

KDA 3 Main Spindle Drive

Project Planning Manual

DOK-DIAX01-KDA*3*****-PRJ1-EN-P



<i>Title</i>	KDA 3 Main Spindle Drive
<i>Type of documentation</i>	Project Planning Manual
<i>Docu. Type</i>	DOK-DIAX01-KDA*3*****-PRJ1-EN-E1,44
<i>Internal file reference</i>	<ul style="list-style-type: none"> • Mappe 7 • KDA3-PJ.pdf • 209-0042-4110-01
<i>The purpose of this document</i>	<p>This document serves:</p> <ul style="list-style-type: none"> • to introduce the drive • to assist in mechanically integrating the drive into the control enclosure, offers guidelines on mounting and installation • to describe the AS programming modules • to explain the components delivered and how these should be stored <p>This document also offers guidelines on supplementary technical documentation</p> <ul style="list-style-type: none"> • covering commissioning, use and service • for electrically integrating the drive into the control enclosure as all the standard electrical connections of the main spindle drive have been compiled in a separate document • by means of the “Document Summary“ which offers an overview of all technical documentation covering the main spindle drives and their respective contents • by means of the summary “Supplementary Documentation“, which lists all titles with order numbers
<i>Copyright</i>	<p>©INDRAMAT GmbH, 1995</p> <p>Copying this document, and giving it to others and the use or communication of the contents thereof without express authority are forbidden. Offenders are liable for the payment of damages. All rights are reserved in the event of the grant of a patent or the registration of a utility model or design (DIN 34-1).</p>
<i>Published by</i>	INDRAMAT GmbH, Dept. ENA (MR)
<i>Validity</i>	All rights are reserved with respect to the content of this documentation and the availability of the product.

Table of Contents

Page

1.	Introducing the Modular KDA 3 Main Spindle Drive	5
2.	Planning the Control Enclosure	9
2.1.	Ambient Conditions	9
2.2.	Mechanical Data	11
2.3.	Thermal Data	15
2.4.	Electrical - Data KDA	17
2.5.	Summary of Technical Data	23
2.6.	Type Codes	24
3.	AS3 Programming Module	25
4.	Condition at Delivery	28
5.	Identifying the Components	29
6.	Storage and Transport	31
7.	Mounting	32
8.	Installation Guidelines	35
9.	Commissioning	36
10.	Service Guidelines	37
10.1.	Fault Diagnostics	37
10.2.	Replacing Equipment	37
11.	Index	40

1. Introducing the Modular KDA 3 Main Spindle Drive



Fig 1.1 Modular KDA 3.2 Main Spindle Drive

The KDA 3.2 drives are used for intelligent digital control of INDRAMAT's 2AD asynchronous motors and 1MB frameless spindle motors with a continuous output at the motor shaft of 3 to 22 kW.

These drives are characterized by high stiffness, positioning features and an extensive speed range with continuous power. This makes them particularly well-suited for use as spindle drives, including spindle positioning and C-axis operation, in numerically-controlled machine tools.

A microcomputer digitally performs drive control, monitoring and diagnostics. This is done by means of an extremely high resolution measurement of rotor position over the full speed range.

A speed control range of 0.0005 rpm to maximum speeds offers excellent, high-quality C-axis operation (resolution $\leq 1/360\,000$ revolution) and spindle positioning.

In addition to speed control, the drives also offer a high degree of internal position control via high-resolution motor feedback or an additional high-resolution spindle feedback.

Controller for modular drive systems

The KDA 3.2 is operated together with additional drive controllers for feed axes. The modular construction of the supply module, main spindle and feed control module make the individual adaptation to a specific task of a CNC machine tool possible.

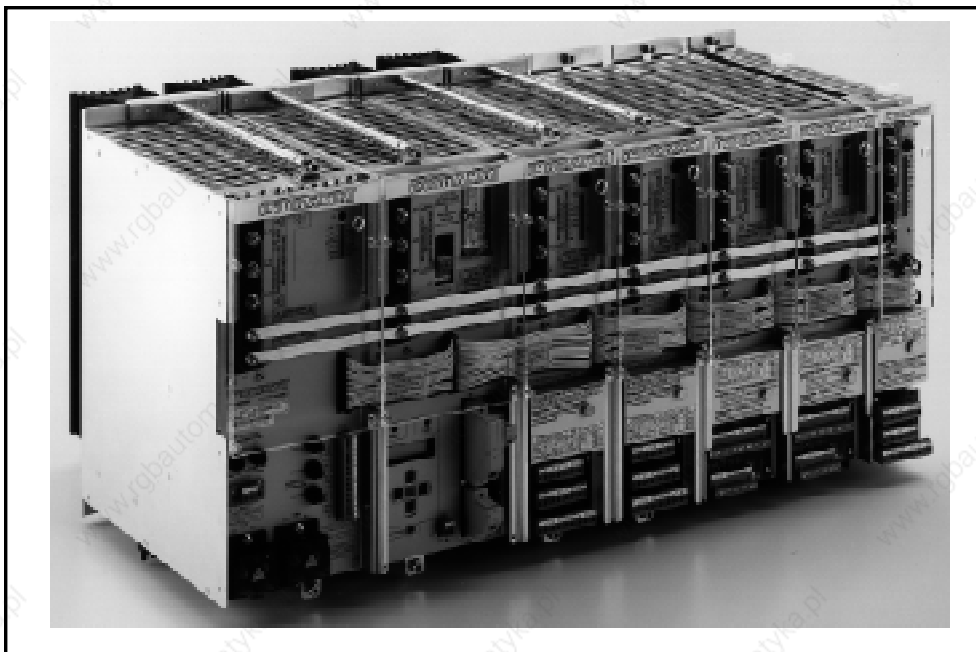

Fig 1.2 Drive configuration with KDA 3.2 modular main spindle drive

Heat conductance outside the control enclosure

The KDA 3 is also offered in a version with the heatsink mounted on the back panel of the unit. This means that heat can be conducted away from the unit, on the outside of the back panel of the enclosure. This construction offers compact control enclosures without cooling units.

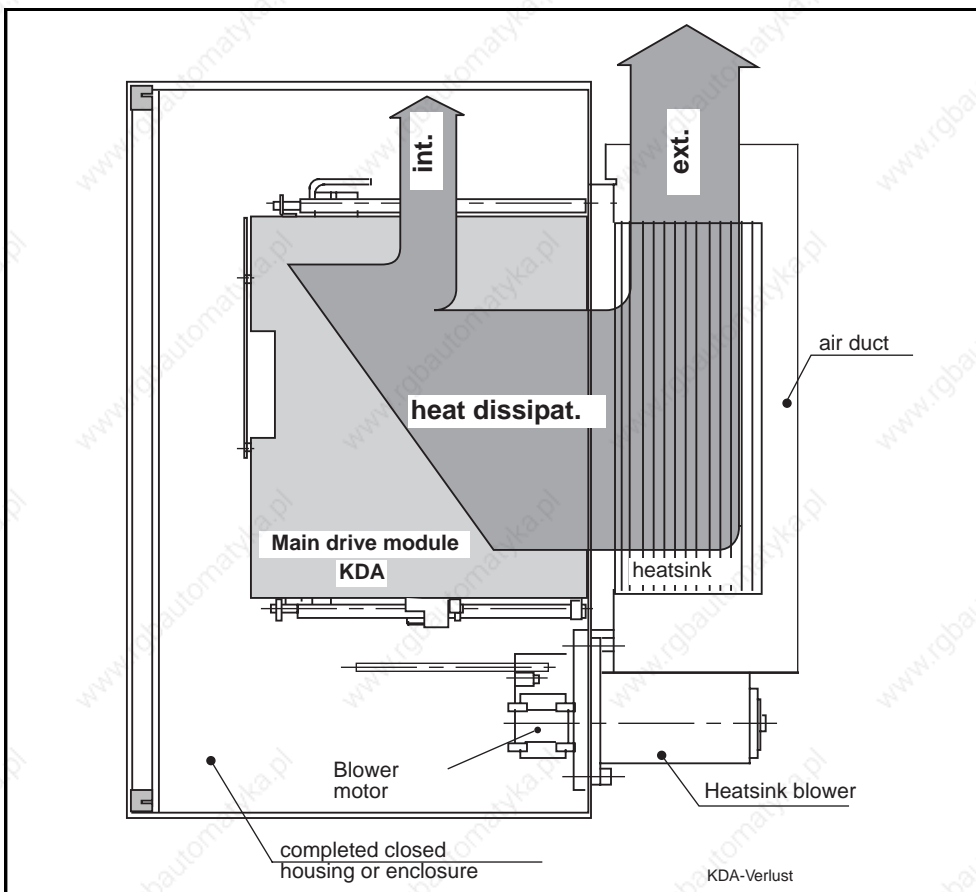

Fig 1.3 Internal and external heat dissipation of the KDA 3

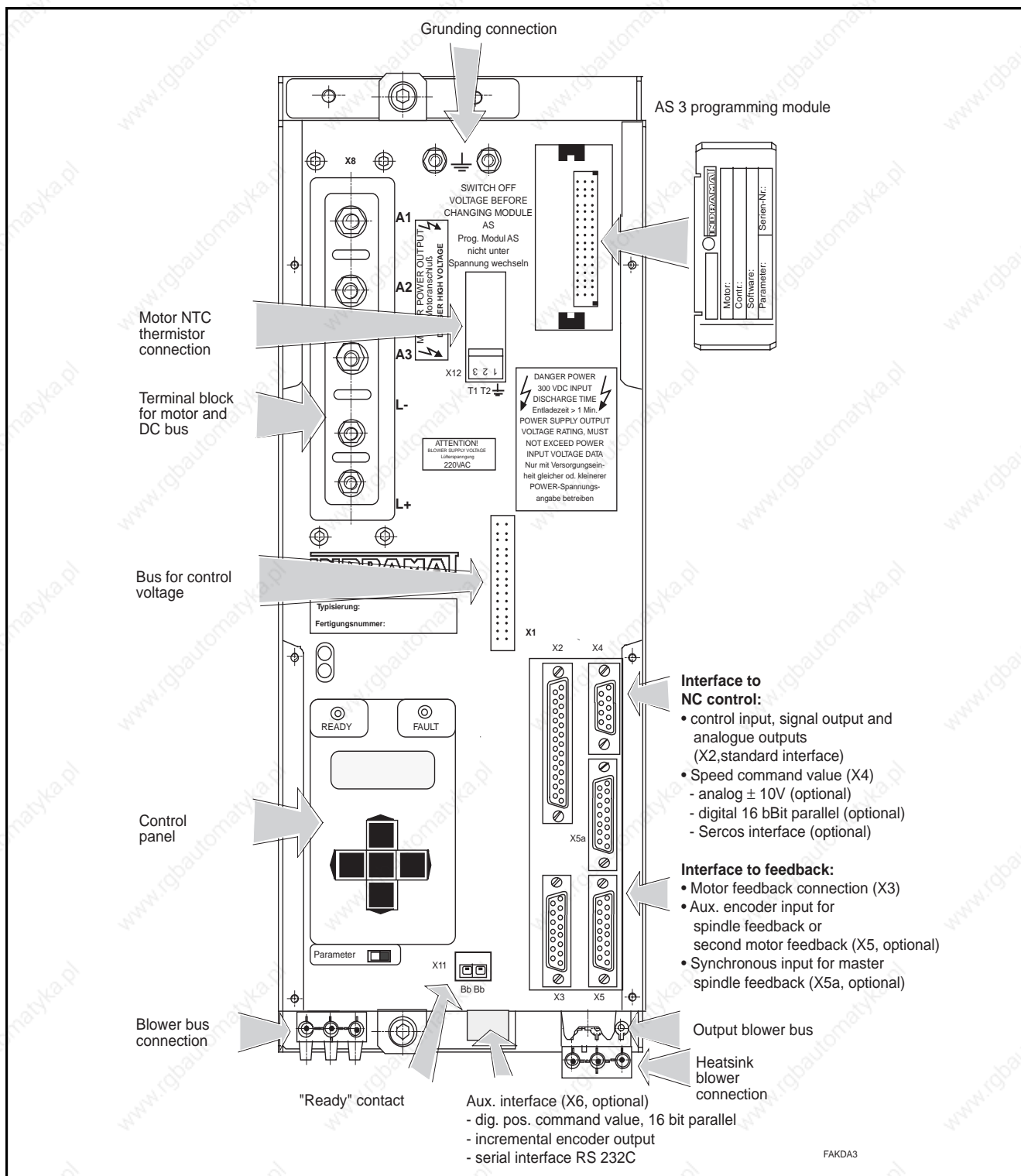

Fig 1.4 Defiinition allocation on KDA 3

Parametrization

The adaptation of different motors, operation modes and conditions of and at the machine is accomplished through parametrization. This, in turn, is accomplished with an integrated input and display unit.

For optimum implementation of machine mechanics, multi-range parameter blocks are available to adapt the various gear stages.

See document entitled: "AC Main Spindle Drives with Regulated Asynchronous Motors or Frameless Spindle Motors - Applications", (doc no. 209-0041-4109).

Interfaces KDA 3 drives are optionally available with:

- ± 10 V speed command value interface,
- SERCOS interface and
- digital parallel speed and position command value interfaces.

It is possible, with conventional CNC controllers equipped with ± 10 V speed interfaces, to output the drive internal rotor position or the spindle position as an incremental encoder signal with programmable resolution for position control.

A serial interface is available for storing and loading parameters onto a PC.

Parameter handling and diagnostics via an NC terminal are possible, if a SERCOS interface is used. Also possible is the implementation of the full speed-control range without the need to switch, and the implementation of the drive-internal high-resolution position control (resolution 1/2 000 000th rev.) for C-axis operation and spindle positioning. The quality of these operations is of the highest.

In addition, SERCOS interface transmits the highly-defined actual position, actual speed and torque values in real time for feed control, rapid tapping, adaptations and, if necessary, for CNC internal position control where required.

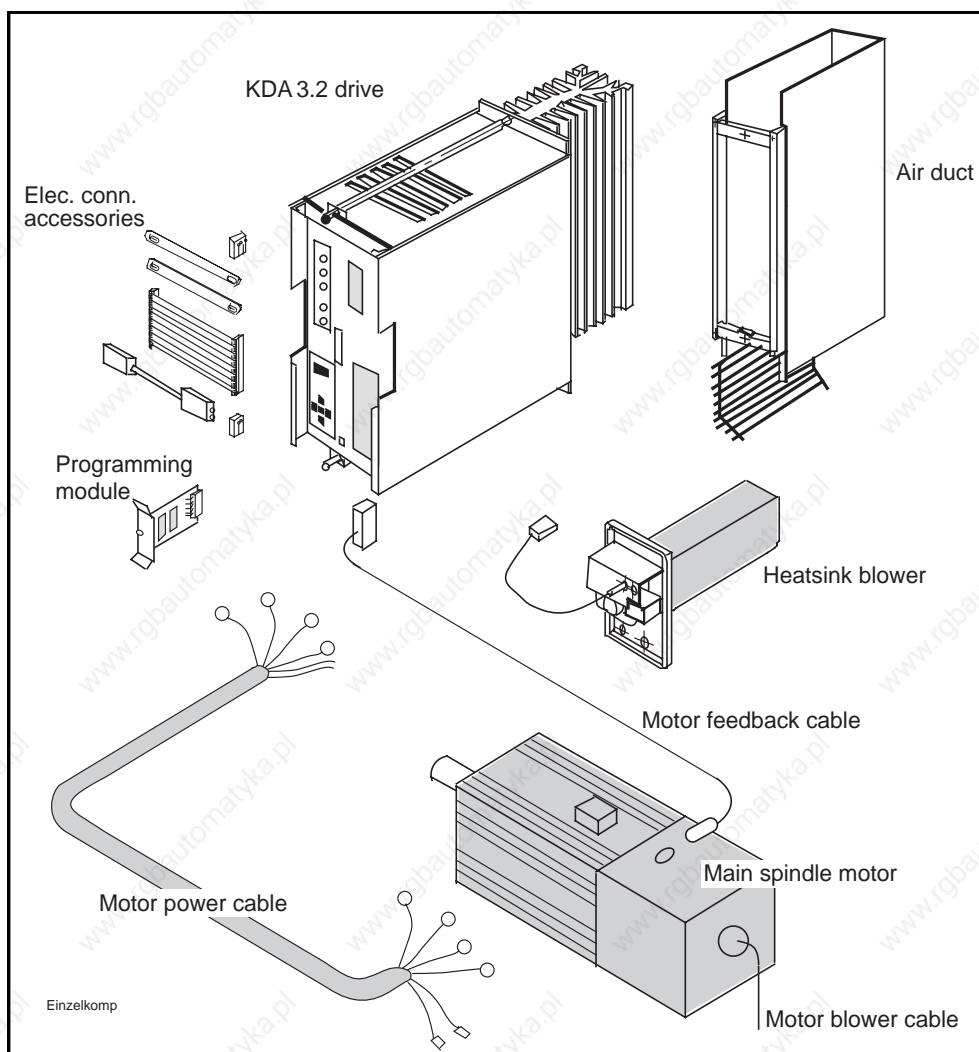

Fig 1.5 Allocation of terms - modular main spindle drive

2. Planning the Control Enclosure

Information about the structural integration of the KDA 3 drive into the machine is broken down as follows:

- ambient conditions,
- mechanical data,
- thermal data,
- technical data/type codes

2.1. Ambient Conditions

The main spindle drive values listed in the selection data apply without restriction if the drive is operated within an ambient temperature range of +5° to +45° C. Peak ambient temperature equals +55° C. There is, otherwise, a reduction in values as outlined in the diagram in Figure 2.1 below.

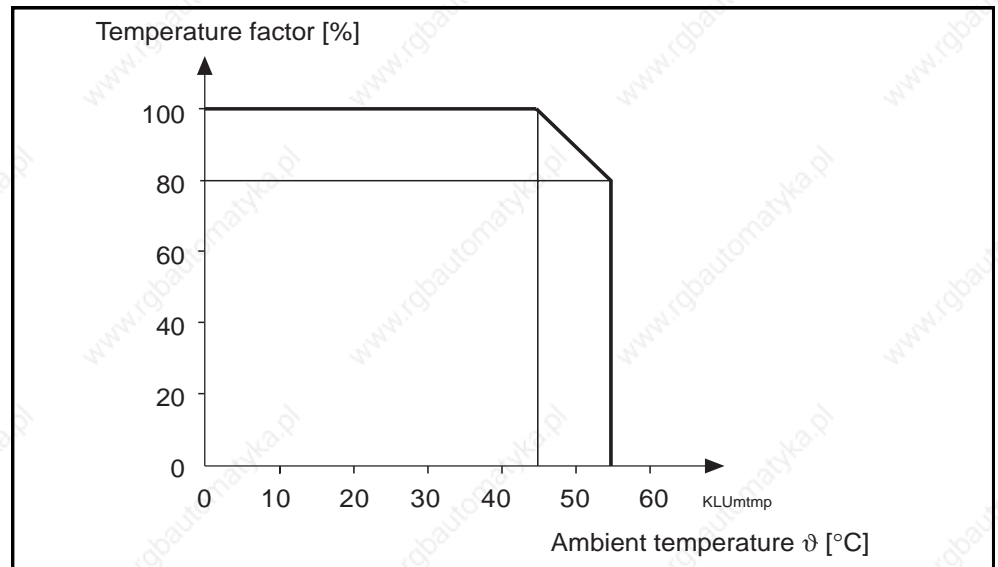

Fig 2.1 Ambient temperature-dependent reduction in drive values

Maximum installation elevation is equal to 1,000 meters above sea level. The values for main spindle drives drop with higher elevations. The reduction is outlined in the corresponding diagram in Figure 2.2 below.

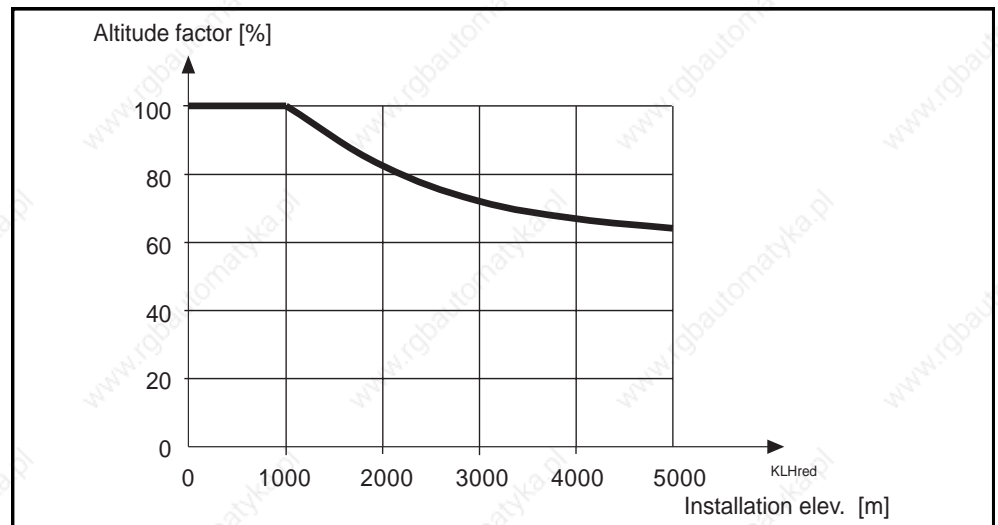

Fig 2.2 Elevation-dependent reduction in drive data

Peak humidity for the immediate environment corresponds to Humidity Classification F, per DIN 40 040.

This means that the unit may be operated in such humid locations as workshops in cold, moderate and dry-warm climates. The average relative humidity in the most humid month of the year may not exceed 70%! Beware of condensation formation!

For further details, see DIN 40 040!

The electrical protection category is IP 10, as per DIN 40 050.

This means that the unit is protected against penetration by objects with a diameter greater than 50 mm.

The drive is not protected against:

- water and
- any deliberate penetration, for example, a hand. Larger body surfaces, however, will be kept out.

The KDA 3.2 has been designed for assembly into a control enclosure or a totally sealed housing as per DIN 40 050!

2.2. Mechanical Data

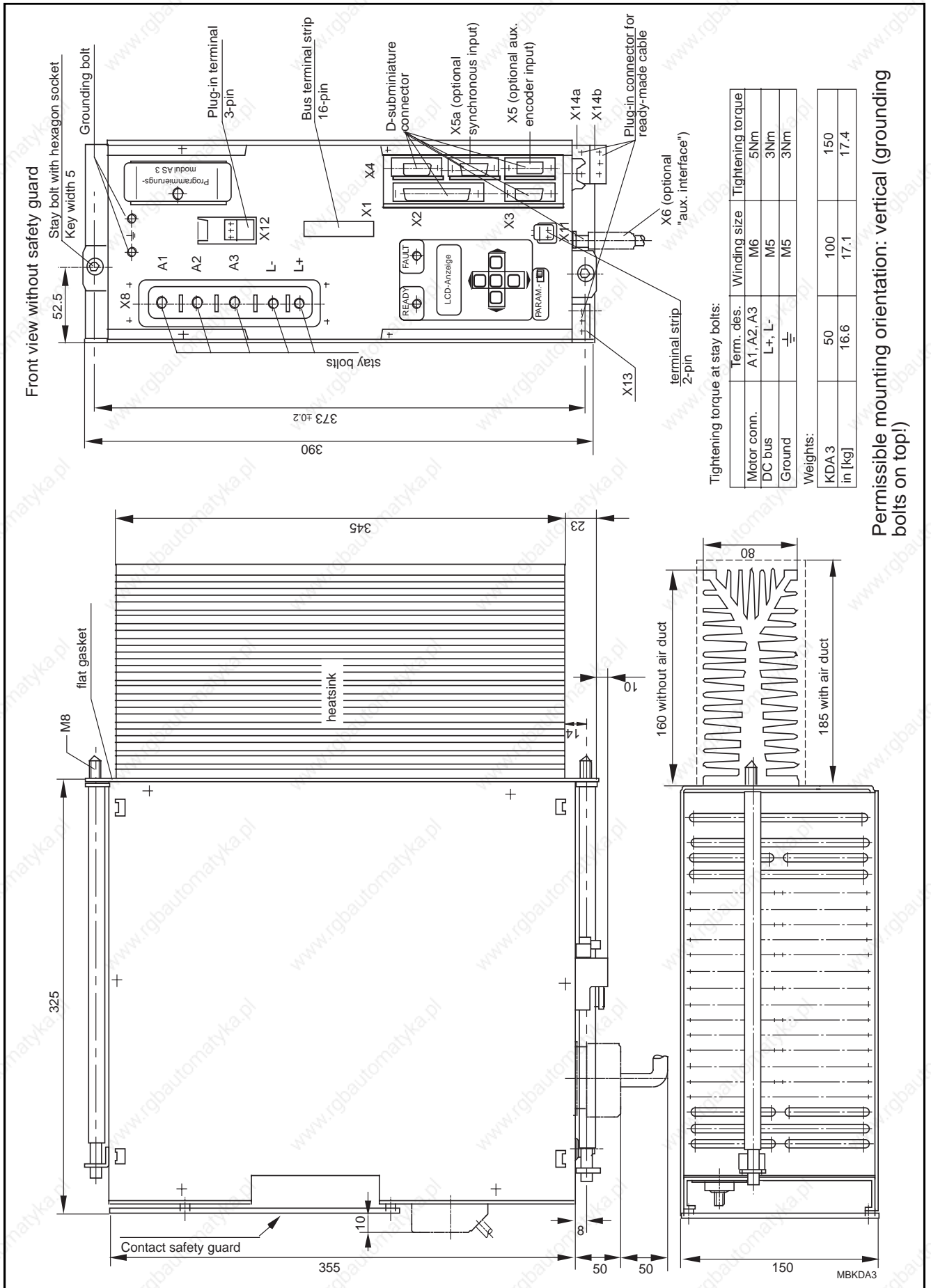

Fig 2.3 KDA 3.2 - dimensional data

2. Planning the Control Enclosure

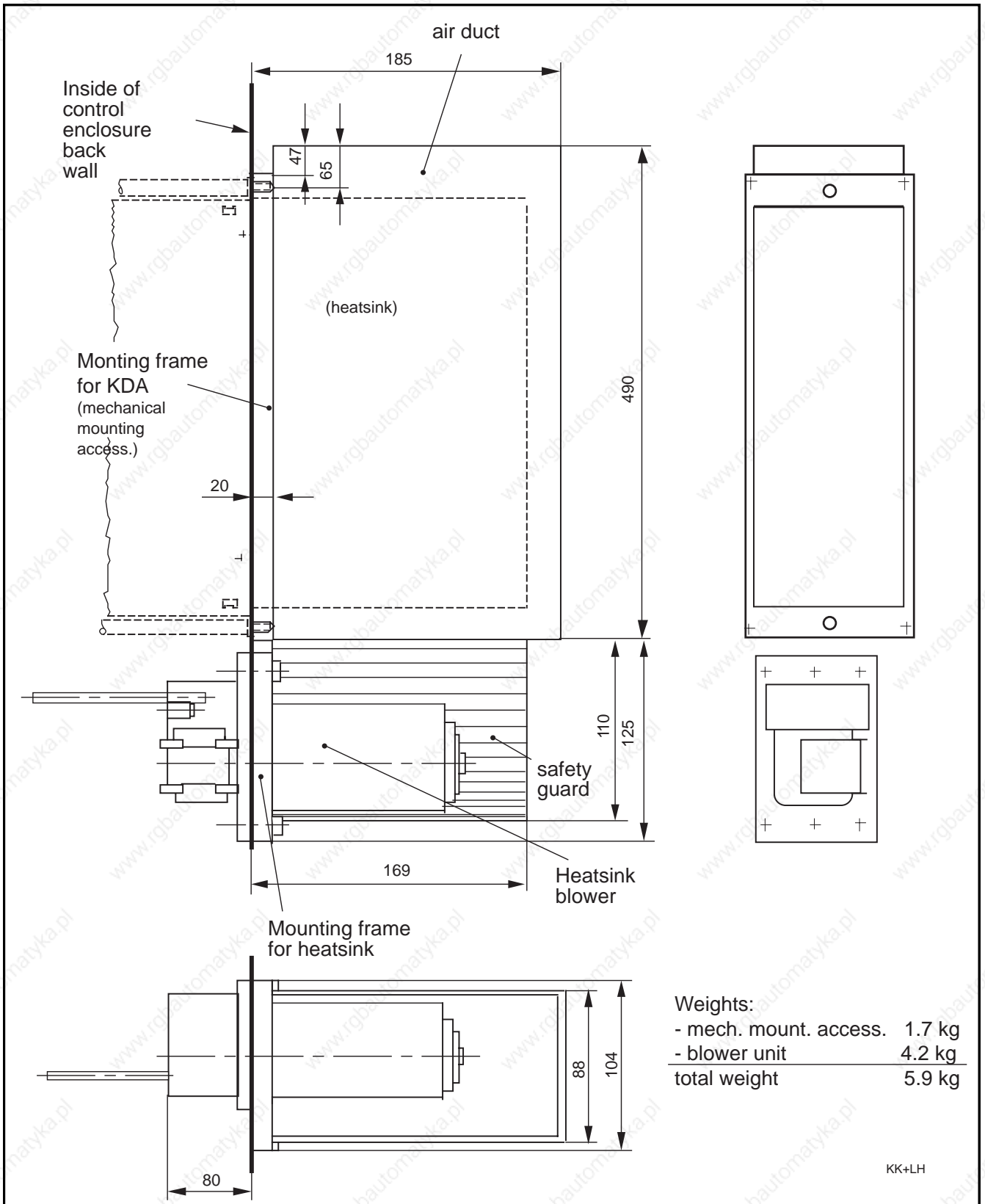

Fig 2.4 Dimensions of mounted Blower unit

The blower produces and conducts the air over the heatsink. The air duct is mounted to the KDA 3.2 frame. It is possible to replace the drive without replacing the blower.

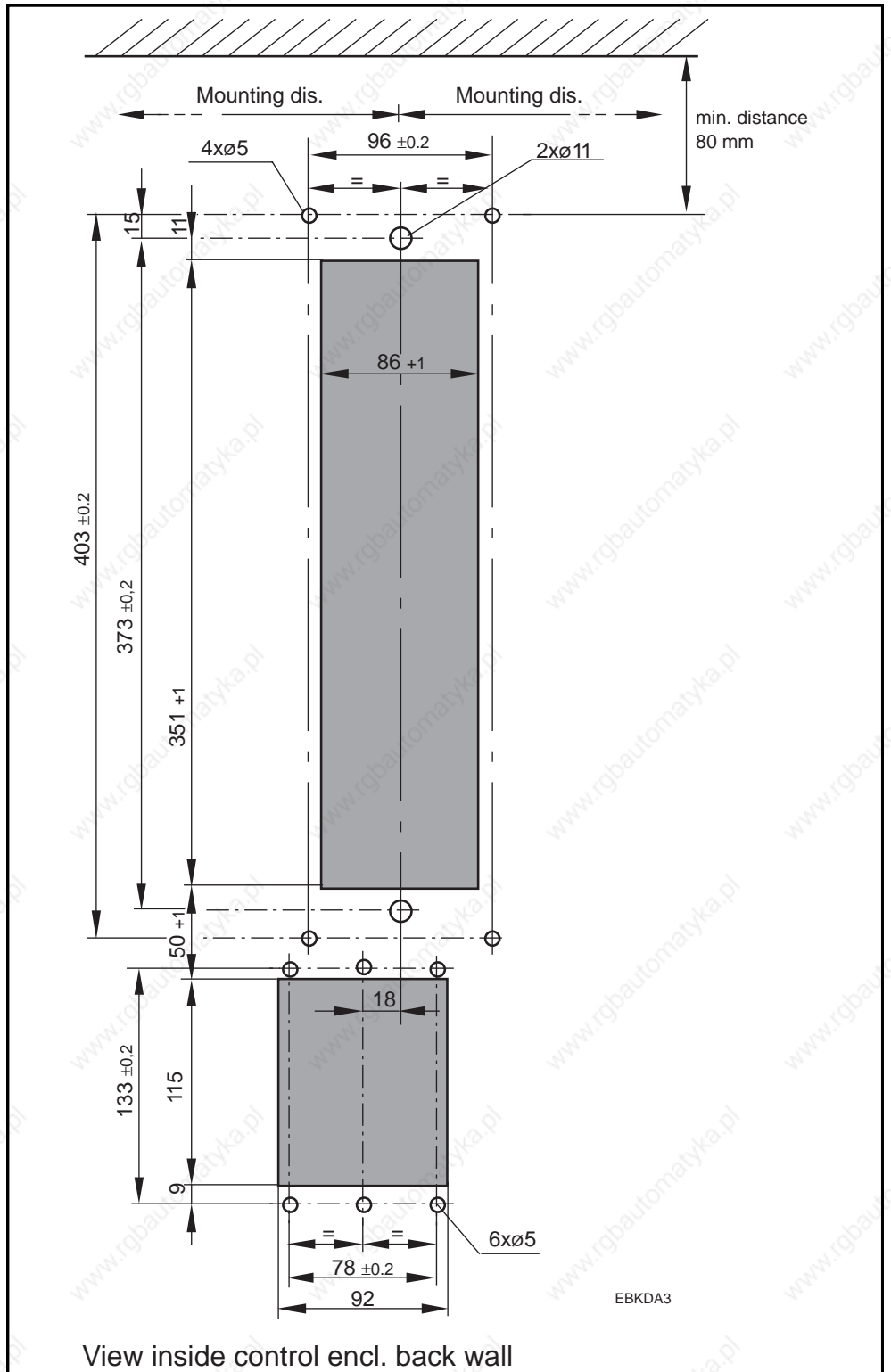

Fig 2.5 Panel cutouts with drilling pattern on back panel of control enclosure

2. Planning the Control Enclosure

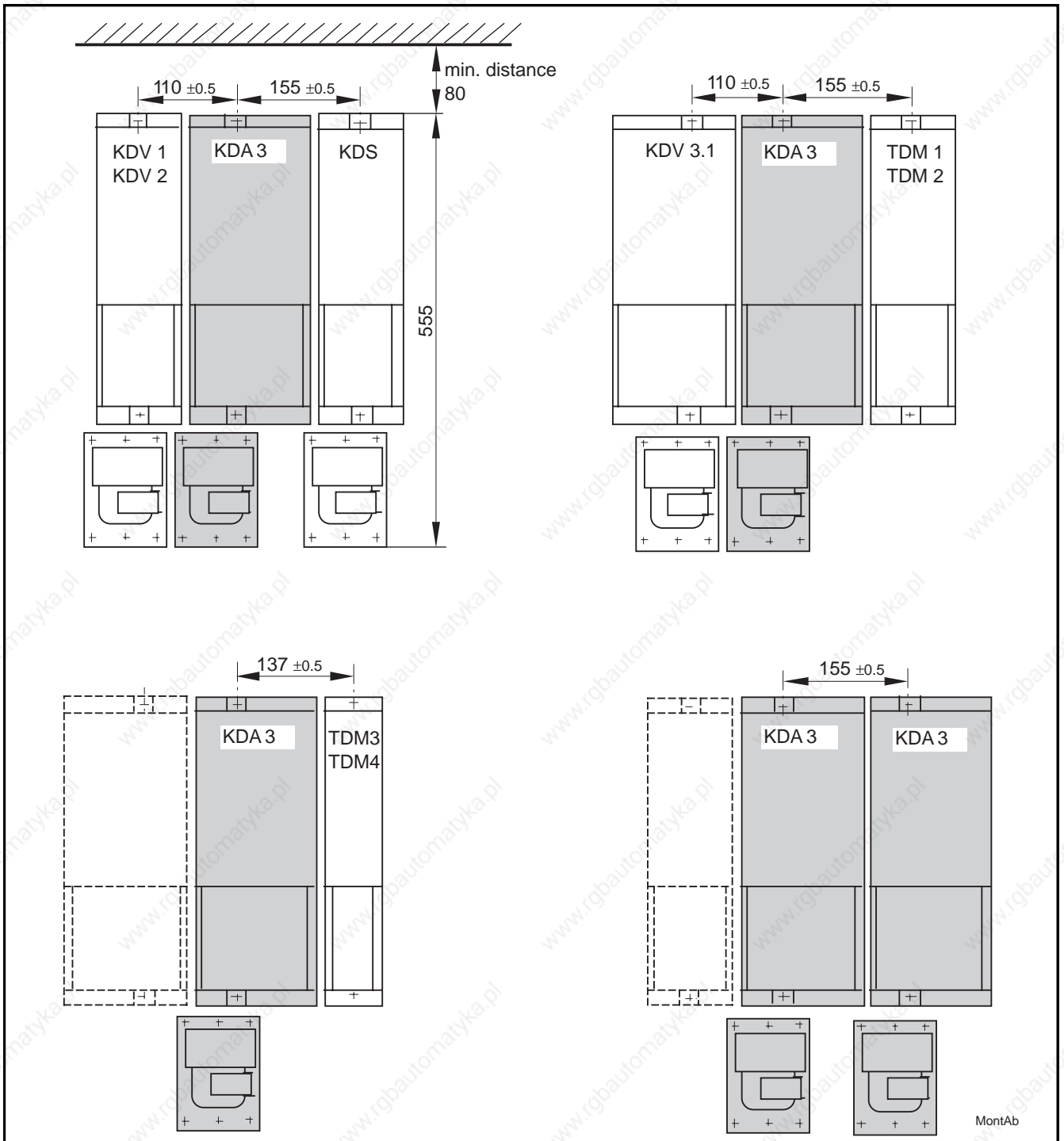

Fig 2.6 Installation distances upwards and to adjacent units of the drive

2.3. Thermal Data

The KDA 3.2 emits heat over the air vents in the housing and via the heat-sink mounted on the back of the unit. The drive is designed to dissipate heat outside the control enclosure. In other words, most of the heat created by the unit is conducted by the heatsink out of the control enclosure.

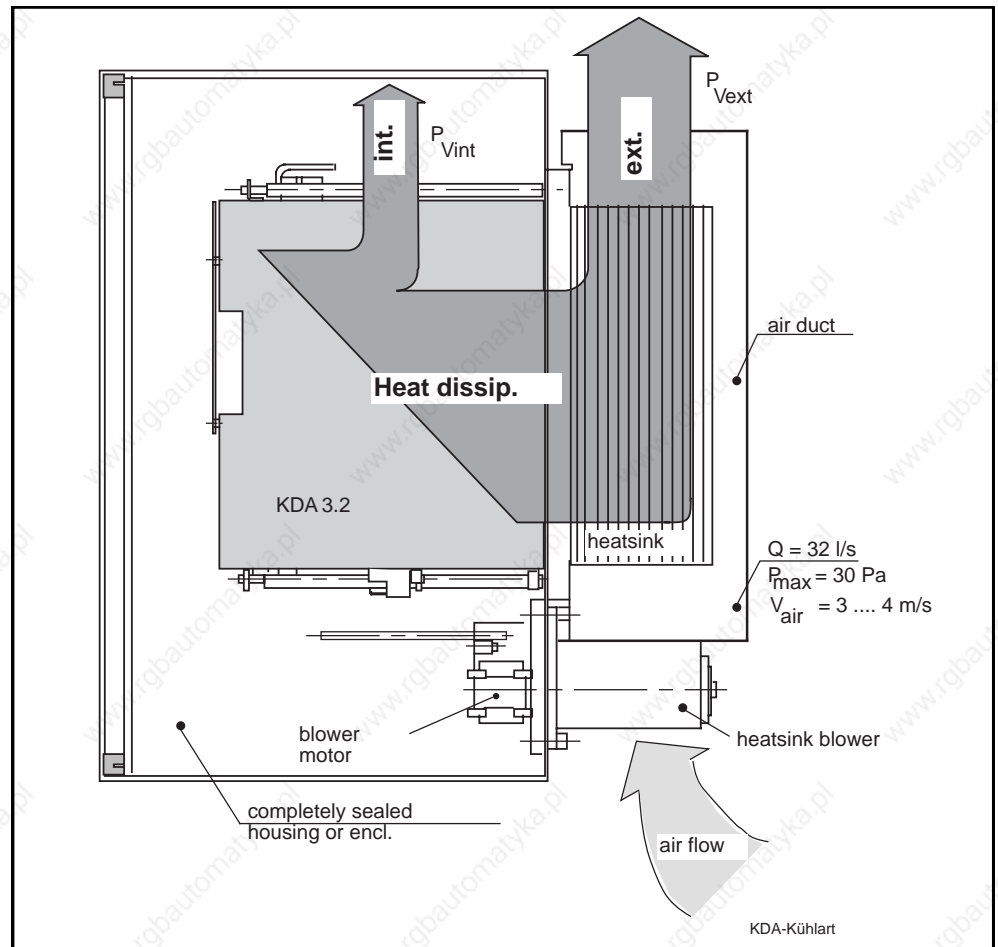

Fig 2.7 KDA 3.2 cooling method

The internal heat loss and the external heat emission of the KDA 3.2 are workload dependent. When calculating the dimensions for either the control enclosure or blower unit, it suffices to know that the heat output is dependent on the continuous output of the main spindle motor used.

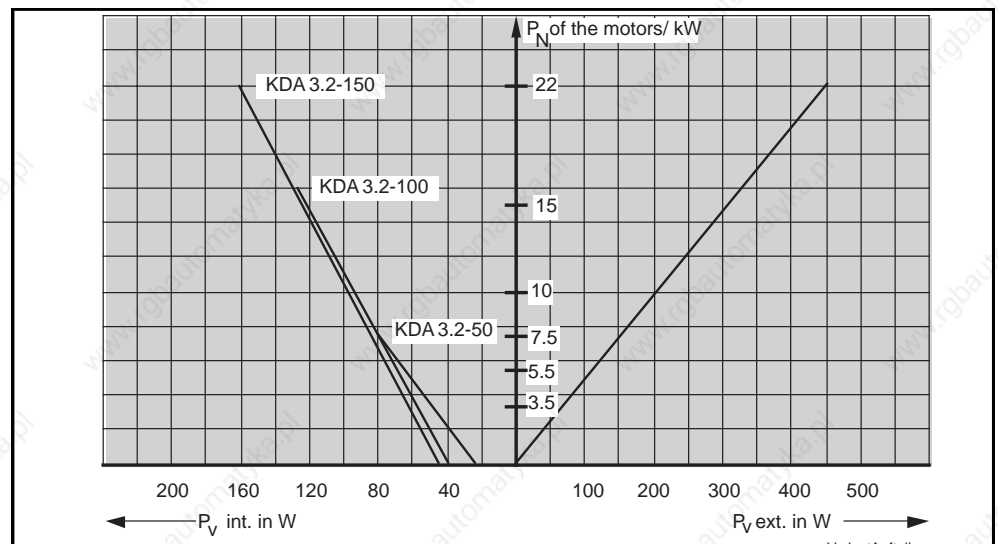

Fig 2.8 Internal and external heat dissipation

Cooling air inlet and outlet

When installing several heatsinks into a common air duct, make sure that there is a sufficient amount of air!

As a safety measure, the values for the cooling air flow, Q , and peak excess pressure P_{\max} just below the heatsink should be controlled!



Very dirty cooling air contaminates the heatsink!
With insufficient heat, the unit should switch itself off.
-> Conduct clean air only. Use air filters, if necessary!

2.4. Electrical - Data KDA

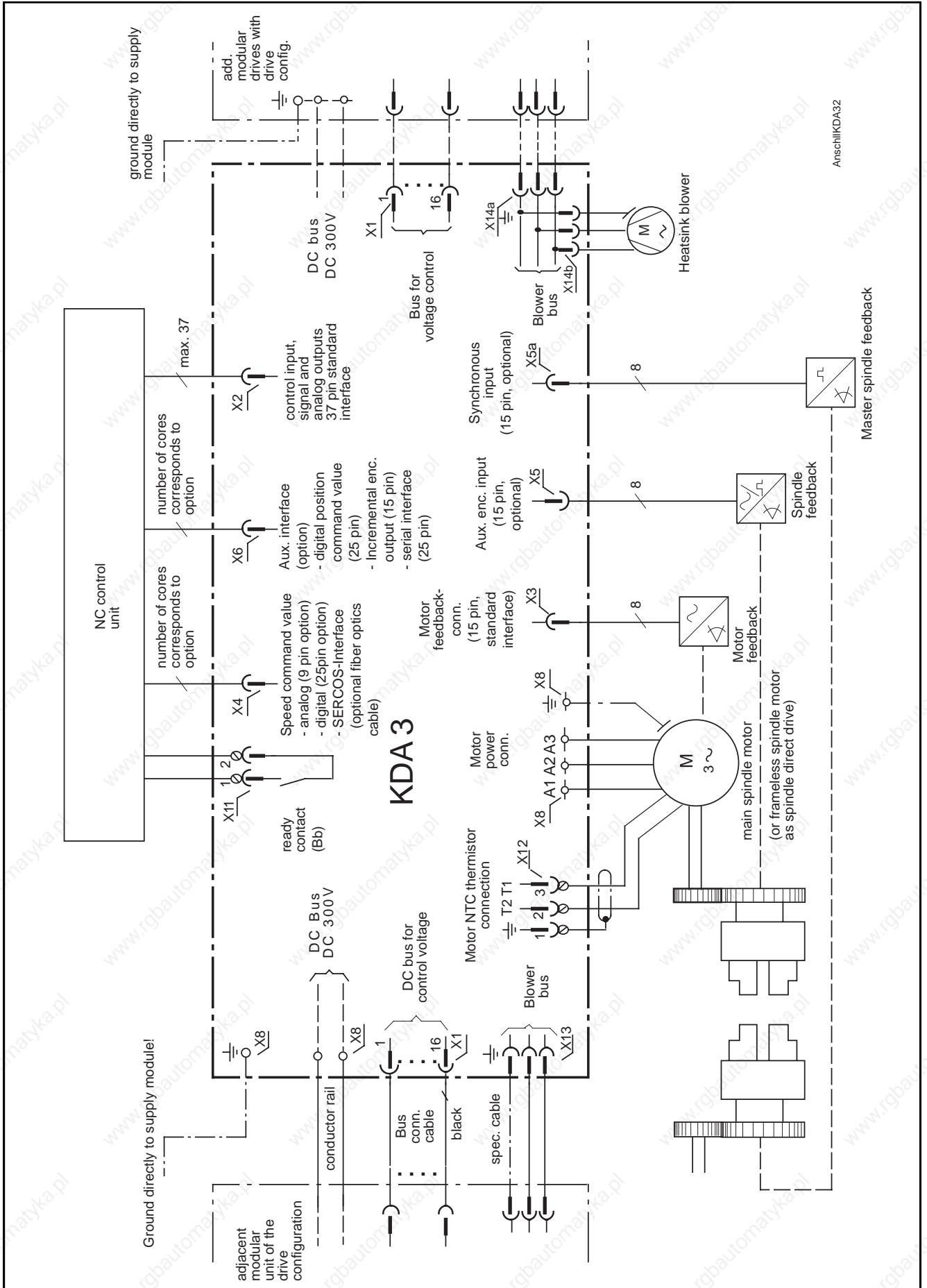

Fig 2.9 Terminal-Diagram KDA 3

Standard electrical connections

The electrical connections of the entire INDRAMAT main spindle drive program are standardized with the goal to reduce the variety of conductors and cables.

There are three categories of electrical connections:

- **Feedback and NC Connections**
with identical connector assignments independent of drive controller and motor type.
- **Drive internal connections**
to fit various control enclosures.
- **Power connections**
identical terminal assignments, connection cross sections are power dependent.

Feedback and NC connections

The cables are dependent upon

- the selected drive options.

The interfaces of all feedback and NC connections are identical independent of the main spindle drive as regards pin assignment and designation. These are outlined in the document entitled, "Electrical Connections of the Main Spindle Drives", doc. no. 209.0042-41111-00, and in the document, "AC Main Spindle Drives with Regulated Asynchronous Motors or Frameless Spindle Motors -- Applications", doc. no. 209-0041-4109-01.

Both the functions and the signal levels linked to these interfaces are also the same independent of the main spindle drive controller. These are outlined in the latter document.

Type designations KDA 3.■-■■■■-■-■■■■-■■

See doc. "Elec. Conn. of Main Spindle Drives"



Standard interface	Name	Connecting clamps	Search string
interface to NC	Control input, signal and analog outputs	X2, 37 pin	IKS 610
interface to feedback	motor feedback connection	X3, 15 pin	IKS 315

Fig 2.10 Allocation of standard interfaces to elec. circuit diagram of feedback and NC connections

Type designations: KDA 3.■-■■■■-■-□□□-■■

functional options

Terminal diagram
See doc. "Electrical conn. of Main Spindle Drives"

Functional options	Codes	Name	Connecting clamps	String text
 Speed comm. value input (type code field 6)	A	analog	X4, 9 pin	IKS 613
	D	digital 16 bit-parallel	X4, 25 pin	IKS 612
	L	SERCOS-Interface	X4, fiber optic cable	IKO
 Add. enc. input (type code field 7)	O	without aux. encl. input		
	P Y	with aux. enc. input	with high-resolution INDRAMAT-enc. (~)	IKS 312
		Synchronous input	X5, 15 pin with incremental encoders (⚡)	IKS 327
 Aux. interface (type code field 8)	O	none		
	D	digital position command value	X6, 25 pin	IKS 614
	I	Incremental enc. output	X6, 15 pin	IKS 620
	S	Serial interface RS 232-C	X6, 25 pin	IKS 015

TBschnitt1

Fig 2.11 Assignment of functional options of drive to elec. connections on unit and terminal diagram of feedback and NC connections

Drive internal connections

There are special electrical connections which match the various positions of the drive controllers within the drive configuration. These can be found in the electrical connecting accessories.

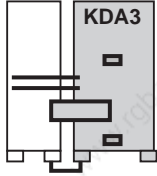
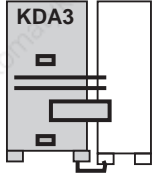
Electrical Connecting Accessories for Main Spindle Drives of the type KDA 3		
Preferred arrangement: KDA 3 located directly next to supply module.		
connecting to following units	if on right	if on left
		
Type designations	Type designations	Type designations
KDV 1, KDV 2 KDV 3, KDV 4 TVD 1 TVM KDA 3	E20-KDA E24-KDA E28-KDA E27-KDA E21-KDA	E21-KDA E23-KDA E29-KDA E26-KDA E21-KDA

ZubKDA3

Fig 2.12 Electrical connecting accessories allocated to the position of the drive within the drive configuration

The electrical connecting accessories consist of the following parts:

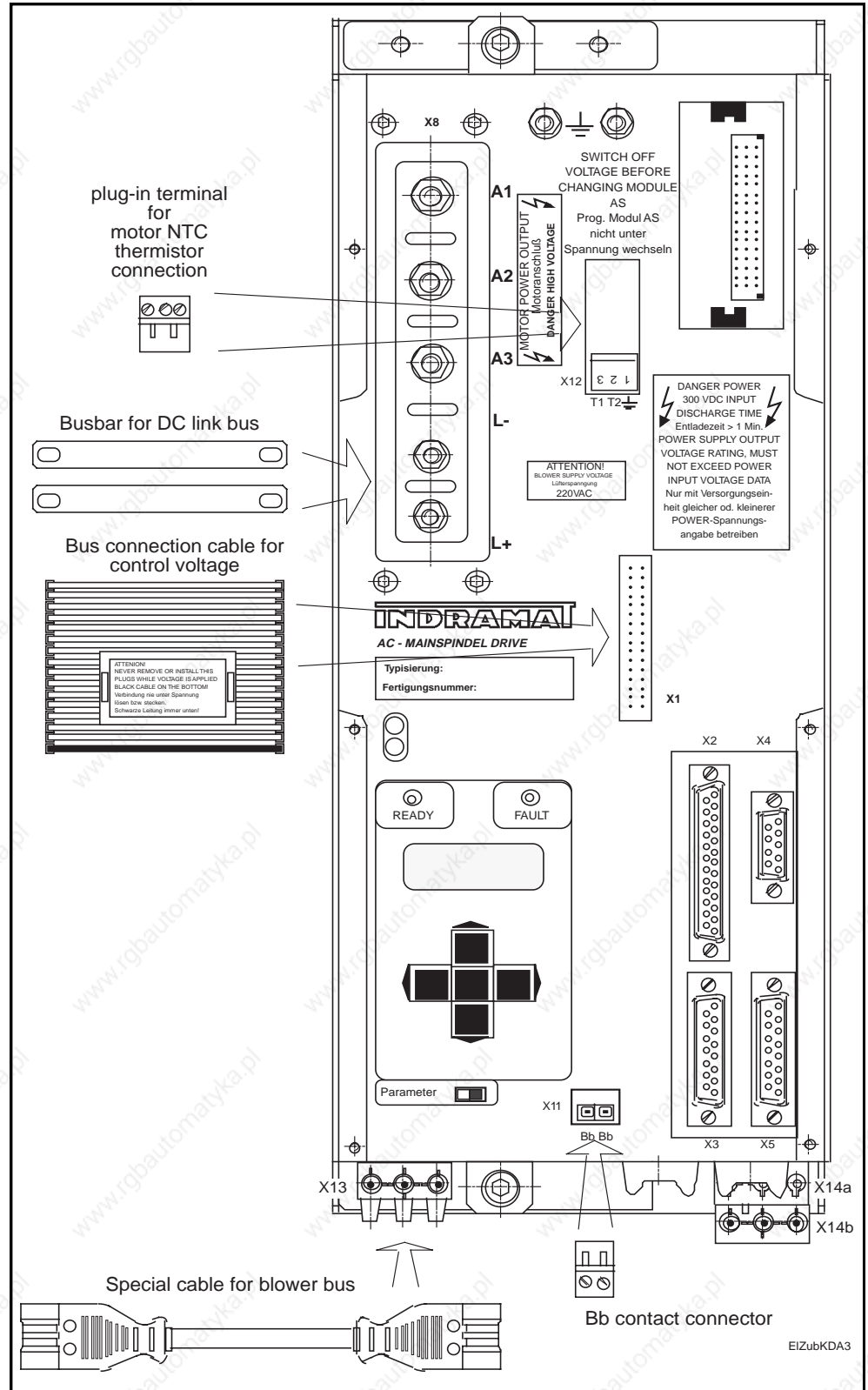

Fig 2.13 Electrical Connecting Accessories E••-KDA

Figure 2.9 depicts the circuit diagram of the drive configuration's internal electrical connections!



The drive within a drive configuration must be grounded individually and directly to the supply module!

Minimum cross section of the ground conductor is 10mm²!

Power connections

Terminal designations and assignments of the power connections on the drive are outlined in the connecting diagram in Figure 2.9. They are also outlined in the circuit diagrams of the power connections in the document entitled, "Electrical connections of the main spindle drive", doc. no. 209-0042-4111!

The cables to the motor power connections are dependent upon the rated current of the motor. This applies to those drive combinations which permit motor overload during short-term or intermittent operations.



Drive combinations: KDA 3.■ - ■■■■ - ■ - ■■■■ - ■■ mit ...	
	Terminal diagram see document "Elec. connections of main spindle drives"
... main spindle motor	Search string
2AD 100B 100C 100D 2AD 101C 101D	2AD 100 with KDA/TDA
2AD 132 B 132 C 132 D	2AD 132 with KDA/TDA
... frameless spindle motor	
1MB 160 E B D F	1 MB with KDA/TDA
1MB 200 D	1MB with KDA/TDA
1MB 240 B D F H	1MB with KDA/TDA
1MB 310 B	1MB with KDA/TDA

Fig 2.14 Allocation of the main spindle motors to the power connections

The smaller value can be used for dimensioning in those motor/drive combinations where the continuous output of the drive is less than that of the motor!

See Figure 2.5, Technical Data, for continuous drive output with various rated currents.

2.5. Summary of Technical Data

Designation	Symbol	Einheit	KDA3.3-50-3-  -W1	KDA3.3-100-3-  -W1	KDA3.3-150-3-  -W1
Cooling mode			forced cooling		
DC bus voltage	U(DC)	(V)		300	
Rated current	I(typ)	(A)	50	100	150
Continuous current	I(cont)	(A)	35	70	90
Current consumption (bus for control voltage)					
+ 24V load voltage	I(+UL)	(A)	1.2	1.4	1.6
± 15V measuring voltage	I(±UM)	(mA)		160	
Weights					
drive weight	m	(kg)	16.6	17.1	17.4
mech. mounting kit (M1-KD)	m	(kg)		1.7	
blower unit (LE4)	m	(kg)		4.2	
Ambient conditions					
perm. ambient temp. range with nominal data		(°Celsius)		+5 ... +45	
perm. max. ambient temperature with reduced nominal data		(°Celsius)		55	
Storage and transport temp.		(°Celsius)		-30 ... +85	
Install. elev. without reduction of nominal data				max. 1000m above sea level	
perm. humidity				F per DIN 40 040	
Protection category				IP 10 per DIN 40 050	

TDKDA3.3

Fig 2.15 Technical Data - KDA 3.3

2.6. Type Codes

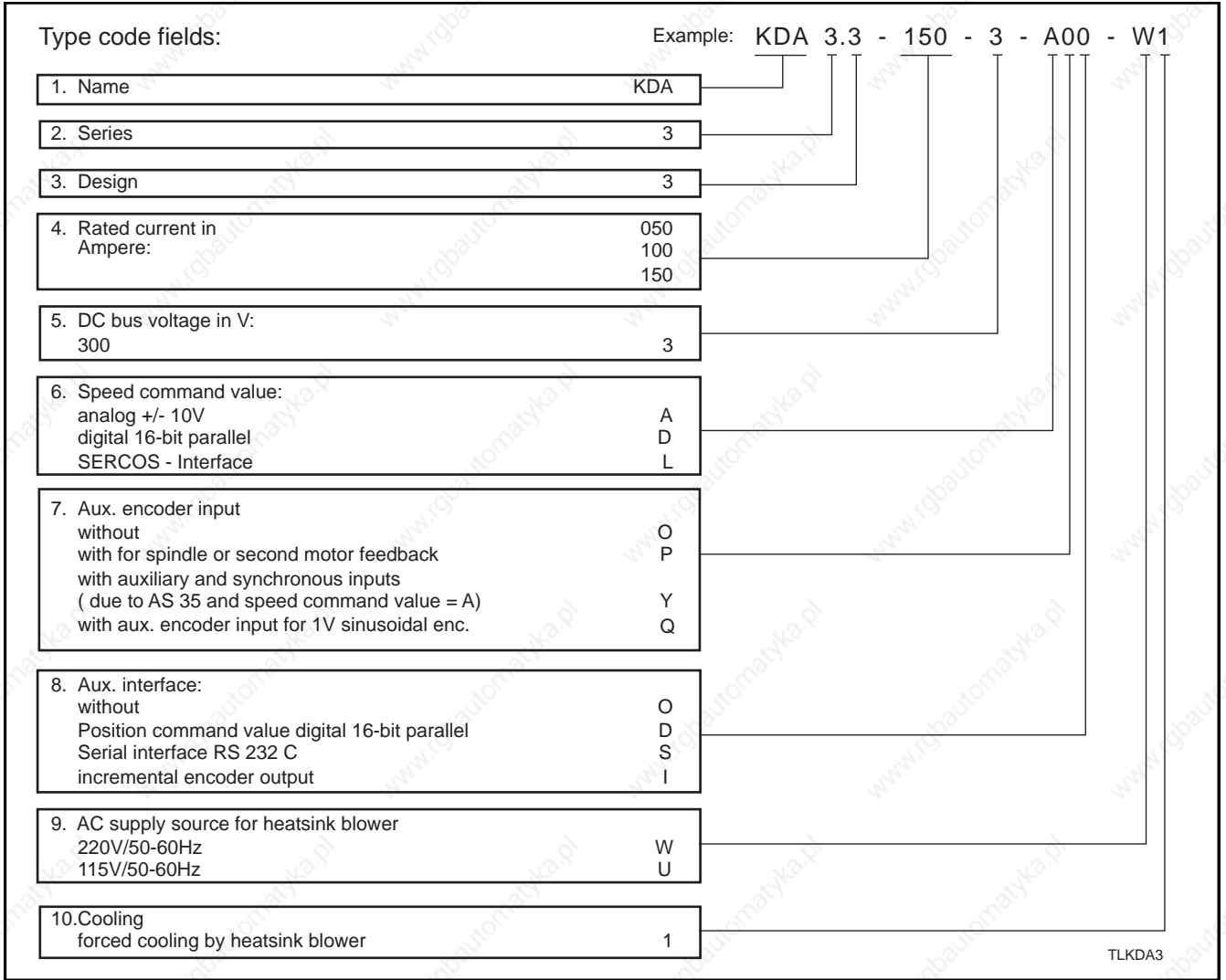

Fig 2.16 KDA - type codes

3. AS3 Programming Module

INDRAMAT main spindle drives are microcomputer controlled. Parameters are used to synchronize the drive and motor and to match the drive to the machine tool.

Advantages when replacing unit

Both the operating software and the parameters are stored in the programming module. No re-setting of the drive is necessary, in the event that a unit needs to be replaced. The drive is immediately synchronized to motor and machine by simply plugging the existing programming module into the new unit.

Duplication

It is easy to duplicate the set programming module for other, similar machines or for saving. The parameter duplicating adaptor or a serial interface and input unit (PC or something similar) is used for this purpose.

Parameters

There are two sets of parameters in the operating software.

- drive-specific parameters and
- application-specific parameters.

The drive-specific parameters affect the operating characteristic curves of the drive. INDRAMAT determines and sets the parameter values for the operating characteristic curves offered.

User-specific parameter for main spindle drive operation are also available (machine-specific values).

Inputting and changing parameter values

Inputting and changing parameters is an identical process in all INDRAMAT main spindle drives. The keypad on the user terminal is used for this purpose.

The document "AC Main Spindle Drives with Regulated asynchronous Motors or Frameless Spindle Motors -- Applications", doc. no. 209-0041-4109, outlines the operation of the drive.

Standard AS programming module

The standard programming module contains the drive-specific parameter values determined by INDRAMAT. The user-specific values are standard values. The machine-dependent data are input at the time the unit is commissioned.

The customer is responsible for the documentation and administration of these user-specific parameters.

Customer-specific programming modules (for large series)

If INDRAMAT is to document, administer and supply a programming module already set with user-specific parameters, then it is necessary to originate a customer-specific programming module. This is done at the request of the customer in agreement with INDRAMAT for an **additional fee**.

AS module compatibility A state-of-the-art, i.e., updated AS programming module, for drive operation is always automatically delivered. Update programming modules are compatible with already delivered programming modules

Programming module update This assures that the drive is always being operated at the technical, state-of-the-art level.

This includes

- fault clearance by software updates
- software updates to expand the range of functions without affecting existing functions
- and improved parameter values in the software for the motor/drive combination.

Rating plate data

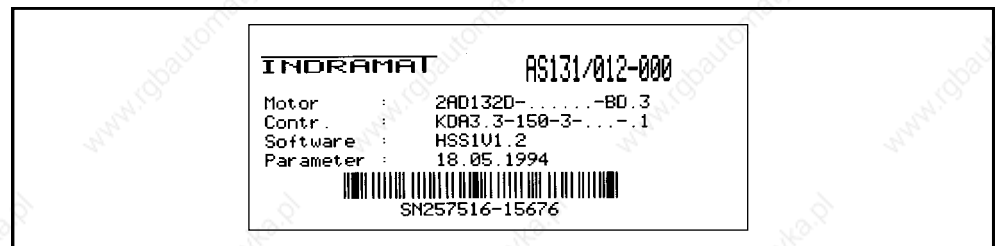

Fig 3.1 Programming module AS with rating plate

About 1: Type codes

The end digits of standard programming modules are -000. Customer-specific programming modules end with the customer-specific digits.

About 2: Motor type information

About 3: Type information on main spindle drives

The data given on the rating plate for the motor and drive must agree with the data of the motor and drive installed.

About 4: Software designations

The letter-number combinations, including the letter "V", designate the software version. The following numbers are the counter digits of the software update.

About 5: Date of parameter determination

INDRAMAT herewith records the date the parameters were set and fixed.

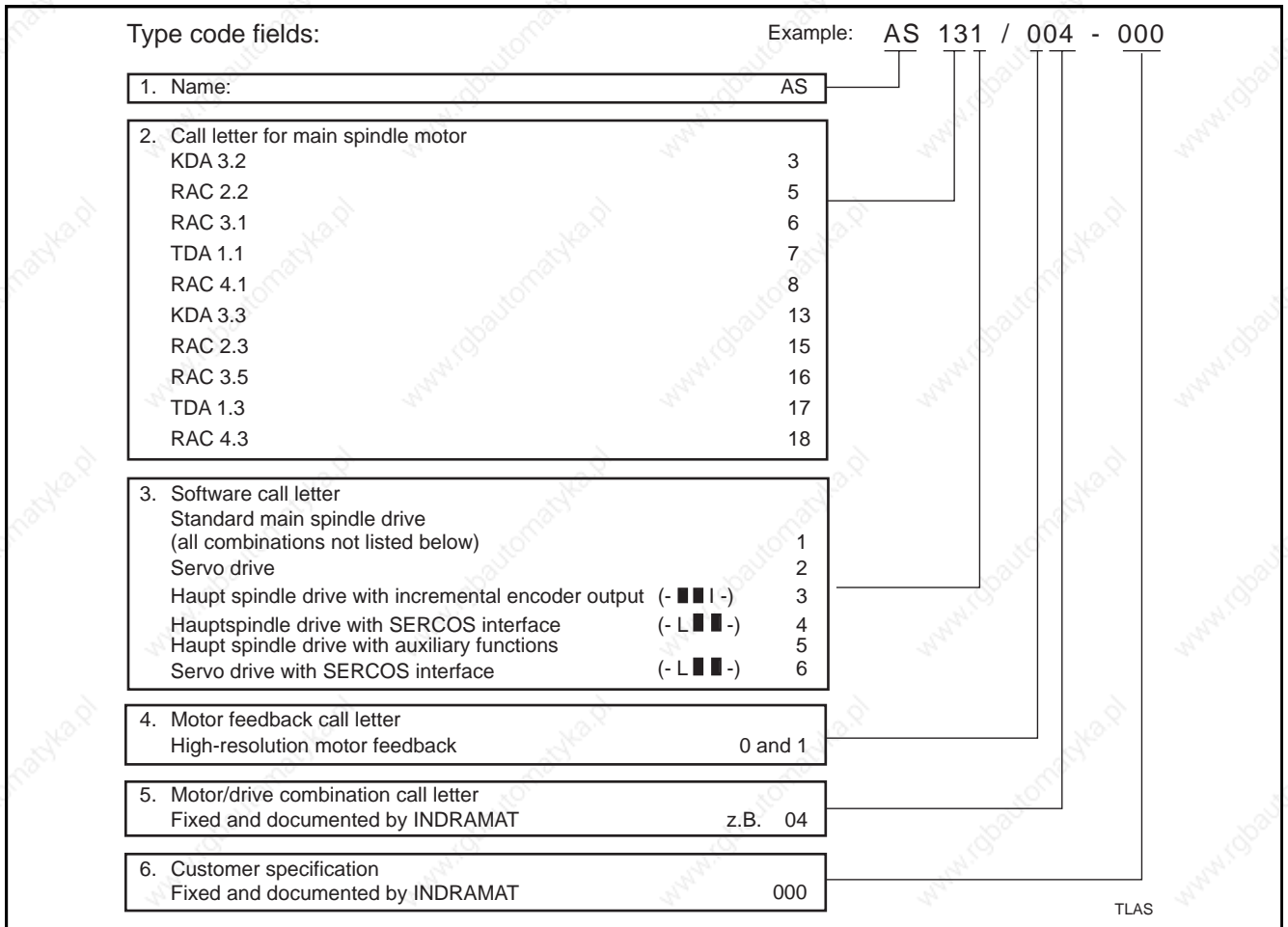

Fig 3.2 AS programming module type codes

4. Condition at Delivery

The components are packed into cartons at delivery. In the case of individual or mixed deliveries, i.e., several different units, all units are packed into individual one-way cartons. All accessories are packed into one carton together. All single cartons are packed together onto one larger transport container, i.e., carton or pallet, at the time of delivery.

Multi-way packaging is used where several identical units are being delivered.

An envelope with two delivery slips is attached to the transport container. There are no other delivery documents unless specifically requested.

5. Identifying the Components

Two copies of the delivery slip are attached to the transport container at delivery. The listed contents of the delivery can be spread over several containers (transport container). This is noted on the delivery slip or bill of lading.

The delivery slip lists the components by designation and order number.

In the case of mixed orders, individually packed controllers and accessories are packed into the transport containers. With multiple orders of the same units, the accessories might be found in a separate transport container.

KDA 3 Drive There is a barcode sticker on the packaging of the KDA 3.2. It identifies contents in terms of design and order handling.

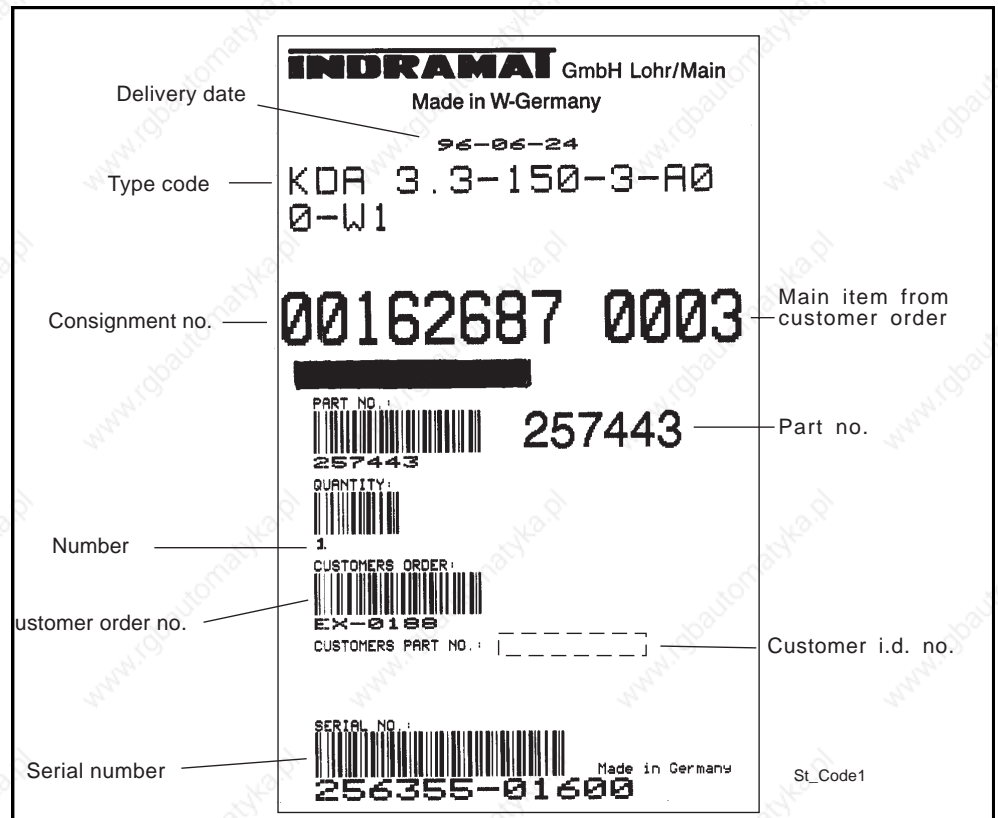

Fig 5.1 An example of a barcode sticker on the KDA

If there are several identical units in one container, then the serial numbers of all the units therein are listed on the barcode sticker. This applies to multi-way packaging only, however.

There is a sticker on the side of the KDA 3.2 itself. It entails all necessary information for servicing. It is identical to the barcode sticker and lists the delivery date.

There is a rating plate on the front of the KDA. It remains visible even after the KDA has been built in, in contrast to the sticker on the side.

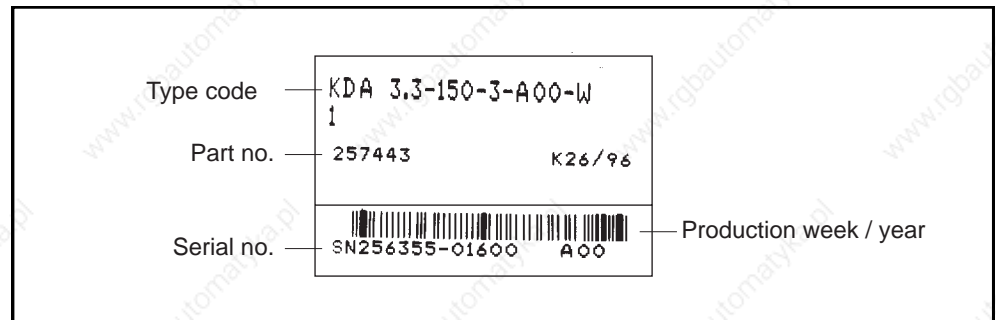

Fig 5.2 An example of a rating plate on the front panel of a KDA

AS programming module

Programming modules are always packed individually in plastic bags and then additionally packed in a carton. The plastic bag protects the AS module against static loads. Touching the printed circuit board can damage it! The programming module number is written by hand on the outside of the carton.

The parameter list is in the bag with the programming module. It entails all information about the programming module and documents the parameter values set at delivery.

If parameters are lost at the time of commissioning, then it is possible to input the original values using this parameter list. Put the parameter list in the machine file!

There is a rating plate on the front of the programming module.

Accessories

The mechanical and electrical accessories are packed into plastic bags and the order number is written by hand on the bag. See Fig 2.12, Fig 2.13 and Fig 7.1 for information on these.

The order number is glued to the cable in the case of ready-made cables. The cable number is imprinted on custom cables.

The blower is also packed into one carton and the order number is written by hand on the carton.

6. Storage and Transport

The drives must be stored dry, dust and shock free. The permissible temperature range is -30 to+85°C.

A shock-absorbing base should be used during transportation if any danger of extensive vibrations exists!

The following are guidelines printed on the packaging:



Fig 6.1 Transport guidelines

7. Mounting

Installing the drive The following is needed to install the unit into the control enclosure:

- mechanical accessories kit M1-KD
- blower unit LE4-...V
- KDA 3 drive

The order of installation corresponds to the sequence of the list.

The back panel of the control enclosure must have vents and drill holes as outlined in section 2.2, Figure 2.5. The orientation must be vertical!

Mounting panel of the drive The mounting panel for the KDA 3, with screws, is contained in the mechanical mounting accessories kit M1-KD.

Firstly, attach the KDA 3.2 frame onto the back panel of the control enclosure. It should be attached to the **outside** of the control enclosure and is screwed on from inside.

The frame braces the back panel of the control enclosure and creates a level surface for the flat gasket on the unit. The frame has all the needed windings and sealing rings to give it and the control cabinet a secure hold.

Heatsink blower Attach the mounting frame for the heatsink blower on the outside of the control enclosure back panel as well. Now screw the air duct from behind onto the KDA's mounting frame.



A very long screw driver is needed to affix the air duct. Its blade must be at least 185 mm long!

The aforementioned parts, including screws, are part of the blower unit LE4-...V. This also applies to the heatsink blower with connecting cable.

The final step is to push the heatsink blower from the inside of the back panel of the control enclosure into the bottom cutout and screw on the installation frame.



The voltage of the blower unit LE4-...V and that of the KDA 3.2 blower supply must be the same.

Type code field nos. 9 and 10 of the KDA 3 = W1: ->LE4-220V

= U1: ->LE4-115V

Figure 2.5 shows the back panel of the control enclosure prepared for the installation of the KDA 3.2.

Drive Push the drive heatsink first into the remaining cutouts above the heatsink blower. Using the fitting bolts, tighten into place on the mounting frame at the upper and lower ends of the KDA.

The AS3./...-. programming module should already be set into the KDA 3 drive at the time the latter is installed. The module is on the upper right hand corner of the KDA 3.2. Push it in and attach it using the knurled-head screw.



The unit with the sharp-edged heatsink must be inserted into the cutout in the mounting panel.

Caution: Hand injuries are possible during installation!

-> When pushing the KDA in, hold it by the long studs on the upper and lower ends of the housing!

The installation of the drive and its parts is depicted in Figure 7.1, Installing the Unit.

Fig 7.1 Installation of unit

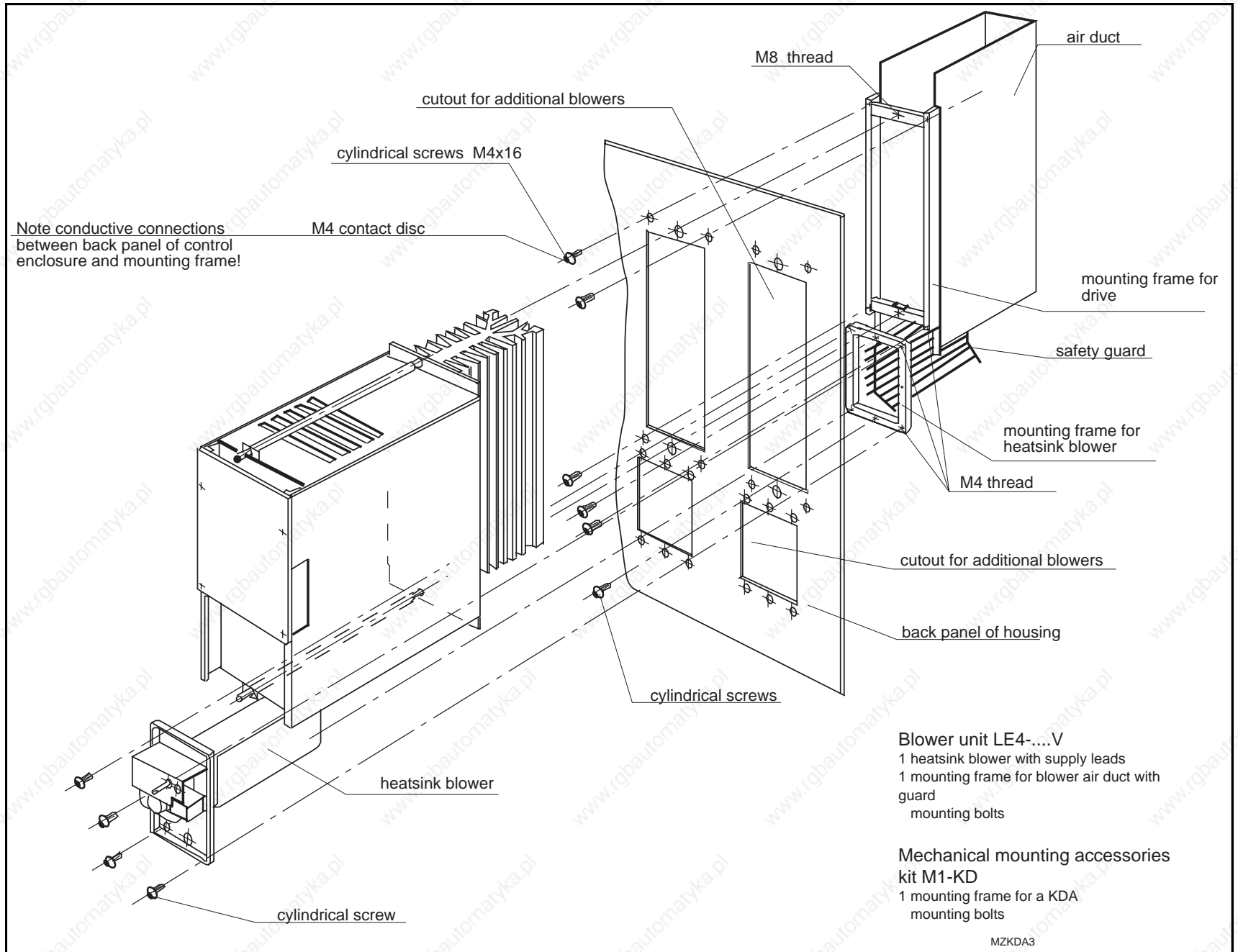

Blower unit LE4-...V
 1 heatsink blower with supply leads
 1 mounting frame for blower air duct with guard
 mounting bolts

Mechanical mounting accessories kit M1-KD
 1 mounting frame for a KDA
 mounting bolts

MZKDA3

8. Installation Guidelines

- The manufacturer's circuit diagrams must be complied with!
- The circuit diagrams of the machine must be coordinated with INDRA-MAT's circuit diagrams!
- The transparent contact guards on the front of the unit must be screwed on once the DC bus voltage is switched on and upon commissioning!
- Do not pull the AS programming module out if power is on. The knurled-head screw must be firmly screwed into place during operation!
- Connect heatsink blower cable!
- Note the maximum tightening torque of the studs, as otherwise they could snap!
- The D-subminiature connectors must be firmly screwed into place during operation!
- Twist the cores of the power cable!
- Plug in the bus end connector on the last drive of the drive configuration (supply module accessories)!
- Ground the motor to the drive and the drive directly onto the supply module!

EMC data Maintaining the limit values for emission of interference (rf interference suppression) at the connecting points of the machine or unit, in particular, operation within residential and light industrial areas, necessitates routing the motor power cables in a shielded manner, or the use of shielded motor power cables and the proper installation of an rf interference suppression filter in the power supply cable of the machine or unit, as recommended by INDRAMAT. This will maintain the limit values as per Class B (interference suppression grade N) as per EN 55011/ 3/91, and Table 1 as per EN 55014/ 1987 at the machine.

For further details on Electromagnetic Compatibility, i.e., EMC, see document, "Electromagnetic Compatibility (EMC) in AC Drives, Project Planning Manual", doc. no. 209-0049-4305.

9. Commissioning

Commissioning procedures are identical in all modular main spindle drives, e.g., KDA 3.2 and TDA 1.1. For this reason, and because of the extensive range of functions, the procedure is described only once in the document "AC Main Spindle Drives with Regulated Asynchronous Motors or Frameless Spindle Motors - Applications", doc. no. 209-0041-4109!

10. Service Guidelines

10.1. Fault Diagnostics

The KDA 3.2 diagnosis faults via the display on the keypad. The drive brakes with a fault and then the KDA 3.2 shuts power off. The fault diagnostics of the different main spindle drives is identical.

For this reason, both the fault diagnostics and the guidelines on fault clearance for all INDRAMAT main spindle drives is outlined in the document, "AC Main Spindle Drives with Regulated Asynchronous Motors or Frameless Spindle Motors - Applications", doc. no. 209-0041-4109).

10.2. Replacing Equipment

To guarantee a high-degree of machine availability, the KDA 3.2 is replaced in the event of a fault and repaired at the manufacturer's workshop.

Since the drive and machine specific parameters of the KDA 3.2 are entailed in the AS programming module, the module need only be removed from the defective unit and inserted into the replacement unit. The drive with the new KDA 3.2 now has the same capabilities as the original drive.

The following procedures must be followed if an exchange becomes necessary:

- Open main switch and secure against switching back on prior to working on any electrical equipment. The drives must be securely at standstill because of voltage at the motor line during motor movements.
- Wait through the discharge time of the DC bus voltage (L+,L-) (≥ 1 minute). Make sure the voltage is less than 50V prior to working. Short circuit, if necessary (Cu-line, A $\geq 6\text{mm}^2$)!
- Screw safety cover of the KDA 3.2 and the adjacent modules into place.
- Release and remove all the rails of the DC link bus and all other connections. Do not forget blower and blower bus!
- Release stud bolts on the top and bottom and then the KDA 3.2.



The replacement unit must be pushed into the cutout of the mounting panel with the sharp-edged heatsink!

Caution: Hands can be injured!

-> Hold the KDA by the long studs on the upper and lower ends of the housing when pushing it in!

- Push the new KDA 3.2 heatsink first into the remaining vents above the heatsink blower. Screw it into the mounting. Use studs on the upper and lower ends of the KDA 3.2.



The AS programming module must never be removed or inserted when voltage is on! Switch power to drive off prior to mounting or replacing the drive!

Returning a defective unit

- Remove the programming module from the defective KDA 3. Insert new one. Secure with knurled-head screw.
- Connect the new KDA as per the machine circuit diagrams. Do not forget the heatsink blower!
- Screw the transparent safety cover into place.
- Restart the unit. See document "AC Main Spindle Drives with Regulated Asynchronous Motors or Frameless Spindle Motors - Applications", doc. no. 209-0041-4109, the section on commissioning for details.
- Fill out repair card for merchandise return/fault protocol! A copy of this repair card is included for your convenience on the next page!
- Return the defective unit with the accompanying card to your INDRAMAT service representative!

Repair Report Card for INDRAMAT equipment and components				
Name:		Co./Loc.:		Date:
Part no. (by replacement of parts)		SN:		Del. cons. no.:
		SN:		Deliv. date:
Mach. manuf./co.:		Type:	Mach. no.:	
Axis:		<input type="checkbox"/> horizontal <input type="checkbox"/> vertical <input type="checkbox"/>	Op. time:	Date failed:
Fault status: Fault _____ _____ <input type="checkbox"/> always present <input type="checkbox"/> occurs sporadically <input type="checkbox"/> occurs after ca. ___ hrs. <input type="checkbox"/> occurs with vibrations <input type="checkbox"/> temperature dependent <input type="checkbox"/> other * _____ * _____ * _____		Additional notes: (e.g., LED diagnostics, error message in display) _____ _____ _____ _____ _____		Failure cause: <input type="checkbox"/> unknown <input type="checkbox"/> connection error <input type="checkbox"/> ext. short <input type="checkbox"/> mech. damage <input type="checkbox"/> loose cable conn, other * _____ * _____ * _____
Supplementary Notes				
General info: <input type="checkbox"/> no functioning <input type="checkbox"/> runs erratically <input type="checkbox"/> uncontrolled drive movements <input type="checkbox"/> fault in only one direction <input type="checkbox"/> supply fuse tripped <input type="checkbox"/> other		Concomitant phenomenon: <input type="checkbox"/> Problems in mech. sys. <input type="checkbox"/> Power section failed <input type="checkbox"/> Control failed <input type="checkbox"/> Motor failed <input type="checkbox"/> Cable break <input type="checkbox"/> other		Drive, Supply Unit, Drive, Power Section: <input type="checkbox"/> Control voltage faulty <input type="checkbox"/> Power sec. fuse F ___ failed <input type="checkbox"/> Defective blower <input type="checkbox"/> Defective bleeder resistor <input type="checkbox"/> Faulty power voltage <input type="checkbox"/> Conn. bolt torn off <input type="checkbox"/> Other
Control: <input type="checkbox"/> no functioning <input type="checkbox"/> no display <input type="checkbox"/> no setpoint output <input type="checkbox"/> Diagnosis <input type="checkbox"/> dim. offset in ___ direction <input type="checkbox"/> interrupt in E-stop loop <input type="checkbox"/> position control loop won't close <input type="checkbox"/> error in program sequency <input type="checkbox"/> int. aux. function fault (outputs) <input type="checkbox"/> acknowledgements not accepted (inputs) <input type="checkbox"/> other _____ _____ _____		Motor: <input type="checkbox"/> Thermoelement defect <input type="checkbox"/> Brake defect <input type="checkbox"/> Blower defect <input type="checkbox"/> Feedback defect <input type="checkbox"/> Tachosignal faulty <input type="checkbox"/> BLC signal faulty <input type="checkbox"/> Short to ground <input type="checkbox"/> Thermal overload <input type="checkbox"/> other _____ _____ _____ _____		Comments: _____ _____ _____ _____ _____ _____

Rep_Bglk.fh3

Fig 10.1 Repair card

11. Index

Numerics

300 V DC bus 17

A

Adaptation 7

Add. interface (X6) 7

Additional encoder input, definition allocation 7

Additional interface, definition allocation 7

Air duct, mounted 12

Allocation of motors to circuit diagram of the power conn. 22

Allocation of standard interfaces 19

Ambient Conditions 9

Ambient temperature reduction 9

Analog outputs, definition allocation 7

Analog outputs, terminal. dia. 17

Analog speed command value, term. dia. 17

Analog speed command, definition allocation 7

Anschluß Kühlkörperlüfter 7

Antriebspaket 6

AS programming module type codes 27

AS3 Programming Module 25

Assignment of functional options 19

Ausbrüche 13

Aux. enc. input, term. dia. 17

Aux. interface, term. dia. 17

B

Berührungsschutzdeckel 11

Betriebsbereitkontakt, Anschlußplan 17

Betriebsbereitkontakt, Stecker für.. 21

Betriebsbereitskontakt, Begriffszuordnung 7

Blower bus conn. cable 21

Blower bus connection 7

Blower bus output 7

Blower bus, conn. cable for .. 21

Blower bus, definition allocation 7

Blower bus, term. dia. 17

Blower duct, single component 8

Blower unit LE4-... V, parts of 34

Blower unit, mounted 12

Blower, mounted 12

Blower, weight 12

Bohrbild für Schaltschrankrückwand 13

Bus für Signalverarbeitung 17

Bus für Signalverarbeitung, Begriffszuordnung 7

Bussteckleiste 17

C

Commissioning 36

Condition at Delivery 28

Connecting cable bus for signal processing 21

Connector for NTC thermistor 21

Control inputs, term. dia. 17

Cooling air inlet and outlet 16

Customer-specific programming modules (for large series) 25

D

Datum der Parameterfestlegung 26
Digital position command, definitiona allocation 7
Digitaler Positionssollwert 17
Dimensions sheet 11
Drehstromasynchronmotor 17
Drehzahlsollwert - digital 17
Drive configuration- intern. conn. 20
Drive configuration with KDA 3.2 6
Drive configuration, part of .. 21
Drive configuration, terminal diagram 17
Drive configuration, type code E..KDA 20
Drive KDA 3, single component 8
D-Sub-Stecker 11

E

Earthing connection bolt 7
Elec. conn. access, parts of .. 21
Elec. conn. circuitry 17
Electrical connecting accessories 8
Electrical connecting accessories, control encl. allocation 20
Electrical data 17
Electrical protection category 10
Elektrische Angaben 17
Elevation-dependent reduction in drive data 9
Erdungsbolzen 11
Expand the range of functions 26
External heat emissio 15

F

Fault Diagnostics 37
Feed control module 6
Feedback and NC connections 18
Feedback interface 7

G

Ground cable, min. dia. 21

H

Heat dissipation outside control encl. 15
Heat loss 15
Heatsink blower, mounted 12
Heatsink blower, single component 8
Heatsink blower, terminal diagram 7

I

Identifying the Components 29
Inc. enc. output, term. dia. 17
Incremental enc. output, term. dia. 17
Incremental encoder signal 8
Inkrementalgeberausgang, Begriffszuordnung 7
Inputting and changing parameter values 25
Installing the drive 32
Interface to NC control 7
Interfaces 8

K

KDA 3 drive, definition allocation 7
KDA 3 weight 11

KDA 3, weight 11

M

Main spindle function unit 8
Main spindle motor 8
Master spindle feedback 17
Maximum installation elevation 9
Mech. mounting access. M1-KD, parts of 34
Mech. mounting access. weight 12
Mech. mounting access., mounted 12
Mechanical Data 11
Meldeausgänge, Begriffszuordnung 7
Minimum clearance 13
Modular drive systems 6
Montageabstan 13
Motor blower cable 8
Motor feedback connection, definition allocation 7
Motor NTC thermistor conn. 17
Motor power cable 8
Motor power conn. 17
Motor, Einzelkomponente 8
Motor, Heileiteranschlu 7
Motor, NTC thermistor connection, definition allocation 7
Motor, term. dia. 17
Motorfeedback 17
Motorfeedbackkabel 8
Mounting 32
Mounting panel 12
Mounting panel for heatsink 12
Mounting panel of the drive 32

O

Operating software 25

P

Parameters 25
Peak humidity 10
Planning the Control Enclosure 9
Plug-in terminal 11
Position command value, position allocation 7
Position command value, term. dia. 17
Programming module 25
Programming module, definition allocation 7

R

Ready contact, term. dia. 17
Repair card for return 39
Replacing Equipment 37
Returning a defective unit 38

S

Safety guard 12
Schnittstelle, Zusatzgeberschnittstelle 11
SERCOS 8
SERCOS interface 8
Serial interface, definition allocation 7
Serial interface, term. dia. 17
Signal outputs, term. dia. 17
Software updates 26

- Software-Update 26
- Speed command value - analog 17
- Speed command value - Sercos 17
- Speed command value, definition allocation 7
- Speed command value, term. dia. 17
- Spindle feedback 17
- Standard electrical connections 18
- Standard interface, term. dia. 17
- Standardschnittstelle, Begriffszuordnung 7
- Stay bolt 11
- Stecker für Bb-Kontakt 21
- Steuereingänge, Begriffszuordnung 7
- Storage and Transport 31
- Summar of Technical Data 23
- Supply module 6
- Synchronus output, term. dia. 17
- T**
- Technical Data KDA 3 23
- Terminal block for motor and DC source 7
- Terminal diagram 17
- Thermal Data 15
- Tightening torque for stay bolts 11
- Type Codes 24
- U**
- User-specific 25

