

**VPC compact**

# VPC compact

The Touch - VPC compact  
for all and everyone

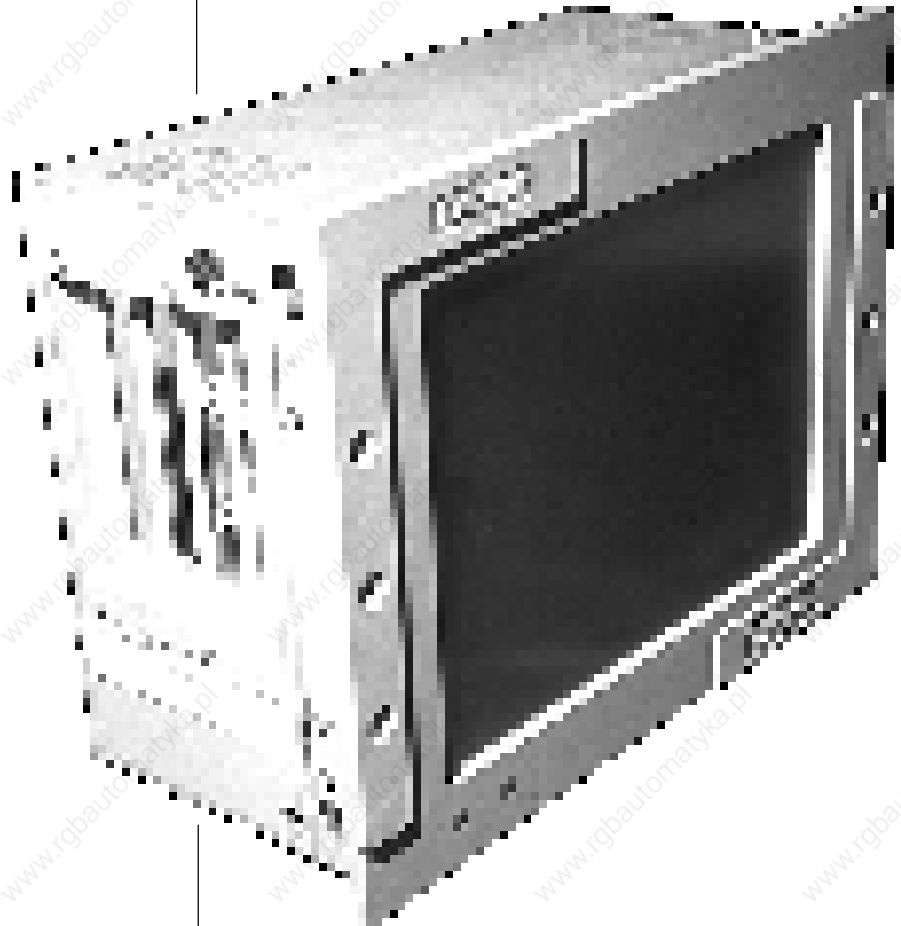

# Table of contents

1. View	
1.1 Front	5
1.2 Side view	5
2. Specifications	
2.1 Connection data	6
2.2 Power loading	6
2.3 Environmental conditions	6
2.4 Service life (MTBF)	7
2.5 Hardware	7
2.5.1 CPU	7
2.5.2 Cache	7
2.5.3 RAM	7
2.5.4 Interfaces	7
2.5.5 Display	7
2.5.6 Touch screen	7
2.6 Mechanics	7
2.6.1 Dimensions	7
3. Installation	
3.1 Clearances	8
3.2 Noise protection measures	9
3.3 Earthing schematic	10
3.4 Installation of an expansion board	11
3.5 Exchanges of the cold-cathode tube	12
3.5.1 Opening of the device	12
3.5.2 De-installation of the tube	13
3.6 Commissioning	14
4. Configuration	
4.1 Jumpers	16
4.1.1 Jumper JP1	17
4.1.2 Jumper JP2	17
4.1.3 Jumper JP3	18
4.1.4 Jumper JP4	19
4.1.5 Jumper JP5	19
4.1.6 Jumper JP6	20
4.1.7 Jumper JP7	20
4.1.8 Setting of the configuration switches	21
4.2 BIOS-Setup	22
4.2.1 Setup main menü	22
4.2.2 Default CMOS setup	24
4.2.3 BIOS Features Setup	27
4.2.4 Chipset Features Setup	30
4.2.5 Power Managment Setup	33

AUSGABE  
MAY  
1996

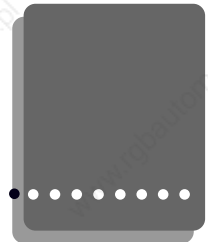

5. Special drivers

5.1	SVGA software for MS-DOS5	36
5.1.1	Driver installation	37
5.2	SVGA software for MS-WINDOWS	37
5.2.1	Driver installation	39
5.3	Touch screen drivers	40
5.3.1	DOS installation	42
5.3.2	WINDOWS 3.1 installation	43

6. Appendix

6.1	Options	44
6.1.1	Expanding of the main memory	44
6.1.2	External monitor	44
6.1.3	Flash disk/RAM disk	45
6.2	Connector assignments	46
6.2.1	The ISA-Bus	46
6.2.1.1	Pin assignments	47
6.2.1.2	Signal description	49
6.2.2	PC/104 expansion slot	53
6.2.3	DRAM socket	55
6.2.4	Silicon disk socket	56
6.2.5	Keyboard interface	57
6.2.6	System interface	57
6.2.7	Floppy disk interface	58
6.2.8	IDE/AT-bus hard disk interface	59
6.2.9	Parallel interface (Centronics)	59
6.2.10	Power connector	60
6.2.11	Monochrome LCD connector	61
6.2.12	Universal LCD connector	62
6.2.13	SVGA monitor connector	62
6.2.14	Serial interfaces	63
6.3	POST codes (Power-On Self-Test)	64
6.3.1	POST signal tone	64
6.3.2	POST messages	64
6.3.3	POST fault messages	64
6.3.4	POST codes	67
6.4	Documentation reference	70

Index	71
-------	----



# Conventions



## What to know

Information marked with this symbol is required for a fast startup. You should absolutely read it.

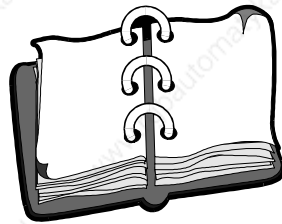

## What you should know

Information marked with this symbol presents further explanations of the operating mode.



## If you have some more time left

If you wish more detailed information then you should consider to read sections marked with this symbol.

# View



## 1.1 Front

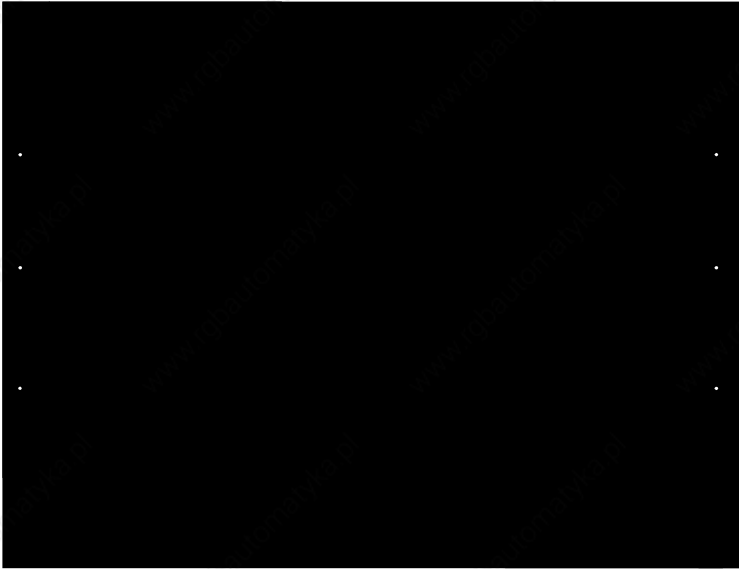

- ① = 10,4"-display with resistive touch sensor
- ② = yellow HD LED
- ③ = green Power LED
- ④ = front made of massive aluminum

## 1.2 Side view

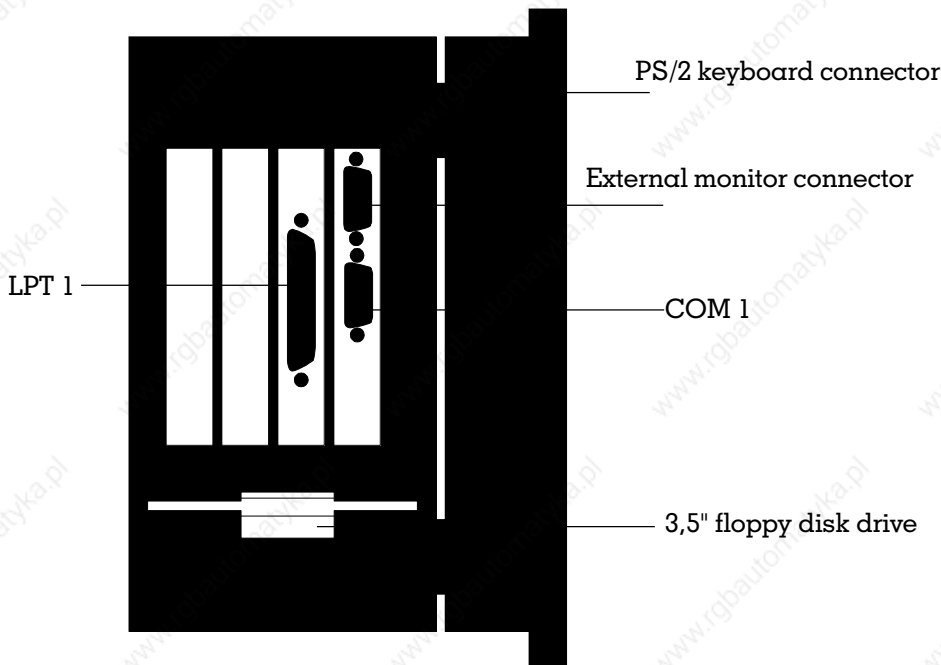

A parallel and a serial interface are available on default.

### 2.1 Connection data

Voltage: 24V / + 10% (DIN EN60204)  
 Current: 4A maximum / fuse M4A

### 2.2 Power loading

Two free PC-slots are available for the user for his/her own application. The supply of these boards is taken from the power supply of the VPCcompact. The following currents can be permanently drawn from each slot:

5V	1.5 amps
12V	0.8 amps
-5V	0.1 amps
-12V	0.1 amps

For short-terms (<1 sec) e.g. at powering-up also higher currents of up to 150% of the nominal value can be drawn. Thereby, the limits depend both on the ambient temperature and on the total power of the power supply (100 VA at 25 C°).

### 2.3 Environmental conditions

Temperature:	0 ... 45°C
Temperature variation:	< 15 °C/h
Humidity:	< 50%
Protection class:	front IP65 rear IP 20
EMC:	according to DIN EN50082-2 - in preparation
Chemical Resistance:	acetone methylene chloride methyl ethyl keytone isopropyl alcohol hexane ammonia-based glass cleaners
Vibrations in operation:	0.75 G, 20 - 200Hz sine wave
Shock proof during storage:	10 G
Resistance to fire:	front: UL-746C, 3/4" flame test

# Specifications

---

## 2.4 Service life (MTBF)

Cold-cathode tube:	10,000h
Hard disk:	300,000h

## 2.5 Hardware

The following sections describe the modules that make up the VPCcompact. This affects essentially the set-up of the central processing unit (CPU card).

### 2.5.1 CPU

Intel 486DX-4/100

### 2.5.2 Cache

16K 1st-level cache (CPU), 4-fold associative

### 2.5.3 RAM

4MB, PS/2, upgradable to 32 MB

### 2.5.4 Interfaces

LPT1, COM1, COM2 (required for touch screen)

### 2.5.5 Display

10,4" color, alternatively TFT (NEC NL6448AC33-L0) or STN (Samsung UG64I011-A).  
The correct color brilliance of the display is available after an operating time of approx. 20 minutes.



### 2.5.6 Touch screen

Resistive foil on glass media with its own controller

## 2.6 Mechanics

### 2.6.1 Dimensions

<b>Front:</b>	width:	304 mm
	height:	232 mm
<b>Rear:</b>	width:	283 mm
	height:	210 mm
	depth:	132 mm

The VPC compact is anticipated for the installation in the front of an arbitrary cabinet, desk or similar. Thus, there are some differences to the operation of of-the-shelf office PCs:

The cabinet used for installation must have an opening of min 211+3 mm x 284+3 mm (h x w).

**Attention:** During the installation, attention must be paid to the correct seating of the gasket at the faceplate so the front side IP65 protection class is guaranteed.

### 3.1 Clearances

Clearances must be kept around the VPCcompact to ensure air circulation for the removing of the heat being created in the device as well as to avoid induced noises.

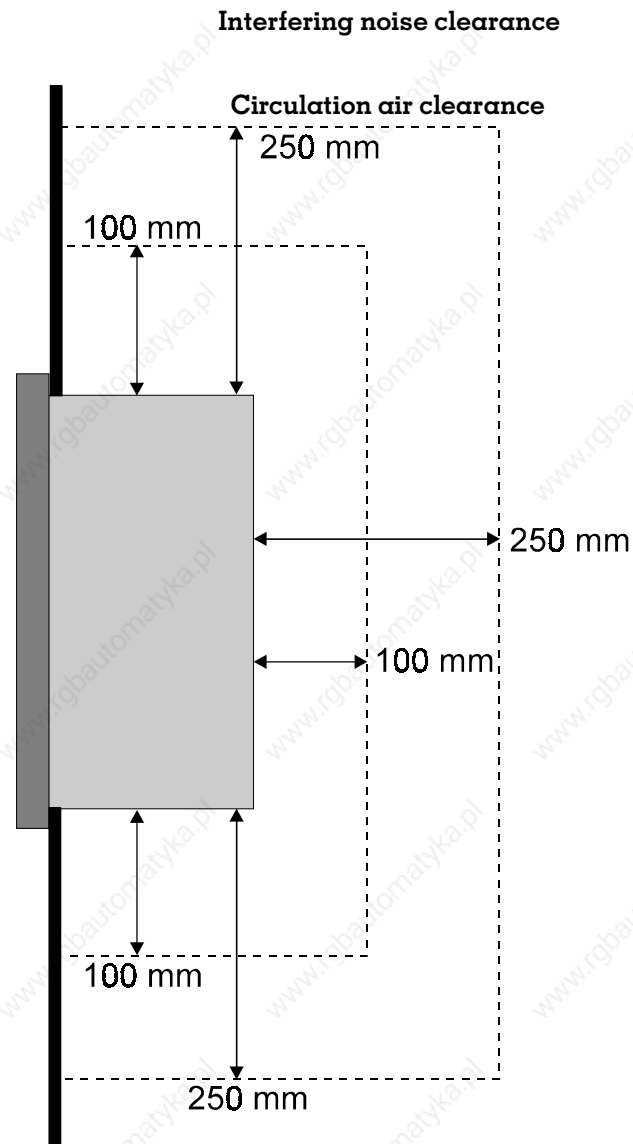



# Installation

---

## 3.2 Noise protection measures

Also the best electronics can guarantee only up to a determined noise level a safe functioning. The following notes should already be observed during the planning phase to avoid unnecessary failures of devices:

- run supply and signal lines of VPC devices shielded and as separately as possible.
- keep safety distance of 250 mm min. to potential interference sources.
- nearby located inductivities (contactors, relays, transformers) must be equipped with noise suppression measures (sheet metals, free-wheeling diodes, suppression devices).
- no fluorescent tubes in the direct proximity.
- define a central earthing point for all modules located in the system and plan all PE connections as short as possible and with generous cross-section.
- frequency converters are to be cleared by shielded filters (manufacturer-independent).
- Protection against high frequency noises is achieved by earthing both sides of the screen of the signal lines.
- Caution: Take care that no earth loops are created. In this case, only one side of the screen is to be connected. The other side is to be connected to PE via a Y capacitor.
- Interferences on cabling can be damped by additional purchasable filtering circuits that are installed before the VPC compact.

### 3.3 Earthing schematic

The grounding of the VPC compact serves two basic functions:

First, to ensure touching protection of the user and second, to work as interference protection measure. Therefore, the highest possible care must be used when grounding the device. For the touching protection that protects the operator against injurious potentials and/or voltages, a low-resistive connection of the earthing terminal to the earth potential is sufficient.

To guarantee a safe earthing of interferences, the earthing terminal must be connected to a central earthing point in the cabinet. Use a wire that is as short as possible. The connection should be made with an earthing cable with a cross section of 10 mm<sup>2</sup> minimum.

The earthing terminal is to be located directly beside the supply voltage input.

The 0V line of the supply voltage may not be connected to earth (PE) at the providing power supply (in the cabinet) since an earth loop may be created!

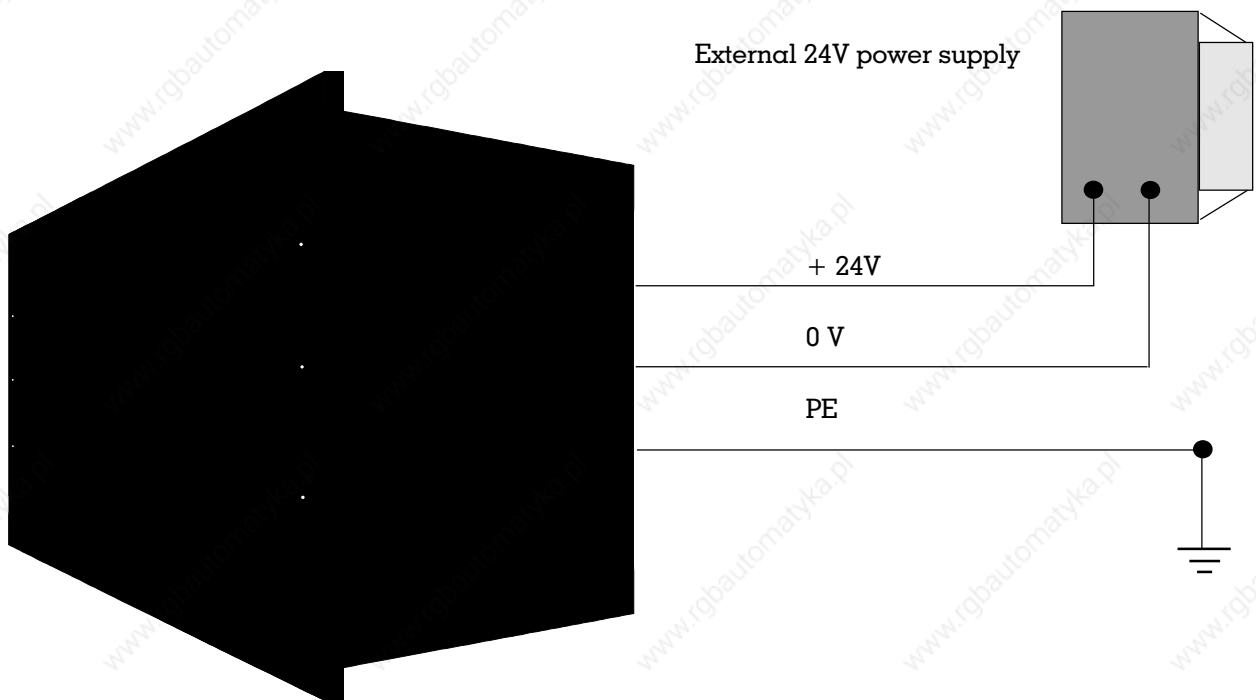

#### Attention!

The VPC compact may only be operated with safety extra-low-voltage according to **VDE 0100** (functional extra-low-voltage with safe separation). The control-power transformer must correspond to **VDE 0551**.

## Installation

---

### 3.4 Installation of an expansion board

The VPC compact is to be separated from the supply voltage before opening the device.

For the opening of the VPC compact and thus for the plugging-in or plugging-out of an expansion board, the fixing screws at the side of the device must be removed. Subsequently, the rear cover can be removed.

The expansion board is plugged into one of the two free slots and is fastened using an anticipated screw.

After that, the rear cover is fixed again.

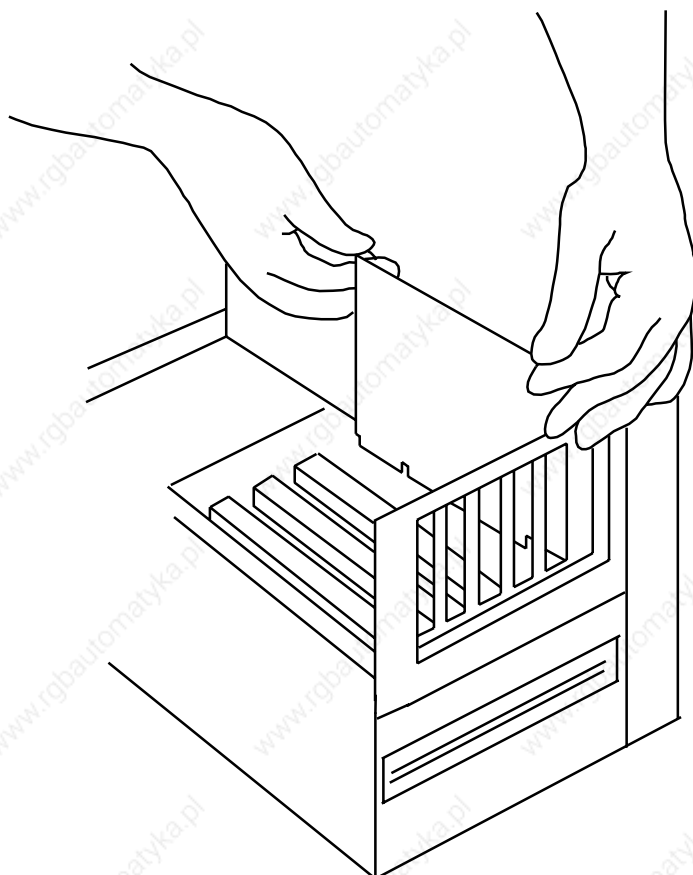

### 3.5 Exchanges of the cold-cathode tube

The cold-cathode tube has only a limited service life. Thus, depending on the power-up time and frequency it might be necessary to change the tube.

You require a medium-sized Phillips screw driver, a very small Phillips screw driver, a medium-sized screw driver and perhaps a pair of tweezers for the exchange of the tube.



**Attention!**

In any case separate the device previously from the supply voltage!

#### 3.5.1 Opening of the device

- Remove the screws at the outside of the casing (A)
- remove the rear cover
- remove the two fixing screws (B)
- swing the inner part of the device out

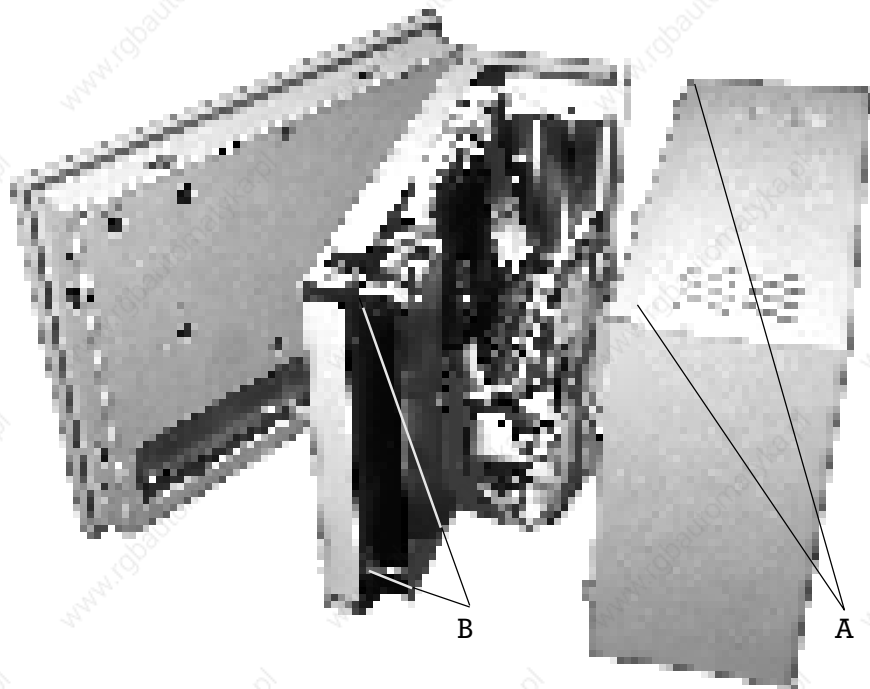

# Installation

## 3.5.2 Deinstallation of the tube

- Remove screws (C)
- remove the protective sheet (D)
- loosen the high voltage connector and remove it through the mounting opening (E)
- remove screw (F)
- pull out the tube (G) carefully

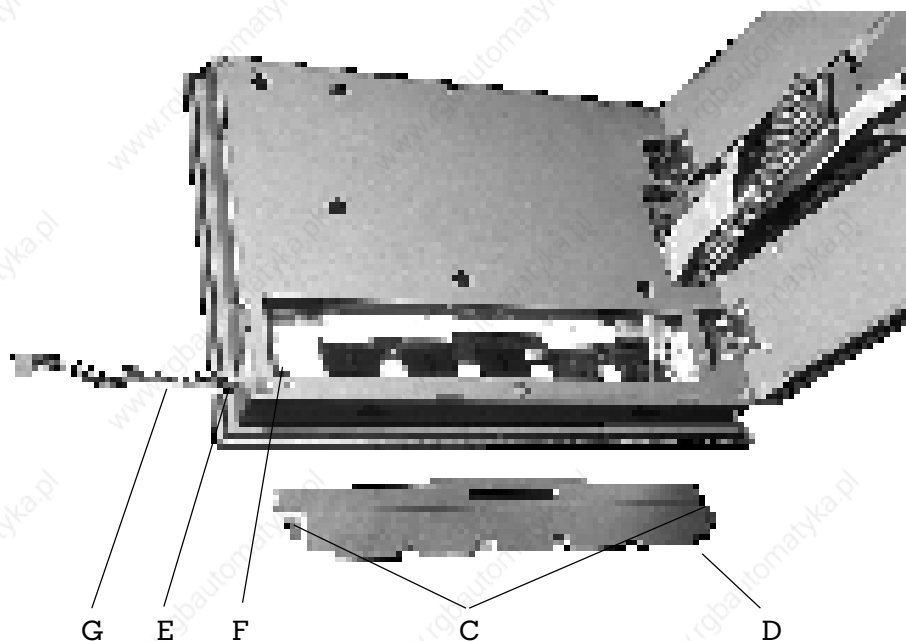

Assembly of the device is made in the reversed order.

### 3.6 Commissioning

All cable connections must be examined before the commissioning of the system. It is to be ensured that all voltages and signals correspond to the corresponding specifications.

- Turn off the system/equipment
- Install and interface the VPC compact
- Turn on the supply voltage
- The green LED on the faceplate in the lower left lights
- The VPC compact boots from the hard disk. Thereby, the yellow hard disk LED on the faceplate in the lower left flashes.
- The VPC compact display the prompt:

```
C:\>
```

Now, the VPC compact is ready for action and the desired application can be installed. Please refer for further notes concerning the installation of the software to the corresponding manuals.

Possibly, changes to the configuration of the VPC compact may be necessary. Please consider the following sections in this case.

**Caution:** Changes to the configuration can result in lasting damages to the system. Only authorized personnel are allowed to perform any changes.

Important user notes:

- The device may only be connected to systems approved by Systeme Lauer.
- Only trained and qualified persons who have familiarized themselves with the product are allowed to install and operate the device.
- The responsibility of persons operating the device must be clearly determined in order to avoid undefined competencies.
- The relevant safety regulations and standards must be observed.
- Before commissioning the device, this instruction manual must be read thoroughly.
- Modifications of or changes to the design of the device are not allowed. Systeme Lauer is not responsible for resulting damages.
- The supply voltage of the device must be within the range specified in the "Specifications" section. Systeme Lauer is not responsible for damages resulting from non-compliance to this requirement.
- The latest manuals and documentation are valid.

# Installation

.....

The specifications published by Systeme Lauer were determined with our methods and facilities; characteristics are only guaranteed to this respect. The user is responsible for testing and determining the suitability for the specific application or for use under actual conditions. Systeme Lauer does not assume any warranty for this.

Modifications reserved

### 4.1 Jumpers

The following drawing shows the order of the jumpers on the AI0486. The numeration is indicated in the individual descriptions and relates to the here shown view. The default setting is marked by a jumper in the respective individual descriptions.

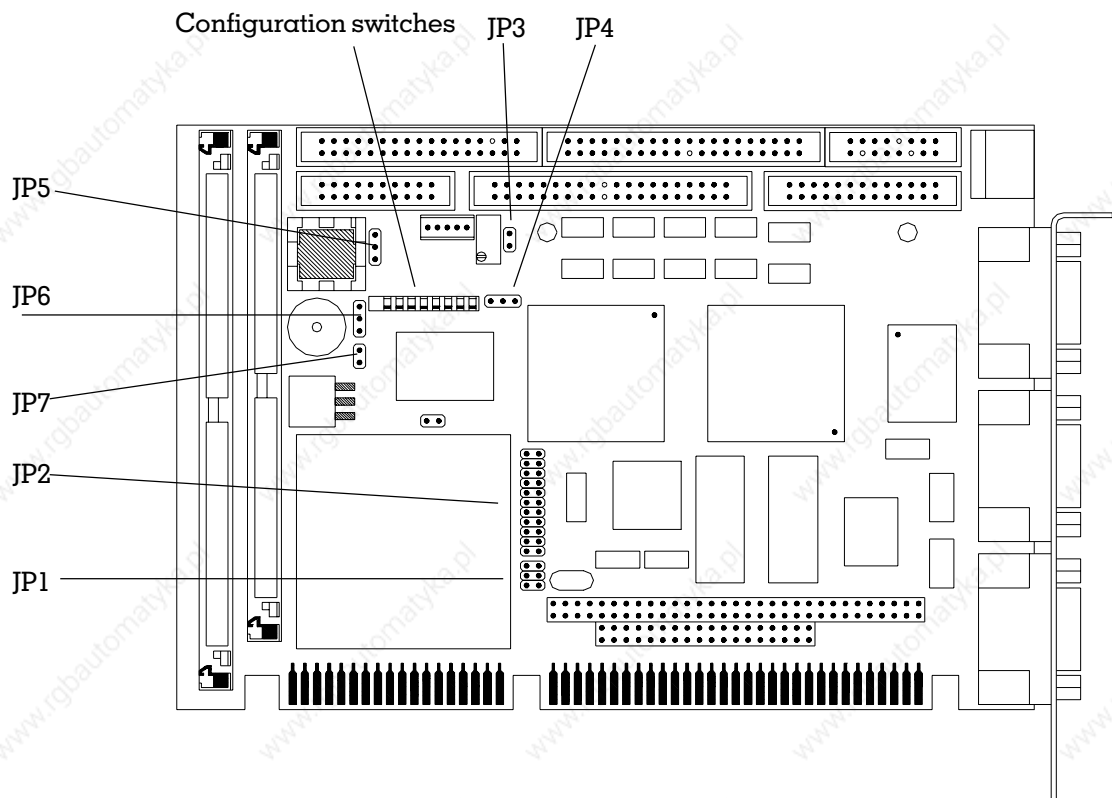



## Configuration

### 4.1.1 Jumper JP1

The clock of the CPU is determined with jumper JP1. Please refer to the figure for the location of the jumper.

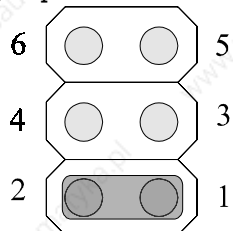

Jumper JP1: CPU clock			
Jumper	20 MHz	25 MHz	33 MHz
1-2		<b>X</b>	
3-4	<b>X</b>		
not used			<b>X</b>

### 4.1.2 Jumper JP2

The type of the used CPU is determined with jumper JP2. Please refer to the figure for the location of the jumper.

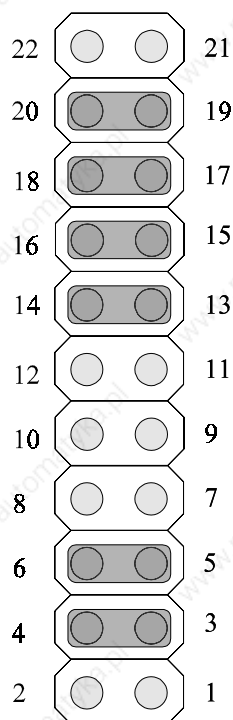

Jumper JP2: CPU Typ			
Jumper	Intel/AMD 486 SX	Intel/AMD 486 DX Intel/AMD 486 DX2	Intel 486 DX4
1-2		X	X
3-4	X		
5-6		X	X
7-8			
9-10			
11-12		X	X
13-14	X	X	
15-16	X	X	
17-18	X	X	
19-20	X	X	X
21-22			

#### 4.1.3 Jumper JP3

The software-controlled contrast voltage is selected with the on-board jumper JP3. Using the contrast control (potentiometer), the maximum possible contrast voltage is set. In this case, please take care to set the LCD contrast voltage in the BIOS-SETUP to the value 0. After the adjustment, the software can influence the contrast voltage only within the adjusted range.

A value set too high can destroy the display!

Jumper JP3: Contrast voltage	
Jumpers	Meaning
1-2 plugged	Adjustment of the screen contrast using the internal on-board contrast control and the software
1-2 tap	Adjustment of the screen contrast using an external potentiometer and the software

## Configuration

### 4.1.4 Jumper JP4

The polarity of the LCD enable signal is determined with jumper JP4. Please refer to the figure for the location of the jumper.

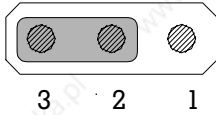

Jumper JP4: Polarity	
Jumper	Meaning
1-2 plugged	Panel-off low (0)
2-3 plugged	Panel-off high (1)

### 4.1.5 Jumper JP5

The external or internal battery is selected with jumper JP5. Please refer to the figure for the location of the jumper.

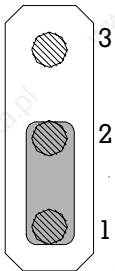

Jumper JP5: Internal battery	
Jumpers	Meaning
1-2 plugged	Internal battery is used
2-3 plugged	Internal battery is turned off
1-2 tap	Here, an external battery can be connected

#### 4.1.6 Jumper JP6

Jumper JP6 determines whether the internal loudspeaker should be used for tone output. Please refer to the figure for the location of the jumper.

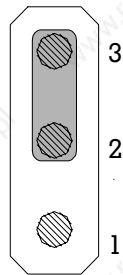

Jumper JP5: Loudspeaker	
Jumpers	Meaning
1-2 plugged	External loudspeaker connectable via the system interface
2-3 plugged	Internal loudspeaker is activated

#### 4.1.7 Jumper JP7

The default type of the primary monitor is determined with this jumper. Please refer to the figure for the location of the jumper.

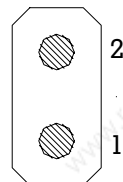

Jumper JP5: Primary monitor	
Jumpers	Meaning
1-2 plugged	Color monitor
1-2 not plug	Monochrome monitor

# Configuration

## 4.1.8 Setting of the configuration switches

A DIL switch bank located on the single-board computer is used for the configuration of the board. Please contact us for the supported LC-display types and the settings of the SW.3 to SW.8 configuration switches.

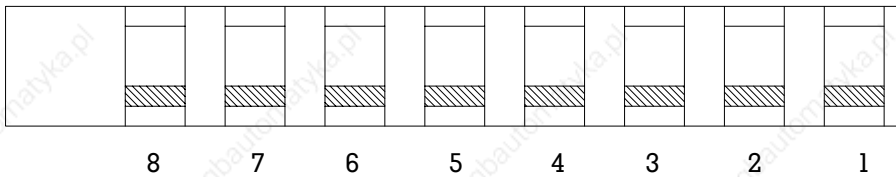

Configuration switches	
Switches	Meaning
SW.1	reserved
SW.2	ON: CRT, OFF : CRT and LCD simultaneously
SW.3	screen type 0
SW.4	screen type 1
SW.5	screen configuration 0
SW.6	screen configuration 1
SW.7	screen configuration 2
SW.8	screen configuration 3

Default settings		
for TFT	SW6	ON
for STN	SW3, SW4, SW6	ON

## 4.2 BIOS-Setup

The Award BIOS features a built-in setup program that allows you to determine the base system configuration like the drive types or the used screen mode. The configuration entered via the setup is stored in a battery-buffered RAM. Thus, it remains preserved also after the switching-off of the computer. This information will be used by the BIOS to configure the computer during the boot phase. Configuration changes to the BIOS can only be performed using a connected external keyboard.

The following message appears on the monitor during the boot process:

### Press DEL to enter SETUP

You can access the setup menu built into the BIOS by pressing the DEL key.

### 4.2.1 Setup main menü

ROM ISA BIOS (2C4I8F10) CMOS SETUP UTILITY AWARD SOFTWARE, INC.	
STANDARD CMOS SETUP BIOS FEATURES SETUP CHIPSET FEATURES SETUP POWER MANAGEMENT SETUP LOAD BIOS DEFAULTS LOAD SETUP DEFAULTS	PASSWORD SETTING IDE HDD AUTO DETECTION SAVE & EXIT SETUP EXIT WITHOUT SAVING
Esc : Quit F10 : Save & Exit Setup	↑ ↓ → ← : Select Item (Shift) F2 : Change Color
Time, Date, Hard Disk Type...	

### Setup main menu

The following submenus can be selected:

#### Standard CMOS Setup

All default BIOS settings are performed here.

#### BIOS Features Setup

This menu contains all advanced BIOS settings.

# Configuration

---

## **Chipset Features Setup**

In this menu, the chipset-specific settings can be performed.

## **Power Management Setup**

This menu allows you to perform all settings that are necessary for the current saving mode.

## **Load BIOS Defaults**

Loads the BIOS setup default values, the system runs most safely with.

## **Load SETUP Defaults**

Loads the setup default values, the system features the maximum power with.

## **Password Setting**

A password can be entered at this point with which the system or the setup can be protected against an unauthorized access.

## **IDE HDD Auto Detection**

In this menu, the BIOS tries to read-out the hard disk parameters of the IDE hard disk. Thereby, several possibilities might be presented for selection. The BIOS supports also the extended modes for IDE hard disks with a capacity larger than 528 MB.

## **Save & Exit Setup**

Saves the performed setup changes in CMOS and exits the setup.

## **Exit Without Save**

Rejects the performed setup changes and exits the setup.



4.2.2 Default CMOS setup

ROM ISA BIOS (2C4I8F10) STANDARD CMOS SETUP AWARD SOFTWARE, INC.											
Date (mm:dd:yy) : Thu, Apr 6 1995 Time (hh:mm:ss) : 17 : 17 : 30											
	CYLS.	HEADS	PRECOMP	LANDZONE	SECTORS	MODE					
Drive C : User ( 202Mb)	987	12	65535	986	35	N O R -					
MAL											
Drive D : None ( 0Mb	0	0	0	0	0						
Drive A : 1.44M, 3.5 in.											
Drive B : None											
Video : EGA/VGA	<table border="1"> <tr> <td>Base Memory: 640K</td> </tr> <tr> <td>Extended Memory: 3328K</td> </tr> <tr> <td><u>Other Memory: 128K</u></td> </tr> <tr> <td>Total Memory: 4096K</td> </tr> </table>							Base Memory: 640K	Extended Memory: 3328K	<u>Other Memory: 128K</u>	Total Memory: 4096K
Base Memory: 640K											
Extended Memory: 3328K											
<u>Other Memory: 128K</u>											
Total Memory: 4096K											
Halt On : All Errors											
ESC : Quit	↑ ↓ → ← : Select Item			PU/PD/+/- : Modify							
F1 : Help	(Shift)F2 : Change Color										

**Default CMOS setup**

The following system parameters are adjustable:

**Date**

Setting of the current date

- Day (01 to 31)
- Month (Jan to Dec)
- Year (1900 to 2099)

**Time**

Setting of the current time

- Hours (00 to 23)
- Minute (00 to 59)
- Second (00 to 59)

**Drive C, Drive D**

- Setting of the hard disk parameters
- No hard disk None
- or a type from the table:



# Configuration

## Hard disk types

Type	MB	Cyl	Heads	Sectors	Precomp	Landing zone	Modell (e.g.)
1	10	306	4	17	128	305	TEAC SD510
2	20	615	4	17	300	615	Seagate ST225
3	30	615	6	17	300	615	
4	62	940	8	17	512	940	
5	46	940	6	17	512	940	
6	20	615	4	17	None	615	Seagate ST125
7	30	462	8	17	256	511	
8	30	733	5	17	None	733	Tandon TM703
9	112	900	15	17	None	901	
10	20	820	3	17	None	820	
11	35	855	5	17	None	855	
12	49	855	7	17	None	855	
13	20	306	8	17	128	319	Disctron 526
14	42	733	7	17	None	733	
16	20	612	4	17	0	663	
17	40	977	5	17	300	977	
18	56	977	7	17	None	977	
19	59	1024	7	17	512	1023	
20	30	733	5	17	300	732	
21	42	733	7	17	300	732	
22	30	733	5	17	300	733	Seagate ST4038
23	10	306	4	17	0	336	
24	40	977	5	17	None	976	Seagate ST4051
25	76	1024	9	17	None	1023	Seagate ST4096
26	71	1224	7	17	None	1223	Maxtor 2085
27	111	1224	11	17	None	1223	Maxtor 2140
28	152	1224	15	17	None	1223	Maxtor 2190
29	68	1024	8	17	None	1023	Maxtor 1085
30	93	1024	11	17	None	1023	Maxtor 1105,1120
31	83						
		918					
			11				
				17			
					None		
						1023	
							Maxtor 1170
							CDC 9415
32	69	925	9	17	None	926	
33	85	1024	10	17	None	1023	
34	102	1024	12	17	None	1023	

**Drive A, Drive B**

Setting of the type of the installed floppy disk drives

- |                       |                |
|-----------------------|----------------|
| · No drive            | None           |
| · 360 KB, 5 1/4 inch  | 360K, 5.25 in. |
| · 1.2 MB, 5 1/4 inch  | 1.2M, 5.25 in. |
| · 720 KB, 3 1/2 inch  | 720K, 3.5 in.  |
| · 1.44 MB, 3 1/2 inch | 1.44M, 3.5 in. |
| · 2.88 MB, 3 1/2 inch | 2.88M, 3.5 in. |

**Video**

Setting of the video adapter

- |                            |         |
|----------------------------|---------|
| · Monochrome video adapter | MONO    |
| · CGA 40 video adapter     | CGA 40  |
| · CGA 80 video adapter     | CGA 80  |
| · EGA or VGA               | EGA/VGA |

**Hold on**

Halt the boot process when the following errors occur

- |   |                   |
|---|-------------------|
| · No fault  | No errors         |
| · All appeared faults   | All error         |
| · All faults, except faults of the keyboard                             | All, But Keyboard |
| · All faults, except floppy disk errors                                 | All, But Diskette |
| · All faults, except faults of the keyboard<br>and of the floppy drives | All, But disk/Key |

**Memory size of the computer** (is only displayed, not changeable)

- |   |                 |
|---|-----------------|
| · Main memory                           | Base memory     |
| · Extended memory above 1 MB            | Extended memory |
| · Memory in the range of 640 KB to 1 MB | Other memory    |
| · Entire installed memory               | Totally memory  |

# Configuration

# 4

## 4.2.3 BIOS Features Setup

ROM ISA BIOS (2C4I8F10) BIOS FEATURES SETUP AWARD SOFTWARE, INC.			
Virus Warning	: Disabled	CPU Internal Cache	: Enabled
Security Option	: Setup		
Quick Power On Self Test	: Enabled	Video BIOS Shadow	: Enabled
Boot Up Floppy Seek	: Disabled	C8000-CFFFF Shadow	: Disabled
Boot Up NumLock Status	: On	D0000-D7FFF Shadow	: Disabled
Boot Up System Speed	: High	D8000-DFFFF Shadow	: Disabled
		E0000-E7FFF Shadow	: Disabled
		E8000-EFFFF Shadow	: Disabled
Boot Sequence	: C,A		
Swap Floppy Drive	: Disabled		
IDE HDD Block Mode	: Enabled		
Typematic Rate Setting	: Disabled		
Typematic Rate (Chars/Sec)	: 6		
Typematic Delay (Msec)	: 250		
Gate A20 Option	: Fast	ESC	: Quit
		F1	: Help
Memory Parity Check	: Disabled	F5	: Old Values (Shift) F2 : Color
		F6	: Load BIOS Defaults
		F7	: Load Setup Defaults

### BIOS features setup

The following system parameters are adjustable:

#### Virus Warning

Check whether changes are performed on the boot block during the operation via the BIOS

- Virus warnings ON Enable
- Virus warnings OFF Disable

#### Security option

Protect system by password

- Password protection for the setup Setup
- Password protection for the system System

#### Quick Power on Self Test

Determines the length the self-test during the system start

- Shortened self-test ON Enable
- Shortened self-test OFF Disable

**Boot up Floppy Seek**

Test of the floppy disk drive at the systems start

- Floppy disk drive ON
- Floppy disk drive OFF

**Boot up NumLock Status**

Status of the numerical key block

- Numerical key block On
- Numerical key block OFF

**Boot Up System Speed**

Setting of the processor speed

- High processor speed High
- Low processor speed Low

**Boot Sequence**

Sequence of the system loading attempt

- Drive A, drive C (default) A, C
- Drive C, drive A C, A

**Swap Floppy Drive**

Exchanges the floppy disk assignment A/B to B/A

- Floppy disk assignment A/B(default) Enable
- floppy disk assignment B/A Disable

**IDE HDD Block Mode**

Switches the block mode for IDE hard disks

- IDE BLOCK MODE ON Enable
- IDE BLOCK MODE OFF Disable

**Typematic Rate Setting**

Enabling of the settings for the automatic key repetition

- Programmed key repetition ON Enable
- Programmed key repetition OFF Disable

**Typematic Rate (Chars/Sec)**

- Number of the key repetitions
- Number of the key repetitions per second 6/8/10/12/15/20/24/30

**Typematic Delay (msec)**

Determines the delay up to the activation of the automatic key repetition function

- Time delay in msec 250/500/750/1000

# Configuration

---

## Gate A20 Option

Mode of the A20 address line

- Switching via the PS/2 port 92h Fast
- Switching via the keyboard controller Normal

## Memory Parity Check

Activation of the parity check of the main memory

- Parity check ON Enable
- Parity check OFF Disable

## CPU Internal Cache

Activation of the CPU of internal cache

- CPU cache ON Enable
- CPU cache OFF Disable

## Video BIOS Shadow

Copy the video BIOS into RAM (Shadow)

- Shadow ON Enable
- Shadow OFF Disable

## C8000-CFFFF Shadow ... E8000-EFFFF Shadow

Copy the shadow ROM BIOS into RAM (Shadow)

- Shadow ON Enable
- Shadow OFF Disable

Only available ROM devices are copied into RAM. No area is released for shadow RAM if an area for shadowing is activated in which no ROM device is found.

# 4

# Configuration

## 4.2.4 Chipset Features Setup

ROM ISA BIOS (2C4I8F10) CHIPSET FEATURES SETUP AWARD SOFTWARE, INC.	
Auto Configuration : Enable	Onboard FDC : Enabled
AT Bus Clock : 1/4 CLKIN	Onboard ISA IDE : Primary
System Shadow : Cacheable	Onboard Serial Port1 : COM1
Video Shadow : Cacheable	Onboard Serial Port2 : COM2
At 00000000H 0KB : OnBoard NoCa	COM3 & COM4 Address : 338H,238H
At 00000000H 0KB : OnBoard NoCa.	Onboard LPT Port : 378H
	Onboard Mouse Supp. : Enabled
	Contrast LCD : 127
	MDFeature Base : 100H
	ESC : Quit      ↑↓→←: Select Item
	F1 : Help      PU/PD/+/-: Modify
	F5 : Old Values (Shift)F2 : Color
	F6 : Load BIOS Defaults
	F7 : Load Setup Defaults

### Chipset features setup

The following system parameters are adjustable:

#### Auto Configuration

Setting of the automatic setup of the AT-BUS CLOCK

- Automatic setup      Enable
- Manual setting      Disable

#### AT BUS Clock

Setting of the asynchronous bus clock rate or the divider for synchronous bus clock

- Asynchronous bus clock      7.159 MHz
- Divider for synchronous bus clock      x/x CLKIN

#### System Shadow

Activation of the CPU-internal cache for the system BIOS

- CPU cache ON      Cacheable
- CPU cache OFF      Non-Cacheable

# Configuration

## Video Shadow

Activation of the CPU-internal cache for the video BIOS

- CPU cache ON Cacheable
- CPU cache OFF Non-Cacheable

## At 0000000H OKB

Disabling of the CPU-internal cache starting at a determined address for a determined size of the main memory or the ISA address range. The address and the size must be adjusted likewise. This setting serves also to generate a window for the ISA-bus.

- No cache for main memory OnBoard NoCa.
- No cache for ISA address range OffBoard NoCa.

## Onboard FDC

Activation of the floppy disk interface on the board

- Floppy disk interface ON Enable
- Floppy disk interface OFF Disable

## Onboard ISA IDE

Selection of the IDE interface on the board

- As the first IDE interface in the system Primary
- As the second IDE interface in the system Secondary
- IDE interface OFF Disable

## Onboard Serial Port1

Setting of the base address of the first serial interface

- As COM1 (address 3F8h with IRQ4) COM1
- As COM2 (address 2F8h with IRQ4) COM2
- As COM3 (with IRQ4) COM3
- As COM4 (with IRQ4) COM4
- Serial interface OFF Disable

## Onboard Serial Port2

Setting of the base address of the second serial interface

- As COM1 (address 3F8h with IRQ3) COM1
- As COM2 (address 2F8h with IRQ3) COM2
- As COM3 (with IRQ3) COM3
- As COM4 (with IRQ3) COM4
- Serial interface OFF Disable

**COM3 & COM4 Address**

Setting of the base address of COM3 and COM4

- |                                   |            |
|-----------------------------------|------------|
| · 338H for COM3 and 238H for COM4 | 338H, 238H |
| · 3E8H for COM3 and 2E8H for COM4 | 3E8H, 2E8H |
| · 2E8H for COM3 and 2E0H for COM4 | 2E8H, 2E0H |
| · 220H for COM3 and 228H for COM4 | 220H, 228H |

**Onboard LPT port**

Setting of the base address of the parallel interface

- |                                    |         |
|------------------------------------|---------|
| · As LPT1 (address 378h with IRQ7) | 378H    |
| · As LPT2 (address 278h with IRQ7) | 278H    |
| · As LPT3 (with IRQ7)              | 3BCH    |
| · Parallel interface OFF           | Disable |

**Onboard Mouse Supp.**

Activation of the PS/2 mouse interface

- |                            |         |
|----------------------------|---------|
| · PS/2 mouse interface ON  | Enable  |
| · PS/2 mouse interface OFF | Disable |

**Contrast LCD**

Setting of the positive and negative contrast voltage

- |                                      |            |
|--------------------------------------|------------|
| · Value for output voltage           | (0 to 255) |
| · Value "0" is the maximum voltage   |            |
| · Value "255" is the minimum voltage |            |

**MDFeature Base**

Setting of the base address for the MicroDesign feature port. Since the entered address is not checked by the system on collision (e.g. with the address of a serial interface) it has to be checked before the selection that this is a free or unused address.

- |                |                |
|----------------|----------------|
| · Base address | (100h to 3F8h) |
|----------------|----------------|



# Configuration

## 4.2.5 Power Management Setup

ROM ISA BIOS (2C4I8F10) POWER MANAGEMENT SETUP AWARD SOFTWARE, INC.	
Power Management : Disable	IRQ 1 (Keyboard) : Enable
PM Control by APM : Yes	IRQ 3 (COM 2) : Enable
Video Off Method : V/H SYNC+Blank	IRQ 4 (COM 1) : Enable
Video Off Option : Susp,Stby <sup>®</sup> Off	IRQ 5 (LPT or LAN) : Enable
** PM Timers **	IRQ 6 (Floppy Disk) : Enable
HDD Power Down : Disable	IRQ 7 (LPT or LAN) : Enable
System Doze : Disable	IRQ 8 (RTC,OS2) : Disable
System Standby : Disable	IRQ 9 (Reserved) : Enable
System Suspend : Disable	IRQ 10 (Reserved) : Enable
** PM Events **	IRQ 11 (Reserved) : Enable
Video Activities : Disable	IRQ 12 (PS2 mouse) : Enable
DMA Activities : Enable	IRQ 13 (387) : Enable
	IRQ 14 (Hard Disk) : Enable
	IRQ 15 (Reserved) : Enable
	ESC : Quit:           ↑↓→← : Select Item
	F1 : Help            PU/PD/+/- : Modify
	F5 : Old Values   (Shift)F2 : Color
	F6 : Load BIOS Defaults
	F7 : Load Setup Defaults

### Power Management Setup

Depending on the processor type, the setup screen for the power management looks differently. Also, the settings of the individual parameters change the setup screen.

The following system parameters are adjustable:

### Power Management

Setting of the current saving modes

- |                                       |             |
|---------------------------------------|-------------|
| · Minimum current saving              | Min Saving  |
| · Maximum current saving              | Max Saving  |
| · Optimal current saving              | Optimize    |
| · Adjustable times for current saving | User Define |
| · Current saving mode from            | Disable     |

**PM Control by APM**

Activation of the APM interface for current saving mode

- APM ON
- APM OFF

**Video Off Method**

Setting of the current saving mode of the screen

- Empty screen Blank screen
- Current saving mode via H-SYNC and V-SYNC V-H  
SYNC + Blank

**Video Off option**

Current saving level of the current saving mode, the screen should be activated with

- Current saving mode never activated Always On
- Current saving mode in Suspend mode activated Suspend<sup>®</sup> Off
- Current saving mode in Suspend mode and stand-by activated Susp, Stby<sup>®</sup> Off
- Current saving mode on all levels activated All mode Off

**HDD Power Down**

Activation of the current saving mode of the IDE hard disk

- Time up to the activation of the current saving mode 1 min - 15 in
- Activation of the current saving mode in Suspend mode When Suspend
- Current saving mode OFF Disable

**System Doze**

Activation of the current saving level 1 of the current saving mode

- Time up to the activation of the current saving level 10 sec - 3 h
- Do not activate the current saving level Disable

**System Standby**

Activation of the current saving level 2 of the current saving mode

- Time up to the activation of the current saving level 10 sec - 3 h
- Do not activate the current saving level Disable

# Configuration

---

## System Suspend

Activation of the current saving level 3 of the current saving mode

- Time up to the activation of the current saving level 10 sec - 3 h
- Do not activate the current saving level Disable

## Video Activities

Awake from the current saving mode on video activities

- Video activities ON Enable
- Video activities OFF Disable

## DMA Activities

Awake from the current saving mode on DMA activities

- DMA activities ON Enable
- DMA activities OFF Disable

## IRQ 1 - IRQ 15

Awake from the current saving mode on IRQ activities

- IRQ activities ON Enable
- IRQ activities OFF Disable

The most important points of the supplied software are addressed in this section. The drivers of the board manufacturer and the drivers for the operation of the touch screen are supplied with the system. Regardless of this, a basic configuration of the hardware has already been performed in our house. Normally, no other settings must be made.

### 5.1 SVGA software for MS-DOS

A special SVGA software is supplied (programs and driver) for the extended functions of the on-board SVGA controller under the MS-DOS operating system. However, the operation of the SVGA controller is also possible without this SVGA software.

Only the VGA resolutions are available (maximum 640 x 480) when using the color LCD.

The SVGA software for the MS-DOS operating system can be found on the DOS installation floppy disk (DOS INSTALL) that accompanies the boards. The following files are stored on the floppy disk:

#### Text

- README.TXT Listing of all drivers and programs on the floppy disk.
- README.1ST If present, the file contains the last information and changes of the operating manual.

#### Drivers

- ACAD.LIF CAR CAD 386, AutoShade and 3D studio screen driver
- CADVANCE.LIF Cadvance screen driver
- GENERIC.LIF Generic CADD screen driver
- LOTUS.LIF Lotus 1-2-3 and Lotus-Symphony screen driver
- PCAD.LIF PCAD screen driver
- WORD.LIF Microsoft Word for MS-DOS-screen driver
- WPLIF WordPerfect screen driver
- UTILITY.LIF ANSI.SYS driver for the extended VGA mode (Paradise mode)

#### Programs

- INSTALL.COM menu-controlled installation program
- CHIPTST.EXE (is used by INSTALL.COM)
- KDINSTAL.EXE (is used by INSTALL.COM)
- READID.EXE (is used by INSTALL.COM)
- VGAMODE.EXE (is used by INSTALL.COM)

## Special drivers

### 5.1.1 Driver installation

A special SVGA software (programs and driver) must be installed on the computer to be able to use the extended functions of the WD90C24 controller under the MS-DOS operating system.

The INSTALL.COM program available on the DOS INSTALL floppy disk is a menu-controlled installation program for the SVGA software. Follow the procedure described below:

- Make a backup of the DOS INSTALL floppy disk and store the original at a safe place.
- Ensure that the board is correctly plugged into your computer and the switches and jumpers of the board are correctly set.
- Start the INSTALL.COM installation program on the floppy disk in drive A: of your computer. For this, enter:  
**A:install<ENTER>**
- Take note to exactly follow the commands when using the installation program as these can be differently depending on selected driver group.

### 5.2 SVGA software for MS-WINDOWS

A special SVGA software (programs and driver) is supplied for the extended functions of the on-board SVGA controller under the MS-WINDOWS user interface. However, the operation of the SVGA controller is possible also without the SVGA software.

The SVGA software for the MS-WINDOWS user interface can be found on the WINDOWS INSTALL floppy disk that accompanies the board.

Following files are available on the floppy disk:

#### Drivers

- |                |                                  |
|----------------|----------------------------------|
| · vga.dr       | Windows 3.1 driver (default VGA) |
| · wd24_8.dr    | Windows 3.1 driver               |
| · wd241k_4.dr  | Windows 3.1 driver               |
| · wd2464_4.dr_ | Windows 3.1 driver               |
| · wd2464_h.dr_ | Windows 3.1 driver               |
| · wd2480_4.dr_ | Windows 3.1 driver               |
| · wddci.dr_    | Windows 3.1 driver               |

#### Character sets

- |               |                           |
|---------------|---------------------------|
| · 8514fix.fo  | Windows 3.1 character set |
| · 85140em.fo_ | Windows 3.1 character set |
| · 8514sys.fo_ | Windows 3.1 character set |
| · cg40woa.fo_ | Windows 3.1 character set |

- cga80woa.fo\_ Windows 3.1 character set
- coure.fo\_ Windows 3.1 character set
- courf.fo\_ Windows 3.1 character set
- dosapp.fo\_ Windows 3.1 character set
- ega40woa.fo\_ Windows 3.1 character set
- ega80woa.fo\_ Windows 3.1 character set
- serife.fo\_ Windows 3.1 character set
- serif.fo\_ Windows 3.1 character set
- smalle.fo\_ Windows 3.1 character set
- smallf.fo\_ Windows 3.1 character set
- sserife.fo\_ Windows 3.1 character set
- sseriff.fo\_ Windows 3.1 character set
- symbole.fo\_ Windows 3.1 character set
- symbolf.fo\_ Windows 3.1 character set
- vgaoem.fo\_ Windows 3.1 character set
- vgasys.fo\_ Windows 3.1 character set
- vgafix.fo\_ Windows 3.1 character set

#### Setup programs

- setup.exe Windows 3.1 setup file
- setup.inf Windows 3.1 setup file
- setup.lst Windows 3.1 setup file
- setup.mst Windows 3.1 setup file
- setupapi.inc Windows 3.1 setup file
- dciman.dl\_ Windows 3.1 setup file
- mscomstf.dll Windows 3.1 setup file
- mscuistf.dll Windows 3.1 setup file
- msdetstf.dll Windows 3.1 setup file
- msinsstf.dll Windows 3.1 setup file
- msshlstf.dll Windows 3.1 setup file
- msuilstf.dll Windows 3.1 setup file
- oemsetup.inf Windows 3.1 setup file
- pvga.gr\_ Windows 3.1 setup file
- v7vga.3g\_ Windows 3.1 setup file
- vddpvga.38\_ Windows 3.1 setup file
- ver.dll Windows 3.1 setup file
- vgalogo.lg\_ Windows 3.1 setup file
- vgalogo.rl\_ Windows 3.1 setup file
- vidchg.ex\_ Windows 3.1 setup file
- vidchg.hl\_ Windows 3.1 setup file
- \_mssetup.exe Windows 3.1 setup file
- \_mstest.exe Windows 3.1 setup file

## Special drivers

---

### 5.2.1 Driver installation

A special SVGA driver must be installed on the computer to be able to use the extended functions of the on-board SVGA controller under the MS-WINDOWS user interface.

The Western Digital Video Changer (vidchg.exe) program available on the WINDOWS INSTALL floppy disk is an installation program for SVGA driver. It can be run under the MS-WINDOWS user interface via the program or file manager. An on-line help presents comprehensive information about every item of the installation program.

To avoid damages, check the selection of the resolution and image refresh rate and whether your monitor supports the selected options.

#### Resolution

Select a resolution for the screen driver

- 640 x 480 This screen resolution allows the selection of the following options for the color settings: 16, 25, 32 K and 64 K colors.
- 800 x 600 This screen resolution allows 16 or 256 colors to be selected. Furthermore, the image refresh rate can be selected, e.g. 56 Hz, 60 Hz or 72 Hz, respectively non-interlaced.
- 1024 x 768 This screen resolution also allows 16 or 256 colors to be selected. 60 Hz interlaced or non-interlaced can be selected for the image refresh rate.

#### Refresh Rate

Select an image refresh rate for the adjusted resolution

- 640 x 480 No image refresh rate can be selected for this resolution.
- 800 x 600 The image refresh rate can be selected as 56 Hz, 60 Hz or 72 Hz non-interlaced.
- 1024 x 768 60 Hz interlaced or non-interlaced can be selected for the image refresh rate.

The image quality is usually improved using a higher image refresh rate. Furthermore, non-interlaced displays a better image than interlaced.

**Color**

Select the color option for the set resolution

- 640 x 480      possible color options are 16, 256, 32 K and 64 K colors
- 800 x 600      possible color options are 16 and 256 colors
- 1024 x 768     possible color options are 16 and 256 colors

The following options can be set if 256 colors have been selected for all resolutions:

**Font Size**

Select a font size for the display

- |                                |            |
|--------------------------------|------------|
| · Large characters for display | Large font |
| · Small characters             | Small font |

**Font Caching**

Turn font caching On or OFF

- |                  |                |
|------------------|----------------|
| · Turn cache on  | Font cache on  |
| · Turn cache off | Font cache off |

Font Caching improves the speed of the screen representation of characters.

**Cursor**

Select a cursor type

- |                        |        |
|------------------------|--------|
| · Normal cursor        | Normal |
| · Reverse video cursor | Invert |

Changes of the cursor type become immediately effective. A re-start of Windows is not necessary.

**Virtual Screen**

Activates a virtual screen

- |                                   |     |
|-----------------------------------|-----|
| · Activate virtual image memory   | On  |
| · Deactivate virtual image memory | Off |

**5.3 Touch screen drivers**

The installation of touch screen drivers is necessary to be able to operate programs via the touch screen. These drivers convert touches on the touch screen into the positioning of a mouse cursor. Thereby, the cursor follows the touch point on the screen. An action (mouse button) is initiated by touching the screen.



# Special drivers

5

Following files are available on the floppy disk:

A:

	!READ.MEI
	INSTALL.EXE
	VGA.GIF
	DISK.ID
	@6253.ADF
	PKUNZIP.EXE
	TOUCH
	README.ELO
	ELODEV.EXE
	ELOCALIB.EXE
	INFO.EXE
	TOUCHES.EXE
	BUSSTAT.EXE
	COMDUMP.EXE
	SAWDUMP.EXE
	ELODEMO.ZIP
	ELODIFF.ZIP
	SETUP.EXE
	MMDOS
	README.MM
	MONMOUSE.COM
	NOMOUSE.COM
	PATCHMSE.EXE
	TUTORIAL.EXE
	MMDIFF.ZIP
	MMWIN
	README.MMW
	MONMOUSE.DRV
	VMMD.386
	ELOCALW.CPL
	ELOCALW.HLP
	CURSOFF.EXE
	ZAXIS.EXE
	METER.DLL
	ELO.BMP
	MMWDIFF.ZIP
	OEMSETUP.INF
	DUTCH
	ELOCALW.CPL
	FRENCH
	ELOCALW.CPL
	ELOCALW.HLP
	GERMAN
	ELOCALW.CPL
	ELOCALW.HLP
	ITALIAN
	ELOCALW.CPL
	SPANISH
	ELOCALW.CPL
	ELOCALW.HLP
	TCHBACK
	README.TCB
	TCHBACK.EXE
	TCBDIFF.ZIP

An external keyboard is necessary for the first installation of the touch screen driver. Connect the keyboard. Insert the ELO TOUCH driver floppy disk into drive A: and enter the following at the DOS prompt:

A:INSTALL

The following screen is shown on the display:



### 5.3.1 DOS installation

- **Enter Installation Path**

Here, the path to the ELO TOUCH directory (default is C:\TOUCH) is specified. In case the indicated directory already exists the user is asked to confirm the overwriting of already existing data.

- **DIFFER Files**

This option allows to deactivate the differences to a possible previous installation. This can be sensible to remove the installation. However, here also 'Do Not Install DIFFER files' can be selected.

- **Select Touchscreen Controller**

Here, the serial controller must be selected. The other selection items affect other products of the ELO company.

- **Select Controller Model**

Here, the E271-2210 AccuTouch® model must be selected.

- **Select Serial Port Where the Controller is Connected**

Here, COM2 must be selected.

- **Select Baud Rate of the Controller**

Here, 9600 should be selected if no other reasons are against it.

After these inputs, the presence of the controller is tested. A corresponding message appears on the display. Then, the required files will be transferred to the hard disk. After that, the touch screen must be calibrated with GO. During the calibration, the user will be requested to touch the sensitive surface area in various graphic resolutions and at various places (the locations are marked with ½).

## Special drivers

---

### 5.3.2 WINDOWS 3.1 installation

- **Enter Installation Path**

Here, the path to the ELO-TOUCH directory (default is C:\TOUCH) is indicated. In case the indicated directory already exists the user is asked to confirm the overwriting of already existing data.

- **DIFFER Files**

This option allows to deactivate the differences to a possible previous installation. That can be sensible to remove the installation. However, here also 'Do Not Install DIFFER files' can be selected.

- **Select Touchscreen Controller**

Here, the serial controller must be selected. The other selection items affect other products of the ELO company.

- **Select Controller Modell**

Here, the E271-2210 AccuTouch® model must be selected.

- **Select Serial Port Where the Controller is Connected**

Here, COM2 must be selected.

- **Select Baud Rate of the Controller**

Here, 9600 should be selected if no other reasons are against it.

After these inputs, the presence of the controller is tested. A corresponding message appears on the display. Before the required files can be transferred to the hard disk, the installation program inquires:

- **Enter the directory for your local Microsoft Windows files**

Here, the path to the local Windows installation (default is C:\WINDOWS) must be specified.

Various inquiries are displayed to confirm overwriting during the copying of the files. The driver will not run properly if one of these inquiries is answered with NO. Then, the touch screen must be calibrated with GO. During the calibration, the user will be requested to touch the sensitive surface area in various graphic resolutions and at various places (the locations are marked with †).

With high color resolutions (> 256 colors) under Windows, the calibration can be possibly inaccurate. In this case, it has to be performed again with the valued offset.

## 6.1 Options

### 6.1.1 Expanding of the main memory

The main memory of the A1O486 is made up by 72-pin SIM modules. Modules with 4, 8 or 16 MB can be supplied. To install a SIMM interlock it as follows into the socket:

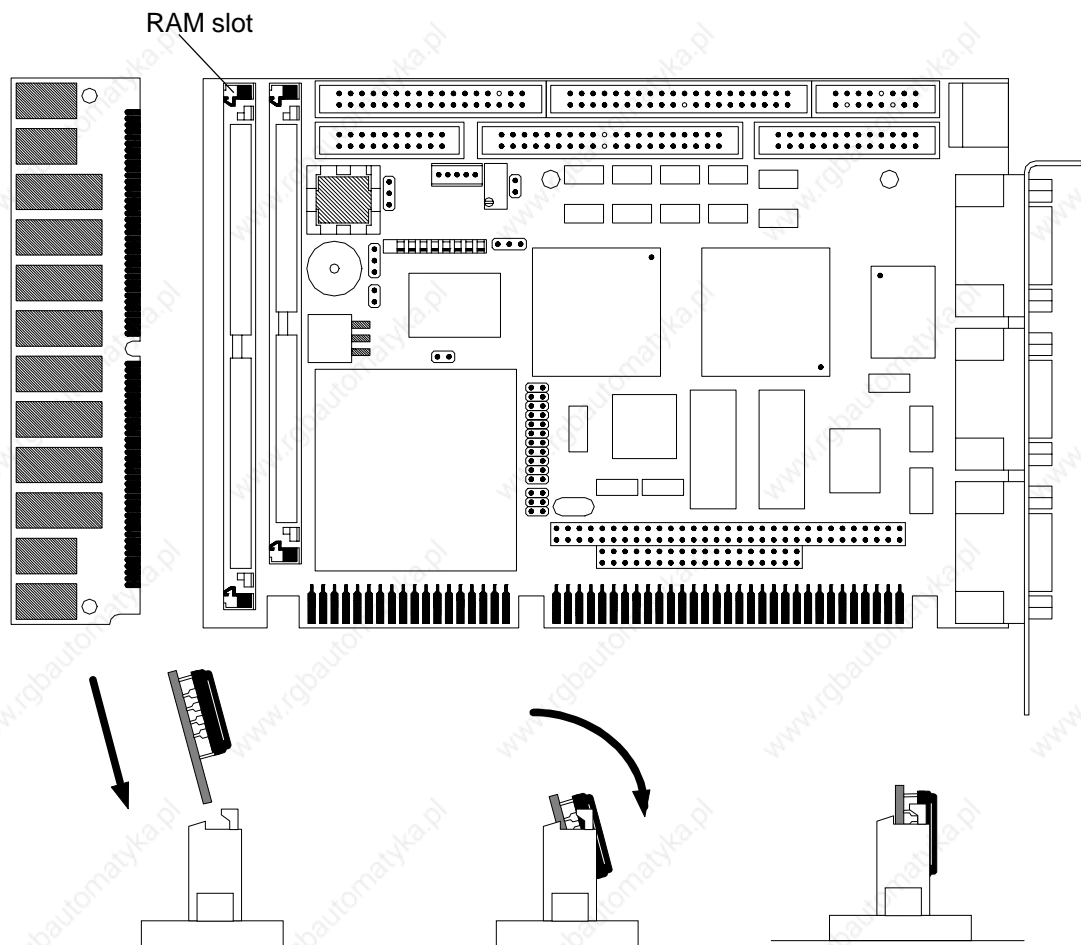

### 6.1.2 External monitor

Using an appropriate connector, an external monitor can be connected to the 15-pin Sub-D connector on the metal mounting bracket. For this, the switch position of the configuration DIP-switch is possibly to be checked. Furthermore, a driver suited for the application has possibly to be installed.

Anyhow, the operation of an external monitor in the VGA mode is also possible without drivers.

# Appendix

# 6

## 6.1.3 Flash disk/RAM disk

On request, we supply various combinations of memory types for the Silicon disk socket of the board.

Some common combination possibilities are listed below. Other combinations can be inquired.

2... 16MB Flash + 1. 4MB SRAM

2... 8MB Flash + 512K. 2MB EPROM

In contrast to a RAM disk in the main memory of the VPC, the content of the Silicon disk also remains preserved during a reset and at a voltage loss (a properly working system battery is assumed).

However, uncontrolled system crashes can damage the data content of the Silicon RAM disk.

The contents of the self contained Flash disk is independent from a battery. Besides, it is fewer subject to faults.

## 6.2 Connector assignments

All important interfaces of an AT-compatible PC are already available on the single-board computer. The following figure presents an overview about the location of the individual connectors, jumpers, and the configuration switches of the AI0486.

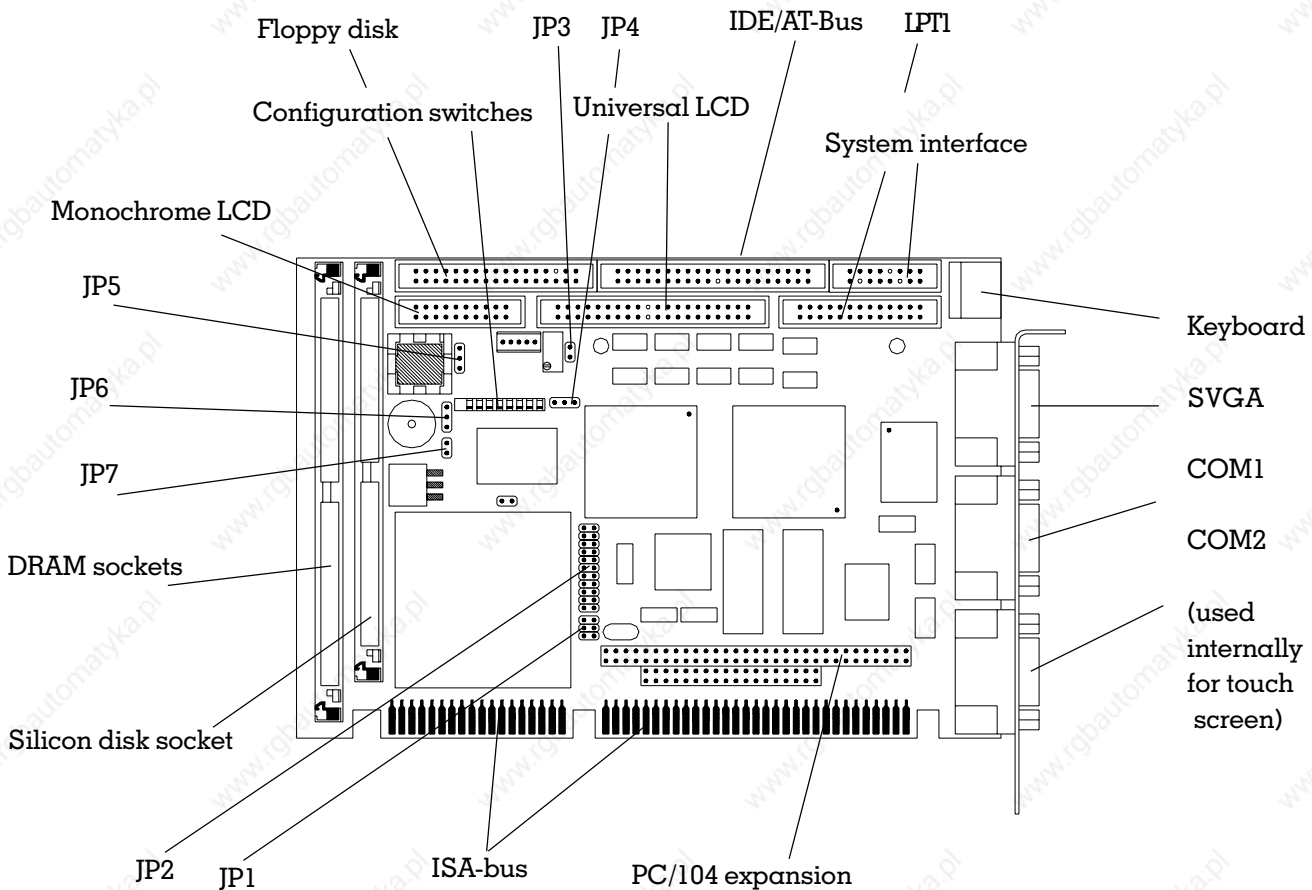

The individual interfaces of the board are described in the following

### 6.2.1 The ISA-bus

The ISA-bus is a multi-master bus with the following characteristics:

- 24-bit addresses for CPU, DMA and bus master
- 8-bit or 16-bit data multi-master ability
- 11 interrupt inputs, edge triggered
- 7 DMA channels (4 x 8-bit, 3 x 16-bit)
- wait state control
- refresh control

# Appendix

## 6.2.1.1 Pin assignments

The pin assignments of the ISA-bus can be taken from the following table. ISA-bus signals marked with the #-character are active low.

ISA-bus: soldering side

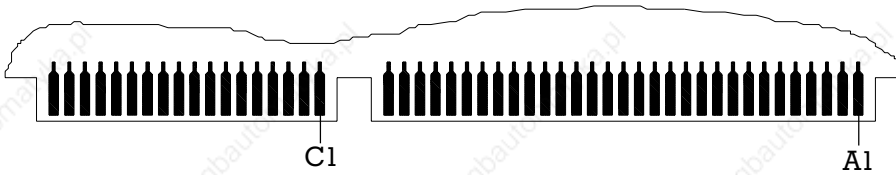

ISA-bus: assembly side

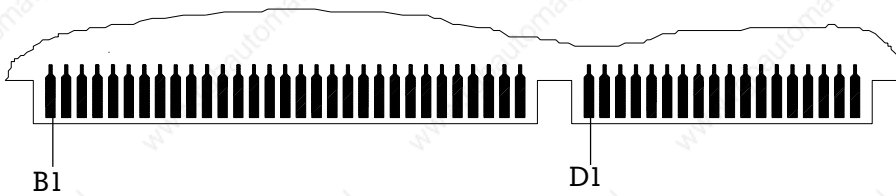

Table: Pin assignment of the ISA-bus

Pin	Signalname	Pin	Signalname	Pin	Signalname	Pin	Signalname
B1	GND	A1	IOCHK#	D1	MEMCS16#	C1	SBHE#
B2	RSTDRV	A2	SD7	D2	IOCS16#	C2	LA23
B3	+5V	A3	SD6	D3	IRQ10	C3	LA22
B4	IRQ9	A4	SD5	D4	IRQ11	C4	LA21
B5	-5V	A5	SD4	D5	IRQ12	C5	LA20
B6	DRQ2	A6	SD3	D6	IRQ15	C6	LA19
B7	-12V	A7	SD2	D7	IRQ14	C7	LA18
B8	WS0#	A8	SD1	D8	DACK0#	C8	LA17
B9	+12V	A9	SD0	D9	DRQ0	C9	MEMR#
B10	GND	A10	CHRDY	D10	DACK5#	C10	MEMW#
B11	SMEMW#	A11	AEN	D11	DRQ5	C11	SD8
B12	SMEMR#	A12	SA19	D12	DACK6#	C12	SD9
B13	IOW#	A13	SA18	D13	DRQ6	C13	SD10
B14	IOR#	A14	SA17	D14	DACK7#	C14	SD11
B15	DACK3#	A15	SA16	D15	DRQ7	C15	SD12
B16	DRQ3	A16	SA15	D16	+5V	C16	SD13
B17	DACK1#	A17	SA14	D17	MASTER#	C17	SD14
B18	DRQ1	A18	SA13	D18	GND	C18	SD15
B19	REFRESH#	A19	SA12				
B20	SYSCLK	A20	SA11				
B21	IRQ7	A21	SA10				
B22	IRQ6	A22	SA9				
B23	IRQ5	A23	SA8				
B24	IRQ4	A24	SA7				
B25	IRQ3	A25	SA6				
B26	DACK2#	A26	SA5				
B27	TC	A27	SA4				
B28	BALE	A28	SA3				
B29	+5V	A29	SA2				
B30	OSC	A30	SA1				
B31	GND	A31	SA0				



## 6.2.1.2 Signal description

The meaning and the particularities of the individual signals are described in the following section. Signal names marked with the #-character are active low.

### **SD0 to SD15**

These lines are used for the data interchange between CPU/DMA, memory and I/O. 8-bit boards must use SD0 to SD7. 16-bit boards must use SD0 to SD15. Two 8-bit accesses are automatically generated for one 16-bit processor access to one 8-bit board. Using a swap buffer, the higher significant data for a HIGH byte access are shifted to SD0 to SD7.

### **LA17 to LA23**

LA17 to LA23 represent the unlatched address bus. Along with the SA0 to SA19 lines of the ISA-bus, they are used to address a maximum of 16 MB of the memory area. The address lines must be latched using the BALE signal. They are generated by the CPU or a bus master as output signals. They must be generated by a bus master as input signals.

### **SA0 to SA19**

The SA0 to SA19 address lines are used by the ISA-bus to address memory and I/O devices. They are stable during the command phase and thus must not be latched. As output signals, they are generated by the CPU or by the DMA controller. As input signal, they must be generated by a bus master. During a refresh cycle (marked by the REFRESH# signal), the refresh address of dynamic memory is applied to the SA0 to SA9 lines.

### **SBHE#**

This active low signal indicates a data transfer on the SD8 to SD15 data lines. It is to be used only for 16-bit boards for the control of the data bus drivers and the write signals on the ISA-bus.

### **AEN**

This signal is used for the addressing of the I/O address range. AEN is a logical ANDing of the HOLDA and MASTERS# signals and indicates that a DMA controller or the refresh logic have taken over the control of the bus. It must always be procured for the address decoding in the I/O range of each expansion board.

### **SYSCLK**

With SYSCLK, a signal synchronous to the system clock is available on the ISA-bus. The frequency is 8.25 MHz with a duty rate of 1:1 (+5%).

### **BALE**

This signal is a logical ORing of the ALE and HOLDA signals. The addresses LA17 to LA23 are latched with this signal. It is not generated in the second cycle of a 16-bit access to an 8-bit board. Thus, it can basically not be evaluated as the start signal for the start of a cycle. During DMA or refresh cycles, the BALE signal is on high level through the logical ORing with HOLDA.

**SMEMR#, SMEMW#**

The SMEMR# signal indicates a reading cycle and the SMEMW# signal a write cycle of/to the ISA memory area within the first MB (address range 000000h to 0FFFFFFh). They are generated by the CPU or by DMA controllers. The SMEMR# signal is also generated by the refresh controller during a refresh. Herewith, the SA0 to SA9 address lines reflect the refresh address. SA10 to SA16 have a high impedance! SA17 to SA19 and LA17 to LA23 are held on low level by the PAGE REGISTER. Doing so, the REFRESH# signal indicates that this is refresh cycle and not a normal reading cycle.

**MEMR#, MEMW#**

The MEMR# signal indicates a reading cycle and the MEMW# signal a write cycle in the entire 16 MB ISA memory address range. As output signals, they are generated by the CPU or by DMA controllers. Concerning the refresh, the same applies for the MEMW# signal as for the SMEMR# signal. As input signal, they must be driven by a bus master.

**IOR#, IOW#**

The IOR# signal indicates a reading cycle and the IOW# signal a writing cycle for an I/O device if AEN is simultaneously active. As output signals, they are generated by the CPU or by DMA controllers. As input signals, they must be driven by a bus master. Since the I/O addresses are not completely decoded on the single-board CPU only a limited I/O address range from 000h to 3FFh is available for expansion boards, i.e. the SA10 to SA15 address lines do not have to be decoded for I/O devices.

**CHRDY**

This asynchronous signal is used for the extension of the access times set as default on the single-board CPU for memory or port accesses. Slow boards generate this signal from the board address and the read and/or write signal. The processor, DMA controller or the refresh controller executes wait states as long as this signal is on low level (NOTREADY). This signal should be used only if an access time of 500 ns is insufficient for 8-bit ISA board. The same applies to an access time of 220 ns for 16-bit ISA boards. It may not be hold longer than 2.1  $\mu$ s by ISA slave modules since the otherwise missing refreshes result in a loss of data.

**WS0#**

The synchronous WS0# ready signal communicates to the bus control logic that the addressed peripheral on the expansion interface requires no wait states. To observe the setup and hold times, this signal must be combined with processor-synchronous signals as IOR#, IOW#, SMEMR#, SMEMW#, MEMR#, MEMW# and SYSClk. The WS0# signal must be generated from the address combined with the READ or WRITE signal to execute a memory cycle of a 16-bit expansion board without wait states (access time 100 ns) being applied.

Must be activated one system clock later than the READ or WRITE-SIGNAL (combined with the address decoding) if a bus cycle should be executed for an 8-bit transfer with at least 2 wait states. This signal must be generated by an open collector or tristate output.

## **MEMCS16#**

The MEMCS16# active low signal indicates that the data transfer is a 16-bit memory access. It must be generated by 16-bit memory boards from the LA17 to LA23 address lines. A wait state is destined for these memory cycles with an access time of 220 ns. Additional wait states are to be inserted via the CHRDY signal if this is insufficient. This signal must be generated by an open collector or tristate output.

## **IOCS16#**

This active low signal indicates that the data transfer is a 16-bit I/O access. It must be generated by 16-bit I/O modules from the SA1-SA15 address lines. A wait state is destined for these I/O cycles with an access time of 220 ns. Additional wait states are to be inserted via the CHRDY signal if this is insufficient. This signal must be generated by an open collector or tristate output.

## **DRQ0 to DRQ3, DRQ5 to DRQ7**

Using the asynchronous DMA request signals, an expansion board can request an I/O memory or memory I/O data transfer. It can request the bus as an ISA master board. DRQ0 has the highest priority. The request is generated by the HIGH level of the DRQ signal and must last until it is confirmed by the DMA controller by asserting the corresponding DACK# signals. Only byte (8 bit) transfers can be requested via the DRQ0 to DRQ3 signals. The DRQ5 to DRQ7 signals can only request word (16 bit) transfers to even addresses (SBHE = 0, A0 = 0). An expansion board can also become the bus master by issuing a DMA request if the DMA channel is programmed for the so called cascade mode and the board generates the MASTERS# signal after receiving the DACK# signal.

## **DACK0# to DACK3#, DACK5# to DACK7#**

The DACK# signals generated by the DMA controller are an acknowledgment of the DMA request. They signal that the solicited DMA transfer can occur. On the expansion board, they are used as I/O select signal for the data register to be served. An expansion board that wants to become the ISA bus master generates the MASTERS# signal after receiving the DACK# signal.

## **TCS**

Depending on the mode, the DMA controller has been programmed for this signal is bi-directionally. The TC signal indicates that a DMA transfer is terminated in the output mode. In the input mode, a DMA slave can interrupt a DMA transfer via this signal.

**MASTER#**

Together with a DRQn DACKn# line pair, this signal is used by an expansion board to become the bus master. The DMA channel must be programmed for the cascade mode.

The expansion board pulls the MASTERS# signal to low after receiving the DACK# signal. One system clock later (125 ns) it can assert the address and data bus. One system clock later again it asserts the read and write lines.

If a bus master wants to use the bus for longer than 10  $\mu$ s then it must perform a memory refresh in intervals of 15  $\mu$ s. Otherwise, data in main memory could be lost. The MASTERS# signal must be generated by an open collector or tristate output.

**REFRESH#**

The REFRESH# signal indicates a memory refresh cycle. It is generated by the refresh control as output signal. As input signal, it must be generated by a bus master (open collector or tristate output) in intervals of 15  $\mu$ s if it wants to use the bus for longer than 10  $\mu$ s. During a refresh, the refresh address is applied to the SA0 to SA15 address lines.

**OSC**

This signal is a 14.31818 MHz clock signal that is used for example for the generation of the color signals of CRT controllers. It can also be used as a timer clock. It is asynchronous to the system clock and has a duty rate of 1: 1.

**RSTDRV**

This signal is used for resetting the control logic of ISA expansion boards. RSTDRV is asserted by the reset controller after powering-up of the computer and after a bus time-out.

**IRQ3 to IRQ7, IRQ9 to IRQ 12, IRQ 14, IRQ 15**

The interrupt signals are used for interrupting the processed program in regular intervals by the processor and signal that an I/O board is being served. They have the following descending priorities: 9, 10, 11, 12, 14, 15, 3, 4, 5, 6, 7. A CPU interrupt is initiated either by an edge or by a level. The interrupt signal must last until the processor has executed the relevant INTA cycles. Since this cannot be recognized on the bus (no INTACK line) an interrupt hold flip-flop must be available for each interrupt signal. This flip-flop must be reset in the interrupt service routine by an I/O command (the I/O command acknowledges the interrupt).

**IOCHK#**

Using this signal, an expansion board can signal the processor a fault (e. g. a parity error) if IOCHK# was previously released by writing to bit 3 of port address 61h. In this case, a NMI can be generated if this is released via bit 7 (= 0) of I/O address 70h.

# Appendix

## 6.2.2 PC/104 expansion slot

The single-board computer features one expansion slot conforming to the PC/104 standard. The same signals are available on the expansion connector as on the ISA-bus. The pin assignment of this PC/104 expansion connector can be taken from table 23.

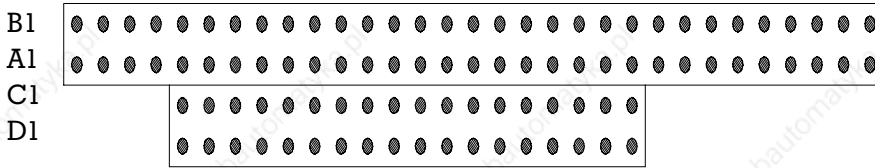

PC/104 expansion slot

The table shows the pin assignment of this PC/104 expansion connector. You find the description of the individual signals in the section of the ISA-bus description. Signal names marked with the #-character are active low.

Pin assignment of the PC/104 expansion connector

Pin	Signalname	Pin	Signalname	Pin	Signalname	Pin	Signalname
B1	GND	A1	IOCHK#	C0	GND	D0	GND
B2	RSTDRV	A2	D7	C1	SBHE#	D1	MEMCS16#
B3	VCC	A3	D6	C2	LA23	D2	IOCS16#
B4	IRQ9	A4	D5	C3	LA22	D3	IRQ10
B5	-5V	A5	D4	C4	LA21	D4	IRQ11
B6	DRQ2	A6	D3	C5	LA20	D5	IRQ12
B7	-12V	A7	D2	C6	LA19	D6	IRQ15
B8	WSO#	A8	D1	C7	LA18	D7	IRQ14
B9	+12V	A9	D0	C8	LA17	D8	DACK0#
B10	GND	A10	CHRDY	C9	MEMR#	D9	DRQ0
B11	SMEMW#	A11	AEN	C10	MEMW#	D10	DACK5#
B12	SMEMR#	A12	SA19	C11	D8	D11	DRQ5
B13	IOW#	A13	SA18	C12	D9	D12	DACK6#
B14	IOR#	A14	SA17	C13	D10	D13	DRQ6
B15	DACK3#	A15	SA16	C14	D11	D14	DACK7#
B16	DRQ3	A16	SA15	C15	D12	D15	DRQ7
B17	DACK1#	A17	SA14	C16	D13	D16	VCC
B18	DRQ1	A18	SA13	C17	D14	D17	MASTER#
B19	REFRESH#	A19	SA12	C18	D15	D18	GND
B20	SYSCLK	A20	SA11	C19	N. C.	D19	GND
B21	IRQ7	A21	SA10				
B22	IRQ6	A22	SA9				
B23	IRQ5	A23	SA8				
B24	IRQ4	A24	SA7				
B25	IRQ3	A25	SA6				
B26	DACK2#	A26	SA5				
B27	TC	A27	SA4				
B28	BALE	A28	SA3				
B29	VCC	A29	SA2				
B30	OSC	A30	SA1				
B31	GND	A31	SA0				
B32	GND	A32	GND				

# Appendix

# 6

## 6.2.3 DRAM socket

The DRAM memory interface is realized by using a 72-pin SIMM socket. Signals of the DRAM socket marked with the #-character are active low.

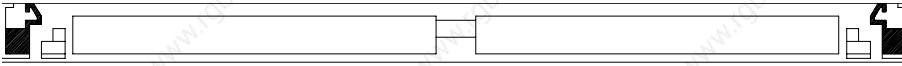

DRAM socket

### Pin assignment of the DRAM socket

Pin	Signalname	Pin	Signalname	Pin	Signalname	Pin	Signalname
1	GND	19	N. C.	37	DQ17	55	DQ12
2	DQ00	20	DQ4	38	DQ35	56	DQ30
3	DQ18	21	DQ22	39	GND	57	DQ13
4	DQ1	22	DQ5	40	CAS0#	58	DQ31
5	DQ19	23	DQ23	41	CAS2#	59	VCC
6	DQ2	24	DQ6	42	CAS3#	60	DQ32
7	DQ20	25	DQ24	43	CAS1#	61	DQ14
8	DQ3	26	DQ7	44	RAS0#	62	DQ33
9	DQ21	27	DQ25	45	RAS1#	63	DQ15
10	VCC	28	A7	46	N. C.	64	DQ34
11	N. C.	29	N. C.	47	W#	65	DQ16
12	A0	30	VCC	48	N. C.	66	N. C.
13	A1	31	A8	49	DQ9	67	PD1
14	A2	32	N. C.	50	DQ27	68	PD2
15	A3	33	RAS3#	51	DQ10	69	PD3
16	A4	34	RAS2#	52	DQ28	70	PD4
17	A5	35	DQ26	53	DQ11	71	N. C.
18	A6	36	DQ8	54	DQ29	72	GND

### 6.2.4 Silicon disk socket

The SRAM, Flash or EPROM memory interface is realized as a 64-pin SIMM socket. Signals of the Silicon disk marked with the #-character are active low.

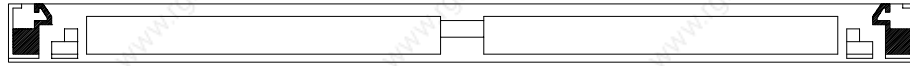

Silicon disk socket

#### Pin assignment of the Silicon disk socket

Pin	Signalname	Pin	Signalname	Pin	Signalname	Pin	Signalname
1	GND	17	D15	33	SA2	49	MEMR#
2	D0	18	VCC	34	SA3	50	MEMW#
3	D1	19	PA0	35	SA4	51	BATT-ON
4	D2	20	PA1	36	SA5	52	VCC-Bat
5	D3	21	PA2	37	SA6	53	V <sub>pp</sub>
6	D4	22	PA3	38	SA7	54	SA14
7	D5	23	PA4	39	SA8	55	SA15
8	D6	24	PA5	40	SA9	56	SA16
9	D7	25	PA6	41	SA10	57	LA17
10	D8	26	PA7	42	SA11	58	LA18
11	D9	27	PA8	43	SA12	59	LA19
12	D10	28	PA9	44	SA13	60	LA20
13	D11	29	PA10	45	VCC	61	LA21
14	D12	30	GND	46	SHBE#	62	LA22
15	D13	31	SA0	47	FLASHCS#	63	LA23
16	D14	32	SA1	48	SRAMCS#	64	GND



## 6.2.5 Keyboard interface

The communication between the keyboard controller and the keyboard is made via a PS/2™-compatible 6-pin female connector that is found above the rear side cover of the board (see figure 30). Alternatively, a keyboard connector can also be connected via a the 16-pin system interface. Voltage is supplied to the keyboard via the keyboard connector. The current requirement of the keyboard should not total more than 500 mA.

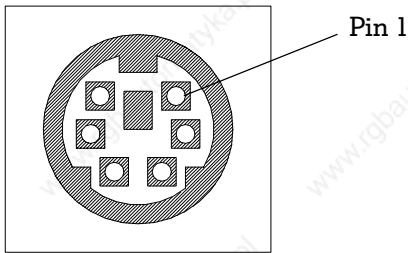

Keyboard interface

Keyboard interface

Pin	Signalname	Pin	Signalname	Pin	Signalname
1	Keyboard clock	3	Keyboard data	5	VCC
2	GND (common)	4	n.c.	6	n.c.

## 6.2.6 System interface

Using the 16-pin system interface, an additional keyboard connector can be connected. Interfacing a PS/2™ mouse, an external loudspeaker (to VCC), a hard disk LED (to VCC), a power LED (to GND), a keyswitch (to GND), and a reset push-button (to GND) is also possible. Please refer to the following table for the pin assignment of the connector.

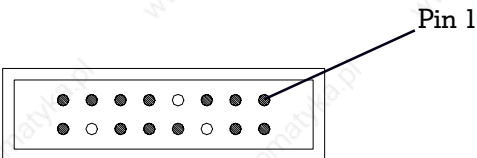

System interface (front view)

### System interface

Pin	Signal name	Pin	Signal name	Pin	Signal name
1	Keyboard clock	7	n.c.	12	External loudspeaker
2	Mouse clock	8	GND (common)	13	Keypad
3	Keyboard data	9	Hard disk LED	n.c.	
4	Mouse data	10	VCC	15	GND (common)
5	VCC (protected)	11	Power - LED	16	Reset push-button
6	n.c.				

### 5.2.7 Floppy disk interface

This connector is a coded double row 34-pin male header for the connection of two 3 1/2 or 5 1/4 inch floppy disk drives by means of a 34-wire flatband cable. The odd pins connect the shield wires to GND. Pin 5 is coded. Signals of the floppy disk interface marked with the #-character are active low.

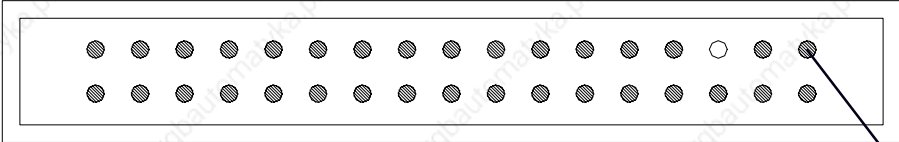

Floppy disk interface

Pin 1

Floppy disk interface

Pin	Signalname	Pin	Signalname
1	GND (common)	2	HDS#
3	GND	4	N. C.
5	code	6	N. C.
7	GND	8	INDEX#
9	GND	10	MO1#
11	GND	12	DS2#
13	GND	4	DS1#
15	GND	16	MO2#
17	GND	18	DIRC#
19	GND	20	STEP#
21	GND	22	WD#
23	GND	24	WE#
25	GND	26	TRK0#
27	GND	28	WP#
29	GND	30	RDD#
31	GND	32	HS#
33	GND	34	DISKCHG#

## 6.2.8 IDE/AT-bus hard disk interface

This connector is a coded double row 40-pin male header for the connection of two IDE/AT hard disk drives by means of a 40-wire flatband cable. Pin 20 is coded. Signal names marked with the #-character are active low.

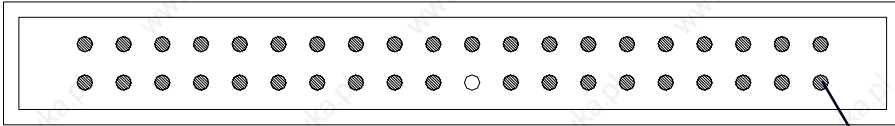

IDE-/AT-Bus

Pin 1

IDE-AT/Bus

Pin	Signalname	Pin	Signalname
1	RESET#	21	N. C.
2	GND (common)	22	GND (common)
3	D7	23	IOW#
4	D8	24	GND (common)
5	D6	25	IOR#
6	D9	26	GND (common)
7	D5	27	(n.c.), IOCHRDY
8	D10	28	BALE
9	D4	29	N. C.
10	D11	30	GND (common)
11	D3	31	IDINIT
12	D12	32	IOCS16
13	D2	33	SA1
14	D13	34	(n.c.), MEMCS16#
15	D1	35	SA0
16	D14	36	SA2
17	D0	37	CS#
18	D15	38	HCS1#
19	GND (common)	39	HDLED
20	code	40	n.c.

## 6.2.9 Parallel interface (Centronics)

The parallel interface (LPT1) is a double row 26-pin male header. Using this connector a 25-pin female connector can be connected. Thus, an AT-compatible (bi-directional) parallel interface is available. Signals of the parallel interface marked with the #-character are active low.

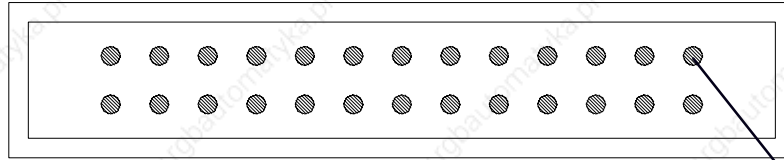

Printer port LPT1

Pin 1

Printer port LPT1

Pin	Signalname	Pin	Signalname
1	STB#, Strobe	2	AFD#, Auto Feed
3	PD0	4	ERROR#
5	PD1	6	INIT#
7	PD2	8	SLIN#, Select In
9	PD3	10	GND (common)
11	PD4	12	GND
13	PD5	14	GND
15	PD6	16	GND
17	PD7	18	GND
19	ACK#, Acknowledge	20	GND
21	Busy	22	GND
23	PE, Paper End	26	GND
25	SLCT, Select	26	VCC

### 6.2.10 Power connector

A single row 5-pin female terminal strip for the 5 volts and 12 volts supply voltages are available on the board. Please refer to the following figure for the location and polarity of the power connector.

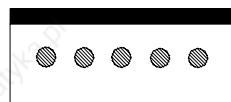

Power connector

Power connector

Pin	Signalname
1	5 volts
2	GND (common)
3	12 volts
4	GND (common)
5	5 volts

# Appendix

## 6.2.11 Monochrome LCD connector

The monochrome LCD connection is a 20-pin double row male header for the connection of a monochrome LC-display.

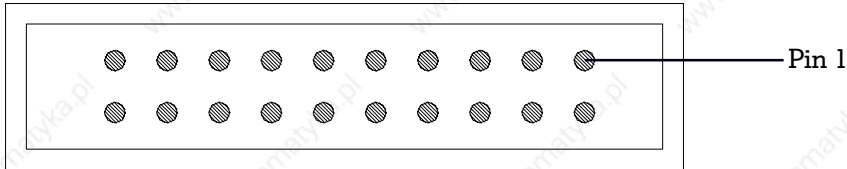

### Monochrome LCD connection

Pin	Signalname	Pin	Signalname
1	Frame-Puls	2	Line Puls
3	5 volts (protected)	4	Panel-OFF JP4 for the polarity
5	negative contrast voltage	6	GND (common)
7	Upper-Data 1	8	Upper-Data 1
9	Upper-Data 1	10	Upper-Data 1
11	Lower-Data 1	12	Lower-Data 1
13	Lower-Data 3	14	Lower-Data 1
15	n.c.	16	n.c.
17	GND (common)	18	12 volts (protected)
19		20	GND (common)

### 6.2.12 Universal LCD connector

The Universal LCD connector is a coded double row 40-pin male header for the connection of a monochrome or color LC-display. Universal LCD signals marked with the #-character are active low.

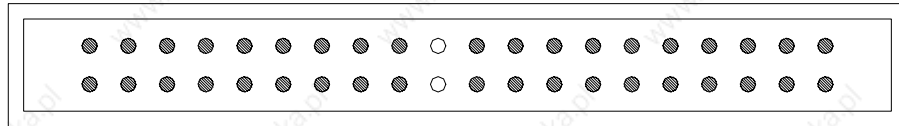

Universal LCD connector

Universal LCD connector.

Pin	Signalname	Pin	Signalname
1	Clock	2	GND
3	RGB-Data 12	4	RGB-Data 13
5	RGB-Data 14	6	GND
7	RGB-Data 6	8	RGB-Data 7
9	RGB-Data 8	10	GND
11	RGB-Data 0	12	RGB-Data 1
13	RGB-Data 2	14	GND
15	Line Puls, Hsync	16	GND
17	Frame pulse, VSync	18	5 volts (protected)
19	GND	20	12 volts switched (protected)
21	n.c. (codes)	22	n.c. (codes)
31	RGB data 17	32	Pixel clock of the RAMDAC
33	Negative contrast voltage	34	Frame rate, blank#
35	Positive contrast voltage	36	12 volts (protected)
37	LCD enables	38	Panel OFF (refer to JP4 for the polarity)
39	GND (common)	40	5 volts (protected)

### 6.2.13 SVGA monitor connector

Using the 15-pin 3-row connector (one additional row compared to a serial interface) a SVGA monitor can be connected to the single-board computer. The SVGA monitor connector is attached to the metal mounting bracket of the board

# Appendix

SVGA monitor connector

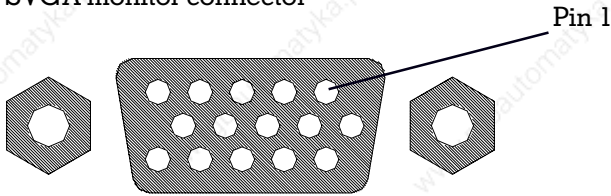

SVGA monitor connector

Pin	Signalname	Pin	Signalname
1	red video signal	9	n.c. (coded)
2	green video signal	10	Synchronization common
3	blue video signal	11	Screen ID bit 0
4	Screen ID bit 2	12	Screen ID bit 1
5	GND (common)	13	Horizontal synchronization
6	red common	14	Vertical synchronization
7	green common	15	Screen ID bit 3
8	blue common		

## 6.2.14 Serial interfaces

Two serial RS-232C interfaces are available on the board. Both interfaces (COM1 and COM2) are AT-compatible. COM1 is housed in a 9-pin connector on the metal mounting bracket of the board. COM2 is used internally for connecting the touch screen.

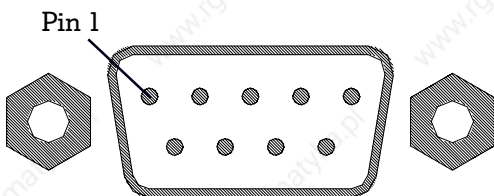

Serial interfaces

Serial interfaces

Pin	Signalname	Pin	Signalname
1	DCD, Data Carrier Detect	6	DSR, Data Set Ready
2	RxD, Receive Data	7	RTS, Ready to Send
3	TxD, Transmit Data	8	CTS, Clear to Send
4	DTR, Data Terminal Ready	9	RI, Ring Indicator
5	GND (common)		

### 6.3 POST codes (Power-On Self-Test)

The ISA computer performs this test automatically after a hardware or software reset and initializes the hardware components. This test is the so-called POST (Power-On Self-Test).

Only after a hardware reset, the computer displays the components that are tested and initialized. A corresponding message is output on the screen if faults appear during these tests. The reason could be a (real) hardware error (e. g. a defective component) or a wrong configuration of the computer based on the setup program (e.g.: two floppy drives are specified but only one is available).

#### 6.3.1 POST signal tone

Long tone, short tone, short tone. With this tone sequence the BIOS signals that the primary screen adapter was not found. No outputs can be made to the monitor.

#### 6.3.2 POST messages

##### **PRESS ESC TO SKIP MEMORY TESTS**

This message is output by the BIOS if the memory above by 1 MB is tested. The test can be lengthy in time since several megabytes of memory can be available. The user has the possibility to interrupt this test prematurely by pressing the space or ESC key.

##### **PRESS F1 TO CONTINUE OR CTRL-ALT-ESC TO ENTER SET UP**

You can continue to boot the computer by pressing the F1 key during the execution of the POST if a fault has appeared that did not cause the POST to abort. Alternatively, you can access the setup menu built into the BIOS by pressing of the key combination CTRL-ALT-ESC.

##### **PRESS DEL TO ENTER SET UP**

If this message appears on the screen you can select the setup menu built into the BIOS by pressing of the DEL key.

#### 6.3.3 POST fault messages

One or also several of the subsequently listed messages can be displayed by the BIOS on the screen if faults have been found during the POST.

##### **CMOS BATTERY HAS FAILED**

The on-board available or externally connected battery powering the CMOS RAM has caused a fault. Either the battery is not connected correctly anymore or it is empty. It must be replaced by a new battery if it is empty.

##### **CMOS CHECKSUM ERROR**

The battery-buffered CMOS RAM has caused a checksum fault. This fault can be caused either by the software (CMOS RAM was specified without recalculating the checksum) or by the hardware (the battery voltage supply was interrupted).



## **DISK BOOT FAILURE; INSERT SYSTEM DISK AND PRESS ENTER**

Insert a system floppy disk in the floppy drive and press subsequently the ENTER key. Check whether the cable set of the hard disk is still seated correctly if the computer would have booted from a hard disk. Also make sure that the sequence of system loading drives is correctly set in the setup and the hard disk was formatted and configured as boot drive.

## **FLOPPY DISK DRIVES OR TYPE MISMATCH ERROR - RUN SETUP**

The BIOS has ascertained that the number or the types of the floppy disk drives do not correspond to the set values in the setup. Select the setup menu and correct the corresponding values.

## **DISPLAY SWITCH IS SET INCORRECTLY**

The switch for the primary screen type can be either be set to monochrome or to color. This error message points out that this switch is set differently compared to the specification in the set up menu. Check which setting is correct and correct the corresponding entry in the setup or reposition the switch on the board.

## **DISPLAY TYPE HAS CHANGED SINCE LAST BOOT**

The previous screen adapter was exchanged against a new one. The computer must be re-configured (switch for the primary screen type and setting in the setup program).

## **ERROR ENCOUNTERED INITIALIZING HARD DRIVE**

The BIOS could not correctly address and initialize a hard disk drive. Check whether the hard disk is correctly connected via the cable set to the controller or to the power supply. Also make sure that the type of the disk is correctly entered in the setup menu.

## **ERROR INITIALIZING HARD DISK CONTROLLER**

The BIOS could not correctly initialize the hard disk controller. Check whether the hard disk is correctly connected to the controller via the cable set and the internal hard disk interface of the board is activated in the setup menu.

## **FLOPPY DISK CNTRLR ERROR OR NO CNTRLR PRESENT**

The BIOS could not correctly address and initialize a floppy disk drive. Ensure that the drive is correctly connected to the controller via the cable set and that the drive is supplied with power. Also make sure that the type of the floppy disk drive is correctly entered in the setup menu. NONE must be entered in the setup menu as drive specification if no floppy disk drive is connected to the computer.



## KEYBOARD ERROR OR NO KEYBOARD PRESENT

The keyboard connected to the computer could not be initialized. Check whether the keyboard is correctly connected. This message can also be caused by pressing key during the boot process or a by a sticking key.

In case a computer should be operated without keyboard (e. g. as file server) it must be specified in the setup menu that the boot process is not stopped due to keyboard faults.

## MEMORY ADDRESS ERROR AT xxx

The BIOS has ascertained a fault at the indicated memory address. This means that the corresponding internal or external memory module is defective. Then, it should be replaced.

## MEMORY PARITY ERROR AT xxx

The BIOS has ascertained a parity fault at the indicated memory address. The corresponding internal or external memory module should be replaced.

## MEMORY SIZE HAS CHANGED SINCE LAST BOOT

The DRAM memory size of the computer was changed after the last boot process of the system by exchanging or completing the memory modules.

## MEMORY VERIFY ERROR AT xxx

The BIOS has ascertained a fault at the indicated memory address. The corresponding memory module should be replaced.

## OFFENDING ADDRESS NOT FOUND

This message appears only together with an I/O channel check or RAM parity error. It means that the segment in which this fault appeared could not be determined.

## OFFENDING SEGMENT: xxx

This message appears only together with an I/O channel check or RAM parity error. It indicates the segment in which this faults has appeared.

## PRESS A KEY TO REBOOT

This message is displayed at the lower screen border if a fault has appeared which requires the computer to be booted up again.

## PRESS F1 TO DISABLES NMI; F2 TO REBOOT

This message is displayed if the BIOS ascertains the appearing of a non-maskable interrupt (NMI) during the POST. You can continue the boot process with a deactivated NMI or reboot the system.

## RAM PARITY ERROR xxx CHECKING FOR SEGMENT xxx

The BIOS has ascertained a parity error in the indicated memory segment. The corresponding memory module should be replaced.

## SYSTEM HALTED; (CTRL-ALT-DEL) TO REBOOT...

The boot process of the computer was interrupted since the BIOS has ascertained a fault during the POST. You can cause a software reset of the computer by pressing the CTRL-ALT-DEL key combination.

### 6.3.4 POST codes

Each test performed by the BIOS outputs an associated value to I/O port 80h during the POST. After a re-start and during the POST, the BIOS outputs the value of the routine to be processed next. The system is stopped if a routine can not be successfully processed. The last POST code is output if it is a significant fault.

A listing of the POST codes is found in the subsequent table:

Value	Tests	Description
01	1. Processor test	CPU flag test
02	2. Processor test	CPU register test
03	Chip initialization	Timer, DMA, and interrupts controllers initialization
04	Refresh toggle test	Port 61h bit 4 testing
05	Keyboard	Keyboard controller initialization
06	(reserved)	
07	CMOS interface	CMOS accesses and battery test
08	Test the first 64K the memory	Early chipset initializing Memory configuration (code C1) Chipset initialization (code BE) Early Shadow (code C5) Cache test (code C6) Test and erasing of the lower 64 KB of memory
09	Early cache	Cyrix CPU init initialization Cache initialization
0A	Interrupts vectors	Loading of the interrupt vector table
0B	CMOS checksum	Loading of the CMOS default values if checksum yields a fault or the INS key was pressed
0C	Keyboard initializing	

OD	Video initialization	Recognize CPU clock frequency Recognize and initialize video adapter; Post signal tone if no adapter found
OE	Video memory test	Set up screen for POST messages arrange shadow corresponding to the setup setting
OF	1. DMA test	Test BIOS checksum Test DMA controller 0
10	2. DMA test	Test DMA controllers 1
11	3. DMA tests	Test DMA Page registers
12-13	(reserved)	
14	Timer test	Test timer/counter
15	1. interrupts test	Interrupt controller 1 mask bit
16	2. Interrupts test	Interrupt controller 2 mask bit
17	3. interrupts test	Stuck interrupts bits
18	4. Interrupts test	Interrupts controllers and timer functionality test (forcing of an interrupt by using one of the timers)
19	Stuck NMI bites	Test NMI bits of port 61h. Reset NMI if OK.
1A	Clock	Indicate CPU clock
1B-1E	(reserved)	
1F	(reserved)	
20	(reserved)	
21-2F	(reserved)	
30	Determine memory size	Determine memory size and write result to the CMOS
31	Base and Extended	At a cold start, the memory is tested for memory writing by storing four different patterns if Quick Power-ON self-Test in the setup is set to disabled. Otherwise the test is performed by writing only one pattern (set to enabled). The memory test can be interrupted by pressing the ESC key.
32	(reserved)	
33-3B	(reserved)	

# Appendix

# 6

3C	Setup enabled	Enable jump into the setup menu and display of the PRESS DEL TO ENTER SETUP message
3D	Mouse initialization	OEM: Examine and initializing the PS/2 mouse
3E	Set up cache	Caching is turned on if enabled in the setup
3F	(reserved)	
BF	Chipset initialization	Load default values into the chipset
40	Virus warning	Display whether virus warning is active or not
41	Floppy disk	Initialize floppy disk controller and drives
42	Hard disks	Initialize hard disk controller and hard disks
43	Peripheral port	Recognize and initialize serial interface(s), parallel interface(s), and game port
44	(reserved)	
45	Co-processor	Recognize and initialize the co-processor
46-4D	(reserved)	
4E	Error messages	Re-start if manufacturing POST loop bit is not set to low (keyboard controller P15). Display found significant faults and continue otherwise
4F	Safety checking	Password scan if function has been activated in the setup
50	CMOS write	Write the copy of the CMOS back from RAM erase screen
51	Pre-boot enable	Enable parity, NMI and cache
52	Scan ROMs	Recognize and initialize option ROM in the range of C8000...EFFFF (if the scan option has been activated in the setup for the area up to F7FFF)
53	Setup 40: area	Time value in 40: initialize area
54-5F	(reserved)	

60	Virus protection	Configure virus protection corresponding to the setup
61	BOOT	Set speed
62	Set keyboard	Set NumLock status and repetition rate
63	Load attempt	Load corresponding to the setup of drive C:/A: or A:/C
FF	Boot	
B=	Wrong interrupt	Wrong interrupt appeared in protected mode
B1	NMI	Unexpected NMI appeared
E1-EF	Setup menu active	Code E1 for page 1 of the setup, E2 for page 2, etc.

#### 6.4 Documentation reference

MicroDesign All-In-One AIO486 operating manual

Samsung UG-64I011-A Technical Handbook

Sanyo LM-CG53-22NTK Technical Handbook

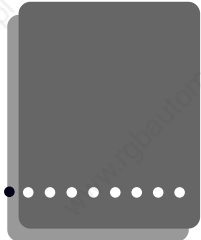

# Index

## A

Accu Touch .....	42
Address lines .....	49
Ambient temperature .....	6

## B

Battery .....	19
BIOS .....	22, 64
Boot process .....	66

## C

Cache .....	7
Calibration .....	43
Centronics .....	59
Checksum .....	65
Chemical resistance .....	6
Circulating air clearance .....	8
Clock .....	17
Codes .....	67
Cold-cathode tube .....	12
Color LC-display .....	62
Colors .....	40
COM1 .....	31, 63
COM2 .....	31
COM3 .....	31
COM4 .....	31
Configuration switch .....	46
Connectors .....	46
Contrast controls .....	18
Contrast voltage .....	18, 32
CPU board .....	7
Current saving modes .....	33
Current .....	6
Cursor .....	40

## D

Dimensions .....	7
Display .....	7
DRAM socket .....	55

## E

Earth potential .....	10
EMC .....	6
Error messages .....	65
Expansion slot board .....	11
External monitor .....	44

## F

FDC parameters .....	31
Fire resistance .....	6
Filter .....	9
Floppy disk drive .....	26, 66
Font size .....	40
Front .....	5

## G

Gasket .....	8
--------------	---

## H

Hard disk .....	65
Hard disk LED .....	57
Hard disk parameters .....	24
Hard disk types .....	25
Humidity .....	6

## I

IDE/AT-Bus .....	59
Image repetition frequency .....	39
Interface .....	7, 46, 59, 62
Interference clearance .....	8
Interference levels .....	9
ISA .....	46

## J

Jumper .....	17, 46
--------------	--------

## K

Key repetitions .....	28
Keyboard .....	22, 57, 66
Keypad .....	57

## L

LCD contrast parameters .....	32
Loudspeaker .....	20, 57
LPT port parameters .....	32
LPT1 .....	32, 59
LPT2 .....	32
LPT3 .....	32

## M

Memory module .....	66
Memory size .....	26
Message .....	64
Monitor .....	5
Monochrome LCD .....	61

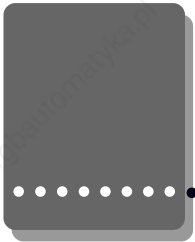

P

Parallel interface .....	32, 59
Parity error .....	66
Parity control .....	28
Password protection .....	27
POST .....	67
Power LED .....	57
Power-ON Self-Test .....	64
Power Management .....	33
Power supply .....	10
Printer port .....	60
Protection type .....	6
PS/2 mouse .....	32

R

RAM .....	7
Rear cover .....	12
Reset push-button .....	57
RS-232C .....	63

S

Screen .....	9
Screen connection .....	63
Screen type .....	65
Serial interface .....	31, 63
Serial port1 parameters .....	31
Serial port2 parameters .....	31
Setup .....	22
Shadow .....	29
Shadow parameters .....	29
Signal tone .....	64
Signals .....	49, 52
Silicon disk .....	45, 56
SIM module .....	44
SVGA monitor connection .....	63
System interface .....	57

T

Temperature .....	6
Temperature variation .....	6
Touch protection .....	7, 41
Touch screen .....	7, 41
Touch screen controller .....	42

V

Video .....	26, 30
Video adapters .....	26
Virus .....	7
Voltage .....	6