



Berger Lahr positioning drives

Berger Lahr positioning drives

General information

The selection of positioning drives was previously limited to either a servomotor drive or a stepping-motor drive. Both of these distinct drive technologies have been combined in the Twin Line product family, enabling you to match the advantages of each system to your particular application.

Three different motor series are available for the Twin Line positioning drives:

3-phase stepping motors

Exceptionally robust, maintenance-free drives. They execute precise, step-by-step movements specified by a positioning controller.

The 3-phase stepping motors can be operated in conjunction with Twin Line power electronics (Power range from 350 W to 750 W) at resolutions from 200 to 1000 steps per revolution or, in micro-step mode, from 2000 to 10000 steps per revolution.

Options such as rotation monitoring, holding brake and rugged, low-backlash planetary gears expand the application possibilities.

AC synchronous servomotors - standard

Provide a very high power intensity, enabling highly dynamic positioning drives offering exceptional performance at a low price.

Power range from 750 W to 3 kW.

AC synchronous servomotors - high performance

Offer high impulse torques and a large power bandwidth, making them easy to adapt to your application.

Power range from 750 W to 8 kW.

Berger Lahr servomotors are compatible with standard servo connection dimensions, providing flexible solutions to any problem. They all come equipped with an absolute measuring system, the SinCos® (SRS) Singleturn. This measuring system is designed to provide optimum performance with our Twin Line family of devices. You can use the HIPERFACE® interface between motor measuring system and device for a self-initialisation of the motor and current-regulator parameters, considerably simplifying the start-up process.

An AC synchronous servomotor module consists of the AC synchronous servomotor itself and the associated controller. Optimum performance is achieved only when motor and controller are perfectly in tune with each other.

Ever more exacting demands are being placed on the applications of modern drive technology, including:

- Positioning precision
- Rotary-speed precision
- Torque precision
- Regulation range
- Dynamics
- Overload compatibility
- Availability

These demands are fully satisfied by the Berger Lahr family of Twin Line products and by both AC synchronous servomotor programs: Standard and High Performance.



Series of High Performance AC synchronous servomotors

AC synchronous servomotors - High Performance

Features

- **High impulse torque** up to five times the continuous stationary torque.
- **Large power bandwidth** encompassing a continuous stationary torque range from 0.34 to 50 Nm, in six model sizes.
- **High adaptability** to your application, because of the availability of individual sizes in several speed/torque variants.

Technical specifications

- 6-pin synchronous motors
- SinCos absolute measuring system[®] (SRS) Singleturn as standard position and rotary-speed measuring system, except for DSM 4-05.x, which only comes with the Resolver
- Use of high-energy neodymium-iron-boron magnets
- Integrated thermal efficiency monitoring (NTC)
- Vibration severity level R according to DIN ISO 2373
- Protection type:
 - Motor housing: IP 65
 - Shaft end, front: IP 64
- Motor and measuring-system connection with mounting sockets, straight exit, except DSM 4-19x, motor connection only via terminal box
- Size (flange)
 - DSM 4-05 (55 x 55 mm²)
 - DSM 4-07 (70 x 70 mm²)
 - DSM 4-09 (92 x 92 mm²)
 - DSM 4-11 (110 x 110 mm²)
 - DSM 4-14 (140 x 140 mm²)
 - DSM 4-19 (190 x 190 mm²)
- Rated speeds, depending on motor length
 - DSM 4-05: 6000 min⁻¹
 - DSM 4-07: 4000/6000 min⁻¹

- DSM 4-09: 3000/4000/6000 min⁻¹
- DSM 4-11: 3000/4000/6000 min⁻¹
- DSM 4-14: 2000/3000/4000 min⁻¹
- DSM 4-19: 1500/2000/3000/4000 min⁻¹

Optional accessories

- Measuring system
 - SinCos[®] (SRM) Multiturn
 - Resolver only for DSM 4-05.x
- Integrated holding brake
- Gearbox
- Mounting sockets, 90°, can be rotated for:
 - Motor (except DSM 4-19.x)
 - Measuring system
- Special shaft, special flange
- Vibration severity level S
- Level R flange precision
- Different colour scheme

Environmental influences

Ambient conditions (based on DIN 50019-R14):

- Temperature: -20 °C to +40 °C
- Humidity: 75 % R.H. yearly average, 95 % R.H. on 30 days, non-condensing

Storage and transport temperature:

- Temperature: -20 °C to +60 °C

Technical Data

AC synchronous servomotors - High Performance

Technical data for DSM 4-05

	U_{DC-Bus}	M_{dO}	I_{dO}	M_{dN}	I_{dN}	n_N	P_N	k_E	M_{max}	I_{max}	J_R	m
	V	Nm	A _{eff}	Nm	A _{eff}	min ⁻¹	kW	V _{eff}	Nm	A _{eff}	kgcm ²	kg
DSM 4-05.1-1xx.x6	325	0.34	1.20	0.32	1.3	6000	0.20	20.0	1.7	7.07	0.17	1.0
DSM 4-05.1-2xx.x6	560	0.34	0.85	0.32	0.9	6000	0.20	27.6	1.7	5.02	0.17	1.0
DSM 4-05.2-1xx.x6	325	0.50	1.50	0.48	1.7	6000	0.30	20.0	2.5	9.05	0.24	1.2
DSM 4-05.2-2xx.x6	560	0.50	1.00	0.48	1.1	6000	0.30	32.8	2.5	6.01	0.24	1.2
DSM 4-05.3-1xx.x6	325	0.65	2.00	0.60	2.3	6000	0.375	20.0	3.2	10.80	0.31	1.4
DSM 4-05.3-2xx.x6	560	0.65	1.20	0.60	1.3	6000	0.375	35.2	3.2	6.51	0.31	1.4
DSM 4-05.4-1xx.x6	325	1.00	3.20	0.80	3.4	6000	0.500	20.0	5.0	16.97	0.45	1.8
DSM 4-05.4-2xx.x6	560	1.00	1.60	0.80	1.7	6000	0.500	40.0	5.0	8.49	0.45	1.8

Technical data for the DSM 4-07.x and its variations

	U_{DC-Bus}	M_{dO}	I_{dO}	M_{dN}	I_{dN}	n_N	P_N	k_E	M_{max}	I_{max}	J_R	m
	V	Nm	A _{eff}	Nm	A _{eff}	min ⁻¹	kW	V _{eff}	Nm	A _{eff}	kgcm ²	kg
DSM 4-07.1-1xx.x4	325	0.65	1.9	0.6	2.0	4000	0.25	20.8	3.1	11.38	0.22	1.5
DSM 4-07.1-2xx.x4	560	0.65	0.9	0.6	0.9	4000	0.25	47.9	3.1	5.37	0.22	1.5
DSM 4-07.1-1xx.x6	325	0.65	2.6	0.5	2.5	6000	0.31	15.4	3.1	15.63	0.22	1.5
DSM 4-07.1-2xx.x6	560	0.65	1.3	0.5	1.2	6000	0.31	32.1	3.1	7.85	0.22	1.5
DSM 4-07.2-1xx.x4	325	1.50	3.2	1.3	2.9	4000	0.54	27.7	7.2	19.23	0.36	2.1
DSM 4-07.2-2xx.x4	560	1.50	1.6	1.3	1.4	4000	0.54	57.2	7.2	9.62	0.36	2.1
DSM 4-07.2-1xx.x6	325	1.50	5.0	1.0	4.4	6000	0.62	17.8	7.2	29.98	0.36	2.1
DSM 4-07.2-2xx.x6	560	1.50	2.4	1.0	2.1	6000	0.62	37.5	7.2	14.42	0.36	2.1
DSM 4-07.3-1xx.x4	325	2.30	5.5	2.0	4.7	4000	0.83	26.3	11.0	33.02	0.57	2.9
DSM 4-07.3-2xx.x4	560	2.30	2.4	2.0	2.0	4000	0.83	60.4	11.0	14.42	0.57	2.9
DSM 4-07.3-1xx.x6	325	2.30	7.7	1.5	6.6	6000	0.94	18.6	11.0	46.17	0.57	2.9
DSM 4-07.3-2xx.x6	560	2.30	3.5	1.5	3.0	6000	0.94	41.8	11.0	21.00	0.57	2.9

U_{DC-Bus}	Intermediate-circuit direct voltage from Twin Line drive or controller	P_N	Rated power
M_{dO}	Continuous stationary torque	k_E	Voltage constant at 1000 min ⁻¹
I_{dO}	Continuous stationary current	M_{max}	Max. torque
M_{dN}	Rated continuous torque	I_{max}	Max. current
I_{dN}	Rated continuous current	J_R	Rotor inertia
n_N	Rated speed	m	Mass

AC synchronous servomotors - High Performance

Technical Data

Technical data for the DSM 4-09.x and its variations

	U _{DC-Bus}	M _{d0}	I _{d0}	M _{dN}	I _{dN}	n _N	P _N	k _E	M _{max}	I _{max}	J _R	m
	V	Nm	A _{eff}	Nm	A _{eff}	min ⁻¹	kW	V _{eff}	Nm	A _{eff}	kgcm ²	kg
DSM 4-09.1-1xx.x3	325	0.95	1.5	0.8	1.3	3000	0.25	36.5	4.3	7.50	1.20	2.7
DSM 4-09.1-2xx.x3	560	0.95	0.8	0.8	0.72	3000	0.25	66.5	4.3	3.96	1.20	2.7
DSM 4-09.1-1xx.x4	325	0.95	2	0.75	1.8	4000	0.31	27.5	4.3	9.97	1.20	2.7
DSM 4-09.1-2xx.x4	560	0.95	1.1	0.75	0.9	4000	0.31	50.2	4.3	5.44	1.20	2.7
DSM 4-09.1-1xx.x6	325	0.95	3	0.7	2.4	6000	0.44	18.3	4.3	14.99	1.20	2.7
DSM 4-09.1-2xx.x6	560	0.95	1.6	0.7	1.3	6000	0.44	33.6	4.3	7.99	1.20	2.7
DSM 4-09.2-1xx.x3	325	2.70	3.2	2.4	2.7	3000	0.75	45.5	12.2	15.98	2.70	3.9
DSM 4-09.2-2xx.x3	560	2.70	1.9	2.4	1.6	3000	0.75	78.8	12.2	9.40	2.70	3.9
DSM 4-09.2-1xx.x4	325	2.70	4.3	2.2	3.6	4000	0.92	34.3	12.2	21.50	2.70	3.9
DSM 4-09.2-2xx.x4	560	2.70	2.5	2.2	2.1	4000	0.92	59	12.2	12.45	2.70	3.9
DSM 4-09.2-1xx.x6	325	2.70	6.5	2.0	5.3	6000	1.25	22.3	12.2	32.46	2.70	3.9
DSM 4-09.2-2xx.x6	560	2.70	3.7	2.0	3	6000	1.25	39.4	12.2	18.46	2.70	3.9
DSM 4-09.3-2xx.x3	560	4.50	2.9	3.9	2.4	3000	1.22	83.5	20.3	14.50	4.20	5.2
DSM 4-09.3-2xx.x4	560	4.50	3.8	3.5	3.1	4000	1.47	64.2	20.3	18.95	4.20	5.2
DSM 4-09.3-2xx.x6	560	4.50	5.6	2.8	3.8	6000	1.76	43.4	20.3	27.93	4.20	5.2
DSM 4-09.4-2xx.x3	560	6.00	4.2	5.0	3.4	3000	1.57	79.7	27.0	21.00	5.40	6.6
DSM 4-09.4-2xx.x4	560	6.00	5.5	4.5	4.4	4000	1.88	61.3	27.0	27.51	5.40	6.6
DSM 4-09.4-2xx.x6	560	6.00	7.8	3	4.5	6000	1.88	42.5	27.0	38.96	5.40	6.6

Technical data for the DSM 4-11.x and its variations

	U _{DC-Bus}	M _{d0}	I _{d0}	M _{dN}	I _{dN}	n _N	P _N	k _E	M _{max}	I _{max}	J _R	m
	V	Nm	A _{eff}	Nm	A _{eff}	min ⁻¹	kW	V _{eff}	Nm	A _{eff}	kgcm ²	kg
DSM 4-11.1-2xx.x3	560	4.20	3	3.7	2.8	3000	1.2	82.7	18.9	10.18	4.80	6.3
DSM 4-11.1-2xx.x4	560	4.20	4	3.5	3.5	4000	1.5	62	18.9	13.58	4.80	6.3
DSM 4-11.1-2xx.x6	560	4.20	6	3	4.8	6000	1.9	41.3	18.9	20.36	4.80	6.3
DSM 4-11.2-2xx.x3	560	7.00	4.8	6.1	4.5	3000	1.9	84.7	31.5	16.26	7.40	7.9
DSM 4-11.2-2xx.x4	560	7.00	6.4	5.8	5.8	4000	2.4	62.9	31.5	21.71	7.40	7.9
DSM 4-11.2-2xx.x6	560	7.00	9.9	3.8	5.9	6000	2.4	40.9	31.5	33.59	7.40	7.9
DSM 4-11.3-2xx.x3	560	10	7.2	8.4	6.3	3000	2.6	84.7	45.0	24.40	9.80	9.6
DSM 4-11.3-2xx.x4	560	10	9.7	7.6	7.7	4000	3.2	62.4	45.0	32.88	9.80	9.6
DSM 4-11.3-2xx.x6	560	10	13.6	5	7.6	6000	3.1	44.6	45.0	46.17	9.80	9.6
DSM 4-11.4-2xx.x3	560	12	8.5	9.9	7.3	3000	3.1	85.9	54.0	28.84	12.70	11.2
DSM 4-11.4-2xx.x4	560	12	11.6	8.6	8.6	4000	3.6	63.1	54.0	39.39	12.70	11.2

U _{DC-Bus}	Intermediate-circuit direct voltage from Twin Line drive or controller	P _N	Rated power
M _{d0}	Continuous stationary torque	k _E	Voltage constant at 1000 min ⁻¹
I _{d0}	Continuous stationary current	M _{max}	Max. torque
M _{dN}	Rated continuous torque	I _{max}	Max. current
I _{dN}	Rated continuous current	J _R	Rotor inertia
n _N	Rated speed	m	Mass

Technical Data

AC synchronous servomotors - High Performance

Technical data for the DSM 4-14.x and its variations

	U_{DC-Bus}	M_{dO}	I_{dO}	M_{dN}	I_{dN}	n_N	P_N	k_E	M_{max}	I_{max}	J_R	m
	V	Nm	A _{eff}	Nm	A _{eff}	min ⁻¹	kW	V _{eff}	Nm	A _{eff}	kgcm ²	kg
DSM 4-14.1-2xx.x2	560	8.5	3.7	7	3.1	2000	1.5	142.3	42	19.80	12.3	10
DSM 4-14.1-2xx.x3	560	8.5	5.6	6.5	4.5	3000	2.0	94.0	42	29.70	12.3	10
DSM 4-14.1-2xx.x4	560	8.5	7.4	5.2	4.8	4000	2.2	71.0	42	39.60	12.3	10
DSM 4-14.2-2xx.x2	560	14.00	5.6	12.2	4.9	2000	2.6	145.4	70	29.70	19.50	12
DSM 4-14.2-2xx.x3	560	14.00	9.0	11.0	7	3000	3.5	96.3	70	48.08	19.50	12
DSM 4-14.2-2xx.x4	560	14.00	12.0	7.6	6.5	4000	3.2	73.1	70	63.64	19.50	12
DSM 4-14.3-2xx.x2	560	19.0	8.1	16.5	7.3	2000	3.5	141.1	85.0	38.89	26.70	16
DSM 4-14.3-2xx.x3	560	19.0	12.4	14.6	9.9	3000	4.6	92.5	85.0	59.40	26.70	16
DSM 4-14.3-2xx.x4	560	19.0	16.2	8.7	7.7	4000	3.6	70.7	85.0	77.78	26.70	16
DSM 4-14.4-2xx.x2	560	27.0	11.9	21.4	9.4	2000	4.5	148.0	121.0	56.57	36	20
DSM 4-14.4-2xx.x3	560	27.0	17.3	15.5	9.9	3000	4.9	101.0	121.0	82.73	36	20

Technical data for the DSM 4-19.x and its variations

	U_{DC-Bus}	M_{dO}	I_{dO}	M_{dN}	I_{dN}	n_N	P_N	k_E	M_{max}	I_{max}	J_R	m
	V	Nm	A _{eff}	Nm	A _{eff}	min ⁻¹	kW	V _{eff}	Nm	A _{eff}	kgcm ²	kg
DSM 4-19.1-2xx.x1	560	25	8.2	22.5	7.5	1500	3.5	189.2	88	28.99	84	31
DSM 4-19.1-2xx.x2	560	25	11.1	21.5	9.7	2000	4.5	140.6	88	38.89	84	31
DSM 4-19.1-2xx.x3	560	25	17.0	20.0	13.8	3000	6.3	91.9	88	60.10	84	31
DSM 4-19.1-2xx.x4	560	25	22.2	16.0	14.8	4000	6.7	70.3	88	77.78	84	31
DSM 4-19.2-2xx.x1	560	50	17.0	42.0	14.5	1500	6.6	179.6	175	60.1	147	44
DSM 4-19.2-2xx.x2	560	50	22.3	38.0	17.2	2000	7.9	137.3	175	78.5	147	44
DSM 4-19.2-2xx.x3	560	50	32.2	31.0	20.6	3000	9.7	95.1	175	113.1	147	44

U_{DC-Bus}	Intermediate-circuit direct voltage from Twin Line drive or controller	P_N	Rated power
M_{dO}	Continuous stationary torque	k_E	Voltage constant at 1000 min ⁻¹
I_{dO}	Continuous stationary current	M_{max}	Max. torque
M_{dN}	Rated continuous torque	I_{max}	Max. current
I_{dN}	Rated continuous current	J_R	Rotor inertia
n_N	Rated speed	m	Mass

AC synchronous servomotors - High Performance

Characteristic curves

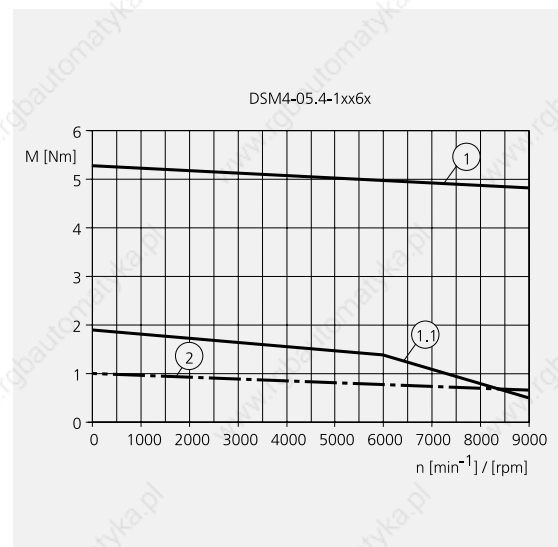
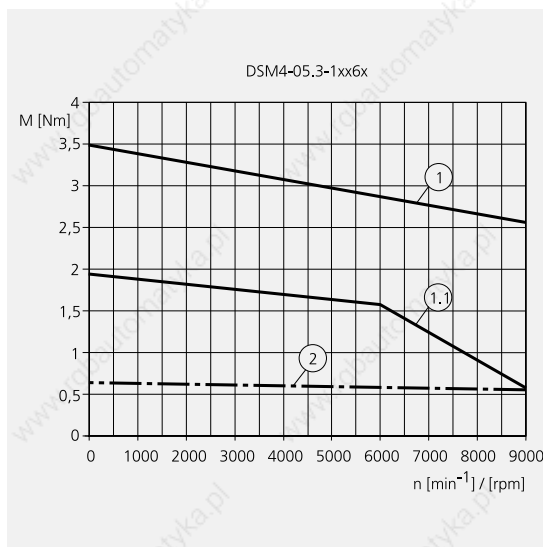
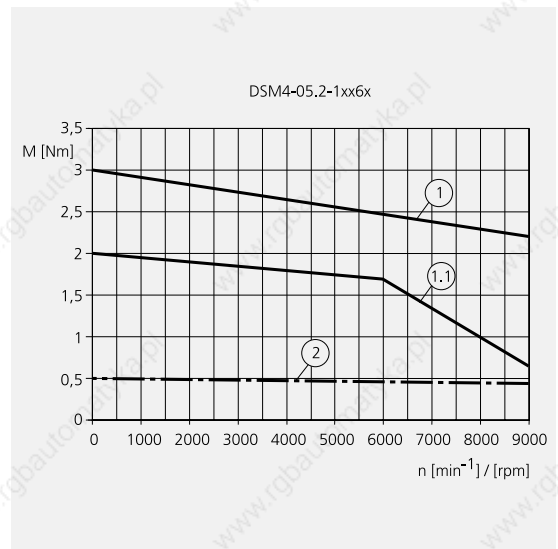
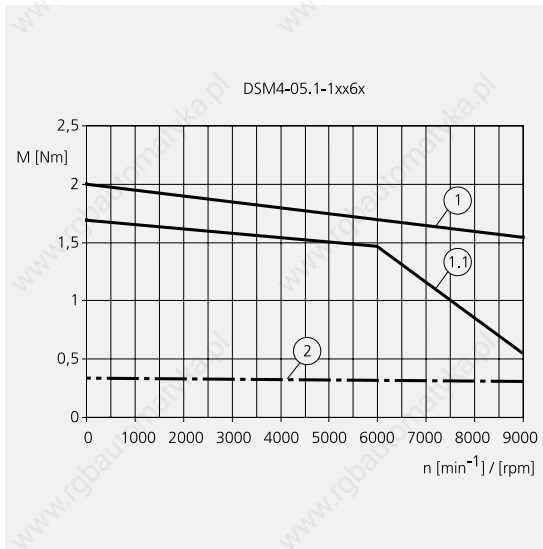

- 1 Motor peak torque
- 2 Continuous torque
- 1.1 Peak torque with TLX x32
- 1.3 Peak torque with TLX x34
- 1.5 Peak torque with TLX x36
- 1.7 Peak torque with TLX x38

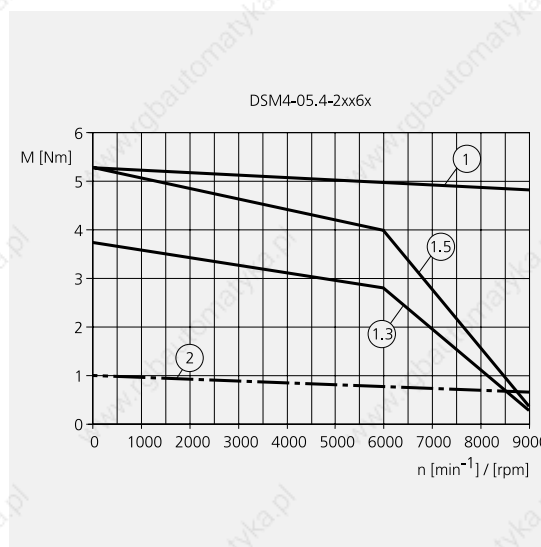
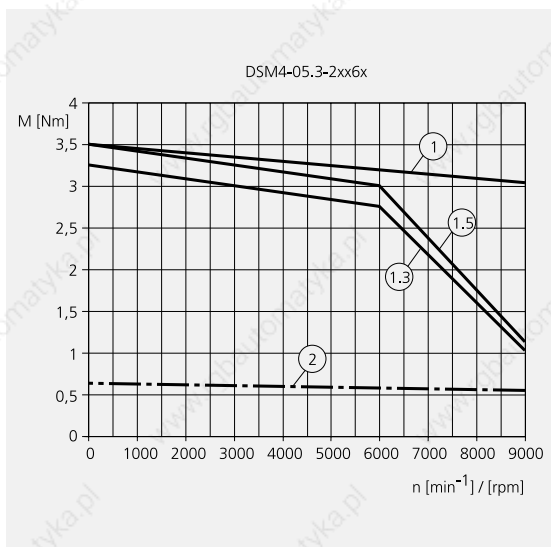
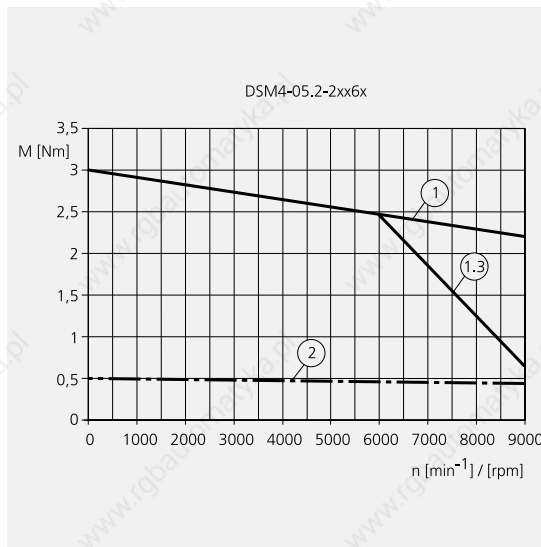
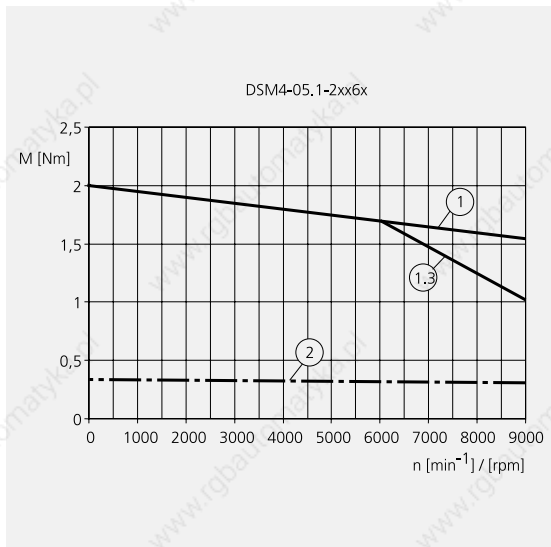

- 1 Motor peak torque
- 2 Continuous torque
- 1.1 Peak torque with TLX x32
- 1.3 Peak torque with TLX x34
- 1.5 Peak torque with TLX x36
- 1.7 Peak torque with TLX x38

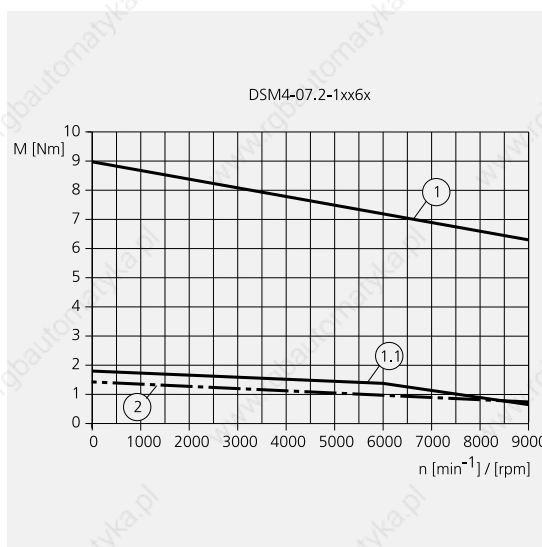
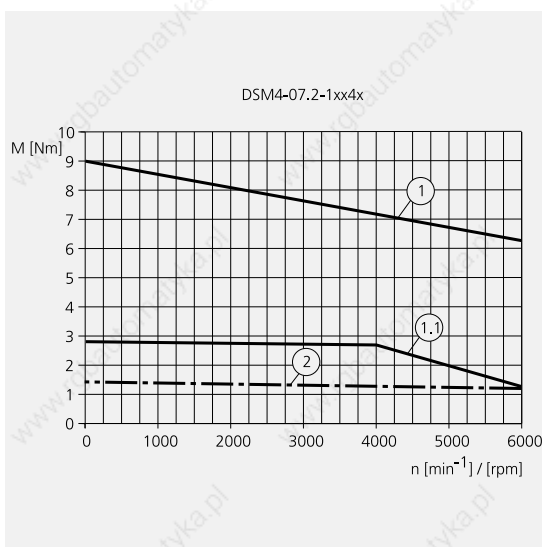
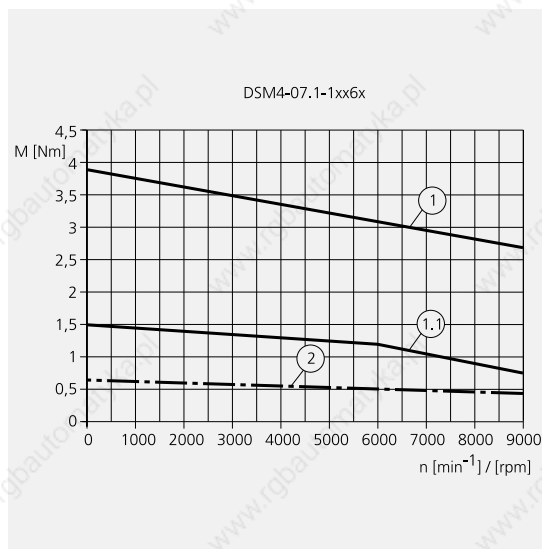
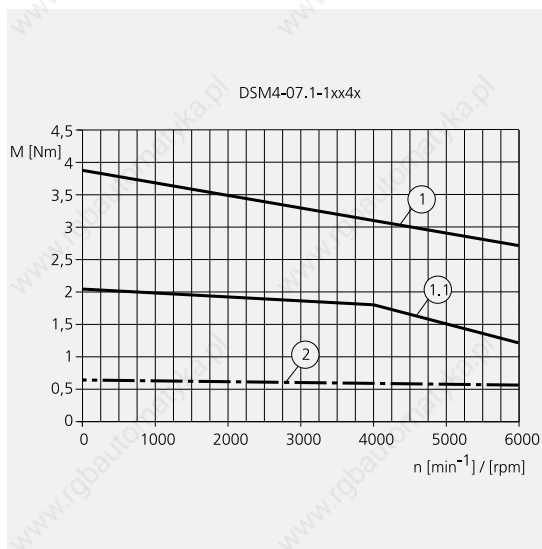

- 1 Motor peak torque
- 2 Continuous torque
- 1.1 Peak torque with TLX x32
- 1.3 Peak torque with TLX x34
- 1.5 Peak torque with TLX x36
- 1.7 Peak torque with TLX x38

Characteristic curves

AC synchronous servomotors - High Performance

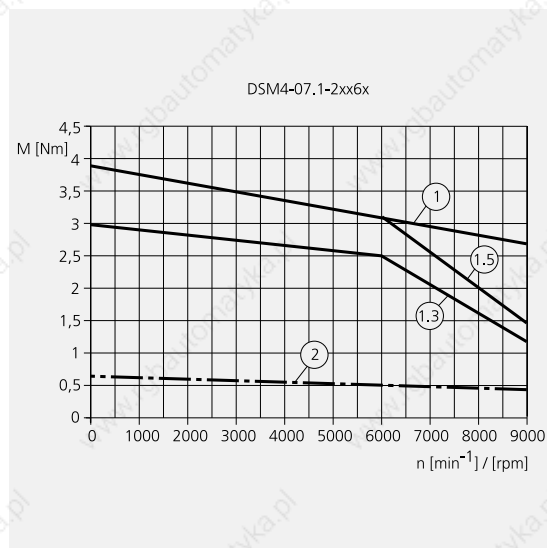
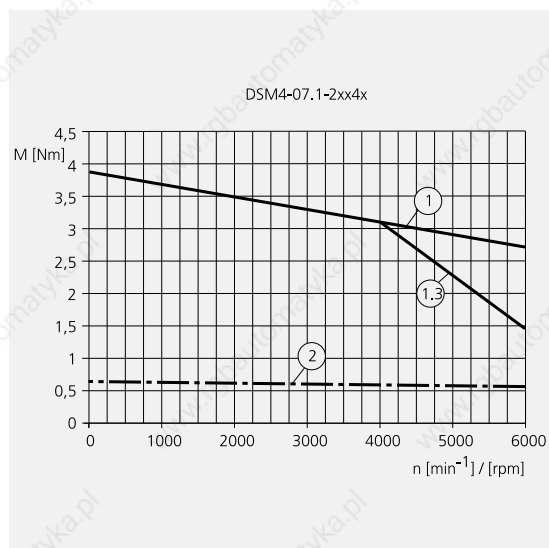
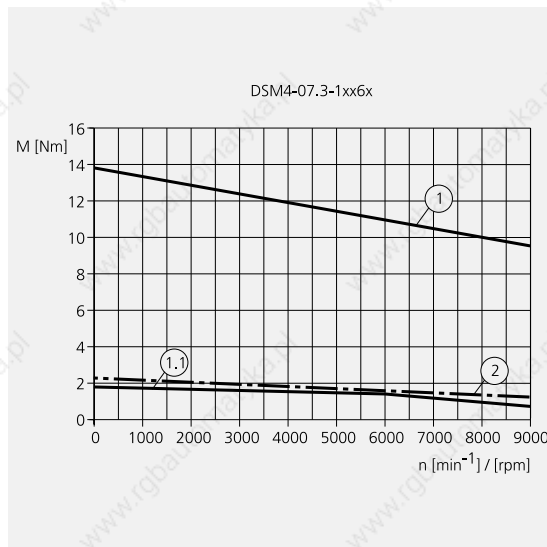
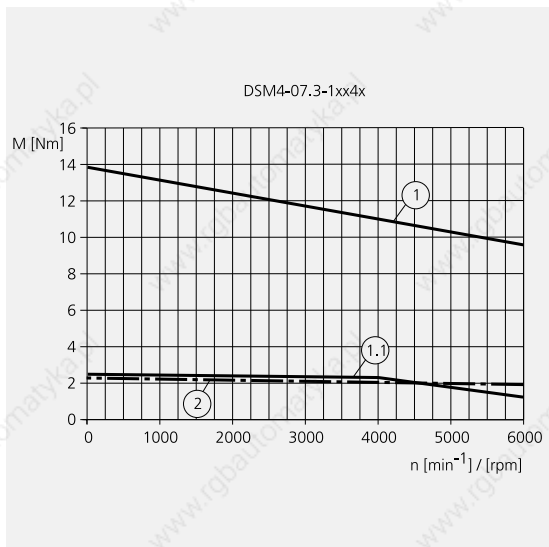

- 1 Motor peak torque
- 2 Continuous torque
- 1.1 Peak torque with TLX x32
- 1.3 Peak torque with TLX x34
- 1.5 Peak torque with TLX x36
- 1.7 Peak torque with TLX x38

AC synchronous servomotors - High Performance

Characteristic curves

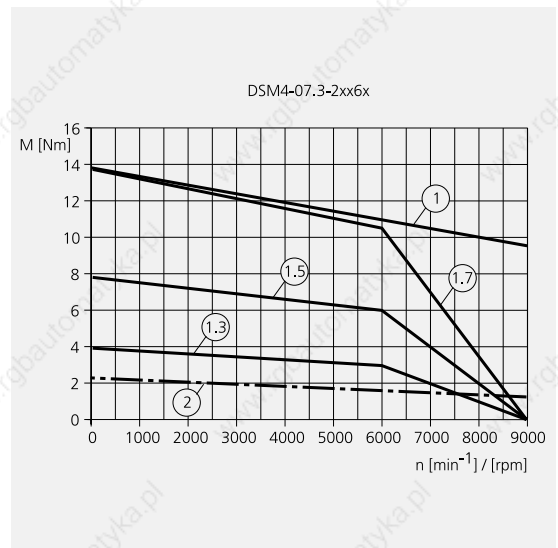
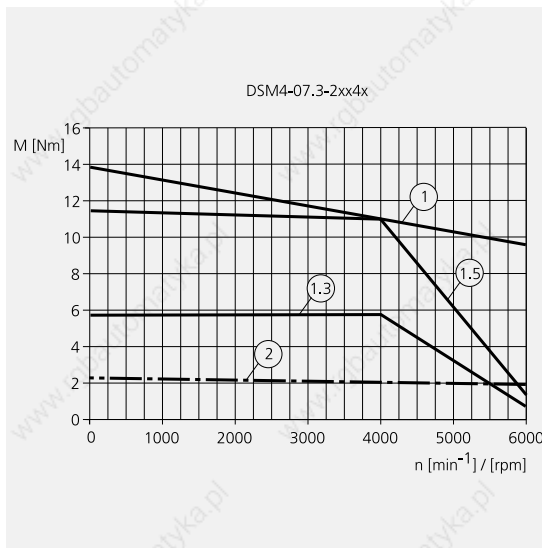
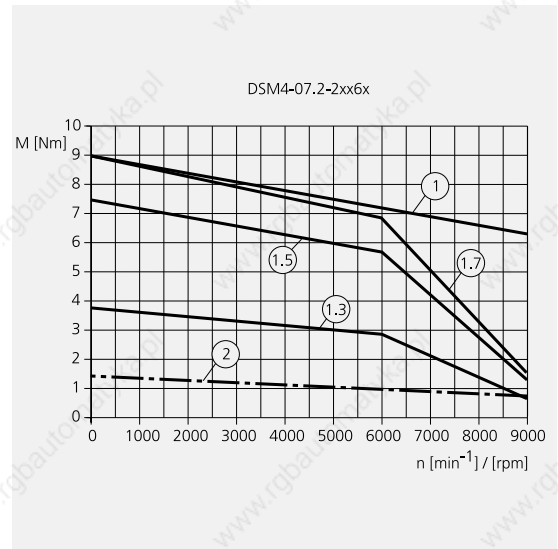
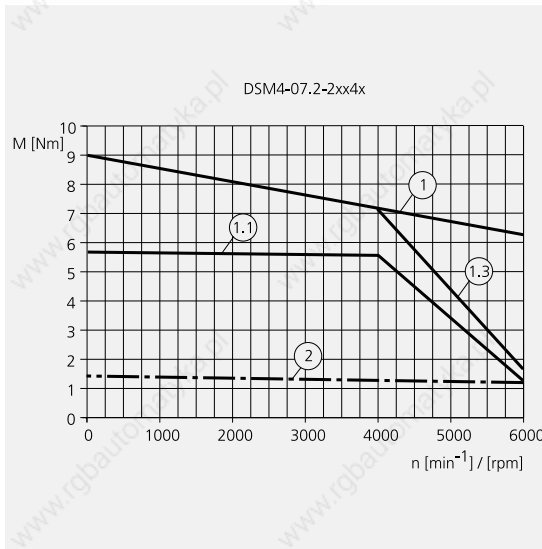

- 1 Motor peak torque
- 2 Continuous torque
- 1.1 Peak torque with TLX x32
- 1.3 Peak torque with TLX x34
- 1.5 Peak torque with TLX x36
- 1.7 Peak torque with TLX x38

Characteristic curves

AC synchronous servomotors - High Performance

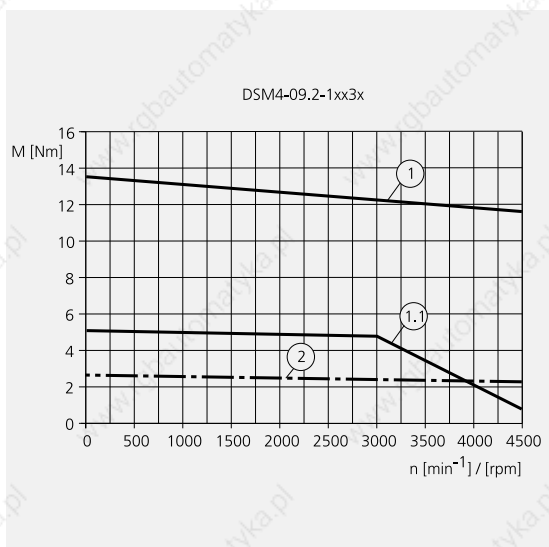
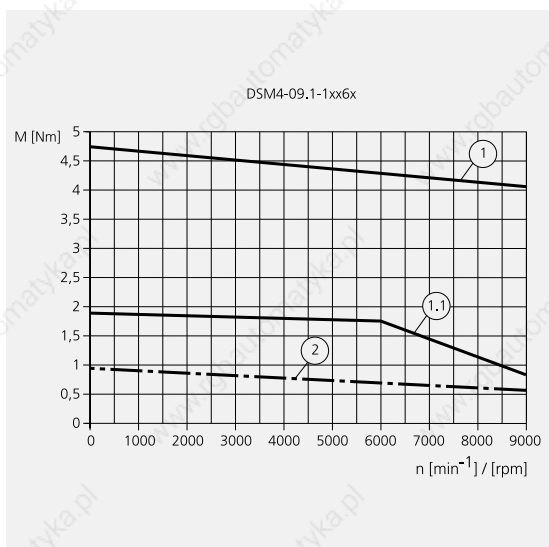
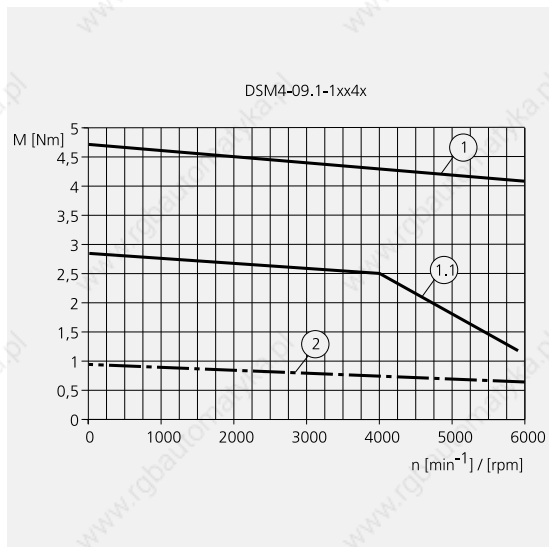
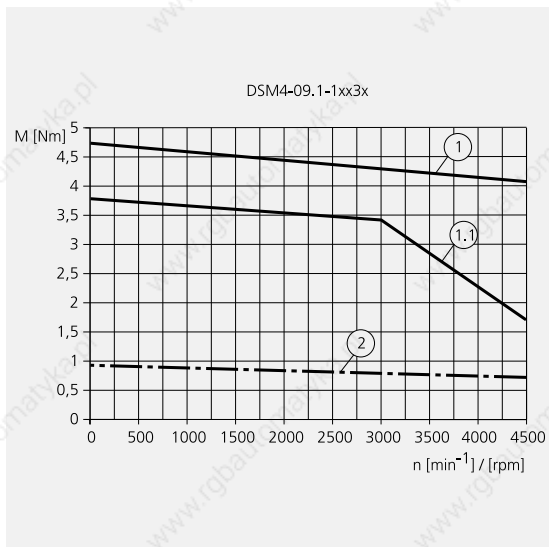

- 1 Motor peak torque
- 2 Continuous torque
- 1.1 Peak torque with TLX x32
- 1.3 Peak torque with TLX x34
- 1.5 Peak torque with TLX x36
- 1.7 Peak torque with TLX x38

AC synchronous servomotors - High Performance

Characteristic curves

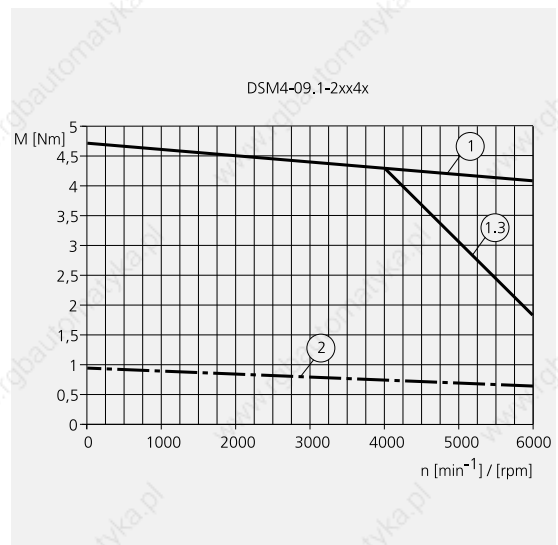
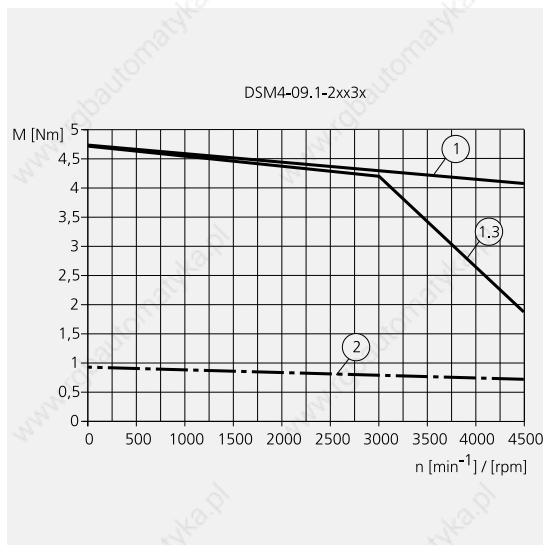
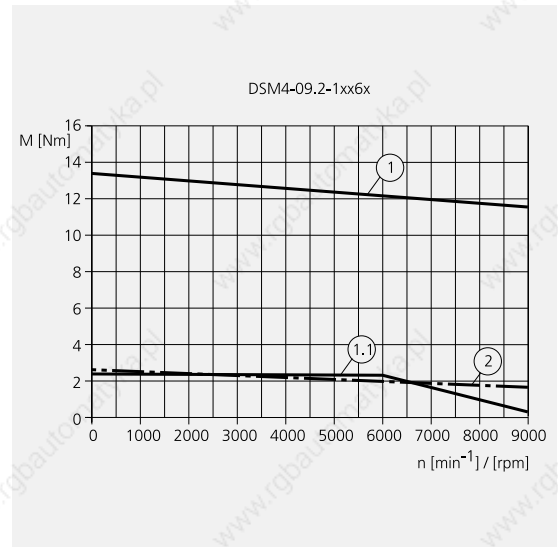
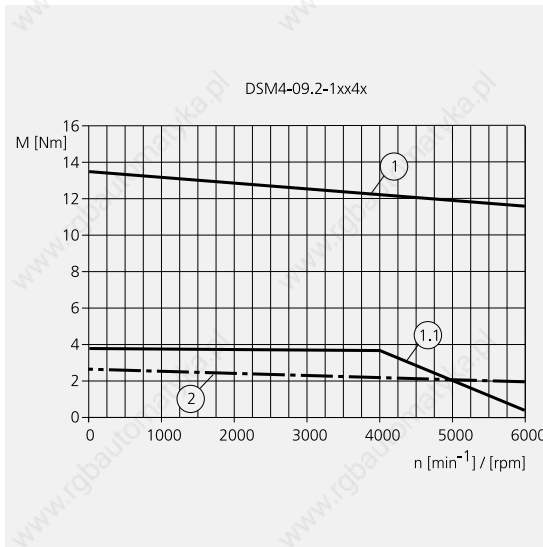

- 1 Motor peak torque
- 2 Continuous torque
- 1.1 Peak torque with TLX x32
- 1.3 Peak torque with TLX x34
- 1.5 Peak torque with TLX x36
- 1.7 Peak torque with TLX x38

Characteristic curves

AC synchronous servomotors - High Performance

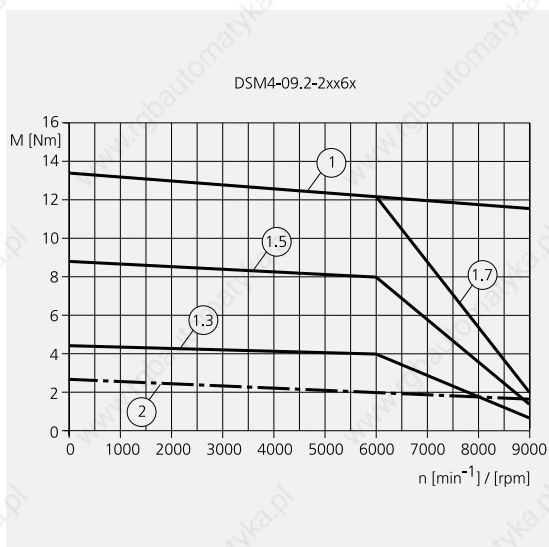
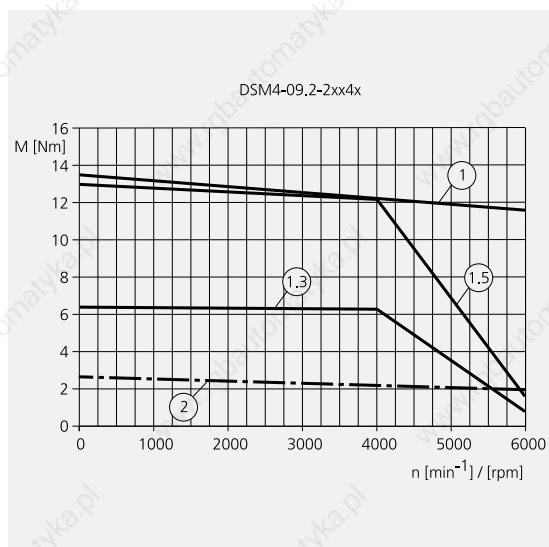
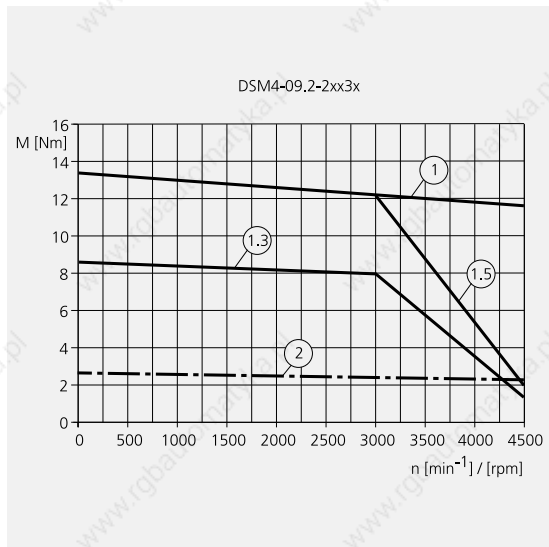
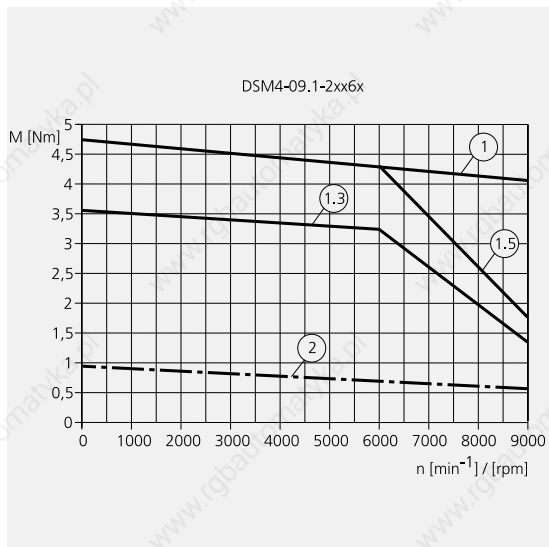

- 1 Motor peak torque
- 2 Continuous torque
- 1.1 Peak torque with TLX x32
- 1.3 Peak torque with TLX x34
- 1.5 Peak torque with TLX x36
- 1.7 Peak torque with TLX x38

AC synchronous servomotors - High Performance

Characteristic curves

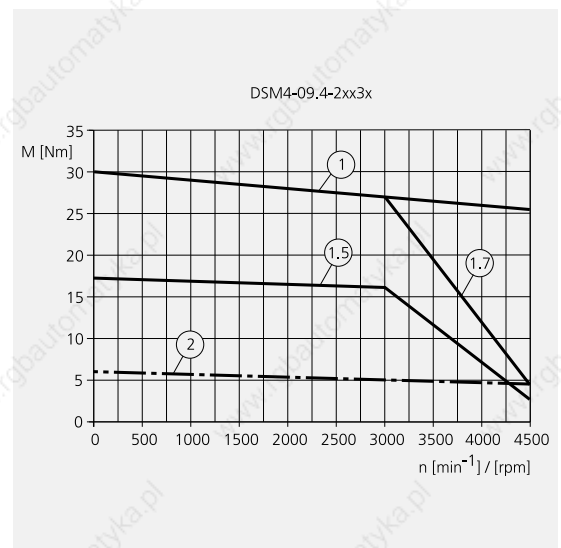
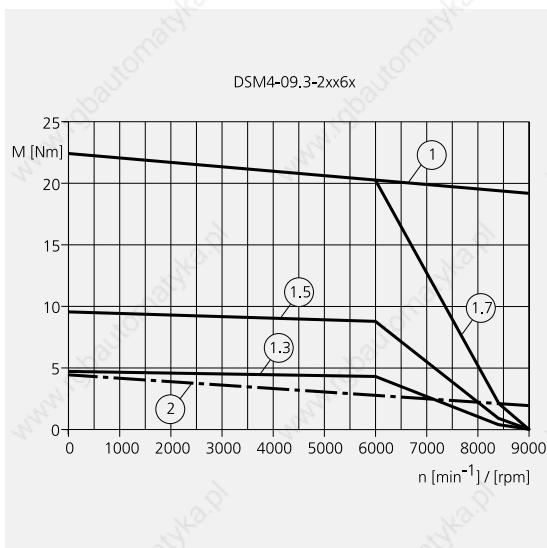
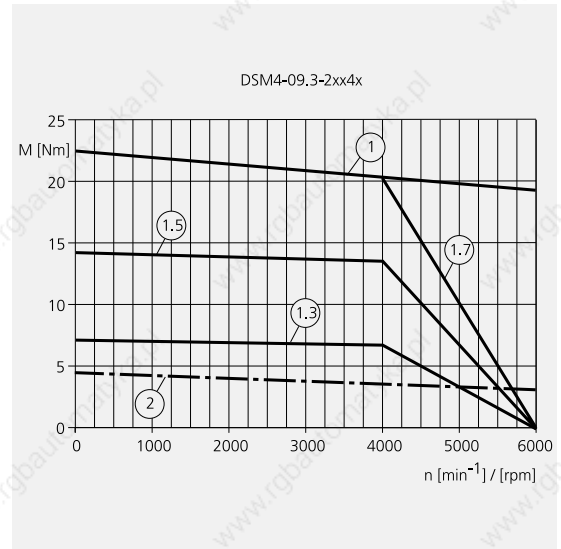
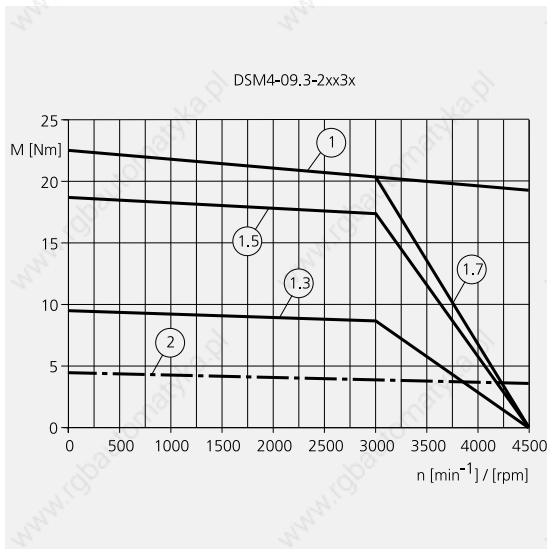

- 1 Motor peak torque
- 2 Continuous torque
- 1.1 Peak torque with TLX x32
- 1.3 Peak torque with TLX x34
- 1.5 Peak torque with TLX x36
- 1.7 Peak torque with TLX x38

Characteristic curves

AC synchronous servomotors - High Performance

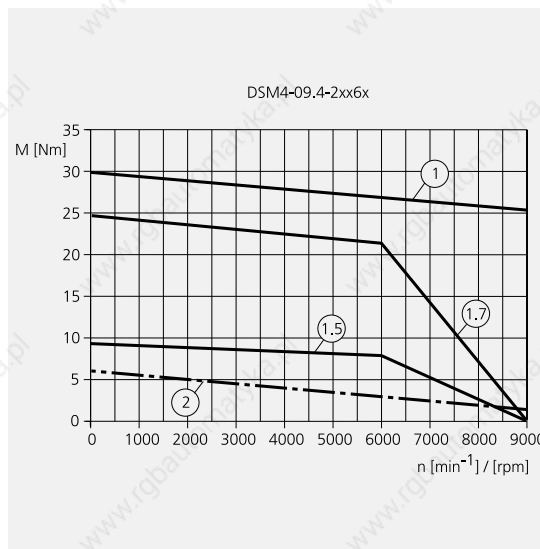
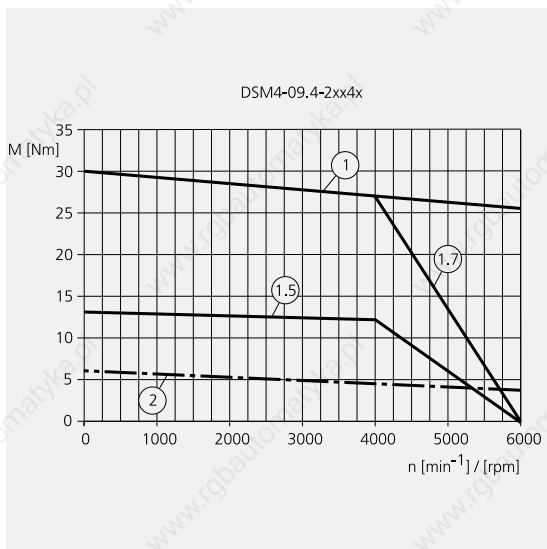

- 1 Motor peak torque
- 2 Continuous torque
- 1.1 Peak torque with TLX x32
- 1.3 Peak torque with TLX x34
- 1.5 Peak torque with TLX x36
- 1.7 Peak torque with TLX x38

AC synchronous servomotors - High Performance

Characteristic curves

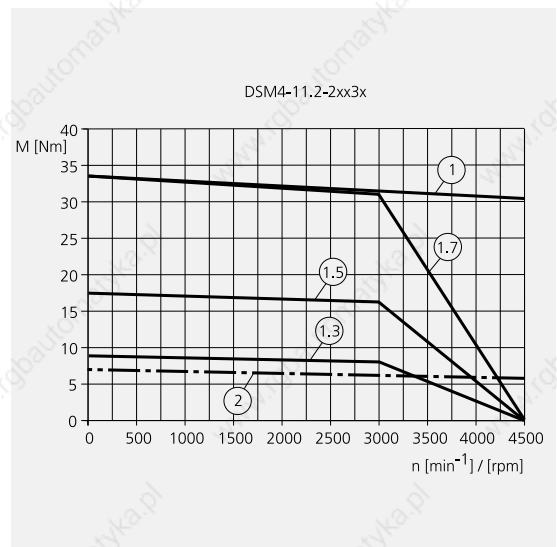
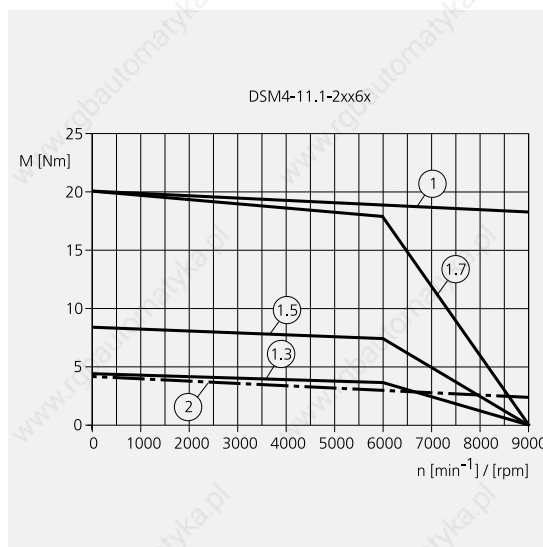
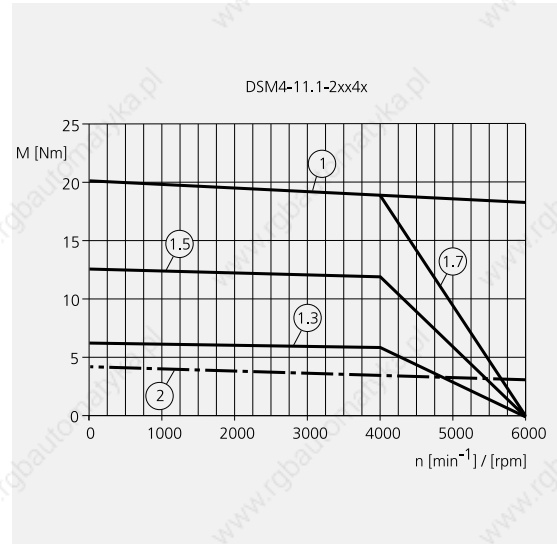
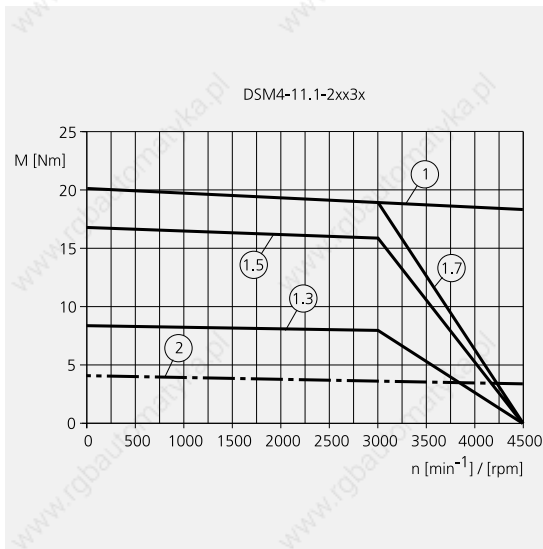

- 1 Motor peak torque
- 2 Continuous torque
- 1.1 Peak torque with TLX x32
- 1.3 Peak torque with TLX x34
- 1.5 Peak torque with TLX x36
- 1.7 Peak torque with TLX x38

Characteristic curves

AC synchronous servomotors - High Performance

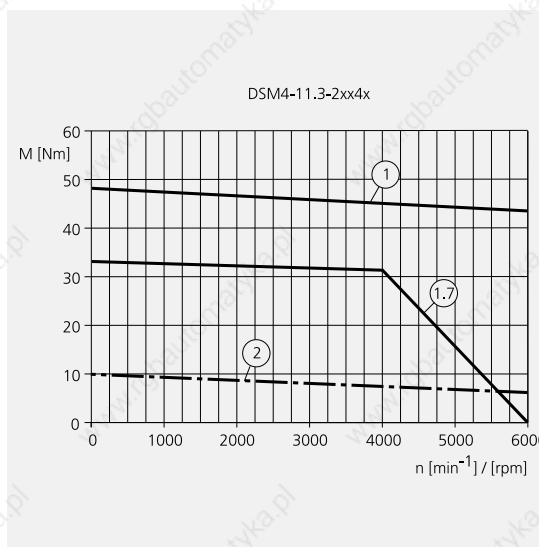
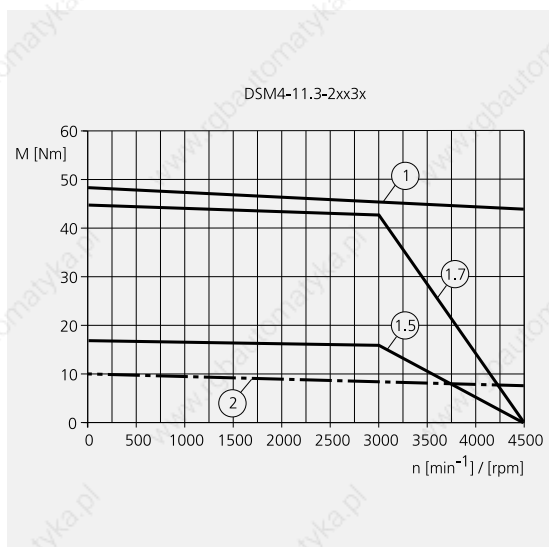
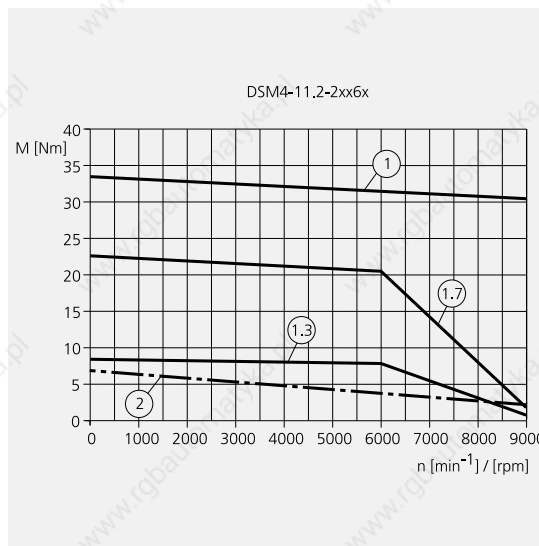
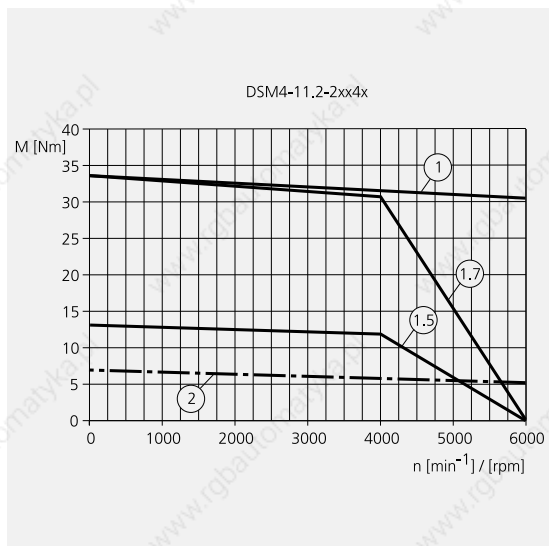

- 1 Motor peak torque
- 2 Continuous torque
- 1.1 Peak torque with TLX x32
- 1.3 Peak torque with TLX x34
- 1.5 Peak torque with TLX x36
- 1.7 Peak torque with TLX x38

AC synchronous servomotors - High Performance

Characteristic curves

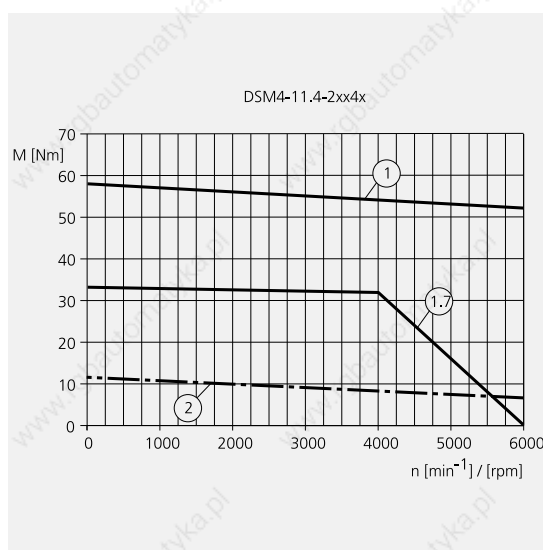
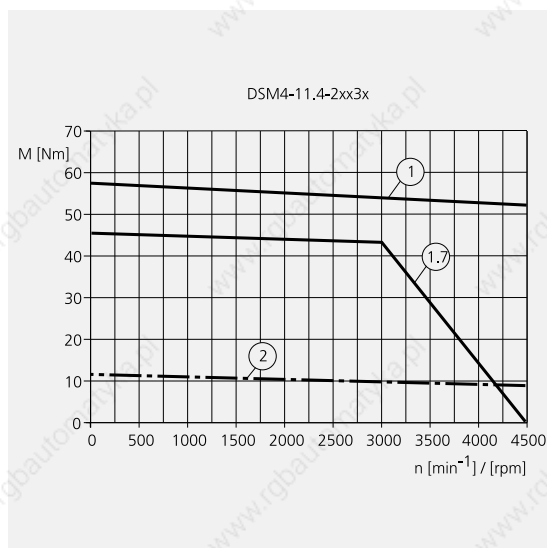
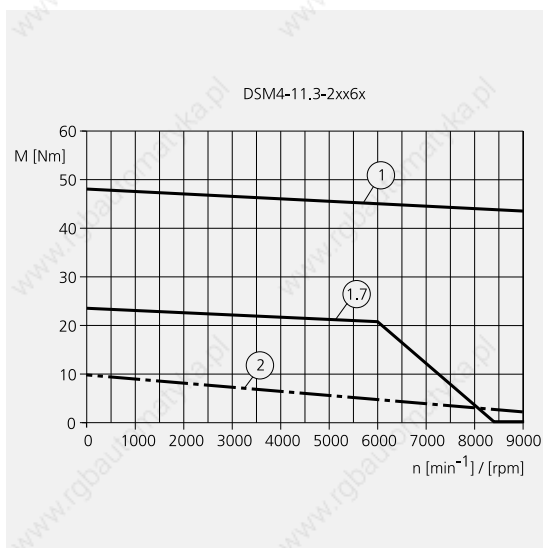

- 1 Motor peak torque
- 2 Continuous torque
- 1.1 Peak torque with TLX x32
- 1.3 Peak torque with TLX x34
- 1.5 Peak torque with TLX x36
- 1.7 Peak torque with TLX x38

Characteristic curves

AC synchronous servomotors - High Performance

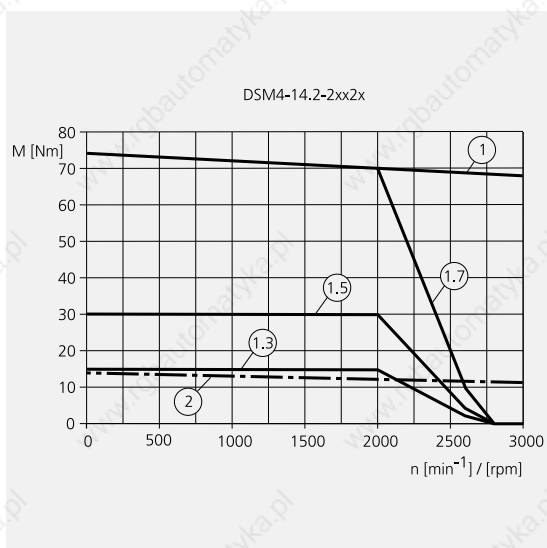
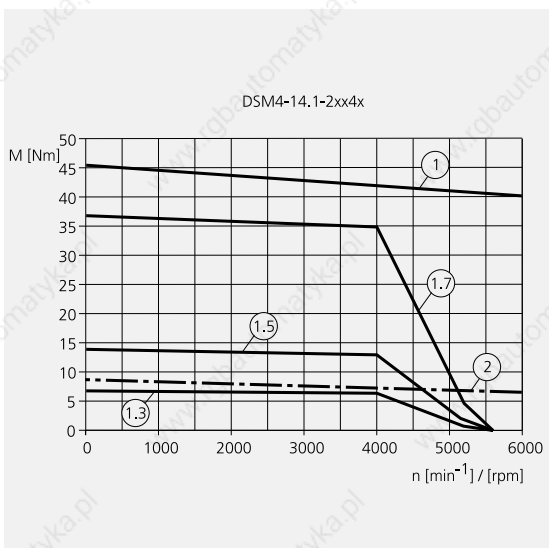
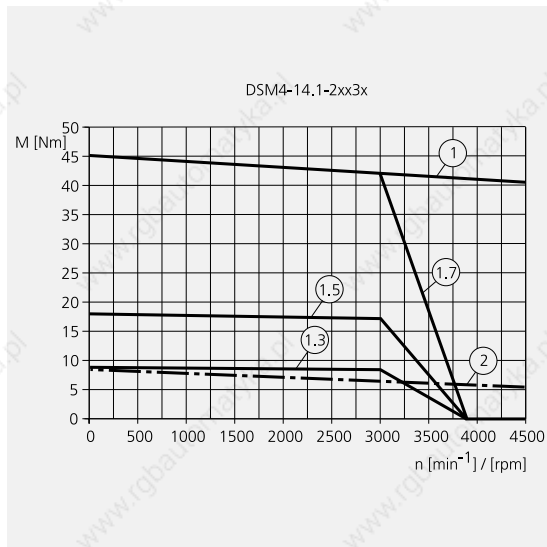
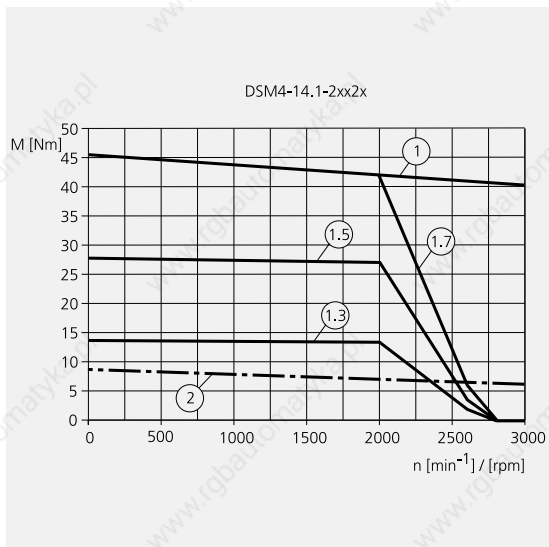

- 1 Motor peak torque
- 2 Continuous torque
- 1.1 Peak torque with TLX x32
- 1.3 Peak torque with TLX x34
- 1.5 Peak torque with TLX x36
- 1.7 Peak torque with TLX x38

AC synchronous servomotors - High Performance

Characteristic curves

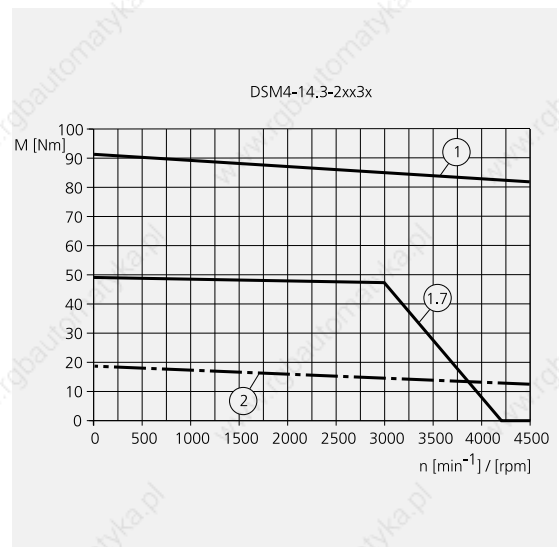
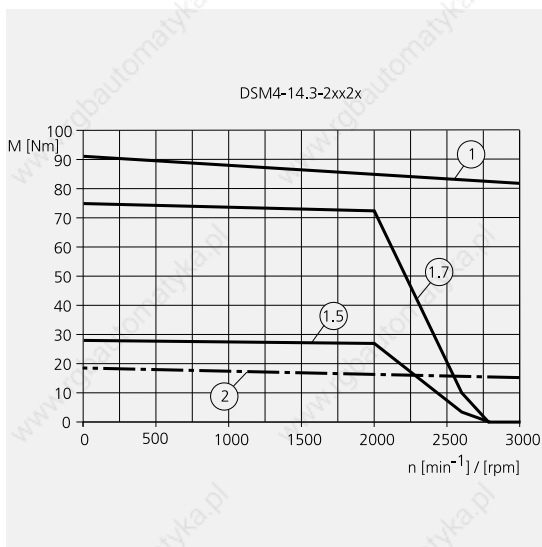
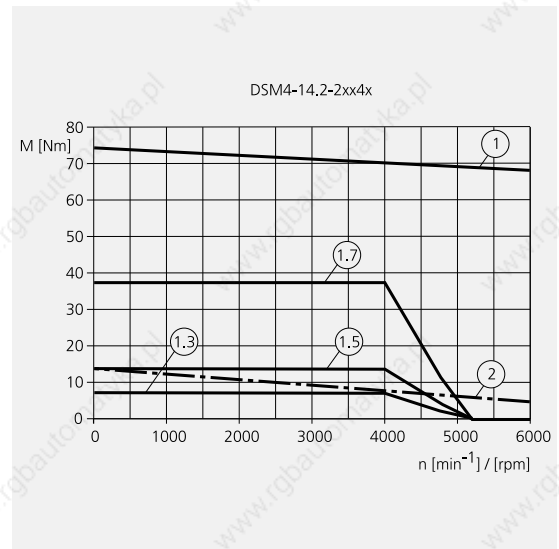
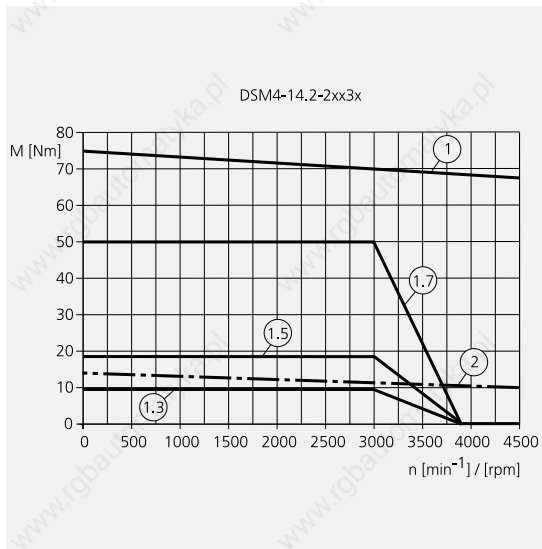

- 1 Motor peak torque
- 2 Continuous torque
- 1.1 Peak torque with TLX x32
- 1.3 Peak torque with TLX x34
- 1.5 Peak torque with TLX x36
- 1.7 Peak torque with TLX x38

Characteristic curves

AC synchronous servomotors - High Performance

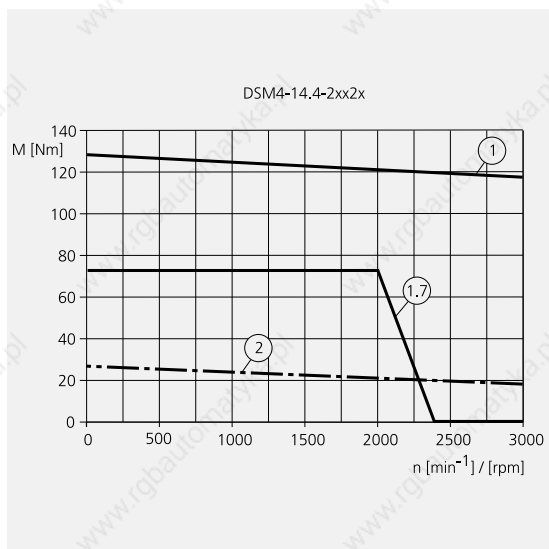
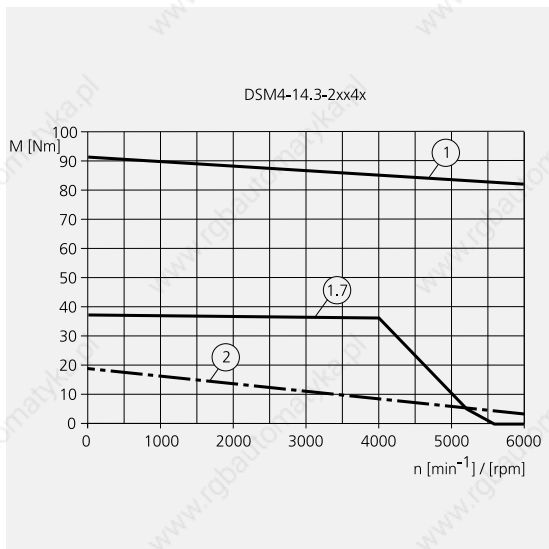

- 1 Motor peak torque
- 2 Continuous torque
- 1.1 Peak torque with TLX x32
- 1.3 Peak torque with TLX x34
- 1.5 Peak torque with TLX x36
- 1.7 Peak torque with TLX x38

AC synchronous servomotors - High Performance

Characteristic curves

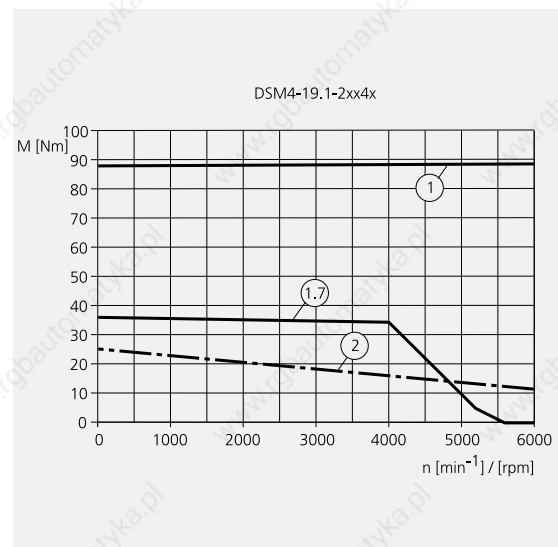
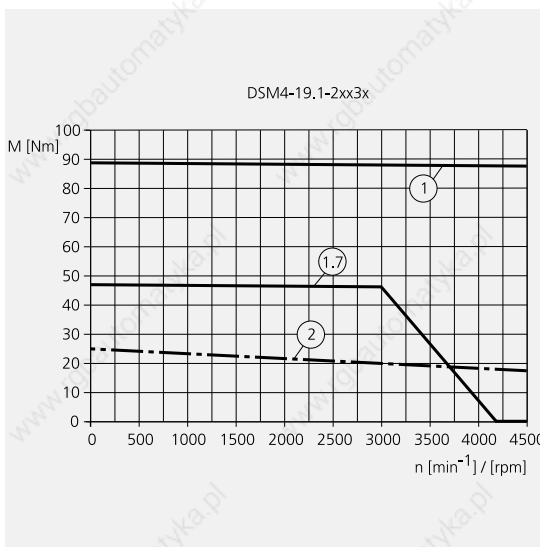
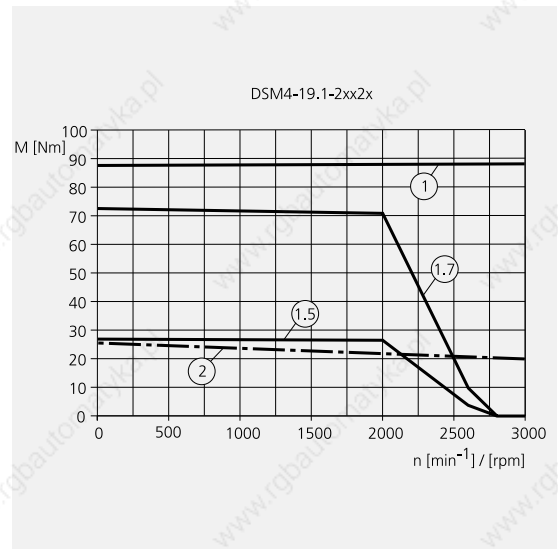
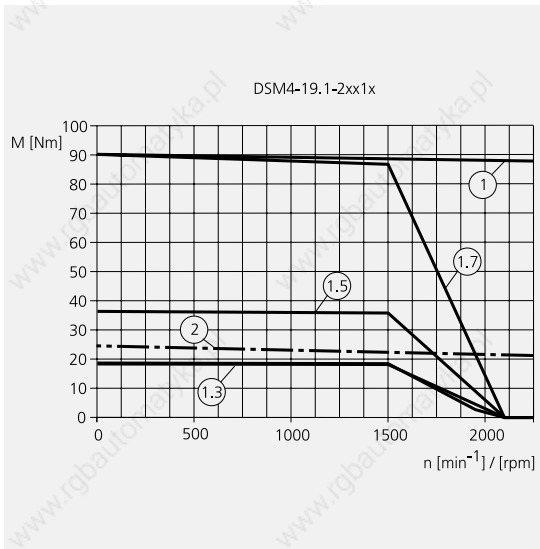

- 1 Motor peak torque
- 2 Continuous torque
- 1.1 Peak torque with TLX x32
- 1.3 Peak torque with TLX x34
- 1.5 Peak torque with TLX x36
- 1.7 Peak torque with TLX x38

Characteristic curves

AC synchronous servomotors - High Performance

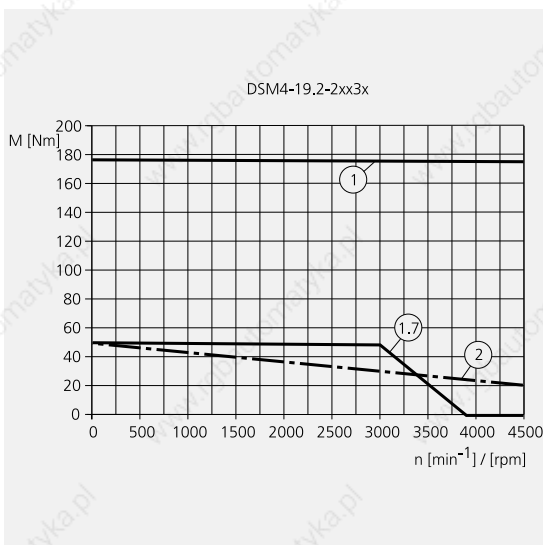
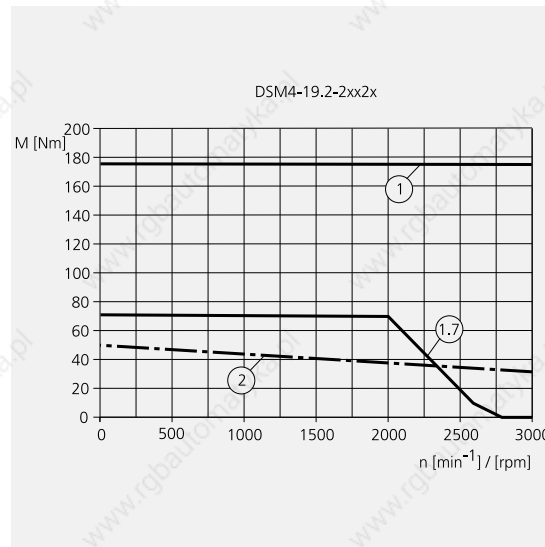
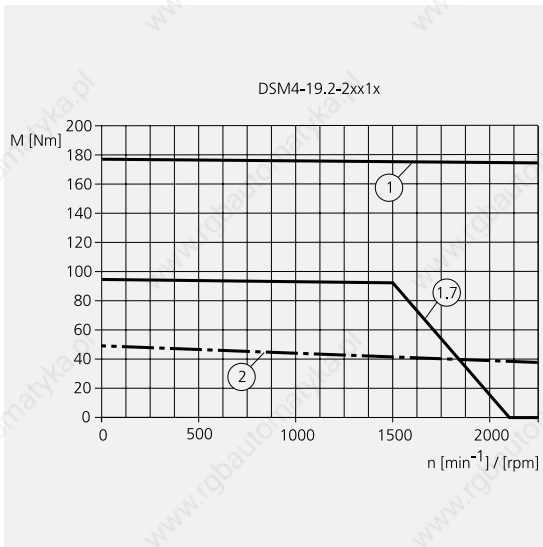

- 1 Motor peak torque
- 2 Continuous torque
- 1.1 Peak torque with TLX x32
- 1.3 Peak torque with TLX x34
- 1.5 Peak torque with TLX x36
- 1.7 Peak torque with TLX x38

AC synchronous servomotors - High Performance

Dimensional drawings

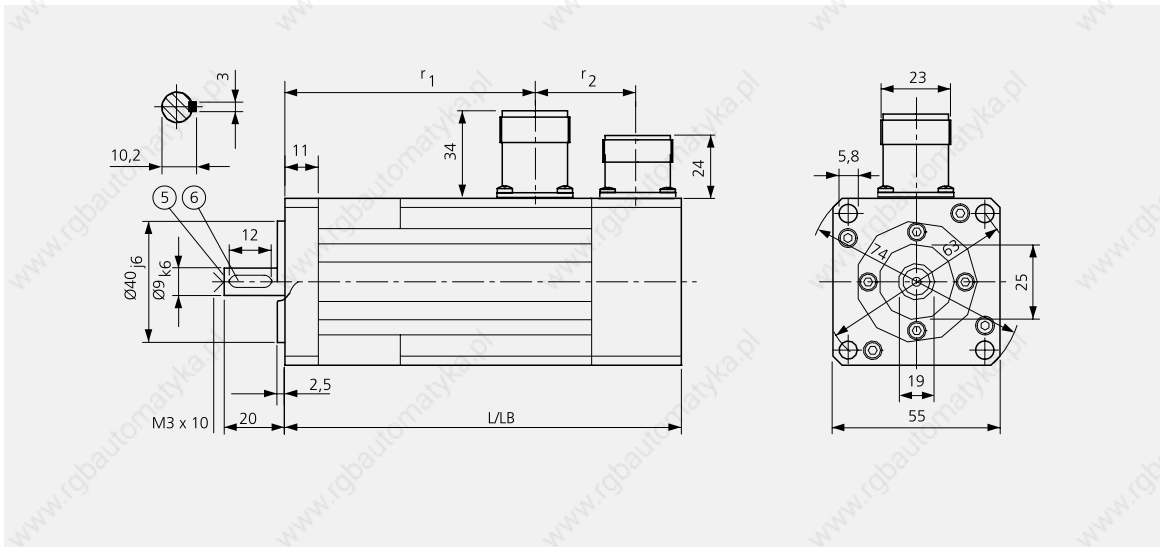

DSM 4-05 High Performance AC synchronous servomotor

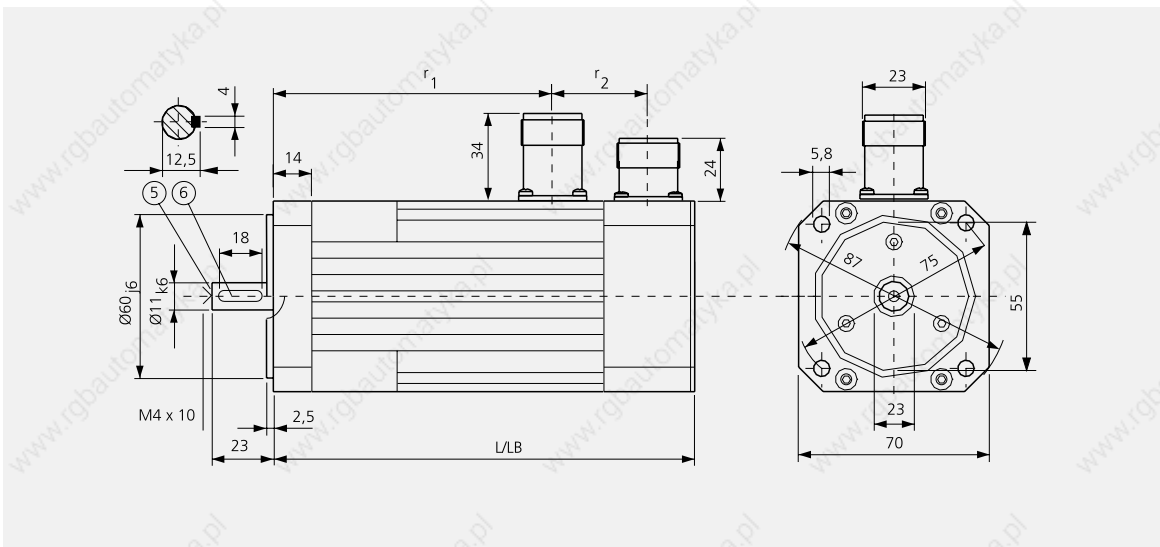

DSM 4-07 High Performance AC synchronous servomotor

- 5 Centre hole
- 6 Featherkey

	L = without brake (n. b.)		LB = with brake (w. b.)		r ₁ (n. b.)	r ₁ (w. b.)	r ₂	Measuring system	
	SinCos®		Resolver					SinCos®	
	SinCos®	Resolver	SinCos®	Resolver	SinCos®	Resolver	SinCos®	Resolver	
DSM 4-05.1	-	121 mm	-	145 mm	72 mm	97 mm	-	33 mm	
DSM 4-05.2	-	133 mm	-	157 mm	85 mm	109 mm	-	33 mm	
DSM 4-05.3	-	145 mm	-	169 mm	97 mm	121 mm	-	33 mm	
DSM 4-05.4	-	170 mm	-	194 mm	121 mm	146 mm	-	33 mm	
DSM 4-07.1	177 mm	136 mm	205 mm	164 mm	81 mm	109 mm	66 mm	33 mm	
DSM 4-07.2	201 mm	160 mm	229 mm	188 mm	105 mm	133 mm	66 mm	33 mm	
DSM 4-07.3	237 mm	196 mm	265 mm	224 mm	141 mm	169 mm	66 mm	33 mm	

Dimensional drawings

AC synchronous servomotors - High Performance

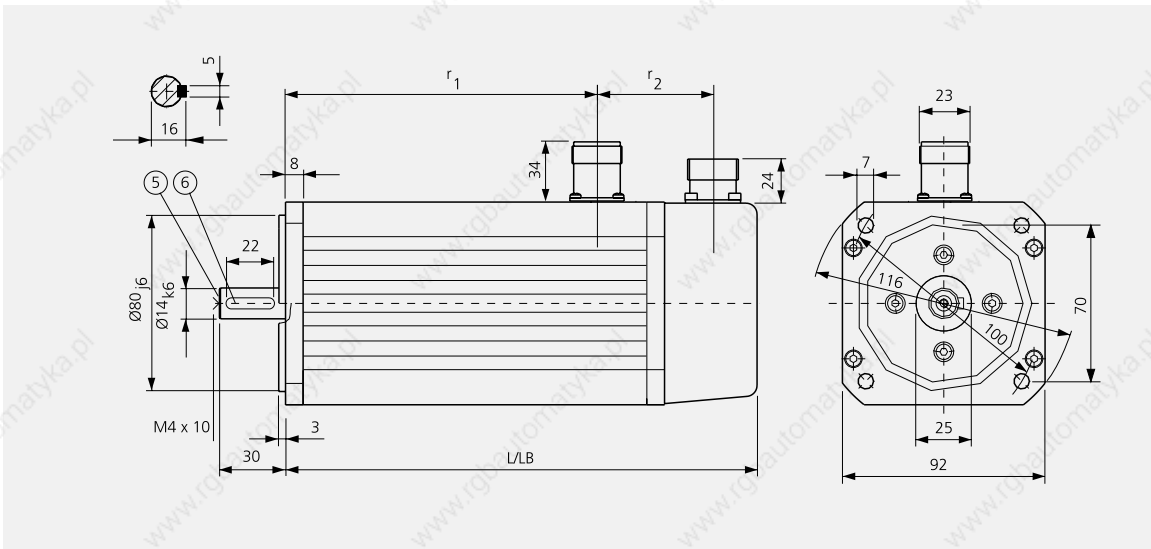

DSM 4-09 High Performance AC synchronous servomotor

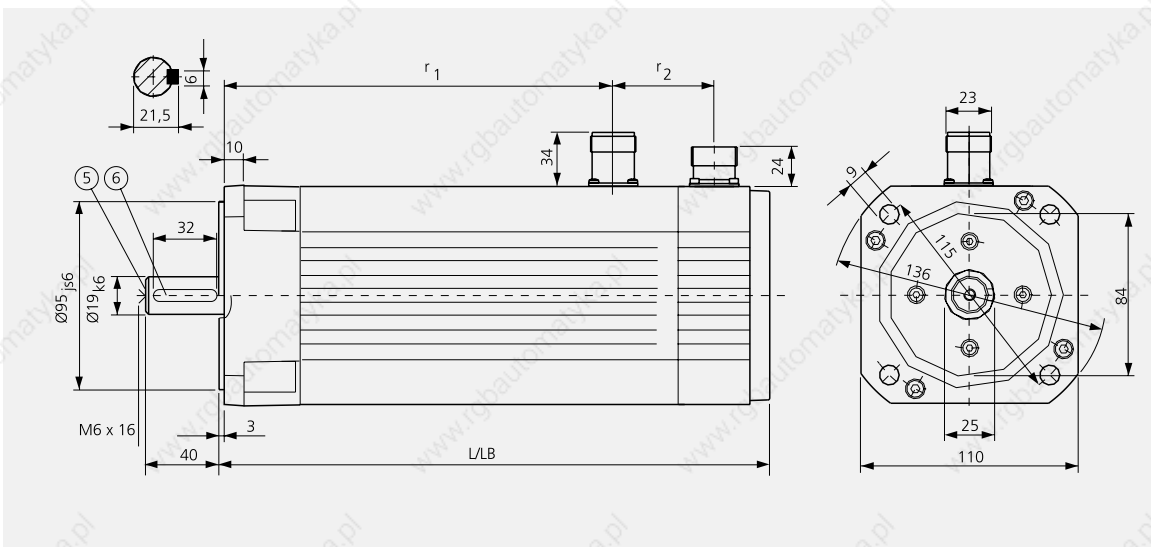

DSM 4-11 High Performance AC synchronous servomotor

- 5 Centre hole
- 6 Featherkey

	L = without brake (n. b.)		LB = with brake (w. b.)		r ₁ (n. b.)	r ₁ (w. b.)	r ₂	Measuring system	
	SinCos®	Resolver	SinCos®	Resolver				SinCos®	Resolver
DSM 4-09.1	163 mm	156 mm	199 mm	192 mm	85 mm	121 mm	51 mm	51 mm	
DSM 4-09.2	187 mm	180 mm	233 mm	226 mm	109 mm	155 mm	51 mm	51 mm	
DSM 4-09.3	221 mm	214 mm	267 mm	260 mm	143 mm	189 mm	51 mm	51 mm	
DSM 4-09.4	255 mm	248 mm	301 mm	294 mm	177 mm	223 mm	51 mm	51 mm	
DSM 4-11.1	255 mm	218 mm	263 mm	226 mm	138 mm	145 mm	82 mm	52 mm	
DSM 4-11.2	285 mm	248 mm	293 mm	256 mm	168 mm	175 mm	82 mm	52 mm	
DSM 4-11.3	315 mm	278 mm	323 mm	286 mm	198 mm	205 mm	82 mm	52 mm	
DSM 4-11.4	345 mm	308 mm	353 mm	316 mm	228 mm	235 mm	82 mm	52 mm	

AC synchronous servomotors - High Performance

Dimensional drawings

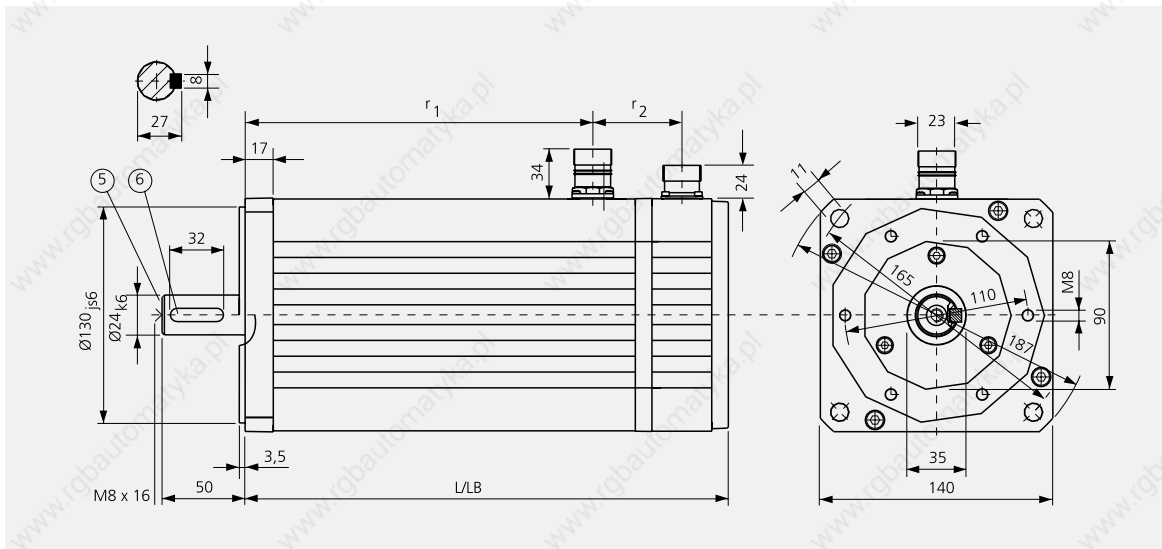

DSM 4-14 High Performance AC synchronous servomotor

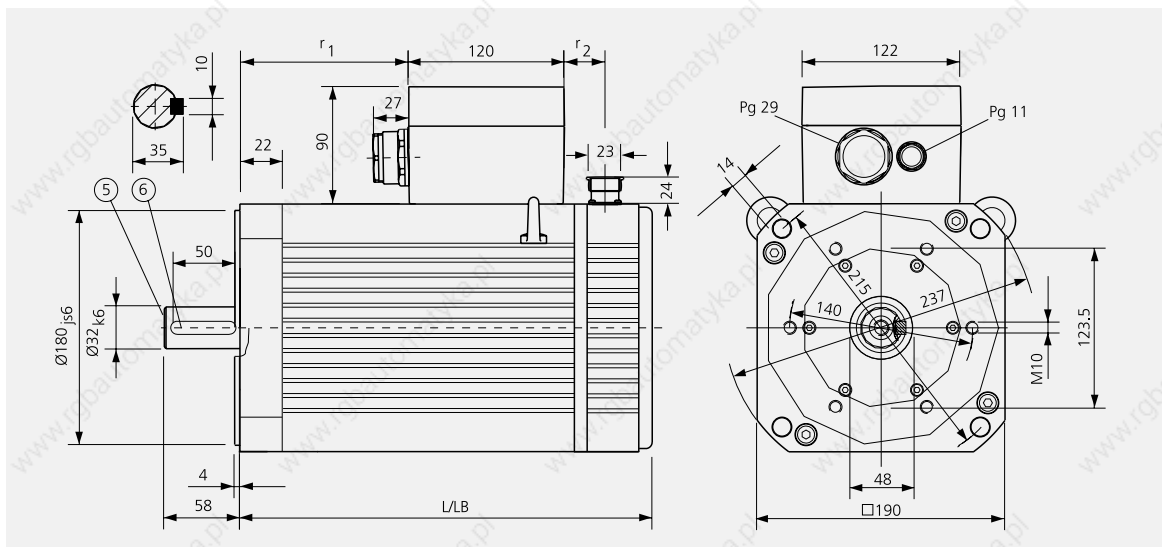

DSM 4-19 High Performance AC synchronous servomotor

- 5 Centre hole
- 6 Featherkey

	L = without brake (n. b.)		LB = with brake (w. b.)		r_1 (n. b.)	r_1 (w. b.)	r_2	Measuring system			
	SinCos®		Resolver					SinCos®		Resolver	
	SinCos®	Resolver	SinCos®	Resolver				SinCos®	Resolver	SinCos®	Resolver
DSM 4-14.1	238 mm	231 mm	283 mm	276 mm	150 mm	195 mm	54 mm	55 mm			
DSM 4-14.2	268 mm	261 mm	313 mm	306 mm	180 mm	225 mm	54 mm	55 mm			
DSM 4-14.3	298 mm	291 mm	343 mm	336 mm	210 mm	255 mm	54 mm	55 mm			
DSM 4-14.4	343 mm	336 mm	388 mm	381 mm	255 mm	300 mm	54 mm	55 mm			
DSM 4-19.1	355 mm	348 mm	355 mm	348 mm	163 mm	163 mm	31 mm	31 mm			
DSM 4-19.2	435 mm	428 mm	435 mm	428 mm	243 mm	243 mm	31 mm	31 mm			

Holding brake

The holding brake is an electromagnetic spring-pressure brake for locking the motor axle after the motor current is shut off. In emergency situations, such as in a power failure or during an EMERGENCY STOP, it shuts down the drive, significantly contributing to overall safety. The motor axle must also be locked for weight-induced torque loads, e.g. in cases of vertical axes in manual mode.

Holding brake controller

The holding brake is controlled via the **Twin Line Holding Brake Controller**, which is available as an accessory.

Caution! Overloading may damage the holding brake! Avoid stationary load torques greater than 25 % of the motor holding torque when using vertical axes with the holding brake.

Technical data of the holding brake for DSM motors

		DSM 4-05	DSM 4-07	DSM 4-09	DSM 4-11	DSM 4-14	DSM 4-19
Holding torque	M_{Br}	2.0 Nm	2.5 Nm	9.0 Nm	11.0 Nm	36.0 Nm	85.0 Nm
Armature inertia	J_{Br}	0.067 kgcm ²	0.380 kgcm ²	0.600 kgcm ²	2.300 kgcm ²	5.900 kgcm ²	17.600 kgcm ²
Electrical pickup power	P_{Br}	12 W	12 W	18 W	21 W	27 W	36 W
Energise time	t_E	25 ms	7 ms	15 ms	20 ms	35 ms	60 ms
De-energise time	t_A	15 ms	5 ms	7 ms	35 ms	50 ms	70 ms
Weight	m_{Br}	0.18 kg	0.30 kg	0.50 kg	0.78 kg	1.63 kg	3.80 kg

Measuring systems

The standard measuring system is the SinCos[®] (SRS) Singleturn. This measuring system is designed to provide optimum performance with our Twin Line family of controllers. You can use the HIPERFACE[®] interface between motor-measuring system and device for a self-initialisation of the motor and current-regulator parameters, considerably simplifying the start-up process.

The SinCos[®] (SRM) Multiturn and Resolver, 2-pin, are optionally available.

Technical data

	SinCos [®] (SRS) Singleturn	SinCos [®] (SRM) Multiturn	Resolver, 2-pin
Resolution with TLx	16384 incr. min ⁻¹	16384 incr. min ⁻¹	4096 incr. min ⁻¹
Precision, integral nonlinearity	± 45 angular seconds	± 45 angular seconds	± 360 angular seconds
Index pulse	–	–	–
Absolute position after activation within [min ⁻¹] with the precision	1 ± 45 angular seconds	4096 ± 45 angular seconds	1 ± 360 angular seconds
Signal form	Sinusoidal/cosinusoidal 1024 cycles min ⁻¹	Sinusoidal/cosinusoidal 1024 cycles min ⁻¹	Sinusoidal/cosinusoidal 1 cycles min ⁻¹
Measuring procedure	High-resolution, optical	High-resolution, optical	Inductive
Interface	HIPERFACE [®]	HIPERFACE [®]	–
Module required on slot 2, TLx	HIFA-C	HIFA-C	RESO-C
Working temperature range	–20 to +115 °C	–20 to +115 °C	–55 to +155 °C

AC synchronous servomotors - High Performance

Type key

Example DSM 4 - X . X - X X X X - X X

Mounting dimensions (flange)

DSM 4 - X . X - X X X X - X X

05 (55 mm) 07 (70 mm)
09 (90 mm) 11 (110 mm)
14 (140 mm) 19 (190 mm)

Length

DSM 4 - X . X - X X X X - X X

1, 2, 3 or 4

Voltage variant

DSM 4 - X . X - X X X X - X X

1 = $U_N = 190$ V, for amplifier with intermediate circuit voltage 270 to 350 VDC
2 = $U_N = 330$ V, for amplifier with intermediate circuit voltage 510 to 690 VDC

Holding brake

DSM 4 - X . X - X X X X - X X

0 = without holding brake
2 = with holding brake

Measuring system/interface

DSM 4 - X . X - X X X X - X X

IB = HIFA-C for SinCos®
R9 = RESO-C for resolver, only for DSM 4-05X

Rated speed

DSM 4 - X . X - X X X X - X X

1 = 1500 rpm, all lengths
3 = 3000 rpm, all lengths
6 = 6000 rpm, not available for all lengths

2 = 2000 rpm, all lengths
4 = 4000 rpm, not available for all lengths

Code for temperature sensors and mounting sockets

DSM 4 - X . X - X X X X - X X

NTC temperature sensor, connection via measuring-system connector, for devices of the Twin Line series

TA = for size/flange: 05/07/19* mounting sockets, straight exit
*except DSM4-19.x, motor connection only via terminal box

6N = for size/flange: 09/11/14 mounting sockets, straight exit

4E = for size/flange: 05/07/09/11/14 mounting sockets 90°, rotating

Measuring system (in conjunction with measuring system/interface)

DSM 4 - X . X - X X X X - X X

G = SinCos® (SRS) Singleturn

H = SinCos® (SRM) Multiturn

Z = resolver 2 pin