

4 PIN SOP PHOTOTRANSISTOR PHOTOCOUPLER EL357N-G Series

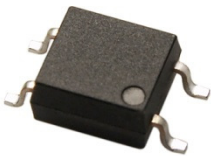

Schematic

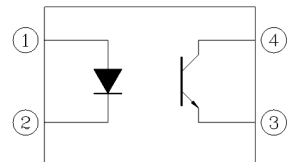

Pin Configuration

1. Anode
2. Cathode
3. Emitter
4. Collector

Features:

- Halogens free
- Current transfer ratio
(CTR: 50~600% at $I_F = 5\text{mA}$, $V_{CE} = 5\text{V}$)
- High isolation voltage between input and output (Viso=3750 V rms)
- Compact 4 Pin SOP with a 2.0 mm profile
- Pb free and RoHS compliant.
- UL approved (No. E214129)
- VDE approved (No. 132249)
- SEMKO approved
- NEMKO approved
- DEMKO approved
- FIMKO approved
- CSA approved (No. 1408633)

Description

The EL357N-G series contains an infrared emitting diode, optically coupled to a phototransistor detector.

The devices in a 4-pin small outline SMD package.

Applications

- DC-DC Converters
- Programmable controllers
- Telecommunication equipments
- Signal transmission between circuits of different potentials and impedances

Absolute Maximum Ratings (Ta=25°C)

| | Parameter | Symbol | Rating | Unit |
|-------------------------|------------------------------------|-----------|------------|-------|
| Input | Forward current | I_F | 50 | mA |
| | Peak forward current (1 us, pulse) | I_{FP} | 1 | A |
| | Reverse voltage | V_R | 6 | V |
| | Power dissipation | P_D | 70 | mW |
| | Derating factor (about Ta=100°C) | | 2.9 | mW/°C |
| Output | Power dissipation | P_C | 150 | mW |
| | Derating factor (above Ta = 70°C) | | 3.7 | mW/°C |
| | Collector current | I_C | 50 | mA |
| | Collector-Emitter voltage | V_{CEO} | 80 | V |
| | Emitter-Collector voltage | V_{ECO} | 7 | V |
| Total Power Dissipation | | P_{TOT} | 200 | mW |
| Isolation Voltage*1 | | V_{ISO} | 3750 | V rms |
| Operating temperature | | T_{OPR} | -55 ~ +110 | °C |
| Storage temperature | | T_{STG} | -55 ~ +125 | °C |
| Soldering Temperature*2 | | T_{SOL} | 260 | °C |

Notes:

*1 AC for 1 minute, R.H.= 40 ~ 60% R.H. In this test, pins 1, 2 are shorted together, and pins 3, 4 are shorted together.

*2 For 10 seconds

Electro-Optical Characteristics (Ta=25°C unless specified otherwise)

Input

| Parameter | Symbol | Min. | Typ. | Max. | Unit | Condition |
|-------------------|----------|------|------|------|---------------|--------------------------|
| Forward voltage | V_F | - | 1.2 | 1.4 | V | $I_F = 20\text{mA}$ |
| Reverse current | I_R | - | - | 10 | μA | $V_R = 4\text{V}$ |
| Input capacitance | C_{in} | - | 30 | 250 | pF | $V = 0, f = 1\text{kHz}$ |

Output

| Parameter | Symbol | Min | Typ. | Max. | Unit | Condition |
|-------------------------------------|------------|-----|------|------|------|---|
| Collector-Emitter dark current | I_{CEO} | - | - | 100 | nA | $V_{CE} = 20\text{V}, I_F = 0\text{mA}$ |
| Collector-Emitter breakdown voltage | BV_{CEO} | 80 | - | - | V | $I_C = 0.1\text{mA}$ |
| Emitter-Collector breakdown voltage | BV_{ECO} | 7 | - | - | V | $I_E = 0.01\text{mA}$ |

Transfer Characteristics (Ta=25°C unless specified otherwise)

| Parameter | Symbol | Min | Typ. | Max. | Unit | Condition |
|--------------------------------------|---------------|--------------------|------|------|---------------|---|
| Current Transfer ratio | EL357N | 50 | - | 600 | % | $I_F = 5\text{mA}, V_{CE} = 5\text{V}$ |
| | EL357NA | 80 | - | 160 | | |
| | EL357NB | 130 | - | 260 | | |
| | EL357NC | 200 | - | 400 | | |
| | EL357ND | 300 | - | 600 | | |
| | EL357NE | 100 | - | 200 | | |
| | EL357NF | 150 | - | 300 | | |
| Collector-Emitter saturation voltage | $V_{CE(sat)}$ | - | 0.1 | 0.2 | V | $I_F = 20\text{mA}, I_C = 1\text{mA}$ |
| Isolation resistance | R_{IO} | 5×10^{10} | - | - | Ω | $V_{IO} = 500\text{Vdc}, 40\sim 60\% \text{ R.H.}$ |
| Floating capacitance | C_{IO} | - | 0.6 | 1.0 | pF | $V_{IO} = 0, f = 1\text{MHz}$ |
| Rise time | t_r | - | 3 | 18 | μs | $V_{CE} = 2\text{V}, I_C = 2\text{mA}, R_L = 100\Omega$ |
| Fall time | t_f | - | 4 | 18 | | |

* Typical values at $T_a = 25^\circ\text{C}$

Typical Electro-Optical Characteristics Curves

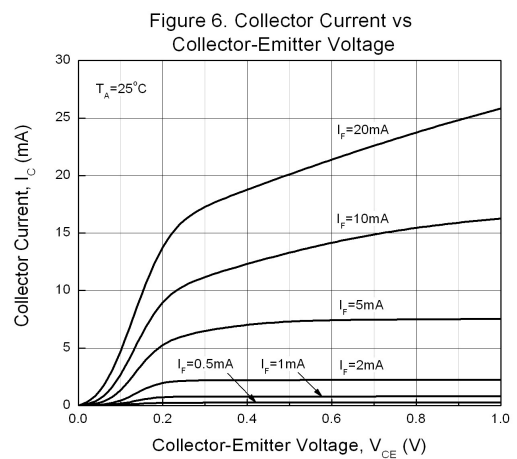
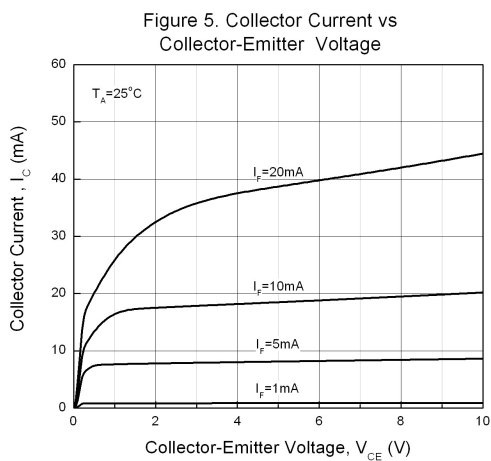
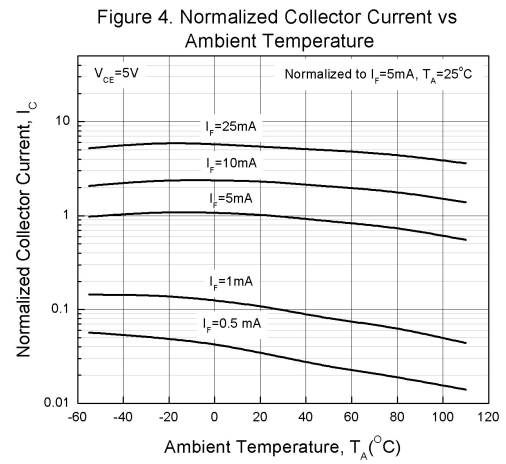
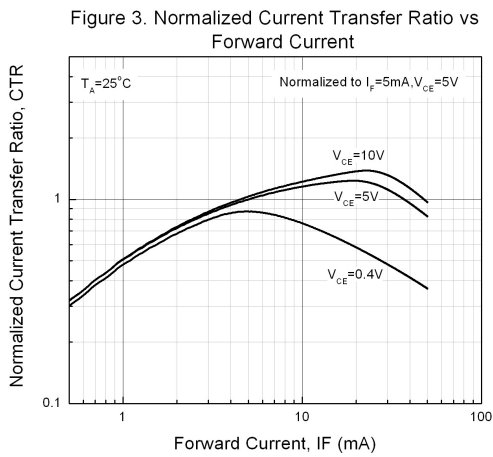
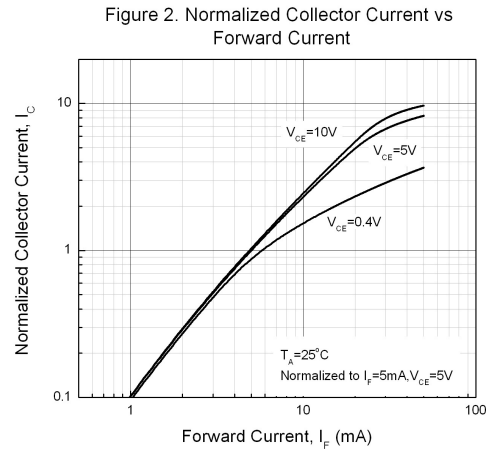
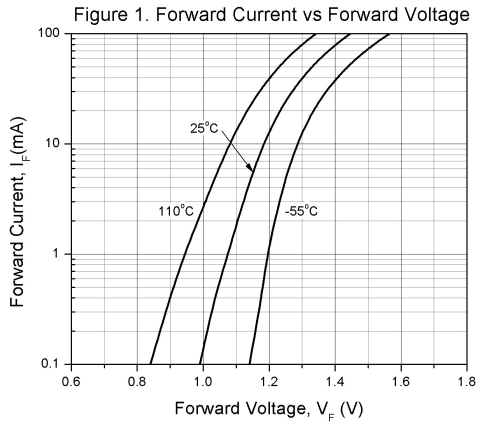

Figure 7. Collector Dark Current vs Ambient Temperature

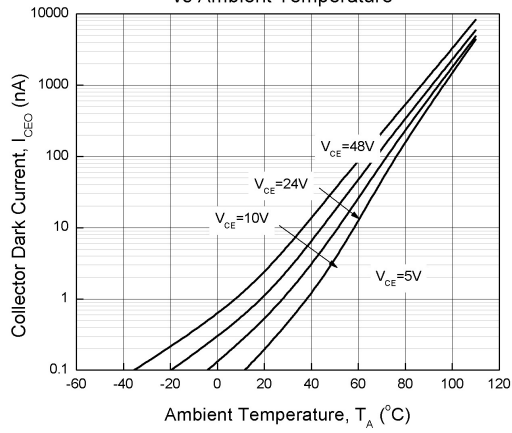

Figure 8. Switching Time vs Load Resistance

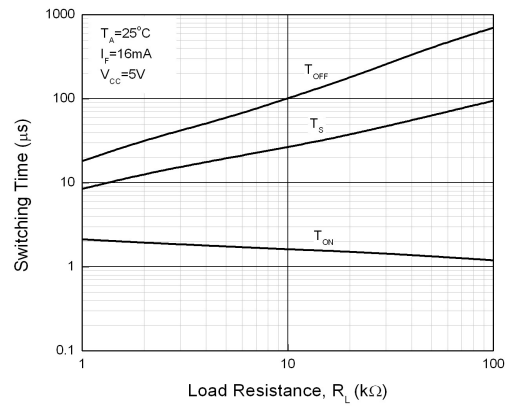

Figure 9. Collector-Emitter Saturation Voltage vs Ambient Temperature

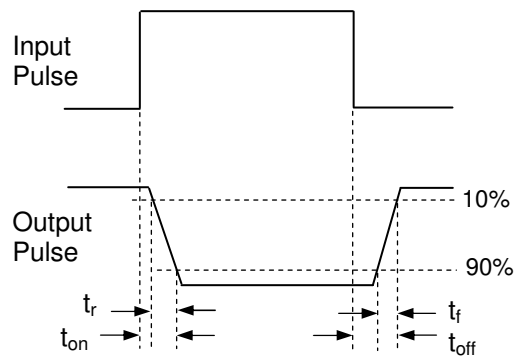
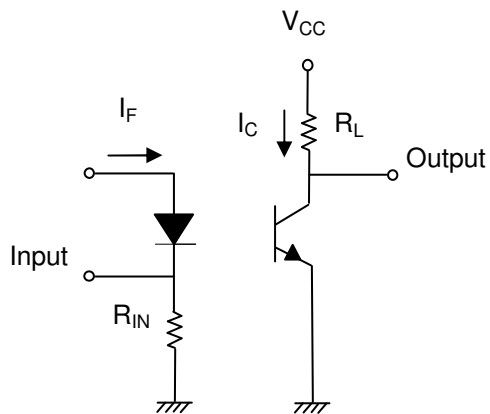
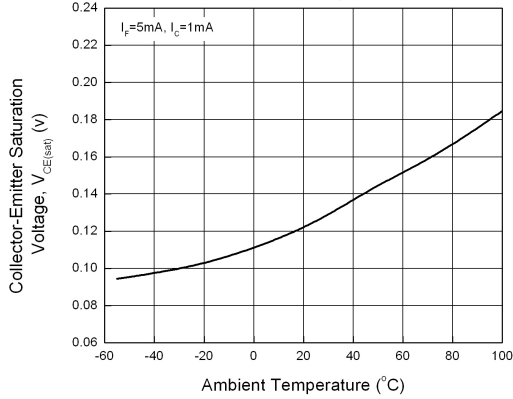

Figure 10. Switching Time Test Circuit & Waveforms

Order Information

Part Number

EL357N(X)(Y)-VG

Note

- X = CTR Rank (A, B, C, D, E, For none)
- Y = Tape and reel option (TA, TB, or none).
- V = VDE (option)
- G = Halogens free

| Option | Description | Packing quantity |
|--------|-----------------------------|---------------------|
| None | Standard SMD option | 100 units per tube |
| -V | Standard SMD option + VDE | 100 units per tube |
| (TA) | TA Tape & reel option | 3000 units per reel |
| (TB) | TB Tape & reel option | 3000 units per reel |
| (TA)-V | TA Tape & reel option + VDE | 3000 units per reel |
| (TB)-V | TB Tape & reel option + VDE | 3000 units per reel |

Package Dimension (Dimensions in mm)

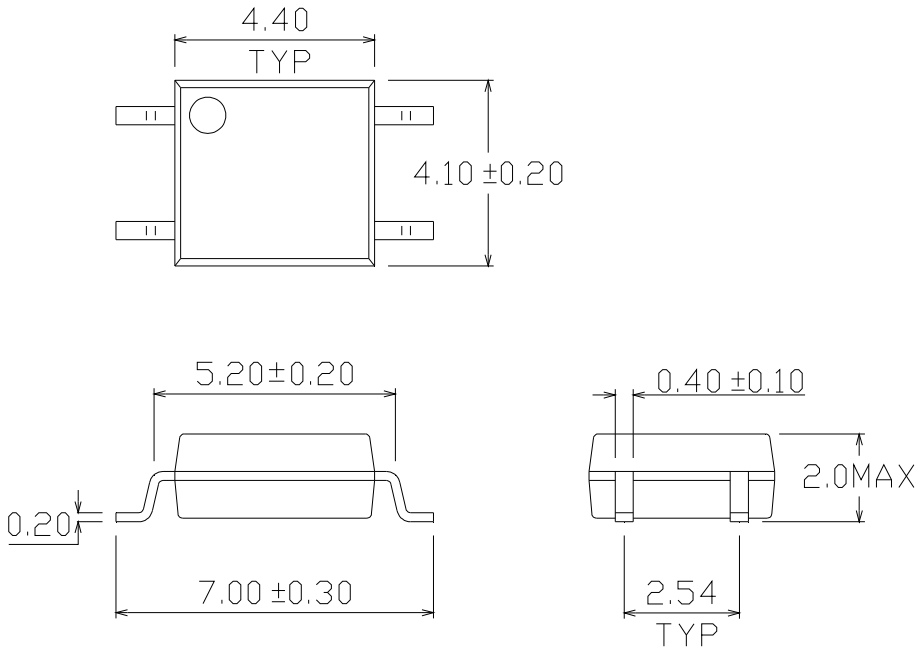

Recommended pad layout for surface mount leadform

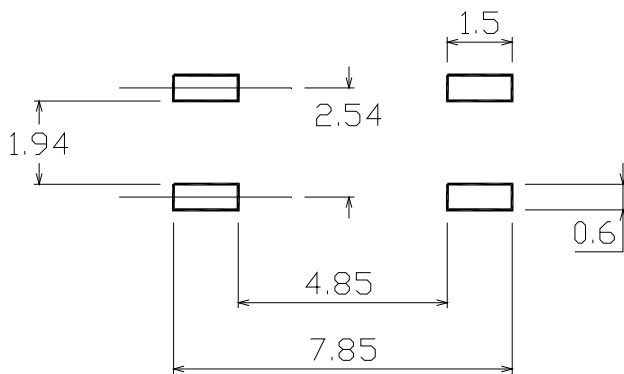

Device Marking



Notes

| | |
|------|---------------------------------|
| EL | denotes Everlight |
| 357N | denotes Device Number |
| R | denotes CTR Rank |
| Y | denotes 1 digit Year code |
| WW | denotes 2 digit Week code |
| V | denotes VDE approved (optional) |

Tape & Reel Packing Specifications

Option TA

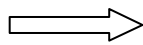
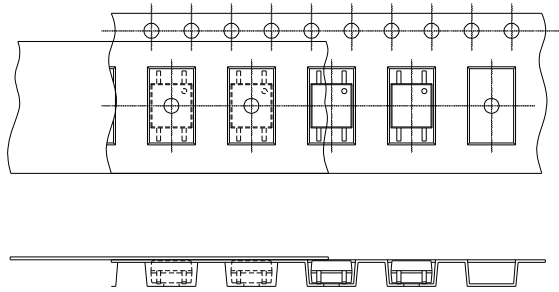

Direction of feed from reel

Option TB

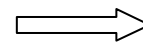
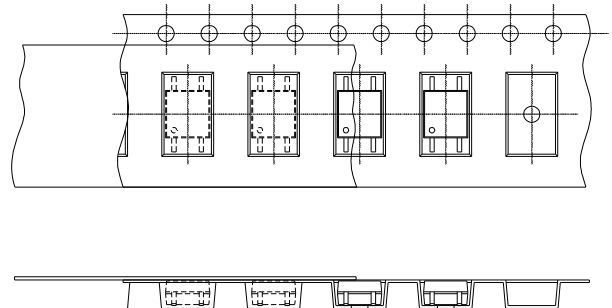

Direction of feed from reel

Tape dimensions

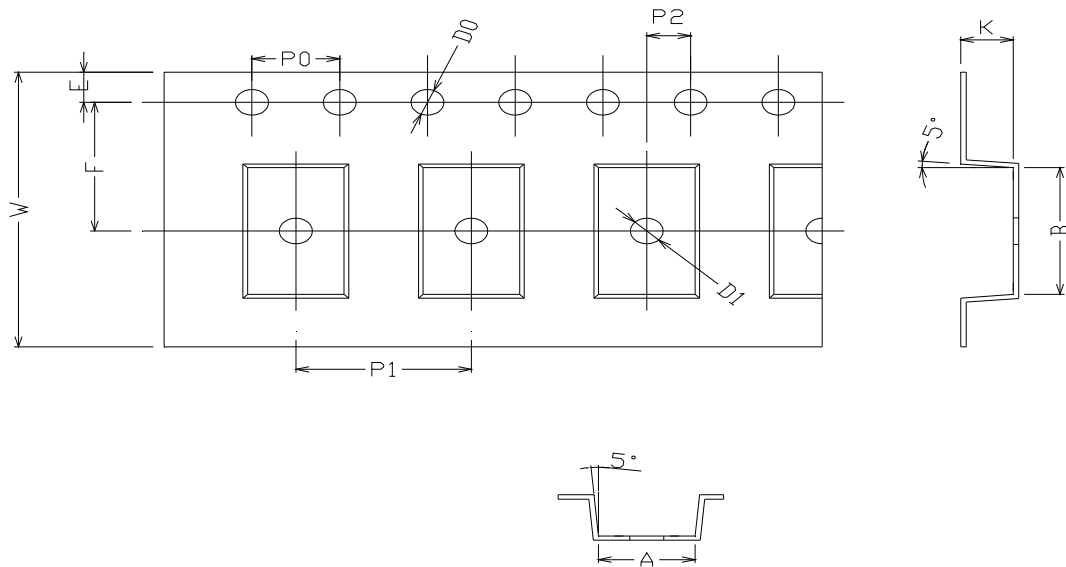

| | | | | | | |
|----------------|------------|-----------|--------------|-------------|------------|-----------|
| Dimension No. | A | B | Do | D1 | E | F |
| Dimension (mm) | 4.4 ± 0.1 | 7.4 ± 0.1 | 1.5 + 0.1/-0 | 1.5 ± 0.1 | 1.75 ± 0.1 | 7.5 ± 0.1 |
| Dimension No. | Po | P1 | P2 | t | W | K |
| Dimension (mm) | 4.0 ± 0.15 | 8.0 ± 0.1 | 2.0 ± 0.1 | 0.25 ± 0.03 | 16.0 ± 0.2 | 2.4 ± 0.1 |

Precautions for Use

1. Soldering Condition

1.1 (A) Maximum Body Case Temperature Profile for evaluation of Reflow Profile

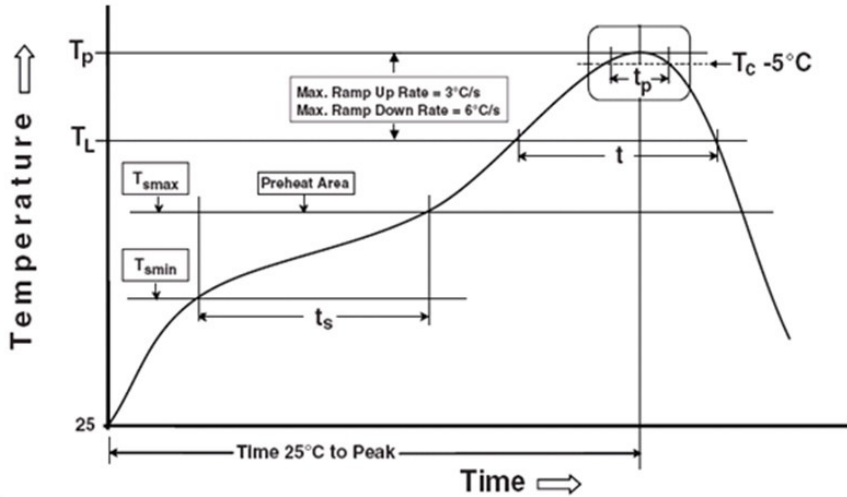

Note:

Reference: IPC/JEDEC J-STD-020D

Preheat

| | |
|--|-----------------|
| Temperature min (T_{smin}) | 150 °C |
| Temperature max (T_{smax}) | 200 °C |
| Time (T_{smin} to T_{smax}) (t_s) | 60-120 seconds |
| Average ramp-up rate (T_{smax} to T_p) | 3 °C/second max |

Other

| | |
|--|-------------------|
| Liquidus Temperature (T_L) | 217 °C |
| Time above Liquidus Temperature (t_L) | 60-100 sec |
| Peak Temperature (T_p) | 260 °C |
| Time within 5 °C of Actual Peak Temperature: $T_p - 5^\circ\text{C}$ | 30 s |
| Ramp- Down Rate from Peak Temperature | 6 °C /second max. |
| Time 25 °C to peak temperature | 8 minutes max. |
| Reflow times | 3 times |

DISCLAIMER

1. Above specification may be changed without notice. EVERLIGHT will reserve authority on material change for above specification.
2. When using this product, please observe the absolute maximum ratings and the instructions for using outlined in these specification sheets. EVERLIGHT assumes no responsibility for any damage resulting from use of the product which does not comply with the absolute maximum ratings and the instructions included in these specification sheets.
3. These specification sheets include materials protected under copyright of EVERLIGHT corporation. Please don't reproduce or cause anyone to reproduce them without EVERLIGHT's consent.

Mouser Electronics

Authorized Distributor

Click to View Pricing, Inventory, Delivery & Lifecycle Information:

[Everlight:](#)

[EL357NC\(TA\)-G](#) [EL357N-G](#)