

Drive System Rexroth IndraDrive

Complete, intelligent and safe



Bosch Rexroth AG dominates in all relevant drive, control and motion technologies worldwide. We offer that vitally important added value in electric drive and control systems – regardless of where you are located and what you want to automate!



Contents

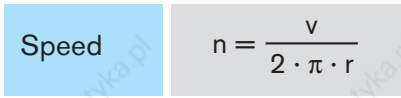
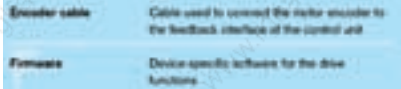
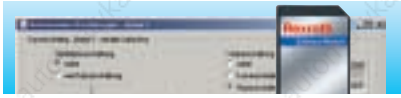

| | |
|---------------------------|-----------|
| Drive expertise | 4 |
| | 01 |
| System overview | 10 |
| | 02 |
| Selection guide | 12 |
| | 03 |
| Power units | 14 |
| | 04 |
| Control units | 32 |
| | 05 |
| Motor-integrated drives | 46 |
| | 06 |
| Firmware | 52 |
| | 07 |
| Motion-Logic | 54 |
| | 08 |
| Safety technology | 56 |
| | 09 |
| Engineering and operating | 60 |
| | 10 |
| Motors and gearboxes | 64 |
| | 11 |
| Auxiliary components | 96 |
| | 12 |
| Glossary | 118 |
| | 13 |
| Formulas | 120 |
| | 14 |
| Additional information | 122 |
| | 15 |

Speed

$$n = \frac{v}{2 \cdot \pi \cdot r}$$

Innovative drives – driving innovation

Rexroth drives have played a pioneering role in the automation industry for many years. Motivation and commitment continue to drive our efforts to maintain our technology leadership.

We keep our ears to the ground to constantly stay in tune with the latest trends in production automation. Based on the information we collect, we develop tomorrow's drive solutions for the production floor. An uncompromising focus on the needs of our customers enables us to drive innovation forward in the machine building and mechanical engineering industry.

We have repeatedly played a pioneering role in the industry. One example of the contributions which we have made to drive technology is the maintenance-free servo motor. The advantages of this technology are so fundamental that it ushered in a new generation of products throughout the mechanical engineering industry starting with transfer machines in the automotive industry. Other milestones include the first main spindle drive with positioning capability and distributed automation solutions with intelligent digital drives for modular machine design.

Linear motor technology is another ultra-modern and innovative field where Rexroth is a leader and can demonstrate more experience than any other company in the world.

Currently, one issue of vital importance is drive-integrated safety technology.

Rexroth has proven time and again that, in the long run, innovation and market success go hand in hand. Over one million Rexroth drives are in use around the world in a wide and diverse range of applications.

Rexroth IndraDrive, the latest generation of drives, and Rexroth IndraDyn, the complete range of motors, are the result of Rexroth's

dedication to innovation in drive technology.

With their fully-integrated platform, innovative safety technology and intelligent functions, Rexroth IndraDrive and IndraDyn are predestined for both intelligent single-axis and complex multiple-axis applications. This innovation in drive technology will set market trends again – to benefit all users.



Innovative integration – Rexroth Automation House

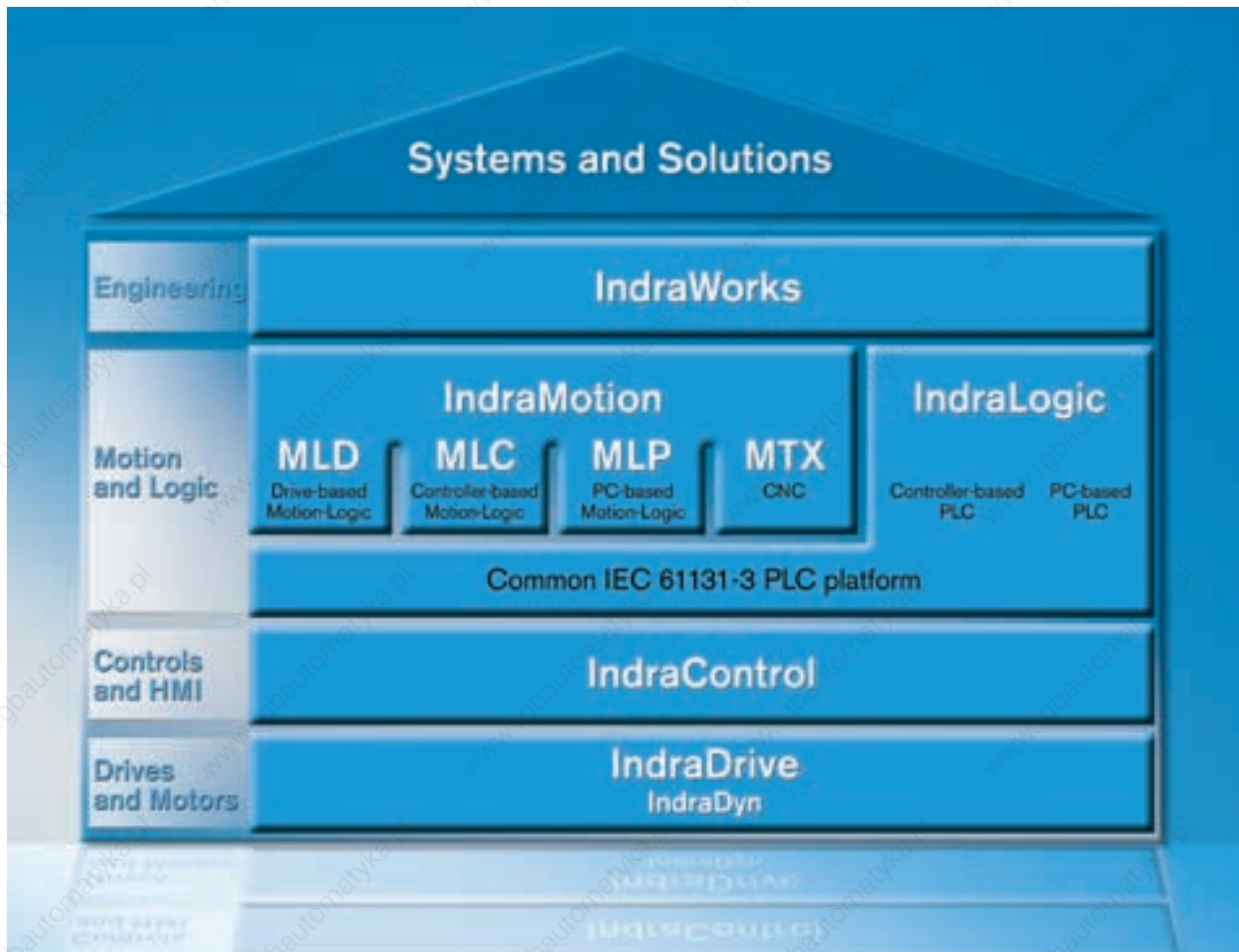

Our Automation House is a unique modular toolkit which gives you everything you need to create leading-edge automation solutions. From drive and control systems to the high-performance software framework for standardized engineering and user-friendly operation. This innovation gives you all the privileges associated with modern automation technology – integration, intelligence and investment for the future.

IndraDrive and IndraDyn

The intelligent drive solution and comprehensive range of motors for maximum dynamics

IndraControl

The standardized control and visualization hardware platform for increased transparency in production

IndraLogic

The IEC-compliant PLC solution for intelligent automation

IndraMotion

The scalable system software platform for high-performance motion control applications

IndraWorks

The integrated engineering software package for project planning, programming, visualization and diagnostics

Rexroth IndraDrive and Rexroth IndraDyn cause a stir in the drive market

This new design is redefining standards in drive technology.

Complete in terms of hardware and software, safe in terms of application and intelligent in terms of functionality:

With IndraDrive and IndraDyn you will benefit from the economic, intelligent and future-assured approach to your automation tasks – regardless of your industry!

It is the combination of three features which gives IndraDrive its unique and pioneering edge:

- Inclusive platform
- Integrated intelligence
- Innovative safety concept

When it comes to practical applications, IndraDrive offers many advantages such as:

- Safety on Board conforming to EN 954-1, Category 3, for safe stop and safe motion
- Wide power range from 1 kW to 120 kW

- Internationally standardized interfaces
- Integrated Motion Logic, with IEC 61131-3 compliant PLC
- Highest performance and precision
- Scalable power and functionality
- Direct mains connection
- Energy-saving power recovery

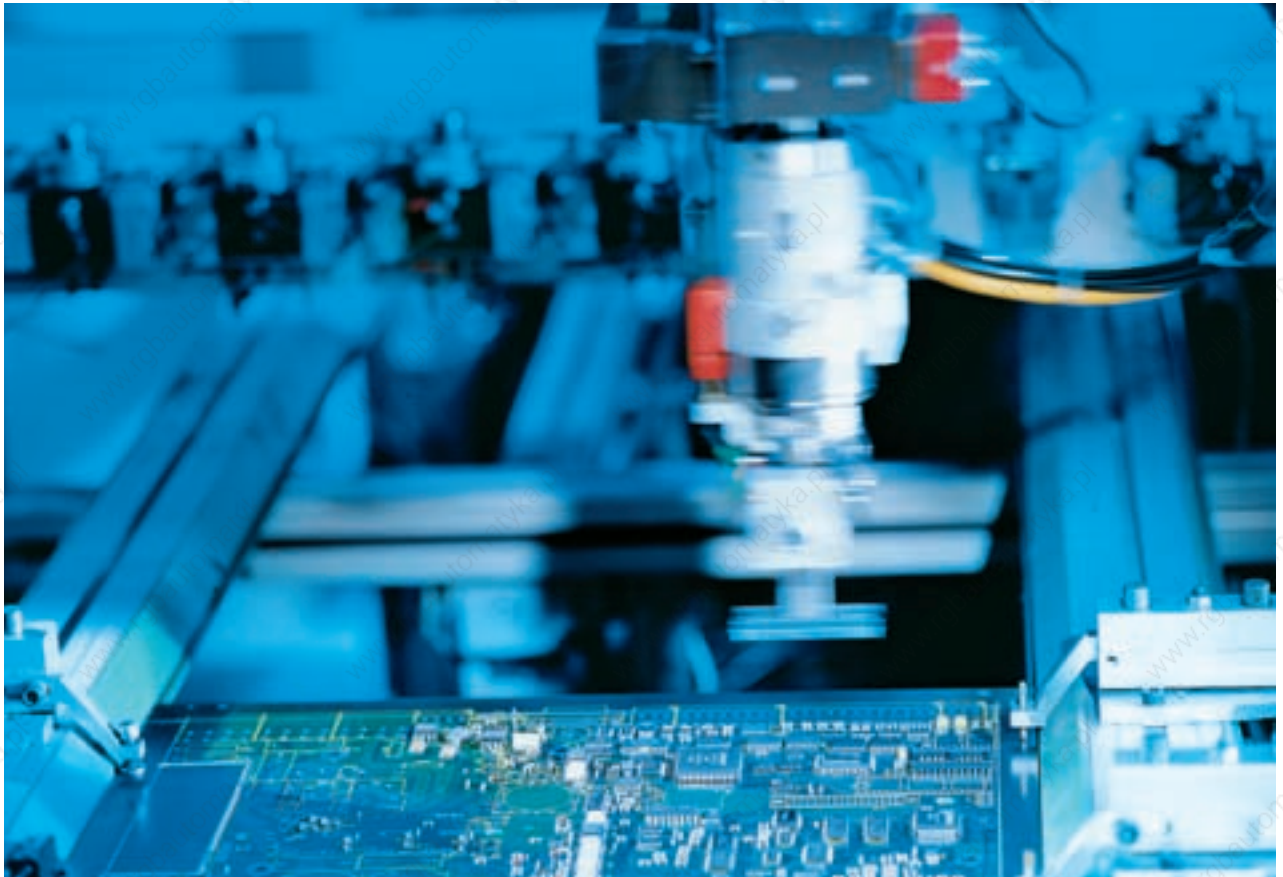



IndraDrive has the power to convince

No matter what demands you make on your drive – IndraDrive offers an impressive array of key benefits:

- Integrated hardware platform
- Scalable functionality
- Unique safety concept

Your benefits

Safety on board

Safety technology certified to EN 954-1, Category 3, protects machine operators while the drives are in motion. In contrast to conventional safety designs, there is no longer any need for motor contactors, additional speed monitors or frequent power shutdown using the line contactor.

Integrated Motion Logic with IEC 61131-3 compliant PLC

Motion Logic with IEC 61131-3 compliant PLC can be integrated as an optional feature that consistently applies open standards. This makes it easier to bring in customer know-how and saves on higher-level control systems and personnel training courses.

Integrated technology functions

The technology functions can be configured on the basis of Motion Logic to perform a wide and diverse range of process-oriented tasks. This does not require any programming knowledge whatsoever on the user's part.

Open interfaces

Internationally recognized interfaces are available for communicating with higher-level machine control systems: SERCOS, PROFIBUS DP, PROFINet IO, CANopen, DeviceNet, analog and parallel.

A single software for all tasks

The engineering software framework, IndraWorks, carries you through all the steps involved in project planning, programming, parameterization, operation and diagnostics.

A unique platform

In the interests of meeting your individual requirements, we have developed two versions of IndraDrive:

- IndraDrive C – Compact converters
- IndraDrive M – Modular inverters

Particularly economic drive solutions can be derived from the common control units and the combination of different versions.

A complete range of motors

The newly developed generation of IndraDyn motors meets all the requirements of modern factory automation through its diversity of design and unique performance:

- Synchronous and asynchronous servo motors which are more compact and more powerful
- Servo motors designed for potentially explosive areas – conforming to ATEX and UL/CSA
- Synchronous and asynchronous motors for high-speed applications such as motor spindles

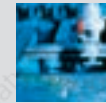

Automation

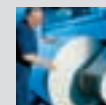

Printing and converting machines

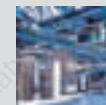

Conveying and storage systems

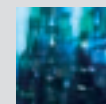

Glass processing machines

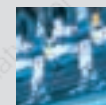

Handling and assembly systems



Woodworking machines

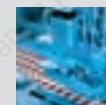

Plastics processing machines

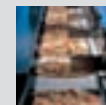

Food processing and packaging machines

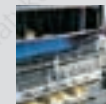

Textile machines

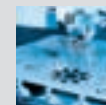

Metal forming

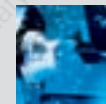

Machine tools

Introducing the new IndraDrive system

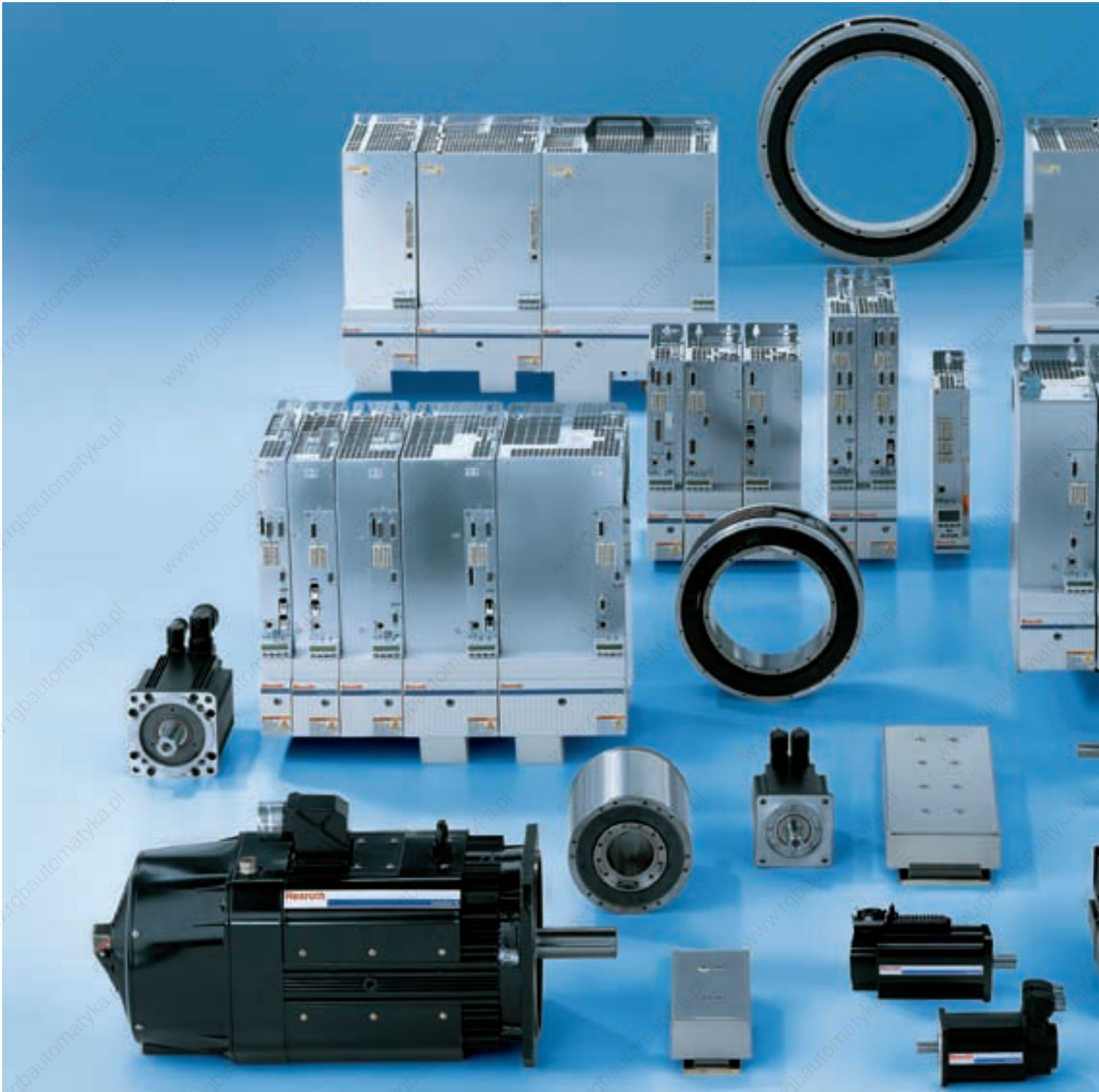

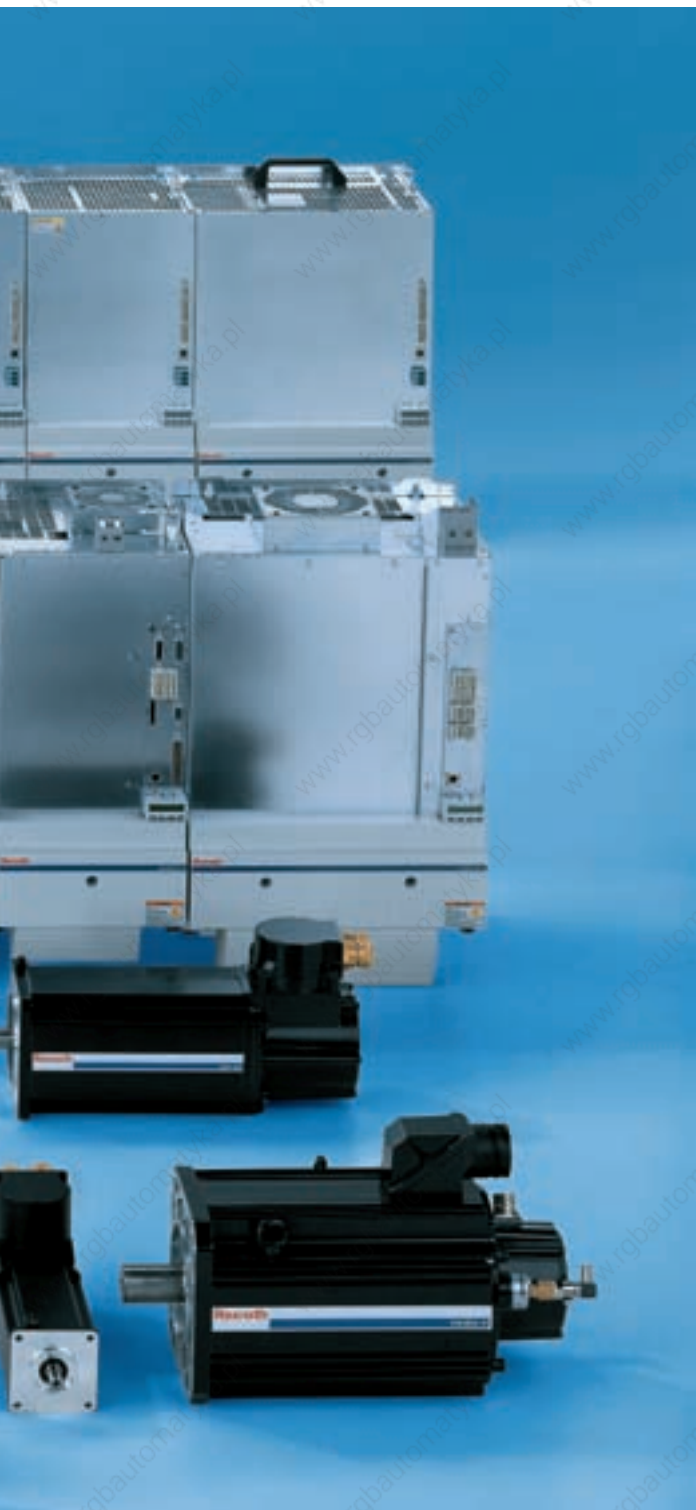

IndraDrive stands for innovation all along the line. Therefore, choosing the new drive generation from Rexroth means that your every wish will be fulfilled.

Main features of the IndraDrive:

- Compact converters and modular inverters on one platform
- Ultra-compact drive unit consisting of control unit and servo motor
- Integrated Motion Logic with IEC-compliant PLC
- Drive-integrated safety technology
- Intelligent technology functions
- Integrated engineering framework for project planning, programming, operation and diagnostics
- Complete range of synchronous and asynchronous motors

Leaving nothing to be desired: Rexroth IndraDrive – the complete system

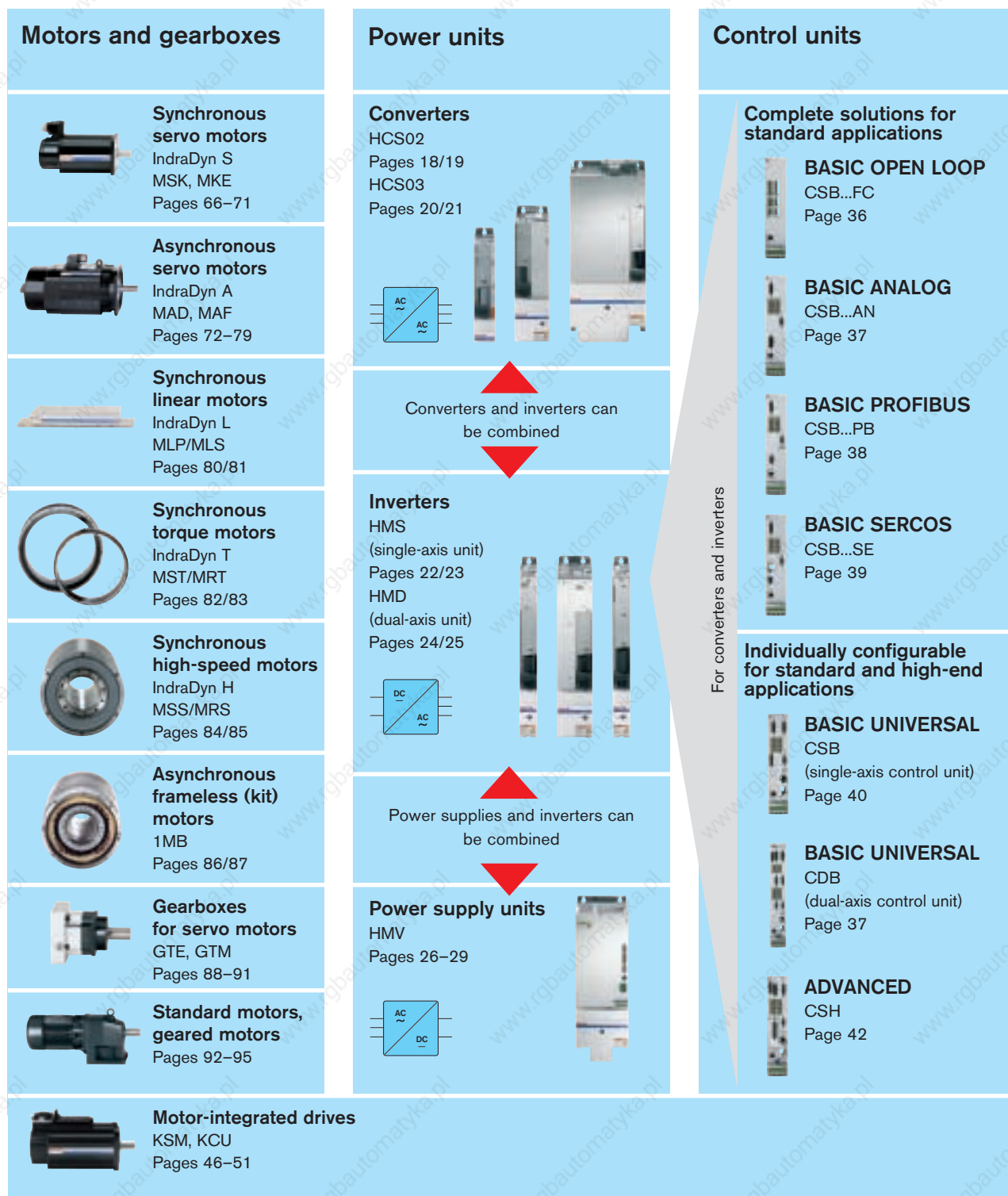

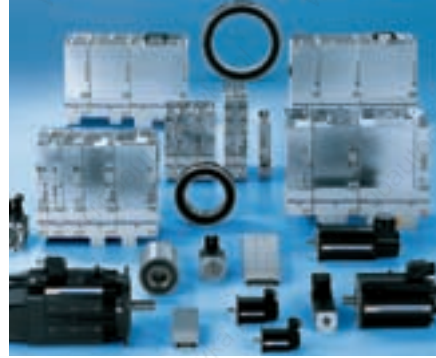

Seamlessly coordinated

- | Integrated system
- | Scalable power
- | Flexible function blocks
- | Open communications standards
- | Future-proof

Your benefits

Firmware

Basic package

**OPEN LOOP /
CLOSED LOOP**

The basic package contains all the functions for standard applications.

Extension packages

SERVO

Frictional torque compensation and compensation for backlash on reversal, axis and encoder error correction, touch probe, etc.

SYNCHRONIZATION

Electronic gears, electronic cam plate, etc.

MAIN SPINDLE

Spindle positioning, gear change, etc.

IndraMotion MLD

Motion Logic conforming to IEC 61131-3

**Technology packages
based on IndraMotion MLD**

Productivity Agent (predictive maintenance), function blocks, demand processing, special cam groups, extended drive function, PLCopen library, etc.

Pages 52/53

Engineering and operation



Operation panels
VCP, VCH, VEP
Page 43



Software module
PFM
Page 43

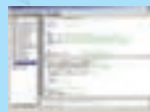

IndraWorks
Engineering software framework for start-up, programming, etc.
Pages 60/61

Cables

Power cables
RKL
Page 116



Encoder cables
RKG
Page 116



Fiber optic cables, bus connectors, etc.



Hybrid cable, terminal connector
RKH
Page 51



Auxiliary components

Mains filters
HNF, NFD
Page 98



Mains filters, mains choke
HNK
Page 99



Mains chokes
HNL
Pages 100/101



Motor filters
HMF
Page 102



Brake resistors
HLR
Pages 103–105



Brake units
HLB
Page 106



Capacity module
HLC
Page 107



Blower unit
HAB
Page 108



Five steps to your drive solution



| Step | Example | Help |
|--|---|--|
| 1 Determine your drive requirements <ul style="list-style-type: none"> • Torque, speed, power ... • Performance (control quality ...) • Interfaces, functions • Single-axis or multi-axis drive | Servo drive for a handling axis <ul style="list-style-type: none"> • RMS torque 4.5 Nm • Maximum torque 8 Nm • Speed 2,500 rpm • PROFIBUS interface • Simple servo functionality | Drive sizing program IndraSize Pages 62/63 |
| 2 Select the power unit/motor combination | IndraDrive C with IndraDyn S HCS02.1E-W0028-A-03-NNNN MSK050C-0300-NN-S1-UG0-NNNN <ul style="list-style-type: none"> • Standstill torque 5 Nm • Maximum torque 9 Nm • Maximum speed 3,000 rpm | Power units Pages 14–31 Motors Pages 64–95 Motor-integrated drives Pages 46–51 |
| 3 Identify the control unit performance and interfaces <ul style="list-style-type: none"> • Higher-level control system • Encoder • Inputs and outputs • Safety technology | BASIC PROFIBUS CSB01.1N-PB-ENS-NNN-NN-S-NN-FW <ul style="list-style-type: none"> • Standard performance • PROFIBUS • IndraDyn standard encoder • Standard operator panel • No additional options | Control units Pages 32–45 |
| 4 Define the firmware function <ul style="list-style-type: none"> • Basic OPEN LOOP or CLOSED LOOP package • Extension packages • Motion Logic • Technology functions | Basic CLOSED LOOP package FWA-INDRV*-MPB-03VRS-D5-1-NNN-NN <ul style="list-style-type: none"> • No extension packages | Firmware Pages 52/53 |
| 5 Select the accessories <ul style="list-style-type: none"> • Mains filters and mains chokes • Brake resistors, brake units • Capacity modules • Cables • Software | Mains filter NFD03.1-480-016 Power cable RKL4302/005,0 Encoder cable RKG4200/005,0 Basic accessories HAS01.1-065-NNN-CN Shield connection HAS02.1-002-NNN-NN Software SWA-IWORKS-D**-xxVRS-D0-CD650-COPY | Auxiliary components Pages 96–117 Engineering software toolkit IndraWorks Pages 60/61 |

Rexroth IndraDrive – power units





Customized for the desired number of axes and performance level

- Wide power range – for all applications
- Converters and inverters can be combined – ideal for small axis groups
- Power supplies and inverters can be combined – ideal for large axis groups

Your benefits

IndraDrive C – compact converters

- Power range from 1.5 kW to 75 kW with maximum current from 12 A to 210 A
- High overload capacity
- Compact design for single-axis applications
- Can be connected to inverters for cost-effective solutions
- Direct mains connection from 200 V to 500 V

IndraDrive M – modular inverters

- Single-axis inverter with maximum current from 20 A to 350 A
- Dual-axis inverter with maximum current from 12 A to 36 A
- Space-saving design for multi-axis applications
- Can be powered via power supply unit or converter
- Energy exchange via common DC bus
- Can be connected to converters for cost-effective solutions

IndraDrive M – modular power supplies

- Power range from 15 kW to 120 kW
- Direct mains connection from 400 V to 480 V
- Energy-saving line regeneration
- Integrated mains contactor
- Integrated brake resistor

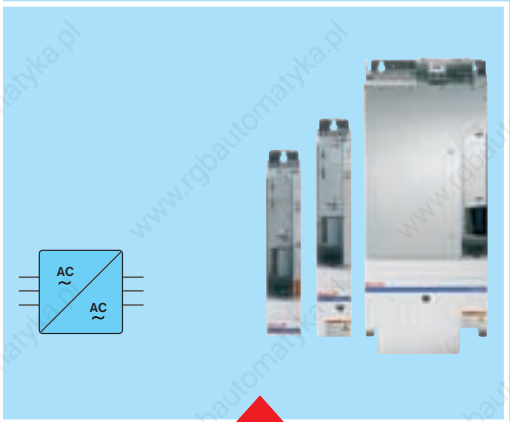

Converters and inverters can be combined

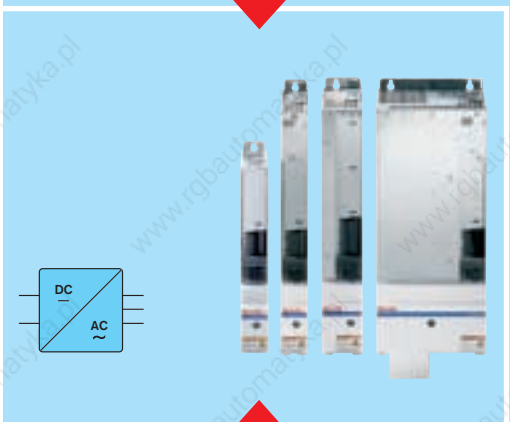

Power supplies and inverters can be combined

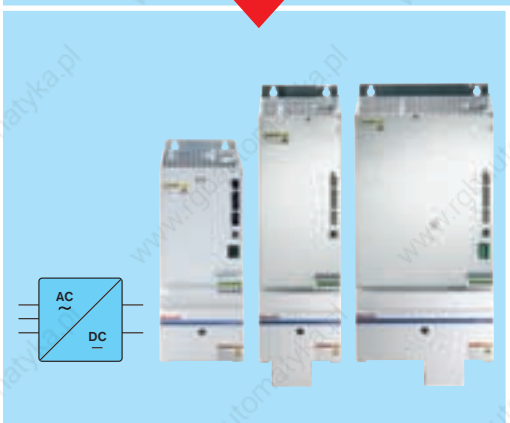

IndraDrive – the clever combination of power units

Single-axis solution with a converter

The IndraDrive C series of converters integrate inverter and power supply in one unit. The compact construction contains additional mains connection components, making it particularly suitable for single-axis applications.



Multi-axis solution with converters and inverters

A combination of IndraDrive C converters and modular IndraDrive M inverters is a particularly cost-effective solution for small axis groups.

The converter for the first axis supplies the inverters of the other axes at the same time. In this case, a converter with sufficient power reserve must be selected in order to be able to supply the smaller inverters as well.

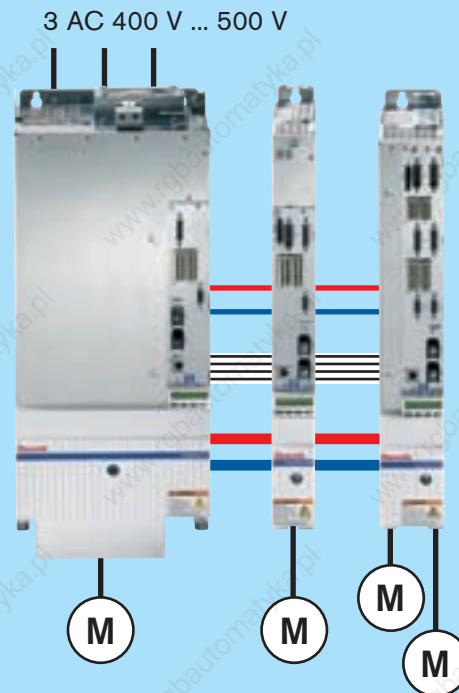

Multi-axis solution with power supplies and inverters

Multi-axis applications are the domain of the modular system IndraDrive M. Power supplies provide the necessary DC bus voltage for the inverters. Compact single-axis or dual-axis inverters and power supplies with integrated mains connection components enable compact solutions for large axis groups.

Maximum energy efficiency can be achieved with power supplies that are capable of mains regeneration. Besides the power recovery encountered in regenerative operation of the drives, another outstanding feature of these devices is the closed-loop DC bus.

3 AC 400 V ... 480 V

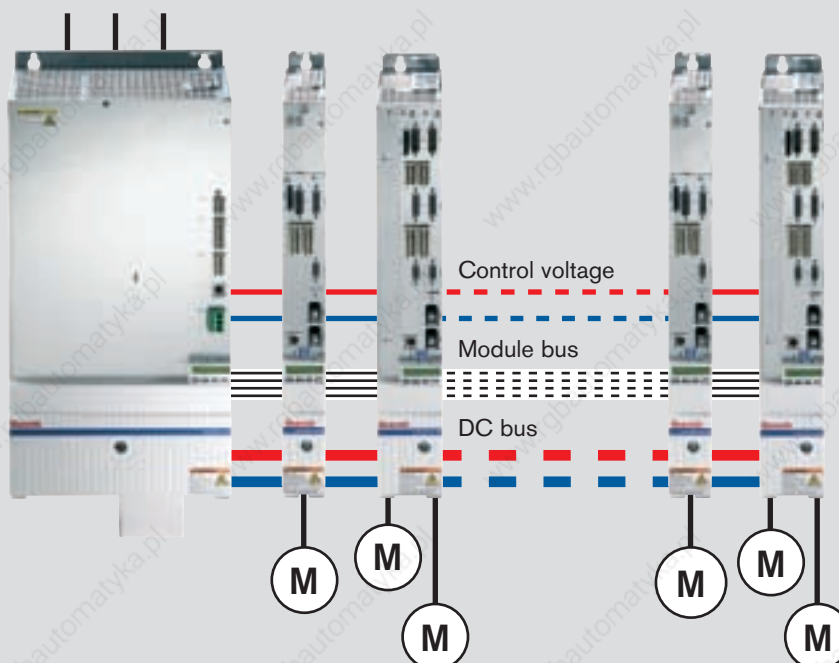

| Power units | | IndraDrive C | | IndraDrive M | | |
|---|--------|--|-------------------------------------|------------------------|----------------------------------|--------------------------------------|
| | | Converter | Converter | Inverter | Power supply units | |
| | | HCS02 | HCS03 | HMS01/HMS02 HMD01 | infeed HMV01.1E | regenerative HMV01.1R HMV02.1R |
| Mains voltage | V | 1 AC 200 ... 250 V 3 AC 200 ... 500 V (±10 %) | 3 AC 400 ... 500 V (+10 %/-15 %) | - | 3 AC 400 ... 480 V (+10 %/-15 %) | |
| Supply frequency | Hz | 48 ... 62 | | - | 48 ... 62 | |
| DC bus continuous power | kW | 2.1 ... 14 | 13 ... 85 | - | 18 ... 120 | |
| Continuous mechanical power ¹⁾ | kW | 1.5 ... 11 | 11 ... 75 | 1.5 ... 75 | - | |
| Overload capacity | | 2.5x | 1.5 ... 2x | 1.5 ... 2.5x | 1.5x | 1.5 ... 2.5x |
| Switching frequency/ max. output frequency | kHz/Hz | - | | - | - | |
| | | 4/400 | | 4/400 | - | |
| | | 8/800 | | 8/800 | - | |
| | | 12/1,200 | | 12/1,200 ²⁾ | - | |
| | | 16/1,600 | | 16/1,600 ²⁾ | - | |
| Output voltage | V | 0 ... 335 (at DC bus voltage DC 475 V) 0 ... 400 (at DC bus voltage DC 570 V) 0 ... 530 (at DC bus voltage DC 750 V) | | - | | |
| Suitable for cabinet depth | mm | 300 | 400 | HMx01: 400/HMx02: 300 | | |
| Mains contactor | | external | | - | internal ³⁾ | |
| Brake chopper | | internal | | - | internal ³⁾ | |
| Brake resistor | | internal (optional external) | external | - | internal ³⁾ | |
| Converter/inverter combination | | yes | yes | yes | - | |
| Control voltage DC 24 V | | external (optional internal) | internal or external | external | | |
| Protection mode | | IP20 | | | | |
| Installation height | m | 1,000 over NN, with derating to 4,000 | | | | |
| Ambient temperature | °C | 0 ... +40, with derating to +55 | | | | |
| Relative air humidity | % | 5 ... 95 (as per EN 61800-5-1), condensation not permitted | | | | |
| Degree of contamination | | 2 (as per EN 61800-5-1) | | | | |
| Cooling system | | Air cooling | | | | |
| CE-mark | | Complies with the low voltage directive 73/23/EEC and the EMC directive 89/336/EEC | | | | |
| Certification | | UL, cUL | | | | |
| EMC | | as EN 61800-3 | | | | |

All data for nominal rating at 3 AC 400 V mains voltage and 4 kHz switching frequency

¹⁾ applies to S1 mode on 4-pole standard motors 3 AC 400 V/50 Hz at 4 kHz switching frequency and a rotary frequency > 4 Hz

²⁾ HMD01 and HMS02.1N-W0028 up to 8 kHz/800 Hz only

³⁾ not applicable for HMV01.1R-W0120

IndraDrive C – compact converters HCS02

| Models with integrated control voltage supply no additional options | Converters | | | | |
|---|----------------|---|----------------|-------------------|-------------------|
| | HCS02.1E-W0012 | HCS02.1E-W0028 | HCS02.1E-W0054 | HCS02.1E-W0070 | |
| | -A-03-NNNV | -A-03-NNNV | -A-03-NNNV | -A-03-NNNV | |
| | | | | | |
| | | | | | |
| Performance data | | | | | |
| Continuous current | A | 4.5 | 11.3 | 20.6 | 28.3 |
| Maximum current | A | 11.5 | 28.3 | 54 | 70.8 |
| DC bus continuous power without/with choke | kW | 2.1/2.1 | 5.1/5.1 | 7/10 | 9/14 |
| Maximum output without/with choke | kW | 5/5 | 8/10 | 12/16 | 14/19 |
| Mains voltage | V | 3 AC 200 ... 500, 1 AC 200 ... 250 ($\pm 10\%$) | | | |
| Continuous input mains current | A | 6 | 13 | 19 | 30 |
| Dependence of output on mains voltage | | at $U_{LN} < 400$ V: 1 % power reduction per 4 V at $U_{LN} > 400$ V: 1 % power gain per 5 V | | | |
| DC bus terminal ¹⁾ | | – | ● | ● | ● |
| DC bus capacity | μ F | 135 | 270 | 405 | 675 |
| Brake resistor | | | | | |
| Brake resistor | | internal | internal | internal/external | internal/external |
| Maximum braking energy consumption | kWs | 1 | 5 | 9 | 13 |
| Continuous braking power | kW | 0.05 | 0.15 | 0.35/3.8 | 0.5/5.5 |
| Maximum braking power | kW | 4 | 10 | 18 | 25 |
| Control voltage data | | | | | |
| Control voltage, internal | V | DC 24 (not for supply of motor holding brake) | | | |
| Control voltage, external | V | DC 24 $\pm 20\%$ (DC 24 $\pm 5\%$ when supplying motor holding brake) | | | |
| Power consumption without control unit and motor brake | W | 12 | 14 | 23 | 23 |
| Continuous current without control unit and motor brake | A | 0.5 | 0.6 | 1.0 | 1.0 |
| Mechanical data | | | | | |
| Width W | mm | 65 | 65 | 105 | 105 |
| Height H | mm | 290 | 352 | | |
| Depth D (incl. plug) | mm | 265 | | | |
| Mass | kg | 2.9 | 3.8 | 6.7 | 6.8 |

All data apply to nominal rating at 3 AC 400 V mains voltage and 4 kHz switching frequency

¹⁾for the connection of additional units, such as HMS, HCS, HLB, HLC

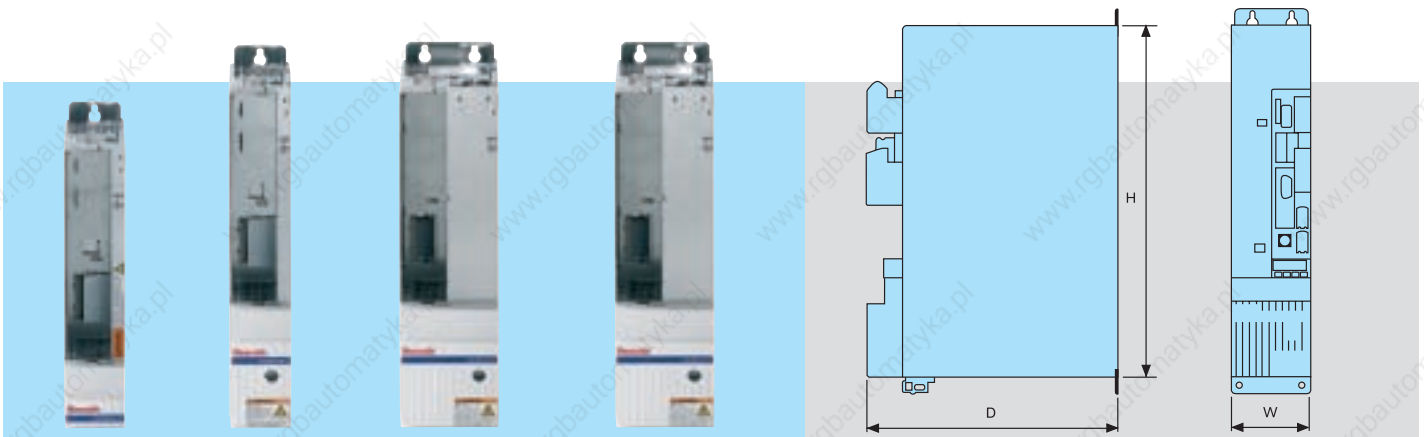

HCS02

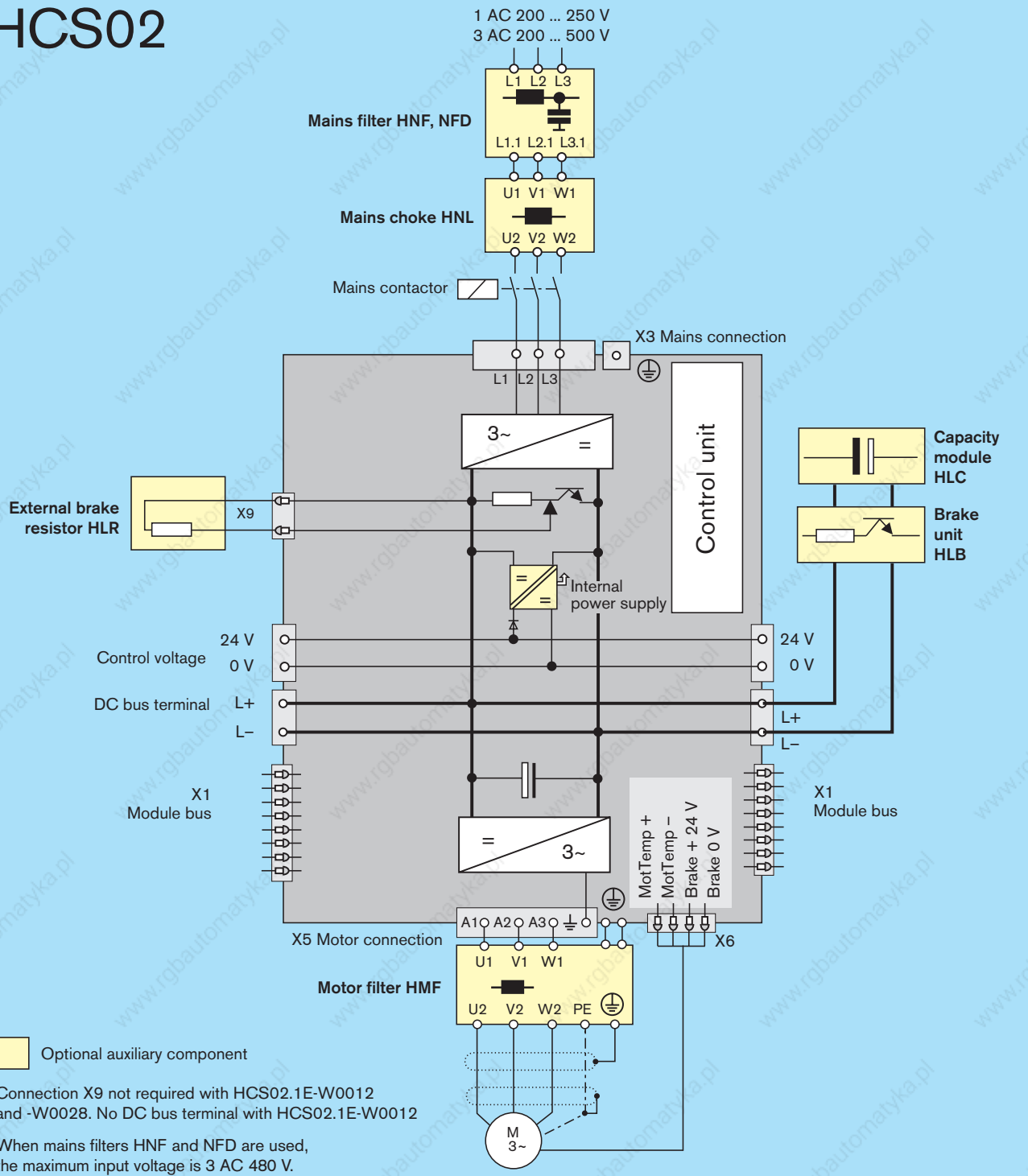

Optional auxiliary component

Connection X9 not required with HCS02.1E-W0012 and -W0028. No DC bus terminal with HCS02.1E-W0012

When mains filters HNF and NFD are used, the maximum input voltage is 3 AC 480 V.

IndraDrive C – compact converters HCS03

| Models | Converters | | | |
|---|--------------------|--------------------|--------------------|--------------------|
| | HCS03.1E- W0070 | HCS03.1E- W0100 | HCS03.1E- W0150 | HCS03.1E- W0210 |
| with integrated control voltage supply | -A-05-NNNV | -A-05-NNNV | -A-05-NNNV | -A-05-NNNV |
| with integrated brake chopper and integrated control voltage | -A-05-NNBV | -A-05-NNBV | -A-05-NNBV | -A-05-NNBV |

| Performance data | | | | | |
|---|----|--|-------|-------|--------|
| Continuous current | A | 45 | 73 | 95 | 145 |
| Maximum current | A | 70 | 100 | 150 | 210 |
| DC bus continuous power without/with choke | kW | 13/25 | 24/42 | 34/56 | 42/85 |
| Maximum output without/with choke | kW | 20/40 | 33/59 | 54/89 | 68/124 |
| Mains voltage | V | 3 AC 400 ... 500 (+10 %/-15 %) | | | |
| Continuous inout mains current | A | 50 | 80 | 106 | 146 |
| Dependence of output mains voltage | | at $U_{LN} < 400$ V: 1 % power reduction per 4 V decrease in voltage | | | |
| DC bus terminal ¹⁾ | | ● | ● | ● | ● |
| DC bus capacity | μF | 940 | 1,440 | 1,880 | 4,700 |
| Brake chopper | | | | | |
| Continuous brake power | kW | 13.2 | 18.9 | 25.2 | 42.6 |
| Maximum brake power | kW | 42 | 63 | 97 | 137 |
| Control voltage data | | | | | |
| Control voltage, internal | V | DC 24 (not for supply of motor holding brake) | | | |
| Control voltage, external | V | DC 24 ± 20 % (DC 24 ± 5 % when supplying motor holding brake) | | | |
| Power consumption without control unit and motor brake | W | 22.5 | 25 | 25 | 30 |
| Continuous current without control unit and motor brake | A | 0.9 | 1.0 | 1.0 | 1.3 |
| Mechanical data | | | | | |
| Width W | mm | 125 | 225 | 225 | 350 |
| Height H | mm | 440 | 440 | 440 | 440 |
| Depth D | mm | 309 | | | |
| Mass | kg | 13 | 20 | 20 | 38 |

All data apply to nominal rating at 3 AC 400 V mains voltage and 4 kHz switching frequency

¹⁾ for the connection of additional units, such as HMS, HCS, HLB, HLC



HCS03

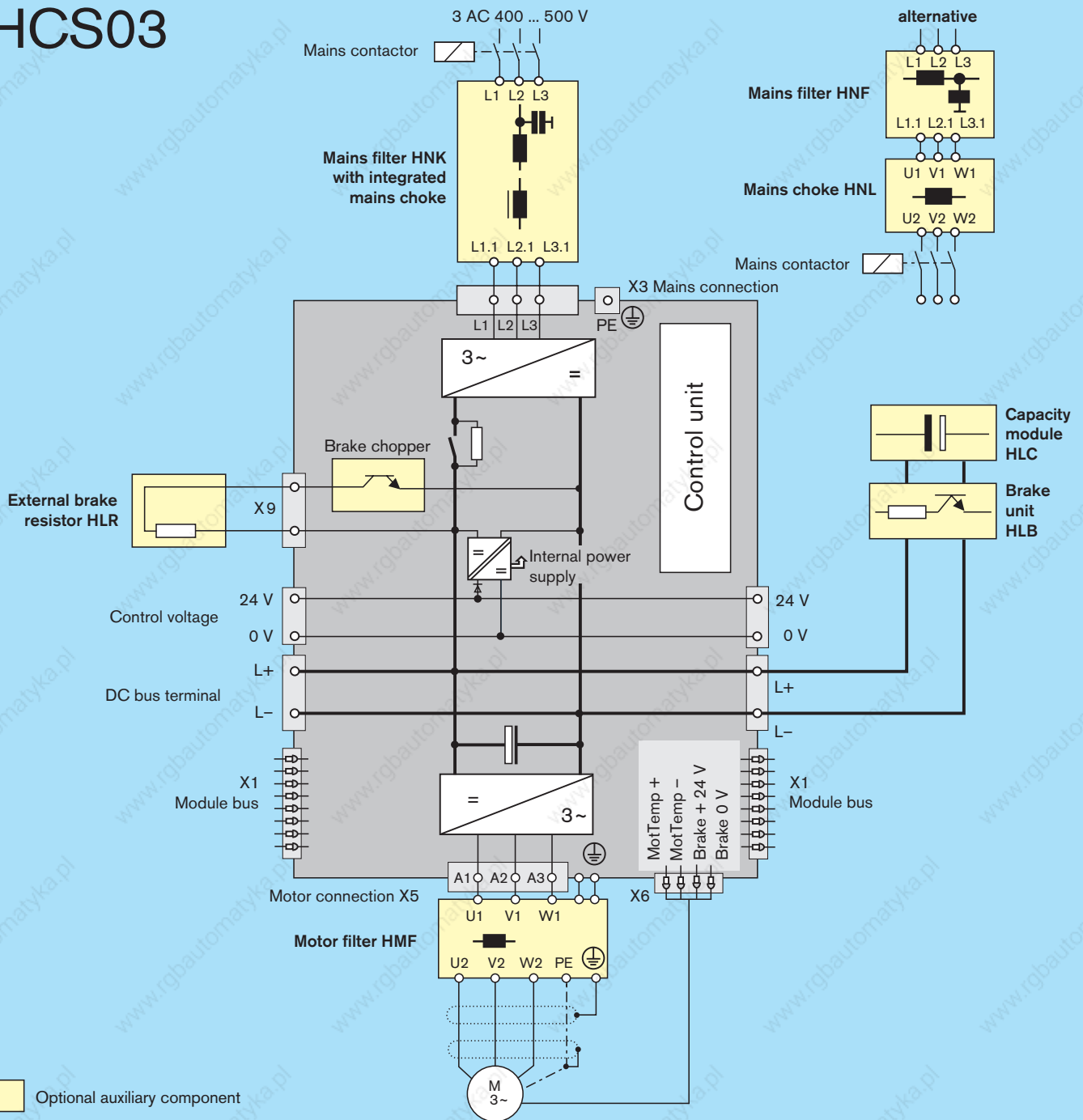

 Optional auxiliary component

Mains choke always required with HCS03.1E-W0210

When HNF mains filters are used, the maximum input voltage is 3 AC 480 V.

IndraDrive M – modular single-axis inverter HMS01 and HMS02

| | | Single-axis inverters | | | | | | | | | | |
|---|----|---|----------------------------------|----------------------------------|----------------------------------|----------------------------------|----------------------------------|----------------------------------|----------------------------------|----------------------------------|----------------------------------|--|
| Models | | HMS01.1N- W0020-A- 07-NNNN | HMS01.1N- W0036-A- 07-NNNN | HMS01.1N- W0054-A- 07-NNNN | HMS01.1N- W0070-A- 07-NNNN | HMS01.1N- W0110-A- 07-NNNN | HMS01.1N- W0150-A- 07-NNNN | HMS01.1N- W0210-A- 07-NNNN | HMS01.1N- W0350-A- 07-NNNN | HMS02.1N- W0028-A- 07-NNNN | HMS02.1N- W0054-A- 07-NNNN | |
| no additional options | | | | | | | | | | | | |
| Performance data | | | | | | | | | | | | |
| Continuous current | A | 12.1 | 21.3 | 35 | 42.4 | 68.5 | 100 | 150 | 250 | 13.8 | 25 | |
| Maximum current | A | 20 | 36 | 54 | 70 | 110 | 150 | 210 | 350 | 28 | 54 | |
| Control voltage data | | | | | | | | | | | | |
| Control voltage external | V | DC 24 ± 20 % (DC 24 ± 5 % when supplying motor holding brake) | | | | | | | | | | |
| Power consumption without control unit and motor brake | W | 10 | 16 | 10 | 16 | 34 | 23 | 75 | 218 ¹⁾ | 13 | 17 | |
| Continuous current without control unit and motor brake | A | 0.4 | 0.7 | 0.4 | 0.7 | 1.4 | 1.0 | 3.1 | 9.1 | 0.5 | 0.7 | |
| Mechanical data | | | | | | | | | | | | |
| Width W | mm | 50 | 50 | 75 | 100 | 125 | 150 | 200 | 350 | 50 | 75 | |
| Height H | mm | 440 | | | | | | | | | 352 | |
| Depth D | mm | 309 | | | | | | | | | 265 | |
| Mass | kg | 5.3 | 5.3 | 6.7 | 7.9 | 11.0 | 12.7 | 18.4 | 31.7 | 3.5 | 5.0 | |

All data apply to nominal rating at 3 AC 400 V mains voltage and 4 kHz switching frequency

¹⁾including auxiliary filter HAB



HMS01

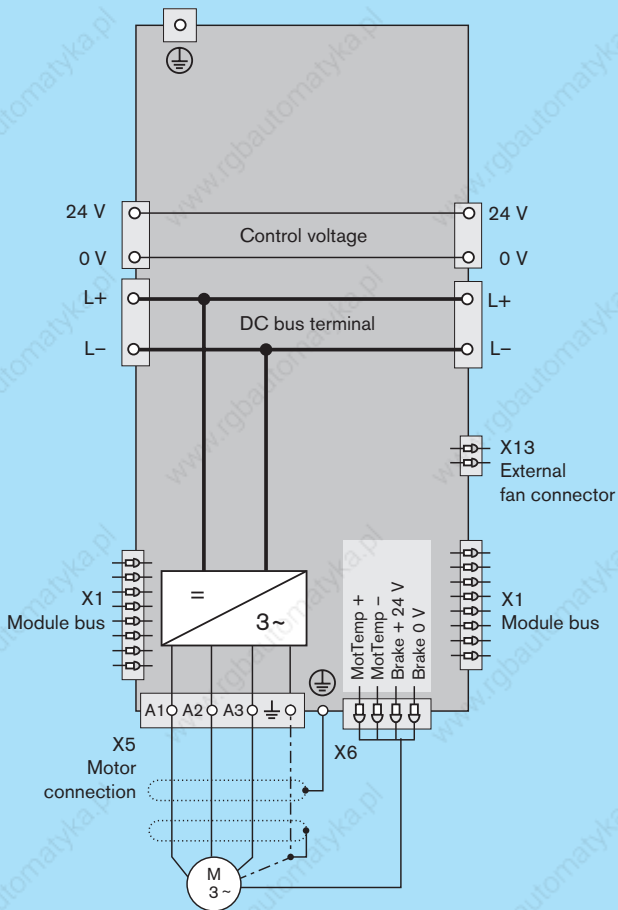

Connection X13 on HMS01.1N-W350 only

HMS02

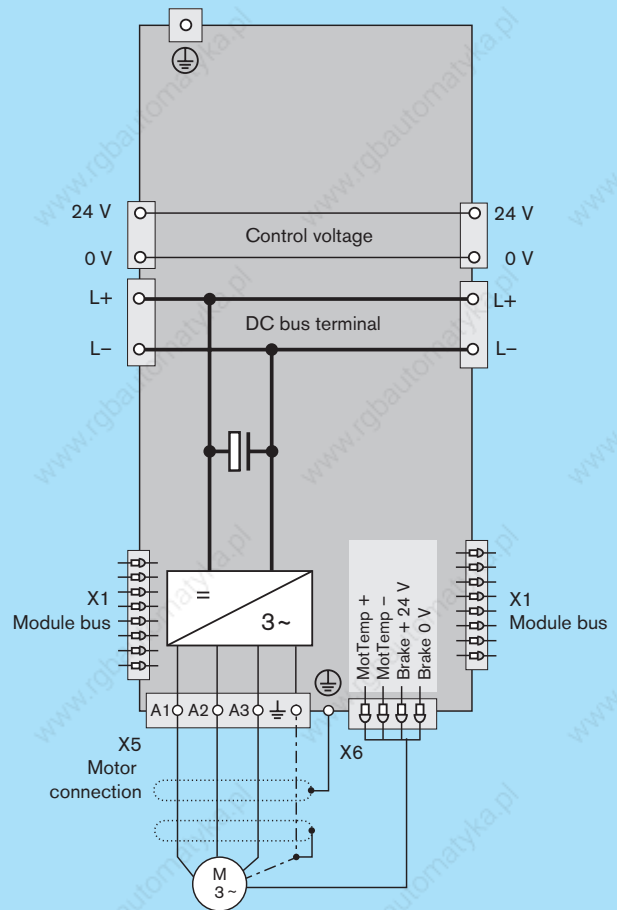

IndraDrive M – modular double-axis inverter HMD01

| | | Double-axis inverter | | |
|---|----|---|----------------------------------|----------------------------------|
| Model | | HMD01.1N- W0012-A- 07-NNNN | HMD01.1N- W0020-A- 07-NNNN | HMD01.1N- W0036-A- 07-NNNN |
| no additional options | | | | |
| Performance data | | | | |
| Continuous current | A | 7 | 10 | 20 |
| Maximum current | A | 12 | 20 | 36 |
| Control voltage data | | | | |
| Control voltage external | V | DC 24 ± 20 % (DC 24 ± 5 % when supplying motor holding brake) | | |
| Power consumption without control unit and motor brake | W | 17 | 17 | 11 |
| Continuous current without control unit and motor brake | A | 0.7 | 0.7 | 0.5 |
| Mechanical data | | | | |
| Width W | mm | 50 | 50 | 75 |
| Height H | mm | 440 | | |
| Depth D | mm | 309 | | |
| Mass | kg | 5.5 | 5.7 | 7.5 |

All data apply to nominal rating at 3 AC 400 V mains voltage and 4 kHz switching frequency

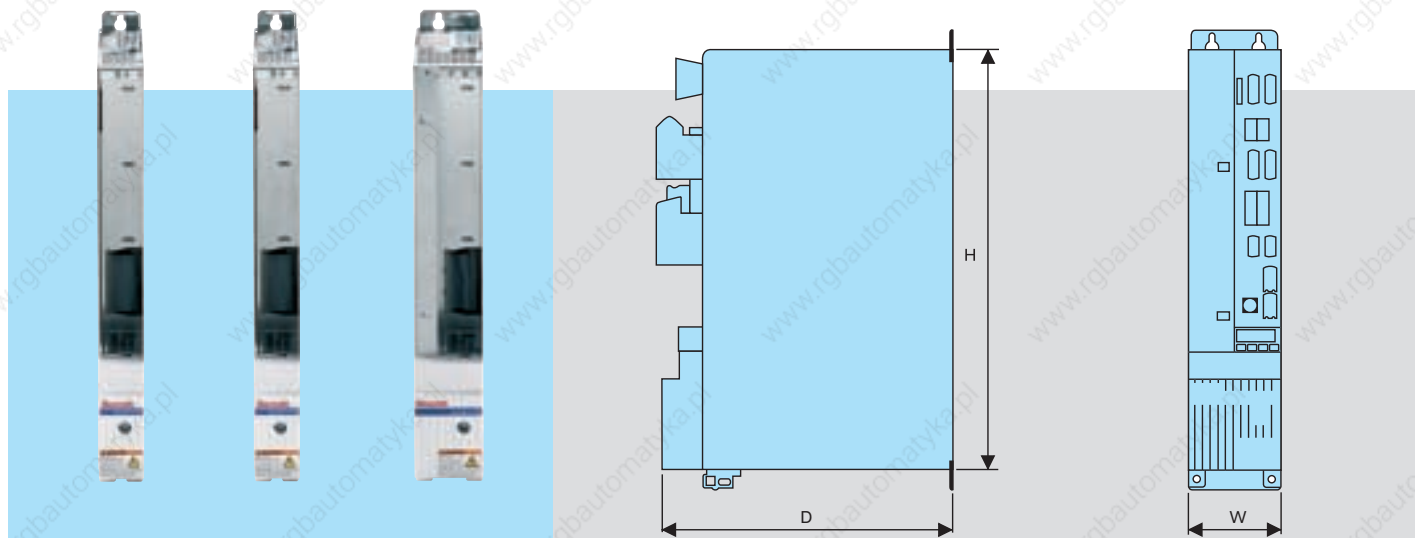

HMD01

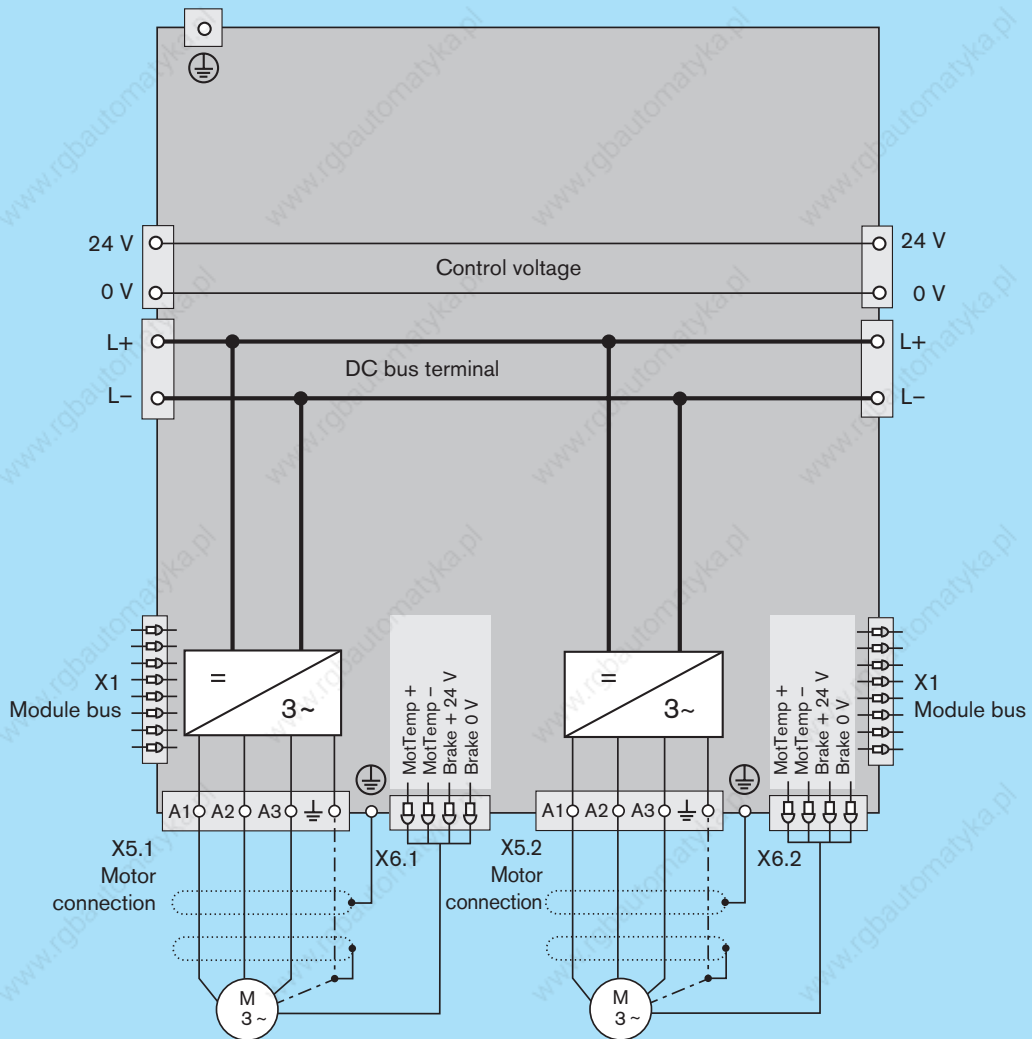

IndraDrive M – modular power supplies HMV01

| Models | Infeed modules | | | Regenerative modules | | | | | | |
|--|---------------------|--|---------------------|----------------------|------------------------------------|---------------------|---------------------|---------------------|----------|--|
| | HMV01.1E-W0030-A-07 | HMV01.1E-W0075-A-07 | HMV01.1E-W0120-A-07 | HMV01.1R-W0018-A-07 | HMV01.1R-W0045-A-07 | HMV01.1R-W0065-A-07 | HMV01.1R-W0120-A-07 | HMV02.1R-W0015-A-07 | | |
| no additional options | -NNNN | -NNNN | -NNNN | -NNNN | -NNNN | -NNNN | -NNNN | -NNNN | | |
| Performance data | | | | | | | | | | |
| DC bus continuous power without/with choke | kW | 18/30 | 45/75 | 72/120 | -/18 | -/45 | -/65 | -/120 | -/15 | |
| Maximum output | kW | 45 | 112 | 180 | 45 | 112 | 162 | 180 | 29 | |
| Mains voltage | V | 3 AC 400 ... 480 (+10/-15 %) | | | | | | | | |
| Continuous input mains current | A | 51 | 125 | 200 | 26 | 65 | 94 | 181 | 23 | |
| Dependence of output on mains | | at $U_{LN} < 400$ V: 1 % power reduction per 4 V | | | | | | | | |
| | | at $U_{LN} > 400$ V: 1 % power gain per 4 V | | | at $U_{LN} > 400$ V: no power gain | | | | | |
| DC bus capacity | μ F | 1,410 | 3,760 | 5,640 | 705 | 1,880 | 2,820 | 4,950 | 700 | |
| DC bus voltage range | V | DC 435 ... 710 | | | DC 750 (regulated) | | | | | |
| Brake resistor | | | | | | | | | | |
| Brake resistor | | internal | | | | | | external | internal | |
| Maximum braking energy consumption | kWs | 100 | 250 | 500 | 80 | 100 | 150 | - | 40 | |
| Continuous braking power | kW | 1.5 | 2.0 | 2.5 | 0.4 | 0.4 | 0.4 | - | 0.3 | |
| Maximum braking power | kW | 36 | 90 | 130 | 36 | 90 | 130 | - | 33 | |
| Control voltage data | | | | | | | | | | |
| Control voltage, external | V | DC 24 ± 5 % | | | | | | | | |
| Power consumption | W | 25 | 30 | 55 | 31 | 41 | 108 | 224 ¹⁾ | 27 | |
| Continuous current | A | 1.0 | 1.3 | 2.3 | 1.3 | 1.9 | 4.5 | 13.0 ¹⁾ | 1.1 | |
| Mechanical data | | | | | | | | | | |
| Width W | mm | 150 | 250 | 350 | 175 | 250 | 350 | 350 | 150 | |
| Height H | mm | 440 ²⁾ | | | | | | | 352 | |
| Depth D (incl. plug) | mm | 309 | | | | | | | 265 | |
| Mass | kg | 13.5 | 22 | 32 | 13.5 | 20 | 31 | 34.5 | 9.5 | |

In the case of the HMV01.1R the continuous output and maximum output data also apply feedback mode.

All data apply to nominal rating at 3 AC 400 V mains voltage

Connection option for auxiliary components, such as HLB, HLC etc.

¹⁾ including auxiliary filter HAB

²⁾ overall height HMV01.1R-W0120 with auxiliary fan HAB: 748 mm



HMV01

HMV01.1E-W0030
 HMV01.1E-W0075
 HMV01.1E-W0120
 HMV01.1R-W0018
 HMV01.1R-W0045
 HMV01.1R-W0065

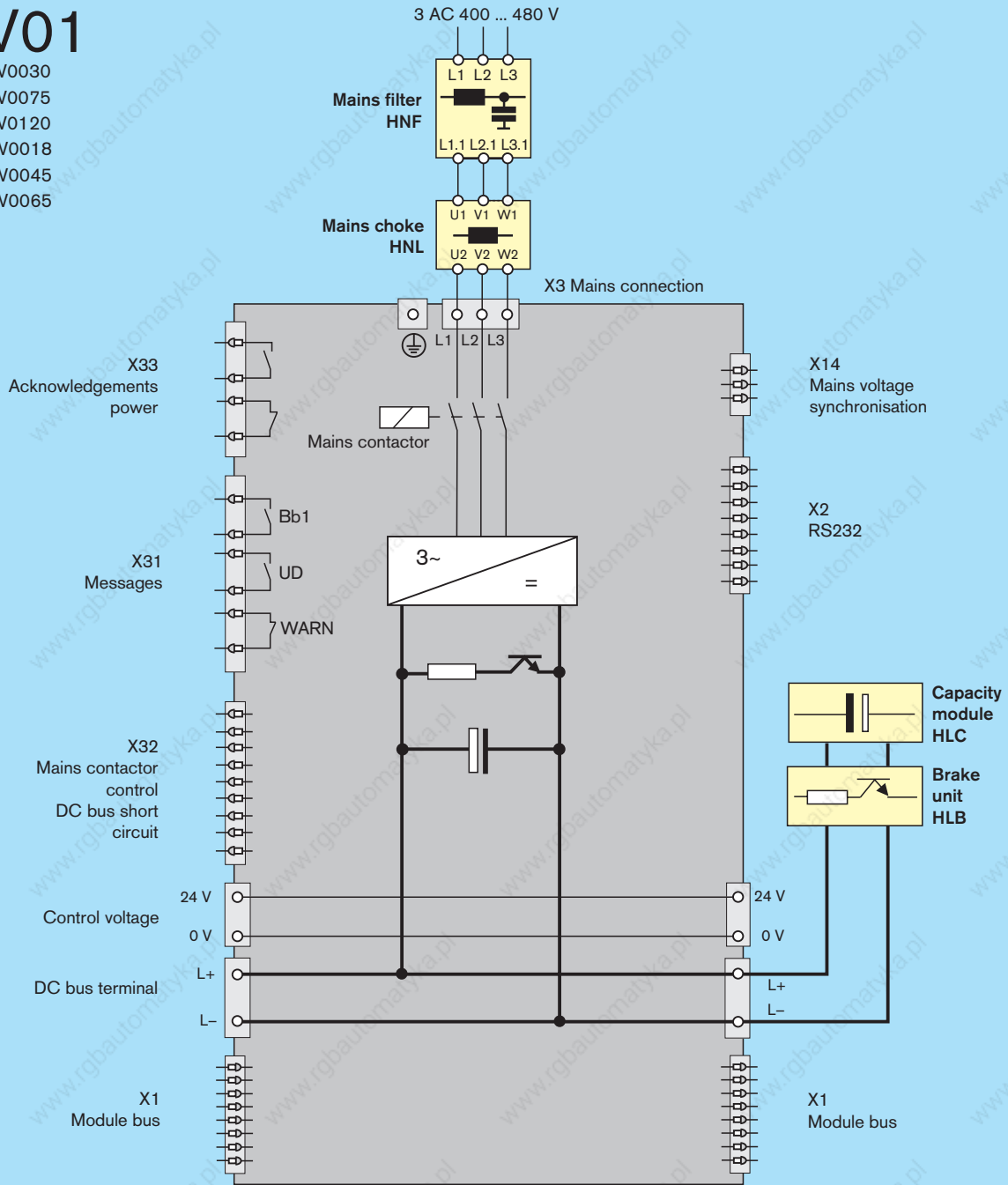

Optional auxiliary component
 Mains choke HNL always required with HMV01.1R
 Connection X14 on HMV01.1R only

HMV01

HMV01.1R-W0120

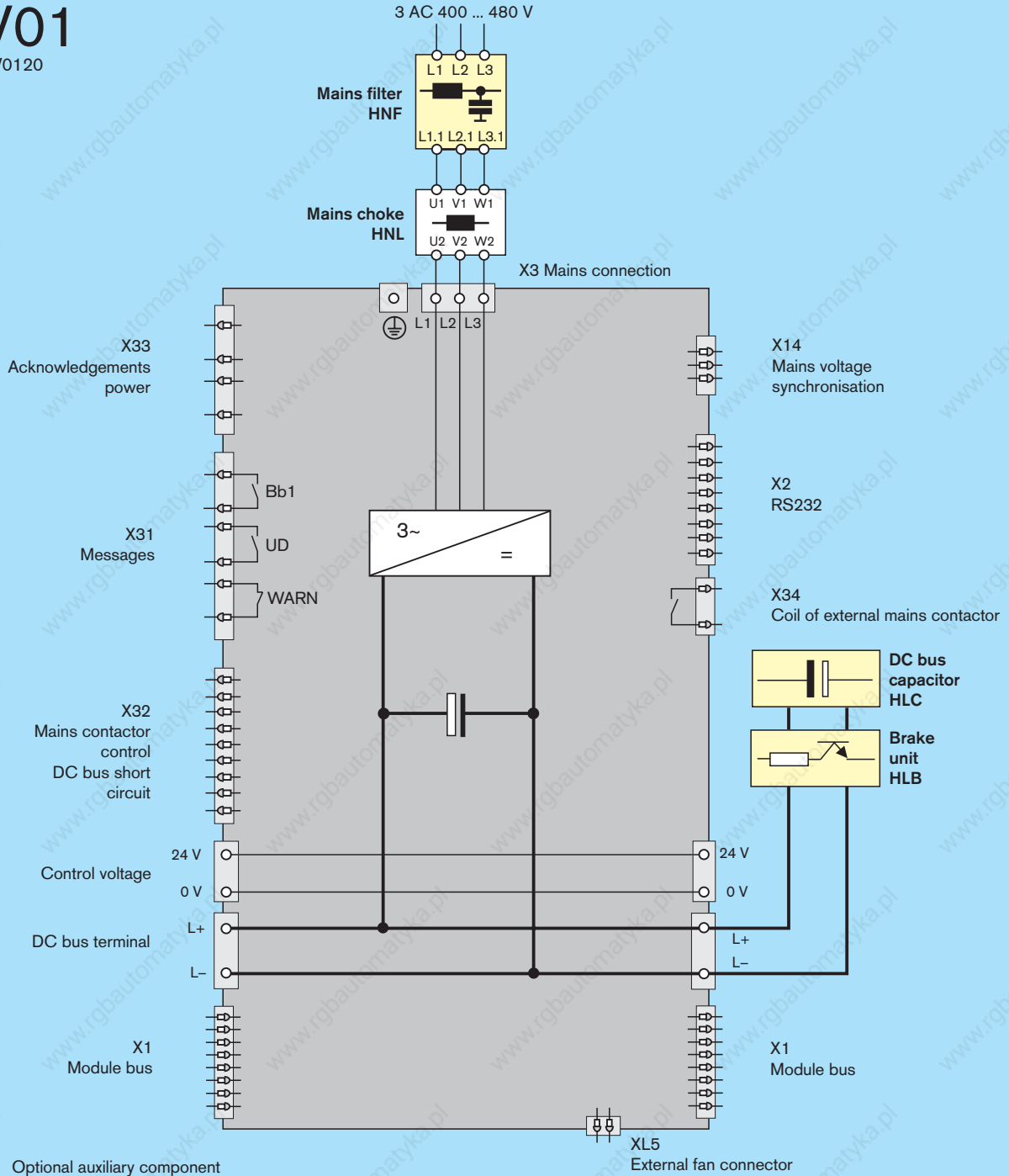

Optional auxiliary component

HMV02

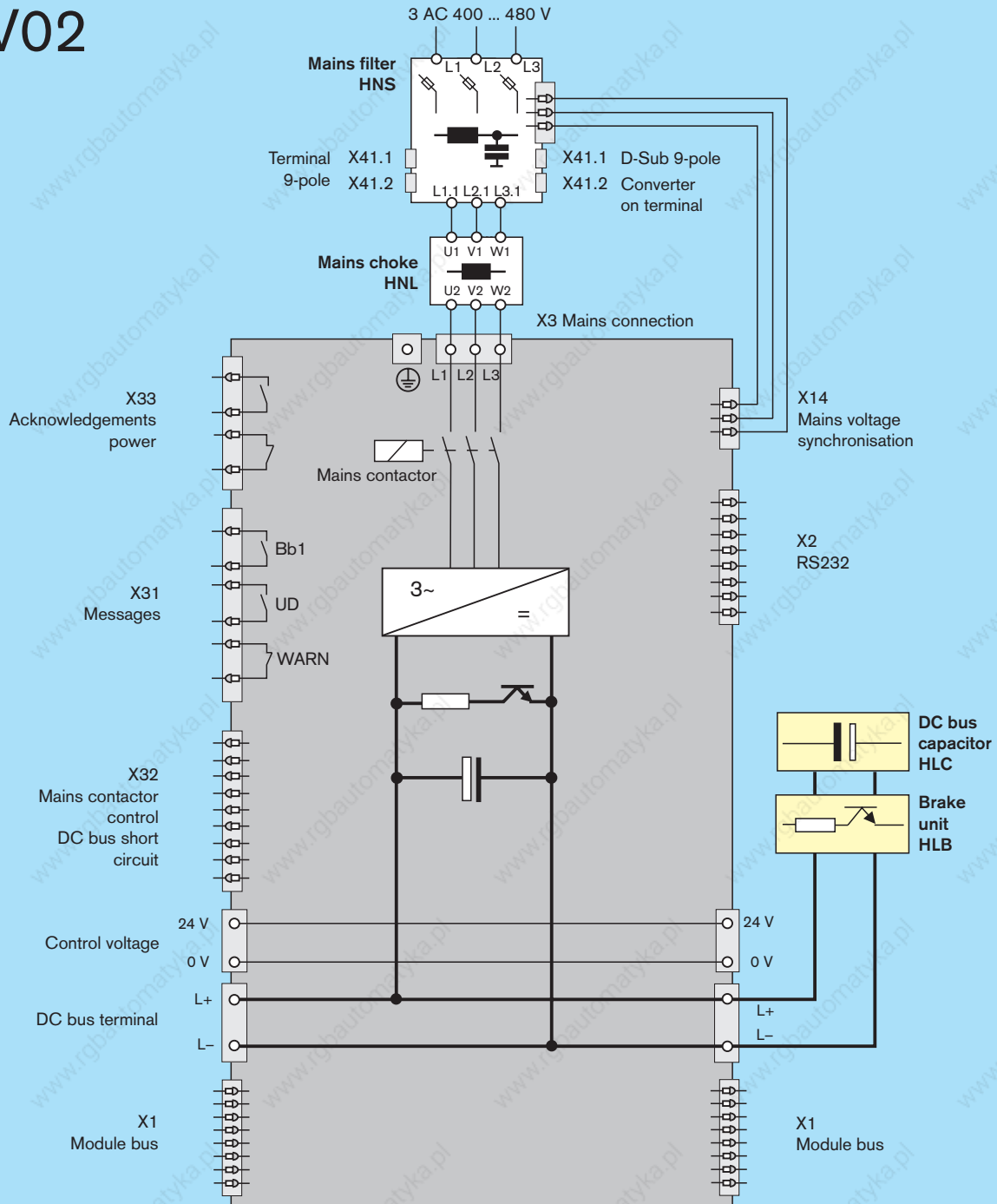

 Optional auxiliary component

Derating under differing operating conditions

Where installation conditions differ, the performance data of the power units decrease according to the capacity utilization factors for:

- Continuous current
- DC bus continuous output
- Continuous braking power

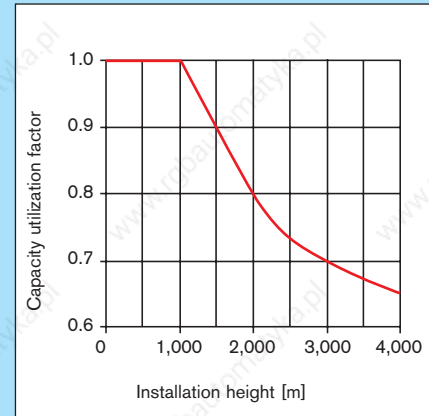
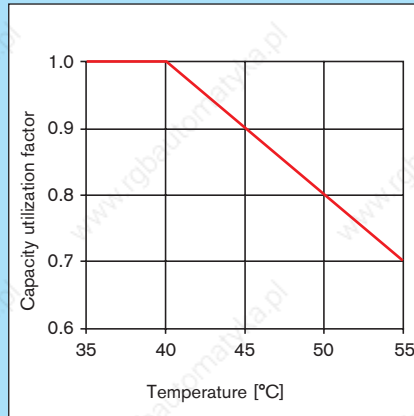

Compared with operation at 4 kHz switching frequency, the output currents of the power units decrease at higher switching frequencies. Please refer to these diagrams for the capacity utilization factors relevant for your application.

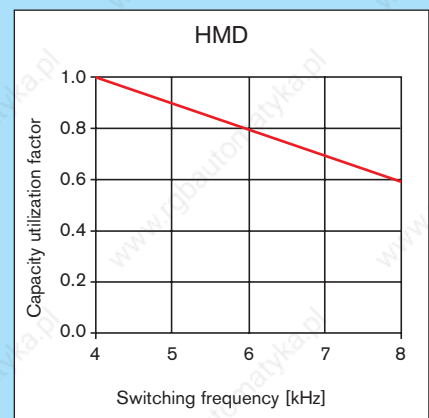
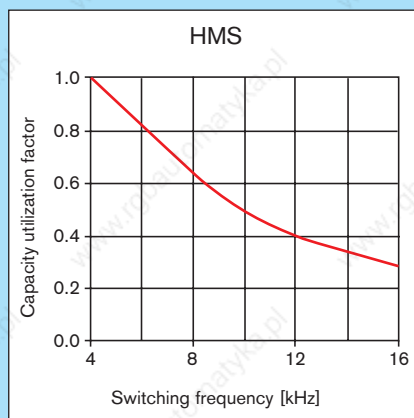
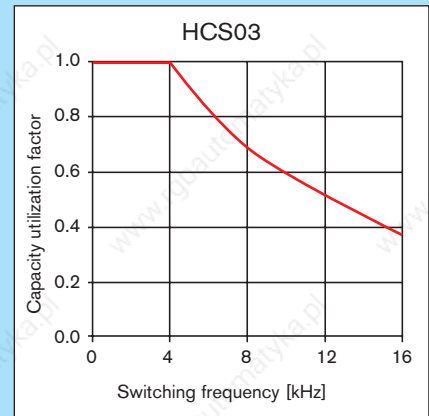
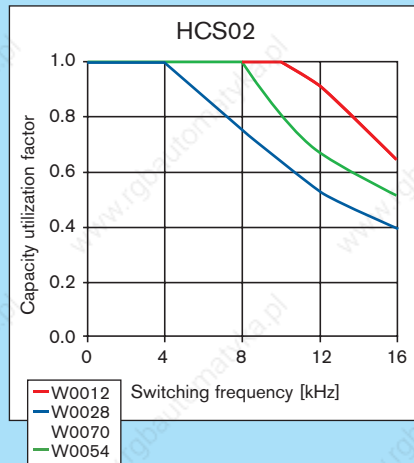



Rexroth IndraDrive – control units





Scalable performance and functionality

- Individual solutions for standard to high-end applications
- Integrated Motion Logic with innovative technology functions
- Open interfaces for international use
- Certified safety technology

Your benefits

We can supply control units tailored to your specific application, ranging from standard to high-end applications. Integrated Motion Logic, numerous technology functions, certified safety technology and standardized interfaces leave nothing to be desired.

BASIC control units – standard performance and functionality

These control units constitute the economic solution for all standard applications with moderate requirements in terms of performance and interface flexibility.

A standard encoder interface for IndraDyn motors is already featured among the BASIC control units. The BASIC UNIVERSAL control units have an additional expansion slot available.

The following BASIC control units are available to choose from:

- BASIC OPEN LOOP
- BASIC ANALOG
- BASIC PROFIBUS
- BASIC SERCOS
- BASIC UNIVERSAL – single-axis
- BASIC UNIVERSAL – dual-axis

ADVANCED control units – maximum flexibility and performance

These control units meet the highest requirements in terms of performance.

Virtually any application can be tackled with the wide range of communication and encoder interfaces as well as analog or digital inputs and outputs.



IndraDrive – scalable performance and functionality

All IndraDrive control units – from the simple frequency converter to the high-end servo drive with integrated Motion Control – are compatible with all IndraDrive C converters and IndraDrive M inverters.

The control units differ in performance, function and configuration. When combined with the various firmware versions and operating panels, every conceivable requirement can be met. This flexible system concept opens up the full range of options when it comes to tackling your individual application – always providing the optimum technical and economical solution.

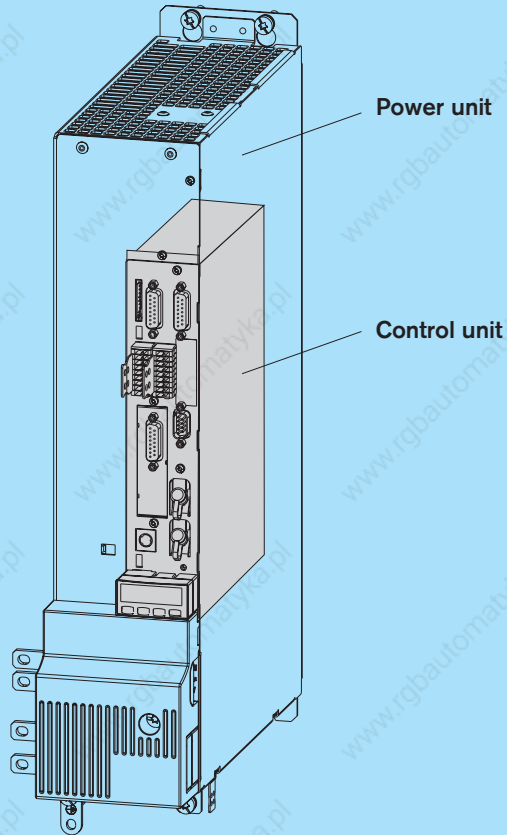

| Overview | Single-axis | Single-axis | Single-axis | Single-axis | Single-axis | Dual-axis | Single-axis |
|--|--------------------|-----------------|-------------------|-----------------|--------------------|----------------------------------|-----------------|
| | BASIC OPEN LOOP | BASIC ANALOG | BASIC PROFIBUS | BASIC SERCOS | BASIC UNIVERSAL | BASIC ⁵⁾ UNIVERSAL | ADVANCED |
| Control communication | | | | | | | |
| Analog/digital for OPEN LOOP operation | ● | – | – | – | – | – | – |
| Analog Interface | – | ● | – | – | – | – | ○ ¹⁾ |
| Parallel Interface | – | – | – | – | ○ | ○ | ○ |
| PROFIBUS DP | – | – | ● | – | ○ | ○ | ○ |
| SERCOS interface | – | – | – | ● | ○ | ○ | ○ |
| SERCOS III | – | – | – | – | ○ | ○ | ○ |
| PROFINet IO (in prep.) | – | – | – | – | ○ | ○ | ○ |
| CANopen | – | – | – | – | ○ | – | ○ |
| DeviceNet | – | – | – | – | ○ | – | ○ |
| Configurations | | | | | | | |
| Option 1 | – | ● ²⁾ | ● ²⁾ | ● ²⁾ | ● ²⁾ | ●/● | ● |
| Option 2 | – | – | – | – | ● | ●/● | ● |
| Option 3 | – | – | – | – | – | – | ● |
| Safety option | – | ● | ● | ● | ● | ●/● | ● |
| Slot for MultiMedia Card | – | – | – | – | ● | ● | ● |

| Options | Single-axis | Single-axis | Single-axis | Single-axis | Single-axis | Dual-axis | Single-axis |
|--|--------------------|-----------------|-------------------|-----------------|--------------------|----------------------------------|-------------|
| | BASIC OPEN LOOP | BASIC ANALOG | BASIC PROFIBUS | BASIC SERCOS | BASIC UNIVERSAL | BASIC ⁵⁾ UNIVERSAL | ADVANCED |
| Encoder interfaces | | | | | | | |
| IndraDyn motors MSK, MAD and MAF Hiperface, 1 V _{SS} and 5 V TTL ³⁾ | - | ● | ● | ● | ● | ○ | ○ |
| MHD, MKD and MKE motors | - | - | - | - | ○ | ○ | ○ |
| EnDat 2.1, 1 V _{SS} and 5 V TTL ⁴⁾ | - | - | - | - | ○ | ○ | ○ |
| Safety options compliant with EN 954-1 | | | | | | | |
| Starting lockout compliant with EN 954-1, Cat. 3 for the prevention of unintentional restart | - | ○ | ○ | ○ | ○ | ○ | ○ |
| Safety technology conforming to EN 954-1, Cat. 3 | - | - | - | - | - | ○ | ○ |
| Expansions | | | | | | | |
| Encoder emulation | - | ● | - | - | ○ | ○ | ○ |
| Analog I/O extension | - | - | - | - | ○ | ○ | ○ |
| Digital I/O extension | - | - | - | - | - | - | ○ |
| Digital I/O with SSI encoder interface | - | - | - | - | - | - | ○ |
| Cross communication | - | - | - | - | - | - | ○ |
| Software module | | | | | | | |
| MultiMedia Card | - | - | - | - | ○ | ○ | ○ |
| Operation panel | | | | | | | |
| Standard | ● | ● | ● | ● | ● | ● | ● |
| Comfort | ○ | ○ | ○ | ○ | ○ | ○ | ○ |

| Technical data | | Single-axis | Single-axis | Single-axis | Single-axis | Single-axis | Dual-axis | Single-axis |
|--|----|--------------------|-----------------|-------------------|-----------------|--------------------|----------------------------------|-------------|
| | | BASIC OPEN LOOP | BASIC ANALOG | BASIC PROFIBUS | BASIC SERCOS | BASIC UNIVERSAL | BASIC ⁵⁾ UNIVERSAL | ADVANCED |
| Cycle times | | | | | | | | |
| Current control | μs | 125 | | | | | | 62.5 |
| Speed control | μs | 250 | | | | | | 125.0 |
| Position control | μs | 500 | | | | | | 250.0 |
| PWM frequency | | | | | | | | |
| 4/8 kHz | | ●/● | ●/● | ●/● | ●/● | ●/● | ●/● | ●/● |
| 12/16 kHz | | -/- | -/- | -/- | -/- | -/- | -/- | ●/● |
| Inputs/outputs | | | | | | | | |
| Digital inputs/of which utilizable for touch probes | | 8/- | 5/- | 5/1 | 5/1 | 5/1 | 18/2 | 7/2 |
| Digital inputs/outputs (user-defined settings) | | - | 4 | 3 | 3 | 3 | 4 | 4 |
| Analog inputs | | 2 | 2 | - | - | - | 1 | 1 |
| Analog outputs | | 2 | - | - | - | - | 2 | 2 |
| Relay outputs | | 3 | 1 | 1 | 1 | 1 | 1 | 1 |
| Interfaces | | | | | | | | |
| RS232 | | ● | ● | ● | ● | ● | ● | ● |
| Control voltage data | | | | | | | | |
| Control voltage | V | DC 24 | | | | | | |
| Power consumption without options | W | 7.5 | 8.0 | 7.5 | 7.5 | 6.5 | 7.5 | 6.0 |
| Continuous current without options | A | 0.31 | 0.33 | 0.31 | 0.31 | 0.27 | 0.31 | 0.25 |

● Standard ○ Optional ¹⁾ in conjunction with additional options ²⁾ encoder interface for IndraDyn motors ³⁾ supply voltage 12 V ⁴⁾ supply voltage 5 V
⁵⁾ only in connection with power unit HMD

BASIC OPEN LOOP – for all applications without an encoder

Interfaces
Digital inputs and outputs
Analog inputs and outputs

Interfaces
Relay outputs

Interfaces
Analog inputs and outputs

Serial interface
RS232

Operation panel
Standard operation panel

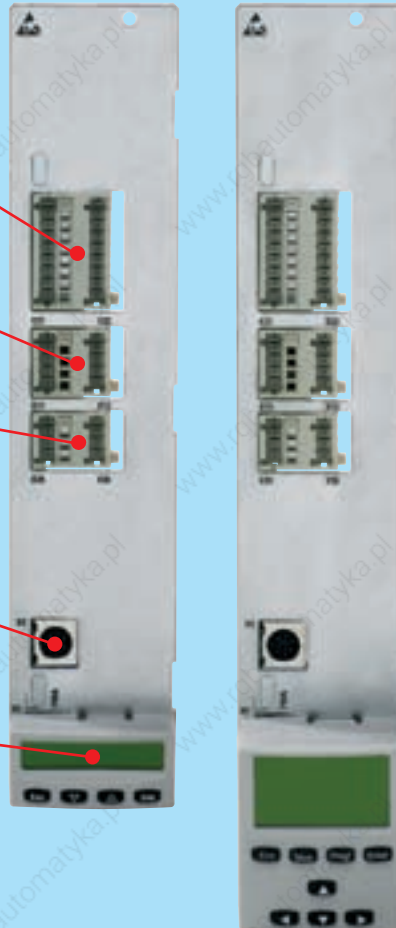

This control unit is specifically designed for frequency converter applications without a encoder.

The target speed can be set via analog or digital inputs.

Status signals and diagnostic messages are output via digital outputs or isolated relay contacts.

For an easy start-up use either the optional VCP 01 operating panel or a PC with the Rexroth IndraWorks software.

The simple step-by-step guide to ordering your BASIC OPEN LOOP control unit:

CSB01.1N-FC-NNN-NNN-NN-S-NN-FW

Single-axis BASIC

Control communication
FC = Frequency Converter Interface

Operation panel
S = Standard

BASIC ANALOG – cost-effective, proven technology

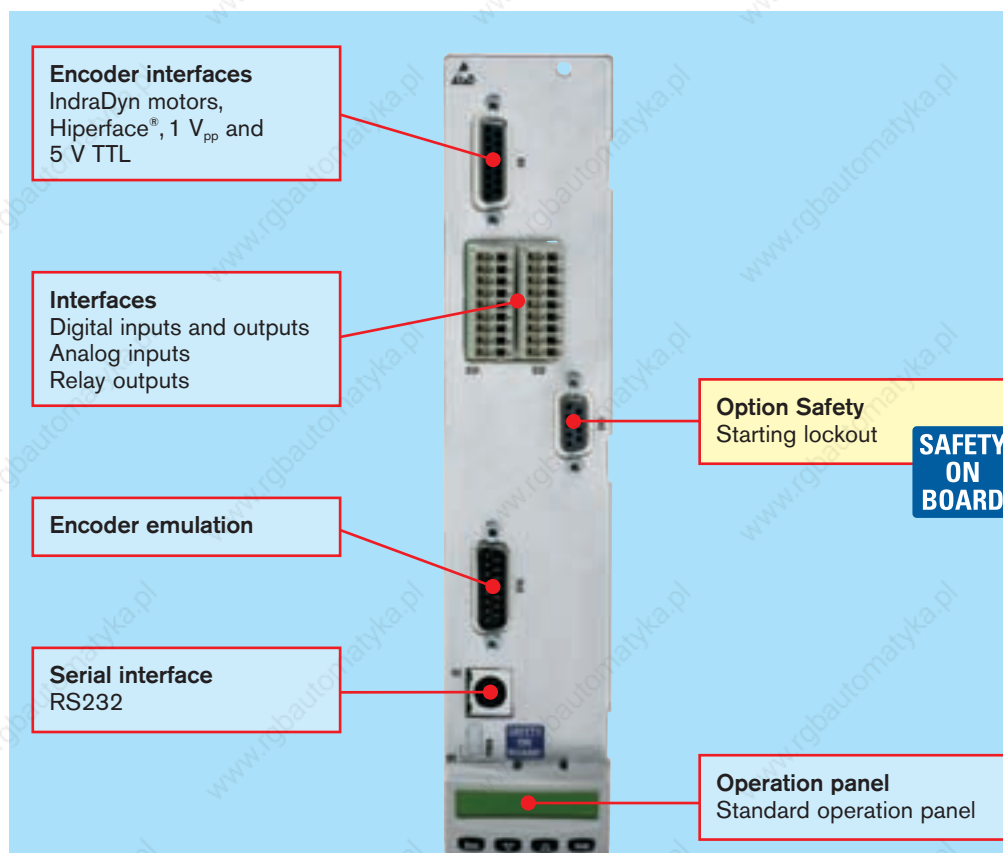

This control component allows you to enjoy the many benefits of digital drive technology on controls with the conventional ± 10 V analog interface. In addition, it gives you the added option of expanding your control equipment at any time to include other communication interfaces by exchanging the control component while retaining the control cabinet setup.

The default speed is set via the analog input. Signals, such as “Control enable” or “Drive stop”, are exchanged by the control system and control unit via digital inputs and outputs. The encoder emulation inside the drive systematizes the actual positions for the control system. There is a choice between the straightforward incremental encoder signal or SSI format.

The correct interface for connecting the IndraDyn motors or other standardized encoders, such as Hiperface, is already integrated.

The simple step-by-step guide to ordering your BASIC ANALOG control unit:

CSB01.1N-AN-ENS-NNN-L1-S-NN-FW

Single-axis BASIC

Control communication
AN = Analog interface

Encoder interface
ENS = IndraDyn motors, Hiperface® etc.

Option

Safety technology
L1 = with starting lockout
NN = without starting lockout

Operation panel
S = Standard

BASIC PROFIBUS – ideal for factory automation

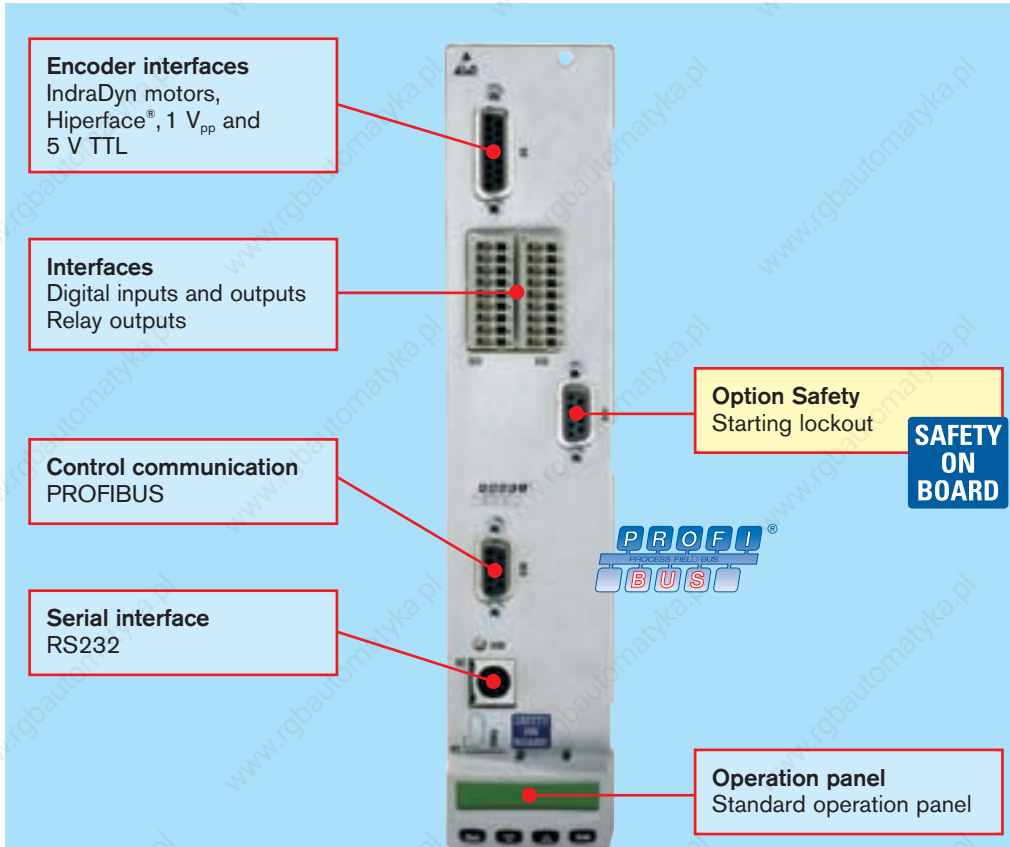

The PROFIBUS fieldbus interface has been used successfully for many years in automated manufacturing technology and process automation.

This bus system is the means by which the control system cyclically exchanges with the bus users all the specified and actual values, including status signals and diagnostic messages.

The correct interface for connecting the IndraDyn motors or other standardized encoders, such as Hiperface, is already integrated.

Start-up with the IndraWorks engineering tool is a convenient option via PROFIBUS. Alternatively, the drive can also be started up via the optional VCP 01 operating panel.

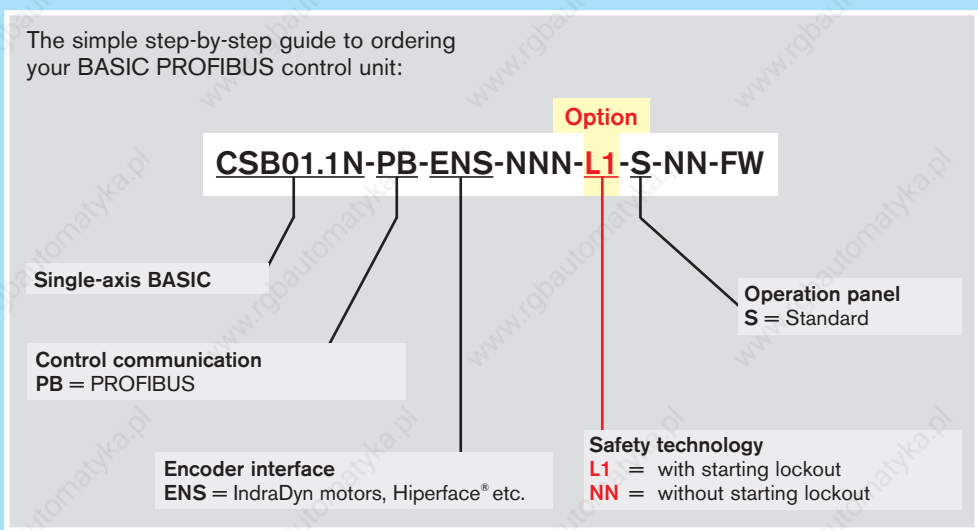

BASIC SERCOS – precise and cost-effective

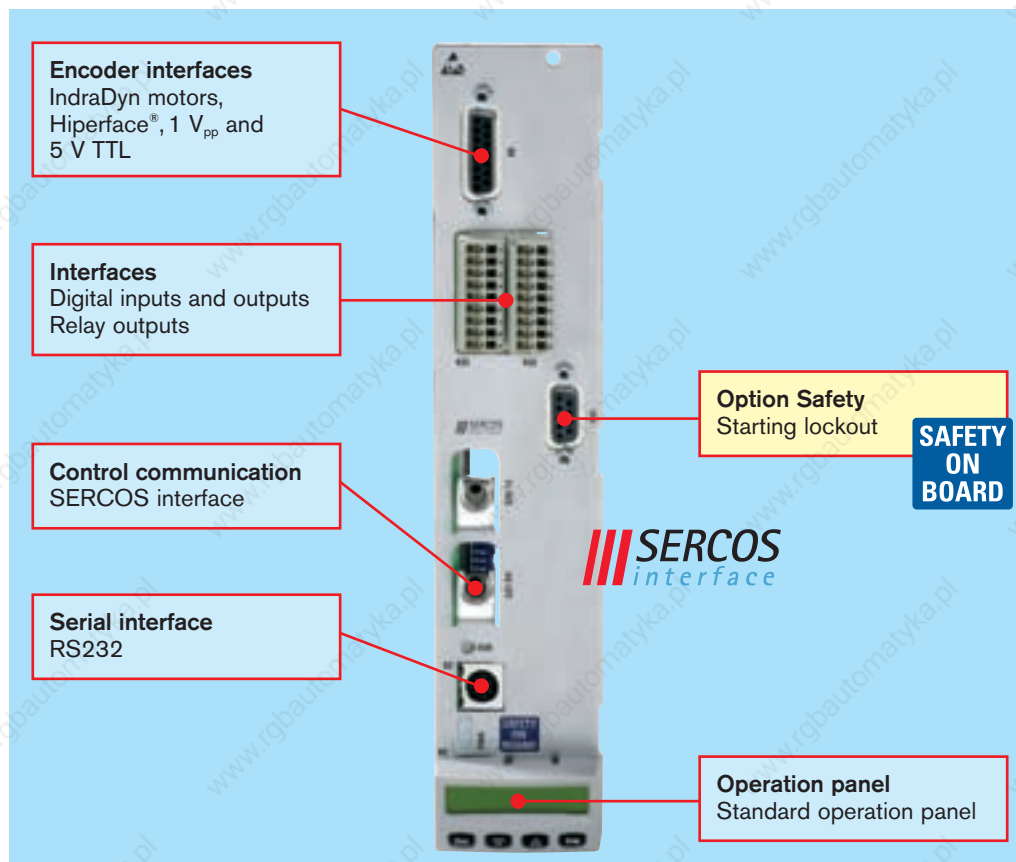

Only with the SERCOS interface¹⁾ can you benefit from all the advantages of digital intelligent drive technology. One distinguishing feature of SERCOS is its extremely short cycle time with which all target and actual values are transferred between the control system and control units. In conjunction with the exact synchronization of all drives, the SERCOS interface guarantees maximum dynamics and precision.

Signal transfer via fiber optics guarantees the secure exchange of real-time data with minimal wiring.

The correct interface for connecting the IndraDyn motors or other standardized encoders, such as Hiperface, is already integrated.

With the engineering tool, IndraWorks, one convenient start-up option is via the SERCOS service channel and the other is via the RS232 interface.

¹⁾ SERCOS interface, the internationally standardized drive interface (IEC 61491/ EN 61491) facilitates optimum compatibility of digital drives and controls made by different manufacturers while exploiting the respective product attributes to maximum effect.

The simple step-by-step guide to ordering your BASIC SERCOS control unit:

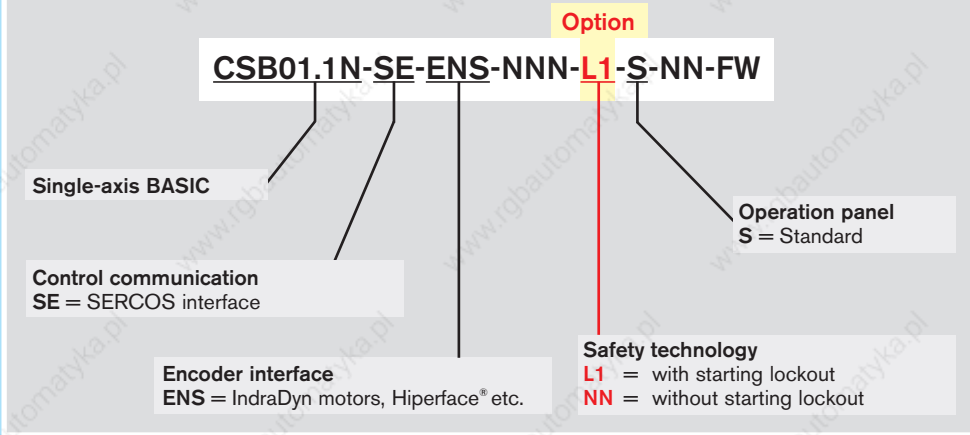

BASIC UNIVERSAL single-axis – flexible for customized solutions

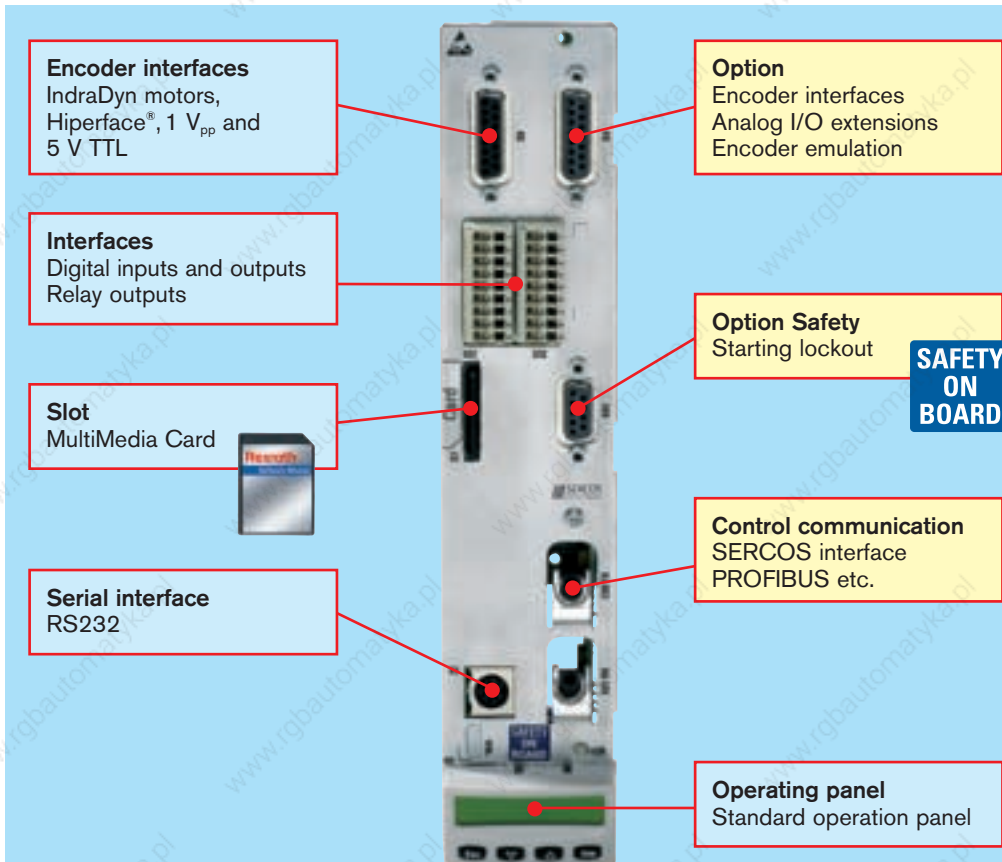

Regardless of your preferred type of control communication, BASIC UNIVERSAL offers you a wide range of industry-standard interfaces. As a result, this control unit is well suited for a variety of applications – including those in your industry.

The correct interface for connecting the IndraDyn motors or other standardized encoders, such as Hiperface, is already integrated. In addition, this control unit has an empty slot for the connection of another encoder, connection of the analog I/O extension or for the emission of emulated encoder signals.

An additional plug-in MultiMedia Card gives you the option of simple transmission or duplication of your drive parameters. This card can also be used to expand the memory for the Motion Logic integrated in the drive (firmware option).

For an easy start-up use either the optional VCP 01 operating panel or a PC with the Rexroth IndraWorks software.

The simple step-by-step guide to ordering your BASIC UNIVERSAL single-axis control unit:

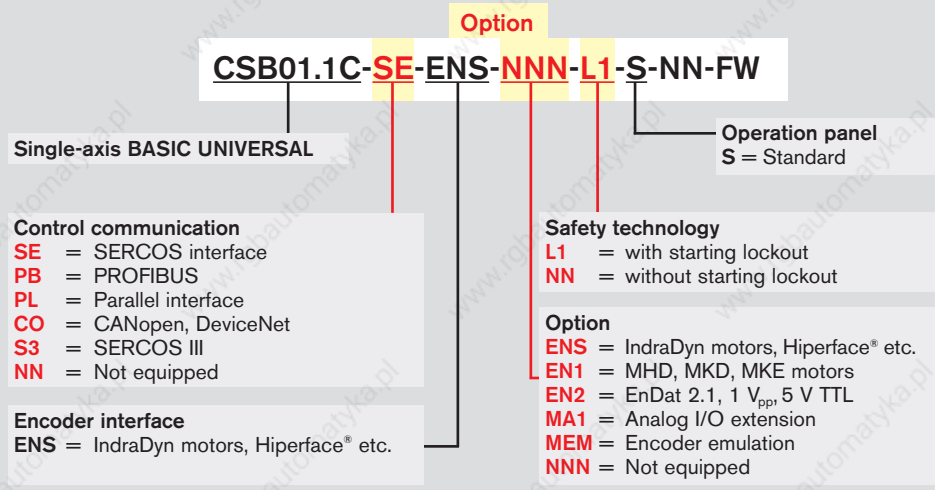

BASIC UNIVERSAL dual-axis – flexible, reliable, space-saving

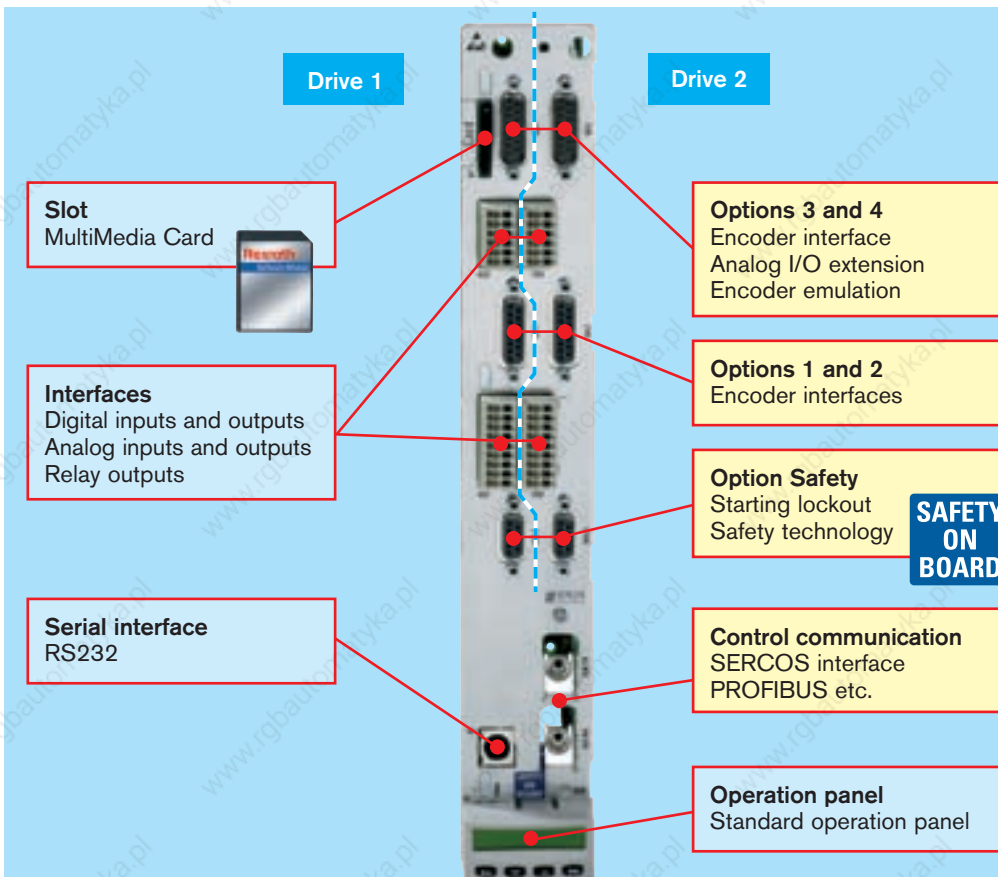

Many axes and limited installation space – these are typical requirements that can be met competently and economically with the BASIC UNIVERSAL dual-axis control unit. With the BASIC UNIVERSAL dual-axis, we have implemented all the functionality for two digital axes in a single control unit. The benefit for you is that, even if there are severe space constraints, you can integrate a number of drives thus minimizing your control cabinet footprint.

With certified safety technology conforming to EN 954-1, Category 3, you are providing effective protection for both the machine and operator. Indeed, we have integrated a number of different safety functions, such as “Safe stop” and “Safe motion”, directly in the drive. This increases reliability while saving on monitoring components and minimizing installation work.

In terms of control communication you can choose between SERCOS interface, PROFIBUS, SERCOS III and PROFInet IO. In the interests of meeting the specific demands of your individual application, IndraDrive offers additional options for the connection of various encoder systems, the connection of an analog I/O extension or for the emission of emulated encoder signals.

The dual-axis control unit offers the ability of storing the axis-oriented drive parameters of both axes on the optional MultiMedia Card.

For an easy start-up use either the optional VCP 01 operating panel or a PC with the Rexroth IndraWorks software.

The simple step-by-step guide to ordering your BASIC UNIVERSAL dual-axis control component:

Option
CDB01.1C-SE-ENS-EN2-NNN-MA1-S1-S-NN-FW

Dual-axis BASIC UNIVERSAL

Control communication
SE = SERCOS interface
PB = PROFIBUS
S3 = SERCOS III
NN = Not equipped

Options 1 and 2
ENS = IndraDyn motors, Hiperface® etc.
EN1 = MHD, MKD, MKE motors
EN2 = EnDat 2.1, 1 V_{pp}, 5 V TTL
NNN = Not equipped

Safety technology
L1 = with starting lockout
S1 = with safety technology
NN = without safety technology

Options 3 and 4
ENS = IndraDyn motors, Hiperface® etc.
EN1 = MHD, MKD, MKE motors
EN2 = EnDat 2.1, 1 V_{pp}, 5 V TTL
MA1 = Analog I/O extension
MEM = Encoder emulation
NNN = Not equipped

Operation panel
S = Standard

ADVANCED – the security of maximum performance and flexibility

Slot MultiMedia Card

Option 1
Encoder interface

Option 2
Encoder interface
Analog I/O extension
Encoder emulation

Option Safety
Starting lockout
Safety technology

Option 3
Encoder interfaces
Analog I/O extension
Encoder emulation
Digital I/O extension
Cross communication

Control communication
SERCOS interface
PROFIBUS etc.

Interfaces
Digital inputs and outputs
Analog inputs and outputs
Relay outputs

Serial interface
RS232

Operation panel
Standard operation panel

SAFETY ON BOARD

ADVANCED control units meet the highest demands in performance and dynamics.

In addition to top performance, they support a wide and diverse range of control communication and encoder interfaces. Digital and analog inputs and outputs are already permanently integrated for communication with higher level control systems. These can also be expanded by digital or analog I/O extensions or by encoder emulation outputs. This high-performance control unit can be optionally equipped with safety technology certified as conforming to EN 954-1, Category 3. The ADVANCED control unit is the ideal platform for the drive-integrated PLC, IndraMotion MLD.

All that is required to start up the drive is a PC and the engineering tool IndraWorks or a connected comfort operating panel.

The simple step-by-step guide to ordering your ADVANCED control component:

Option
CSH01.1C-SE-ENS-EN2-NNN-S1-S-NN-FW

Single-axis ADVANCED

Operation panel
S = Standard

Control communication

- SE** = SERCOS interface
- PB** = PROFIBUS
- PL** = Parallel interface
- CO** = CANopen, DeviceNet
- S3** = SERCOS III
- NN** = Not equipped

Option 1 (encoder interface)

- ENS** = IndraDyn motors, Hiperface® etc.
- EN1** = MHD, MKD, MKE motors
- EN2** = EnDat 2.1, 1 V_{pp}, 5 V TTL
- NNN** = Not equipped

Option 2

- ENS** = IndraDyn motors, Hiperface® etc.
- EN1** = MHD, MKD, MKE motors
- EN2** = EnDat 2.1, 1 V_{pp}, 5 V TTL
- MA1** = Analog I/O extension
- MEM** = Encoder emulation
- NNN** = Not equipped

Safety technology

- L1** = with starting lockout
- S1** = with safety technology
- NN** = without safety technology

Option 3

- ENS** = IndraDyn motors, Hiperface® etc.
- EN1** = MHD, MKD, MKE motors
- EN2** = EnDat 2.1, 1 V_{pp}, 5 V TTL
- MA1** = Analog I/O extension
- MEM** = Encoder emulation
- MD1** = Digital I/O extension
- MD2** = Digital I/O with SSI encoder interface
- CCD** = Cross communication
- NNN** = Not equipped

Accessories – advantages for your control unit

These components can help you to capitalize on your drive – during start-up, operation and diagnostics.

Operation panels

All control units are equipped with a standard plug-in operating panel. An optional comfort operating panel with graphics capabilities. This will guide you quickly and confidently through all the start-up steps – no PC is required. Moreover, the comfort operating panel offers the capability of transmitting the drive parameters from one drive to another – quickly and easily.



Separate control terminals

For complex applications, especially in conjunction with the drive-integrated Motion Logic, we recommend the use of our compact control terminals IndraControl VCP. Connection is via the drive's serial interface.

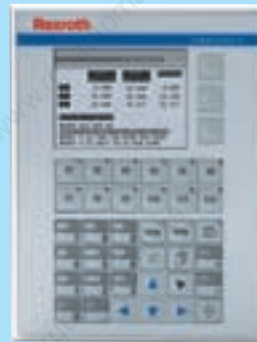

From the simple text display right through to the graphics-capable touch screen, it always provide a particularly cost-effective solution for operation and visualization.

For more detailed information, please refer to the product catalog "Automation Systems and Control Components" (R911320438).



Software module

The optional MultiMedia Card allows you to transmit or duplicate your axis-oriented drive parameters quickly and easily – without a PC.



This software module comes in two versions:

- PFM02.1-016-NN-FW with drive firmware
- PFM02.1-016-NN-NW preformatted for simple parameter transfer

Interface cable

For start-up or operation connect your PC or a separate control terminal directly to the RS232 serial interface of the control unit.

The pre-assembled PC interface cable IKB0041 is available in lengths of 2, 5, 10 or 15 m.

The RKB0004 operator terminal cable is available in lengths of 2, 5 and 10 m.



Overview of interfaces

Control communication

Analog/digital for OPEN LOOP operation

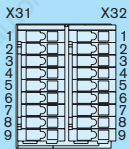

- 2 x 9-pin plug-in terminals
- 8 digital inputs

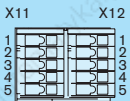

- 2 x 5-pin plug-in terminals
- 3 relay outputs (24 V DC and 230 V AC)

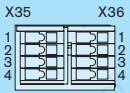

- 2 x 4-pin plug-in terminals
- 2 analog inputs
 - 2 analog outputs

Analog interface

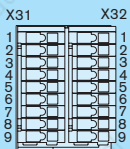

- 2 x 9-pin plug-in terminals
- Analog inputs ± 10 V
 - Digital inputs/outputs
 - Relay output

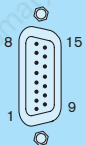

- D-SUB, 15-pin, male version
- Encoder emulation, incremental or absolute (SSI)
 - Output frequency max. 1 MHz

Parallel interface

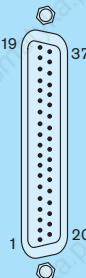

- D-SUB, 37-pin, male version
- 16 inputs, reverse polarity protected
 - 16 outputs, short-circuit proof
 - DC-isolated

Also suitable for input/output expansion in conjunction with IndraMotion MLD

SERCOS interface



- 2 x fiber optic cable connections



- Choice of transfer rates 2, 4, 8 or 16 Mbaud

PROFIBUS DP

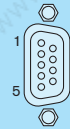

- D-SUB, 9-pin, female version

CANopen/DeviceNet



- Open-style connector, 5-pin

- Selector switch for CANopen or DeviceNet

SERCOS III



- 2 x RJ45 plug-in connection

Encoder interfaces

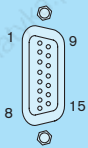

ENS encoder interface for IndraDyn motors, Hiperface®, 1 V_{pp}, 5 V TTL

D-SUB, 15-pin, female version
 • Encoder supply: 11.6 V/300 mA

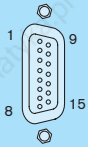

EN1 encoder interface for MHD, MKD and MKE motors

D-SUB, 15-pin, female version
 • Encoder supply I²C: 8 V/250 mA
 or resolver: 18.2 V/70 mA

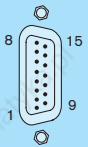

EN2 encoder interface for EnDat 2.1, 1 V_{pp}, 5 V TTL

D-SUB, 15-pin, male version
 • Encoder supply: 5 V/300 mA

Encoder emulation

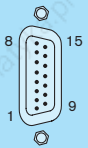

Encoder emulation **MEM**

D-SUB, 15-pin, male version
 • Internal voltage supply
 • Encoder signals DC-isolated
 • Incremental or
 • Absolute (SSI format)
 • Output frequency max. 1 MHz

Cross communication

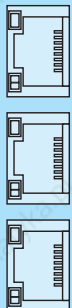

Cross communication **CCD**

3 x RJ45 plug-in connection
 • Master for connection of up to 7 Slaves (SERCOS III)
 • Ethernet engineering interface

Input/output extensions

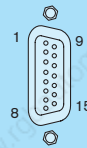

Analog I/O extensions **MA1**

D-SUB, 15-pin, female version
 • 2 analog input ports ± 10 V
 • 14 bit incl. 8-time oversampling
 • 2 analog 12 bit output ports

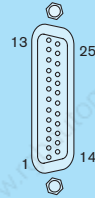

Digital I/O extensions **MD1**

D-SUB, 25-pin, male version
 • External voltage supply from 19 V to 30 V
 • 12 inputs, reverse polarity protected
 • 8 outputs, short-circuit proof

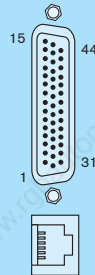

Digital I/O with SSI interface **MD2**

D-SUB, 44-pin, male version
 • External voltage supply from 19 V to 30 V
 • 16 inputs, reverse polarity protected
 • 16 outputs, short-circuit proof



RJ11 plug-in connection for SSI measuring encoder interface

Safety

Starting lockout **L1**



D-SUB, 9-pin, female version
 • Supply voltage 24 V DC
 • Drive signals A, B and inverse
 • Acknowledgement
 • Acknowledgement, inverse

Safety technology **S1**

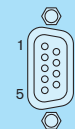

D-SUB, 9-pin, female version
 • Supply voltage 24 V DC
 • Mode selection panel inputs
 • Acknowledgement, forced dormant error detection and diagnostics/safety door lock

IndraDrive Mi – motor-integrated drive system



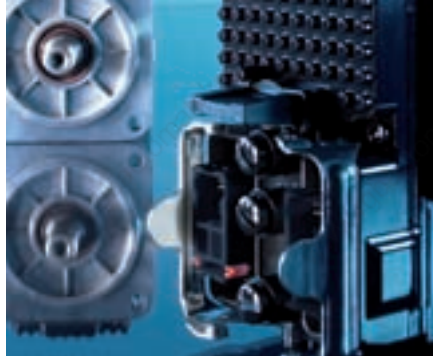

Compact and economically efficient:

- ! Maximum torques of up to 35 Nm
- ! Flexible extension options
- ! Easy project planning
- ! Less wiring
- ! Smaller control cabinet size

Your benefits

IndraDrive Mi – highest performance, smallest space requirements

With IndraDrive Mi, Rexroth introduces another milestone in drive technology – electronic control system and servo motor combined in one ultra-compact unit.

This makes IndraDrive Mi the ideal solution for all applications where maximum flexibility and economic efficiency should come along with minimum space requirements.

In addition to its compact design, IndraDrive Mi combines the best characteristics of an IndraDrive and MSK servo motor – from the drive-integrated PLC according to IEC 61131-3 up to protection category IP65.

Adaption box KCU

The adaption box KCU allows all required connections for a daisy chain of up to 20 IndraDrive Mi – This reduces the installation workload to a minimum.

Accessories

- Hybrid cable – for communication and power supply
- Terminal connector – for terminating the drive chain
- Interface cable – for connection to a PC
- Software module – for data transfer without a PC



IndraDrive Mi – the ultra-compact drive system

The compact control electronics of the IndraDrive Mi uses the lateral surface of the servo motor as a cooling element. This reduces the total unit size by more than 50 % compared to classical servo drive solutions and by up to 30 % compared to other integrated solutions.

Another advantage of the IndraDrive Mi is the significantly reduced installation work – a single cable is sufficient for power supply and communication via SERCOS interface.

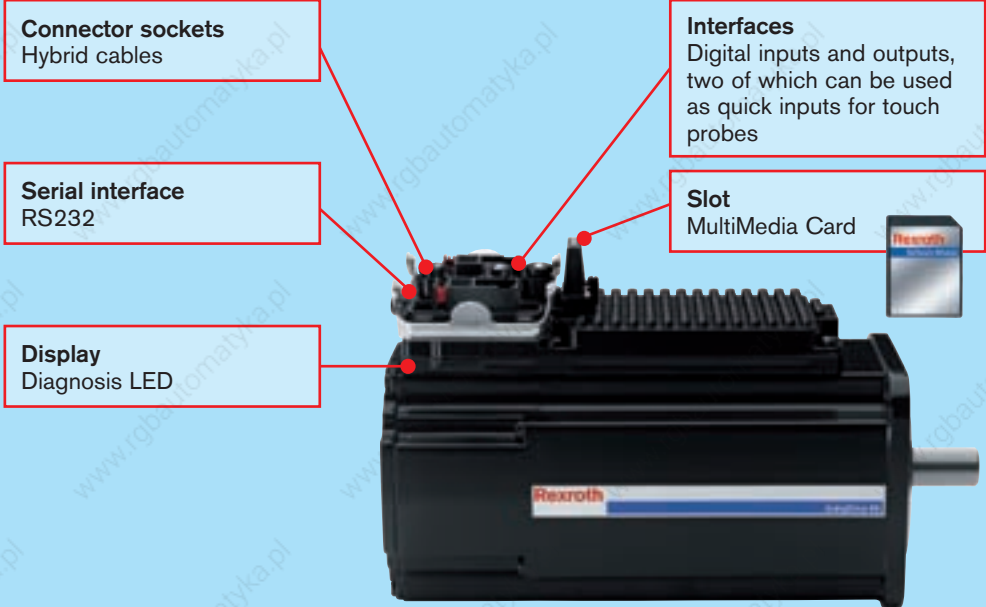

The simple step-by-step guide ordering your motor-integrated drive system – IndraDrive Mi:

Option
KSM01.2B-061C-35N-M1-HP0-SE-NN-D7-NN-FW

Control unit version
B = BASIC

Basic motor
 • Overall size (e. g. "061")
 • Overall length (e. g. "C")
 • Winding (e. g. "35")

Cooling system
N = Natural convection

Encoder
S1 = Singleturn encoder (Hiperface) 128 increments
M1 = Multiturn encoder (Hiperface) 128 increments with 4096 revolutions absolute

Electrical connection
H = Connector, hybrid

Supply voltage
D7 = DC 750 V

Safety technology
NN = without safety technology (in preparation: CIP safety on SERCOS)

Control communication
SE = SERCOS interface (RS422)

Shaft
G = Plain shaft with shaft sealing ring
P = Keyway conforming to DIN 6885-1 and shaft sealing ring

Holding brake
0 = without holding brake
2 = with electrically released holding brake (DC 24 V)

| Servo drive | | Maximum speed | Continuous torque at standstill | Maximum torque | Continuous current at standstill | Maximum current | Moment of inertia | Dimensions | | | | | | | Mass ¹⁾ | |
|--------------|------|-----------------|---------------------------------|----------------|----------------------------------|-----------------|---------------------------|------------|--------|--------|----------------------|----------------------|----------------------|----------------------|--------------------|-----------|
| | | n_{Max} [rpm] | M_0 [Nm] | M_{Max} [Nm] | I_0 [A] | I_{Max} [A] | J_R [kgm ²] | A [mm] | B [mm] | C [mm] | $\varnothing D$ [mm] | $\varnothing E$ [mm] | $\varnothing F$ [mm] | $\varnothing G$ [mm] | H [mm] | m [kg] |
| KSM01.2B-041 | C-42 | 5,500 | 2.2 | 9.4 | 1.4 | 6.8 | 0.000170 | 82 | 252 | 30 | 14 | 50 | 95 | 6.6 | 201 | 5.5/6.0 |
| KSM01.2B-061 | C-35 | 4,300 | 6.0 | 25.0 | 3.3 | 14.9 | 0.000870 | 115 | 271 | 40 | 19 | 95 | 130 | 9.0 | 216 | 9.5/10.3 |
| | C-61 | 6,000 | 5.5 | 18.0 | 5.0 | 17.7 | | | | | | | | | | |
| KSM01.2B-071 | C-24 | 3,400 | 10.5 | 35.0 | 4.4 | 17.7 | 0.001730 | 140 | 307 | 58 | 32 | 130 | 165 | 11.0 | 248 | 14.0/15.1 |
| | C-35 | 4,700 | 10.0 | 28.0 | 5.7 | 17.7 | | | | | | | | | | |
| KSM01.2B-076 | C-35 | 4,700 | 8.7 | 29.0 | 5.7 | 17.7 | 0.004300 | 140 | 290 | 50 | 24 | 110 | 165 | 11.0 | 248 | 14.5/15.6 |

All data refer to the operation with 750 V DC bus voltage

¹⁾ values without/with holding brake

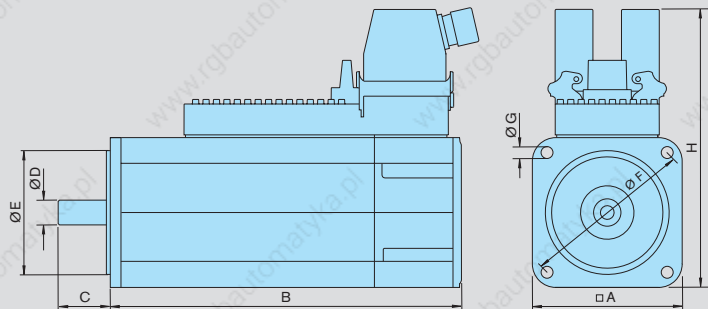
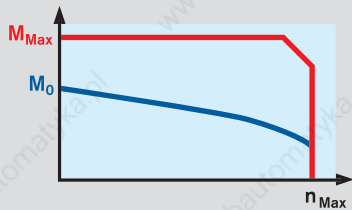

All advantages of IndraDrive Mi at one glance:

- Significant reduction of the cabinet size by up to 70 %
- Drastic reduction of wiring work by up to 85 %
- Significant increase of flexibility and modularity of machines and plants

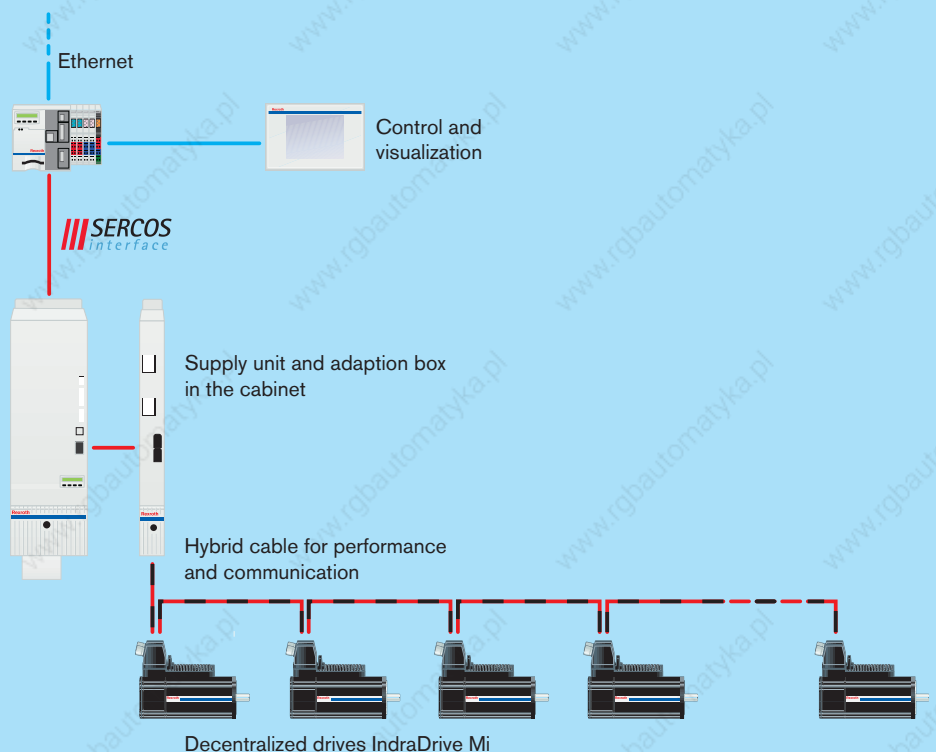

IndraDrive Mi – adaption box KCU

| Adaption box | Nominal voltage input | Nominal current input | Width W | Height H | Depth D | Mass |
|--------------------------------|-----------------------|-----------------------|---------|----------|---------|------|
| | V | A | mm | mm | mm | kg |
| KCU01.2N-SE-SE*-025-NN-S-NN-NW | DC 540 ... 750 | 25 | 50 | 352 | 252 | 3.8 |

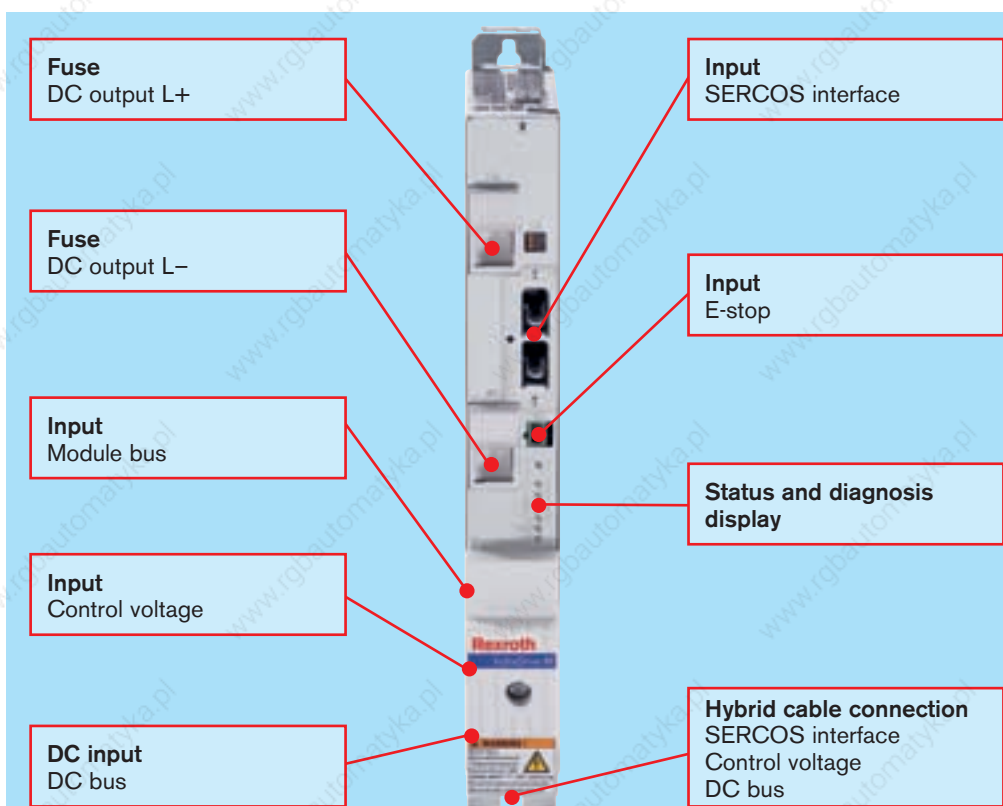

Adaption box KCU

In addition to its function as a signal converter for SERCOS interface, the compact adaption box KCU allows all necessary connections to the IndraDrive Mi at a common coupling.

- Conversion of SERCOS interface from the fiber optics cable to RS422
- Routing of the power supply from the DC bus of an IndraDrive converters or supply unit
- Exchange of status and diagnostic messages between IndraDrive Mi and supply unit
- Supply of control voltage to the IndraDrive Mi
- Protection of the DC bus connection with integrated fuses

Up to 20 IndraDrive Mi units can be flexibly connected in series in one drive chain – without any modifications to the cabinet or additional splitting boxes.

If required, it is also possible to operate several drive chains in parallel at one supply unit.

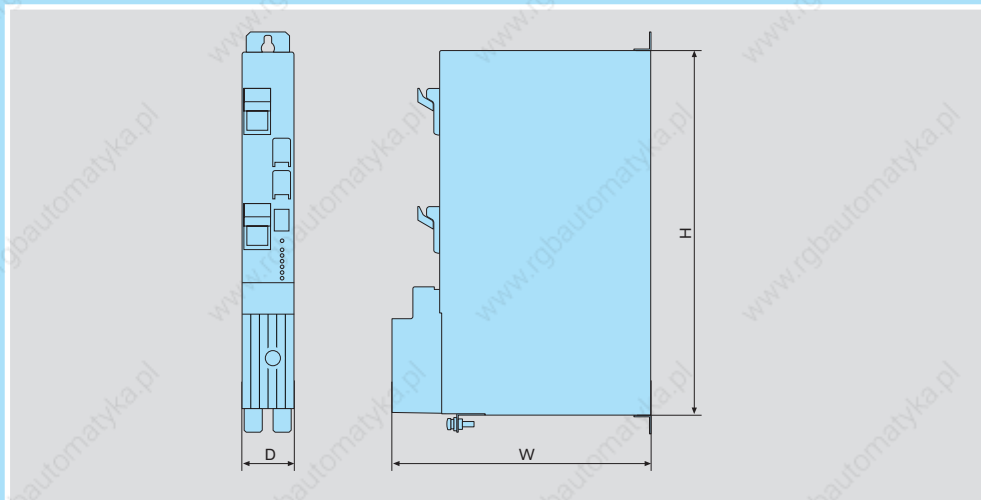

IndraDrive Mi – accessories

Hybrid cable RKH and terminal connector RHS

The significant reduction of installation work is one of the big advantages of the IndraDrive Mi – a single cable is sufficient for power supply and communication via SERCOS interface.

The hybrid cable RKH is supplied pre-assembled with plug-in connectors. Coded connectors ensure that the hybrid cable is connected with the correct polarity. From the wide range of connecting cables, select the suitable outgoing direction for your application.

Each cable with one or several IndraDrive Mi is connected with a terminal connector RHS0004.



Interface cable

For start-up or operation, connect your PC directly to the serial interface of the IndraDrive Mi.

The cable RKB0006 for connection of a PC to the IndraDrive Mi is available pre-assembled with a length of 5 m.



Software module ¹⁾

The MultiMedia Card provides an easy transmission or duplication of your drive parameters without PC.

¹⁾ included in the delivery



Rexroth IndraDrive – firmware

The firmware can be tailored to your specific application in a number of flexible configurations:

- Basic OPEN LOOP package (frequency converter applications)
- Basic CLOSED LOOP package (servo and frequency converter applications)
- Extension packages (optional)
- Motion Logic (IndraMotion MLD optional)

The basic package is already sufficient to perform the majority of standard drive functions – from simple V/f control right through to positioning block mode.

Various extension packages provide you with the options of electronic synchronization, additional servo functions or main spindle operation.

The freely-programmable Motion Logic with integrated PLC conforming to IEC 61131-3 and ready-to-use technology functions enable simple execution of complex machine processes.

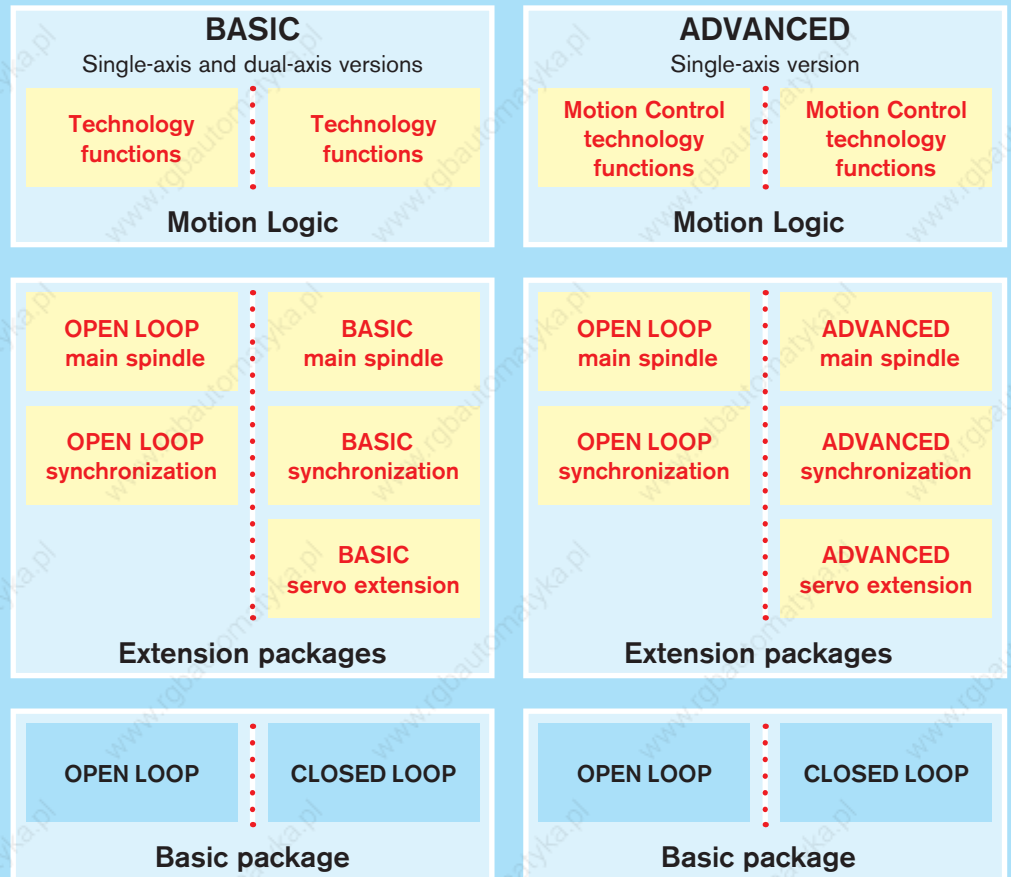

The simple step-by-step guide to ordering your IndraDrive firmware:

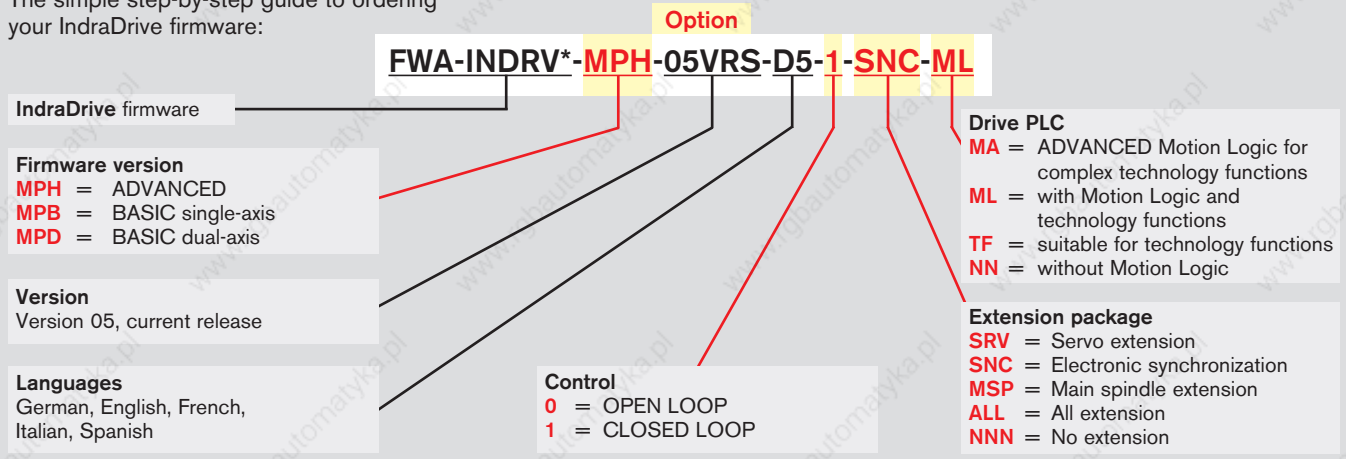



Customized functionality

- ! All standard functions already included in basic package
- ! Individual function extensions
- ! Industry-specific technology functions
- ! Integrated IEC-compliant Motion Logic

Your benefits

| Basic package | BASIC | | ADVANCED | |
|--|-----------|-------------|-----------|-------------|
| | OPEN LOOP | CLOSED LOOP | OPEN LOOP | CLOSED LOOP |
| Basic functions | | | | |
| General motor with V/f-Curve, incl. slip compensation | | | | |
| I x R compensation and stall protection | | | | |
| Field-oriented control circuit adjustment | | | | |
| Electronic type plate | | | | |
| Automatic control circuit adjustment | ● | ● | ● | ● |
| Setpoint generator for control optimization | | | | |
| Travel to fixed stop | | | | |
| Adjustable error response | | | | |
| Brake control | | | | |
| Oscilloscope function | | | | |
| Basic functions OPEN LOOP | | | | |
| Speed ramp generator | ● | ● | ● | ● |
| Motorized potentiometer function | | | | |
| Basic functions CLOSED LOOP | | | | |
| Position, speed and torque control | | | | |
| Drive-controlled referencing | | | | |
| Drive-controlled positioning | | | | |
| Interpolation inside drive | | | | |
| Positioning block mode | | | | |
| Position, speed and torque limit | | | | |
| Automatic commutation adjustment | - | ● | - | ● |
| Travel to fixed stop | | | | |
| Path switching point with ON and OFF switching threshold | | | | |
| Encoder emulation, incremental or absolute (SSI format) | | | | |

| Extension packages | BASIC | | ADVANCED | |
|--|-----------------|-----------------|-----------|-------------|
| | OPEN LOOP | CLOSED LOOP | OPEN LOOP | CLOSED LOOP |
| Servo extension | | | | |
| Easy compensation of backlash on reversal | - | ● | - | ● |
| Axis error correction | - | - | - | ● |
| Quadrant error correction | - | - | - | ● |
| Frictional torque compensation | - | ● | - | ● |
| Touch probe with fast stop | - | 1 | - | 2 |
| Dynamic cam group | - | ● | - | ● |
| Main spindle | | | | |
| Parameter block changeover | ● | ● | ● | ● |
| Spindle positioning mode | - | ● | - | ● |
| Drive-controlled gear changes | - | - | - | ● |
| Synchronization | | | | |
| Speed synchronization | ● | ● | ● | ● |
| Angle synchronization | - | ● | - | ● |
| Measuring wheel mode | - | ● | - | ● |
| Real and virtual leading axis | ● | ● | ● | ● |
| Cam plate (tabular value) | - | ● | - | ● |
| Cam plate (analytical value) | - | - | - | ● |
| Touch probe with time measurement | 1 | - | 1 | - |
| Touch probe with synchronization function | - | 1 | - | 2 |
| Dynamic cam group | - | ● | - | ● |
| Motion Logic | | | | |
| | OPEN LOOP | CLOSED LOOP | OPEN LOOP | CLOSED LOOP |
| IndraMotion MLD | | | | |
| Freely programmable in compliance with IEC 61131-3 | | | | |
| Programming system for IL, ST, FBD, LD, SFC and CFC | | | | |
| 4 user tasks (periodic, unsolicited or event-controlled) | ● ¹⁾ | ● ¹⁾ | ● | ● |
| Libraries: system-specific, drive-specific, PLCopen | | | | |
| Support of customer libraries | | | | |
| Process-oriented technology packages | | | | |

¹⁾ BASIC control units are restricted in terms of performance

Rexroth IndraMotion MLD – integrated Motion Logic

The world's first open drive

With IndraMotion MLD drive functions, motion control and processing logic merge to form a modern open automation platform for modular machine concepts. The drive-integrated Motion Logic reduces or even eliminates the need for higher-level control systems.

Open standards

Standardized programming languages and the integrated engineering framework IndraWorks simplify project planning, programming, operation and diagnostics. At the same time you are directly investing your valuable know-how in the drive and thereby safeguarding your competitive edge. Programming is in compliance with IEC 61131-3 in the following languages:

- Instruction list (IL)
- Structured text (ST)
- Functional block diagram (FBD)
- Ladder diagram (LD)
- Sequential function chart (SFC)
- Continuous function chart (CFC)

The availability of standardized modules in the PLCopen-compliant function library gives you access to a multitude of motion functions.

Flexible programming

With user-definable programming you have the freedom and flexibility to configure your application to your requirements. Indeed, you have the latitude to combine innovative drive functions, extensive function libraries and process-oriented technology packages into one perfect automation solution.

Achieve your goals faster

Even large-scale and complex applications can be handled with ease with our ready-to-use function blocks and predefined technology packages. Combine them to form your own user program or simply use them as configurable functions.

Examples of items:

- PLCopen modules
- Cam group
- Print-mark control
- Register control
- Tension control
- Loop control
- Winder
- Demand processing
- Extended drive functions:
 - Variable retraction motion
 - Adaptive feedrate control
 - Analog force control
 - and much more

Selected function blocks and technology packages for IndraMotion MLD are available on CD-ROM:

- Order number:
SWA-IM*MLD-LTE-02VRS-D0-CD650-COPY

Innovative modules for any application

- Functions library:
Collection of function blocks conforming to IEC or PLCopen
- User library:
Collection of function blocks developed by the user
- Technology packages:
Process-oriented function blocks, e.g. tension control
- User program:
Application-specific combination of different function blocks and technology packages

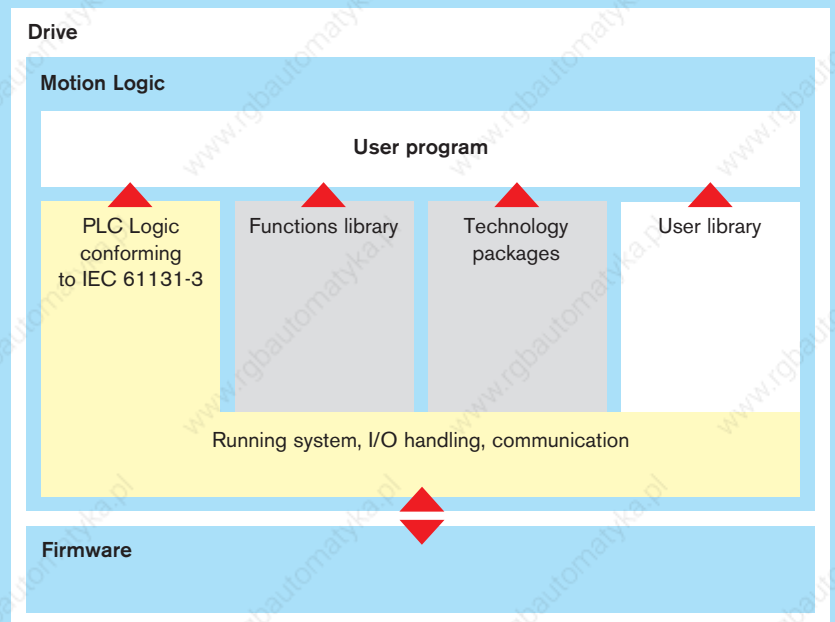

Drive and control system seamlessly coordinated

- Highly-economic solution for single-axis and multi-axis applications without additional hardware
- Minimized engineering thanks to IEC- and PLCopen-compliant configuration
- Predefined technology packages for faster implementation of system solution

Your benefits

Single-axis solution

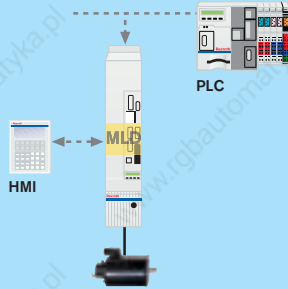

IndraMotion MLD-S
Integrated Motion Logic

Multi-axis solution

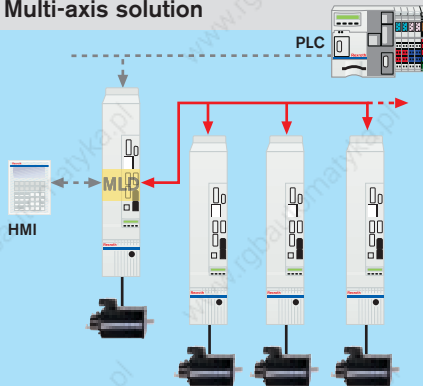

IndraMotion MLD-M
Integrated Motion Logic with cross communication

Achieve your goals faster with standards

The drive-based Motion Logic eliminates the need for higher-level control systems. Standardized programming languages and interfaces also help keep training and engineering costs to a minimum.

By employing ready-to-use function libraries and technology packages you can benefit from available know-how to further reduce engineering costs. You can contribute your own valuable know-how directly to the drive, thereby singling yourself out from your competitors.

| IndraMotion MLD | | MLD-S BASIC | MLD-S ADVANCED | MLD-M ADVANCED |
|--|------|---|---|---|
| Number of axes | | 1 | 1 | up to 8 |
| Hardware requirement (master) | | BASIC control unit CSB | ADVANCED control unit CSH | ADVANCED control unit CSH with option CCD |
| Firmware option | | TF | ML | ML |
| Performance | | | | |
| | | Depends on the utilization of the BASIC drive | 100 µs per 1,000 instructions in IL using bit and word processing | |
| Tasks | | | | |
| Number of tasks | | 4 | | |
| Types of tasks | | Periodic, unsolicited or event-controlled | | |
| Cycle times | ms | 2 | 1 | 1 |
| Program memory | | | | |
| Firmware 03VRS | kB | 192 | | - |
| from firmware 04VRS | kB | approx. 350 | | |
| Retain data memory | | | | |
| on control component | Byte | 248 | 248 | 248 |
| with option MD1 using firmware 03VRS | kB | - | 32 | - |
| with option MD1, MD2 or CCD using firmware 04VRS | kB | - | 32 | 32 |
| Programming | | | | |
| Programming system | | Rexroth IndraWorks MLD | | |
| Programming languages | | Instruction list (IL), Structured text (ST), Functional block diagram (FBD), Ladder diagram (LD), Ladder function (LDF), Sequential function chart (SFC), Continuous function chart (CFC) | | |
| Programming interfaces | | RS232 (Ethernet under development) | | |
| Program debug functions | | Breakpoint, single-step, single cycle, write/force, monitoring, sampling trace, simulation, online change | | |
| Libraries supplied | | System-specific, drive-specific and PLCopen | | |
| Control communication | | | | |
| | | SERCOS interface, PROFIBUS, PROFINET IO, DeviceNet, CANopen, parallel interface, analog interface, analog/digital for OPEN LOOP mode, IndraMotion MLD | | |
| Digital inputs and outputs | | | | |
| Inputs | | 5 ¹⁾ | 7 | Depends on the number and type of control units and option used |
| Inputs/outputs (user defined settings) | | 3 ¹⁾ | 4 | |
| Option MD1 | | - | 12 I/8 O | |
| Option MD2 | | - | 16 I/16 O | |
| Parallel interface | | 16 I/16 O | 16 I/16 O | |
| Analog inputs and outputs | | | | |
| on control unit | | - | 1 I/2 O | Depends on the number and type of control units and option used |
| with option MA1 | | 2 I/2 O | 2 I/2 O | |

¹⁾ applies to control unit CSB01.1C

Safety on Board – integrated safety technology

Whether for machine tools, printing and packaging or mounting, handling and robotics applications – protecting people from uncontrolled machine movements is top priority.

Clear guidelines issued by the EU

All machine manufacturers are obliged to carry out a hazard evaluation and risk analysis prior to construction. This is stipulated in the European Machinery Directive 98/37/EC. Moreover, any potential hazards detected must be eliminated step by step. Safety should be integrated in the machinery and meet current standards in technology.

How safe can you get?

IndraDrive is redefining current standards in technology because IndraDrive integrates the safety directly in the drive, resulting in ultra-short response times. IndraDrive therefore demonstrates the current capacities and requirements of safety technology – IndraDrive is faster because the movement is monitored directly where it is generated. This is the critical advantage, especially when it comes to monitoring direct drives or other high-dynamic drives, for example.

Quickest reaction time with highest drive dynamics

With the new IndraDrive generation from Rexroth, a variety of safety functions are available right inside the drive – without any detours through the control. This increases reliability, saves on additional monitoring components and reduces installation cost and effort.

It is all made possible by redundant software and hardware components in the drive. The non-contacting monitoring of all set limit values enables very short response times of less than 2 ms. As soon as a fault is detected, all the drives are automatically stopped depending on the stop category selected (0, 1 or 2).

Axis movements minimized thanks to ultra-short response times

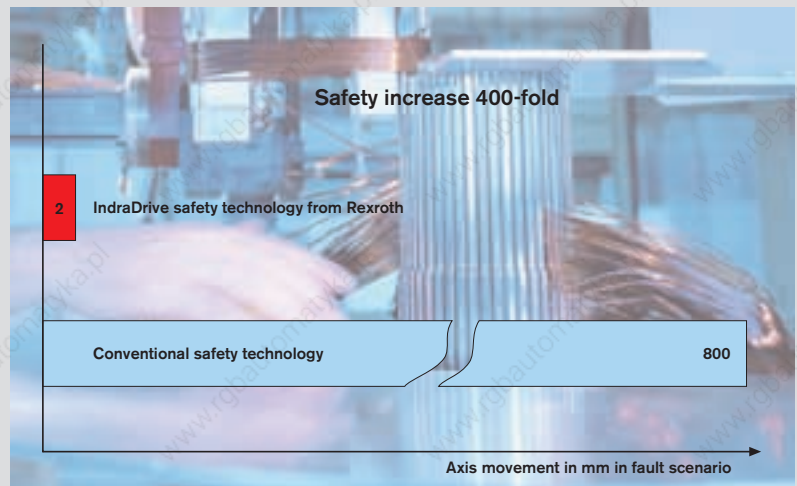

Before a user in the protected area reacts to an error with an acknowledgement linked to contacts, a linear axis with a ball screw has already traveled 100 to 200 mm, linear motors have

already traveled 400 to 800 mm. IndraDrive safety technology finds the error within 2 ms and the axis moves only 2 mm.

Safety functions inside the drive effectively protect people and machines

- High reliability due to certified integrated safety functions according to EN 954-1, Category 3
- Extremely fast reaction times (< 2 ms) for communication with internal monitors
- No need for additional measuring systems or sensors
- Online dynamic sampling of the inputs and shutoff paths while work is in progress
- PROFIsafe interface with reduced configuration and installation effort and safe, de-centralizes I/Os
- Reduced certification effort and short series start-up times



Our safety technology is verified by an accredited organization and certified as conforming to EN 954-1, Category 3.



Intelligent and safe

- ! Safety category 3 certified as conforming to EN 954-1
- ! Extensive safety functions
- ! Minimum response times
- ! Independent of the control system
- ! Straightforward integration in the machine

Your benefits

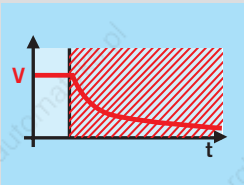

Safe start lockout

(Stop category 0 as per EN 60204-1)
Torque cut-off for drives; drives are safely disconnected from the power supply.

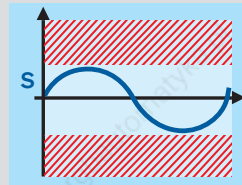

Safe absolute position range and safe software limit switches

In addition to the safely reduced speed and/or safe direction of rotation, it is also possible to select a safe absolute position range.

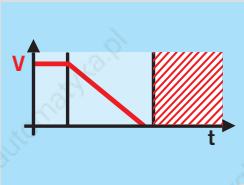

Safe stop

(Stop category 1 as per EN 60204-1)
Monitored shutdown – controlled by controller or drive, torque-free shutdown of drives, drives are safely disconnected from the power supply.

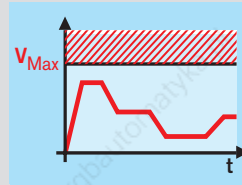

Safe maximum speed limit

The maximum speed is safely monitored regardless of the mode of operation.

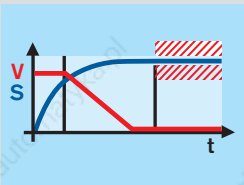

Safe operation stop

(Stop category 2 as per EN 60204-1)
Monitored shutdown – controlled by controller or drive. Shuts down the drives while maintaining all the control functions.

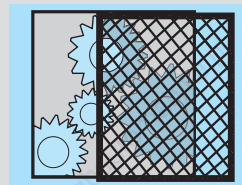

Safe guard door lock

When all the drives in one zone are in safe state, the guard door lock is released.

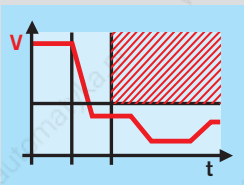

Safe speed reduction

When acknowledgement is given, a safely reduced speed can be used for travel in a special operating mode.

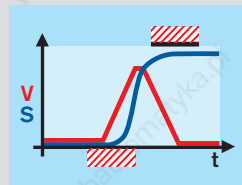

Safe increment limit

When acknowledgement is given, a safely limited increment can be used for travel in a special operating mode.

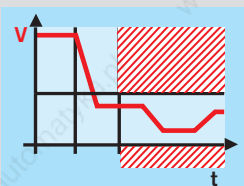

Safe direction of rotation

In addition to a safely reduced speed it is also possible to define a safe direction of rotation.

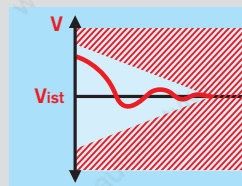

Safely monitored shutdown

This function can be parameterized with safely monitored shutdown time and safely monitored delay time on the basis of the actual velocity.

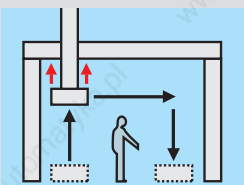

Safe brake and holding system

The safe brake and holding system is based on two independent brakes that are separately activated and monitored by the redundant, diverse channels in the drive.

Safety on Board – be on the safe side

Safe starting lockout

The starting lockout is the most cost-effective solution for preventing the drive from restarting unintentionally. The power supply is cut off electronically.

usually on two channels. The starting lockout is activated via two redundant 24 V signals.

This function can be selected with all control units except BASIC OPEN LOOP.

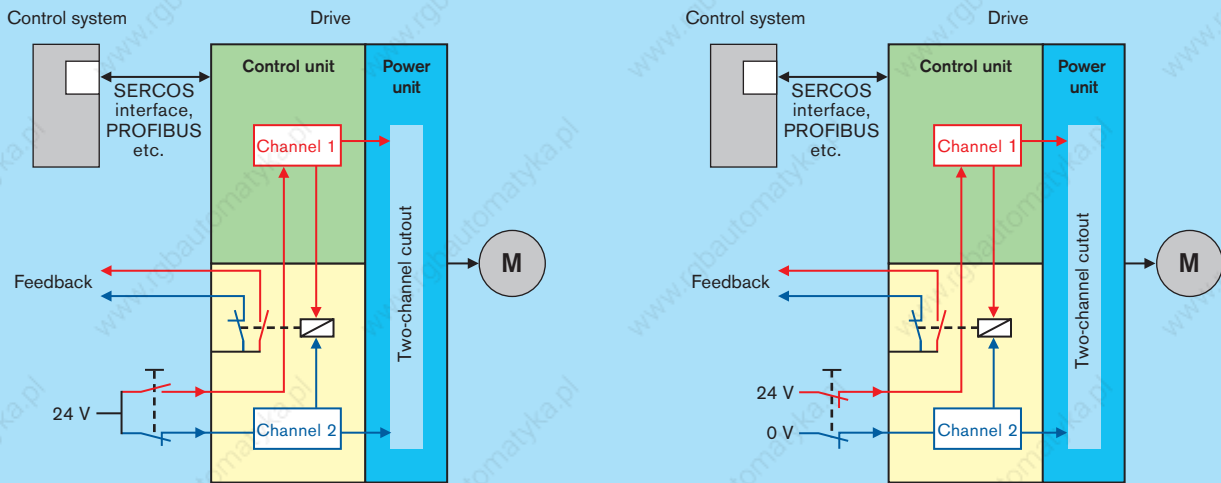

Starting lockout selected via NC/NO contacts or via two NC contacts

Safe stop and safe motion

The ADVANCED and BASIC UNIVERSAL dual-axis control units offer you all the available safety functions – including safe motion and safe absolute position.

This safety is guaranteed by two redundant, diverse processor systems which carry out all the relevant calculations separately and monitor each other.

The two-channel selection of the required safety function can be executed differently.

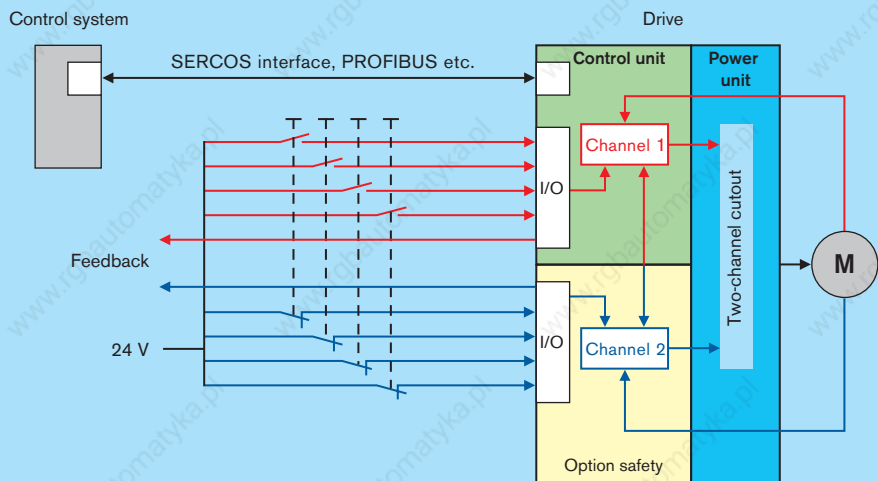

Selection and feedback via 24 V signals – the simplest way

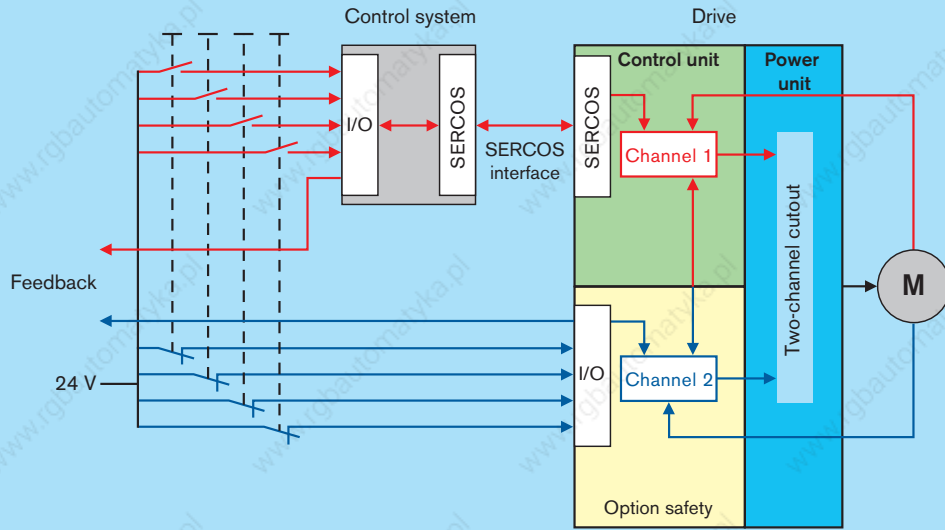

Selection and feedback signal via control communication (channel 1) and 24 V signals (channel 2) – for simpler wiring

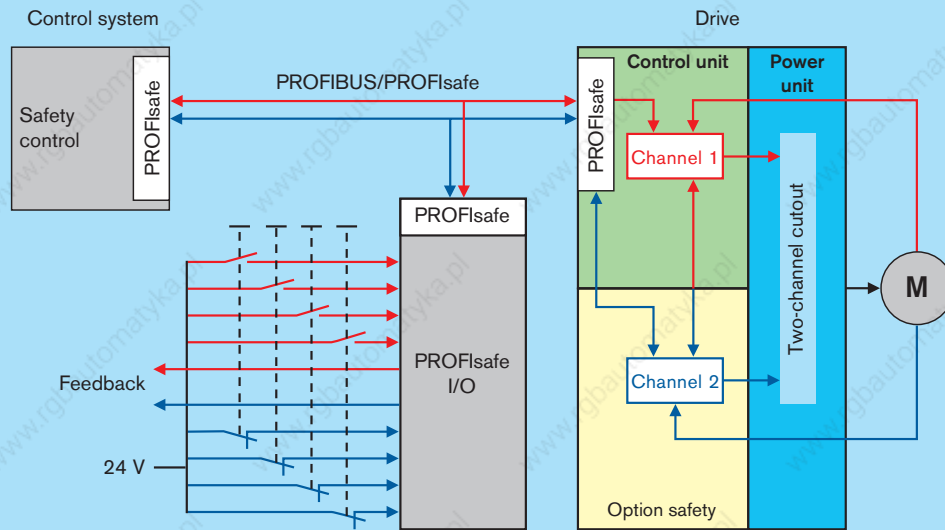

Selection and feedback signal via PROFIsafe – the user-friendly solution

Rexroth IndraWorks – a tool for all engineering tasks

Simple and user-friendly, Rexroth IndraWorks is the ideal engineering environment for all Rexroth electrical control and drive systems. This engineering framework brings together in one integrated interface all the tools required for:

- Configuration
- Programming
- Parameterization
- Operation
- Visualization
- Diagnostics

Advantages

- Integrated software framework for all engineering tasks
- Application-oriented tools
- Intelligent user guidance
- User-friendly, menu-driven operation
- Standardized programming according to IEC 61131-3
- PLCopen-compliant module library
- Open-architecture through integrated FDT/DTM technology
- Microsoft .NET technology

IndraWorks for IndraDrive can be supplied on CD-ROM

- IndraWorks D – for drive engineering:
SWA-IWORKS-D**-xxVRS-D0-CD650-COPY
- IndraWorks MLD – additionally supporting IndraLogic and IndraMotion MLD:
SWA-IWORKS-MLD**-xxVRS-D0-CD650-COPY

Cam editor CamBuilder for IndraWorks (as an option)

- SWA-IWORKS-CAM-xxVRS-D0

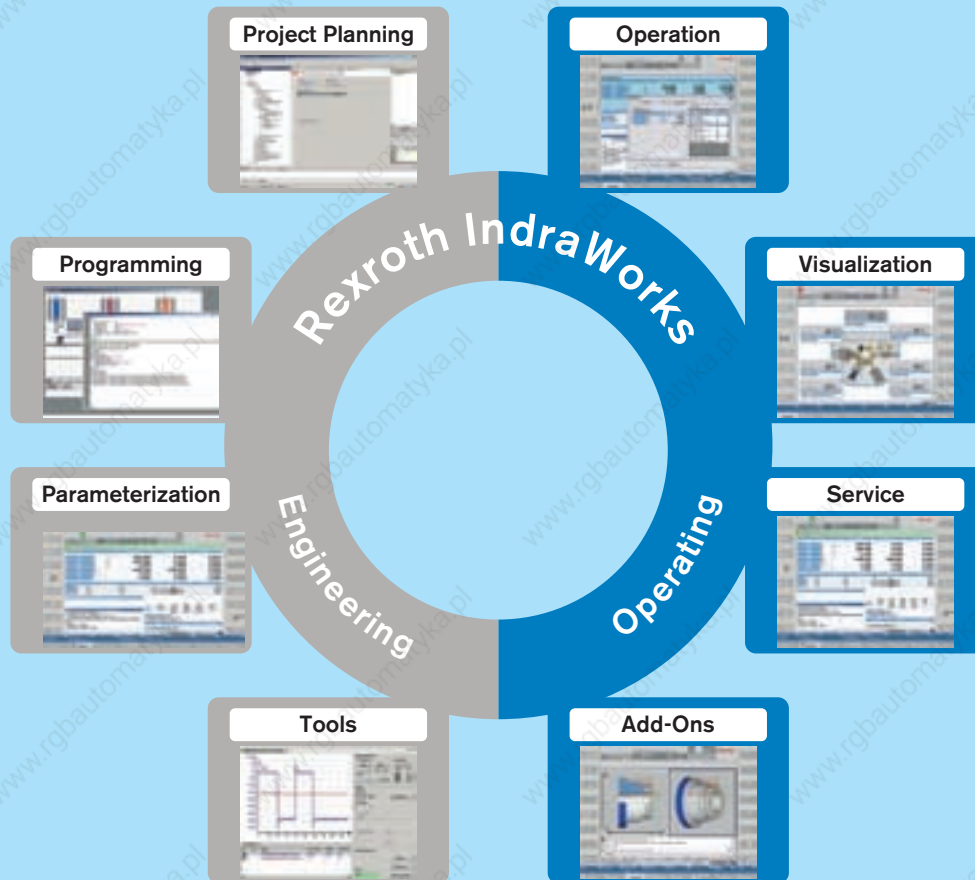

Rexroth IndraWorks – the integrated engineering framework for project planning, programming, parameterization, operation and monitoring

IndraWorks – the universal engineering framework

- ! One tool for all automation tasks
- ! Guided start-up for rapid achievement of results
- ! Offline configuration of projects
- ! User-friendly programming environment

Your benefits

Start-up wizard

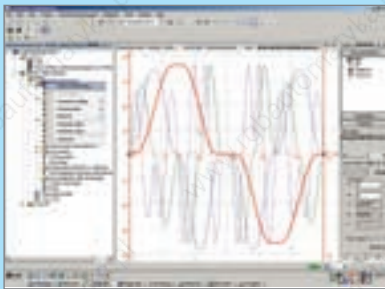

IndraWorks interactively guides you through all the steps of the startup process and only requires you to input the relevant data. All values to be input are directly related to the mechanics of the machine. This simplifies the input of data, along with allowing you to freely select measurement units.

You individually assemble the required sequence of movements from a large selection of positioning modes presented in graphic form. Once compiled, the set of parameters is saved in a file and can be easily transmitted to other machines via fieldbus or the RS232 serial interface.

Offline mode

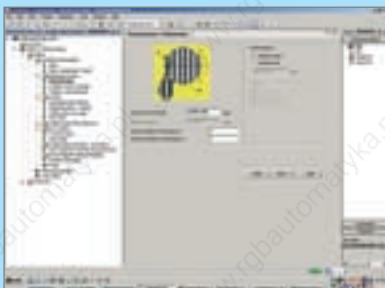

The machine-related modes of operation and the corresponding parameters can be set in advance offline and later transferred to the machine.

Programming



All functionality and programming modes according to IEC 61131-3 are available for the drive-integrated PLC.

With PLCOpen function blocks, you can quickly and transparently integrate drive functionality into your PLC program.

Integrated technology functions

The configurable Motion Logic-based technology functions allow you to perform the full range of different process-oriented tasks – and require no programming skills.

Auto-tuning

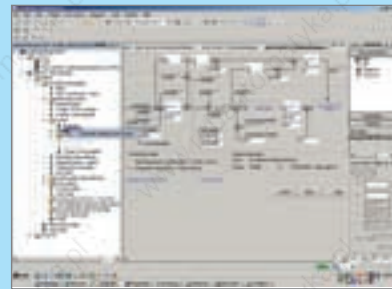

Parameters for all internal control functions are automatically set when IndraDyn motors are connected.

This setting is ideal for the majority of applications, requiring no further adjustment. Where requirements are more complex, the auto-tuning function is available to assist with adjusting the control settings to your machine.

Four-channel oscilloscope

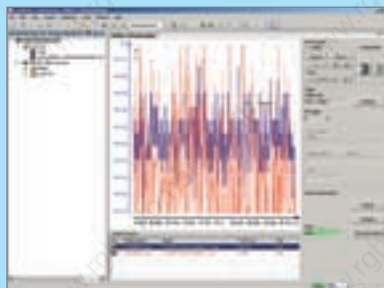

The integrated four-channel oscilloscope is available to assist with drive optimization, troubleshooting and preventive maintenance. For documentation purposes all the measurements and the related settings can be printed out or saved to a file.

CamBuilder (optional)

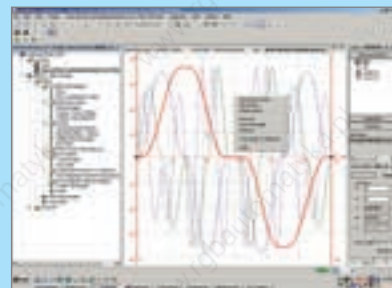

Rexroth CamBuilder is a graphics-based software tool for the convenient creation of electronic cams. With a few inputs, you can implement various applications easily and quickly. The established cams are directly transferable to Rexroth drives and controls.

Rexroth IndraSize – rapid and safe sizing

IndraSize – the user-friendly program for drive sizing – is the quickest way to finding the optimum drive for your machine. Regardless of whether you are using a conventional servo axis or direct drive, IndraSize allows you to define the ideal motor/drive combination in a few steps.

Mechanics

IndraSize is compatible with all standard drive mechanisms such as:

- Ball screw with rotating screw
- Ball screw with rotating nut
- Rack and pinion
- Belt drive
- Direct drive, linear
- Direct drive, rotary
- Roll feed
- Cross cutter

With the aid of graphics you simply simulate your machine kinematics, combining the motor and the selected mechanical parts with the various transfer units:

- Coupling
- Belt drive
- Gears

Any number of these can be combined in any order.



Motion profile

With IndraSize you can freely compile a full motion profile from individual sequences of movements. If applicable, you may use higher-order equations of motion as e. g. polynomials or sines. Alternatively, import ready-made cams generated with the CamBuilder.

Moreover, IndraSize allows you to define typical applications very simply by inputting parameters. Applications can be configured in next to no time, such as:

- Roll feeds
- Press feeders
- Flying cutoff
- Winders
- Cross cutters

Download

IndraSize can be downloaded from the Internet at www.boschrexroth.com/indrasize

Mechanical system



Ball screw with rotating screw



Ball screw with rotating nut



Belt drive



Gear rack and pinion



Direct drive, linear



Direct drive, rotary



Roller mechanics

and much more

Five steps to your drive solution

Regardless of whether you want to tackle a simple or complex drive task – whatever the case, IndraSize will lead you confidently through just five steps to success. Let the menu take you through the individual program steps from selecting the mechanical system and associated motion profile right through to the point where you are presented with the optimum motor/drive combination together with a table or curve showing its performance data.

1. Step:
Select mechanical system and motion profile



4. Step:
Select the drive from the filtered list generated



2. Step:
Input mechanical and link element data



5. Step:
Specify the presentation of results



3. Step:
Define the motion cycle



Rexroth IndraDyn – motors and gearboxes



Rexroth

A powerful family

- Extensive range including robust housed and frameless (kit) motors
- Coverage of entire power range
- High-precision encoder systems
- Highly-dynamic synchronous linear motors
- Special hazardous duty designs conforming to ATEX or UL/CSA

Your benefits

IndraDyn S

Synchronous MSK servo motors for all requirements up to 448 Nm
Synchronous MKE servo motors with explosion-proof enclosure for potentially explosive atmospheres up to 190 Nm

IndraDyn A

Air-cooled asynchronous MAD servo motors with power ratings up to 100 kW
Liquid-cooled asynchronous MAF servo motors with power ratings up to 120 kW

IndraDyn L

Synchronous linear motors for feeding forces of up to 21,500 N

IndraDyn T

Synchronous torque motors with torque ratings up to 13,800 Nm and speeds of up to 4,000 rpm

IndraDyn H

High-speed frameless (kit) motors for speeds of up to 30,000 rpm and maximum torques of up to 4,500 Nm

1MB

Asynchronous frameless (kit) motors for speeds of up to 20,000 rpm and rated torques of up to 875 Nm

Servo gearbox

GTE servo planetary gears for standard applications
GTM servo planetary gears for high-performance applications

Standard and geared motors

Wide range of motors made by well-known manufacturers for combining with IndraDrive



IndraDyn S – MSK servo motors to meet all requirements

The particularly outstanding features of the MSK range of motors are its wide power spectrum and narrow size increments. The high torque density of these synchronous servo motors allows a particularly compact design with maximum torques of up to 448 Nm.

Depending on the level of precision required, we can supply the motors with encoder systems for standard or high-precision requirements. Both encoder versions are available in a single-turn and multi-turn configuration.

A number of further options, such as the shaft keyway, holding brake, reduced runout and the high protection category IP65 mean that they can be used in virtually any application.





Compact and powerful

- ! Maximum torques up to 448 Nm
- ! Maximum speeds up to 9,000 rpm
- ! Encoder systems for a wide and diverse range of applications
- ! High protection category IP65
- ! Choice of cooling systems

Your benefits

The simple step-by-step guide to ordering your MSK servo motor:

Option
MSK060C-0600-NN-S1-UG0-NNNN

Motor

- Size (e. g. "060")
- Overall length (e. g. "C")
- Winding (e. g. "0600")

Cooling system

NN = Natural convection

Surface cooling or (FN)
 Option of liquid cooling for certain sizes

Encoder

- S1** = Single-turn encoder (Hiperface) 128 increments
- M1** = Multi-turn encoder (Hiperface) 128 increments with 4096 revolutions absolute
- S2** = Single-turn encoder (EnDat) 2048 increments
- M2** = Multi-turn encoder (EnDat) 2048 increments with 4096 revolutions absolute

Shaft

- G** = Plain shaft with shaft sealing ring
- P** = Keyway conforming to DIN 6885-1 and shaft sealing ring

Other versions

- N** = Standard
 - S¹⁾** = Hazardous duty version conforming to Equipment Group II, Category 3, G and D
- ¹⁾ hazardous duty design available for certain sizes

Shaft runout

- N** = Standard, in conjunction with S1 or M1 encoder only
- R** = Reduced, linear movement conforming to DIN 42955, in conjunction with S2 or M2 encoder only

Holding brake

- 0** = without holding brake
- 1** = with electr. released holding brake

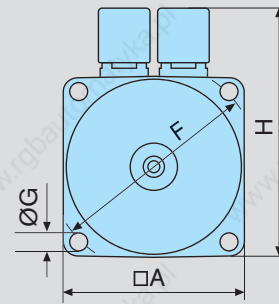
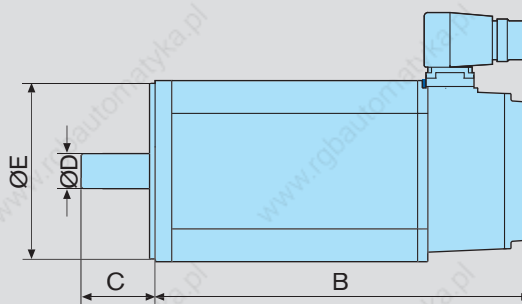
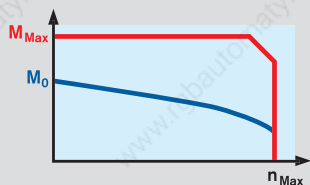

IndraDyn S – technical data

| Motor | | Maximum speed ¹⁾ | Cont. torque at standstill | Maximum torque | Cont. current at standstill | Maximum current | Moment of inertia | Dimensions | | | | | | | Mass ²⁾ | |
|--------|--------|-----------------------------|----------------------------|-----------------------|-----------------------------|----------------------|------------------------------------|------------|--------|--------|----------|----------|----------|----------|--------------------|-----------|
| | | n _{Max} [rpm] | M ₀ [Nm] | M _{Max} [Nm] | I ₀ [A] | I _{Max} [A] | J _R [kgm ²] | A [mm] | B [mm] | C [mm] | Ø D [mm] | Ø E [mm] | Ø F [mm] | Ø G [mm] | H [mm] | m [kg] |
| MSK030 | B-0900 | 9,000 | 0.4 | 1.8 | 1.5 | 6.8 | 0.000013 | 54 | 152.5 | 20 | 9 | 40 | 63 | 4.5 | 98.5 | 1.3/1.6 |
| | C-0900 | 9,000 | 0.8 | 4.0 | 1.5 | 6.8 | 0.000030 | | 188 | | | | | | | 1.9/2.1 |
| MSK040 | B-0450 | 6,500 | 1.7 | 5.1 | 1.5 | 6.0 | 0.000100 | 82 | 155.5 | 30 | 14 | 50 | 95 | 6.6 | 124.5 | 2.8/3.1 |
| | B-0600 | 7,500 | | | 2.0 | 8.0 | | | | | | | | | | |
| | C-0450 | 6,500 | 2.7 | 8.1 | 2.4 | 9.6 | 0.000140 | | 185.5 | | | | | | | 3.6/3.9 |
| | C-0600 | 7,500 | | | 3.1 | 12.4 | | | | | | | | | | |
| MSK050 | B-0300 | 4,300 | 3.0 | 9.0 | 1.8 | 7.2 | 0.000280 | 98 | 173 | 40 | 19 | 95 | 115 | 9 | 134.5 | 4.0/4.9 |
| | B-0450 | 4,500 | | | 3.1 | 12.4 | | | | | | | | | | |
| | B-0600 | 6,000 | | | 3.7 | 14.8 | | | | | | | | | | |
| | C-0300 | 4,700 | 5.0 | 15.0 | 3.1 | 12.4 | 0.000330 | | 203 | | | | | | | 5.4/6.3 |
| | C-0450 | 6,000 | | | 4.7 | 18.8 | | | | | | | | | | |
| | C-0600 | 6,000 | | | 6.2 | 24.8 | | | | | | | | | | |
| MSK060 | B-0300 | 4,800 | 5.0 | 15.0 | 3.0 | 12.0 | 0.000480 | 116 | 181 | 50 | 24 | 95 | 130 | 9 | 156 | 5.7/6.4 |
| | B-0600 | 6,000 | | | 6.1 | 24.4 | | | | | | | | | | |
| | C-0300 | 4,900 | 8.0 | 24.0 | 4.8 | 19.2 | 0.000800 | | 226 | | | | | | | 8.4/9.2 |
| | C-0600 | 6,000 | | | 9.5 | 38.0 | | | | | | | | | | |
| MSK061 | C-0200 | 3,000 | 8.0 | 32.0 | 3.1 | 14.0 | 0.000752 | 116 | 264 | 40 | 19 | 95 | 130 | 9 | 156 | 8.3/8.8 |
| | C-0300 | 4,200 | | | 4.3 | 19.4 | | | | | | | | | | |
| | C-0600 | 6,000 | | | 7.7 | 34.7 | | | | | | | | | | |
| MSK070 | C-0150 | 2,500 | 13.0 | 33.0 | 4.1 | 16.4 | 0.002910 | 140 | 238 | 58 | 32 | 130 | 165 | 11 | 202 | 11.7/13.2 |
| | C-0300 | 5,500 | | | 8.2 | 32.8 | | | | | | | | | | |
| | C-0450 | 6,000 | | | 12.3 | 36.9 | | | | | | | | | | |
| | D-0150 | 2,700 | 17.5 | 52.5 | 6.2 | 24.8 | 0.003750 | | 268 | | | | | | | 14.0/15.6 |
| | D-0300 | 4,900 | | | 11.0 | 33.0 | | | | | | | | | | |
| | D-0450 | 6,000 | 23.0 | 60.0 | 16.6 | 49.8 | 0.004580 | | 298 | | | | | | | 16.2/17.8 |
| | E-0150 | 2,200 | | | 6.4 | 25.6 | | | | | | | | | | |
| | E-0300 | 5,300 | | | 15.4 | 46.3 | | | | | | | | | | |
| MSK071 | E-0450 | 6,000 | 12.0 | 44.0 | 19.3 | 57.9 | 0.001730 | 140 | 272 | 58 | 32 | 130 | 165 | 11 | 202 | 13.9/15.8 |
| | C-0200 | 3,500 | | | 5.2 | 23.4 | | | | | | | | | | |
| | C-0300 | 5,000 | | | 7.3 | 32.9 | | | | | | | | | | |
| | C-0450 | 5,800 | 17.5 | 66.0 | 8.9 | 40.1 | 0.002550 | | 312 | | | | | | | 18.0/19.6 |
| | D-0200 | 3,200 | | | 7.3 | 32.8 | | | | | | | | | | |
| | D-0300 | 3,800 | 23.0 | 84.0 | 9.1 | 40.5 | 0.002900 | | 352 | | | | | | | 23.5/25.1 |
| | D-0450 | 6,000 | | | 15.4 | 69.3 | | | | | | | | | | |
| | E-0200 | 3,400 | | | 10.1 | 45.5 | | | | | | | | | | |
| E-0300 | 4,200 | 23.0 | 84.0 | 12.5 | 56.3 | 0.002900 | 352 | 23.5/25.1 | | | | | | | | |
| E-0450 | 6,000 | | | 20.0 | 90.1 | | | | | | | | | | | |

| Motor | Maximum speed ¹⁾ | Cont. torque at standstill | Maximum torque | Cont. current at standstill | Maximum current | Moment of inertia | Dimensions | | | | | | | | Mass ²⁾ | |
|--------|-----------------------------|----------------------------|----------------|-----------------------------|-----------------|---------------------------|------------|--------|--------|----------------------|----------------------|----------------------|----------------------|--------|--------------------|-----------|
| | n_{Max} [rpm] | M_0 [Nm] | M_{Max} [Nm] | I_0 [A] | I_{Max} [A] | J_R [kgm ²] | A [mm] | B [mm] | C [mm] | $\varnothing D$ [mm] | $\varnothing E$ [mm] | $\varnothing F$ [mm] | $\varnothing G$ [mm] | H [mm] | m [kg] | |
| MSK075 | C-0200 | 4,000 | 12.0 | 44.0 | 5.9 | 26.4 | 0.003520 | 140 | 307 | 58 | 32 | 130 | 165 | 11 | 202 | 14.8/16.4 |
| | C-0300 | 4,500 | | | 8.2 | 36.9 | | | | | | | | | | |
| | C-0450 | 6,000 | | | 12.3 | 55.4 | | | | | | | | | | |
| | D-0200 | 4,000 | 17.0 | 66.0 | 8.1 | 36.6 | 0.004900 | 140 | 347 | 58 | 32 | 130 | 165 | 11 | 202 | 19.0/20.1 |
| | D-0300 | 4,500 | | | 11.4 | 51.3 | | | | | | | | | | |
| | D-0450 | 6,000 | | | 16.1 | 72.5 | | | | | | | | | | |
| | E-0200 | 3,850 | 21.0 | 88.0 | 10.2 | 45.9 | 0.006130 | 140 | 387 | 58 | 32 | 130 | 165 | 11 | 202 | 22.5/23.6 |
| | E-0300 | 5,200 | | | 14.2 | 63.9 | | | | | | | | | | |
| E-0450 | 6,000 | 18.4 | | | 82.7 | | | | | | | | | | | |
| MSK076 | C-0300 | 4,700 | 12.0 | 43.5 | 7.2 | 32.4 | 0.004300 | 140 | 292.5 | 50 | 24 | 110 | 165 | 11 | 180 | 13.8/14.9 |
| | C-0450 | 5,000 | | | 12.2 | 54.9 | | | | | | | | | | |
| MSK100 | A-0200 | 4,000 | 15.0 | 54.0 | 9.3 | 41.7 | 0.011000 | 192 | 302 | 60 | 32 | 130 | 215 | 11 | 211.5 | 23.0/24.1 |
| | A-0300 | 4,000 | | | 10.3 | 46.5 | | | | | | | | | | |
| | A-0450 | 4,500 | | | 12.1 | 54.4 | | | | | | | | | | |
| | B-0200 | 4,100 | 28.0 | 102.0 | 14.7 | 66.2 | 0.019200 | 192 | 368 | 60 | 32 | 130 | 215 | 11 | 211.5 | 34.0/36.0 |
| | B-0300 | 4,750 | | | 17.4 | 78.3 | | | | | | | | | | |
| | B-0400 | 4,500 | | | 23.7 | 106.7 | | | | | | | | | | |
| | B-0450 | 4,500 | 38.0 | 148.0 | 28.5 | 110.7 | 0.027300 | 192 | 434 | 60 | 32 | 130 | 215 | 11 | 211.5 | 45.1/50.0 |
| | C-0200 | 3,500 | | | 17.7 | 79.7 | | | | | | | | | | |
| | C-0300 | 4,500 | | | 21.6 | 97.2 | | | | | | | | | | |
| | C-0450 | 4,000 | 48.0 | 187.0 | 35.4 | 159.3 | 0.035000 | 192 | 502 | 60 | 32 | 130 | 215 | 11 | 211.5 | 56.0/59.5 |
| D-0200 | 2,100 | 13.0 | | | 58.5 | | | | | | | | | | | |
| D-0300 | 3,000 | 20.7 | | | 93.2 | | | | | | | | | | | |
| MSK101 | C-0200 | 4,000 | 32.0 | 110.0 | 15.3 | 69.3 | 0.006500 | 192 | 350 | 80 | 38 | 180 | 215 | 14 | 258 | 28.3/32.1 |
| | C-0300 | 4,500 | | | 18.7 | 84.2 | | | | | | | | | | |
| | C-0450 | 6,000 | | | 25.9 | 116.5 | | | | | | | | | | |
| | D-0200 | 3,400 | 50.0 | 160.0 | 22.2 | 99.9 | 0.009320 | 192 | 410 | 80 | 38 | 180 | 215 | 14 | 258 | 40.0/43.8 |
| | D-0300 | 4,600 | | | 30.6 | 137.7 | | | | | | | | | | |
| | D-0450 | 6,000 | | | 41.7 | 187.7 | | | | | | | | | | |
| | E-0200 | 3,500 | 70.0 | 231.0 | 32.1 | 144.5 | 0.013800 | 192 | 501 | 80 | 38 | 180 | 215 | 14 | 258 | 53.5/57.3 |
| | E-0300 | 4,600 | | | 41.6 | 187.4 | | | | | | | | | | |
| E-0450 | 6,000 | 58.3 | | | 262.4 | | | | | | | | | | | |
| MSK131 | B-0200 | 3,400 | 85.0 | 220.0 | 36.7 | 165.0 | 0.023200 | 303 | 470 | 110 | 48 | 250 | 300 | 18 | 337 | 84.0/89.4 |
| | D-0200 | 3,000 | | | 62.5 | 281.4 | | | | | | | | | | |

All the specifications relate to the basic version of the motor with encoder S1 and without holding brake

¹⁾ at 750 V DC bus voltage

²⁾ values without/with standard holding brake

IndraDyn S – MKE servo motors for potentially explosive areas

The MKE range of motors are specifically designed for use in production plants susceptible to explosive mixtures of air and flammable gases, vapors, mist or dust:

- Chemical industry
- Mining
- Printing shops
- Woodworking
- Paint shops
- Mills
- Food processing industry
- Refineries
- Tank farms
and much more

Within the broad range of torques up to a maximum of 190 Nm, there is a choice of various sizes of motor with flameproof enclosures. Needless to say, all are ATEX certified and/or UL/CSA compliant.

These motors can also be supplied with a range of options – holding brake, keyway and single- or multi-turn encoder systems.



The simple step-by-step guide to ordering your MKE servo motor:

MKE037B-144-AGO-BENN

Motor

- Size (e. g. "037")
- Overall length (e. g. "B")
- Winding (e. g. "144")

Encoder

- A** = Single-turn encoder (Hiperface) 128 increments
- B¹⁾** = Single-turn encoder (EnDat) 2048 increments
- C** = Multi-turn encoder (Hiperface) 128 increments with 4096 revolutions absolute
- D¹⁾** = Multi-turn encoder (EnDat) 2048 increments with 4096 revolutions absolute

¹⁾ not applicable to MKE037 and MKE047

Shaft

- G** = Plain shaft with shaft sealing ring
- P** = Keyway conforming to DIN 6885-1 and shaft sealing ring

Option

Cable entry

- 4** = Diameter 13 – 16 mm
- 6** = Diameter 17 – 19.5 mm
- N** = Conforming to American Standard (UL)

Housing design

- E²⁾** = Conforming to European standard (ATEX)
 - U** = Conforming to American standard (UL)
- ²⁾ version E only available with power connection option B

Power connection

- A** = on the A-Side
- B** = on the B-Side
- L** = Left
- R** = Right

Holding brake

- 0** = without holding brake
- 1** = with electr. released holding brake



Ultra-safe

- ! Maximum torques up to 190 Nm
- ! Maximum speeds up to 9,000 rpm
- ! Range of encoder systems
- ! Explosion-proof enclosure
- ! Compliance with ATEX and UL/CSA

Your benefits

| Motor | Maximum speed | Cont. torque at standstill | Maximum torque | Cont. current at standstill | Maximum current | Moment of inertia | Dimensions | | | | | | | | Mass ¹⁾ | |
|--------|---------------|----------------------------|----------------|-----------------------------|-----------------|-------------------|-----------------|------------|----------------|-----------|-------------------------------|-----------|--------|--------|--------------------|----------------------|
| | | | | | | | n_{Max} [rpm] | M_0 [Nm] | M_{Max} [Nm] | I_0 [A] | I_{Max} [kgm ²] | J_R [A] | A [mm] | B [mm] | C [mm] | $\varnothing D$ [mm] |
| MKE037 | B-144 | 9,000 | 0.9 | 4.0 | 4.7 | 21.2 | 0.000030 | 60 | 283 | 20 | 9 | 40 | 70 | 4.5 | 123 | 2.5/2.8 |
| MKE047 | B-144 | 6,000 | 2.7 | 11.3 | 7.1 | 32.0 | 0.000170 | 88 | 287 | 30 | 14 | 50 | 100 | 6.6 | 146 | 5.5/5.8 |
| MKE098 | B-047 | 3,200 | 12.0 | 43.5 | 13.9 | 62.6 | 0.004300 | 144 | 383 | 50 | 24 | 110 | 165 | 11 | 202 | 18.0/19.1 |
| | B-058 | 4,000 | | 43.5 | 17.5 | 79.0 | | | | | | | | | | |
| | B-024 | 2,000 | 28.0 | 102.0 | 21.7 | 97.7 | 0.019400 | 194 | 492 | 60 | 32 | 130 | 215 | 14 | - | 44.0/45.1 |
| | B-058 | 4,000 | | | 40.1 | 180.5 | | | | | | | | | | |
| MKE118 | D-012 | 1,000 | 48.0 | 187.0 | 17.5 | 78.8 | 0.036200 | 194 | 664 | 60 | 32 | 130 | 215 | 14 | - | 65.0/69.1 |
| | D-027 | 2,000 | | | 31.3 | 140.9 | | | | | | | | | | |
| | D-035 | 3,000 | | | 42.2 | 190.0 | | | | | | | | | | |

¹⁾ values without/with standard holding brake

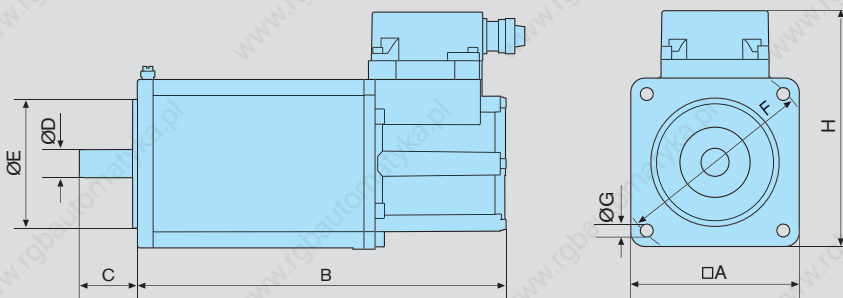
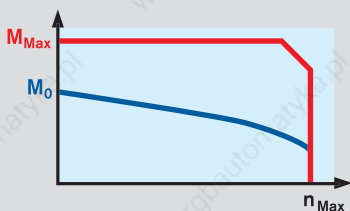

Internationally recognized certification

MKE motors have been certified by the German metrology institute providing scientific and technical services, the PTB Braunschweig, in accordance with Directive 94/9/EC – ATEX95 (PTB 03 ATEX 1108 X Ex II 2 G/D EEx d IIB T4 IP6X T 135 °C).

The certificates are recognized by all member states of the European Union as well as non-European members of the CENELEC.

MKE motors based on the American standard (UL/CSA) conforming to Class I, Groups C and D as per UL508C, UL674 and UL1446, have been certified directly by Underwriters Laboratories Inc. (UL) in the USA.

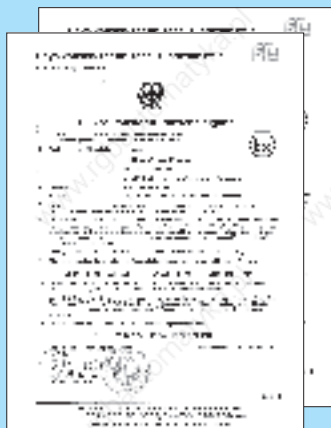

MKE as per ATEX – terminal box with EExd cable connectors



MKE as per UL/CSA – terminal box with lines for conduit installation

IndraDyn A – MAD asynchronous servo motors for high performance

With their phenomenal power density, the MAD range of motors is predestined for servo and main spindle applications, such as in machine tools, printing presses or metal forming technology.

High-resolution single-turn or multi-turn encoder systems and outstanding true running quality guarantee highest

handling precision. In addition to the optional keyway and holding brake, these motors can also be supplied with a special bearing assembly for high-speed applications or for applications with increased radial load.

The motor protection category IP65 even includes the fan motor, making it suitable for harsh industrial use.

The easy-maintenance design of the motor means that it is even possible to exchange the fan while the motor is running – particularly advantageous in the printing industry.





Robust and easy-maintenance

- ▮ Rated outputs of up to 100 kW
- ▮ Maximum speeds up to 11,000 rpm
- ▮ Encoder systems for a wide and diverse range of applications
- ▮ High protection category IP65, including fan motor
- ▮ Easy-maintenance motor design

Your benefits

The simple step-by-step guide to ordering your MAD asynchronous servo motor:

Option
MAD100C-0100-SA-S2-AH0-05-N1

Motor

- Size (e. g. "100")
- Overall length (e. g. "C")
- Winding (e. g. "0100")

Cooling system

- SA** = Axial-flow fan
- SL** = Fan cowl

Encoder

- S2** = Single-turn encoder (EnDat) 2048 increments
- M2** = Multi-turn encoder (EnDat) 2048 increments with 4096 revolutions absolute
- S6¹⁾** = Single-turn encoder (EnDat) 2048 increments for potentially explosive atmospheres
- M6¹⁾** = Multi-turn encoder (EnDat) 2048 increments and 4096 revolutions, for potentially explosive atmospheres
- C0** = Incremental encoder 2048 increments

¹⁾ equipment group II 2G, type of protection EEx p d IIB T3 only in combination with cooling option SL

Line terminal

- A** = Plug for A side
- B** = Plug for B side
- L** = Plug left
- R** = Plug right
- F** = Terminal box for A side
- K** = Terminal box for B side
- T** = Terminal box left
- S** = Terminal box right

Shaft

- G** = Plain shaft with sealing ring
- H** = Plain shaft without sealing ring
- P** = with keyway and sealing ring
- Q** = with keyway but without sealing ring

Vibration severity grade

- 1** = A
- 3** = B

Bearing assembly

- N** = Standard
 - H²⁾** = High speed
 - V²⁾** = Heavy duty
- ²⁾ only for certain sizes

Construction

- 05** = Flange-mounted
- 35** = Flange-mounted or foot-mounted

Holding brake

- 0** = without holding brake
 - 1** = with electr. released holding brake
 - 3³⁾** = with electr. released holding brake, heavy duty
 - 5** = with electr. clamped holding brake
- ³⁾ only for certain sizes

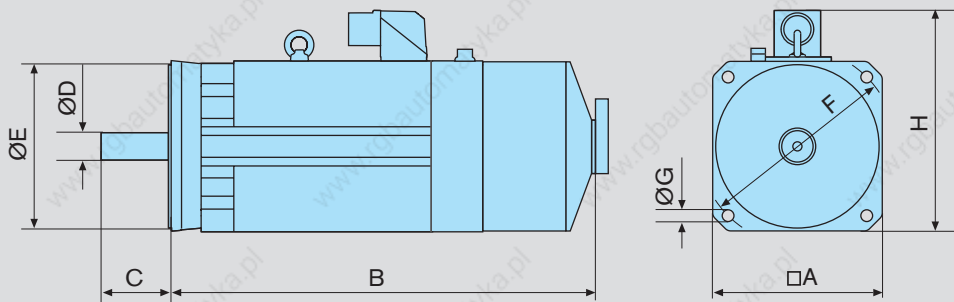
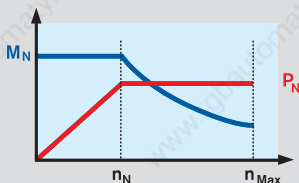

IndraDyn A – technical data

| Motor | Rated speed | Maximum speed | Rated torque | Maximum torque | Rated power | Rated current | Moment of inertia | Dimensions | | | | | | | Mass ²⁾ | | |
|--------|-------------------------|---------------------------|------------------------|--------------------------|------------------------|-----------------------|---------------------------------------|------------|-----------|-----------|-------------|-------------|-------------|-------------|-------------------------|--------------|-----|
| | n _N [rpm] | n _{Max} [rpm] | M _N [Nm] | M _{Max} [Nm] | P _N [kW] | I _N [A] | J _R [kgm ²] | A [mm] | B [mm] | C [mm] | Ø D [mm] | Ø E [mm] | Ø F [mm] | Ø G [mm] | H ¹⁾ [mm] | m [kg] | |
| MAD100 | B-0050 | 500 | 3,000 | 34 | 75.1 | 1.8 | 5.3 | 0.0190 | 192 | 462 | 60 | 32 | 130 | 215 | 14 | 277 (264) | 43 |
| | B-0100 | 1,000 | 6,000 | 31 | 74.7 | 3.2 | 8.9 | | | | | | | | | | |
| | B-0150 | 1,500 | 9,000 | 30 | 68.0 | 4.7 | 12.9 | | | | | | | | | | |
| | B-0200 | 2,000 | 11,000 | 28 | 66.2 | 5.9 | 14.6 | | | | | | | | | | |
| | B-0250 | 2,500 | 11,000 | 25 | 61.5 | 6.5 | 16.2 | | | | | | | | | | |
| | C-0050 | 500 | 3,000 | 51 | 112.3 | 2.7 | 8.2 | 0.0284 | 192 | 537 | 60 | 32 | 130 | 215 | 14 | 277 (264) | 59 |
| | C-0100 | 1,000 | 6,000 | 50 | 118.8 | 5.2 | 13.2 | | | | | | | | | | |
| | C-0150 | 1,500 | 9,000 | 48 | 110.4 | 7.5 | 19.7 | | | | | | | | | | |
| | C-0200 | 2,000 | 11,000 | 45 | 105.5 | 9.4 | 25.7 | | | | | | | | | | |
| | C-0250 | 2,500 | 11,000 | 40 | 91.0 | 10.5 | 27.8 | | | | | | | | | | |
| | D-0050 | 500 | 3,000 | 70 | 153.6 | 3.7 | 10.1 | 0.0392 | 192 | 612 | 60 | 32 | 130 | 215 | 14 | 277 (264) | 72 |
| | D-0100 | 1,000 | 6,000 | 64 | 146.5 | 6.7 | 19.3 | | | | | | | | | | |
| D-0150 | 1,500 | 9,000 | 59 | 140.8 | 9.3 | 25.6 | | | | | | | | | | | |
| D-0200 | 2,000 | 11,000 | 54 | 129.8 | 11.3 | 27.2 | | | | | | | | | | | |
| D-0250 | 2,500 | 11,000 | 50 | 118.7 | 13.1 | 32.4 | | | | | | | | | | | |
| MAD130 | B-0050 | 500 | 3,000 | 95 | 208.8 | 5.0 | 12.8 | 0.0840 | 260 | 570 | 110 | 42 | 250 | 300 | 18 | 345 (340) | 100 |
| | B-0100 | 1,000 | 6,000 | 100 | 230.0 | 10.5 | 26.9 | | | | | | | | | | |
| | B-0150 | 1,500 | 9,000 | 85 | 200.0 | 13.4 | 34.9 | | | | | | | | | | |
| | B-0200 | 2,000 | 10,000 | 80 | 187.2 | 16.8 | 43.0 | | | | | | | | | | |
| | B-0250 | 2,500 | 10,000 | 75 | 176.5 | 19.6 | 47.2 | | | | | | | | | | |
| | C-0050 | 500 | 3,000 | 140 | 307.9 | 7.3 | 19.7 | 0.1080 | 260 | 640 | 110 | 42 | 250 | 300 | 18 | 345 (340) | 122 |
| | C-0100 | 1,000 | 6,000 | 125 | 305.0 | 13.1 | 36.2 | | | | | | | | | | |
| | C-0150 | 1,500 | 9,000 | 117 | 275.2 | 18.4 | 48.9 | | | | | | | | | | |
| | C-0200 | 2,000 | 10,000 | 110 | 252.9 | 23.0 | 57.0 | | | | | | | | | | |
| | C-0250 | 2,500 | 10,000 | 100 | 250.0 | 26.2 | 62.0 | | | | | | | | | | |
| | D-0050 | 500 | 3,000 | 180 | 395.6 | 9.4 | 24.2 | 0.1640 | 260 | 770 | 110 | 42 | 250 | 300 | 18 | 345 (340) | 165 |
| | D-0100 | 1,000 | 6,000 | 170 | 417.8 | 17.8 | 43.7 | | | | | | | | | | |
| D-0150 | 1,500 | 9,000 | 155 | 374.6 | 24.3 | 61.5 | | | | | | | | | | | |
| D-0200 | 2,000 | 10,000 | 150 | 340.7 | 31.4 | 71.3 | | | | | | | | | | | |
| D-0250 | 2,500 | 10,000 | 120 | 310.0 | 31.4 | 72.0 | | | | | | | | | | | |

| Motor | Rated speed | Maximum speed | Rated torque | Maximum torque | Rated power | Rated current | Moment of inertia | Dimensions | | | | | | | | Mass ²⁾ | | | | | | | |
|--------|-------------------------|---------------------------|------------------------|--------------------------|------------------------|-----------------------|---------------------------------------|------------|-----------|-----------|-------------|-------------|-------------|-------------|-------------------------|--------------------|------|-----|-----|-----|-------|-----|-----|
| | n _N [rpm] | n _{Max} [rpm] | M _N [Nm] | M _{Max} [Nm] | P _N [kW] | I _N [A] | J _R [kgm ²] | A [mm] | B [mm] | C [mm] | Ø D [mm] | Ø E [mm] | Ø F [mm] | Ø G [mm] | H ¹⁾ [mm] | m [kg] | | | | | | | |
| MAD160 | B-0050 | 500 | 3,000 | 220 | 483.9 | 11.5 | 0.2500 | 316 | 748 | 110 | 55 | 300 | 350 | 18 | 422 (395) | 201 | | | | | | | |
| | B-0100 | 1,000 | 6,000 | 200 | 460.9 | 20.9 | | | | | | | | | | | 43.5 | | | | | | |
| | B-0150 | 1,500 | 6,000 | 190 | 440.1 | 29.9 | | | | | | | | | | | 61.6 | | | | | | |
| | B-0200 | 2,000 | 6,000 | 160 | 375.3 | 33.5 | | | | | | | | | | | 75.8 | | | | | | |
| | C-0050 | 500 | 3,000 | 240 | 528.2 | 12.6 | 27.6 | | 0.3110 | | | | | | | 838 | 140 | 60 | 300 | 350 | 18 | 469 | 238 |
| | C-0100 | 1,000 | 6,000 | 225 | 530.0 | 23.6 | 52.9 | | | | | | | | | | | | | | | | |
| | C-0150 | 1,500 | 6,000 | 215 | 496.0 | 33.8 | 75.3 | | | | | | | | | | | | | | | | |
| C-0200 | 2,000 | 6,000 | 210 | 494.2 | 44.0 | 93.9 | 0.4580 | 320 | 1,089 | 140 | 60 | 300 | 350 | 18 | 469 | | | | | | | | |
| C-0050 | 500 | 3,000 | 325 | 715.5 | 17.0 | 38.2 | | | | | | | | | | | | | | | | | |
| C-0100 | 1,000 | 6,000 | 300 | 620.0 | 31.4 | 69.0 | | | | | | | | | | | | | | | | | |
| C-0150 | 1,500 | 6,000 | 270 | 681.0 | 42.4 | 88.6 | | | | | | | | | | | | | | | | | |
| C-0200 | 2,000 | 6,000 | 250 | 594.4 | 52.4 | 104.6 | | 0.5940 | | | | | | | 1,089 | 140 | 60 | 300 | 350 | 18 | 403 | | |
| D-0050 | 500 | 3,000 | 390 | 857.8 | 20.4 | 39.7 | | | | | | | | | | | | | | | | | |
| D-0100 | 1,000 | 6,000 | 370 | 901.5 | 38.7 | 82.4 | | | | | | | | | | | | | | | | | |
| D-0150 | 1,500 | 6,000 | 340 | 794.0 | 53.4 | 107.4 | 1.6500 | 434 | 1,240 | 75 | 350 | 400 | 583 | 610 | | | | | | | | | |
| D-0200 | 2,000 | 6,000 | 300 | 768.2 | 62.8 | 117.4 | | | | | | | | | | | | | | | | | |
| C-0050 | 500 | 3,000 | 660 | 1,450.0 | 34.6 | 72.0 | | | | | | | | | | | | | | | | | |
| MAD225 | C-0100 | 1,000 | 3,750 | 640 | 1,450.0 | 67.0 | | 121.0 | | | | | | 434 | | | | | | | 1,240 | 75 | 350 |
| C-0150 | 1,500 | 3,750 | 593 | 1,450.0 | 93.1 | 174.0 | | | | | | | | | | | | | | | | | |

All the specifications given relate to the basic version of the motor without a holding brake. The maximum speed depends on the bearing version.

¹⁾ motor height H for version with terminal box, the values in parentheses apply for power connection with plug ²⁾ values without holding brake with fan

IndraDyn A – MAF asynchronous servo motors with liquid cooling

The liquid-cooled motors in the MAF series are particularly suitable for applications demanding maximum torques in minimum amounts of space. At the same time the unique cooling

system design ensures the thermal isolation of motor and machine and therefore maximum handling precision. The quick couplings with integrated leak-proofing simplify your maintenance work.

Options such as holding brakes, different encoder systems, vibration severity grades and shaft specifications allow you to tailor the MAF motors optimally to your specific application.





Compact and powerful

- | Rated outputs of up to 120 kW
- | Maximum speeds up to 11,000 rpm
- | Encoder systems for a wide and diverse range of applications
- | High protection category IP65
- | Liquid cooling with quick coupling

Your benefits

The simple step-by-step guide to ordering your MAF asynchronous servo motor:

Option
MAF100C-0100-FQ-S2-AH0-05-N1

Motor

- Size (e. g. "100")
- Overall length (e. g. "C")
- Winding (e. g. "0100")

Cooling system connection

- FQ** = Connection thread
- FR** = Quick coupling (comprised in the delivery)

Encoder

- S2** = Single-turn encoder (EnDat) 2048 increments
- M2** = Multi-turn encoder (EnDat) 2048 increments with 4096 revolutions absolute
- S6¹⁾** = Single-turn encoder (EnDat) 2048 increments for potentially explosive atmospheres
- M6¹⁾** = Multi-turn encoder (EnDat) 2048 increments and 4096 revolutions, for potentially explosive atmospheres
- C0** = Incremental encoder 2048 increments

¹⁾ equipment group II 2G, type of protection EEx p d IIB T3 only in combination with cooling option SL

Vibration severity grade

- 1** = A
- 3** = B

Bearing assembly

- N** = Standard
 - H²⁾** = High speed
 - V²⁾** = Heavy duty
- ²⁾ only for certain sizes

Construction

- 05** = Flange-mounted
- 35** = Flange-mounted or foot-mounted

Line terminal

- A** = Plug for A side
- B** = Plug for B side
- L** = Plug left
- R** = Plug right
- F** = Terminal box for A side
- K** = Terminal box for B side
- T** = Terminal box left
- S** = Terminal box right

Shaft

- G** = Plain shaft with sealing ring
- H** = Plain shaft without sealing ring
- P** = with keyway and sealing ring
- Q** = with keyway but without sealing ring

Holding brake

- 0** = without holding brake
 - 1** = with electr. released holding brake
 - 3³⁾** = with electr. released holding brake, heavy duty
 - 5** = with electr. clamped holding brake
- ³⁾ only for certain sizes

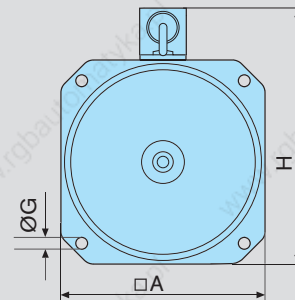
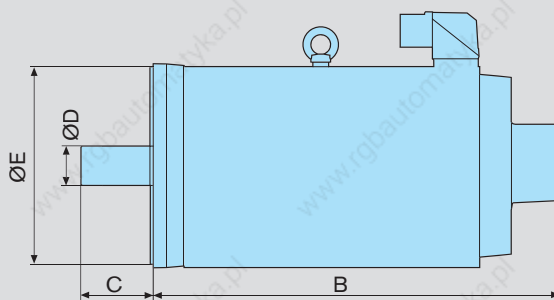
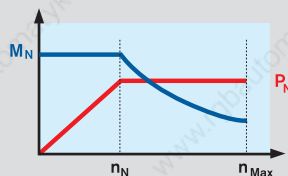

IndraDyn A – technical data

| Motor | Rated speed | Maximum speed | Rated torque | Maximum torque | Rated power | Rated current | Moment of inertia | Dimensions | | | | | | | Mass ³⁾ | |
|--------|-------------------------|---------------------------|------------------------|--------------------------|------------------------|-----------------------|---------------------------------------|------------|-----------|-----------|-------------|-------------|-------------|--------------|-------------------------|-----------|
| | n _N [rpm] | n _{Max} [rpm] | M _N [Nm] | M _{Max} [Nm] | P _N [kW] | I _N [A] | J _R [kgm ²] | A [mm] | B [mm] | C [mm] | Ø D [mm] | Ø E [mm] | Ø F [mm] | Ø G [mm] | H ¹⁾ [mm] | m [kg] |
| MAF100 | B-0050 | 500 | 3,000 | 50 | 109.7 | 2.6 | 8.5 | 192 | 382 | 60 | 38 | 130 | 215 | 14 | 277 (264) | 38 |
| | B-0100 | 1,000 | 6,000 | 46 | 110.0 | 4.8 | 15.2 | | | | | | | | | |
| | B-0150 | 1,500 | 9,000 | 42 | 101.4 | 6.6 | 18.1 | | | | | | | | | |
| | B-0200 | 2,000 | 11,000 | 38 | 92.4 | 8.0 | 23.9 | | | | | | | | | |
| | B-0250 | 2,500 | 11,000 | 33 | 83.6 | 8.6 | 26.0 | | | | | | | | | |
| | C-0050 | 500 | 3,000 | 70 | 153.7 | 3.9 | 12.1 | | | | | | | | | |
| | C-0100 | 1,000 | 6,000 | 68 | 154.0 | 7.5 | 19.0 | 0.0284 | 457 | 60 | 38 | 130 | 215 | 14 | 277 (264) | 52 |
| | C-0150 | 1,500 | 9,000 | 66 | 149.5 | 10.4 | 27.9 | | | | | | | | | |
| | C-0200 | 2,000 | 11,000 | 64 | 145.2 | 13.4 | 36.7 | | | | | | | | | |
| | C-0250 | 2,500 | 11,000 | 62 | 138.1 | 16.2 | 40.2 | | | | | | | | | |
| | D-0050 | 500 | 3,000 | 88 | 193.3 | 4.6 | 14.5 | | | | | | | | | |
| | D-0100 | 1,000 | 6,000 | 84 | 190.0 | 8.8 | 27.1 | | | | | | | | | |
| D-0150 | 1,500 | 9,000 | 79 | 185.3 | 12.4 | 32.7 | 0.0320 | 532 | 60 | 38 | 130 | 215 | 14 | 277 (264) | 64 | |
| D-0200 | 2,000 | 11,000 | 80 | 182.3 | 16.8 | 43.1 | | | | | | | | | | |
| D-0250 | 2,500 | 11,000 | 75 | 177.5 | 19.6 | 45.8 | | | | | | | | | | |
| B-0050 | 500 | 3,000 | 116 | 254.7 | 6.1 | 14.7 | | | | | | | | | | |
| B-0100 | 1,000 | 6,000 | 112 | 254.7 | 11.7 | 28.4 | 0.0790 | 260 | 110 | 42 | 250 | 300 | 18 | 345 (340) | 81 | |
| B-0150 | 1,500 | 9,000 | 115 | 264.0 | 18.1 | 43.7 | | | | | | | | | | |
| B-0200 | 2,000 | 10,000 | 100 | 220.0 | 20.9 | 52.7 | | | | | | | | | | |
| B-0250 | 2,500 | 10,000 | 90 | 210.0 | 23.6 | 55.5 | | | | | | | | | | |
| C-0050 | 500 | 3,000 | 155 | 340.0 | 8.1 | 21.0 | | | | | | | | | | |
| C-0100 | 1,000 | 6,000 | 150 | 330.0 | 15.7 | 38.0 | | | | | | | | | | |
| C-0150 | 1,500 | 9,000 | 145 | 329.8 | 22.8 | 53.2 | 0.1010 | 478 | 110 | 42 | 250 | 300 | 18 | 345 (340) | 106 | |
| C-0200 | 2,000 | 10,000 | 135 | 314.7 | 28.3 | 69.8 | | | | | | | | | | |
| C-0250 | 2,500 | 10,000 | 125 | 298.4 | 32.7 | 75.5 | | | | | | | | | | |
| D-0050 | 500 | 3,000 | 230 | 506.3 | 12.0 | 32.3 | 0.1510 | 608 | 110 | 42 | 250 | 300 | 18 | 345 (340) | 147 | |
| D-0100 | 1,000 | 6,000 | 220 | 500.0 | 23.0 | 50.7 | | | | | | | | | | |
| D-0150 | 1,500 | 9,000 | 200 | 484.4 | 31.4 | 72.6 | | | | | | | | | | |
| D-0200 | 2,000 | 10,000 | 200 | 461.4 | 41.9 | 93.9 | | | | | | | | | | |
| D-0250 | 2,500 | 10,000 | 190 | 432.1 | 49.7 | 113.0 | | | | | | | | | | |

| Motor | Rated speed | Maximum speed | Rated torque | Maximum torque | Rated power | Rated current | Moment of inertia | Dimensions | | | | | | | | Mass ³⁾ | |
|--------|-------------------------|---------------------------|------------------------|--------------------------|------------------------|-----------------------|---------------------------------------|------------|-------------------|-----------|-------------|-------------|-------------|-------------|-------------------------|--------------------|-----|
| | n _N [rpm] | n _{Max} [rpm] | M _N [Nm] | M _{Max} [Nm] | P _N [kW] | I _N [A] | J _R [kgm ²] | A [mm] | B [mm] | C [mm] | Ø D [mm] | Ø E [mm] | Ø F [mm] | Ø G [mm] | H ¹⁾ [mm] | m [kg] | |
| MAF160 | B-0050 | 500 | 3,000 | 270 | 594.5 | 14.1 | 34.3 | 0.2300 | 316 | 618 | 110 | 60 | 300 | 350 | 18 | 422 (395) | 197 |
| | B-0100 | 1,000 | 6,000 | 260 | 592.7 | 27.2 | 73.7 | | | | | | | | | | |
| | B-0150 | 1,500 | 6,000 | 250 | 570.8 | 39.3 | 89.5 | | | | | | | | | | |
| | B-0200 | 2,000 | 6,000 | 240 | 550.1 | 50.3 | 108.5 | | | | | | | | | | |
| | C-0050 | 500 | 3,000 | 340 | 747.8 | 17.8 | 47.4 | 0.2600 | 708 | | | | | | | 227 | |
| | C-0100 | 1,000 | 6,000 | 325 | 746.4 | 34.0 | 91.2 | | | | | | | | | | |
| | C-0150 | 1,500 | 6,000 | 300 | 681.4 | 47.1 | 109.5 | | | | | | | | | | |
| | C-0200 | 2,000 | 6,000 | 285 | 677.4 | 59.7 | 136.0 | | | | | | | | | | |
| MAF180 | C-0050 | 500 | 3,000 | 435 | 986.2 | 22.8 | 50.0 | 0.4900 | 320 ²⁾ | 792 | | 60 | 300 | 350 | | 469 | 322 |
| | C-0100 | 1,000 | 6,000 | 400 | 957.0 | 41.9 | 93.9 | | | | | | | | | | |
| | C-0150 | 1,500 | 6,000 | 365 | 858.1 | 57.3 | 128.8 | | | | | | | | | | |
| | C-0200 | 2,000 | 6,000 | 318 | 739.2 | 66.6 | 154.0 | | | | | | | | | | |
| | D-0050 | 500 | 3,000 | 500 | 1,100.2 | 26.2 | 60.4 | 0.6100 | 902 | 140 | | | | 18 | | 382 | |
| | D-0100 | 1,000 | 6,000 | 460 | 1,094.5 | 48.2 | 94.8 | | | | | | | | | | |
| | D-0150 | 1,500 | 6,000 | 435 | 1,013.0 | 68.3 | 146.1 | | | | | | | | | | |
| | D-0200 | 2,000 | 6,000 | 400 | 1,008.0 | 83.8 | 168.5 | | | | | | | | | | |
| MAF225 | C-0050 | 500 | 3,000 | 860 | 1,750.0 | 45.0 | 98.0 | 1.6500 | 434 ²⁾ | 932 | | 75 | 350 | 400 | | 583 | 587 |
| | C-0100 | 1,000 | 3,750 | 820 | 1,750.0 | 85.9 | 170.0 | | | | | | | | | | |
| | C-0150 | 1,500 | 3,750 | 764 | 1,750.0 | 120.0 | 215.0 | | | | | | | | | | |

All the specifications given relate to the basic version of the motor without a holding brake. The maximum speed depends on the bearing version.

¹⁾ motor height H for version with terminal box, the values in parentheses apply for power connection with plug ²⁾ housing size > flange size A ³⁾ values without holding brake

IndraDyn L – linear motors for maximum dynamics

Compact construction, high dynamics and maximum forces of up to 21,500 N – these are the challenges to which our IndraDyn L synchronous linear motors are admirably equipped to meet. Given their exceptionally low force ripple, these motors are particularly suitable for applications with maximum demands in terms of acceleration and accuracy.

There is a choice of sizes geared to typical requirements supplied in standard encapsulation or thermal encapsulation for maximum temperature stability.

The combination of several linear motors – whether in series or parallel – gives rise to completely new machine concepts with greatly enhanced machining force.



The simple step-by-step guide to ordering your IndraDyn L synchronous linear motor:

Primary part

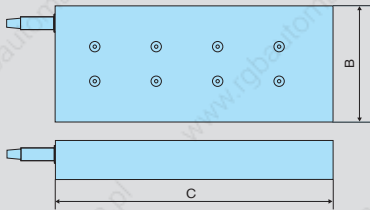

MLP140C-0170-FS-N0CN-NNNN

Option

Enclosure

- S** = Standard encapsulation
- T** = Thermal encapsulation

Motor (primary part)

- Size (e. g. "140")
- Overall length (e. g. "C")
- Winding (e. g. "0170")

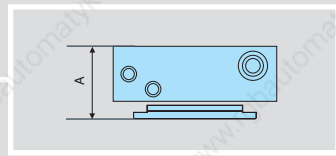

Secondary part

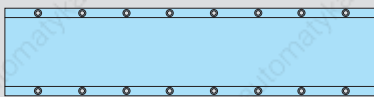

MLS140S-3A-0150-NNNN

Option

Segment length

- 0150** = 150 mm
- 0450** = 450 mm
- 0600** = 600 mm

Motor (Secondary part)

- Size (e. g. "140")

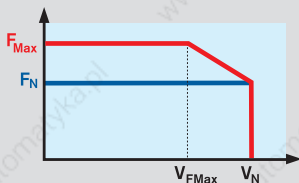



High dynamics and precision

- ! Maximum force of up to 21,500 N
- ! Maximum velocity up to 600 m/min
- ! Compact design
- ! Low force ripple
- ! Heat dissipation minimized by thermal encapsulation

Your benefits

| Motor | Continuous nominal force | Maximum force | Nominal velocity | Maximum velocity with F _{Max} | Cont. nominal current | Maximum current | Standard encapsulation | | | | Thermal encapsulation | | | | | |
|--------|--------------------------|---------------|------------------|--|-----------------------|-----------------|---------------------------|--------------------|---------------------|---------------------|---------------------------|--------------------|---------------------|---------------------|-----|-----|
| | | | | | | | Total installation height | Primary part width | Primary part length | Primary part mass | Total installation height | Primary part width | Primary part length | Primary part mass | | |
| | | | | | | | A [mm] | B [mm] | C [mm] | m _p [kg] | A [mm] | B [mm] | C [mm] | m _p [kg] | | |
| MLP040 | A-0300 | 250 | 800 | 500 | 300 | 4.2 | 61.4 | 100 | 210 | 4.7 | 108 | 235 | 6.1 | | | |
| | B-0150 | 370 | 1,150 | 300 | 150 | 4.2 | | | | | | | | 20 | | |
| | B-0250 | | | 400 | 250 | 5.3 | | | | | | | | | 27 | |
| | B-0300 | | | 500 | 300 | 6.0 | | | | | | | | | | 35 |
| MLP070 | A-0150 | 550 | 2,000 | 200 | 150 | 5.5 | 61.4 | 130 | 285 | 8.4 | 138 | 310 | 10.9 | | | |
| | A-0220 | | | 360 | 220 | 6.3 | | | | | | | | 42 | | |
| | A-0300 | | | 450 | 300 | 10.5 | | | | | | | | | 55 | |
| | B-0100 | | | 820 | 2,600 | 200 | | | | | | | | 100 | | 5.5 |
| | B-0120 | 220 | 120 | | | 5.8 | | | | | | | | 42 | | |
| | B-0150 | 260 | 150 | | | 6.2 | | | | | | | | | 48 | |
| | B-0250 | 400 | 250 | | | 10.0 | | | | | | | | 55 | | |
| | B-0300 | 450 | 300 | 12.0 | 70 | | | | | | | | | | | |
| | C-0120 | 1,200 | 3,800 | 180 | | 120 | | | | | | | | 8.9 | 55 | |
| | C-0150 | | | 250 | 150 | 11.7 | | | | | | | | 70 | | |
| | C-0240 | | | 350 | 240 | 13.0 | | | | | | | | | | 90 |
| | C-0300 | | | 450 | 300 | 19.0 | | | | | | | | 110 | | |
| MLP100 | A-0090 | 1,180 | 3,750 | 150 | 90 | 6.6 | 61.4 | 160 | 360 | 13.5 | 168 | 385 | 17.0 | | | |
| | A-0120 | | | 190 | 120 | 8.0 | | | | | | | | 44 | | |
| | A-0150 | | | 220 | 150 | 10.0 | | | | | | | | | 55 | |
| | A-0190 | | | 290 | 190 | 12.0 | | | | | | | | 70 | | |
| | B-0120 | 1,785 | 5,600 | 190 | 120 | 12.0 | | | | | | | | | 70 | |
| | B-0250 | | | 350 | 250 | 22.0 | | | | | | | | 130 | | |
| | C-0090 | | | 170 | 90 | 13.0 | | | | | | | | | | 90 |
| | C-0120 | | | 2,310 | 7,150 | 190 | | | | | | | | 120 | | |
| C-0190 | 290 | 190 | 23.0 | 140 | | | | | | | | | | | | |
| MLP140 | A-0120 | 1,680 | 5,200 | | 190 | 120 | 12.0 | 61.4 | 200 | 360 | 17 | 208 | 385 | 21.2 | | |
| | B-0090 | 2,415 | 7,650 | 160 | 90 | 15.0 | 85 | | | | | | | | | |
| | B-0120 | | | 190 | 120 | 18.0 | | | | | | | | | 105 | |
| | C-0050 | 3,150 | 10,000 | 110 | 50 | 13.0 | 70 | | | | | | | | | |
| | C-0120 | | | 190 | 120 | 21.0 | | | | | | | | | 125 | |
| | C-0170 | | | 250 | 170 | 29.0 | | | | | | | | | | 140 |
| | C-0350 | | | 400 | 350 | 53.0 | | | | | | | | | 260 | |
| MLP200 | A-0090 | 2,415 | 7,450 | 170 | 90 | 13.0 | 61.4 | 200 | 360 | 23 | 268 | 385 | 28.3 | | | |
| | A-0120 | | | 190 | 120 | 16.0 | | | | | | | | 88 | | |
| | B-0040 | 3,465 | 10,900 | 100 | 40 | 13.0 | | | | | | | | | 70 | |
| | B-0120 | | | 190 | 120 | 22.0 | | | | | | | | 130 | | |
| | C-0090 | | | 170 | 90 | 23.3 | | | | | | | | | | 120 |
| | C-0120 | 4,460 | 14,250 | 190 | 120 | 30.0 | | | | | | | | 175 | | |
| | C-0170 | | | 220 | 170 | 46.0 | | | | | | | | | 210 | |
| | D-0060 | | | 5,560 | 17,750 | 140 | | | | | | | | | | 60 |
| D-0100 | 180 | | | | | 100 | 46.0 | 210 | | | | | | | | |
| D-0120 | 190 | 120 | 53.0 | | | 225 | | | | | | | | | | |
| MLP300 | A-0090 | 3,350 | 11,000 | | | | 160 | 90 | 19.0 | - | - | - | - | 77.9 | 368 | 385 |
| | A-0120 | | | 190 | 120 | 23.0 | 138 | | | | | | | | | |
| | B-0070 | 5,150 | 16,300 | 140 | 70 | 28.0 | | 140 | | | | | | | | |
| | B-0120 | | | 190 | 120 | 35.0 | 205 | | | | | | | | | |
| | C-0060 | | | 110 | 60 | 29.0 | | | 140 | | | | | | | |
| | C-0090 | 6,720 | 21,500 | 150 | 90 | 37.0 | 212 | | | | | | | | | |
| | C-0120 | | | 180 | 120 | 52.3 | | 222 | | | | | | | | |

All the specifications given are based on operation with liquid cooling and 540 V DC bus voltage.

IndraDyn T – frameless (kit) torque motors

The IndraDyn T torque motors are liquid-cooled kit motors which have been optimized for high torques of up to 13,800 Nm. They consist of a stator with three-phase winding and a rotor with permanent magnets.

Typical areas of application for these motors mainly include direct drives in rotary tables or swivel axes in machining centers. However, they also offer innovative new approaches to solutions in mechanical engineering applications using robots, plastics processing machines, woodworking machines, lathes and special purpose machines.

We can supply the motors with an optional preassembled assembly aid for quick and easy installation.



The simple step-by-step guide to ordering your IndraDyn T torque motor:

Stator

MST^{Option}**530B-0070-FT-N0****CN**-NNNN

Motor (Stator)

- Size (e. g. "530")
- Overall length (e. g. "B")
- Winding (e. g. "0070")

Electrical connection

- CN** = Axial on side with larger Ø
- SN** = Axial on side with smaller Ø
- RN** = Radial on side with larger Ø

Rotor

MRT^{Option}**530B-3A-0410**-NNNN

Motor (Rotor)

- Size (e. g. "530")
- Overall length (e. g. "B")

Internal diameter of rotor

The rotors can be supplied with different internal diameters.



Powerful and direct

- ▮ Maximum torques of up to 13,800 Nm
- ▮ Full torque even at standstill
- ▮ Extremely high overload capacity
- ▮ Liquid cooling with thermal encapsulation
- ▮ Easy to assemble

Your benefits

| Motor | | Rated torque | Maximum torque | Speed at M_{Max} | Rated speed | Rated current | Maximum current | Rotor ¹⁾ Moment of inertia | Dimensions | | | Mass ²⁾ |
|--------|--------|---------------|-------------------|---------------------|----------------|---------------|------------------|--|------------|-----------|------------|--------------------|
| | | M_N [Nm] | M_{Max} [Nm] | n_{Mmax} [rpm] | n_N [rpm] | I_N [A] | I_{Max} [A] | J_R [kgm ²] | ØA [mm] | B [mm] | ØC [mm] | m [kg] |
| MST130 | A-0200 | 9 | 15 | 900 | 2,000 | 7.5 | 16 | 0.0008 | 150 | 63 | 60 | 2.4/0.65 |
| | C-0050 | 25 | 40 | 225 | 500 | 7.5 | 12 | 0.0018 | | 103 | | 5.1/1.5 |
| | E-0020 | 42 | 65 | 90 | 200 | 7.5 | 12 | 0.0029 | | 143 | | 7.7/2.2 |
| MST160 | A-0050 | 35 | 90 | 180 | 500 | 6.5 | 20 | 0.0059 | 180 | 95 | 80 | 5.6/2.4 |
| | C-0050 | 70 | 180 | 180 | 500 | 13.0 | 40 | 0.0108 | | 145 | | 9.6/4.3 |
| | E-0050 | 105 | 270 | 180 | 500 | 19.5 | 60 | 0.0158 | | 195 | | 13.9/6.2 |
| MST210 | A-0027 | 50 | 100 | 100 | 270 | 7.0 | 25 | 0.0120 | 230 | 75 | 120 | 7.2/3.0 |
| | C-0027 | 120 | 250 | 100 | 270 | 13.0 | 50 | 0.0230 | | 120 | | 11.5/4.8 |
| | C-0050 | | | 200 | 500 | 25.0 | 100 | | | | | |
| | D-0070 | 150 | 300 | 270 | 700 | 32.0 | 120 | 0.0270 | | 150 | | 13.8/5.8 |
| MST290 | E-0027 | 240 | 500 | 100 | 270 | 24.0 | 90 | 0.0420 | 310 | 195 | 200 | 18.8/7.8 |
| | B-0018 | 220 | 460 | 70 | 180 | 14.8 | 60 | 0.0800 | | 105 | | 13.5/6.2 |
| | D-0002 | 350 | 700 | 10 | 25 | 6.3 | 25 | 0.1100 | | 135 | | 20.0/9.0 |
| | D-0004 | | | 17 | 45 | 10.4 | 30 | | | | | |
| | D-0018 | | | 70 | 180 | 26.0 | 100 | | | | | |
| E-0004 | 575 | 1,150 | 16 | 40 | 12.5 | 50 | 0.1700 | 195 | 25.1/11.6 | | | |
| E-0018 | | | 70 | 180 | 35.0 | 125 | | | | | | |
| MST360 | B-0018 | 375 | 900 | 70 | 180 | 20.0 | 70 | 0.1900 | 385 | 120 | 260 | 23.0/9.8 |
| | D-0012 | 525 | 1,150 | 45 | 120 | 16.5 | 60 | 0.2700 | | 150 | | 28.8/13.5 |
| | D-0018 | | | 70 | 180 | 28.0 | 100 | | | | | |
| | E-0018 | 875 | 1,900 | 70 | 180 | 42.0 | 141 | 0.4400 | | 210 | | 40.3/20.9 |
| MST450 | B-0012 | 540 | 1,200 | 45 | 120 | 22.0 | 70 | 0.4500 | 480 | 120 | 350 | 31.0/13.0 |
| | D-0006 | 810 | 1,800 | 25 | 60 | 18.8 | 50 | 0.6400 | | 150 | | 38.7/17.9 |
| | D-0012 | | | 45 | 120 | 33.0 | 100 | | | | | |
| | E-0006 | 1,400 | 3,250 | 25 | 60 | 32.0 | 88 | 1.0100 | | 210 | | 54.2/27.7 |
| | E-0012 | | | 45 | 120 | 46.0 | 125 | | | | | |
| MST530 | B-0010 | 800 | 1,800 | 45 | 100 | 28.6 | 71 | 0.9200 | 565 | 120 | 410 | 36.0/22.0 |
| | C-0010 | 1,200 | 2,700 | 40 | 100 | 31.2 | 88 | 1.2500 | | 150 | | 45.0/27.5 |
| | E-0010 | 2,100 | 4,700 | 40 | 100 | 64.0 | 212 | 1.9200 | | 210 | | 63.0/38.5 |
| | G-0007 | 4,200 | 9,200 | 28 | 70 | 96.0 | 305 | 3.8400 | | 370 | | 144.0/77.0 |
| | L-0006 | 6,300 | 13,800 | 25 | 60 | 120.0 | 380 | 5.7600 | | 520 | | 205.0/115.0 |

All the specifications given are based on operation with liquid cooling and 540 V DC bus voltage ¹⁾ depends on rotor version ²⁾ stator/rotor

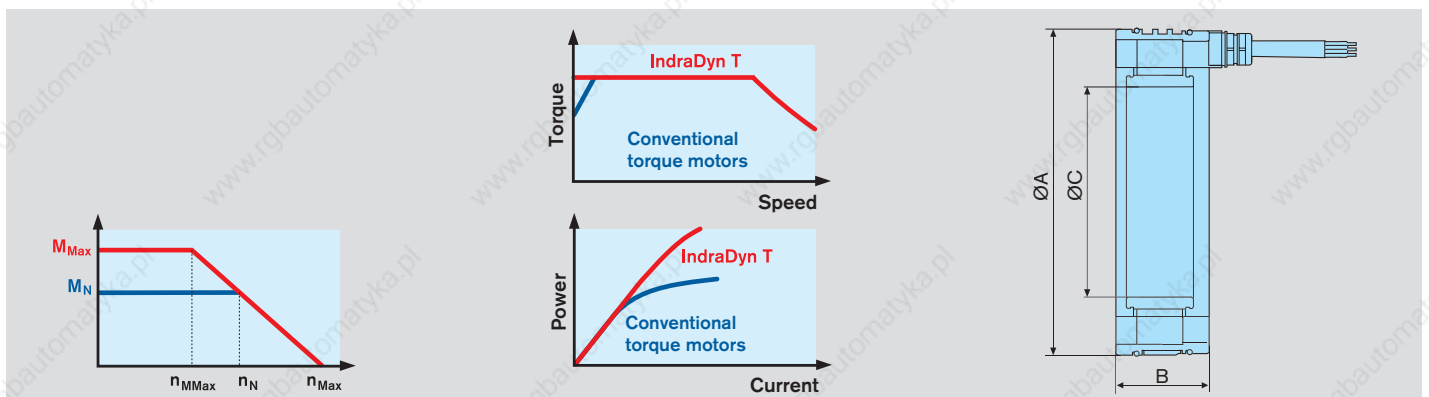

IndraDyn H – high-speed frameless (kit) motors

The liquid-cooled high-speed IndraDyn H kit motors achieve maximum torques of up to 4,500 Nm with speeds of up to 30,000 rpm.

With their broad constant output power range, short ramp-up time and low rotor temperature they are predestined for motor spindles and other similar areas of application.

The new onboard cooling system simplifies their integration in the machine and increases their cooling efficiency.

For extra easy assembly and disassembly we can supply the rotor on request with a step interference fit and the corresponding hydraulic connections.



The simple step-by-step guide to ordering your high-speed IndraDyn H motor:

Stator

MSS^{Option}**182A-0100-FA-N0CN-NNNN**

Motor (Stator)

- Size (e. g. "182")
- Overall length (e. g. "A")
- Winding (e. g. "0100")

Rotor

MRS^{Option}**182A-1N-0075-NNNN**

Internal diameter of rotor

Corresponding internal diameters are available for every rotor size. For further details see configuration handbook.

Motor (Rotor)

- Size (e. g. "182")
- Overall length (e. g. "A")

Rotor version

- 1N** = Smooth bore
- 2N** = Step interference fit with hydraulic connection



High dynamics and precision

- ! Maximum torques up to 4,500 Nm
- ! Maximum speeds up to 30,000 rpm
- ! Wide constant output power range
- ! Integrated cooling system
- ! Straightforward integration in the machine

Your benefits

| Motor | | Rated speed | Maximum speed | Rated torque | Maximum torque | Rated power | Rated current | Maximum current | Rotor ¹⁾ | Dimensions | | | Mass ²⁾ | |
|--------|--------|----------------|--------------------|---------------|-------------------|---------------|---------------|------------------|---|-------------------------|-----------|---------------------------------------|--------------------|------------|
| | | n_N [rpm] | n_{Max} [rpm] | M_N [Nm] | M_{Max} [Nm] | P_N [kW] | I_N [A] | I_{Max} [A] | Moment of inertia J_R [kgm ²] | $\varnothing A$ [mm] | B [mm] | $\varnothing C$ ¹⁾ [mm] | m [kg] | |
| MSS102 | B-0800 | 8,000 | 30,000 | 10.5 | 30.0 | 8.8 | 18.0 | 40.0 | 0.0030 | 120 | 156 | 46 | 7.7/2.1 | |
| | D-0800 | 8,000 | 30,000 | 20.0 | 45.0 | 16.8 | 24.0 | 69.0 | 0.0040 | | 206 | | 10.1/3.1 | |
| | F-0300 | 3,000 | 18,000 | 32.0 | 75.0 | 10.1 | 15.3 | 35.0 | 0.0060 | 120 | 306 | 46 | 14.9/5.1 | |
| F-0800 | 8,000 | 30,000 | 26.0 | 68.0 | 21.8 | 43.0 | 100.0 | | | | | | | |
| MSS142 | B-0700 | 7,000 | 28,000 | 27.5 | 67.0 | 20.2 | 45.0 | 100.0 | 0.0110 | 160 | 181 | 58 | 16.7/4.6 | |
| | D-0700 | 7,000 | 28,000 | 40.5 | 90.0 | 29.7 | 65.0 | 140.0 | 0.0140 | | 231 | | 21.2/6.5 | |
| | F-0700 | 7,000 | 28,000 | 65.0 | 150.0 | 47.6 | 68.0 | 180.0 | 0.0170 | | 281 | | 25.7/8.3 | |
| MSS162 | B-0400 | 4,000 | 20,000 | 50.0 | 115.0 | 20.9 | 42.0 | 110.0 | 0.0140 | 180 | 206 | 68 | 22.0/6.9 | |
| | D-0400 | 4,000 | 20,000 | 70.0 | 160.0 | 29.3 | 64.0 | 170.0 | 0.0180 | | 256 | | 28.1/8.8 | |
| | F-0310 | 3,100 | 15,500 | 90.0 | 200.0 | 29.2 | 64.0 | 170.0 | 0.0220 | | 306 | | 34.1/10.6 | |
| | J-0200 | 2,000 | 10,000 | 120.0 | 275.0 | 25.1 | 64.0 | 170.0 | 0.0280 | | 381 | | 46.1/13.4 | |
| MSS182 | A-0100 | 1,000 | 6,000 | 12.0 | 30.0 | 1.3 | 3.7 | 11.0 | 0.0089 | 200 | 82 | 85 | 6.9/2.7 | |
| | A-0250 | 2,500 | 12,000 | 12.0 | 30.0 | 3.1 | 5.0 | 15.0 | | | | | | |
| | B-0280 | 2,800 | 12,000 | 100.0 | 230.0 | 29.3 | 64.0 | 170.0 | 0.0310 | | 232 | | 32.1/9.6 | |
| | D-0260 | 2,600 | 12,000 | 140.0 | 320.0 | 38.1 | 71.0 | 200.0 | 0.0390 | | 282 | | 38.9/11.8 | |
| MSS202 | F-0200 | 2,000 | 12,000 | 200.0 | 450.0 | 41.9 | 71.0 | 200.0 | 0.0530 | 220 | 382 | 96 | 52.6/21.3 | |
| | A-0200 | 2,000 | 11,000 | 105.0 | 270.0 | 22.0 | 45.0 | 130.0 | 0.0500 | | 215 | | 33.0/12.8 | |
| | B-0150 | 1,500 | 8,200 | 140.0 | 390.0 | 22.0 | 52.0 | 141.0 | 0.0640 | | 265 | | 40.7/16.2 | |
| | B-0210 | 2,100 | 11,500 | 140.0 | 390.0 | 30.8 | 68.0 | 180.0 | | | | | | |
| MSS242 | D-0170 | 1,700 | 9,300 | 175.0 | 480.0 | 31.2 | 68.0 | 180.0 | 0.0770 | 270 | 315 | 110 | 48.3/19.6 | |
| | F-0120 | 1,200 | 6,600 | 245.0 | 650.0 | 30.8 | 68.0 | 180.0 | 0.1040 | | 415 | | 63.7/26.9 | |
| | B-0100 | 1,000 | 6,000 | 250.0 | 575.0 | 26.2 | 68.0 | 180.0 | 0.1190 | | 275 | | 66.7/22.5 | |
| | D-0070 | 700 | 4,200 | 375.0 | 860.0 | 27.5 | 49.5 | 180.0 | 0.1670 | | 375 | | 92.3/31.7 | |
| MSS272 | F-0060 | 600 | 3,600 | 425.0 | 970.0 | 26.7 | 68.0 | 180.0 | 0.1930 | 300 | 425 | 135 | 105.1/36.5 | |
| | B-0065 | 650 | 3,000 | 400.0 | 900.0 | 27.2 | 71.0 | 200.0 | 0.2680 | | 330 | | 90.4/35.5 | |
| | B-0080 | 800 | 3,200 | 400.0 | 900.0 | 33.5 | 82.0 | 250.0 | | | | | | |
| | D-0050 | 500 | 2,200 | 525.0 | 1,200.0 | 27.5 | 71.0 | 200.0 | 0.3350 | | 405 | | 112.3/44.5 | |
| MSS312 | F-0040 | 400 | 1,800 | 650.0 | 1,500.0 | 27.2 | 71.0 | 200.0 | 0.4030 | 340 | 480 | 170 | 134.2/53.5 | |
| | B-0035 | 350 | 1,500 | 650.0 | 1,550.0 | 23.8 | 62.5 | 170.0 | 0.6170 | | 380 | | 128.7/55.0 | |
| | D-0028 | 280 | 1,200 | 820.0 | 1,950.0 | 24.0 | 59.5 | 160.0 | 0.7510 | | 455 | | 154.1/67.4 | |
| | D-0060 | 600 | 2,400 | 820.0 | 1,950.0 | 51.5 | 93.2 | 250.0 | | | | | | |
| | F-0028 | 280 | 1,200 | 975.0 | 2,275.0 | 28.6 | 62.0 | 180.0 | 0.8850 | | 455 | | 179.5/79.5 | |
| MSS382 | H-0025 | 250 | 1,100 | 1,125.0 | 2,750.0 | 29.5 | 62.0 | 180.0 | 1.0640 | 405 | 630 | 240 | 215.0/95.6 | |
| | H-0085 | 850 | 3,400 | 1,100.0 | 2,750.0 | 97.9 | 197.0 | 570.0 | | | | | | |
| | B-0025 | 250 | 1,000 | 1,375.0 | 2,875.0 | 36.0 | 85.0 | 250.0 | 1.5250 | | | | 430 | 178.5/77.6 |
| | D-0020 | 200 | 800 | 1,775.0 | 3,700.0 | 37.2 | 101.0 | 250.0 | 1.9110 | | | | 530 | 220.1/97.2 |
| MSS482 | F-0018 | 180 | 720 | 2,170.0 | 4,500.0 | 40.9 | 83.6 | 250.0 | 2.2960 | 510 | 115 | 345 | 262.0/120.0 | |
| | A-0200 | 2,000 | 5,000 | 120.0 | 275.0 | 25.1 | 40.0 | 140.0 | 0.6040 | | | | 115 | 14.8/16.4 |

All the specifications given are based on operation with liquid cooling and 540 V DC bus voltage. The indicated maximum speed is reached at a DC bus voltage of 750 V.

¹⁾ depends on rotor version ²⁾ stator/rotor with largest available internal diameter of rotor

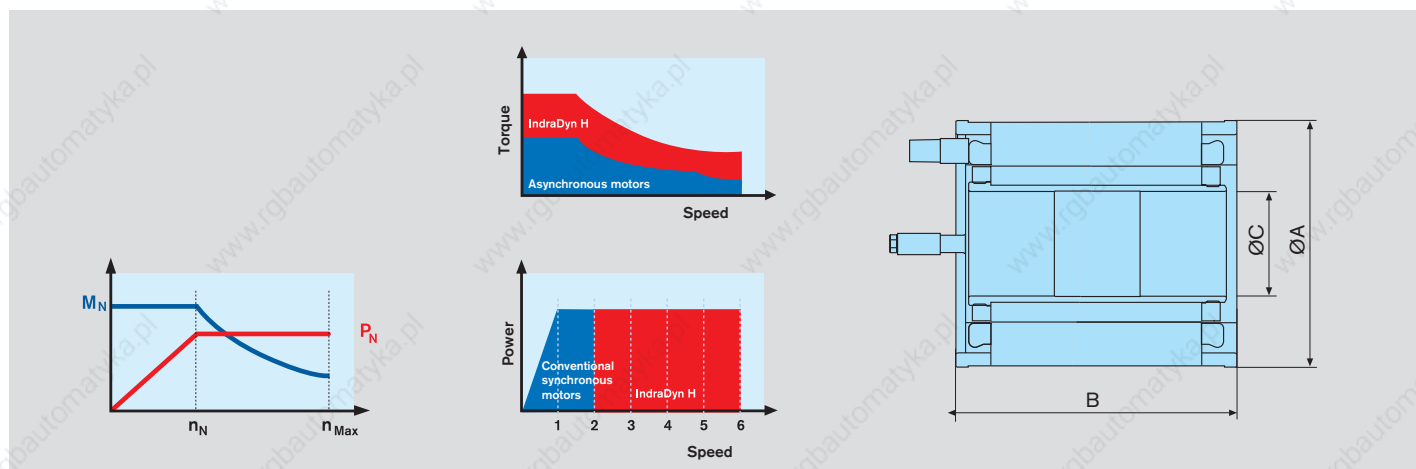

1MB – asynchronous frameless (kit) motors for compact drive solutions

The 1MB frameless (kit) motors are maintenance-free asynchronous motors with high power density. For different performance requirements and installation situations, our product range offers 9 motor sizes with different overall lengths and diameters.

Typical areas of application of these motors are the main spindles of modern CNC machines and machining centers. These frameless (kit) motors excel by their superb running smoothness and perfect servo quality for C-axis machining, thread cutting and spindle positioning.



The simple step-by-step guide to ordering your asynchronous frameless (kit) motor 1MB:

Stator

Motor (stator)

- Overall size (e. g. "310")
- Overall length (e. g. "B")
- Winding (e. g. "6B")

Option
1MS**310B-6B-A2/S010**

Special version

S010 = with several integrated temperature sensors (NTC thermistor, PTC thermistor, temperature switch)

Electrical connection

- 1** = Lines at the stator side brought out with larger outside diameter
- 2** = Lines at the stator side brought out with smaller outside diameter

Rotor

Motor (rotor)

- Overall size (e. g. "310")
- Overall length (e. g. "B")

Option
1MR**310B-A094**

Internal diameter of rotor

For each rotor size, corresponding internal diameters are available. For details, refer to the configuration handbook.

Rotor version

e. g. step interference with hydraulic connection



Robust and reliable

- Rated torques up to 875 Nm
- Maximum speeds up to 20,000 rpm
- Large spindle cutoff
- Excellent running smoothness
- Easy integration into the machine

Your benefits

| Motor | | Rated speed | Maximum speed | Rated torque | Rated performance | Rated current | Moment of inertia | Dimensions | | | Mass ²⁾ |
|--------|------|-------------------------|---------------------------|------------------------|------------------------|-----------------------|---------------------------------------|-------------|-----------|---------------------------|--------------------|
| | | n _N [rpm] | n _{Max} [rpm] | M _N [Nm] | P _N [kW] | I _N [A] | J _R [kgm ²] | Ø A [mm] | B [mm] | Ø C ¹⁾ [mm] | m [kg] |
| 1MS140 | B-4A | 7,500 | 20,000 | 7 | 5.5 | 18.0 | 0.0044 | 160 | 150 | 45 | 5.3/3.3 |
| | B-4B | 5,000 | 20,000 | 7 | 3.7 | 25.0 | 0.0061 | | | | 8.2/4.5 |
| | D-4B | 4,000 | 16,000 | 14 | 6.0 | 43.0 | 0.0082 | | | | 11.8/6.1 |
| | F-4A | 3,000 | 15,000 | 24 | 7.5 | 43.0 | 0.0103 | | | | 15.5/7.3 |
| | H-4B | 3,000 | 15,000 | 34 | 10.5 | 58.0 | 0.0084 | | | | 6.8/5.3 |
| 1MS160 | B-4A | 3,000 | 12,000 | 16 | 5.0 | 36.0 | 0.0121 | 180 | 255 | 60 | 11.1/7.3 |
| | D-4A | 3,000 | 12,000 | 32 | 10.0 | 48.0 | 0.0149 | | | | 14.4/9.4 |
| | D-4B | 2,000 | 8,000 | 32 | 6.7 | 23.8 | 0.0161 | | | | 15.8/10.2 |
| | E-4B | 1,000 | 4,000 | 33 | 3.5 | 19.0 | 0.0201 | | | | 21.0/9.8 |
| | F-4A | 3,000 | 12,000 | 48 | 15.0 | 74.0 | 0.0267 | | | | 28.1/12.7 |
| | F-4B | 3,000 | 12,000 | 48 | 15.0 | 45.0 | 0.0267 | | | | 28.1/12.7 |
| | F-4D | 2,500 | 10,000 | 48 | 12.5 | 23.2 | 0.0267 | | | | 28.1/12.7 |
| | H-4A | 3,000 | 12,000 | 64 | 20.0 | 58.0 | 0.0267 | | | | 28.1/12.7 |
| | N-4A | 3,000 | 12,000 | 89 | 28.0 | 75.0 | 0.0267 | | | | 28.1/12.7 |
| | N-4B | 2,000 | 8,000 | 89 | 18.6 | 60.0 | 0.0267 | | | | 28.1/12.7 |
| | N-4C | 1,500 | 6,000 | 89 | 14.0 | 26.0 | 0.0267 | | | | 28.1/12.7 |
| 1MS200 | C-4A | 1,500 | 6,000 | 57 | 9.0 | 50.0 | 0.0410 | 220 | 295 | 66 | 21.0/15.0 |
| | D-4B | 1,500 | 6,000 | 85 | 13.5 | 48.0 | 0.0370 | | | | 29.0/19.0 |
| | D-4C | 5,000 | 20,000 | 59 | 31.0 | 75.0 | 0.0370 | | | | 29.0/19.0 |
| | D-4D | 2,500 | 10,000 | 85 | 22.0 | 59.0 | 0.0370 | | | | 29.0/19.0 |
| | D-4E | 1,500 | 6,000 | 85 | 13.5 | 84.0 | 0.0370 | | | | 29.0/19.0 |
| | D-4F | 6,000 | 18,000 | 49 | 31.0 | 82.0 | 0.0590 | | | | 34.0/22.0 |
| | E-4B | 1,800 | 7,200 | 85 | 16.0 | 41.4 | 0.0590 | | | | 34.0/22.0 |
| | E-4C | 3,900 | 15,600 | 74 | 30.2 | 65.0 | 0.0690 | | | | 41.0/26.0 |
| | H-4B | 1,500 | 6,000 | 124 | 19.5 | 68.0 | 0.0690 | | | | 41.0/26.0 |
| | H-4D | 1,500 | 6,000 | 124 | 19.5 | 52.6 | 0.0690 | | | | 41.0/26.0 |
| 1MS240 | B-4A | 1,000 | 4,000 | 62 | 6.5 | 46.0 | 0.0780 | 270 | 360 | 72 | 29.0/19.0 |
| | F-4A | 1,000 | 4,000 | 123 | 13.0 | 74.0 | 0.1200 | | | | 48.0/29.0 |
| | H-4B | 1,000 | 4,000 | 169 | 18.0 | 56.0 | 0.1530 | | | | 62.0/37.0 |
| 1MS241 | D-6A | 1,000 | 4,000 | 112 | 12.0 | 62.0 | 0.1350 | 270 | 410 | 111 | 38.0/24.0 |
| | D-6C | 1,000 | 4,000 | 112 | 12.0 | 27.0 | 0.2270 | | | | 63.0/39.0 |
| | H-6C | 1,800 | 7,200 | 202 | 32.0 | 75.5 | 0.2270 | | | | 63.0/39.0 |
| | H-6D | 850 | 3,400 | 202 | 18.0 | 66.4 | 0.2270 | | | | 63.0/39.0 |
| | H-6G | 800 | 3,200 | 202 | 16.9 | 39.7 | 0.2270 | | | | 63.0/39.0 |
| 1MS242 | N-4B | 1,700 | 6,800 | 185 | 33.0 | 98.0 | 0.1350 | 270 | 440 | 71 | 81.0/37.0 |
| 1MS270 | C-4B | 1,500 | 6,000 | 190 | 30.0 | 96.0 | 0.2580 | 300 | 400 | 120 | 82.0/52.0 |
| 1MS310 | B-6B | 1,000 | 4,000 | 260 | 27.0 | 75.0 | 0.4770 | 340 | 450 | 125 | 84.0/65.0 |
| | B-6D | 700 | 2,800 | 260 | 19.0 | 81.0 | 0.4920 | | | | 108.0/80.0 |
| | B-6E | 440 | 1,760 | 260 | 12.0 | 58.0 | 0.7230 | | | | 133.0/97.0 |
| | D-6B | 800 | 3,200 | 340 | 28.5 | 81.0 | 0.7230 | | | | 133.0/97.0 |
| | F-6A | 400 | 1,600 | 480 | 20.0 | 61.0 | 1.3900 | | | | 162.0/106.0 |
| | F-6B | 900 | 3,600 | 480 | 35.0 | 111.0 | 1.3900 | | | | 162.0/106.0 |
| 1MS375 | B-6B | 600 | 2,400 | 636 | 40.0 | 120.0 | 1.7300 | 405 | 620 | 170 | 205.0/132.0 |
| | D-6B | 600 | 2,400 | 875 | 55.0 | 150.0 | 1.7300 | | | | 205.0/132.0 |
| | D-6D | 300 | 1,200 | 875 | 27.5 | 94.0 | 1.7300 | | | | 205.0/132.0 |

All the specifications given are based on operation with liquid cooling and 540 V DC bus voltage.

¹⁾ available diameters depend on rotor version ²⁾ stator/rotor

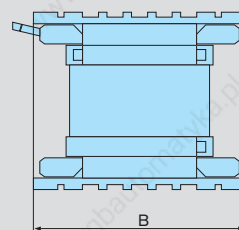
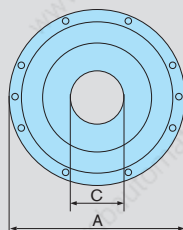
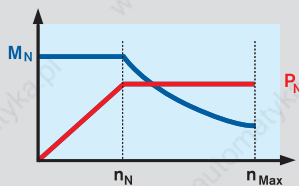

GTE – planetary gearboxes for standard applications

Together with our dynamic MSK motors, the compact GTE range of planetary gearboxes guarantees high torques in all standard applications.

Typical areas of application include simple handling and automation systems with rack-and-pinion drives or synchronous belt drives.

Virtually all performance requirements can be met in these applications thanks to the subtle staggering of sizes and the high power density of the GTE gearboxes.

The single-stage or two-stage gearboxes can be supplied with a plain shaft or keyway.

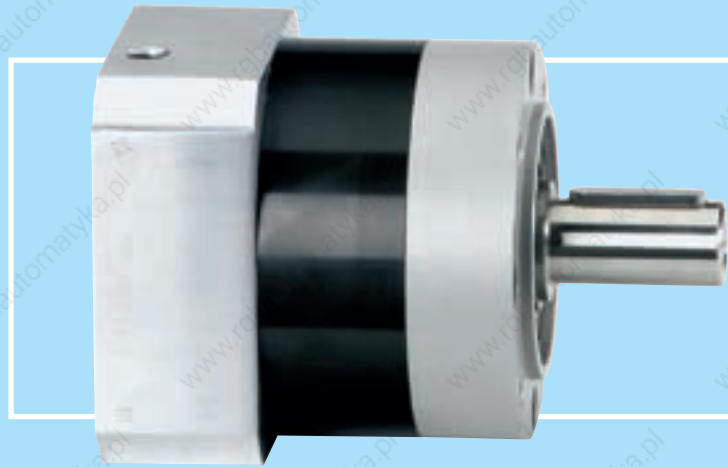

The simple step-by-step guide to ordering your GTE planetary gearboxes:

Option
GTE060-NN1-004A-NN03

Gearbox

- Size (e. g. "040")

Gear stages

- 1 = Single-stage
- 2 = Two-stage

Output shaft and backlash

- A = with keyway
- B = Plain shaft

Motor/gearbox combination

| | Motor | GTE060 | GTE080 | GTE120 | GTE160 |
|-----|-------|--------|--------|--------------------|--------------------|
| MSK | 030 | NN02 | NN02 | – | – |
| | 040 | – | NN03 | NN03 | – |
| | 050 | – | – | NN20 | NN20 |
| | 060 | – | – | NN21 ¹⁾ | NN21 |
| | 061 | – | – | NN05 ¹⁾ | NN05 |
| | 070 | – | – | – | NN16 |
| | 071 | – | – | – | NN16 |
| | 075 | – | – | – | NN16 |
| | 076 | – | – | – | NN06 |
| | 100 | – | – | – | NN09 ¹⁾ |

¹⁾ combination only possible with single-stage gearboxes

Economical and compact

- ! Ideal for standard applications
- ! Low backlash
- ! Open choice of mounting positions
- ! Silent operation
- ! Lifetime lubrication

Your benefits

| Gearbox | Transmission ratio | | Nominal input speed | Maximum input speed | Maximum output speed | Nominal input torque | Nominal output torque | Maximum input torque | Maximum output torque | Backlash | Torsional stiffness | Efficiency | Moment of inertia | Mass |
|---------|--------------------|------------------|---------------------|---------------------|----------------------|----------------------|-----------------------|----------------------|-----------------------|---------------|---------------------|------------------------|-------------------|------|
| | i | n_{IN} N [rpm] | n_{IN} Max [rpm] | n_{OUT} Max [rpm] | M_{IN} N [Nm] | M_{OUT} N [Nm] | M_{IN} Max [Nm] | M_{OUT} Max [Nm] | - [arcmin] | D [Nm/arcmin] | η [%] | J [kgcm ²] | m [kg] | |
| GTE060 | single-stage | 3 | 4,000 | 13,000 | 4,333 | 4.0 | 12 | 4.0 | 12 | < 20 | 1.5 | 96 | 0.135 | 0.9 |
| | | 4 | 4,000 | 13,000 | 3,250 | 4.0 | 16 | 4.0 | 16 | | | | | |
| | | 5 | 4,000 | 13,000 | 2,600 | 3.2 | 16 | 3.2 | 16 | | | | | |
| | | 8 | 4,000 | 13,000 | 1,625 | 1.9 | 15 | 1.9 | 15 | | | | | |
| | two-stage | 12 | 4,000 | 13,000 | 1,083 | 3.7 | 44 | 3.7 | 44 | < 25 | 1.5 | 94 | 0.127 | 1.1 |
| | | 20 | 4,000 | 13,000 | 650 | 2.2 | 44 | 2.2 | 44 | | | | | |
| GTE080 | single-stage | 3 | 4,000 | 7,000 | 2,333 | 13.3 | 40 | 13.3 | 40 | < 12 | 4.5 | 96 | 0.770 | 2.1 |
| | | 4 | 4,000 | 7,000 | 1,750 | 12.5 | 50 | 12.5 | 50 | | | | | |
| | | 5 | 4,000 | 7,000 | 1,400 | 10.0 | 50 | 10.0 | 50 | | | | | |
| | | 8 | 4,000 | 7,000 | 875 | 6.3 | 50 | 6.3 | 50 | | | | | |
| | two-stage | 12 | 4,000 | 7,000 | 583 | 10.0 | 120 | 10.0 | 120 | < 17 | 5.2 | 94 | 0.720 | 2.6 |
| | | 20 | 4,000 | 7,000 | 350 | 6.0 | 120 | 6.0 | 120 | | | | | |
| GTE120 | single-stage | 3 | 3,500 | 6,500 | 2,167 | 26.7 | 80 | 26.7 | 80 | < 8 | 11 | 96 | 2.630 | 6 |
| | | 4 | 3,500 | 6,500 | 1,625 | 25.0 | 100 | 25.0 | 100 | | | | | |
| | | 5 | 3,500 | 6,500 | 1,300 | 22.0 | 110 | 22.0 | 110 | | | | | |
| | | 8 | 3,500 | 6,500 | 813 | 15.0 | 120 | 15.0 | 120 | | | | | |
| | two-stage | 12 | 3,500 | 6,500 | 542 | 21.7 | 260 | 21.7 | 260 | < 12 | 11 | 94 | 2.560 | 8 |
| | | 20 | 3,500 | 6,500 | 325 | 13.0 | 260 | 13.0 | 260 | | | | | |
| GTE160 | single-stage | 3 | 3,000 | 6,500 | 2,167 | 133.3 | 400 | 133.3 | 400 | < 6 | 32.5 | 96 | 12.140 | 18 |
| | | 4 | 3,000 | 6,500 | 1,625 | 112.5 | 450 | 112.5 | 450 | | | | | |
| | | 5 | 3,000 | 6,500 | 1,300 | 90.0 | 450 | 90.0 | 450 | | | | | |
| | | 8 | 3,000 | 6,500 | 813 | 56.3 | 450 | 56.3 | 450 | | | | | |
| | two-stage | 12 | 3,000 | 6,500 | 542 | 66.7 | 800 | 66.7 | 800 | < 10 | 35 | 94 | 12.370 | 22 |
| | | 20 | 3,000 | 6,500 | 325 | 40.0 | 800 | 40.0 | 800 | | | | | |
| | | 40 | 3,000 | 6,500 | 163 | 17.5 | 700 | 17.5 | 700 | | | | 5.280 | |

GTM – planetary gearboxes for maximum performance

Characterized by a particularly high power density and low backlash, the high-precision GTM range of planetary gearboxes has been designed for mounting directly on servo motors.

Their high degree of efficiency makes these gearboxes suitable for the S1 continuous operation and therefore ideal for use in printing presses, for example.

Combined with the dynamic IndraDyn motors they achieve the highest speeds, acceleration and optimum positioning accuracy.

The single-stage or two-stage gearboxes can be supplied with a plain shaft or keyway and also with reduced backlash on request.

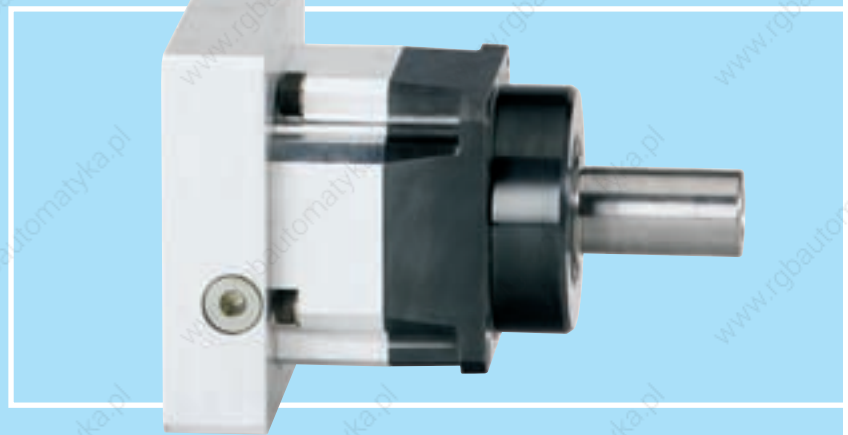

The simple step-by-step guide to ordering your GTM planetary gearbox:

GTM075-NN1-004A-NN03

Option

Gears

- Size (e. g. "075")

Gear range

- 1 = Single-stage
- 2 = Two-stage

Output shaft and backlash

- A = with keyway
- B = Plain shaft
- C = with keyway and reduced backlash
- D = Plain shaft, reduced backlash

Motor/gearbox combination

| | Motor | GTM060 | GTM075 | GTM100 | GTM140 | GTM180 | GTM240 |
|-----|-------|--------|--------|--------|--------------------|--------------------|--------------------|
| MSK | 030 | NN02 | – | – | – | – | – |
| | 040 | NN03 | NN03 | – | – | – | – |
| | 050 | – | NN20 | NN20 | NN20 | – | – |
| | 060 | – | NN21 | NN21 | NN21 | – | – |
| | 061 | – | NN05 | NN05 | NN05 | – | – |
| | 070 | – | – | NN16 | NN16 | NN16 | – |
| | 071 | – | – | NN16 | NN61 | NN16 | – |
| | 075 | – | – | NN16 | NN61 | NN16 | – |
| | 076 | – | – | NN06 | NN06 | – | – |
| | 100 | – | – | – | NN09 | NN09 | – |
| 101 | – | – | – | NN19 | NN19 | – | |
| 131 | – | – | – | – | NN15 ¹⁾ | NN15 ¹⁾ | |
| MKE | 037 | NN13 | – | – | – | – | – |
| | 047 | NN14 | NN14 | – | – | – | – |
| | 098 | – | – | NN06 | NN06 | – | – |
| MAD | 118 | – | – | – | NN09 | NN09 | – |
| | 100 | – | – | – | NN09 | NN09 | – |
| | 130 | – | – | – | – | NN11 ¹⁾ | NN11 ¹⁾ |
| MAF | 160 | – | – | – | – | – | NN12 ¹⁾ |
| | 100 | – | – | – | – | NN08 | – |
| | 130 | – | – | – | – | NN11 ¹⁾ | NN11 ¹⁾ |

¹⁾ combination only possible with single-stage gearboxes



High-precision and flexibility

- ! High-precision gearing for highest positioning accuracy
- ! Minimum power dissipation in continuous operation
- ! Optimized gear tooth forming for silent operation
- ! Environment-resistant, hermetically sealed housing
- ! High acceleration torque is achievable through a compact and rigid construction

Your benefits

| Gearbox | Transmission ratio | | Nominal input speed | Maximum input speed | Maximum output speed | Nominal input torque | Nominal output torque | Maximum input torque | Maximum output torque | Backlash standard / reduced | Torsional stiffness | Efficiency | Moment of inertia | Mass |
|---------|--------------------|----|---------------------|---------------------|----------------------|----------------------|-----------------------|----------------------|-----------------------|-----------------------------|---------------------|------------|------------------------|------|
| | | i | $n_{IN N}$ [rpm] | $n_{IN Max}$ [rpm] | $n_{OUT Max}$ [rpm] | $M_{IN N}$ [Nm] | $M_{OUT N}$ [Nm] | $M_{IN Max}$ [Nm] | $M_{OUT Max}$ [Nm] | - [arcmin] | D [Nm/arcmin] | η [%] | J [kgcm ²] | [kg] |
| GTM060 | single-stage | 4 | 3,000 | 5,000 | 1,250 | 6.25 | 25 | 12.5 | 50 | $\leq 6/\leq 3$ | 3.5 | ≥ 97 | 0.160 | 1.6 |
| | | 5 | 4,000 | 6,300 | 1,260 | 5.00 | 25 | 10.0 | 50 | | | | | |
| | | 7 | 5,000 | 8,000 | 1,143 | 3.60 | 25 | 7.1 | 50 | | | | | |
| | | 10 | 6,000 | 10,000 | 1,000 | 2.00 | 20 | 4.0 | 40 | | | | | |
| | two-stage | 20 | 4,000 | 6,300 | 315 | 1.25 | 25 | 2.5 | 50 | $\leq 8/\leq 6$ | ≥ 94 | 0.120 | 2.2 | |
| | | 50 | 6,000 | 10,000 | 200 | 0.50 | 25 | 1.0 | 50 | | | | | |
| GTM075 | single-stage | 4 | 3,000 | 5,000 | 1,250 | 21.30 | 85 | 42.5 | 170 | $\leq 6/\leq 3$ | 8.2 | ≥ 97 | 0.550 | 2.9 |
| | | 5 | 4,000 | 6,300 | 1,260 | 20.00 | 100 | 40.0 | 200 | | | | | |
| | | 7 | 5,000 | 8,000 | 1,143 | 12.10 | 85 | 24.3 | 170 | | | | | |
| | | 10 | 6,000 | 10,000 | 1,000 | 6.00 | 60 | 11.0 | 110 | | | | | |
| | two-stage | 20 | 4,000 | 6,300 | 315 | 4.25 | 85 | 8.5 | 170 | $\leq 8/\leq 6$ | ≥ 94 | 0.470 | 3.8 | |
| | | 50 | 6,000 | 10,000 | 200 | 2.00 | 100 | 4.0 | 200 | | | | | |
| GTM100 | single-stage | 3 | 2,300 | 4,000 | 1,333 | 40.00 | 120 | 73.3 | 220 | $\leq 4/\leq 2$ | 24 | ≥ 97 | 2.800 | 5.7 |
| | | 4 | 2,500 | 4,000 | 1,000 | 42.50 | 170 | 85.0 | 340 | | | | | |
| | | 5 | 3,000 | 5,000 | 1,000 | 40.00 | 200 | 80.0 | 400 | | | | | |
| | | 7 | 4,000 | 6,300 | 900 | 24.30 | 170 | 48.6 | 340 | | | | | |
| | | 10 | 5,000 | 8,000 | 800 | 12.00 | 120 | 22.0 | 220 | | | | | |
| | two-stage | 20 | 3,000 | 5,000 | 250 | 8.50 | 170 | 17.0 | 340 | $\leq 6/\leq 4$ | ≥ 94 | 1.560 | 7.5 | |
| | | 50 | 5,000 | 8,000 | 160 | 4.00 | 200 | 8.0 | 400 | | | | | |
| | | | | | | | | | | | | 1.440 | | |
| GTM140 | single-stage | 3 | 1,800 | 3,200 | 1,067 | 93.30 | 280 | 186.7 | 560 | $\leq 4/\leq 2$ | 48 | ≥ 97 | 8.200 | 11.5 |
| | | 4 | 2,000 | 3,200 | 800 | 105.00 | 420 | 210.0 | 840 | | | | | |
| | | 5 | 2,500 | 4,000 | 800 | 100.00 | 500 | 200.0 | 1,000 | | | | | |
| | | 7 | 3,000 | 5,000 | 714 | 60.00 | 420 | 120.0 | 840 | | | | | |
| | | 10 | 4,000 | 6,300 | 630 | 28.00 | 280 | 56.0 | 560 | | | | | |
| | two-stage | 20 | 2,500 | 4,000 | 200 | 21.00 | 420 | 42.0 | 840 | $\leq 6/\leq 4$ | ≥ 94 | 5.290 | 15 | |
| | | 50 | 4,000 | 6,300 | 126 | 10.00 | 500 | 20.0 | 1,000 | | | | | |
| GTM180 | single-stage | 3 | 1,300 | 2,500 | 833 | 240.00 | 720 | 480.0 | 1,440 | $\leq 4/\leq 2$ | 148 | ≥ 97 | 36.000 | 27 |
| | | 4 | 1,500 | 2,500 | 625 | 255.00 | 1,020 | 510.0 | 2,040 | | | | | |
| | | 5 | 2,000 | 3,200 | 640 | 240.00 | 1,200 | 480.0 | 2,400 | | | | | |
| | | 7 | 2,500 | 4,000 | 571 | 145.70 | 1,020 | 291.4 | 2,040 | | | | | |
| | | 10 | 3,000 | 5,000 | 500 | 72.00 | 720 | 144.0 | 1,440 | | | | | |
| | two-stage | 20 | 2,000 | 3,200 | 160 | 51.00 | 1,020 | 102.0 | 2,040 | $\leq 6/\leq 4$ | ≥ 94 | 6.950 | 35 | |
| | | 50 | 3,000 | 5,000 | 100 | 24.00 | 1,200 | 48.0 | 2,400 | | | | | |
| | | | | | | | | | | | | 5.450 | | |
| GTM240 | single-stage | 3 | 800 | 2,000 | 667 | 600.00 | 1,800 | 1,000.0 | 3,000 | $\leq 4/\leq 2$ | 340 | ≥ 97 | 128.000 | 62 |
| | | 4 | 1,000 | 2,000 | 500 | 625.00 | 2,500 | 1,250.0 | 5,000 | | | | | |
| | | 5 | 1,200 | 2,500 | 500 | 600.00 | 3,000 | 1,200.0 | 6,000 | | | | | |
| | | 7 | 1,500 | 3,000 | 429 | 357.10 | 2,500 | 714.3 | 5,000 | | | | | |
| | | 10 | 2,000 | 3,500 | 350 | 180.00 | 1,800 | 300.0 | 3,000 | | | | | |
| | | | | | | | | | | | | | 51.100 | |

Standard and geared motors – for simple applications

For use with frequency converters we recommend combining IndraDrive with geared motors or three-phase asynchronous motors made by NORD Drive Systems or VEM Motors.

Upon request we can supply all-in-one solutions, comprising of control units and motors also sourced directly from Rexroth.

Our range of geared motors covers various types of gears of different performance categories:

- Spur gear motors with rated outputs of up to 160 kW and torques of up to 26,000 Nm

- Offset geared motors with rated outputs of up to 200 kW and torques of up to 200,000 Nm
- Bevel gear motors with rated outputs of up to 160 kW and torques of up to 32,000 Nm
- Worm gear motors with rated outputs of up to 15 kW and torques of up to 3,000 Nm

Our range of three-phase asynchronous motors includes:

- Standard motors with rated outputs of up to 500 kW
- Energy-saving motors with rated outputs of up to 335 kW

These motors are particularly suitable for operation with frequency converters and boast the following features:

- Motor design conforming to DIN EN 60034 (IEC 72)
- Mounting dimensions and output correlation compliant with DIN 42673, 42677
- Robust, low-vibration version in gray cast iron
- Protection category IP 55, higher protection category up to IP 65 optional
- Insulation class F with thermal reserve, insulation class H optional
- Further options include brakes, encoder, position of terminal box, etc.



Cross reference for IEC standard motors

| Mechanical motor output P _{Nom} | I _{Nom} | cos φ | η | Continuous operation I _{Nom} (> 10 min) | Overload operation 1.1 x I _{Nom} (1 min) I _{Nom} (9 min) | Overload operation 1.5 x I _{Nom} (1 min) I _{Nom} (4 min) | Overload operation 2 x I _{Nom} (2 s) I _{Nom} (18 s) |
|---|------------------|-------|--------|--|--|--|---|
| 1.1 kW | 2.6 A | 0.79 | 76.6 % | HCS02.1E-W0012 HMS01.1N-W0020 HMD01.1N-W0012 | HCS02.1E-W0012 HMS01.1N-W0020 HMD01.1N-W0012 | HCS02.1E-W0012 HMS01.1N-W0020 HMD01.1N-W0012 | HCS02.1E-W0012 HMS01.1N-W0020 HMD01.1N-W0012 |
| 1.5 kW | 3.4 A | 0.81 | 78.8 % | HCS02.1E-W0012 HMS01.1N-W0020 HMD01.1N-W0012 | HCS02.1E-W0012 HMS01.1N-W0020 HMD01.1N-W0012 | HCS02.1E-W0028 HMS01.1N-W0020 HMD01.1N-W0012 | HCS02.1E-W0028 HMS01.1N-W0020 HMD01.1N-W0012 |
| 2.2 kW | 5.2 A | 0.76 | 81.0 % | HCS02.1E-W0028 HMS01.1N-W0020 HMD01.1N-W0012 | HCS02.1E-W0028 HMS01.1N-W0020 HMD01.1N-W0012 | HCS02.1E-W0028 HMS01.1N-W0020 HMD01.1N-W0012 | HCS02.1E-W0028 HMS01.1N-W0020 HMD01.1N-W0012 |
| 3.0 kW | 6.7 A | 0.79 | 82.0 % | HCS02.1E-W0028 HMS01.1N-W0020 HMD01.1N-W0012 | HCS02.1E-W0028 HMS01.1N-W0020 HMD01.1N-W0020 | HCS02.1E-W0028 HMS01.1N-W0020 HMD01.1N-W0020 | HCS02.1E-W0028 HMS01.1N-W0020 HMD01.1N-W0020 |
| 4.0 kW | 8.8 A | 0.78 | 84.2 % | HCS02.1E-W0028 HMS01.1N-W0020 HMD01.1N-W0020 | HCS02.1E-W0028 HMS01.1N-W0020 HMD01.1N-W0020 | HCS02.1E-W0028 HMS01.1N-W0036 HMD01.1N-W0036 | HCS02.1E-W0054 ¹⁾ HMS01.1N-W0036 HMD01.1N-W0036 |
| 5.5 kW | 11.8 A | 0.77 | 85.7 % | HCS02.1E-W0054 ¹⁾ HMS01.1N-W0020 HMD01.1N-W0036 | HCS02.1E-W0054 ¹⁾ HMS01.1N-W0036 HMD01.1N-W0036 | HCS02.1E-W0054 ¹⁾ HMS01.1N-W0036 HMD01.1N-W0036 | HCS02.1E-W0054 ¹⁾ HMS01.1N-W0036 HMD01.1N-W0036 |
| 7.5 kW | 15.0 A | 0.84 | 87.0 % | HCS02.1E-W0054 ¹⁾ HMS01.1N-W0036 HMD01.1N-W0036 | HCS02.1E-W0054 ¹⁾ HMS01.1N-W0036 HMD01.1N-W0036 | HCS02.1E-W0070 ¹⁾ HMS01.1N-W0036 HMD01.1N-W0036 | HCS02.1E-W0070 ¹⁾ HMS01.1N-W0036 HMD01.1N-W0036 |
| 11.0 kW | 21.0 A | 0.85 | 88.4 % | HCS02.1E-W0070 ¹⁾ HMS01.1N-W0036 | HCS02.1E-W0070 ¹⁾ HMS01.1N-W0054 | HCS02.1E-W0070 ¹⁾ HMS01.1N-W0054 | HCS03.1E-W0070 ¹⁾ HMS01.1N-W0054 |
| 15.0 kW | 28.0 A | 0.86 | 89.4 % | HCS03.1E-W0070 ¹⁾ HMS01.1N-W0054 | HCS03.1E-W0070 ¹⁾ HMS01.1N-W0054 | HCS03.1E-W0070 ¹⁾ HMS01.1N-W0070 | HCS03.1E-W0070 ¹⁾ HMS01.1N-W0070 |
| 18.5 kW | 34.5 A | 0.86 | 90.0 % | HCS03.1E-W0070 ¹⁾ HMS01.1N-W0054 | HCS03.1E-W0070 ¹⁾ HMS01.1N-W0070 | HCS03.1E-W0100 ¹⁾ HMS01.1N-W0110 | HCS03.1E-W0100 ¹⁾ HMS01.1N-W0110 |
| 22.0 kW | 42.0 A | 0.84 | 90.5 % | HCS03.1E-W0070 ¹⁾ HMS01.1N-W0070 | HCS03.1E-W0100 ¹⁾ HMS01.1N-W0110 | HCS03.1E-W0100 ¹⁾ HMS01.1N-W0110 | HCS03.1E-W0100 ¹⁾ HMS01.1N-W0110 |
| 30.0 kW | 55.5 A | 0.85 | 91.5 % | HCS03.1E-W0100 ¹⁾ HMS01.1N-W0110 | HCS03.1E-W0100 ¹⁾ HMS01.1N-W0110 | HCS03.1E-W0150 ¹⁾ HMS01.1N-W0150 | HCS03.1E-W0150 ¹⁾ HMS01.1N-W0150 |
| 37.0 kW | 67.0 A | 0.86 | 92.5 % | HCS03.1E-W0100 ¹⁾ HMS01.1N-W0110 | HCS03.1E-W0150 ¹⁾ HMS01.1N-W0150 | HCS03.1E-W0150 ¹⁾ HMS01.1N-W0150 | HCS03.1E-W0150 ¹⁾ HMS01.1N-W0150 |
| 45.0 kW | 81.0 A | 0.86 | 93.0 % | HCS03.1E-W0150 ¹⁾ HMS01.1N-W0150 | HCS03.1E-W0150 ¹⁾ HMS01.1N-W0150 | HCS03.1E-W0210 ¹⁾ HMS01.1N-W0210 | HCS03.1E-W0210 ¹⁾ HMS01.1N-W0210 |
| 55.0 kW | 98.5 A | 0.86 | 93.5 % | HCS03.1E-W0210 ¹⁾ HMS01.1N-W0150 | HCS03.1E-W0210 ¹⁾ HMS01.1N-W0210 | HCS03.1E-W0210 ¹⁾ HMS01.1N-W0210 | HCS03.1E-W0210 ¹⁾ HMS01.1N-W0210 |
| 75.0 kW | 134.0 A | 0.86 | 94.1 % | HCS03.1E-W0210 ¹⁾ HMS01.1N-W0210 | HCS03.1E-W0210 ¹⁾ HMS01.1N-W0210 | HMS01.1N-W0350 ²⁾ | HMS01.1N-W0350 ²⁾ |
| 90.0 kW | 160.0 A | 0.86 | 94.6 % | HMS01.1N-W0350 ²⁾ | HMS01.1N-W0350 ²⁾ | HMS01.1N-W0350 ²⁾ | HMS01.1N-W0350 ²⁾ |
| 110.0 kW | 194.0 A | 0.86 | 95.1 % | HMS01.1N-W0350 ²⁾ | HMS01.1N-W0350 ²⁾ | - | - |
| 132.0 kW | 233.0 A | 0.86 | 95.1 % | HMS01.1N-W0350 ²⁾ | HMS01.1N-W0350 ²⁾ | - | - |

The examples apply to operation of 4-pole standard motors 3 AC 400 V/50 Hz at 4 kHz switching frequency and a rotary frequency > 4 Hz. An external fan may be necessary depending on your application. ¹⁾ with HNL power choke ²⁾ preliminary

Cross reference for NEMA standard motors

| Mechanical motor output P _{Nom} | I _{Nom} | cos φ | η | Continuous operation I _{Nom} (> 10 min) | Overload operation 1.1 x I _{Nom} (1 min) I _{Nom} (9 min) | Overload operation 1.5 x I _{Nom} (1 min) I _{Nom} (4 min) | Overload operation 2 x I _{Nom} (2 s) I _{Nom} (18 s) |
|---|------------------|-------|--------|--|--|--|---|
| 1.5 hp | 2.3 A | 0.72 | 82.5 % | HCS02.1E-W0012 HMS01.1N-W0020 HMD01.1N-W0012 | HCS02.1E-W0012 HMS01.1N-W0020 HMD01.1N-W0012 | HCS02.1E-W0012 HMS01.1N-W0020 HMD01.1N-W0012 | HCS02.1E-W0012 HMS01.1N-W0020 HMD01.1N-W0012 |
| 2.0 hp | 3.0 A | 0.78 | 85.5 % | HCS02.1E-W0012 HMS01.1N-W0020 HMD01.1N-W0012 | HCS02.1E-W0012 HMS01.1N-W0020 HMD01.1N-W0012 | HCS02.1E-W0012 HMS01.1N-W0020 HMD01.1N-W0012 | HCS02.1E-W0012 HMS01.1N-W0020 HMD01.1N-W0012 |
| 3.0 hp | 4.0 A | 0.80 | 90.2 % | HCS02.1E-W0028 HMS01.1N-W0020 HMD01.1N-W0012 | HCS02.1E-W0028 HMS01.1N-W0020 HMD01.1N-W0012 | HCS02.1E-W0028 HMS01.1N-W0020 HMD01.1N-W0012 | HCS02.1E-W0028 HMS01.1N-W0020 HMD01.1N-W0012 |
| 5.0 hp | 6.7 A | 0.79 | 88.5 % | HCS02.1E-W0028 HMS01.1N-W0020 HMD01.1N-W0012 | HCS02.1E-W0028 HMS01.1N-W0020 HMD01.1N-W0020 | HCS02.1E-W0028 HMS01.1N-W0020 HMD01.1N-W0020 | HCS02.1E-W0028 HMS01.1N-W0020 HMD01.1N-W0020 |
| 7.5 hp | 9.7 A | 0.81 | 88.5 % | HCS02.1E-W0054 ¹⁾ HMS01.1N-W0020 HMD01.1N-W0020 | HCS02.1E-W0054 ¹⁾ HMS01.1N-W0020 HMD01.1N-W0036 | HCS02.1E-W0054 ¹⁾ HMS01.1N-W0036 HMD01.1N-W0036 | HCS02.1E-W0054 ¹⁾ HMS01.1N-W0036 HMD01.1N-W0036 |
| 10.0 hp | 12.7 A | 0.81 | 90.2 % | HCS02.1E-W0054 ¹⁾ HMS01.1N-W0036 HMD01.1N-W0036 | HCS02.1E-W0054 ¹⁾ HMS01.1N-W0036 HMD01.1N-W0036 | HCS02.1E-W0054 ¹⁾ HMS01.1N-W0036 HMD01.1N-W0036 | HCS02.1E-W0054 ¹⁾ HMS01.1N-W0036 HMD01.1N-W0036 |
| 15.0 hp | 18.5 A | 0.84 | 90.2 % | HCS02.1E-W0070 ¹⁾ HMS01.1N-W0036 HMD01.1N-W0036 | HCS02.1E-W0070 ¹⁾ HMS01.1N-W0036 HMD01.1N-W0036 | HCS02.1E-W0070 ¹⁾ HMS01.1N-W0054 - | HCS02.1E-W0070 ¹⁾ HMS01.1N-W0054 - |
| 20.0 hp | 26.0 A | 0.78 | 91.0 % | HCS03.1E-W0070 ¹⁾ HMS01.1N-W0054 | HCS03.1E-W0070 ¹⁾ HMS01.1N-W0054 | HCS03.1E-W0070 ¹⁾ HMS01.1N-W0054 | HCS03.1E-W0070 ¹⁾ HMS01.1N-W0054 |
| 25.0 hp | 31.5 A | 0.82 | 91.7 % | HCS03.1E-W0070 ¹⁾ HMS01.1N-W0054 | HCS03.1E-W0070 ¹⁾ HMS01.1N-W0054 | HCS03.1E-W0100 ¹⁾ HMS01.1N-W0110 | HCS03.1E-W0070 ¹⁾ HMS01.1N-W0110 |
| 30.0 hp | 38.5 A | 0.79 | 93.0 % | HCS03.1E-W0070 ¹⁾ HMS01.1N-W0070 | HCS03.1E-W0070 ¹⁾ HMS01.1N-W0070 | HCS03.1E-W0100 ¹⁾ HMS01.1N-W0110 | HCS03.1E-W0100 ¹⁾ HMS01.1N-W0110 |
| 40.0 hp | 50.0 A | 0.82 | 91.7 % | HCS03.1E-W0100 ¹⁾ HMS01.1N-W0110 | HCS03.1E-W0100 ¹⁾ HMS01.1N-W0110 | HCS03.1E-W0100 ¹⁾ HMS01.1N-W0150 | HCS03.1E-W0150 ¹⁾ HMS01.1N-W0150 |
| 50.0 hp | 60.5 A | 0.81 | 92.4 % | HCS03.1E-W0100 ¹⁾ HMS01.1N-W0110 | HCS03.1E-W0100 ¹⁾ HMS01.1N-W0110 | HCS03.1E-W0150 ¹⁾ HMS01.1N-W0150 | HCS03.1E-W0150 ¹⁾ HMS01.1N-W0150 |
| 60.0 hp | 73.5 A | 0.83 | 91.7 % | HCS03.1E-W0150 ¹⁾ HMS01.1N-W0150 | HCS03.1E-W0150 ¹⁾ HMS01.1N-W0150 | HCS03.1E-W0210 ¹⁾ HMS01.1N-W0210 | HCS03.1E-W0210 ¹⁾ HMS01.1N-W0210 |
| 75.0 hp | 92.0 A | 0.82 | 94.1 % | HCS03.1E-W0150 ¹⁾ HMS01.1N-W0150 | HCS03.1E-W0210 ¹⁾ HMS01.1N-W0150 | HCS03.1E-W0210 ¹⁾ HMS01.1N-W0210 | HCS03.1E-W0210 ¹⁾ HMS01.1N-W0210 |
| 100.0 hp | 115.0 A | 0.87 | 94.5 % | HCS03.1E-W0210 ¹⁾ HMS01.1N-W0210 | HCS03.1E-W0210 ¹⁾ HMS01.1N-W0210 | HMS01.1N-W0350 ²⁾ | HMS01.1N-W0350 ²⁾ |
| 125.0 hp | 143.0 A | 0.87 | 94.5 % | HMS01.1N-W0210 | HMS01.1N-W0350 ²⁾ | HMS01.1N-W0350 ²⁾ | HMS01.1N-W0350 ²⁾ |
| 150.0 hp | 170.0 A | 0.87 | 95.4 % | HMS01.1N-W0350 ²⁾ | HMS01.1N-W0350 ²⁾ | HMS01.1N-W0350 ²⁾ | HMS01.1N-W0350 ²⁾ |
| 200.0 hp | 230.0 A | 0.86 | 95.0 % | HMS01.1N-W0350 ²⁾ | HMS01.1N-W0350 ²⁾ | - | - |

The examples apply to operation of 4-pole standard motors 3 AC 400 V/60 Hz at 4 kHz switching frequency and a rotary frequency > 4 Hz. An external fan may be necessary depending on your application. ¹⁾ with HNL power choke ²⁾ preliminary

Auxiliary components





Accessories for all requirements

- ▮ Filters and chokes for EMC-proof operation
- ▮ Components designed to absorb high braking forces
- ▮ Energy storage capacitors for dynamic sequences
- ▮ Accessories for simplified assembly and installation

Your benefits

Mains filters

- EMC filters for the power supply units and converters
- for reduced circuit feedback

Mains filters with integrated mains choke

- for direct mounting on HCS03 series converters

Mains chokes

- for increased DC bus continuous output
- for reduced harmonics

Motor filters

- to protect the motor winding from extreme voltage rises
- for effective reduction of malfunctions in the motor supply line

Brake resistor

- for input power during regenerative operation
- for direct mounting on HCS02 and HCS03 series converters

Brake units

- brake resistor and braking transistor in one unit
- for increased braking power

Capacity modules

- capacitor unit for dynamic energy storage
- can be combined with power supply units or converters to save space

Blower unit

- for direct installation to supply unit HMV01.1R-W0120 and inverter HMS01.1N-W0350

Other accessories

- basic accessories for assembly and installation
- shield connection for EMC-compatible connection of the motor cable to the power unit
- control cabinet adapter for combining control units of different depths
- auxiliary capacitor
- electrical adaptors
- modular bus extension to bridge larger distances between drive groups

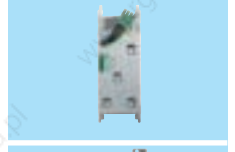

Mains filters – for HMV power supply units and HCS converters

| Mains filters for HMV power supply units and HCS converters | Continuous current | Power dissipation | Width W | Height H | Depth D | Mass |
|---|-----------------------|----------------------|-----------|-----------|-----------|-----------|
| | A | W | mm | mm | mm | kg |
| HNFO1.1A-F240-E0051-A-480-NNNN | 51 | < 89 | 100 | 440 | 262 | 15 |
| HNFO1.1A-M900-E0051-A-480-NNNN | 51 | < 91 | 100 | 440 | 262 | 15 |
| HNFO1.1A-F240-E0125-A-480-NNNN | 125 | < 127 | 150 | 440 | 262 | 18 |
| HNFO1.1A-M900-E0125-A-480-NNNN | 125 | < 174 | 150 | 440 | 262 | 30 |
| HNFO1.1A-F240-E0202-A-480-NNNN | 202 | < 238 | 150 | 440 | 262 | 29 |
| HNFO1.1A-M900-E0202-A-480-NNNN | 202 | < 373 | 250 | 440 | 262 | 37 |
| HNFO1.1A-A075-E0235-A-500-NNNN | 235 | in prep. | in prep. | in prep. | in prep. | in prep. |
| HNFO1.1A-A075-E0309-A-500-NNNN | 309 | in prep. | 175 | 263 | 180 | in prep. |
| HNFO1.1A-F240-R0026-A-480-NNNN | 26 | < 73 | 100 | 440 | 262 | 14 |
| HNFO1.1A-M900-R0026-A-480-NNNN | 26 | < 77 | 150 | 440 | 262 | 17 |
| HNFO1.1A-F240-R0065-A-480-NNNN | 65 | < 163 | 150 | 440 | 262 | 25 |
| HNFO1.1A-M900-R0065-A-480-NNNN | 65 | < 157 | 150 | 440 | 262 | 26 |
| HNFO1.1A-F240-R0094-A-480-NNNN | 94 | < 135 | 150 | 440 | 262 | 28 |
| HNFO1.1A-M900-R0094-A-480-NNNN | 94 | < 146 | 150 | 440 | 262 | 29 |
| HNFO1.1A-H350-R0180-A-480-NNNN | 180 | < 305 | 250 | 440 | 262 | 45 |
| HNS02.1A-Q200-R0023-A-480-NNNN | 23 | < 75 | 80 | 352 | 265 | 15 |
| for HCS converters | A | W | mm | mm | mm | kg |
| NFD03.1-480-007 | 7 | 3.9 | 50 | 160 | 90 | 0.7 |
| NFD03.1-480-016 | 16 | 6.4 | 55 | 220 | 90 | 1 |
| NFD03.1-480-030 | 30 | 11.9 | 60 | 270 | 100 | 1.4 |
| NFD03.1-480-055 | 55 | 25.9 | 90 | 220 | 105 | 2 |
| NFD03.1-480-075 | 75 | 30.4 | 90 | 240 | 145 | 3.5 |

All data applies to nominal rating at 3 AC 400 V mains voltage. Please see the selection tables on the end of this chapter for exact assignments to the power units.



Mains filters ensure that the EMC limit values are adhered to and suppress leakage current generated by line capacitors.

Our mains filters are optimally coordinated with the power units and are scalable in regards to current, number of drives and motor cable length.

They can be combined with our shielded motor cables for trouble-free operation conforming to EN 61800-3, Class A, Group 2, even with cable lengths of up to 75 m.

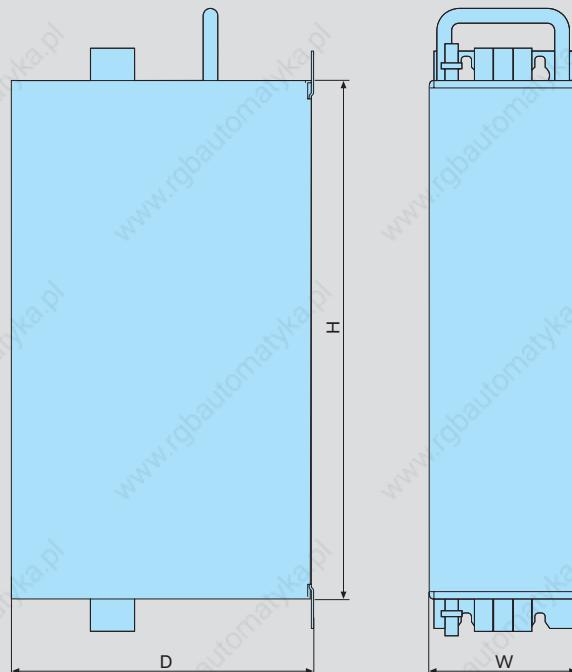

Mains filters with integrated mains choke – for HCS03 converters

| Mains filters with integrated mains choke | Continuous current | Power dissipation | Nominal inductance | Capacitance | Width W | Height H | Depth D | Mass |
|---|--------------------|-------------------|--------------------|---------------|---------|----------|---------|------|
| | A | W | μH | μF | mm | mm | mm | kg |
| HNK01.1A-A075-E0050-A-500-NNNN | 50 | 50 | 3 x 571 | 3 x 1.1 | 125 | 322.5 | 251.5 | 15 |
| HNK01.1A-A075-E0080-A-500-NNNN | 80 | 80 | 3 x 362 | 3 x 2.2 | 225 | 310 | 270 | 20 |
| HNK01.1A-A075-E0106-A-500-NNNN | 106 | 110 | 3 x 240 | 3 x 2.2 | 225 | 310 | 270 | 20 |
| HNK01.1A-A075-E0146-A-500-NNNN | 146 | 130 | 3 x 170 | 3 x 2.2 | 350 | 380 | 270 | 28 |

All data applies to nominal rating at 3 AC 400 V mains voltage. Please see the selection tables on the end of this chapter for exact assignments to the power units.

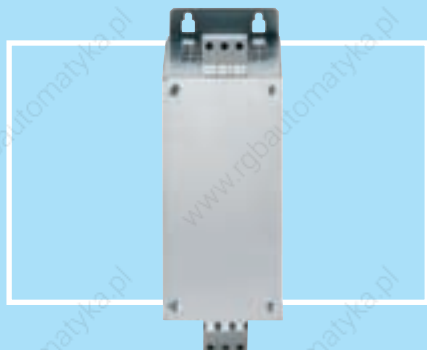

The combination of mains filter and mains choke in one unit simplifies assembly and installation. It is simply fitted underneath the converter to form one space-saving unit. It is also a particularly easy way to comply with the directives contained in EN 61800-3, Class A, Group 2.

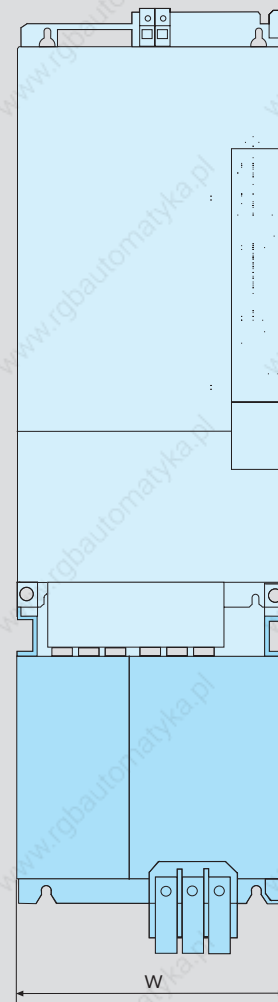
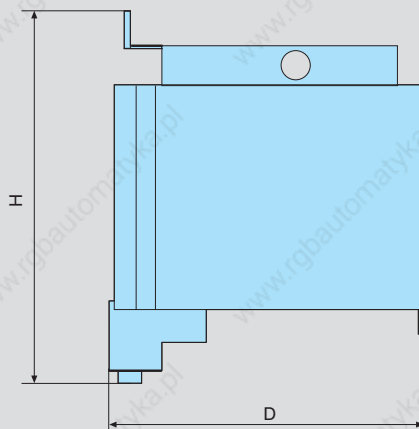

Example of assembly

Mains chokes – for HMV power supply units and HCS converters

| Mains choke | Continuous current | Power dissipation | Nominal inductance | Capacitance | Width W | Height H | Depth D | Mass |
|--------------------------------|--------------------|-------------------|--------------------|---------------|---------|----------|---------|------|
| | A | W | μH | μF | mm | mm | mm | kg |
| HNL01.1E-1000-N0012-A-500-NNNN | 12 | 40 | 3 x 1,000 | – | 120 | 164 | 61 | 2.7 |
| HNL01.1E-1000-N0020-A-500-NNNN | 20 | 60 | 3 x 1,000 | – | 150 | 184 | 66.5 | 3.8 |
| HNL01.1E-0600-N0032-A-500-NNNN | 32 | 75 | 3 x 600 | – | 150 | 184 | 66.5 | 4.5 |
| HNL01.1E-0400-N0051-A-480-NNNN | 51 | 165 | 3 x 400 | – | 180 | 225 | 112 | 13.5 |
| HNL01.1E-0200-N0125-A-480-NNNN | 125 | 170 | 3 x 200 | – | 230 | 295 | 148 | 24 |
| HNL01.1E-0100-N0202-A-480-NNNN | 202 | 200 | 3 x 100 | – | 265 | 350 | 152 | 33 |
| HNL01.1R-0980-C0026-A-480-NNNN | 26 | 225 | 3 x 980 | 3 x 10 | 210 | 245 | 172 | 16 |
| HNL01.1R-0590-C0065-A-480-NNNN | 65 | 310 | 3 x 590 | 3 x 20 | 300 | 360 | 205 | 45 |
| HNL01.1R-0540-C0094-A-480-NNNN | 94 | 420 | 3 x 540 | 3 x 20 | 340 | 385 | 229 | 65 |
| HNL01.1R-0300-C0180-A-480-NNNN | 180 | 800 | 3 x 300 | 3 x 30 | 340 | 400 | 261 | 73 |
| HNL02.1R-0980-C0023-A-480-NNNN | 23 | 95 | 3 x 980 | 3 x 10 | 165 | 352 | 115 | 14 |
| HNL01.1E-0571-N0050-A-500-NNNN | 50 | 50 | 3 x 571 | – | 183 | 238 | 100 | 13 |
| HNL01.1E-0362-N0080-A-500-NNNN | 80 | 80 | 3 x 362 | – | 205 | 175 | 180 | 17 |
| HNL01.1E-0240-N0106-A-500-NNNN | 106 | 100 | 3 x 240 | – | 205 | 193 | 210 | 17 |
| HNL01.1E-0170-N0146-A-500-NNNN | 146 | 130 | 3 x 170 | – | 250 | 205 | 230 | 23 |

All data applies to nominal rating at 3 AC 400 V mains voltage. Please see the selection tables on the end of this chapter for exact assignments to the power units.

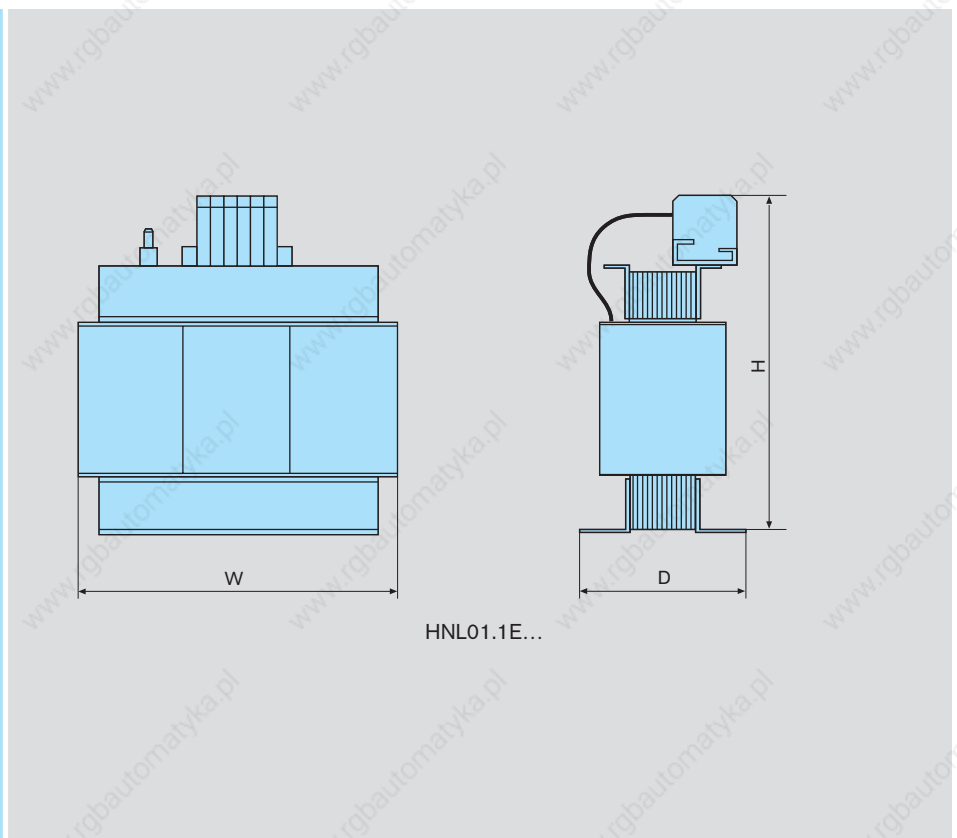

In connection with the mains chokes, converters and infeed power supply units realize higher DC bus continuous power. They reduce the harmonics in the line current while simultaneously preventing circuit feedback.

When using supply units with line regeneration, these components are always required.

This combination always complies to the permissible EMC values for industrial networks stipulated by EN 61000-2-4.

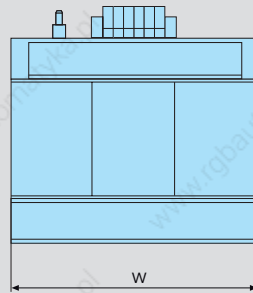

HNL01.1R...

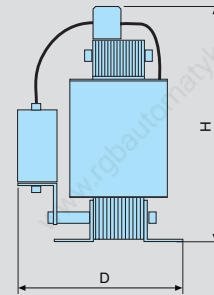

HNL02.1R...

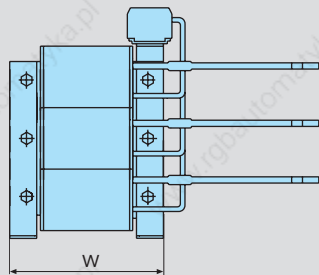
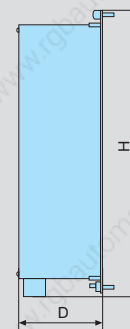

HNL01.1E-0571...

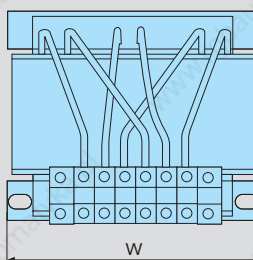
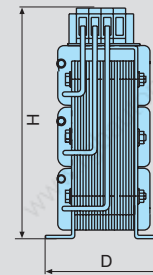

HNL01.1E-0362... to HNL01.1E-0170...

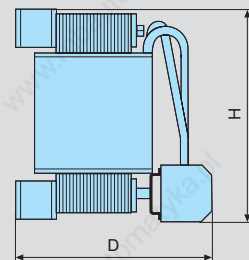

Motor filters – for HCS converters

| Motor filter | Continuous current | Power dissipation | Inductance | Width W | Height H | Depth D | Mass |
|--------------------------------|--------------------|-------------------|---------------|---------|----------|---------|------|
| | A | W | μH | mm | mm | mm | kg |
| HMF01.1N-N0K2-M0012-A-500-NNNN | 12 | in prep. | 3 x 900 | 155 | 162 | 92 | 5 |
| HMF01.1N-N0K2-M0028-A-500-NNNN | 28 | in prep. | 3 x 450 | 210 | 182 | 130 | 11 |
| HMF01.1A-N0K2-D0045-A-500-NNNN | 45 | 120 | 3 x 160 | 125 | 330 | 270 | 15 |
| HMF01.1A-N0K2-D0073-A-500-NNNN | 72 | 160 | 3 x 100 | 225 | 315 | 270 | 20 |
| HMF01.1A-N0K2-D0095-A-500-NNNN | 95 | 190 | 3 x 78 | 225 | 315 | 270 | 20 |
| HMF01.1A-N0K2-D0145-A-500-NNNN | 145 | 220 | 3 x 50 | 350 | 400 | 260 | 38 |

All data applies to nominal rating at 3 AC 400 V mains voltage and 4 kHz clock frequency. The maximum output frequency is 200 Hz. Please see the selection tables on the end of this chapter for exact assignments to the power units.



The combination of the steep switching curves of modern converters and long motor wires can often cause transient overvoltages on the motor terminals. This, along with the leakage current of the motor wires, can be reduced by using a motor filter on the inverter output.

This has the following advantages:

- Voltage rise limited to values below 1 kV/ μs
- Winding insulation protected by limiting the voltage peak to max. 1,000 V
- Operation of several motors connected in parallel on one frequency converter via long supply lines
- Compliance with increased EMC requirements thanks to reduced interference voltages

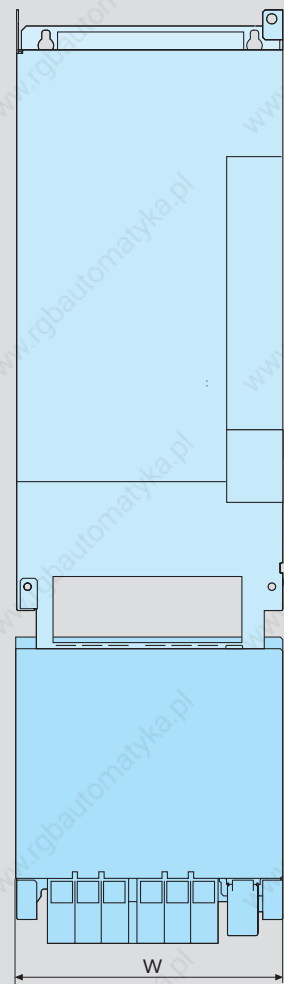
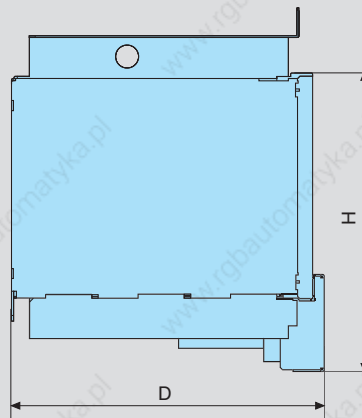

Example of assembly for HMF...D0045 to ...D0145

Brake resistors – for HCS converters

| Braking resistor | Maximum energy consumption | Braking power | | | | Resistance | Width W | Height H | Depth D | Mass |
|--------------------------------|----------------------------|---------------|------|----------------------|-------------------------|------------|---------|----------|---------|------|
| | | Duration | max. | t _{on} time | t _{cycle} time | | | | | |
| | kWs | kW | kW | s | s | Ω | mm | mm | mm | kg |
| HLR01.1N-0300-N17R5-A-007-NNNN | 37 | 0.30 | 37 | 1 | 120 | 20.5 | 123 | 300 | 196 | 3 |
| HLR01.1N-0470-N11R7-A-007-NNNN | 56 | 0.47 | 56 | 1 | 120 | 13.7 | 223 | 300 | 210 | 4.5 |
| HLR01.1N-0780-N07R0-A-007-NNNN | 93 | 0.78 | 93 | 1 | 120 | 8.2 | 223 | 300 | 210 | 5.5 |
| HLR01.1N-1K08-N05R0-A-007-NNNN | 130 | 1.08 | 130 | 1 | 120 | 5.8 | 350 | 300 | 220 | 8 |

Please see the selection tables on the end of this chapter for exact assignments to the power units.



When using the HCS03 converters in regenerative operation there is a choice of particularly compact brake resistors for various different levels of power consumption.

The brake resistor is mounted directly above the converter. This space-saving arrangement also simplifies the installation work. At the same time the converter's extracted air flow makes an effective cooling system.

The robust construction and high dielectric strength of the resistor elements enables high power and impulse loading. The resistor elements are flame-proof and are protected from harmful environmental factors by their full encapsulation.

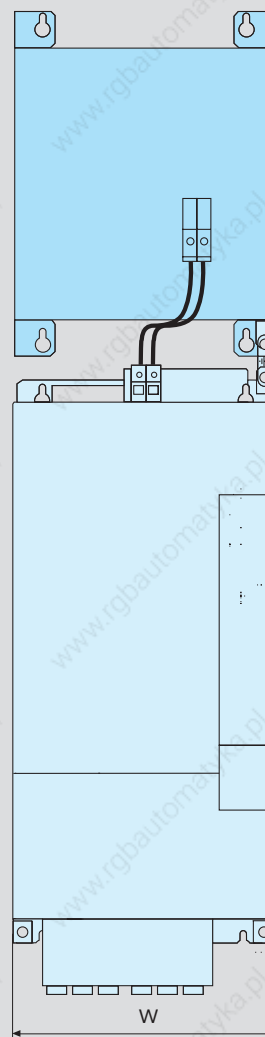
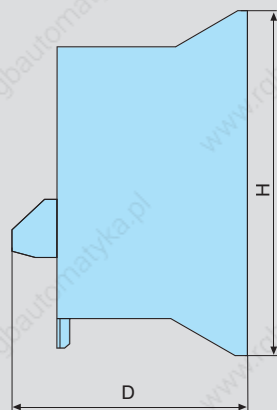

Example of assembly

Brake resistors, heavy-duty version – for HCS converters

| Brake resistor | Maximum energy consumption | Brake power | | | | Resistance | Type | Width W | Height H | Depth T | Mass |
|--------------------------------|----------------------------|-------------|------|----------------------|--------------------------|------------|------|----------|----------|----------|----------|
| | | Duration | max. | t _{on} time | t _{cycle} times | | | | | | |
| | kWs | kW | kW | s | s | Ω | mm | mm | mm | kg | |
| HLR01.1N-01K8-N40R0-A-007-NNNN | 72 | 1.8 | 18 | 4 | 120 | 40.0 | – | in prep. | in prep. | in prep. | in prep. |
| HLR01.1N-03K8-N40R3-A-007-NNNN | 300 | 3.8 | 18 | 16.7 | 120 | 40.3 | – | in prep. | in prep. | in prep. | in prep. |
| HLR01.1N-02K4-N28R0-A-007-NNNN | 100 | 2.4 | 26 | 3.9 | 120 | 28.0 | – | in prep. | in prep. | in prep. | in prep. |
| HLR01.1N-05K5-N28R2-A-007-NNNN | 420 | 5.5 | 26 | 16.2 | 120 | 28.2 | – | in prep. | in prep. | in prep. | in prep. |
| HLR01.1N-01K6-N18R0-A-007-NNNN | 109 | 1.6 | 34 | 3.3 | 120 | 20.0 | A | 185 | 586 | 120 | 5.2 |
| HLR01.1N-03K5-N19R0-A-007-NNNN | 252 | 3.5 | 31 | 8 | 120 | 21.3 | B | 300 | 270 | 490 | 9.5 |
| HLR01.1N-04K5-N18R0-A-007-NNNN | 432 | 4.5 | 33 | 13 | 120 | 20.2 | B | 400 | 270 | 490 | 13 |
| HLR01.1N-06K5-N18R0-A-007-NNNN | 686 | 6.5 | 33 | 21 | 120 | 20.2 | B | 400 | 270 | 490 | 13 |
| HLR01.1N-10K0-N18R0-A-007-NNNN | 1,080 | 10 | 33 | 32 | 120 | 20.2 | B | 600 | 270 | 490 | 22 |
| HLR01.1N-02K0-N15R0-A-007-NNNN | 137 | 2 | 40 | 3.4 | 120 | 16.7 | A | 185 | 686 | 120 | 6.2 |
| HLR01.1N-05K0-N15R0-A-007-NNNN | 360 | 5 | 40 | 9 | 120 | 16.9 | B | 400 | 270 | 490 | 13 |
| HLR01.1N-07K0-N14R0-A-007-NNNN | 672 | 7 | 43 | 16 | 120 | 15.7 | B | 600 | 270 | 490 | 22 |
| HLR01.1N-09K5-N13R0-A-007-NNNN | 1,003 | 9.5 | 46 | 22 | 120 | 14.6 | B | 600 | 270 | 490 | 22 |
| HLR01.1N-14K5-N13R0-A-007-NNNN | 1,566 | 14.5 | 46 | 34 | 120 | 14.6 | B | 800 | 270 | 490 | 33 |
| HLR01.1N-04K5-N07R4-A-007-NNNN | 246 | 4.5 | 81 | 3 | 120 | 8.3 | B | 300 | 270 | 490 | 9.5 |
| HLR01.1N-08K5-N08R0-A-007-NNNN | 612 | 8.5 | 75 | 8.2 | 120 | 9.0 | B | 600 | 270 | 490 | 22 |
| HLR01.1N-11K0-N07R3-A-007-NNNN | 1,056 | 11 | 82 | 13 | 120 | 8.2 | B | 600 | 270 | 490 | 22 |
| HLR01.1N-15K0-N08R1-A-007-NNNN | 1,584 | 15 | 74 | 21 | 120 | 9.1 | B | 800 | 270 | 490 | 33 |
| HLR01.1N-24K0-N07R2-A-007-NNNN | 2,592 | 24 | 83 | 31 | 120 | 8.1 | C | 795 | 710 | 490 | 80 |
| HLR01.1N-06K5-N06R1-A-007-NNNN | 356 | 6.5 | 98 | 3.6 | 120 | 6.9 | B | 400 | 270 | 490 | 13 |
| HLR01.1N-12K5-N05R5-A-007-NNNN | 900 | 12.5 | 109 | 8.3 | 120 | 6.2 | B | 800 | 270 | 490 | 33 |
| HLR01.1N-17K0-N05R1-A-007-NNNN | 1,632 | 17 | 117 | 14 | 120 | 5.7 | B | 1,000 | 270 | 490 | 43 |
| HLR01.1N-23K0-N05R5-A-007-NNNN | 2,429 | 23 | 109 | 22 | 120 | 6.2 | C | 595 | 710 | 490 | 56 |
| HLR01.1N-36K0-N05R4-A-007-NNNN | 3,888 | 36 | 111 | 35 | 120 | 6.1 | C | 995 | 710 | 490 | 93 |

Please see the selection tables on the end of this chapter for exact assignments to the power units.

The heavy-duty version of the brake resistor must always be used in applications where high regeneration occurs over a relatively long period of time. This is the case, for example, when lowering large loads or when braking high mass moments of inertia.

Depending on the braking power required there is a choice of compact brake resistors of different power levels and designs for each converter.

Type A

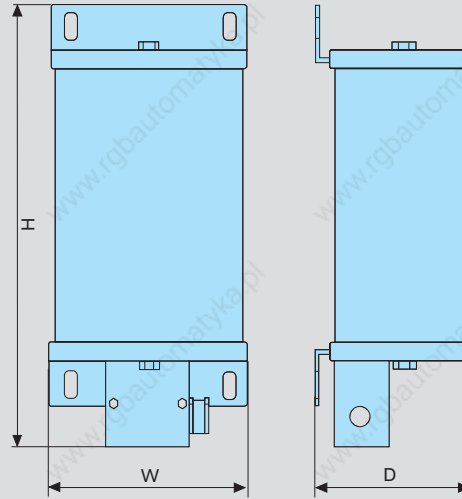

Type B

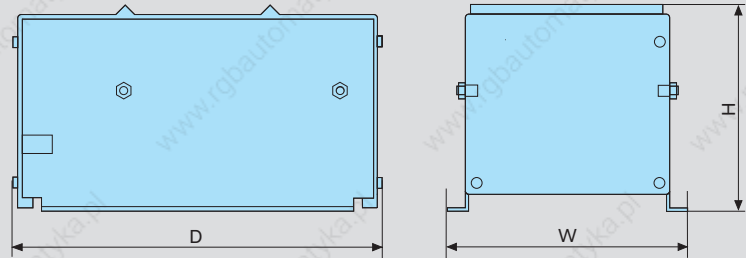

Type C

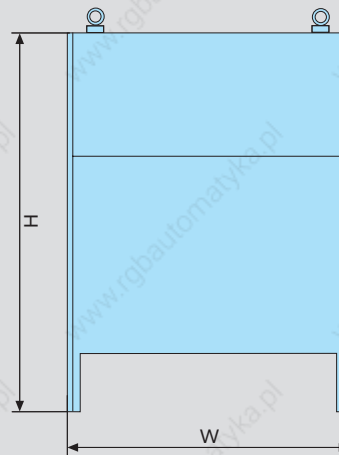

Brake units – for HMV power supply units and HCS converters

| Brake units | Maximum energy consumption | Brake power | | | | Width W mm | Height H mm | Depth D mm | Mass kg |
|--------------------------------|-------------------------------|-------------|------|---------------|-------------------|---------------|----------------|---------------|------------|
| | | Duration | max. | t_{on} time | t_{cycle} times | | | | |
| | kWs | kW | kW | s | s | | | | |
| HLB01.1C-01K0-N06R0-A-007-NNNN | 100 | 1 | 100 | 5 | 100 | 65 | 352 | 251.5 | 5.8 |
| HLB01.1D-02K0-N03R4-A-007-NNNN | 500 | 2 | 100 | 1 | 250 | 100 | 440 | 309 | 12.2 |

Please see the selection tables on the end of this chapter for exact assignments to the power units.



The connection of brake units increases the continuous and peak regenerative power.

The brake unit also makes it possible to have the DC bus short circuit function available in the drive system.

This function makes it possible to brake the synchronous motors even in the event of a power failure.

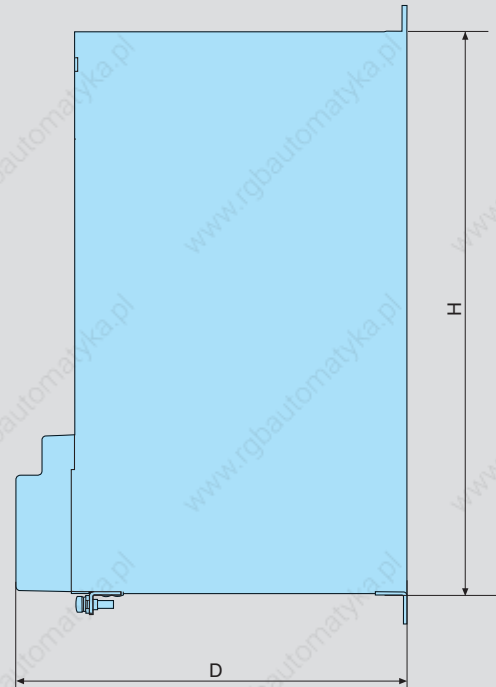
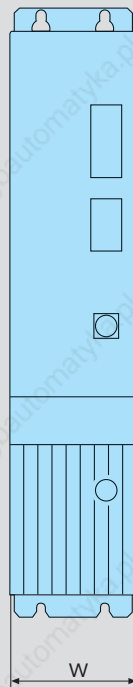

Capacity modules – for HMV power supply units and HCS converters

| Capacity modules | Capacitance | Width W | Height H | Depth D | Mass |
|--------------------------|-------------|---------|----------|---------|------|
| | mF | mm | mm | mm | kg |
| HLC01.1C-01M0-A-007-NNNN | 1 | 50 | 352 | 251.5 | 3.2 |
| HLC01.1C-02M4-A-007-NNNN | 2.4 | 50 | 352 | 251.5 | 4.3 |
| HLC01.1D-05M0-A-007-NNNN | 5 | 75 | 440 | 309 | 8.6 |

Please see the selection tables on the end of this chapter for exact assignments to the power units.



Capacity modules improve the energy balance in applications where machining cycles take place in rapid succession, such as roll feeds or cross cutting lines.

Connected to the DC bus, the capacity modules act as a temporary energy storage unit and reduce the heat loss in the control cabinet by relieving the braking resistor.

In the event of a power failure the reserve energy enables a controlled retraction motion. This protects the workpiece and the tool, e.g. in gear cutting machines.

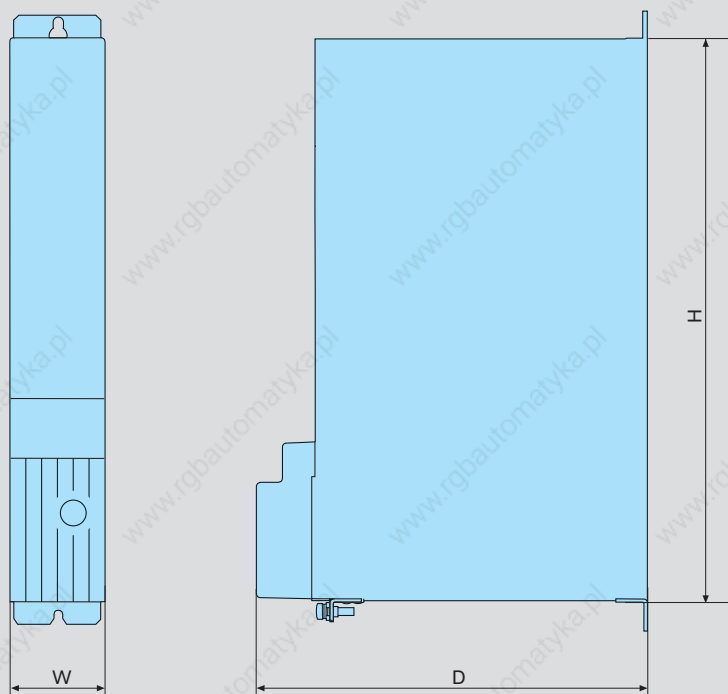

Additional fan – for HVM supply units and HMS inverters

| Blower unit | Width W | Height H | Depth D | Mass |
|----------------------|---------|----------|---------|------|
| | mm | mm | mm | kg |
| HAB01.1-0350-1640-NN | 350 | 308 | 152 | 7.5 |



The additional fan HAB01 is required for operating the supply unit HVM01.1R-W0120 and the inverter HMS01.1N-W0350. In a space-saving arrangement, it is mounted directly below the unit. The electrical connection is made by a simple plug-in connector.

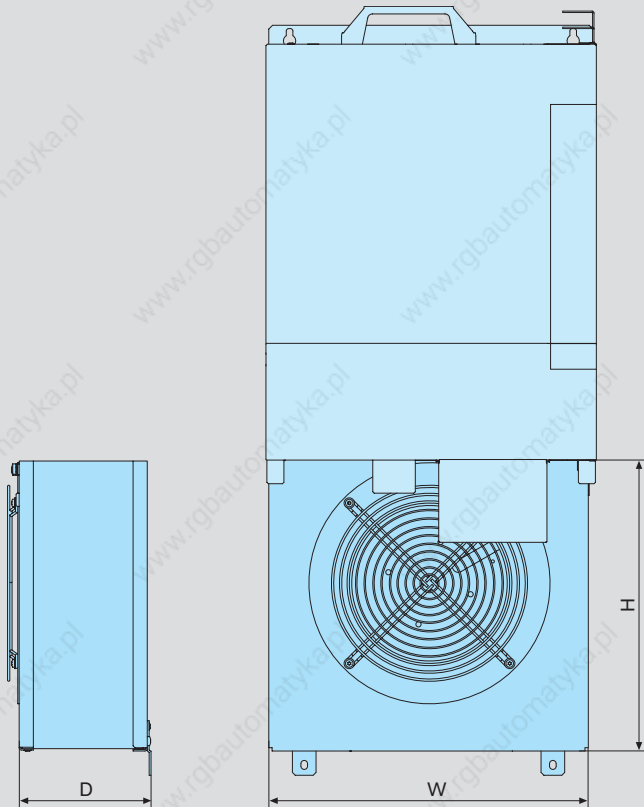

Other accessories



Basic accessories HAS01

The basic accessories contain all the mounting parts and fixing elements. Depending on the application, we supply these accessories complete with all the connecting bars for control voltage and DC bus.



Shield connection HAS02

The shield connection plate is an EMC-compatible method of connecting the motor cable to your control unit. It also serves as a cord grip.

Control cabinet adapter HAS03

The control cabinet adapters are used to combine HCS02 converters and their auxiliary components options, HLB brake unit and HLC expansion capacitor, with units from the IndraDrive M series. Spacer bolts can be used to even out the lower unit depth thus creating an even frontage with a uniform installation height.

Auxiliary capacitor HAS04

Use the additional capacitor HAS04 to operate HCS02 and HCS03 inverters with an HNF mains filter even if the minimum number of attached control units is not reached.

Electrical adapters HAS05

- HAS05.1-001 Use the HAS05.1-001-NNN-NN adapter to connect a HNK mains filter or a HMF motor filter to an HCS03.1E-W0070 converter.
- HAS05.1-002 If you install both – mains filter and motor filter please use the HAS05.1-002-NNN-NN adapter.
- HAS05.1-003 You can use the HAS05.1-003 signal level converter to adjust the voltage level of the encoder emulation signals to your application. Signal levels can be adjusted between 5 and 30 volts. The signal level converter is simply connected to the D-Sub connector of the control unit.
- HAS05.1-004 You can use the HAS05.1-004 DC bus adapter to supply power to inverter units without using the standard connecting bars. Cables with a cross-section of up to 2 x 50 mm² per phase can be used.
- HAS05.1-005 The HAS05.1-005 signal level converter enables you to add RS485 connectivity to your IndraDrive. Pre-assembled cables are available to connect the level converter to the RS232 port of the control unit. The converters can either be clipped on to a DIN rail or attached directly to the mounting plate.

Module bus extension RKB0001

All the control units are fitted with a bus cable – matched to the respective unit width – to transmit the control signals.

Where there are relatively large distances between individual control units we can supply the necessary module bus extensions. These come in various lengths ranging from 0.5 m and 40 m.

Auxiliary components – cross reference

| Components | HMV01.1E- W0030 | HMV01.1E- W0075 | HMV01.1E- W0120 | HMV01.1R- W0018 | HMV01.1R- W0045 | HMV01.1R- W0065 | HMV01.1R- W0120 | HMV02.1R- W0015 | HCS02.1E- W0012 | HCS02.1E- W0028 | HCS02.1E- W0064 | HCS03.1E- W0070 | HCS03.1E- W0070 | HCS03.1E- W0100 | HCS03.1E- W0150 | HCS03.1E- W0210 |
|------------|--------------------|--------------------|--------------------|--------------------|--------------------|--------------------|--------------------|--------------------|--------------------|--------------------|--------------------|--------------------|--------------------|--------------------|--------------------|--------------------|
|------------|--------------------|--------------------|--------------------|--------------------|--------------------|--------------------|--------------------|--------------------|--------------------|--------------------|--------------------|--------------------|--------------------|--------------------|--------------------|--------------------|

Mains filter HNF

| | | | | | | | | | | | | | | | | |
|--------------------------------|---------|---------|---------|---------|---------|---------|-------|--|----------------------|----------------------|------------------------|----------------------|----------------------|--|----------------------|----------------------|
| HNF01.1A-F240-E0051-A-480-NNNN | 12/280 | | | | | | | | | | | | 6/240 ²⁾ | | | |
| HNF01.1A-M900-E0051-A-480-NNNN | 21/1050 | | | | | | | | 12/900 ¹⁾ | | 12/900 ¹⁾²⁾ | 12/900 ²⁾ | 12/900 ²⁾ | | | |
| HNF01.1A-F240-E0125-A-480-NNNN | | 12/280 | | | | | | | | | | | | | 6/240 ²⁾ | |
| HNF01.1A-M900-E0125-A-480-NNNN | | 21/1050 | | | | | | | | | | | | | 12/900 ²⁾ | |
| HNF01.1A-F240-E0202-A-480-NNNN | | | 12/280 | | | | | | | | | | | | | 6/240 ²⁾ |
| HNF01.1A-M900-E0202-A-480-NNNN | | | 21/1050 | | | | | | | | | | | | | 12/900 ²⁾ |
| HNF01.1A-A075-E0235-A-500-NNNN | | | | | | | | | | | | | | | | |
| HNF01.1A-A075-E0309-A-500-NNNN | | | | | | | | | | | | | | | | |
| HNF01.1A-F240-R0026-A-480-NNNN | | | | 12/280 | | | | | | 6/240 ¹⁾ | | 6/240 ²⁾ | 6/240 ²⁾ | | | |
| HNF01.1A-M900-R0026-A-480-NNNN | | | | 21/1050 | | | | | | 12/900 ¹⁾ | | 12/900 ²⁾ | 12/900 ²⁾ | | | |
| HNF01.1A-F240-R0065-A-480-NNNN | | | | | 12/280 | | | | | | | | | | | |
| HNF01.1A-M900-R0065-A-480-NNNN | | | | | 21/1050 | | | | | | | | | | | |
| HNF01.1A-F240-R0094-A-480-NNNN | | | | | | 12/280 | | | | | | | | | 6/240 ²⁾ | |
| HNF01.1A-M900-R0094-A-480-NNNN | | | | | | 21/1050 | | | | | | | | | 12/900 ²⁾ | |
| HNF01.1A-H350-R0180-A-480-NNNN | | | | | | | 8/350 | | | | | | | | | |

Mains filter HNS

| | | | | | | | | | | | | | | | | |
|--------------------------------|--|--|--|--|--|--|--|----------------------|--|--|--|--|--|--|--|--|
| HNS02.1A-Q200-R0023-A-480-NNNN | | | | | | | | 12/200 ¹⁾ | | | | | | | | |
|--------------------------------|--|--|--|--|--|--|--|----------------------|--|--|--|--|--|--|--|--|

Mains filter NFD03

| | | | | | | | | | | | | | | | | |
|-----------------|--|--|--|--|--|--|--|--|---------------------|--|---------------------|---------------------|--|--|--|--|
| NFD03.1-480-007 | | | | | | | | | 6/120 ¹⁾ | | | | | | | |
| NFD03.1-480-016 | | | | | | | | | 6/120 ¹⁾ | | | | | | | |
| NFD03.1-480-030 | | | | | | | | | 6/120 ¹⁾ | | 6/120 ²⁾ | 6/120 ²⁾ | | | | |
| NFD03.1-480-055 | | | | | | | | | 6/120 ¹⁾ | | 6/120 ²⁾ | 6/120 ²⁾ | | | | |
| NFD03.1-480-075 | | | | | | | | | 6/120 ¹⁾ | | 6/120 ²⁾ | 6/120 ²⁾ | | | | |

Notes: 12/280 = mains filter for up to 12 drives and a maximum motor cable length of 280 m. These values must be reviewed for each application. Additional components may be necessary.

Regardless of the number of axes, the effective total mains current must not exceed the maximum current rating of the mains filter.

The maximum length might be different in case of open-loop mode or when using unshielded cables.

¹⁾recommended values for group supply without DC bus connection, the maximum cable length for single drives is 75 m.

²⁾recommended values for central supply: one inverter supplies power to other inverters, the maximum cable length for single drives is 75 m.

Mains filter with integrated HNK mains choke

| | | | | | | | | | | | | | | | | |
|--------------------------------|--|--|--|--|--|--|--|--|--|--|--|--|------|------|------|------|
| HNK01.1A-A075-E0050-A-500-NNNN | | | | | | | | | | | | | 1/75 | | | |
| HNK01.1A-A075-E0080-A-500-NNNN | | | | | | | | | | | | | | 1/75 | | |
| HNK01.1A-A075-E0106-A-500-NNNN | | | | | | | | | | | | | | | 1/75 | |
| HNK01.1A-A075-E0146-A-500-NNNN | | | | | | | | | | | | | | | | 1/75 |

Notes: 1/75 = mains filter for one drive, maximum motor cable length 75 m. These values must be reviewed for each application. Additional components may be necessary.

The effective mains current must not exceed the maximum current rating of the mains filter.

The maximum length might be different in case of open-loop mode or when using unshielded cables.

| Components | HMV01.1E- W0030 | HMV01.1E- W0075 | HMV01.1E- W0120 | HMV01.1R- W0018 | HMV01.1R- W0045 | HMV01.1R- W0065 | HMV01.1R- W0120 | HMV02.1R- W0015 | HCS02.1E- W0012 | HCS02.1E- W0028 | HCS02.1E- W0054 | HCS03.1E- W0070 | HCS03.1E- W0100 | HCS03.1E- W0150 | HCS03.1E- W0210 |
|------------|--------------------|--------------------|--------------------|--------------------|--------------------|--------------------|--------------------|--------------------|--------------------|--------------------|--------------------|--------------------|--------------------|--------------------|--------------------|
|------------|--------------------|--------------------|--------------------|--------------------|--------------------|--------------------|--------------------|--------------------|--------------------|--------------------|--------------------|--------------------|--------------------|--------------------|--------------------|

| Mains choke HNL | | | | | | | | | | | | | | | |
|--------------------------------|---|---|---|---|---|---|---|---|---|---|---|---|---|---|---|
| HNL01.1E-0400-N0051-A-480-NNNN | • | | | | | | | | | | | | | | |
| HNL01.1E-0200-N0125-A-480-NNNN | | • | | | | | | | | | | | | | |
| HNL01.1E-0100-N0202-A-480-NNNN | | | • | | | | | | | | | | | | |
| HNL01.1R-0980-C0026-A-480-NNNN | | | | • | | | | | | | | | | | |
| HNL01.1R-0590-C0065-A-480-NNNN | | | | | • | | | | | | | | | | |
| HNL01.1R-0540-C0094-A-480-NNNN | | | | | | • | | | | | | | | | |
| HNL01.1R-0300-C0180-A-480-NNNN | | | | | | | • | | | | | | | | |
| HNL01.1E-1000-N0012-A-500-NNNN | | | | | | | | | • | • | | | | | |
| HNL01.1E-1000-N0020-A-500-NNNN | | | | | | | | | | | • | | | | |
| HNL01.1E-0600-N0032-A-500-NNNN | | | | | | | | | | | | • | | | |
| HNL01.1E-0571-N0050-A-500-NNNN | | | | | | | | | | | | | • | | |
| HNL01.1E-0362-N0080-A-500-NNNN | | | | | | | | | | | | | | • | |
| HNL01.1E-0240-N0106-A-500-NNNN | | | | | | | | | | | | | | | • |
| HNL01.1E-0170-N0146-A-500-NNNN | | | | | | | | | | | | | | | • |
| HNL02.1R-0980-C0023-A-480-NNNN | | | | | | | | • | | | | | | | |

The effective total mains current of your application must not exceed the maximum rated current of the mains choke.

| Motor filter HMF | | | | | | | | | | | | | | | |
|--------------------------------|--|--|--|--|--|--|--|--|---|---|---|---|---|---|---|
| HMF01.1N-NOK2-M0012-A-500-NNNN | | | | | | | | | • | • | | | | | |
| HMF01.1N-NOK2-M0028-A-500-NNNN | | | | | | | | | | | • | • | | | |
| HMF01.1A-NOK2-D0045-A-500-NNNN | | | | | | | | | | | | • | | | |
| HMF01.1A-NOK2-D0073-A-500-NNNN | | | | | | | | | | | | | • | | |
| HMF01.1A-NOK2-D0095-A-500-NNNN | | | | | | | | | | | | | | • | |
| HMF01.1A-NOK2-D0145-A-500-NNNN | | | | | | | | | | | | | | | • |

Auxiliary components – cross reference

| Components | HCS02.1E-W0054 | HCS02.1E-W0070 | HCS03.1E-W0070 | HCS03.1E-W0100 | HCS03.1E-W0150 | HCS03.1E-W0210 |
|--------------------------------|----------------|----------------|----------------|----------------|----------------|----------------|
| Brake resistor HLR | | | | | | |
| HLR01.1N-01K8-N40R0-A-007-NNNN | ○ | | | | | |
| HLR01.1N-03K8-N40R3-A-007-NNNN | ○ | | | | | |
| HLR01.1N-02K4-N28R0-A-007-NNNN | | ○ | | | | |
| HLR01.1N-05K4-N28R2-A-007-NNNN | | ○ | | | | |
| HLR01.1N-0300-N17R5-A-007-NNNN | | | ● | | | |
| HLR01.1N-01K6-N18R0-A-007-NNNN | | | ○ | | | |
| HLR01.1N-03K5-N19R0-A-007-NNNN | | | ○ | | | |
| HLR01.1N-04K5-N18R0-A-007-NNNN | | | ○ | | | |
| HLR01.1N-06K5-N18R0-A-007-NNNN | | | ○ | | | |
| HLR01.1N-10K0-N18R0-A-007-NNNN | | | ○ | | | |
| HLR01.1N-0470-N11R7-A-007-NNNN | | | | ● | | |
| HLR01.1N-02K0-N15R0-A-007-NNNN | | | | ○ | | |
| HLR01.1N-05K0-N15R0-A-007-NNNN | | | | ○ | | |
| HLR01.1N-07K0-N14R0-A-007-NNNN | | | | ○ | | |
| HLR01.1N-09K5-N13R0-A-007-NNNN | | | | ○ | | |
| HLR01.1N-14K5-N13R0-A-007-NNNN | | | | ○ | | |
| HLR01.1N-0780-N07R0-A-007-NNNN | | | | | ● | |
| HLR01.1N-04K5-N07R4-A-007-NNNN | | | | | ○ | |
| HLR01.1N-08K5-N08R0-A-007-NNNN | | | | | ○ | |
| HLR01.1N-11K0-N07R3-A-007-NNNN | | | | | ○ | |
| HLR01.1N-15K0-N08R1-A-007-NNNN | | | | | ○ | |
| HLR01.1N-24K0-N07R2-A-007-NNNN | | | | | ○ | |
| HLR01.1N-1K08-N05R0-A-007-NNNN | | | | | | ● |
| HLR01.1N-06K5-N06R1-A-007-NNNN | | | | | | ○ |
| HLR01.1N-12K5-N05R5-A-007-NNNN | | | | | | ○ |
| HLR01.1N-17K0-N05R1-A-007-NNNN | | | | | | ○ |
| HLR01.1N-23K0-N05R5-A-007-NNNN | | | | | | ○ |
| HLR01.1N-36K0-N05R4-A-007-NNNN | | | | | | ○ |

● Standard version ○ Heavy-duty version

Auxiliary components – cross reference

| Components | HMS01.1N-W0020 | HMS01.1N-W0036 | HMS01.1N-W0054 | HMS01.1N-W0070 | HMS01.1N-W0110 | HMS01.1N-W0150 | HMS01.1N-W0210 | HMS01.1N-W0350 | HMS02.1N-W0028 | HMS02.1N-W0054 | HMD01.1N-W0012 | HMD01.1N-W0020 | HMD01.1N-W0036 | HCS02.1E-W0012 | HCS02.1E-W0028 | HCS02.1E-W0054 | HCS02.1E-W0070 | HCS03.1E-W0070 | HCS03.1E-W0100 | HCS03.1E-W0150 | HCS03.1E-W0210 | HNK01.1A-...-E0050 | HNK01.1A-...-E0080 | HNK01.1A-...-E0106 | HNK01.1A-...-E0146 | KCU01.2N |
|------------|----------------|----------------|----------------|----------------|----------------|----------------|----------------|----------------|----------------|----------------|----------------|----------------|----------------|----------------|----------------|----------------|----------------|----------------|----------------|----------------|----------------|--------------------|--------------------|--------------------|--------------------|----------|
|------------|----------------|----------------|----------------|----------------|----------------|----------------|----------------|----------------|----------------|----------------|----------------|----------------|----------------|----------------|----------------|----------------|----------------|----------------|----------------|----------------|----------------|--------------------|--------------------|--------------------|--------------------|----------|

| Shield connection HAS02 | | | | | | | | | | | | | | | | | | | | | | | | | | | |
|-------------------------|---|---|---|---|---|---|---|---|---|---|---|---|---|---|---|---|---|---|---|--|---|---|---|--|--|---|---|
| HAS02.1-001-NNN-NN | • | • | • | • | | | | | | | | | | | | | | | | | | | | | | | |
| HAS02.1-002-NNN-NN | | | | | | | | | • | • | • | • | • | • | • | • | | | | | | | | | | | |
| HAS02.1-003-NNN-NN | | | | | • | • | • | | | | | | | | | | | | | | | | | | | | |
| HAS02.1-004-NNN-NN | | | | | | | | | | | | | | | | | • | | | | | | | | | | |
| HAS02.1-005-NNN-NN | | | | | | | | | | | | | | | | | | • | • | | | | | | | | |
| HAS02.1-006-NNN-NN | | | | | | | | | | | | | | | | | | | | | • | | | | | | |
| HAS02.1-007-NNN-NN | | | | | | | | | | | | | | | | | | | | | | • | • | | | | |
| HAS02.1-008-NNN-NN | | | | | | | | | | | | | | | | | | | | | • | | | | | | |
| HAS02.1-009-NNN-NN | | | | | | | | | | | | | | | | | | | | | | | | | | • | |
| HAS02.1-010-NNN-NN | | | | | | | | | | • | | | | | | | | | | | | | | | | | |
| HAS02.1-011-NNN-NN | | | | | | | | | | • | | | | | | | | | | | | | | | | | |
| HAS02.1-014-NNN-NN | | | | | | | | • | | | | | | | | | | | | | | | | | | | |
| HAS02.1-015-NNN-NN | | | | | | | | | | | | | | | | | | | | | | | | | | | • |

| Components | HCS02.1E-W0012 | HCS02.1E-W0028 | HCS02.1E-W0054 | HCS02.1E-W0070 | HLB01.1C | HLC01.1C |
|------------|----------------|----------------|----------------|----------------|----------|----------|
|------------|----------------|----------------|----------------|----------------|----------|----------|

| Control cabinet adapter HAS03 | | | | | | |
|-------------------------------|--|---|--|---|--|---|
| HAS03.1-002-NNN-NN | | • | | | | • |
| HAS03.1-004-NNN-NN | | | | • | | • |

| Components | HCS02.1E-W0012 | HCS02.1E-W0028 | HCS02.1E-W0054 | HCS02.1E-W0070 | HCS03.1E-W0070 | HCS03.1E-W0100 | HCS03.1E-W0150 | HCS03.1E-W0210 |
|------------|----------------|----------------|----------------|----------------|----------------|----------------|----------------|----------------|
|------------|----------------|----------------|----------------|----------------|----------------|----------------|----------------|----------------|

| Auxiliary capacitor HAS04 | | | | | | | | |
|---------------------------|--|---|---|---|---|---|---|---|
| HAS04.1-001-NNN-NN | | • | • | • | | | | |
| HAS04.1-002-NNN-NN | | | | | • | • | • | • |

Only required in combination with mains filter HNF or if power is supplied to other HMS01 inverters.

| Components | HMV01.1E-W0030 | HMV01.1E-W0075 | HMV01.1E-W0120 | HMV01.1R-W0018 | HMV01.1R-W0045 | HMV01.1R-W0065 | HMV01.1R-W0120 | HMV02.1R-W0015 | HMS01.1N-W0020 | HMS01.1N-W0036 | HMS01.1N-W0054 | HMS01.1N-W0070 | HMS01.1N-W0110 | HMS01.1N-W0150 | HMS01.1N-W0210 | HMS01.1N-W0350 | HMS02.1N-W0028 | HMS02.1N-W0054 | HMD01.1N-W0012 | HMD01.1N-W0020 | HMD01.1N-W0036 |
|------------|----------------|----------------|----------------|----------------|----------------|----------------|----------------|----------------|----------------|----------------|----------------|----------------|----------------|----------------|----------------|----------------|----------------|----------------|----------------|----------------|----------------|
|------------|----------------|----------------|----------------|----------------|----------------|----------------|----------------|----------------|----------------|----------------|----------------|----------------|----------------|----------------|----------------|----------------|----------------|----------------|----------------|----------------|----------------|

| Adapter HAS05 – DC bus connection | | | | | | | | | | | | | | | | | | | | | |
|-----------------------------------|---|---|---|---|---|---|---|---|---|---|---|---|---|---|---|---|---|---|---|---|---|
| HAS05.1-004-NNL-NN | • | • | • | • | • | • | • | • | • | • | • | • | • | • | • | • | • | • | • | • | • |
| HAS05.1-004-NNR-NN | • | • | • | • | • | • | • | • | • | • | • | • | • | • | • | • | • | • | • | • | • |

| Components | BASIC OPEN LOOP CSB01.1N-FC | BASIC ANALOG CSB01.1N-AN | BASIC PROFIBUS CSB01.1N-PB | BASIC SERCOS CSB01.1N-SE | BASIC UNIVERSAL Single-axis CSB01.1C | BASIC UNIVERSAL Dual-axis CDB01.1C | ADVANCED CSH01.1C |
|------------|-----------------------------------|--------------------------------|----------------------------------|--------------------------------|---|---|----------------------|
|------------|-----------------------------------|--------------------------------|----------------------------------|--------------------------------|---|---|----------------------|

| Adapter HAS05 – signal level converter | | | | | | | |
|--|--|---|--|--|-----------------|-----------------|-----------------|
| HAS05.1-003-NNN-NN | | • | | | • ¹⁾ | • ¹⁾ | • ¹⁾ |

¹⁾ for control units with MEM encoder emulation only

| Adapter HAS05 – RS232/485 converter | | | | | | | |
|-------------------------------------|---|---|---|---|---|---|---|
| HAS05.1-005-NNN-NN | • | • | • | • | • | • | • |

| Adapter HAS05 – from the D-Sub 9-pole connector (X41) to the terminal | | | | | | | |
|---|--|-----------------|-----------------|-----------------|-----------------|-----------------|-----------------|
| HAS05.1-007-NNN-NN | | • ¹⁾ | • ¹⁾ | • ¹⁾ | • ¹⁾ | • ¹⁾ | • ¹⁾ |

¹⁾ for control units with Safety Technology option (L1, S1)

| Components | HCS03.1E-W0070 with HMF motor filter | HCS03.1E-W0070 with HNK mains filter | HCS03.1E-W0070 with HMF motor filter and HNK mains filter |
|------------|---|---|--|
|------------|---|---|--|

| Adapter HAS05 – connection accessories | | | |
|--|---|---|---|
| HAS05.1-001-NNN-NN | • | • | • |
| HAS05.1-002-NNN-NN | | | • |

Auxiliary components – connection cables

| Motor | Power unit | Power cable | Encoder cable |
|---|--|-------------|---------------|
| MSK030B-0900 MSK030C-0900 MSK040B-0450, -0600 MSK040C-0450, -0600 MSK050B-0300, -0450, -0600 MSK050C-0300, -0450, -0600 MSK060B-0300, -0600 MSK060C-0300, -0600 MSK061C-0200, -0300, -0600 MSK076C-0300, -0450 | HMD01.1N-W0012 HMx01.1N-W0020 HMx01.1N-W0036 HCS02.1E-W0012 HCS02.1E-W0028 | RKL4302 | |
| MSK070C-0150, -0300, -0450 MSK070D-0150 MSK070E-0150 MSK071C-0200, -0300, -0450 MSK071D-0200, -0300, -0450 MSK071E-0200, -0300 MSK075C-0200, -0300, -0450 MSK075D-0200, -0300 MSK075E-0200, -0300 | HMD01.1N-W0012 HMx01.1N-W0020 HMx01.1N-W0036 HCS02.1E-W0012 HCS02.1E-W0028 | RKL4306 | |
| | HMS01.1N-W0054 HMS01.1N-W0070 HCS02.1E-W0054 HCS02.1E-W0070 HCS03.1E-W0070 | RKL4307 | |
| | HMx01.1N-W0020 HMx01.1N-W0036 HCS02.1E-W0012 HCS02.1E-W0028 | RKL4308 | |
| MSK070D-0300, -0450 MSK070E-0300 MSK071E-0450 MSK075D-0450 MSK075E-0450 | HMS01.1N-W0054 HMS01.1N-W0070 HCS02.1E-W0054 HCS02.1E-W0070 HCS03.1E-W0070 | RKL4309 | RKG4200 |
| | HMS01.1N-W0110 HMS01.1N-W0150 HMS01.1N-W0210 HCS03.1E-W0100 HCS03.1E-W0150 | RKL4310 | |
| MSK070E-0450 | HMS01.1N-W0054 HMS01.1N-W0070 HCS02.1E-W0054 HCS02.1E-W0070 HCS03.1E-W0070 | RKL4314 | |
| | HMS01.1N-W0110 HMS01.1N-W0150 HMS01.1N-W0210 HCS03.1E-W0100 HCS03.1E-W0150 | RKL4315 | |
| MSK100A-0200, -0300, -0400 MSK100B-0200 MSK100D-0200 MSK101C-0200 | HMx01.1N-W0020 HMx01.1N-W0036 HCS02.1E-W0012 HCS02.1E-W0028 | RKL4325 | |
| | HMS01.1N-W0054 HMS01.1N-W0070 HCS02.1E-W0054 HCS02.1E-W0070 HCS03.1E-W0070 | RKL4320 | |

| Motor | Power unit | Power cable | Encoder cable |
|---|--|-------------|---------------|
| MSK100B-0300 MSK100C-0200, -0300 MSK100D-0300 | HMx01.1N-W0020 HMx01.1N-W0036 HCS02.1E-W0012 HCS02.1E-W0028 | RKL4326 | RKG4200 |
| | HMS01.1N-W0054 HMS01.1N-W0070 HCS02.1E-W0054 HCS02.1E-W0070 HCS03.1E-W0070 | RKL4321 | |
| | HMS01.1N-W0110 HMS01.1N-W0150 HMS01.1N-W0210 HCS03.1E-W0100 HCS03.1E-W0150 | RKL4343 | |
| MSK100B-0400 MSK100B-0450 MSK101C-0300, -0450 | HMx01.1N-W0020 HMx01.1N-W0036 HCS02.1E-W0012 HCS02.1E-W0028 | RKL4327 | |
| | HMS01.1N-W0054 HMS01.1N-W0070 HCS02.1E-W0054 HCS02.1E-W0070 HCS03.1E-W0070 | RKL4322 | |
| | HMS01.1N-W0054 HMS01.1N-W0070 HCS02.1E-W0054 HCS02.1E-W0070 HCS03.1E-W0070 | RKL4323 | |
| MSK100C-0450 MSK101D-0200, -0300 MSK101E-0200 MSK131B-0200 MSK131D-0100 | HMS01.1N-W0110 HMS01.1N-W0150 HMS01.1N-W0210 HCS03.1E-W0100 HCS03.1E-W0150 | RKL4328 | |
| | HMS01.1N-W0054 HMS01.1N-W0070 HCS02.1E-W0054 HCS02.1E-W0070 HCS03.1E-W0070 | RKL4324 | |
| | HMS01.1N-W0110 HMS01.1N-W0150 HMS01.1N-W0210 HCS03.1E-W0100 HCS03.1E-W0150 | RKL4329 | |
| MSK101D-0450 MSK101E-0300 | HMS01.1N-W0054 HMS01.1N-W0070 HCS02.1E-W0054 HCS02.1E-W0070 HCS03.1E-W0070 | RKL4344 | |
| | HMS01.1N-W0110 HMS01.1N-W0150 HMS01.1N-W0210 HCS03.1E-W0100 HCS03.1E-W0150 | RKL4330 | |
| | HCS03.1E-W0210 | RKL4333 | |
| MSK131D-0200 | HCS03.1E-W0210 | RKL4349 | |

These tables are an extract from our extensive range of cables. Cables for other motors can be found in our documentation entitled "Connection cables – selection data". All specifications given relate to motors with natural convection.

Glossary

| | |
|---|---|
| ADVANCED | Control units for maximum performance and dynamics with many configuration options |
| BASIC | Control units for standard applications |
| Basic accessories | All the mounting parts and hardware, and the connecting bars for the control voltage and DC bus |
| Brake chopper Brake transistor | Transistor which switches a brake resistor on and off |
| Brake resistor | For input power in regenerative operation (converted into heat) |
| Brake unit | All-in-one unit comprising brake resistor and braking transistor (brake chopper) used to increase the braking power |
| Braking power | Power which is recovered in regenerative operation of the motors |
| Capacity module | Optional auxiliary component used to increase the storable DC bus energy |
| CLOSED LOOP | Closed control loop (automatically regulated operation) in which the device being regulated is monitored using a measuring system and made available to the drive |
| Control cabinet adapter | Spacer bolts used to even out different unit depths |
| Control unit | The part of the drive unit comprising all the control functions and interfaces for installation in the power unit |
| Converter | Takes the mains voltage with its fixed amplitude and frequency and generates a three-phase alternating current with variable amplitude and frequency |
| DC bus voltage | DC voltage generated from the AC network and used to supply the power units; also serves as buffer storage for energy |
| Derating | Lowering of the specified data in the event of a change in operating conditions |

| | |
|--------------------------|--|
| EMC | Electromagnetic compatibility |
| Encoder cable | Cable used to connect the motor encoder to the encoder interface of the control unit |
| Firmware | Device-specific software for the drive functions |
| Functions library | Collection of function blocks conforming to IEC or PLCopen |
| IndraDrive | Converter or inverter, consisting of a power unit and a control unit, used to control servo or standard motors |
| IndraDrive C | Compact drive series, converter |
| IndraDrive M | Modular drive series, inverter and power supply units |
| IndraDrive Mi | Motor-integrated drive series – Inverter, control unit and synchronous servo motor in one unit |
| IndraDyn A | Air-cooled or liquid-cooled asynchronous servo motors |
| IndraDyn H | High-speed frameless (kit) motors |
| IndraDyn L | Synchronous linear motors |
| IndraDyn S | Synchronous servo motors, also for potentially explosive areas |
| IndraDyn T | Synchronous frameless (kit) torque motors |
| IndraMotion MLD | Integrated automation solution comprising drive functions, motion control and processing logic |
| IndraSize | Software tool used for sizing and selecting drives based on the machine data |
| IndraWorks | Engineering software toolkit for project planning, parameterization, start-up, diagnostics, etc. |
| Inverter | Takes the DC bus voltage and generates a three-phase alternating current with variable amplitude and frequency |

| | |
|-----------------------------|---|
| Mains choke | Used to increase the continuous DC bus output and to suppress harmonics |
| Mains filter | EMC filters for power supply units and converters used to reduce circuit feedback |
| Module bus | Bus connection between power units for exchanging internal control signals |
| Module bus extension | Optional bus connection used to bridge larger than average distances between individual drive control units |
| Motion Logic | Integrated automation solution comprising drive functions, motion control and processing logic |
| Motor filter | Used to protect the motor winding from extreme voltage rises |
| OPEN LOOP | Open control loop (controlled operation) in which the device being controlled is not monitored using measuring techniques |
| Power cable | Cable for connecting the motor to the power unit |
| Power supply unit | Takes the mains voltage with fixed amplitude and frequency and generates a DC bus voltage |
| Power unit | The part of the drive control unit containing the power electronics to control the motors, used to hold the control unit |
| Regeneration | Recirculation of the energy into the supply network during regenerative operation of the drive |
| Safety on Board | Safety technology integrated in the drive, certified as complying with EN 954-1, Category 3 |
| Shield connection | Connection plate for EMC-compatible connection of the motor cable to the control unit |
| Software module | MultiMedia Card for simple transmission of axis-oriented drive parameters without the use of a PC |

| | |
|----------------------------|---|
| Switching frequency | Clock frequency of the pulse width modulation (PWM) |
| Technology package | Process-oriented function blocks, e.g. tension control |
| User library | Collection of function blocks developed by the user |
| User program | Application-specific combination of different function blocks / technology packages |

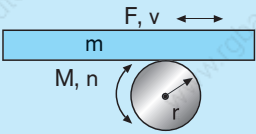
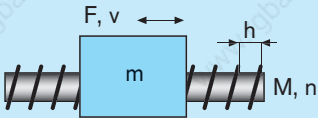
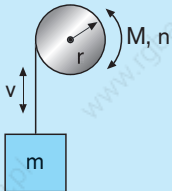
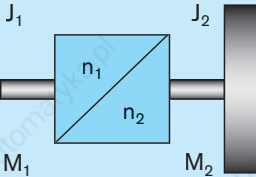

Formulas

| | Speed | Torque | Output | Mass moment of inertia |
|--|-------------------------------------|--|------------------------------------|---|
| Roller, wheel and pinion drive  | $n = \frac{v}{2 \cdot r \cdot \pi}$ | $M = F \cdot r$ | $P = \frac{F \cdot v}{60}$ | $J = m \cdot r^2$ |
| Ball screw drive  | $n = \frac{v \cdot 1000}{h}$ | $M = \frac{F \cdot h}{2 \cdot \pi \cdot 1000}$ | $P = \frac{F \cdot v}{60}$ | $J = m \cdot \left(\frac{h}{2 \cdot \pi \cdot 1000} \right)^2$ |
| Pulley drive  | $n = \frac{v}{2 \cdot \pi \cdot r}$ | $M = m \cdot g \cdot r$ | $P = \frac{m \cdot g \cdot v}{60}$ | $J = m \cdot r^2$ |
| | Speed | Torque | Transmission ratio | Mass moment of inertia |
| Gear conversion  | $n_1 = n_2 \cdot i$ | $M_1 = \frac{M_2}{i}$ | $i = \frac{n_1}{n_2}$ | $J_1 = \frac{J_2}{i^2}$ |

| Miscellaneous | | | |
|------------------------------|---|----------------------------|--|
| Rotational frequency | $\omega = \frac{2 \cdot \pi \cdot n}{60}$ | Effective electrical power | $P = U \cdot I \cdot \cos\varphi \cdot \sqrt{3}$ |
| Rotational kinetic energy | $W = \frac{J}{2} \cdot \omega^2$ | Apparent electrical power | $S = U \cdot I \cdot \sqrt{3}$ |
| Translational kinetic energy | $W = \frac{m}{2} \cdot \left(\frac{v}{60}\right)^2$ | Reactive electrical power | $Q = U \cdot I \cdot \sin\varphi \cdot \sqrt{3}$ |
| Synchronous rpm | $n = \frac{f \cdot 60}{p}$ | DC bus voltage | $U = U_{net} \cdot \sqrt{2}$ |
| Synchronous speed | $v = 2 \cdot f \cdot \tau_p$ | Force | $F = m \cdot a$ |

| Unit conversion | | | |
|-----------------|--------------|------------------|--------------|
| Physical value | Name of unit | Conversion | Name of unit |
| force | pound-force | 1 lbf = 4.4482 N | Newton |
| power | horsepower | 1 hp = 745.7 W | watt |
| length | inch | 1 in = 25.4 mm | millimeter |
| length | foot | 1 ft = 0.3048 m | meter |
| mass | pound | 1 lb = 0.4536 kg | kilogram |

| Legend | | |
|---|--|--|
| a – Acceleration [ms ⁻²] | J – Mass moment of inertia [kgm ²] | r – Radius [m] |
| F – Force [N] | M – Torque [Nm] | S – Apparent power [VA] |
| f – Frequency [s ⁻¹] | m – Mass [kg] | U – Voltage [V] |
| g – Gravitational acceleration [9.81 ms ⁻²] | n – Rotational speed [rpm] | v – Speed [m/min] |
| h – Spindle pitch [mm] | P – Power [W] | W – Energy [Ws] |
| I – Current [A] | p – Pole pair number | τ_p – Pole pitch |
| i – Transmission ratio | Q – Reactive power [var] | ω – Rotational frequency [s ⁻¹] |

Documentation and further information

We can supply further information about IndraDrive and IndraDyn as a hard copy, on CD-ROM, DVD or on the Internet.

Alternatively you can contact your local Rexroth distribution agency directly. The relevant address can be found on the back cover of this document.



IndraDrive Mi
Configuration
R911320925/DE
R911320924/EN



IndraMotion MLD
Application
instructions
R911306071/DE
R911306084/EN



IndraDrive
Control units
Project Planning
Manual
R911295011/DE
R911295012/EN



IndraMotion MLD
The first steps
Brief description
R911319304/DE
R911319306/EN

Documentation – hard copy



Drive system
IndraDrive Project
Planning Manual
R911309635/DE
R911309636/EN



Firmware
Theory of operation
R911315484/DE
R911315485/EN



IndraMotion MLD
Libraries
Library description
R911318317/DE
R911319224/EN



IndraDrive
Supply Units and
Power Sections
R911318789/DE
R911318790/EN



Firmware
Parameter
description
R911297316/DE
R911297317/EN



IndraLogic
Programming
instructions
R911305035/DE
R911305036/EN



IndraDrive
Additional
Components
R911306139/DE
R911306140/EN



Safety technology
Application
instructions
R911297837/DE
R911297838/EN



Troubleshooting
information
R911297318/DE
R911297319/EN



IndraDyn S
Project Planning
Manual
R911296288/DE
R911296289/EN



IndraDyn S
for hazardous areas
Project Planning
Manual
R911312708/DE
R911312709/EN



IndraDyn A
Project Planning
Manual
R911295054/DE
R911295781/EN



1MB frameless (kit)
spindle motors
Project Planning
Manual
R911263704/DE
R911264277/EN



IndraDyn L
Project Planning
Manual
R911293634/DE
R911293635/EN



GTE gearboxes
Project Planning
Manual
R911308841/DE
R911308842/EN



IndraDyn H
Project Planning
Manual
R911297894/DE
R911297895/EN



GTM gearboxes
Project Planning
Manual
R911297320/DE
R911297321/EN



IndraDyn T
Project Planning
Manual
R911291224/DE
R911298798/EN



Connection cables
Selection data
R911280894/DE
R911280897/EN

Documentation on CD/DVD

The complete documentation for
IndraDrive and IndraDyn on
CD-ROM or DVD.



R911306531/DE
and EN

Documentation online

All current documentation can also
be downloaded at
www.boschrexroth.com/mediadirectory

Download IndraSize

IndraSize – the drive sizing program can
be downloaded at
www.boschrexroth.com/indrasize

Rexroth online

Information about Bosch Rexroth AG and
our products and system solutions can be
found by visiting
www.boschrexroth.com

Bosch Rexroth AG
Electric Drives and Controls
P.O. Box 13 57
97803 Lohr, Germany
Bgm.-Dr.-Nebel-Str. 2
97816 Lohr, Germany
Phone +49 9352-40-0
Fax +49 9352-40-4885
www.boschrexroth.com

Presented by: _____



The data specified above only serve to describe the product. As our products are constantly being further developed, no statements concerning a certain condition or suitability for a certain application can be derived from our information. The information given does not release the user from the obligation of own judgment and verification. It must be remembered that our products are subject to a natural process of wear and aging.

71 511 AE/07-08 – A3 – SM
R911313044
© Bosch Rexroth AG 2007
Subject to revisions!
Printed in Germany