

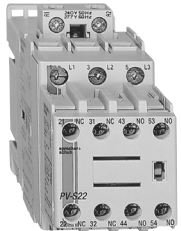

















Top (Front) Mount Auxiliary Contact Blocks ①

Contact Block	Description	NO	NC	Contact Arrangement	For use with...	Standard Contacts Catalog Number	Price	Bifurcated Contacts Catalog Number ②	Price
 <p>Top mount auxiliary contact blocks snap-on to the top (front) of any CA7 contactor</p>	<p>Auxiliary Contact Blocks for Top Mounting -</p> <ul style="list-style-type: none"> • 2 and 4 pole • Snap on design - mounts without tools • Electronic compatible contacts • Mutual positive guidance to the main contactor poles (excluding L types) • Several terminal numbering choices even for models with equal function • Late break /early make (L) available <p>Bifurcated Contacts</p> <p>Bifurcated auxiliary contacts provides a higher degree of reliability than the standard cross-stamped auxiliary contacts because it H-bridge divides each movable contact into two sections at the tip of the spanner. Typical application is low-voltage low-current applications (i.e.: PLC). Cross-stamped contacts are good for a minimum of 5mA at 17v while bifurcated contacts are good for a minimum of 3mA at 5v.</p>	0	2		CA7 all	CS7-PV-02	27	CS7-PVB-02	42
					CA7-30...97-✱-00	CA7-PV-02	27	CA7-PVB-02	42
		1	1		CA7 all	CS7-PV-11	27	CS7-PVB-11	42
					CA7-30...97-✱-00	CA7-PV-11	27	CA7-PVB-11	42
					CA7-9...23-✱-10 CA7-9...23-✱-01	CA7-PV-S11	27	CA7-PVB-S11	42
		2	0		CA7 all	CS7-PV-20	27	CS7-PVB-20	42
					CA7-30...97-✱-00	CA7-PV-20	27	CA7-PVB-20	42
		1EM	1LB		CA7-30...97-✱-00	CA7-PV-L11	37	NOT AVAILABLE	~
		1	3		CA7-30...97-✱-00	NOT AVAILABLE	~	CA7-PVB-13	79
		2	2		CA7 all	CS7-PV-22	53	CS7-PVB-22	79
	CA7-30...97-✱-00			CA7-PV-22	53	CA7-PVB-22	79		
	CA7-9...23-✱-10 CA7-9...23-✱-01			CA7-PV-S22	53	CA7-PVB-S22	79		
3	1		CA7 all	CS7-PV-31	53	CS7-PVB-31	79		
			CA7-9...23-✱-10 CA7-9...23-✱-01	CA7-PV-S31	53	CA7-PVB-S31	79		
			CA7 all	CS7-PV-13	53	CS7-PVB-13	79		
4	0		CA7 all	CS7-PV-40	53	CS7-PVB-40	79		
0	4		CA7 all	CS7-PV-04	53	CS7-PVB-04	79		
1+1EM	1+1LB		CA7 all	CS7-PV-L22	74	NOT AVAILABLE	~		







4-pole auxiliary



2-pole auxiliary contact block (typical)

① Max. number of auxiliary contacts that may be mounted:
 • AC Coil and Electronic DC Coil contactors - max. 4 N.O. contacts on the front of the contactor, 2-N.O. contacts on the side, 4-N.C. front or side: 6 total.
 • True DC Coil contactors - max. 4 N.O. contacts on the front of the contactor, or max. 2-N.O. contacts on side, 4-N.C. front or side: 4 total.
 ② Detailed ratings can be found on page A74.

Side Mount Auxiliary Contact Blocks (1 & 2 Pole) ①

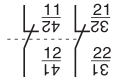
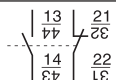
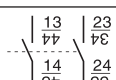
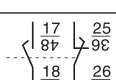
Contact Block	Description	NO	NC	Contact Arrangement	For use with...	Catalog Number ③	Price
 <p>1-pole (typical)</p>  <p>2-pole (typical)</p>	<p>Auxiliary Contact Blocks for Side Mounting - ①</p> <ul style="list-style-type: none"> • 1 and 2-pole • Two way numbering for right or left mounting on the contactor • Snap-on design - mounts without tools • Electronic compatible contacts down to 24V, 20mA • Late break / early make (L) available • Mutual positive guidance to the main contactor poles (excluding L-types) 	0	1		CA7 all	CA7-PA-01	17
		1	0		CA7 all ②	CA7-PA-10	17
		0	2		CA7 all	CA7-PA-02	27
		1	1		CA7 all ②	CA7-PA-11	27
		2	0		CA7 all ②	CA7-PA-20	27
		1EM	1LB		CA7 all	CA7-PA-L11	37

- ① Max. number of auxiliary contacts that may be mounted:
 - AC Coil contactors - max. 4 N.O. contacts on the front of the contactor, 2-N.O. contacts on the side, 4-N.C. front or side: 6 total.
 - DC Coil contactors - max. 4 N.O. contacts on the front of the contactor, or max. 2-N.O. contacts on side, 4-N.C. front or side: (4) total.
- ② Left mounting only is recommended when using with CA7-9...CA7-23 contactors. These contactors have built-in auxiliaries, which will result in duplicate terminal markings if mounted on the right.
- ③ Detailed ratings can be found on page A74.

Control Modules (continued)

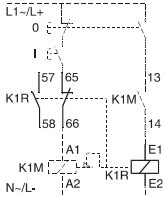
Module	Description	For use with...	Connection Diagrams	Catalog Number	Price
	<p>Mechanical Latch – Following contactor latching, the contactor coil is immediately de-energized by the NC auxiliary contact (65-66).</p> <ul style="list-style-type: none"> • Electrical or manual release • 1 NO + 1 NC auxiliary switch • Suitable for all CA7 contactors 	All CA7 ⑥		CV7-11-* Replace * with coil code below (See Application Note below)	94

CV7 Mechanical Latch Coil Codes ①②④⑤

Coil Code	Application Range			Latch & Contactor Coil Rating
	50 Hz	60 Hz	VDC	
24Z	24 VAC	24 VAC	12 VDC	24V 50/60 Hz
48Z	48 VAC	48 VAC	24 VDC	48V 50/60 Hz
110	100 VAC	110 VAC	48 or 60VDC	110V50/110V60
120	110 VAC	120 VAC	~	110V50/120V60
220W	~	208...240 VAC	~	208...240V60
230Z	230 VAC	230 VAC	110 VDC	230V 50/60 Hz
240Z	240 VAC	240 VAC	125 VDC	240V 50/60 Hz
277	240 VAC	277 VAC	~	240V50/277V60
380	380...400 VAC	440 VAC	~	380...400V50/440V60
400Z	400 VAC	400 VAC	220 VDC	400V 50/60 Hz
415	400...415 VAC	~	~	400...415 V50 Hz
480	440 VAC	480 VAC	~	440V50/480V60
600 ③	550 VAC	600 VAC	~	550V50/600V60

APPLICATION NOTE:

The CV7 Mechanical Latch for CA7 may be used for both AC and DC applications; however when using DC control circuit the user must apply the following rules for coil selection of the contactor and latch combination:

- When DC control circuits are required use CA7-9...55 contactors with AC coil and latch with AC coil. From column "VDC" in the table on the left, identify the required application DC control voltage and then select its specific Coil Code. Enter this Coil Code to complete the catalog numbers for both the contactor and latch (i.e.: 125V DC control circuit should use a 240Z coil code in both the CA7-9...55 and CV7). This works because both coils are only momentary energized and coil clearing contacts breaks the circuit after closing or opening.
- The above statement does NOT apply to applications CA7-60D...97D two-winding DC coil contactors. When DC control circuits are required use CA7-60D...97D contactors with standard two winding DC coil and the CV7 latch with AC coil selected from the table, top left. (i.e.: 125V DC control circuit should use 125DD coil code in the contactor and 240Z AC coil code in the CV7 latch).
- The CA7-9E...55E contactor uses an electronic DC coil and the CV7 latch coil code should be chosen from the table on the left. (i.e.: 24V DC control circuit select CA7-9E...55E with code 24E and CV7 latch uses a 48Z AC coil code).

① Other voltages available. Contact your Sprecher + Schuh representative.

② CV7 must be wired for momentary operation only.





③ Use 600V AC when 575 V is required.

④ Command duration 0.03...10 seconds.

⑤ Coil operating limits on CV7-11 match those of the contactor it is being used with.

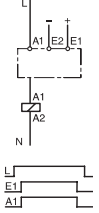

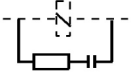
⑥ Not for use with CA7-90 (4-pole) contactors.

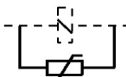
Control Modules (continued)

Module	Description	For use with...	Connection Diagrams	Function		Catalog Number	Price
				Input	Output		
	<p>Electronic Interface – Interface between the DC control signal from a PLC and the AC operating mechanism of the contactor.</p> <ul style="list-style-type: none"> Requires no additional surge suppression for the coils Suitable for all CA7 contactors ② 	CA7 all (with AC control)		<p>24V DC ①</p> <p>12V DC</p> <p>48V DC</p>	<p>110...</p> <p>240V AC</p>	<p>CR17E-24</p> <p>CR17E-12</p> <p>CR17E-48</p> <p><i>Indicates special order</i></p>	72
	<p>Surge Suppressors - Limits coil switching transients.</p> <ul style="list-style-type: none"> Plug-in, coil mounted Suitable for all CA7 contactors 	CA7 all (with AC control)		<p>RC Module - AC Control (50/60Hz)</p> <p>24...48V</p> <p>110...280V</p> <p>380...480V</p>		<p>CRC7-48</p> <p>CRC7-280</p> <p>CRC7-480</p>	34
		CA7-9C...43C (with conventional DC control)		<p>Diode Module - DC Control</p> <p>12-250VDC</p>		<p>CRD7-250 ③</p>	34
		CA7 all (with AC control) CA7-9C...43C (with conventional DC control)		<p>Varistor Module - AC/DC Control</p> <p>12...55VAC/ 12...77VDC</p> <p>56...136VAC/ 78...180VDC</p> <p>137...277VAC/ 181...350VDC</p> <p>278...575VAC</p>		<p>CRV7-55 ③</p> <p>CRV7-136 ③</p> <p>CRV7-277 ③</p> <p>CRV7-575 ③</p>	34

- ① Control voltage 18...30V DC (10...15mA)
- ② Minimum actuation current is 5 volts, 2ma. The leakage current is <1mA for the following:
 - CR17E-12 @ 2.5 VDC input
 - CR17E-24 @5 VDC input
 - CR17E-48 @ 10 VDC input.
- ③ Electronic DC Contactors (CA7-9E...55E) include internal surge protection and do not require additional external surge protection.

AC Voltage Sag Immunity Modules

Module	Description	Full-Wave Bridge Rectifier		Catalog Number	Price
		Module Input	Module Output		
		Control circuit voltage range	For use with CA7-60...97 contactors with DC coil		
	SEMI-F47-Module	24-250 VAC	24-250 VDC ⓘ	CA7-SF47	109
	Semi-F47-Module with 1...30s on-delay timer	110-250 VAC	110-250 VDC ⓘ	CA7-SF47A30	175

Sprecher + Schuh's CA7-SF47 module meets the Semi-F47 AC voltage sag immunity requirements to 50% voltage sag for 200 ms. Voltage sags can affect the readiness and operation of contactors and starters, resulting in shut downs, lost production, and diminished revenue. It is essential for process equipment to be compatible with its electrical environment. The CA7-SF47 voltage sag immunity module is an essential component to achieve equipment reliability during voltage sag events.

Product Features

- Meets Semi-F47 standard requirements
- For use with CA7-60...97 contactors with DC coils. A full-wave bridge rectifier internal to the CA7-SF47 module provides AC to DC coil voltage rectification.
- Suitable for contactor range (with screw terminals)
 - CA7-60...97, 3-Pole contactors
 - CA7-90, 4-Pole contactor
- Optional 1 to 30 seconds On-Delay timer function.

Benefits

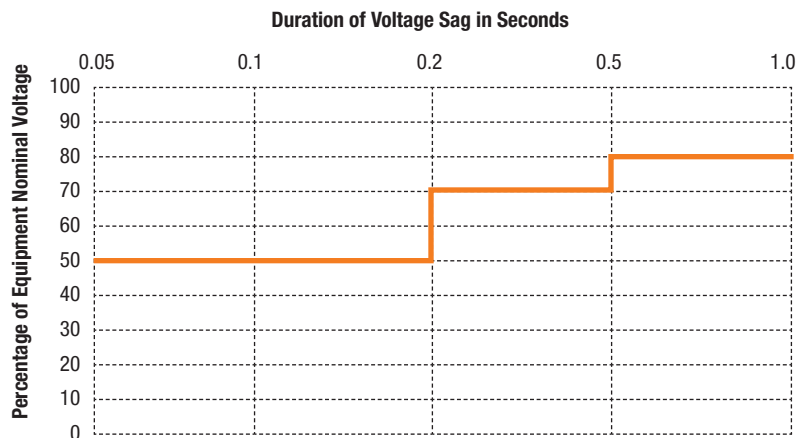

- Direct mounting to the coil terminals of the CA7 contactors. Only 24 mm is added to the component height.
- Direct electrical connection to the contactor. Customer coil power connections are made at the terminals of the CA7-SF47 module
- The CA7-SF47A30 module includes a 1 to 30 seconds adjustable On-Delay timer in addition to the voltage sag immunity functionality. Two independent functions in a single module.



VOLTAGE SAG DURATION				VOLTAGE SAG
Seconds	Milliseconds	Cycles at 60 hz	Cycles at 50 hz	Percent (%) of Equipment Nominal Voltage
< 0.05 s	< 50 ms	< 3 cycles	< 2.5 cycles	Not specified
0.05 to 0.2 s	50 to 200 ms	3 to 12 cycles	2.5 to 10 cycles	50%
0.2 to 0.5 s	200 to 500 ms	12 to 30 cycles	10 to 25 cycles	70%
0.5 to 1.0 s	500 to 1000 ms	30 to 60 cycles	25 to 50 cycles	80%
> 1.0 s	> 1000 ms	> 60 cycles	> 50 cycles	Not specified

ⓘ Input AC control circuit voltage must be matched when selecting the contactor/relay DC coil voltage.

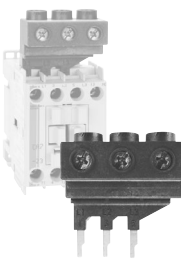
Terminal Lug Kits ①

Component	Description	For use with . . .	Maximum Resistive Current Ratings (A) ②			Pkg. Qty.	Catalog Number ①	Price Each
			IEC (40°C)	IEC (60°C)	UL/CSA (40°C)			
	3 Pole Lug Kit – Allows larger wires to be used with the contactor. Ideal for wye-delta, reversing and multispeed contactors and starters. Can increase IEC AC-1 current rating, as well as the UL/CSA continuous current (resistive) rating of the contactor. Three pole kit used for smaller contactors.	CA7-9. . .23 -line side -load side	45	45	40	1	CA7-P-KN23 CA7-P-KL23	41
		CA7-30. . .37	60	55	55	1	CA7-P-K37	56
	1 Pole Lug Kit – Allows larger wires to be used with the contactor. Ideal for wye-delta, reversing and multispeed contactors and starters. Can increase AC-1 current rating of the contactor. One pole kit used for larger contactors.	CA7-43. . .55	90	75	75	3 ③	CA7-P-K43	28 ③ Each
		CA7-60. . .97	130	130	130	3 ③	CA7-P-K85	33 ③ Each

Paralleling Links ①②

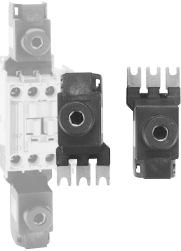
Component	Description	For use with . . .	Maximum Resistive Current Ratings (A) ②			Pkg. Qty.	Catalog Number ①	Price Each
			IEC (40°C)	IEC (60°C)	UL/CSA (40°C)			
	3 Pole Paralleling Link – Allows smaller CA7 contactors to be used on single-phase resistive applications. By paralleling the three power poles, the contacts see only a portion of the actual load. ④	CA7-9. . .23	100	100	100	2 ③	CA7-P-B23	10 ③ Each
		CA7-30. . .37	150	135	150	2 ③	CA7-P-B37	15 ③ Each

Quick Connectors

Component	Description	For use with . . .	Pkg. Qty.	Catalog Number	Price Each
	Stab Connectors - Dual stab (0.250 inch)	CA7-9. . .97 coil term. CA7-9. . .23 power term. CA7 accessories	20 100 100	CA7-SC2 CA7-SC10 CA4-SC11	1.75



① cULus Approved (File E33916).

② Lighting applications are not considered purely resistive loads. Therefore, the IEC and UL/CSA resistive ratings listed here do not apply to lighting loads. Lighting contactor ratings are provided in the Technical Information section.

③ Priced per piece. Total cost is package quantity x price. Minimum order, 3 pieces.

④ Engineering practice permits 2.5 x I_e to be applied to a contactor when 3 poles are connected in parallel for single phase discharge lamp (ballast lighting) applications.

Reversing Components

Component	Description	For Use With...	Pkg. Qty.	Catalog Number	Price Each
	Dovetail Connectors – Connects multiple contactor and starter assemblies together.	CA7 all	10	CA7-S9	1.75
	Reversing Power Wiring Kit - ① Provides a solid “wireless” connection for reversing applications. May be used with both solid state and thermal O/L relays.	CA7-9...12 CA7-16...23	1	CAUT7-PW23	17
		CA7-30...37	1	CAUT7-PW37	20
		CA7-43...55	1	CAUT7-PW55	37
		CA7-60...97	1	CAUT7-PW85	94

Reversing Power Wiring Kits

Only the kits are catalog items. Single components are available by special order in bulk packages of 20 pieces.

Reversing Starter Connection Kits ②

Kit = CAUT7-PW23
CA7-PW1M23M

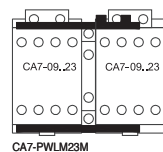

CA7-PWLM23M

Kit = CAUT7-PW37
CA7-PW1M37M

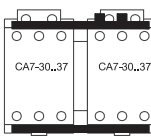

CA7-PWLM37M

Kit = CAUT7-PW55
CA7-PW1M55

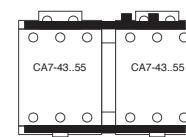

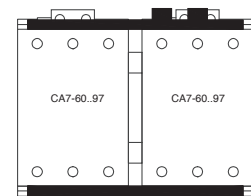

CA7-PWLM55M

Kit = CAUT7-PW85
CA7-PW1M85M



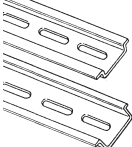

CA7-PWLM85M

Assembly Components

Component	Description	For Use With...	Pkg. Qty.	Catalog Number	Price Each
	Protective Covers - Protects against unintended manual operation.	CA7 all	1	CA7-SCC	3.35
	Protective Covers - For front mounted auxiliary contacts, pneumatic timers and latches.	CS7-PV, CA7-PV, CZE7, CZA7, CV7	1	CA7-SCF	1.75
	DIN-rail - 2 meter lengths (6' 6"); price per rail	CA7 all	20	3F 3AF	29 44
			10		

Marking Systems

Component	Description	Pkg. Qty.	Catalog Number	Price Each
	Label Sheet – 1 sheet with 105 self-adhesive paper labels each, 6 x 17mm	1	CA7-FMS	1.75
	Marking Tag Sheet - 1 sheet with 160 perforated paper labels each, 6 x 17mm. To be used with transparent cover.	1	CA7-FMP	1.75
		100 ②	CA7-FMC	.17
	Tag Carrier - For marking with Clip-on Tags. See Terminals Section N for complete listing of Clip-on Tags.	100 ②	CA7-FMA2	.17

① cULus Approved (File E33916).

Wye-Delta Starter Kits ①

Wye-Delta power wiring kits were designed to aid in the field assembly of open-transition wye-delta starters that use CA7 contactors. These kits include line, load and start-point (shorting) connections. Assembling a wye-delta starter requires the use of the following components:

- Contactors and overload relay
- Mechanical / Electrical Interlock (Cat.No: CM7-02)
- Electronic Wye-delta Timer (Cat. No: CRZY7-30-110/240)
- Dovetail Connector to couple 1M and 2M contactor (Cat. No: CA7-S9); optional



Power Jumper Connection



Shorting Bar



Reversing Power Connection

Three Contactor Assembly Components

3-Phase Rating											For 3 contactor assembly ②	Price	
kW (50Hz)				HP (60Hz)				Use with catalog number . . .					
230V	380V	415V	500V	690V	200V	230V	460V	575V	Delta	Wye			
									1M	2M	1S	Catalog Number	Price
5.5	8	8	8	8	5	5	10	10	CA7-9	CA7-9	CA7-9		
7.5	11	11	11	11	5	7.5	15	15	CA7-12	CA7-12	CA7-9		
10	14	15	14	14	7.5	10	20	20	CA7-16	CA7-16	CA7-12		
14	21	21	19	19	7.5	10	25	25	CA7-23	CA7-23	CA7-12		
18	28	28	28	28	10	15	30	30	CA7-30	CA7-30	CA7-16	CAYT7-PW37	27
19	35	35	32	32	15	20	40	40	CA7-37	CA7-37	CA7-23		
23	40	40	41	41	20	25	50	50	CA7-43	CA7-43	CA7-37	CAYT7-PW55	44
30	45	45	45	45	25	30	60	60	CA7-55	CA7-55	CA7-30		
33	58	60	56	56	30	40	75	75	CA7-60	CA7-60	CA7-37	CAYT7-PW72	79
39	69	67	70	70	40	50	100	100	CA7-72	CA7-72	CA7-43		
47	82	82	81	81	50	60	125	125	CA7-85	CA7-85	CA7-60	CAYT7-PW85	106
50	90	90	90	90	50	60	125	125	CA7-97	CA7-97	CA7-60		

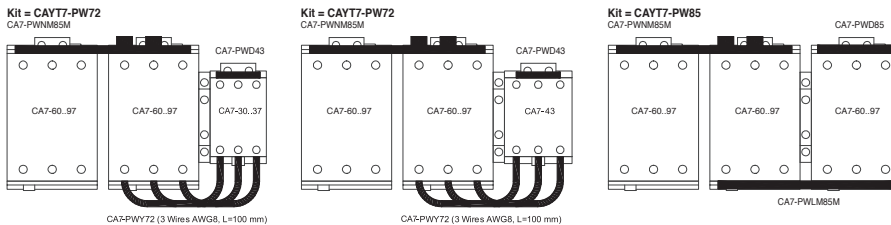
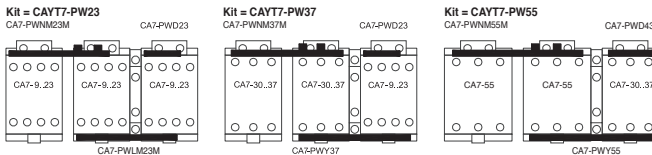

Two Contactor Assembly Components

When Connecting...		Load Side Power Connection		Shorting Bar	
Delta	Wye	Catalog Number	Price	Catalog Number	Price
2M	1S				
CA7-30	CA7-30	CA7-PWLM37M	11	CA7-PWD43	14
CA7-37	CA7-37				
CA7-43	CA7-43	CA7-PWLM55M	18		
CA7-55	CA7-55				
CA7-60	CA7-60	CA7-PWLM85M	46		
CA7-72	CA7-72				
CA7-85	CA7-85				
CA7-97	CA7-97				

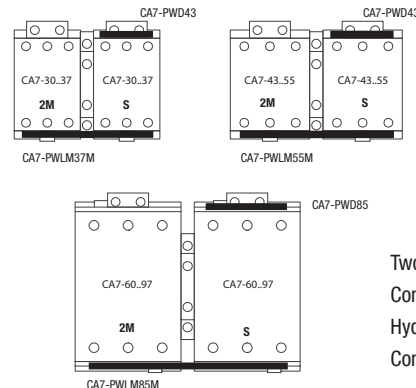

Two Contactor Wiring Connections are for Hydraulic Elevator Wye-Delta Contactors CA7Y2

① cULus Approved (File E33916).

② Individual parts of kits are available for unique applications by special order. Contact your Sprecher + Schuh Representative.

Renewal Coils - A.C. ①②③

AC Control Voltages			AC Coil Codes ②	For use with contactor . . .									
				CA7-9...16 CA7-9-M...16-M... CAQ7-16 CNX-205...206 CAN7-12...16 ~	CA7-23...37 CA7-23-M...37-M... CAQ7-37 CNX-207...209 CAN7-37 CAL(V)7-20-M40	CA7-43...55 ~ ~ CNX-212 CA7-40-M, CAN7-43 CAL(V)7-30-M40	CA7-60...85 ~ ~ CNX-218 CAN7-85 ~	CA7-97 CA7-90-M... ~ ~ CAL(V)7-60-M40	Cat. No.	Cat. No.	Cat. No.	Cat. No.	Cat. No.
50 Hz	60 Hz	50/60 Hz											
~	12V	~	12B	TA006	TC006	TD006	TE006	TF006					
12V	~	~	12A	TA404	TC404	TD404	TE404	TF404					
~	24V	~	24B	TA013	TC013	TD013	TE013	TF013					
24V	~	~	24A	TA407	TC407	TD407	TE407	TF407					
~	~	24V	24Z	TA855	TC855	TD855	TE855	TF855					
32V	36V	~	36	TA481	TC481	TD481	TE481	TF481					
36V	~	~	36A	TA410	TC410	TD410	TE410	TF410					
42V	48V	~	48	TA482	TC482	TD482	TE482	TF482					
48V	~	~	48A	TA414	TC414	TD414	TE414	TF414					
~	~	48V	48Z	TA860	TC860	TD860	TE860	TF860					
100V	100...110V	100	110	TA861	TC861	TD861	TE861	TF861					
110V	120V	~	120	TA473	TC473	TD473	TE473	TF473					
~	~	110V	110Z	TA856	TC856	TD856	TE856	TF856					
120V	~	~	120A	TA425	TC425	TD425	TE425	TF425					
115V	127V	~	127	TA424	TC424	TD424	TE424	TF424					
127V	~	~	127A	TA428	TC428	TD428	TE428	TF428					
200V	200..220V	200V	220	TA862	TC862	TD862	TE862	TF862					
~	208V	~	208	TA049	TC049	TD049	TE049	TF049					
200...220V	208..240V	~	220W	TA296	TC296	TD296	TE296	TF296					
220V	240V	~	240	TA474	TC474	TD474	TE474	TF474					
220...230V	260V	~	230A	TA441	TC441	TD441	TE441	TF441					
~	~	200...230V	230W	TA864	TC864	TD864	TE864	TF864					
~	~	230V	230Z	TA851	TC851	TD851	TE851	TF851					
230...240V	~	~	240A	TA440	TC440	TD440	TE440	TF440					
240V	277V	~	277	TA480	TC480	TD480	TE480	TF480					
~	~	240V	240Z	TA858	TC858	TD858	TE858	TF858					
~	347V	~	347	TA065	TC065	TD065	TE065	TF065					
~	380V	~	380B	TA067	TC067	TD067	TE067	TF067					
380V...400V	440V	~	380	TA071	TC071	TD071	TE071	TF071					
~	~	400V	400Z	TA863	TC863	TD863	TE863	TF863					
400V...415V	~	~	415	TA457	TC457	TD457	TE457	TF457					
440V	480V	~	480	TA475	TC475	TD475	TE475	TF475					
~	~	440V	440Z	TA859	TC859	TD859	TE859	TF859					
500V	~	~	500A	TA479	TC479	TD479	TE479	TF479					
550V	600V	~	600	TA476	TC476	TD476	TE476	TF476					
Price				59	84	101	118	118					

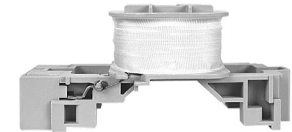

CA7 AC Coil (typical)

① Other coil voltages available. Contact your Sprecher + Schuh representative for information.

② AC Codes in bold letters and shaded indicate coils that are standard stocked items.

③ AC and DC coils on CNX-xxx contactors are not interchangeable.

Renewal Coils - D.C. ①②

A
CA7 Contactors

DC Control Voltages	DC Coil Codes ②	Electronic DC Replacement Coils ⑥			True DC Replacement Coils ⑦			Two Winding DC Replacement Coils	
		For use with contactor...			For use with contactor...			For use with contactor...	
		CA7-9E...16E CA7-9E-M...16E-M... CAN7-12E...16E	CA7-23E...37E CA7-23E-M... CAN7-37E	CA7-43E...55E CA7-40E-M... CAN7-43E	CA7-9C(D)...16C(D) CA7-9C(D)-M... 16C(D)-M... CNX-205...206 CAN7-12C...16C	CA7-23C(D)...37C(D) CA7-23C(D)-M... CNX-207...209 CAN7-37C	CA7-43C CA7-43C(D) CA7-40C-M... CNX7-212 CAN7-43C	CA7-60D...85D ⑧ CNX7-218 CAN7-85D	CA7-97D ⑨ CA7-90D-M...
Cat. No.	Cat. No.	Cat. No.	Cat. No.	Cat. No.	Cat. No.	Cat. No.	Cat. No.		
9V ③	9D	~	~	~	TA766	TC766	TD766	~	~
9V Diode ③	9DD	~	~	~	~	~	~	TE766M	TF766M
12V Electronic	12E	TC708E	TC708E	TD708E	~	~	~	~	~
12V	12D	~	~	~	TA708	TC708	TD708	~	~
12V Diode	12DD	~	~	~	~	~	~	TE708M	TF708M
24V Electronic	24E	TC714E	TC714E	TD714E	~	~	~	~	~
24V ④	24D	~	~	~	TA714	TC714	TD714	~	~
24V Diode ④	24DD	~	~	~	TA714M	TC714M	TD714M	TE714M	TF714M
36-48V Elec	36E	TC719E	TC719E	TD719E	~	~	~	~	~
36V	36D	~	~	~	TA719	TC719	TD719	~	~
36V Diode	36DD	~	~	~	~	~	~	TE719M	TF719M
48-72V Elec	48E	TC724E	TC724E	TD724E	~	~	~	~	~
48V	48D	~	~	~	TA724	TC724	TD724	~	~
48V Diode	48DD	~	~	~	~	~	~	TE724M	TF724M
60V	60D	~	~	~	TA774	TC774	TD774	~	~
60V Diode	60DD	~	~	~	~	~	~	TE774M	TF774M
64V	64D	~	~	~	TA727	TC727	TD727	~	~
64V Diode	64DD	~	~	~	~	~	~	TE727M	TF727M
72V	72D	~	~	~	TA728	TC728	TD728	~	~
72V Diode	72DD	~	~	~	~	~	~	TE728M	TF728M
80V	80D	~	~	~	TA729	TC729	TD729	~	~
80V Diode	80DD	~	~	~	~	~	~	TE729M	TF729M
110-125V Elec	110E	TC733E	TC733E	TD733E	~	~	~	~	~
110V	110D	~	~	~	TA733	TC733	TD733	~	~
110V Diode	110DD	~	~	~	~	~	~	TE733M	TF733M
115V	115D	~	~	~	TA734	TC734	TD734	~	~
115V Diode	115DD	~	~	~	~	~	~	TE734M	TF734M
125V	125D	~	~	~	TA737	TC737	TD737	~	~
125V Diode	125DD	~	~	~	~	~	~	TE737M	TF737M
220-250V Elec	220E	TC747E	TC747E	TD747E	~	~	~	~	~
220V	220D	~	~	~	TA747	TC747	TD747	~	~
220V Diode	220DD	~	~	~	~	~	~	TE747M	TF747M
230V	230D	~	~	~	TA749	TC749	TD749	~	~
230V Suppres.	230DS	~	~	~	~	~	~	TE749F	TF749F
250V	250D	~	~	~	TA751	TC751	TD751	~	~
250V Suppres.	250DS	~	~	~	~	~	~	TE751F	TF751F
Price (coil without diode)		~	~	~	138	165	190	~	~
Price (coil with diode)		202	202	215	202	202	215	235	235

Note: The "DD" coils listed above include an integrated bidirectional diode. Drop out time of this design is significantly improved when compared to an external diode. See ratings on page A68.

- ① Other coil voltages may be available. Contact your Sprecher + Schuh representative for information.
- ② DC Codes in bold letters and shaded indicate coils that are standard stocked items.
- ③ Voltage operating range: $0.65 \dots 1.3 \times U_s$
- ④ Voltage operating range: $0.7 \dots 1.25 \times U_s$
- ⑤ CA7-60D...97D contactors have a two winding coil with built-in late break auxiliary contact and coil suppression.
- ⑥ CA7-9E...55E electronic coils are not interchangeable with non-electronic DC or AC coils
- ⑦ AC and DC coils on CNX-xxx contactors are not interchangeable.

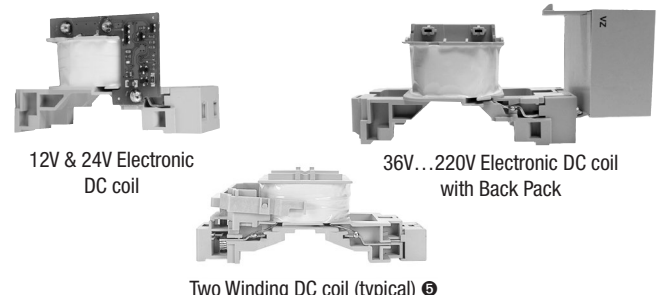

CA7 Contactors

Replacement Contactors Cross Reference, Series CA1 to Series CA7 (Open Type Only) ①

I _e [A] ①		Ratings for Switching AC Motors (AC2 / AC3 / AC4)										Series CA1U Obsolete	Series CA7 Equivalent		
		kW (50 Hz)				UL/CSA HP (60 Hz)								Catalog Number	Catalog Number
		AC-3	AC-1	230V	400V / 415V	500V	690V	1 Ø		3 Ø					
						115V	230V	200V	230V	460V	575V				
						1	3	5	5	10	10	CA1U-10			
16	32	5.5	7.5	7.5	7.5	1	3	5	5	10	15		CA7-16-10		
						2	3	7-1/2	7-1/2	15	20	CA1U-14			
23	32	7.5	11	13	10	2	3	5	7-1/2	15	15		CA7-23-10		
						2	5	7-1/2	10	20	25	CA1U-16			
30	65	10	15	15	15	2	5	7-1/2	10	20	25		CA7-30-10		
						3	7-1/2	10	15	30	40	CA1U-25			
43	85	13	22	25	22	3	7-1/2	10	15	30	30		CA7-43-10		
72	100	22	40	45	40	5	15	20	25	50	60		CA7-72-10		
						5	15	25	25	50	60	CA1U-40			
85	100	25	45	55	45	7-1/2	15	25	30	60	60		CA7-85-10		
						7-1/2	20	30	30	60	75	CA1U-55			
97	130	30	55	55	55	10	15	30	30	75	75		CA7-97-10		

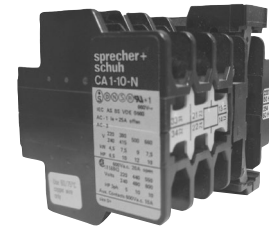

CA1U-10
Contactor

Replacement Contactors Cross Reference, Series CA3 to Series CA7 (Open Type Only) ①

I _e [A] ①		Ratings for Switching AC Motors (AC2 / AC3 / AC4)										Series CA3 Obsolete	Series CA7 Equivalent		
		kW (50 Hz)				UL/CSA HP (60 Hz)								Catalog Number	Catalog Number
		AC-3	AC-1	230V	400V / 415V	500V	690V	1 Ø		3 Ø					
						115V	230V	200V	230V	460V	575V				
								2	2	5	7-1/2	CA3-9-10			
9	32	3	4	4	4	1/2	1 1/2	2	2	5	7-1/2		CA7-9-10		
								3	3	7-1/2	10	CA3-12-10			
12	32	4	5.5	5.5	5.5	1/2	2	3	3	7-1/2	10		CA7-12-10		
								5	5	10	15	CA3-16-10			
16	32	5.5	7.5	7.5	7.5	1	3	5	5	10	15		CA7-16-10		
								5	5	10	15	CA3-23A-10			
23	32	7.5	11	13	10	2	3	5	7-1/2	15	15		CA7-23-10		
								7-1/2	7-1/2	15	20	CA3-23-10			
30	65	10	15	15	15	2	5	7-1/2	10	20	25		CA7-30-10		
								10	10	20	25	CA3-30-10			
								10	10	25	30		CA7-37-10		
37	65	11	18.5/20	20	18.5	3	5	10	10	25	30	CA3-37			
43	85	13	22	25	22	3	7-1/2	10	15	30	30		CA7-43-10		
								10	15	30	40	CA3-43			
								15	20	40	50	CA3-60			
55	85	15	30	30	22	5	10	15	20	40	40		CA7-55-10		
60	100	18.5	32	37	32	5	10	15	20	40	50		CA7-60-10		
								20	20	50	60	CA3-72			
72	100	22	40	45	40	5	15	20	25	50	60		CA7-72-10		
85	100	25	45	55	45	7-1/2	15	25	30	60	60		CA7-85-10		
97	130	30	55	55	55	10	15	30	30	75	75		CA7-97-10		

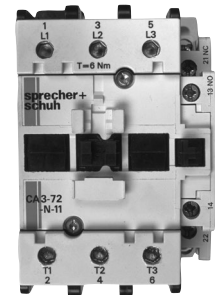

CA3-72
Contactor

① Available auxiliary contacts may vary. See selection pages for more information.