



Fiber Optic Cable Installation and Handling Instructions

Introduction

Fiber optic cables can be easily damaged if they are improperly handled or installed. It is imperative that certain procedures be followed in the handling of these cables to avoid damage and/or limiting their usefulness. The information contained in this manual should serve as a guide to proper handling, installing, testing, and for troubleshooting problems with fiber optic cables.

For:	See page:
Overview	2
Fiber Optic Cable Pulling Techniques	3
Routing Fiber Optic Cables	5
Installation Checklist	6
Cleaning Techniques for Fiber Optic Cables	7
Fiber Optic Cable Attenuation Measurements	8
Plastic Fiber Optic Cable Attenuation Limits	12
SERCOS Attenuation Limits	15
System Field Testing Overview	16
Configuring Light Source	18
Physical Test Mode for Connections	19
Fiber Optic Cable Specifications	25
Rockwell Automation Support	BackCover

Overview

Optical fibers require special care during installation to ensure reliable operation. Installation guidelines regarding minimum bend radius, tensile loads, twisting, squeezing, or pinching of cable must be followed. Cable connectors should be protected from contamination and scratching at all times. Violation of any of these parameters causes increased attenuation or permanent damage to the cable. The following are a few general comments to consider when installing fiber optic cables.

Do not exceed maximum cable lengths

Make sure you check the installation instructions of the module for the appropriate cable lengths to ensure proper operation.

You may experience additional attenuation loss when using bulkhead connectors to join cables even when the total length is less than maximum. Care should be used in maintaining total attenuation budget when joining cables with bulkhead connectors.

Do not exceed minimum bend radius for a given cable type

Exceeding the bend radius of the cable can cause unseen damage to the fibers of the cables that may not manifest itself for a period of time. This can lead to an expensive restringing of cables at a later date. See the cable specification tables later in this manual for appropriate bend radii for each catalog number.

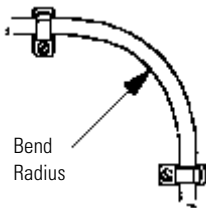

Figure 1 Correct Bend Radius

Avoid twisting cable

Use proper pulling techniques in laying out your cable. Putting twists in the cable greatly increases your chances of breaking the fibers.

Fiber Optic Cable Pulling Techniques

Installation methods for both wire cables and optical fiber cables are similar. Just remember these rules:

- **Never pull on the connector.** The connector/cable interface is not designed for pulling.
- **Use a pulling grip** designed for pre-connected fiber optic cables. Grips with a fixed pull ring should use a swivel to attach the pull rope.
- **Monitor tension.** Do not exceed the maximum tensile load.
 - On runs from 40m to 100m, use proper lubricants and make sure they are compatible with the cable jacket.
 - On runs over 100m, use proper lubricants and pull from the middle out to both ends.
 If possible, use an automated puller with tension control or at least a breakaway-pulling eye.
- **Always use a straight pull.** Use cable guides to maintain the recommended bend radius. Do not exceed the cable bend radius. Exceeding the bend radius harms the fibers. It may not be immediate, it may even take a few years but eventually by exceeding the recommended bend radius of the cable you reduce the useful life of the cable.

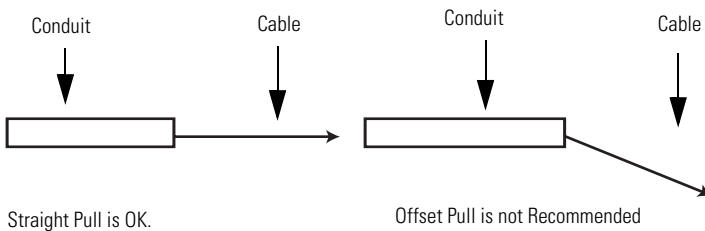

Figure 2 Proper Pulling Technique Through Conduit

- **Do not twist the cable.** Putting a twist in the cable can stress the fibers.

- **For a 40m or longer pull.** If you are installing cable of lengths 40m or longer, use a “figure 8” on the ground to prevent twisting. The figure 8 puts a half twist in on one side of the 8 and takes it out on the other, preventing twists.

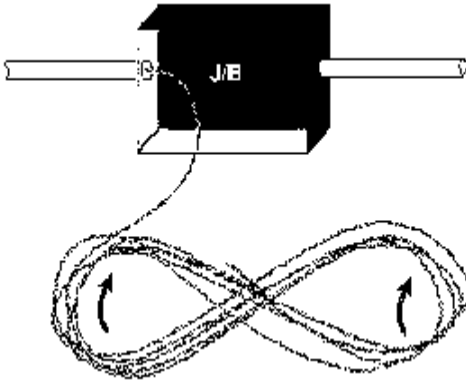

Figure 3 Prevent Twisting the Cable By Laying Cable in a Figure 8 Pattern

1. Lay cable on floor in a figure 8 pattern.
 2. Turn Figure 8 cable 360 degrees (upside down) before continuing.
 3. Pull in opposite direction (may require two people).
-
- **Use a swivel-pulling eye,** to prevent additional twisting of the cable during installation.

Suggested Pull Grips

The Hubbell OPTISOK, Kellems Fiber-Optic Pulling grip

Routing Fiber Optic Cables

Take care to properly route cables through cabinets and right angle raceways.

- **Install cables in raceways without loops.** Avoid placing fiber optic cables in raceways and conduits with copper cables to avoid excessive loading or twisting.

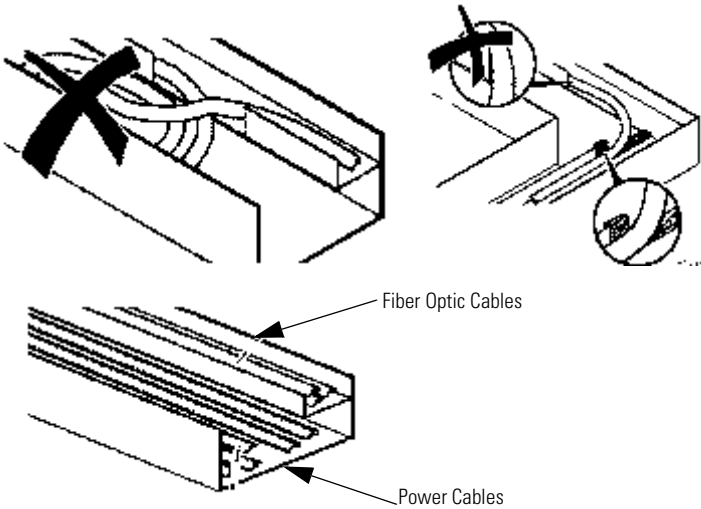

Figure 4 Using Raceways and Conduits

- **Protect cables from excessive or frequent bending.** Cables do not have a flex rating. Routing on a cabinet door should be used as a last resort. Special care must be taken to protect the cable and to avoid exceeding the bend radius of the cable.

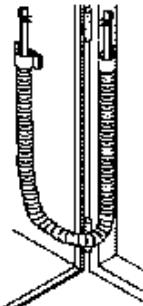

Figure 5 Routing Technique for Cabinet Door

- **Use proper cable pulling techniques when routing cables.** See the section *Fiber Optic Cable Pulling Techniques* earlier in this manual.
- **Attach cables with plastic clamps having large surface areas.** Avoid pinching or squeezing cable. Cable clamps should be installed manually with gentle pressure.

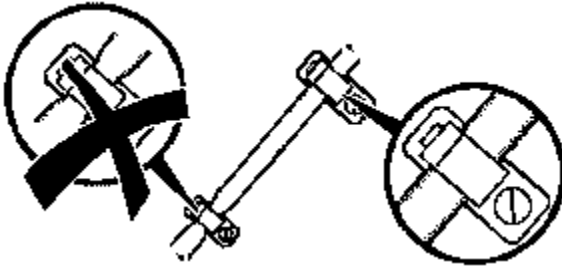

Figure 6 Proper Use of Plastic Clamps

Installation Checklist

Use the following installation checklist to ensure proper handling.

Installation Procedure	Complete	Comments
Maximum cable length not exceeded		
Bending radius not exceeded		
Maximum tensile load not exceeded; proper pulling techniques used		
Cable not squeezed or bent		
Cable installed without loops in raceways		
Cable protected from sharp edges		
Fiber cable installed in separate raceways from copper		
Cable connector cleanliness maintained		
Cable connector finger tight to transceivers		

Cleaning Techniques for Fiber Optic Cables

Proper cleaning of the fiber optic cable ends and transceivers is essential to minimize system attenuation. Dirty fiber optic cables cross contaminate their mating transceivers. Conversely a dirty transceiver contaminates its mating fiber optic cable.

There are a variety of ways to clean fiber optic components. Readily available prepackaged wipes, swabs and, canned air are suitable. Always choose an optical grade cleaner for these purposes.

Cleaning Fiber Optic Cable Ends

Use a wet wipe to loosen particles on the end of the cable connector using a circular or straight wiping motion while using care to avoid wiping over area of pad that has already been used. Do not use a back and forth scrubbing action. Always use a clean area of the swab for each connector. When in doubt use a fresh wipe. Follow up the wet wipe cleaning with a dry wipe to remove any residue. Use canned air to remove any lint from the cable end.

Cleaning Fiber Optic Transceivers

Choose an optical grade lint free swab that fits easily into the transceiver barrel. Under some conditions a fast evaporating optical cleaning solvent may be used to saturate the swab (e.g., 99% pure alcohol). The swab should be gently placed into the barrel of the connector and rotate no more than one turn. DO NOT rotate back-and-forth or round-and-round because this could grind debris into the transceiver. The swabs should only be used ONCE. Use a dry clean swab and insert into barrel and rotate once. Discard swab. Use canned air to blow out the barrel.

Chemtronics and Coventry are just some of the manufacturers of suitable cleaning swabs and wipes.

- Newark Electronics:
92N4770 Fiber Clean Dispense System (cleaning cloth/tape)
- Contact East supplies:
Optic Wipes part # 127-734
Fiber Optic Swabs part # 416-761

Fiber Optic Cable Attenuation Measurements

1. Inspect and clean the ends of the reference cable.
2. Securely connect appropriate reference cable corresponding to the type of cable to be tested.
 - POF reference cable used for testing POF cable
 - HCS reference cable used for testing HCS cable

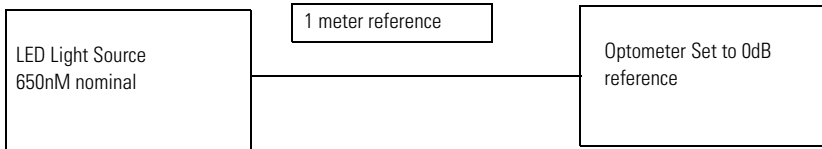

Figure 7 Zero dB Reference

3. Turn on light Source
4. Turn on optometer and select appropriate wavelength.
5. Verify Output Power
 - a. POF reference cable -7.5dBm to -3.5dBm
 - b. HCS reference cable -18dBm to -10dBm

Note: If output power is out of range, verify that the source has fresh batteries and proper calibration.

6. Set the zero db reference for the optometer. (see optometer reference manual)

Cable Attenuation Measurement

1. Inspect ends of cable for proper termination. Clean ends of fiber.
2. Turn on light Source

3. Verify that optometer is set to measure appropriate wavelength and attenuation in dB.

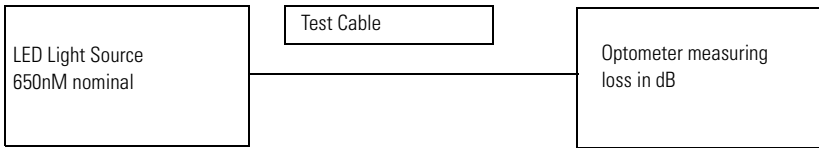

Figure 8 Attenuation Measurement

4. Securely connect test cable between source and optometer.
5. Use the dB value on the optometer to verify that the cable under test is within specification listed in the table for that specific catalog number.
6. Reverse the cable and test again starting at step 2.

Cable Attenuation Measurement with Bulkhead Connector

1. Inspect ends of cable for proper termination. Clean ends of fiber.
2. Turn on light Source
3. Securely connect appropriate reference cable corresponding to the type of cable to be tested.
 - POF reference cable used for testing POF cable
 - HCS reference cable used for testing HCS cable
4. Securely connect bulkhead connector to reference cable.
5. Securely connect test cable between bulkhead connector and optometer.

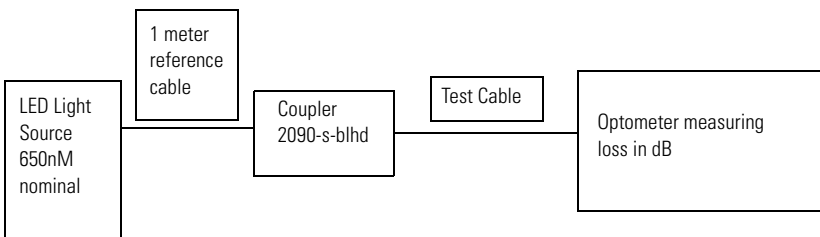

Figure 9 Attenuation Measurement with Bulkhead Connector

6. Verify that optometer is set to measure appropriate wavelength and attenuation in dB.
7. Use the dB value on the optometer to verify that the cable under test is within specification listed in the table for that specific catalog number.
8. Reverse the cable and test again starting at step 2.

Recommended Equipment List

650 nm LED Light Source - Tempo 253B

Optometer - Tempo CP-3137

Mating adapters for SMA connectors - Tempo 905-120-5000

- 1m HCS Reference Cable with recorded attenuation - XSOPTZCS
T01SSFSF0001MZ
- 1m POF Reference Cable - Tempo PO1XSFS0001M1

Hard Clad Silica Glass Fiber Optic Cable Attenuation Limits

Hard Clad Silica Glass (HCS) Fiber cable attenuation calculations for cables <= 100m

HCS Cable Attenuation = Cable Loss + Connector Loss + Finishing Tolerance

HCS Cable Attenuation = $((15 - 4 * \log(Lkm)) * Lkm) + 1.5dB + 0.5dB$

Catalog Number	Length meters, (inches)	Maximum Attenuation (dB)	Maximum Attenuation With Bulkhead Conn.
2090-SCVG50-0	50, (1968)	3.01	NOT ALLOWED
2090-SCVG100-0	100, (3936)	3.90	NOT ALLOWED
2090-SCVG150-0	150, (5904)	3.90	NOT ALLOWED
2090-SCVG200-0	200, (7872)	3.90	NOT ALLOWED

Plastic Fiber Optic Cable Attenuation Limits

Plastic Fiber (POF) Attenuation Calculations:

POF Attenuation = Cable Loss + Connector Loss + Finishing Tolerance

POF Attenuation = (0.19dB/m * Length) + 1.5dB + 0.5dB

Catalog Number	Length meters, (inches)	Maximum Attenuation (dB)	Maximum Attenuation With Bulkhead Conn.
2090-SCEP0-1	0.1, (4)	2.02	5.02
2090-SCEP0-2	0.2, (7)	2.04	5.04
2090-SCEP0-3	0.3, (12)	2.06	5.06
2090-SCEP1-0	1, (39)	2.19	5.19
2090-SCEP3-0	3, (118)	2.57	5.57
2090-SCEP5-0	5, (197)	2.95	5.95
2090-SCEP8-0	8, (315)	3.52	6.52
2090-SCEP10-0	10, (394)	3.90	6.90
2090-SCEP15-0	15, (591)	4.85	7.85
2090-SCEP20-0	20, (787)	5.80	8.80
2090-SCEP25-0	25, (984)	6.75	9.75
2090-SCEP32-0	32, (1260)	8.08	11.08

Catalog Number	Length meters, (inches)	Maximum Attenuation (dB)	Maximum Attenuation With Bulkhead Conn.
2090-SCNP0-1	0.1, (4)	2.02	5.02
2090-SCNP0-3	0.3, (12)	2.06	5.06
2090-SCNP0-9	0.9, (35)	2.17	5.17
2090-SCNP1-0	1, (39)	2.19	5.19
2090-SCNP3-0	3, (118)	2.57	5.57
2090-SCNP5-0	5, (197)	2.95	5.95
2090-SCNP8-0	8, (315)	3.52	6.52
2090-SCNP10-0	10, (394)	3.90	6.90
2090-SCNP15-0	15, (591)	4.85	7.85
2090-SCNP20-0	20, (787)	5.80	8.80
2090-SCNP25-0	25, (984)	6.75	9.75
2090-SCNP32-0	32, (1260)	8.08	11.08

Catalog Number	Length meters, (inches)	Maximum Attenuation (dB)	Maximum Attenuation With Bulkhead Conn.
2090-SCVP0-1	0.1, (4)	2.02	5.02
2090-SCVP0-3	0.3, (12)	2.06	5.06
2090-SCVP0-9	0.9, (35)	2.17	5.17
2090-SCVP1-0	1, (39)	2.19	5.19
2090-SCVP3-0	3, (118)	2.57	5.57
2090-SCVP5-0	5, (197)	2.95	5.95
2090-SCVP8-0	8, (315)	3.52	6.52
2090-SCVP10-0	10, (394)	3.90	6.90
2090-SCVP15-0	15, (591)	4.85	7.85
2090-SCVP20-0	20, (787)	5.80	8.80
2090-SCVP25-0	25, (984)	6.75	9.75
2090-SCVP32-0	32, (1260)	8.08	11.08

SERCOS Attenuation Limits

The SERCOS standard defines different allowable attenuation losses for both Plastic and Hard Clad Silica fiber optic cables. The differences for the two types of fiber are due to the drive characteristics of the transmitters into the different diameters of POF and HCS cables.

The fiber optic transmitter power is measured using a 1-meter length reference standard cable to an optometer. SERCOS has system attenuation limits, which are governed by the minimum light power required for proper operation of the receiver. SERCOS generally includes a bulkhead connector in the transmitter to receiver path. The table below shows these limits.

SERCOS System Optical Transmission line Specifications @ 650nm

Continuous Light ON	Plastic Optical Fiber (POF)	Glass Optical Fiber (HCS)
Transmitter Min Power	-7.5 dBm (uW)	-18 dBm (uW)
Transmitter Max Power	-3.5 dBm (uW)	-10 dBm (uW)
Receiver Min Power	-20 dBm (uW)	-22 dBm (uW)
Receiver Max Power	-5.0 dBm (uW)	-7.0 dBm (uW)
System Attenuation limit	POF Cable \geq 29.6 m	HCS Cable \geq 200 m
Max point to point attenuation	12.5 dB	4.0 dB

System Field Testing Overview

The total point to point attenuation should never exceed 12.5dB for POF and 4dB for HCS cables. Field testing cables as installed is accomplished in much the same manner as tests described in section 1. Field-testing requires verification of transmitter light power output and receiver input power. Cables may have more attenuation after installation due to bending encountered by the installed path.

System Field Testing Verify Transmitter Output Power

Verify transmitter power as outlined below:

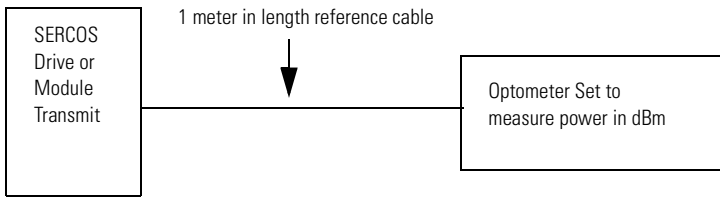

Figure 10 Field Testing Transmitter Output Power

1. Inspect and clean the ends of the reference cable.
2. Put the Source into Continuous light mode. High power output.
3. Turn on optometer and select appropriate wavelength.
4. Put the meter into the absolute power measurement mode(-dBm)
5. Securely connect appropriate reference cable corresponding to the type of cable to be tested.
 - POF reference cable used for testing POF cable
 - HCS reference cable used for testing HCS cable
6. Read the value off the meter.
7. Verify that the power out put of the transmitter is within the range specified in the SERCOS attenuation table.

System Field Testing Verify Receiver Power

Verify receiver power as outlined below:

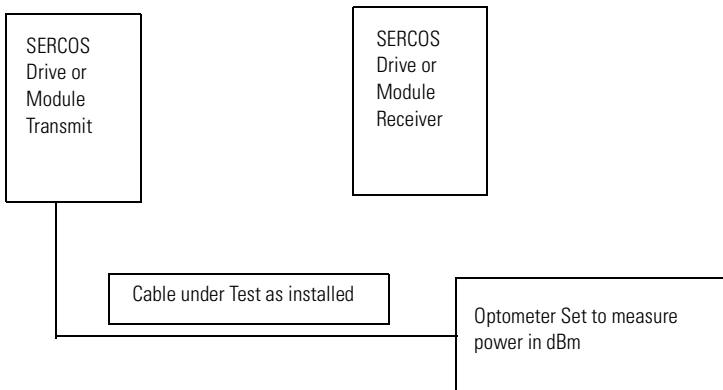

Figure 11 Field Testing Receiver Power

1. Inspect and clean the ends of the cable under test.
2. Disconnect the cable to be tested from the receiver of the Drive or module.
3. Put the Source into Continuous light mode. High power output.
4. Turn on optometer and select appropriate wavelength.
5. Put the meter into the absolute power measurement mode(-dBm)
6. Securely connect appropriate reference cable corresponding to the type of cable to be tested.
 - POF reference cable used for testing POF cable
 - HCS reference cable used for testing HCS cable
7. Read the value off the meter.
8. Verify that the power is within the range specified for a receiver in the SERCOS attenuation table.

Configuring Light Source

Configure test module as test light source

1. Plug module into ControlLogix rack
2. Set desired light power. Switch up for hi power output. Switch down for low power output.

Configure Ultra3000™ drive as test light source

1. Set baudrate rotary switch to the 9:00 position to enable continuous light output mode.
2. Power up the drive

The drive is outputting in continuous light mode at maximum output power.

Configure Kinetix™ family drive as test light source

1. Set DIP switch 1 to proper position to enable high power output. (See drive user manual for proper position).
2. Connect a computer to the Drive via a serial port and anaconda.
3. Use drive explorer software to set IDN701 to a value of 91 to enable continuous light output mode.

The drive remains in this mode until power is cycled.

Measurement using general purpose LED source.

Physical Test Mode for Connections

Purpose

The Physical Test Mode lets you to test and diagnose the condition of the fiber optical connections to the SERCOS interface™ module.

Description

SERCOS is a real-time optical serial interface between the control unit and its associated drives to transmit periodic and non-periodic data. The module provides three tri-color LED indicators to show the state of the system. The LEDs are located on the bezel of the module. These LEDs display a variety of orange patterns for Physical Test Mode diagnostics.

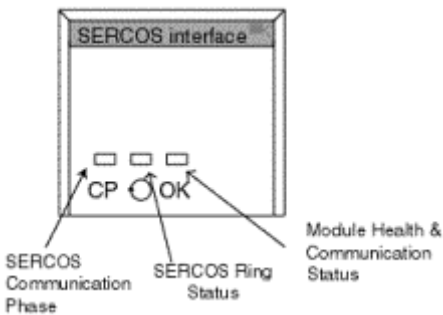

Figure 12 1756-MxxSE Motion Module Bezel Showing LED Locations

The table below offers an explanation of the OK indicator.

If the OK indicator displays:	The module status is:
Flashing orange light	Physical Test Mode is active.

The table below offers an explanation of the SERCOS ring indicator.

If the SERCOS ring indicator displays:	The module status is:
Solid orange light	Continuous light is active.
Flashing orange light	Zero bit stream is active.

The table below offers an explanation of the CP indicator.

If the CP indicator displays:	The module status is:
Flashing fast orange light	Hi power is active.
Flashing slow orange light	Low power is active.

To facilitate testing of fiber optical connections, a test mode via CIP Generic Message Type to the SERCOS Axis object can be configured. This test mode lets you set hi and low optical power, continuous light and zero bit stream test modes. This service closes all connections upon execution, which shuts down motion. It is recommended that all motion be shut down prior to executing this instruction. The SERCOS fiber transmit cable should also be disconnected from the module in preparation for attachment of optical test equipment.

ATTENTION

The Module Must be Reset/RIUP (Removed & Inserted Under Power) to cancel the test function.



To perform the test you must add an MSG instruction to your ladder logic. The MSG instruction is accessible from the Input/Output selection.



Figure 13 MSG Instruction from Input/Output Tab

Click on the MSG button to insert the instruction on the desired rung.

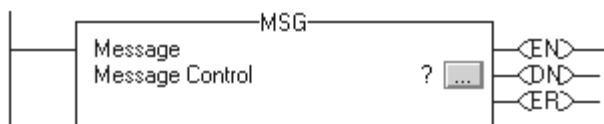

Figure 14 MSG Instruction Faceplate

Right mouse click on the Message Control operand field and select New Tag. Enter a name for the tag and make sure Message is the value in the Data Type field. It should default to Message. If not, click on the ellipsis button and select Message from the list. From here you can either click on the Configure button to reach the Message configuration screen or press the OK button. If you press the OK button, you must then click on the ellipsis button next to the Message Control field.

Message Instruction Settings

The Message Configuration Screen has three tabs: Configuration, Communication and Tag. This is where you set the values for the test.

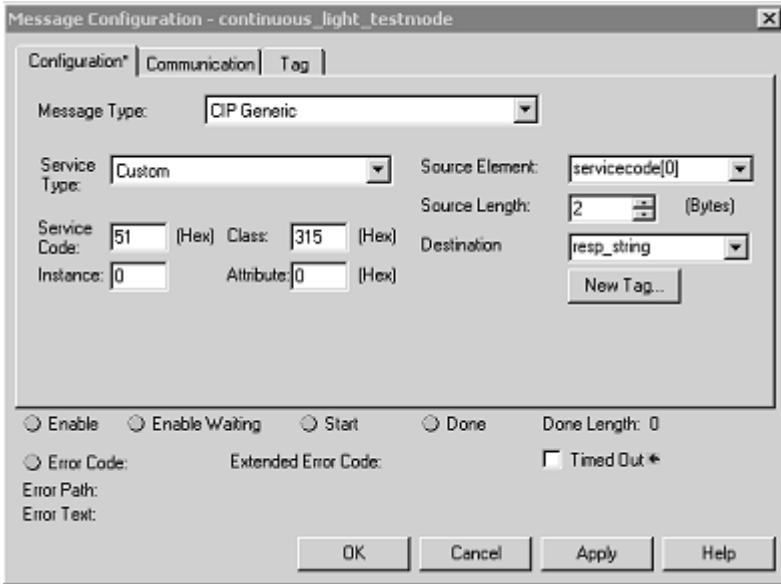

Figure 15 Message Configuration Tab

Enter the following values for the fields on the Configuration Tab screen.

Message Type: CIP generic

Service Type: Custom

Service Code: 51 hex.

Class: 315 hex.

Instance: 0

Attribute: 0.

Source Element: The Source Element must be an INT array of 1. The first element of the array needs to be set to the value of the desired test mode.

Servicecode[0] = Value set to desired Physical testmode

- 0 = Set Continuous Light
- 1 = Set Zero Bit Stream
- 2 = Set High transmission power level
- 3 = Set Low transmission power level

Source Length: must be set to 2 bytes.

Destination Field: The *resp_string* must be set to a INT array of 1. There is no response specific data for this instruction.

Message Instruction Communications Tab

Click on the Communication Tab to access the Message Instruction Communication screen.

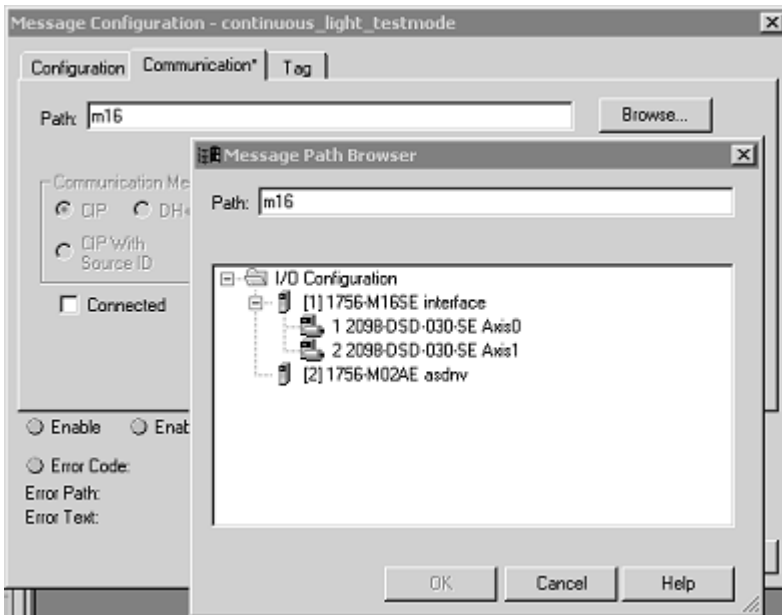

Figure 16 Message Communication Screen

At this screen you set the path to the module. Use the browse button to find the module then set the Path to the module.

Message Instruction Tag Tab

Click on the Tag Tab to access the Message Instruction Tag screen.

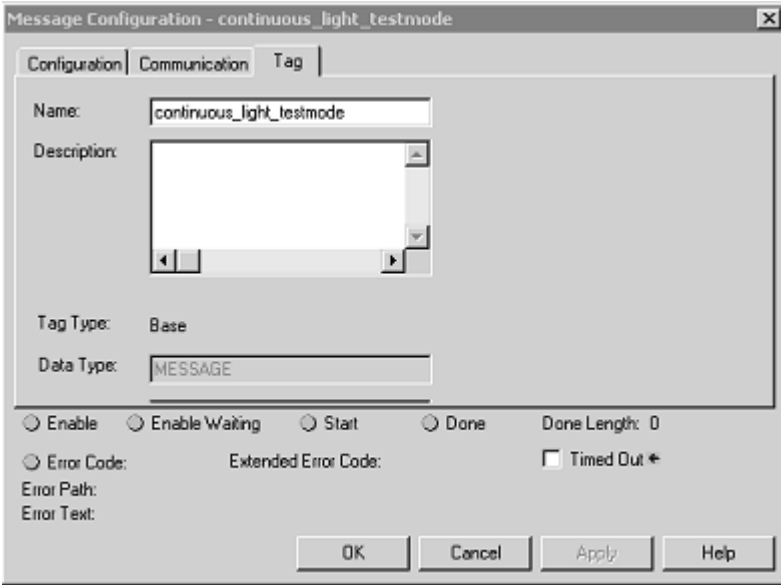

Figure 17 Message Tag Screen

Accept the CIP message instruction defaults.

The following example sets the Continuous Light test mode for attenuation testing.

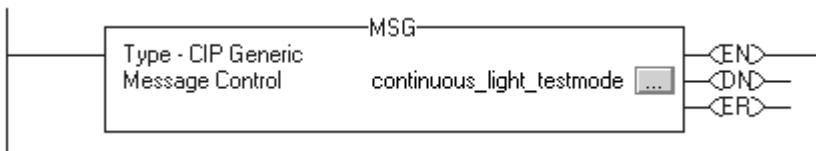

Figure 18 Ladder Diagram of MSG Instruction

Check the LED display to verify instruction execution.

Fiber Optic Cable Specifications

Hard Clad Silica Glass Fiber Optic Cable Mechanical Limits

Catalog Number	Length meters, (inches)	Long Term Bend Radius No Load mm (in.)	Maximum Tensile Load Newtons (Lbs.)	Impact	Twist (times)
2090-SCVG50-0	50, (1970)	30 (1.2)	<98 (22)	490 N/5 cm	Avoid*
2090-SCVG100-0	100, (3937)	30 (1.2)	<98 (22)	490 N/5 cm	Avoid*
2090-SCVG150-0	150, (5905)	30 (1.2)	<98 (22)	490 N/5 cm	Avoid*
2090-SCVG200-0	200, (7874)	30 (1.2)	<98 (22)	490 N/5 cm	Avoid*

*Highly susceptible to fracture under twisting load.

Plastic Fiber Optic Cable Mechanical Limits

Catalog Number	Length meters, (inches)	Long Term Bend Radius No Load mm (in.)	Maximum Tensile Load Newtons (Lbs.)	Impact	Twist (times)
2090-SCEP0-1	0.1, (4)	25.4 (1.0)	< 70 (15)	0.4 N·m	5
2090-SCEP0-3	0.3, (12)	25.4 (1.0)	< 70 (15)	0.4 N·m	5
2090-SCEP0-9	0.9, (35)	25.4 (1.0)	< 70 (15)	0.4 N·m	5
2090-SCEP1-0	1, (39)	25.4 (1.0)	< 70 (15)	0.4 N·m	5
2090-SCEP3-0	3, (118)	25.4 (1.0)	< 70 (15)	0.4 N·m	5
2090-SCEP5-0	5, (197)	25.4 (1.0)	< 70 (15)	0.4 N·m	5
2090-SCEP8-0	8, (315)	25.4 (1.0)	< 70 (15)	0.4 N·m	5
2090-SCEP10-0	10, (394)	25.4 (1.0)	< 70 (15)	0.4 N·m	5
2090-SCEP15-0	15, (591)	25.4 (1.0)	< 70 (15)	0.4 N·m	5
2090-SCEP20-0	20, (787)	25.4 (1.0)	< 70 (15)	0.4 N·m	5
2090-SCEP25-0	25, (984)	25.4 (1.0)	< 70 (15)	0.4 N·m	5

Catalog Number	Length meters, (inches)	Long Term Bend Radius No Load mm (in.)	Maximum Tensile Load Newtons (Lbs.)	Impact	Twist (times)
2090-SCEP32-0	32, (1260)	25.4 (1.0)	< 70 (15)	0.4 N·m	5
2090-SCNP0-1	0.1, (4)	25.4 (1.0)	< 70 (15)	0.4 N·m	5
2090-SCNP0-3	0.3, (12)	25.4 (1.0)	< 70 (15)	0.4 N·m	5
2090-SCNP0-9	0.9, (35)	25.4 (1.0)	< 70 (15)	0.4 N·m	5
2090-SCNP1-0	1, (39)	25.4 (1.0)	< 70 (15)	0.4 N·m	5
2090-SCNP3-0	3, (118)	25.4 (1.0)	< 70 (15)	0.4 N·m	5
2090-SCNP5-0	5, (197)	25.4 (1.0)	< 70 (15)	0.4 N·m	5
2090-SCNP8-0	8, (315)	25.4 (1.0)	< 70 (15)	0.4 N·m	5
2090-SCNP10-0	10, (394)	25.4 (1.0)	< 70 (15)	0.4 N·m	5
2090-SCNP15-0	15, (591)	25.4 (1.0)	< 70 (15)	0.4 N·m	5
2090-SCNP20-0	20, (787)	25.4 (1.0)	< 70 (15)	0.4 N·m	5
2090-SCNP25-0	25, (984)	25.4 (1.0)	< 70 (15)	0.4 N·m	5
2090-SCNP32-0	32, (1260)	25.4 (1.0)	< 70 (15)	0.4 N·m	5
2090-SCVP0-1	0.1, (4)	40.0 (1.6)	< 245 (55)	0.4 N·m	5
2090-SCVP0-3	0.3, (12)	40.0 (1.6)	< 245 (55)	0.4 N·m	5
2090-SCVP0-9	0.9, (35)	40.0 (1.6)	< 245 (55)	0.4 N·m	5
2090-SCVP1-0	1, (39)	40.0 (1.6)	< 245 (55)	0.4 N·m	5
2090-SCVP3-0	3, (118)	40.0 (1.6)	< 245 (55)	0.4 N·m	5
2090-SCVP5-0	5, (197)	40.0 (1.6)	< 245 (55)	0.4 N·m	5
2090-SCVP8-0	8, (315)	40.0 (1.6)	< 245 (55)	0.4 N·m	5
2090-SCVP10-0	10, (394)	40.0 (1.6)	< 245 (55)	0.4 N·m	5
2090-SCVP15-0	15, (591)	40.0 (1.6)	< 245 (55)	0.4 N·m	5

Catalog Number	Length meters, (inches)	Long Term Bend Radius No Load mm (in.)	Maximum Tensile Load Newtons (Lbs.)	Impact	Twist (times)
2090-SCVP20-0	20, (787)	40.0 (1.6)	< 245 (55)	0.4 N·m	5
2090-SCVP25-0	25, (984)	40.0 (1.6)	< 245 (55)	0.4 N·m	5
2090-SCVP32-0	32, (1260)	40.0 (1.6)	< 245 (55)	0.4 N·m	5

Rockwell Automation Support

Rockwell Automation provides technical information on the web to assist you in using our products. At <http://support.rockwellautomation.com>, you can find technical manuals, a knowledge base of FAQs, technical and application notes, sample code and links to software service packs, and a MySupport feature that you can customize to make the best use of these tools.

For an additional level of technical phone support for installation, configuration and troubleshooting, we offer TechConnect Support programs. For more information, contact your local distributor or Rockwell Automation representative, or visit <http://support.rockwellautomation.com>.

Installation Assistance

If you experience a problem with a hardware module within the first 24 hours of installation, please review the information that's contained in this manual. You can also contact a special Customer Support number for initial help in getting your module up and running:

United States	1.440.646.3223 Monday – Friday, 8am – 5pm EST
Outside United States	Please contact your local Rockwell Automation representative for any technical support issues.

On-Line Documentation

Documentation for Rockwell Automation products can be downloaded free of charge in pdf format from: <http://literature.rockwellautomation.com>

Ultra3000 and Kinetix are trademarks of Rockwell Automation.

www.rockwellautomation.com

Power, Control and Information Solutions Headquarters

Americas: Rockwell Automation, 1201 South Second Street, Milwaukee, WI 53204-2496 USA, Tel: (1) 414.382.2000, Fax: (1) 414.382.4444
Europe/Middle East/Africa: Rockwell Automation, Vorstlaan/Boulevard du Souverain 36, 1170 Brussels, Belgium, Tel: (32) 2 663 0600, Fax: (32) 2 663 0640
Asia Pacific: Rockwell Automation, Level 14, Core F, Cyberport 3, 100 Cyberport Road, Hong Kong, Tel: (852) 2887 4788, Fax: (852) 2508 1846

Publication 2090-IN010C-EN-P – April 2005

PN 321174-P03

Supersedes publication 2090-IN010A-EN-P – March 2004

Copyright © 2004 Rockwell Automation, Inc. All rights reserved. Printed in the U.S.A.