

MB 33 0780 GB



Lenze

Antriebstechnik

Service instructions

Inverter drives
Range 630

Lenze

Antriebstechnik GmbH
A 4470 Enns, Mühlenstr. 3
Österreich Telefon 07223/34 21-0
Telex 02-291 66 len a Telefax 07223/32 80

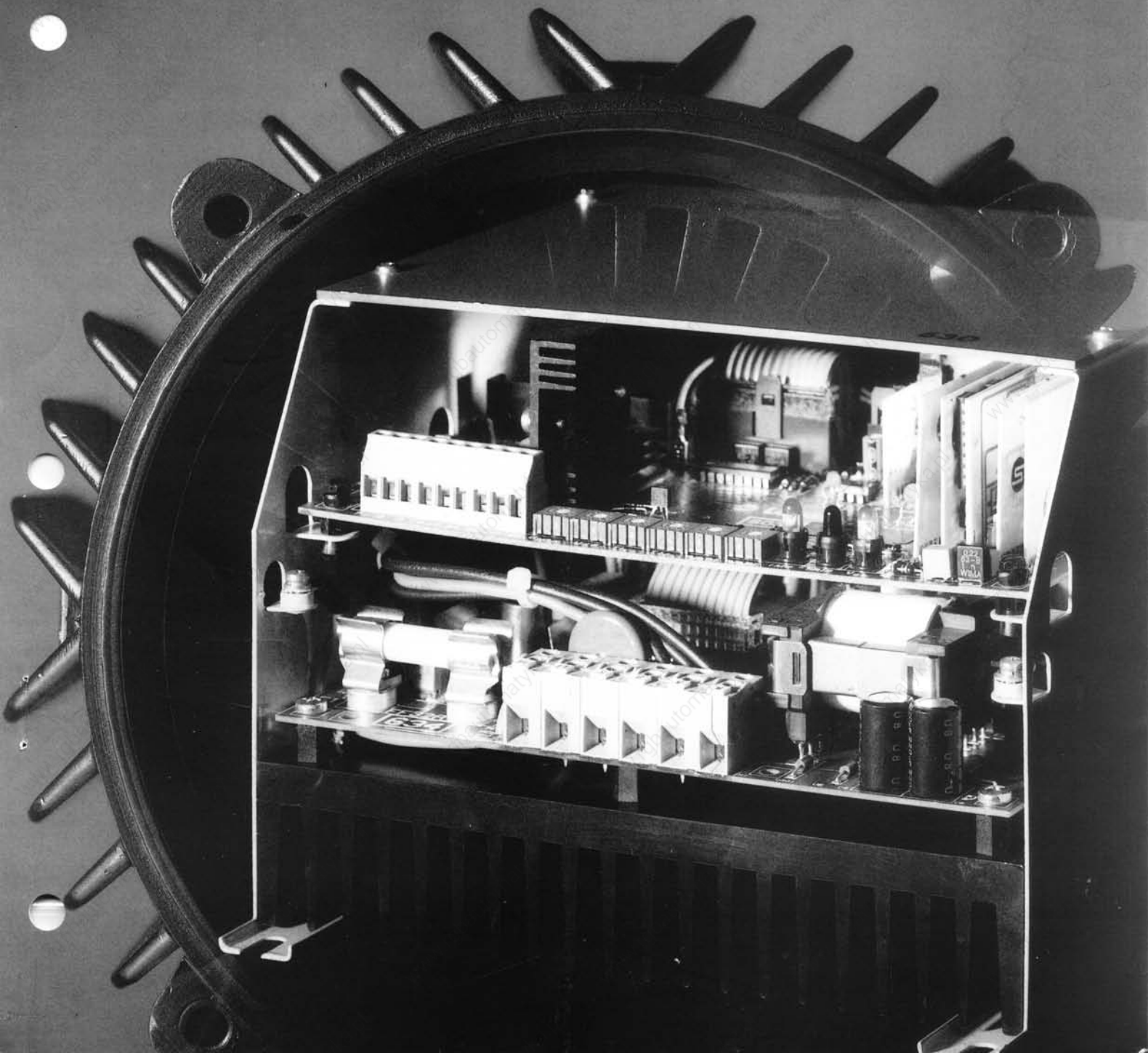

26.10.1989

Table of contents

page

1.	General information	2
2.	Technical data, fuses, mains chokes	2 - 3
3.	Block diagram 631 - 634	4
3.1	Block diagram 6031 control stage	5
3.2	Block diagram 630 power stage	6
4.	Trimmers, display of operational status	7
5.	Connecting plan	7
6.	Overall connecting plans	8 - 11
6.1	Overall connecting plan 631	8
6.2	Overall connecting plan 632	9
6.3	Overall connecting plan 633	10
6.4	Overall connecting plan 634	11
7.	Fault finding instructions	12 - 13
8.	Checking the power stage	14
8.1	Mains rectifier	14
8.2	Inverter	15
8.3	DC link capacitors	15
8.4	Relay, switch-on resistor	16
9.	List of units, components, hybrids	17
10.	Fitted components	18
10.1	Analog integrated circuits	18
10.2	Discrete small power semiconductors	18 - 20
10.3	Hybrids	20 - 26
10.4	Power semiconductors	27 - 33

1. General information



Caution: The modules are fitted with C-MOS and MOS components which are sensitive against electrostatic influences

Please note the following information, when the controller is handled and checked; otherwise these circuits may be destroyed.

- Make sure that there is a potential compensation (charge accumulation between controller, tools, measuring instruments, and personnel before servicing.
- The modules must be touched at the edges, never at the components and their connections.
- Caution: Controller is carrying mains potential up to 20s after switching-off
- The phase current should be measured with a moving iron instrument and the voltage with a moving coil instrument.

2. Technical data

Type		631	632	633	634
Output power	S/kVA	1.3	1.5	2.6	3.6
Rated motor power	P/kW	0.55	0.75	1.5	2.2
Mains voltage	$U_{\text{mains}}/\text{V}$	L_1N 190 - 260 $\pm 0\%$ 50 - 60			
Rated mains current	$I_{\text{mains}}/\text{A}$	7.0	9.0	15.0	17.0
Output voltage	$U_{\text{phase}}/\text{V}$	3 x 0 ... U_{mains}			
Rated output current	I_N/A	3.4	4.0	7.0	9.5
Max. unit current	I_{max}/A	5.4	6.4	11.2	15.0
Power loss $f_d=50\text{Hz}$, $I=I_N$	P_V/W	50	70	90	150
Output frequency	f_d/Hz	0 ... 110			
Master voltage	U_{LN}/V	0 ... 10			
Master current	I_{LN}/mA	0 .. 20 or 4 ... 20			
Ambient temperature	$T_u/^\circ\text{C}$	0 ... 45			
Dimensions	HxBxD mm	155 x 202 x 230			
Weight	kg	2.2	2.9	4.0	4.0

Fuses, mains chokes

	631	632	633	634
Mains fuses F1 Part no.	FF12.5A 6.3x32 324 808	FF16A 6.3x32 305 725	FF25A 10x38 307 308	FF30A 10x38 321 554
Control fuse F2 Part no.	F1A 5x20 321 660			
Mains chokes Part no.	5mH, 9A 323 330	5mH, 9A 323 330	3.5mH, 14A 323 331	1.6mH, 17A 323 361
Controller part no.	326 442	326 443	326 444	326 445

3. Block diagram 631 - 634

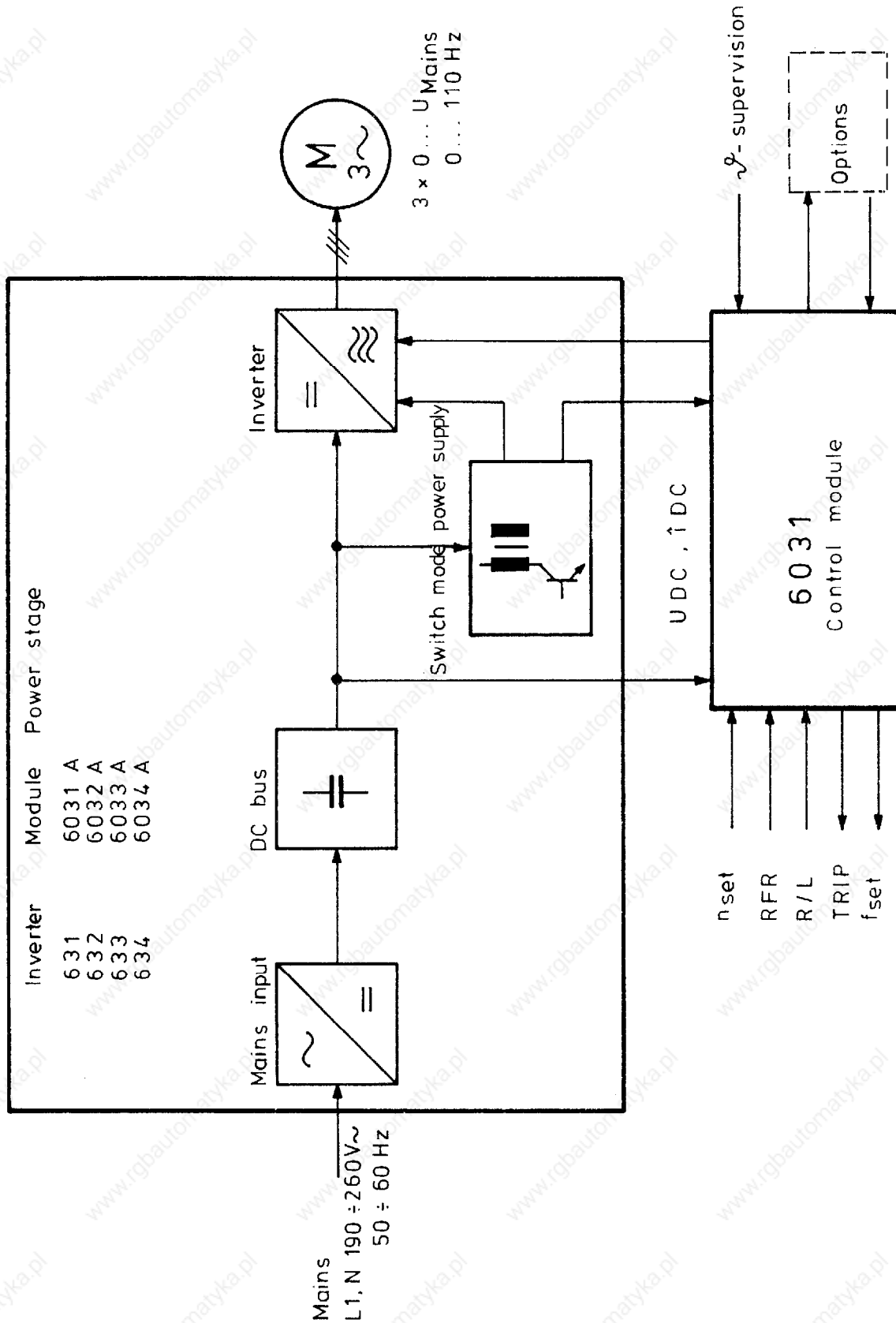

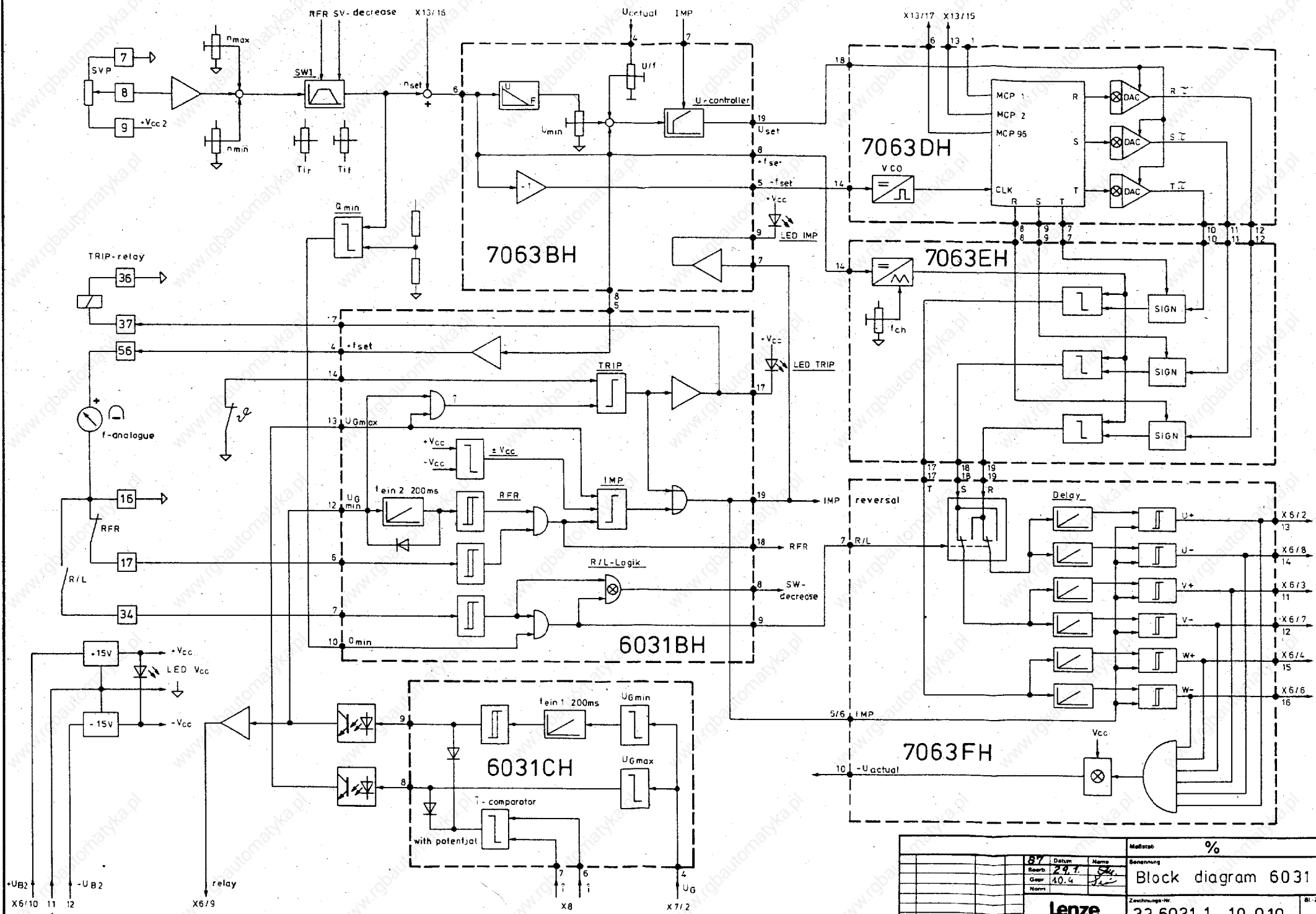

BY		Datum		Name		Maßstab		%	
Gez.		24.7.		S		Benennung		Block diagram 6031	
Norm		40.4		S		Zeichnungs-Nr.		33.6031.1-10.010	
Lenze						Bl.-Zahl		Bl.	

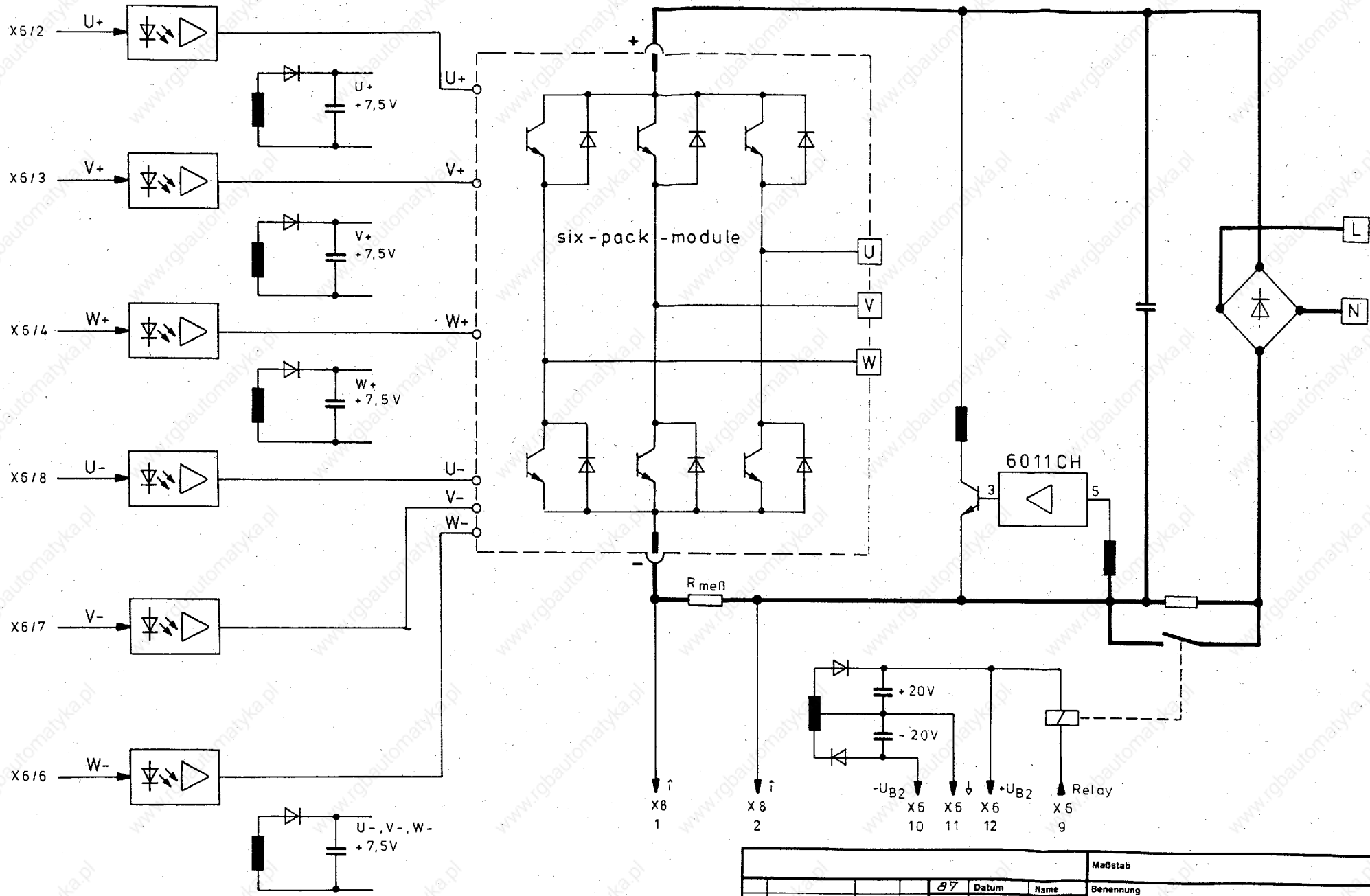

				Maßstab	
				Benennung	
				Block diagram	
				Power stage 630	
				Zeichnungs-Nr.	
				33.630.31 - 10.011	
				Bl.-Zahl	
				Bl.	
				Ers. f.	
				Ers. d.	
				Für diese Zeichnung behalten wir uns alle Rechte vor	
Zust.	Anderung	Datum	Name	Urspr.	

4. Trimmers, display of operational status

Fig. 21

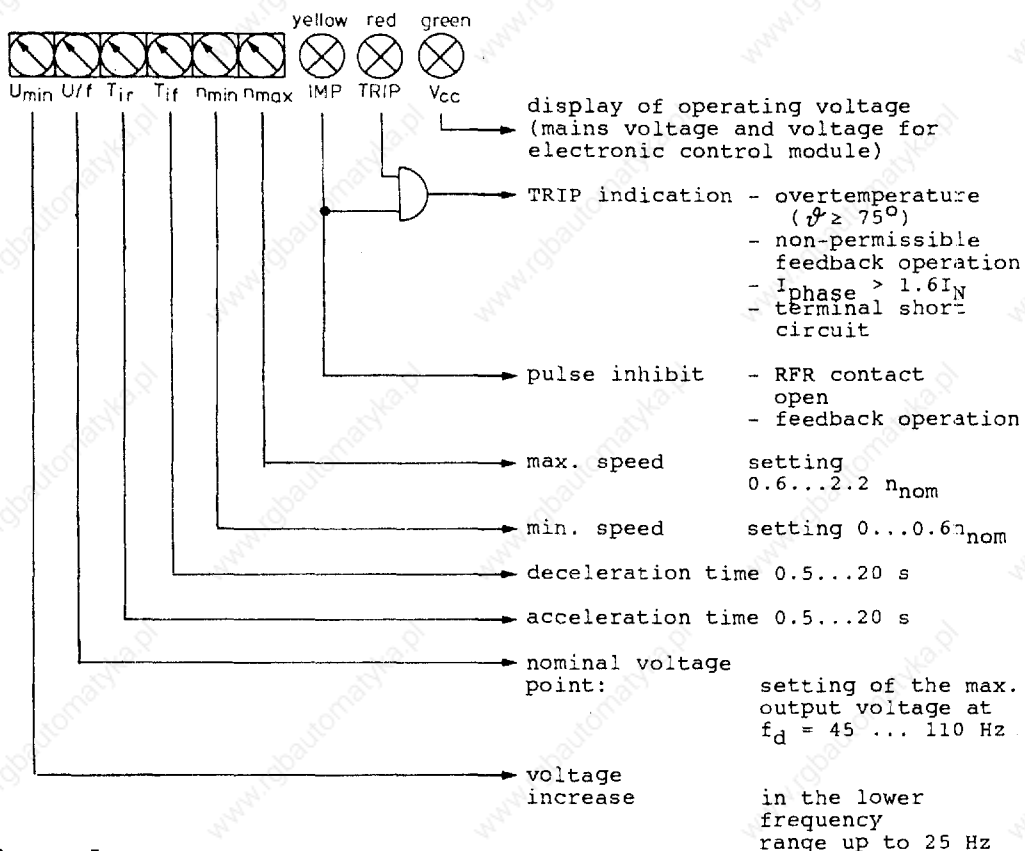

5. Connecting plan

Control module 6031

All control terminals are free of mains potential. Screen control cables. Apply screen on one side of the inverter to PE.

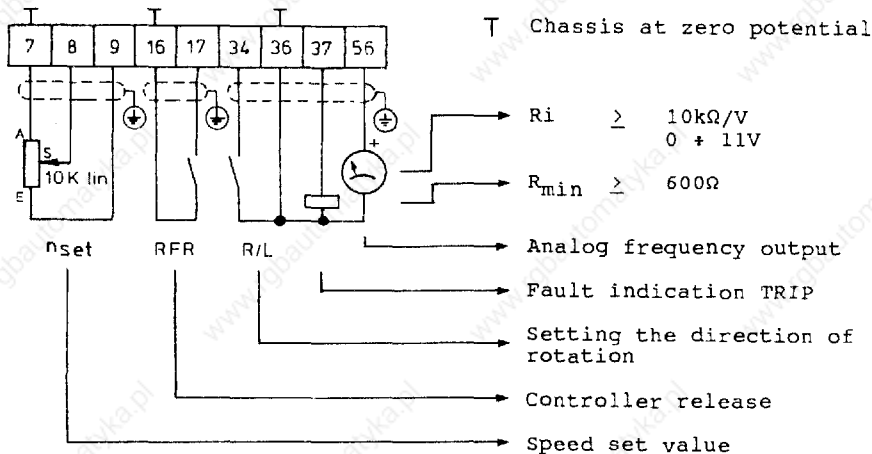

Power stage

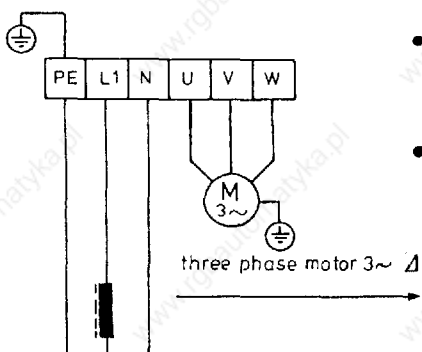

Caution:

- Terminals carry mains potential up to 20 s after switching off
- Do not switch in the motor phases (if necessary, please consult manufacturer)
- Operate unit 634 only with allocated mains choke 1.6mH/17 A, part no: 323 361

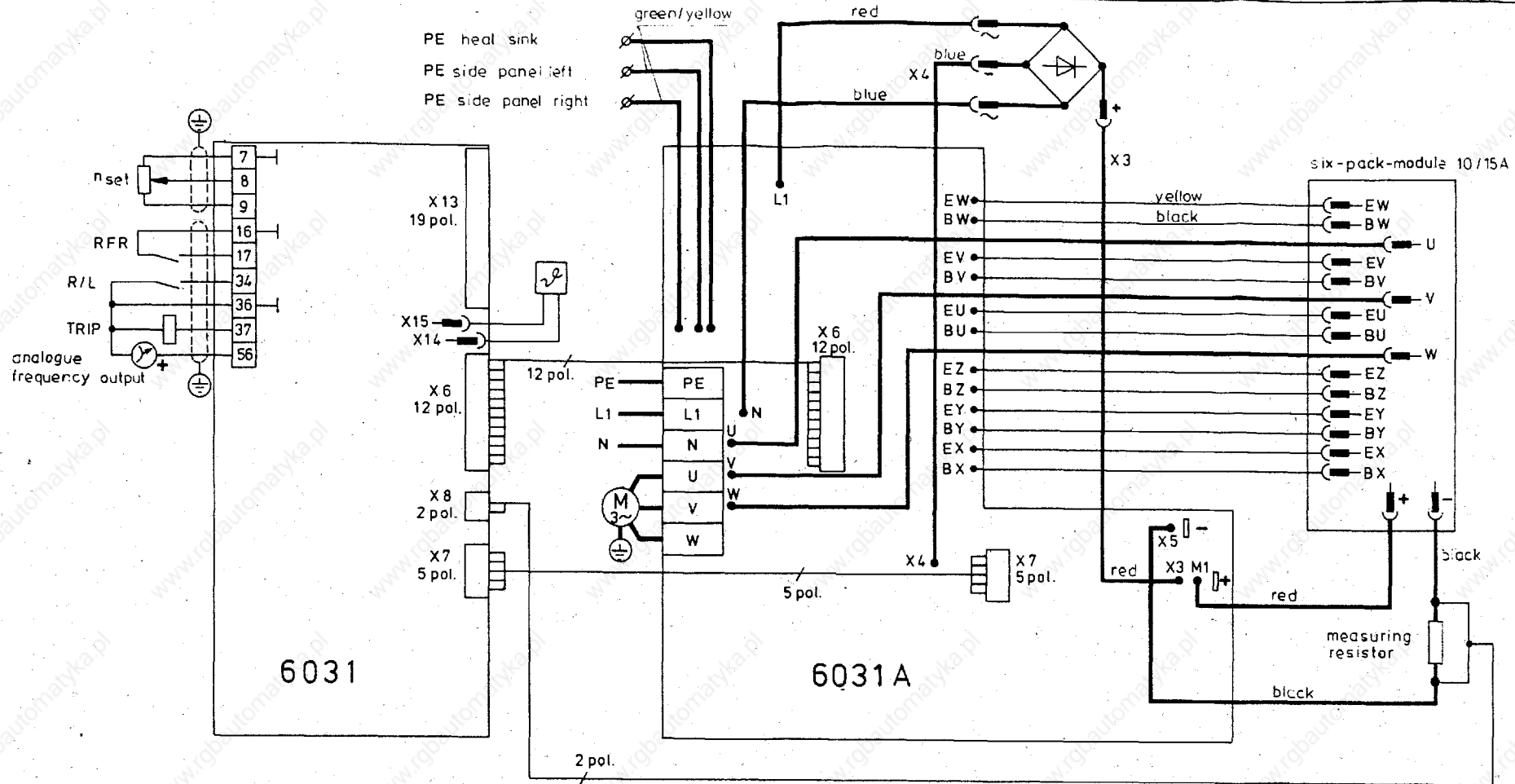

pin	X 13
1	+UB2 ≈ 20V
2	+Vcc2 = 15V
3	GND 2 L
4	-Vcc2 = -15V
5	$Q_{min}, f_{ch} Q_{min} \approx 13V, f < Q_{min} \approx -13V$
6	Uset 0 ÷ 10V
7	fset 0 ÷ 11V
8	nset, ULeit 0 ÷ 11V
9	RFR : L=0V=DN, H=+15V=OFF
10	R/L : R=H=15V, L=L=0V
11	TRIP : L=0V=OFF, H=15V=ON
12	TRIP : L=0V=DN, H=15V=OFF
13	$f_{ch} \approx 350Hz \pm 4KHz$
14	 + 6,5V - 6,5V
15	nset, ULeit 0 ÷ 11V

pin	X 13
16	summation for nset
17	$96 \times f_d \approx 0 \div 10,5 KHz$
18	comp. for SWI +12V acceleration -12V deceleration
19	active L= 0V → WR inhibited H=15V → WR released

pin	X 6
1	opto coupler current U+,V+,W+
2	triggering U+
3	" V+
4	" W+
5	opto coupler current U-,V-,W-
6	triggering U-
7	" V-
8	" W-
9	relay ON = 0V OFF ≈ 20V
10	+UB2 ≈ 20V
11	GND 2 L
12	-UB2 ≈ -20V

pin	X 8
1	Iz DC link current
2	GND 1 L

X 14	OFF ≈ 15V = TRIP ON ≈ 0V
X 15	GND 2 L

pin	X 7
1	GND 1 L
2	Uz ≈ 8,4V
3	+UB1 ≈ 7V
4	GND 1 for 6011CH
5	-U31 ≈ -7,5V

Connections of the modules

name of the connectors on print	EW	BW	EV	BV	EU	BU	EZ	BZ	EY	BY	EX	BX
name on module of Mitsubishi 10A part no. 326530	EwP	BwP	EvP	BvP	EuP	BuP	EwN	BwN	EvN	BvN	EuN	BuN
Toshiba 15A " " 326538	EW	BW	EV	BV	EU	BU	-	BZ	E-	BY	-	BX
Fuji 15A " " 326537	EW	BW	EV	BV	EU	BU	-	BZ	EC	BY	-	BX

- connect spade connectors U, V, W, + and - according to drawing
- spade connectors existing on the module, but not indicated in the drawing are not connected

basic connections

U+ BU → EU	ON	≈ +2,0V
V+ BV → EV	OFF	≈ -1,4V
W+ BW → EW	ON	≈ +2,0V
U- BU → EU	OFF	≈ -1,4V
V- BV → EV	ON	≈ +2,0V
W- BW → EW	OFF	≈ -1,4V
U- BU → EU	ON	≈ +2,0V
V- BV → EV	OFF	≈ -1,4V
W- BW → EW	ON	≈ +2,0V
U- BU → EU	OFF	≈ -1,4V

A7		Datum	Name	Maßstab	%
Beauf.	30.7			Overall connecting plan 631	
Gepr.	11.4				
Lenze				Zuschuss-Nr.	Bl-Zahl
				33.631.33 - 00.001	01

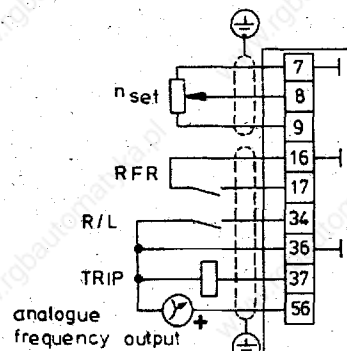

6031

PE heat sink
PE side panel left
PE side panel right

X13
19 pol.

X15
X14

X6
12 pol.

X8
2 pol.

X7
5 pol.

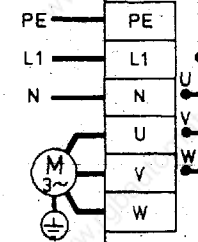

6032A

5 pol.

2 pol.

X6
12 pol.

X7
5 pol.

X3
M1

six-pack-module 15A

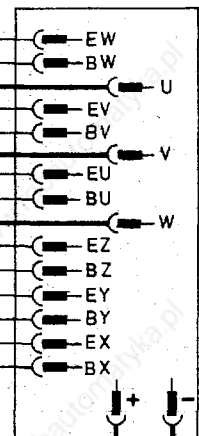

Connections of the modules

name of the connectors on print	EW	BW	EV	BV	EU	BU	EZ	BZ	EY	BY	EX	BX
name on module of	EW	BW	EV	BV	EU	BU	EW	BW	EV	BV	EU	BU
Mitsubishi 15A part no. 326 531	EW	BW	EV	BV	EU	BU	-	BZ	BY	-	BX	-
Toshiba 15A " " 326 538	EW	BW	EV	BV	EU	BU	-	BZ	BY	-	BX	-
Fuji 15A " " 326 537	EW	BW	EV	BV	EU	BU	-	BZ	BY	-	BX	-

- 1 connect spade connectors U, V, W, + and - according to drawing
- 2 spade connectors existing on the module, but not indicated in the drawing are not connected.

basic connections

U+ BU → EU	ON ≈ +2,0V	OFF ≈ -1,4V
V+ BV → EV	ON ≈ +2,0V	OFF ≈ -1,4V
W+ BW → EW	ON ≈ +2,0V	OFF ≈ -1,4V
U- BX → EX	ON ≈ +2,0V	OFF ≈ -1,4V
V- BY → EY	ON ≈ +2,0V	OFF ≈ -1,4V
W- BZ → EZ	ON ≈ +2,0V	OFF ≈ -1,4V



pin	X 13
1	+U _{B2} ≈ 20V
2	+Vcc2 = 15V } total charge
3	GND 2 L } 50mA
4	-Vcc 2 = -15V
5	Q _{min} , I _Q min ≈ 13V, I _Q < Q _{min} ≈ -13V
6	U _{set} 0 ÷ 10V
7	f _{set} 0 ÷ 11V
8	nset, U _{Leit} 0 ÷ 11V
9	RFR : L=0V=ON, H=+15V=OFF
10	R/L : L=0V=ON, H=+15V=OFF
11	R/L : R=H=15V, L=L=0V
12	TRIP : L=0V=OFF, H=15V=ON
13	TRIP : L=0V=ON, H=15V=OFF
14	f _{ch} ≈ 350Hz ÷ 4 KHz +6,5V -6,5V
15	nset ; U _{Leit} 0 ÷ 11V

pin	X 13
16	summation for nset
17	96 x f _g = 0 ÷ 10,5 KHz
18	comp. for SWI +12V acceleration -12V deceleration
19	active L : 0V → WR inhibited H=15V → WR released

pin	X 6
1	opto coupler current U _s , V _s , W _s
2	triggering U _s
3	" V _s
4	" W _s
5	opto coupler current U ₋ , V ₋ , W ₋
6	triggering U ₋
7	" V ₋
8	" W ₋
9	relay ON = 0V OFF ≈ 20V
10	+U _{B2} ≈ 20V
11	GND 2 L
12	-U _{B2} ≈ -20V

pin	X 8
1	I _Z DC link current
2	GND 1 L

X14	OFF ≈ 15V = TRIP ON ≈ 0V
X15	GND 2 L

pin	X 7
1	GND 1 L
2	U _Z ≈ 8,4V
3	+U _{B1} ≈ 7V
4	GND 1 for 6011CH
5	-U _{B1} ≈ -7,5V

Maßstab		%	
07	Datum	Name	Bemerkung
30.7.			
Overall connecting plan 632			
Lenze			Zeichnungs-Nr. 33.632.33 - 00.001
			Bl.-Zahl

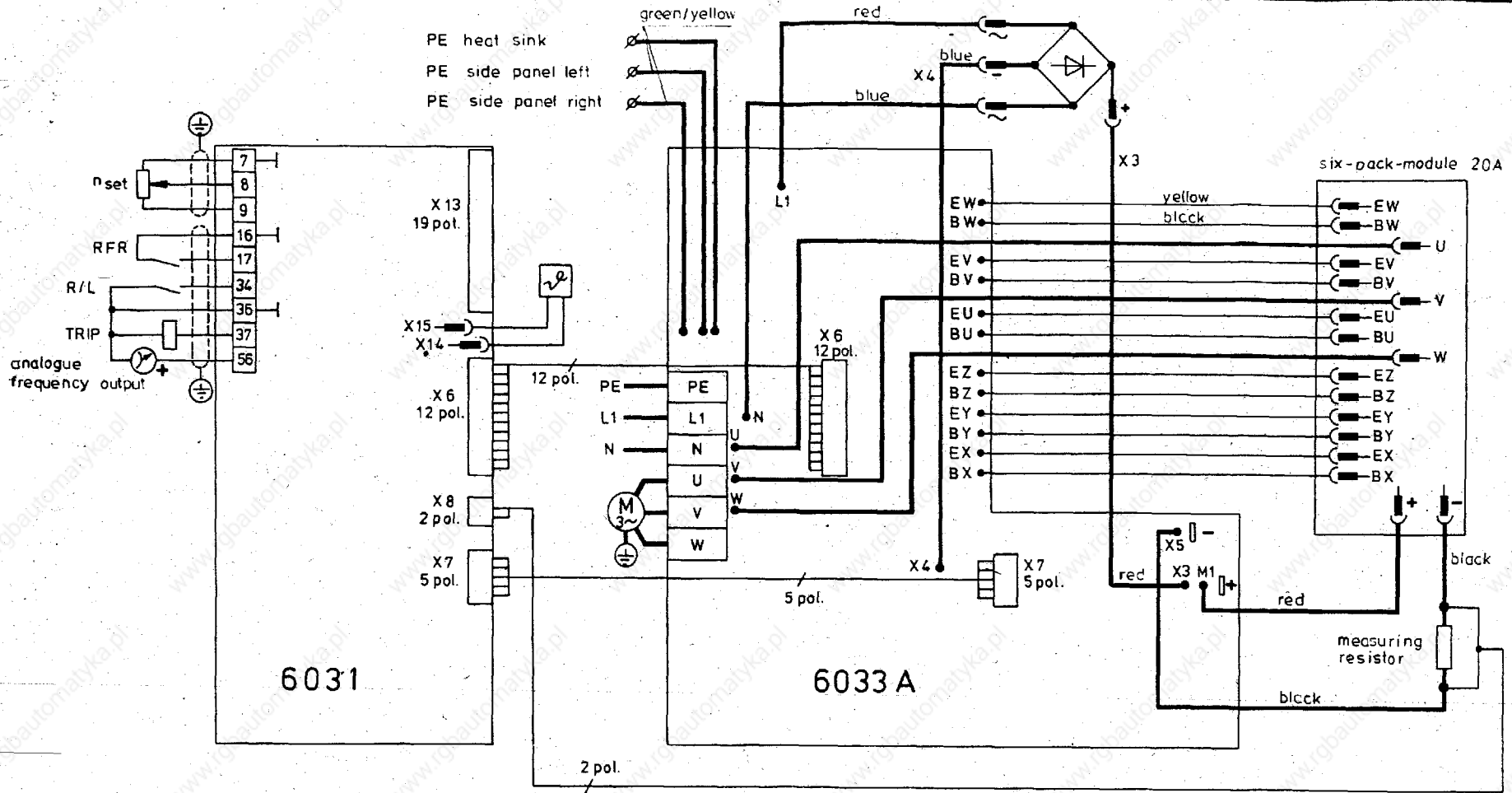

pin	X 13
1	+U _{B2} ≈ 20V
2	+Vcc2 ≈ 15V total charge
3	GND 2 1 50mA
4	-Vcc2 ≈ -15V
5	Q _{min} , f > Q _{min} ≈ 13V, f < Q _{min} ≈ -13V
6	U _{set} 0 ÷ 10V
7	f _{set} 0 ÷ 11V
8	n _{set} , U _{Leit} 0 ÷ 11V
9	RFR: L=0V=ON, H=+15V=OFF
10	IMP: L=0V=ON, H=15V=OFF
11	R/L: R=H=15V, L=L=0V
12	TRIP: L=0V=OFF, H=15V=ON
13	f: L=0V=ON, H=15V=OFF
14	f _{ch} ≈ 350Hz ÷ 4 kHz
	+ 6,5V
	- 6,5V
15	n _{set} ; U _{Leit} 0 ÷ 11V

pin	X 13
16	summation for n _{set}
17	96 x 10 ⁰ ≈ 10,5 KHz
18	comp. for SWI +12V acceleration -12V deceleration
19	active L= 0V → WR inhibited H= 15V → WR released

pin	X 6
1	opto coupler current U ₊ , V ₊ , W ₊
2	triggering U ₊
3	" V ₊
4	" W ₊
5	opto coupler current U ₋ , V ₋ , W ₋
6	triggering U ₋
7	" V ₋
8	" W ₋
9	relay ON = 0V OFF ≈ 20V
10	+U _{B2} ≈ 20V
11	GND 2 1
12	-U _{B2} ≈ -20V

pin	X 8
1	I ₂ DC link current
2	GND 1 1

X 14	OFF ≈ 15V = TRIP ON ≈ 0V
X 15	GND 2 1

pin	X 7
1	GND 1 1
2	U ₂ ≈ 8,4V
3	+U _{B1} ≈ 7V
4	GND 1 for 6011CH
5	-U _{B1} ≈ -7,5V

Connections of the modules

name on print	EW	BW	EV	BV	EU	BU	EZ	BZ	EY	BY	EX	BX
Mitsubishi 20A part no. 326 532	EW	BWP	EvP	BvP	EuP	BuP	EW	B	N	EV	N	UN
Toshiba 20A " " 326 533	EW	BW	EV	BV	EU	BU	-	BZ	E-	BY	-	BX
Fuji 20A " " 326 540	EW	BW	EV	BV	EU	BU	EZ	BZ	EY	BY	EX	BX
Fuji 20A " " 326 539	EW	BW	EV	BV	EU	BU	-	BZ	EC	BY	-	BX

- connect spade connectors U, V, W, + and - according to drawing
- spade connectors existing on the module, but not indicated in the drawing are not connected.

basic connections

U ₊ BU → EU	ON ≈ +2,0V	
	OFF ≈ -1,4V	
V ₊ BV → EV	ON ≈ +2,0V	
	OFF ≈ -1,4V	
W ₊ BW → EW	ON ≈ +2,0V	
	OFF ≈ -1,4V	
U ₋ BU → EX	ON ≈ +2,0V	
	OFF ≈ -1,4V	
V ₋ BV → EY	ON ≈ +2,0V	
	OFF ≈ -1,4V	
W ₋ BZ → EZ	ON ≈ +2,0V	
	OFF ≈ -1,4V	



Date			Name			MeStab			%		
47	30.7.	30.7.	Overall connecting plan 633								
Lenze						Zeichnungs-Nr. 33.633.33 - 00.001					

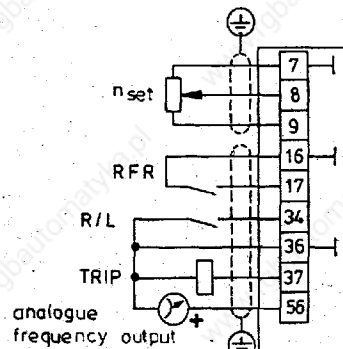

6031

PE heat sink
PE side panel left
PE side panel right

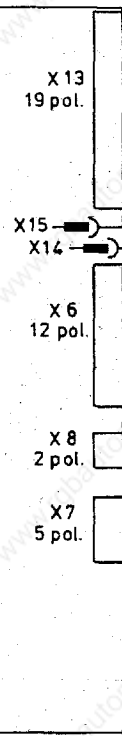

2 pol.

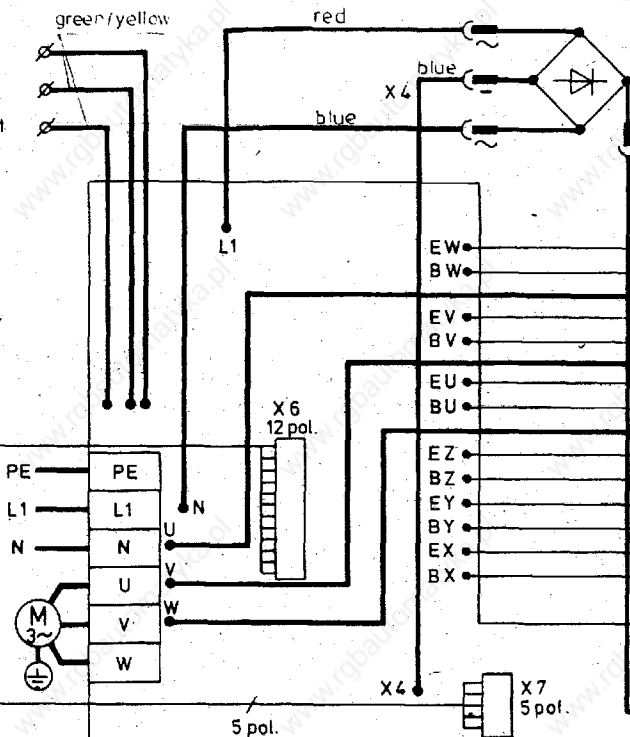

6034A

six-pack-module 30A

pin	X 13
1	+UB2 ≈ 20V
2	+Vcc2 = 15V } total charge
3	GND 2 1 } 50 mA
4	-Vcc2 = -15V
5	Qmin, f > Qmin ≈ 13V, f < Qmin ≈ -13V
6	Uset 0 ÷ 10V
7	fset 0 ÷ 11V
8	nset, ULeit 0 ÷ 11V
9	RFR : L=0V=ON, H=+15V=OFF
10	IMP : L=0V=ON, H=15V=OFF
11	R/L : R=H=15V, L=L=0V
12	TRIP : L=0V=OFF, H=15V=ON
13	⚡ : L=0V=ON, H=15V=OFF
14	fch ≈ 350Hz ± 4 KHz 6.5V 6.5V
15	nset, ULeit 0 ÷ 11V

pin	X 13
16	summation for nset
17	96 x f _d : 0 ÷ 10.5 KHz
18	comp. for SWI +12V acceleration -12V deceleration
19	active L= 0V → WR inhibited H= 15V → WR released

pin	X 6
1	opto coupler current U+,V+,W+
2	triggering U+
3	" V+
4	" W+
5	opto coupler current U-,V-,W-
6	triggering U-
7	" V-
8	" W-
9	relay ON = 0V OFF ≈ 20V
10	+UB2 ≈ 20V
11	GND 2 1
12	-UB2 ≈ -20V

pin	X 8
1	I _z DC link current
2	GND 1 L

pin	X 14
X 14	OFF ≈ 15V = TRIP 0 ÷ ≈ 0V
X 15	GND 2 1

pin	X 7
1	GND 1 L
2	U _z ≈ 8.4V
3	+UB1 ≈ 7V
4	GND 1 for 6011CH
5	-U _{z1} ≈ -7.5V

Connections of the modules

name of the connectors on print	EW	BW	EV	BV	EU	BU	EZ	BZ	EY	BY	EX	BX
Toshiba 30A part-no. 326 534	EW	BW	EV	BV	EU	BU	EZ	BZ	EY	BY	EX	BX
Fuji 30A " " 326541	EW	BW	EV	BV	EU	BU	EZ	BZ	EY	BY	EX	BX

1. connect spade connectors U,V,W,+ and - according to drawing

basic connections

U+	BU → EU	ON ≈ +2,0V	+2V
		OFF ≈ -1,4V	
V+	BV → EV	ON ≈ +2,0V	-1,4V
		OFF ≈ -1,4V	
W+	BW → EW	ON ≈ +2,0V	
		OFF ≈ -1,4V	
U-	BX → EX	ON ≈ +2,0V	
		OFF ≈ -1,4V	
V-	BY → EY	ON ≈ +2,0V	
		OFF ≈ -1,4V	
W-	BZ → EZ	ON ≈ +2,0V	
		OFF ≈ -1,4V	

Masthead				%
Bearb.	Datum	Name	Bewertung	
30.7.				
Overall connecting plan 634				
Zeichnungs-Nr.				
33.634.33 - 00.001				
Bl. Zahl				
Bl.				

Lenze

33.634.33 - 00.001

You find the necessary measurement
() in chapter 8 under "checking the power stage".

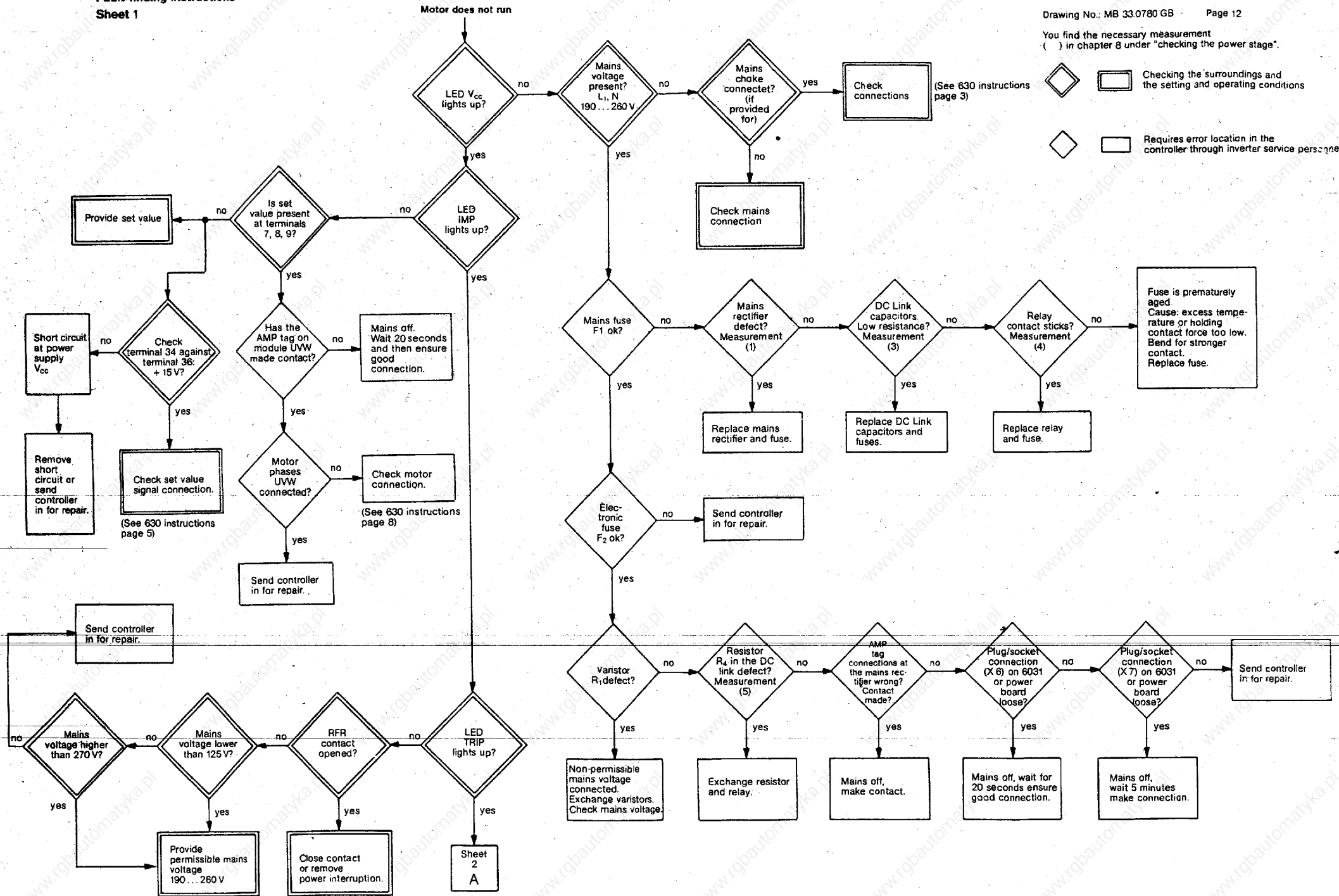
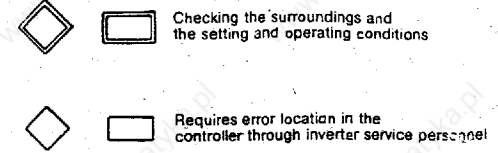

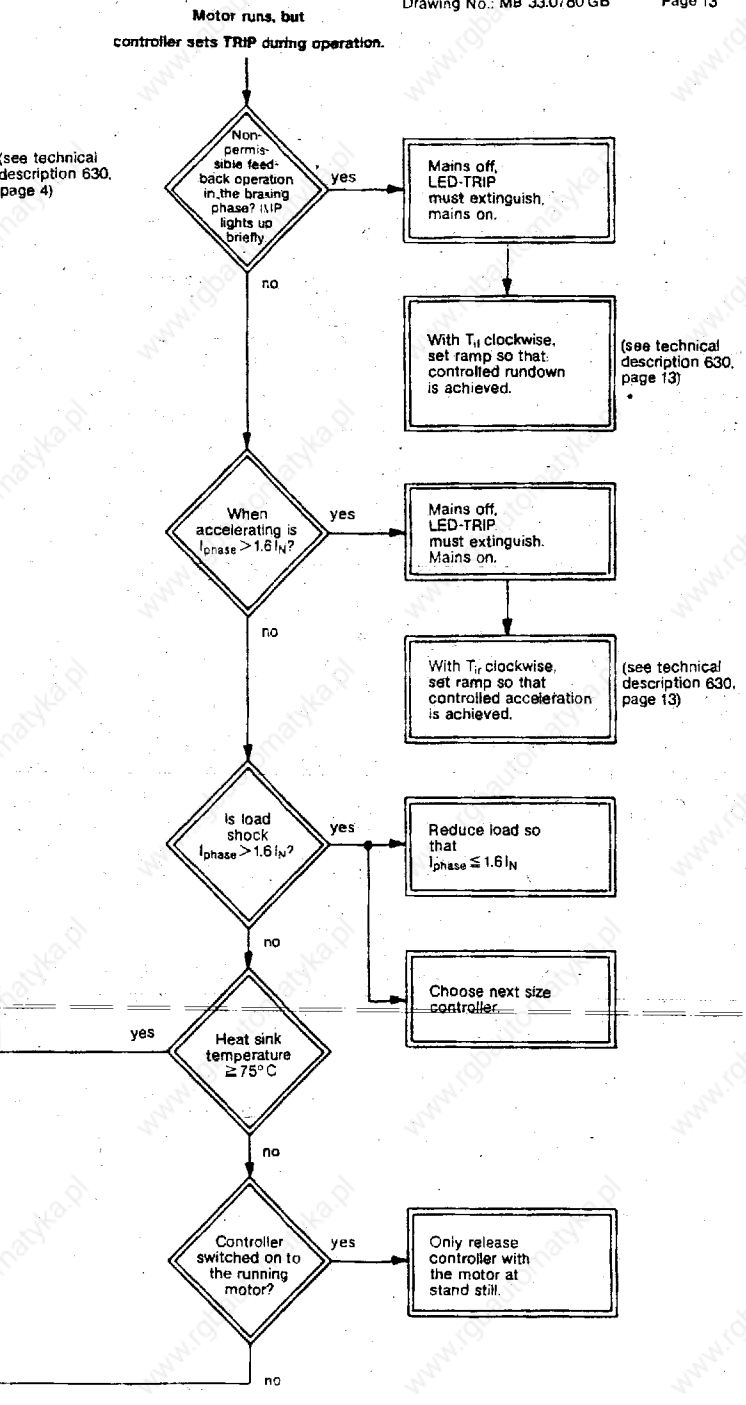
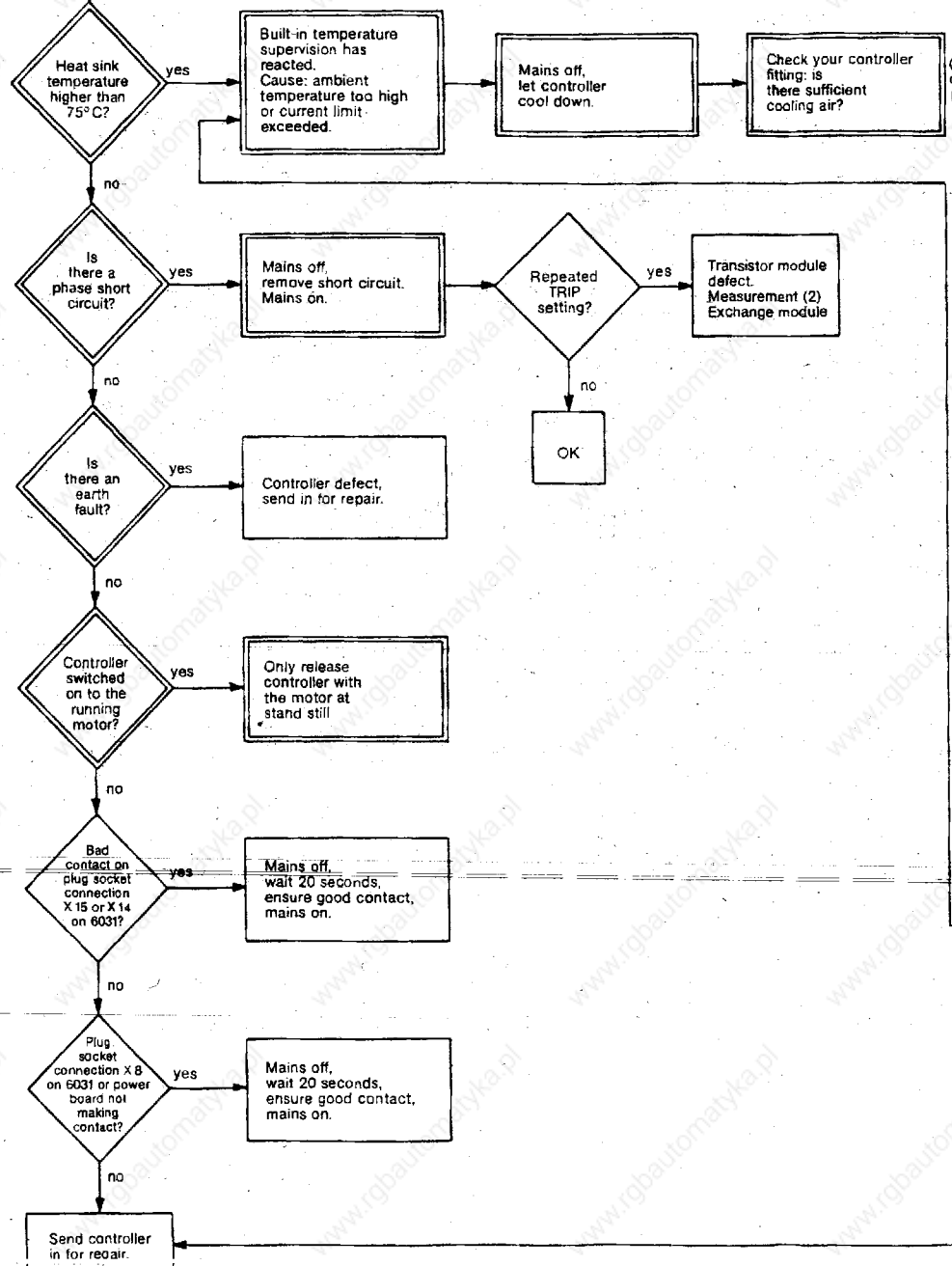

(see technical description 630, page 4)

(see technical description 630, page 13)

(see technical description 630, page 13)

8. Checking the power stage

The power stage was measured with an ohmmeter (analog multiple measuring instrument e.g. type Metavo 3 of Metrawatt) or with a digital multimeter (e.g. Fluke 77) when no voltage is applied at the controller).

Power supply cable and motor cable must be disconnected. The listed resistances stand for the nominal state. When they vary, there is a fault.

Operate digital multimeter in the measuring range \rightarrow | .

For the values marked with * the measuring instrument shows a small resistance at first, but then the stated final values are attained after a short time (approx. 1-2 s, depending on the measuring current).

+ and - refer to the two AMP plugs on the power board in the area of the DC link capacitors.

Caution: The positive pole of the internal accumulator of the used analog instrument is applied at the negative measuring terminal. Instruments of other manufacturers may be different (positive pole of the internal accumulator at the positive measuring terminal).

8. Measurement (1) Mains rectifier

positive connection of the ohmmeter at controller terminal	negative connection of the ohmmeter at controller terminal	displayed analog value	displayed voltage
L ₁	+ AMP plug	R > 10 kΩ*	0.4-0.6V
N	+ AMP plug	R > 10 kΩ*	0.4-0.6V
+ AMP plug	L ₁	R < 1 kΩ	OL
+ AMP plug	N	R < 1 kΩ	OL
- AMP plug	L ₁	R > 10 kΩ*	0.4-0.6V
- AMP plug	N	R > 10 kΩ*	0.4-0.6V
L ₁	- AMP plug	R < 1 kΩ	OL
N	- AMP plug	R → 1 kΩ	OL
L ₁	PE	R → ∞	OL
N	PE	R → ∞	OL
PE	L ₁	R → ∞	OL
PE	N	R → ∞	OL

8.2 Measurement (2) Inverter

positive connection of the ohmmeter at controller terminal	negative connection of the ohmmeter at controller terminal	displayed analog value	displayed voltage
U	+ AMP plug	$R > 10 \text{ k}\Omega^*$	0.4-0.6V
V	+ AMP plug	$R > 10 \text{ k}\Omega^*$	0.4-0.6V
W	+ AMP plug	$R > 10 \text{ k}\Omega^*$	0.4-0.6V
+ AMP plug	U	$R < 1 \text{ k}\Omega$	OL
+ AMP plug	V	$R < 1 \text{ k}\Omega$	OL
+ AMP plug	W	$R < 1 \text{ k}\Omega$	OL
- AMP plug	U	$R > 10 \text{ k}\Omega^*$	0.4-0.6V
- AMP plug	V	$R > 10 \text{ k}\Omega^*$	0.4-0.6V
- AMP plug	W	$R > 10 \text{ k}\Omega^*$	0.4-0.6V
U	-U AMP plug	$R < 1 \text{ k}\Omega$	OL
V	-U AMP plug	$R < 1 \text{ k}\Omega$	OL
W	-U AMP plug	$R < 1 \text{ k}\Omega$	OL
PE	U	$R \rightarrow \infty$	OL
PE	V	$R \rightarrow \infty$	OL
PE	W	$R \rightarrow \infty$	OL
U	PE	$R \rightarrow \infty$	OL
V	PE	$R \rightarrow \infty$	OL
W	PE	$R \rightarrow \infty$	OL

8.3 Measurement (3) DC link capacitors

positive connection of the ohmmeter at controller terminal	negative connection of the ohmmeter at controller terminal	displayed analog value	displayed voltage
+ AMP plug	- AMP plug	$R < 1 \text{ k}\Omega^*$	0.6-1.2V
- AMP plug	+ AMP plug	$R > 10 \text{ k}\Omega^*$	OL

8.4 Measurement (4) (5) Relay, switch-on resistor

Operate digital multimeter in the Ω measuring range

positive connection of the ohmmeter at controller terminal	negative connection of the ohmmeter at controller terminal	displayed analog value	displayed digital value
- rectifier	- AMP plug	631	631
		632 } $\approx 4.5\Omega$	632 } $\approx 4.5\Omega$
		633 } $\approx 7.5\Omega$	633 } $\approx 7.5\Omega$
		634 }	634 }

When the display shows 0Ω the relay contact sticks or the protective switch-on resistor R4 is of low resistance.

When the display shows ∞ or $> 1\text{ M}\Omega$ the protective switch-on resistor R4 is of high resistance.

9. List of units, components, hybrids

Integrated product	part.no	Description	Parts to be used				mother boards, mother units
			631	632	633	634	
631	326 442	frequency inverter 631					
632	326 443	frequency inverter 632					
633	326 444	frequency inverter 633					
634	326 445	frequency inverter 634					
6031	326 446	control board 631-634	1x	1x	1x	1x	631,632,633,634
6031A	326 447	power board for 631	1x				631
6032A	326 448	power board for 632		1x			632
6033A	326 449	power board for 633			1x		633
6034A	326 450	power board for 634				1x	634
6031BH	326 433	CW/CCW switching thick layer hybrid	1x	1x	1x	1x	6031
6031CH	326 435	I and U supervision thick layer hybrid	1x	1x	1x	1x	6031
6011CH	326 431	switch mode power supply thick layer hybrid	1x	1x	1x	1x	6031A, 6032A 6033A, 6034A
7063BH	326 087	U controller thick layer hybrid	1x	1x	1x	1x	6031
70630H	326 089	sinus 1 thick layer hybrid	1x	1x	1x	1x	6031
7063EH	326 090	sinus 2 thick layer hybrid	1x	1x	1x	1x	6031
7063FH	326 091	sinus 3 thick layer hybrid	1x	1x	1x	1x	6031
<u>Options</u>							
6035A	326 624	PLC option	1x	1x	1x	1x	631,632,633,634
60310H	328 590	clamp hybrid	1x	1x	1x	1x	6031
6031C	328 935	clamp option	1x	1x	1x	1x	631,632,633,634
6030	328 894	hand held terminal for diagnosis	1x	1x	1x	1x	631,632,633,634
6030	328 897	current transformer	1x	1x	1x	1x	631,632,633,634

10. Fitted components

10.1 Analog integrated circuits

Darlington array
ULN 2004

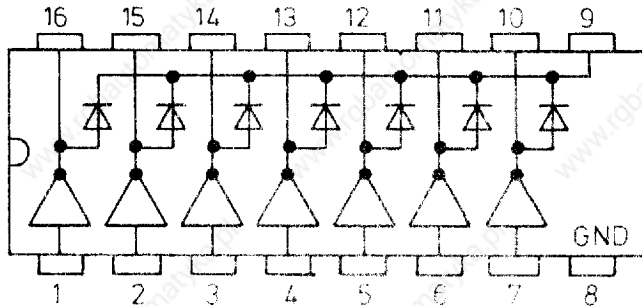

part no. 321 044

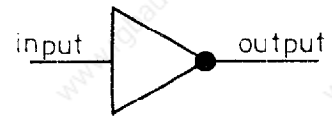

opto coupler

CNY17-III

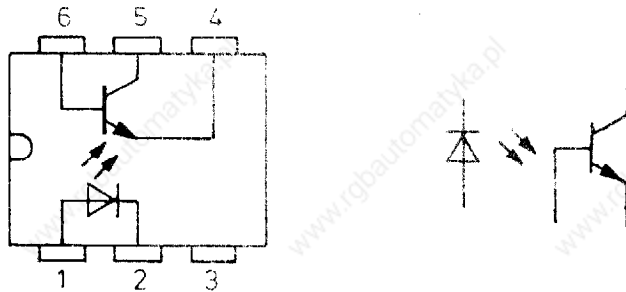

part no. 324 517

x operational amplifier

LM 348 N

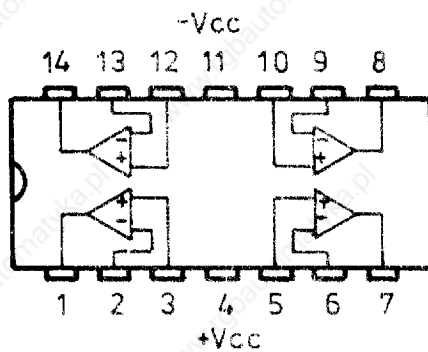

part no. 307 900

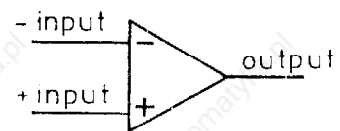

10.2 Discrete small power semiconductors

MOS-FET transistor n-channel

BS 170

part no. 321 940

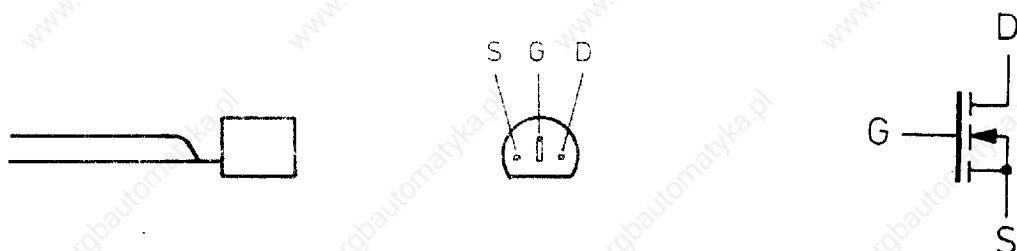

Positive fixed voltage controller +15V
78 M 15 CKC

part no. 307 168

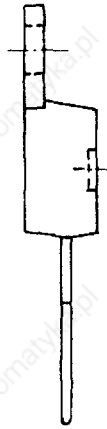
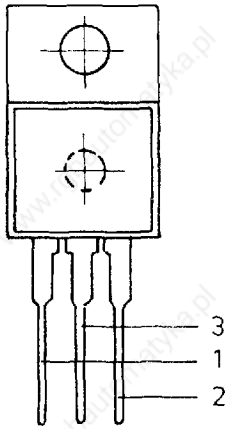

- 1 = input
- 2 = output
- 3 = GND

Negative fixed voltage controller -15V
79 M 15 AUC

part no. 307 899

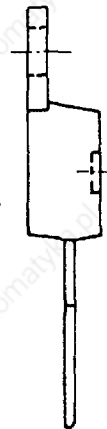
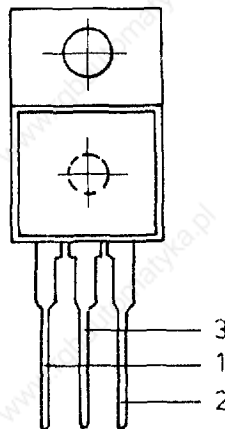

- 1 = GND
- 2 = output
- 3 = input

Driver components PC 920

part no. 326 412

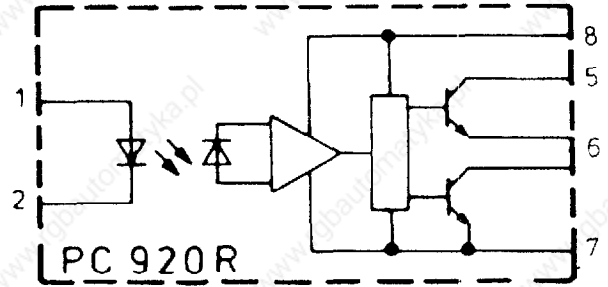
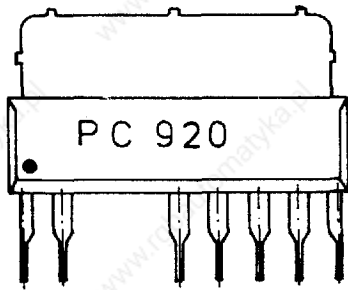

10.3 Hybrids

Hybrid 6011CH

switch mode power supply control

scale 1:1

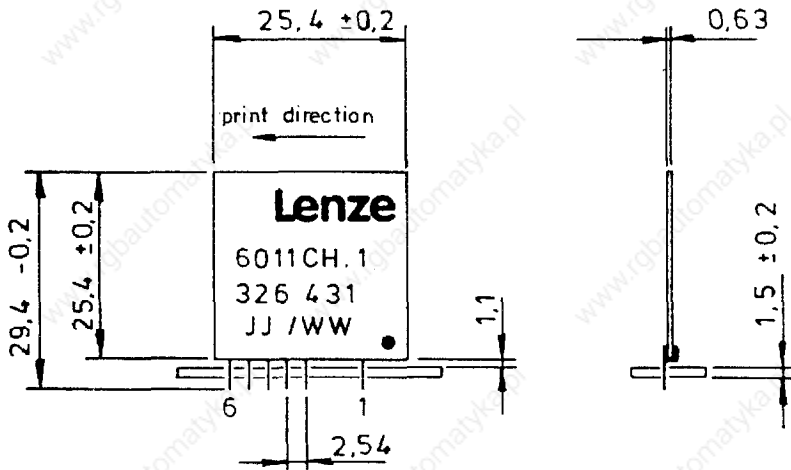

connecting pins are crimped

part no. 326 431

pin

- 1 + U_G (0-385V)
- 2 switch-on lock \perp — switch mode power supply on
+0.7V — switch mode power supply off
- 3 basis of the switch mode power supply transistor



20 kHz ≤ f ≤ 30 kHz

- 4 GND1 DC link ground \perp
- 5 control winding
- 6 - U_B = 7.5 V ± 2%

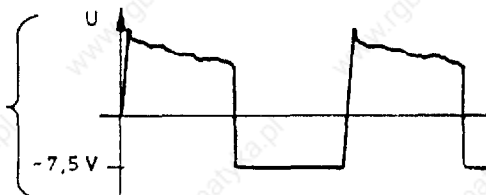

Hybrid 6031CH

Supervision power stage

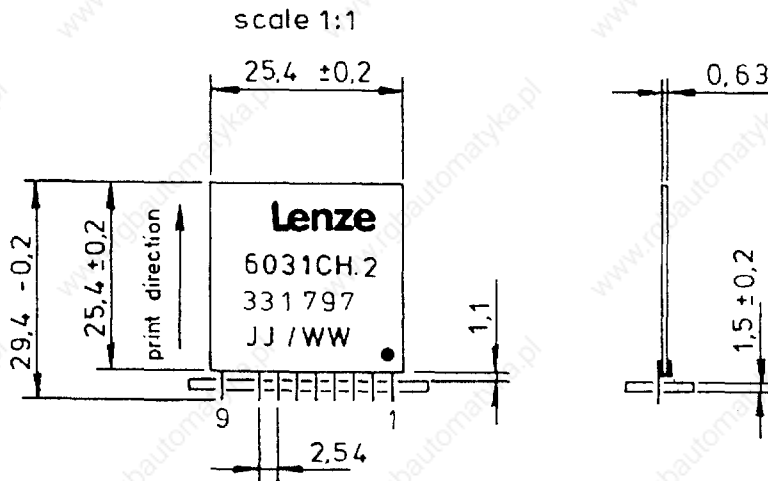

connecting pins are crimped

part no. 331 797

pin	
1	$+U_{B1} = +6.5V \pm 5\%$
2	GND1 \perp
3	$-U_{B1} = -7.5V \pm 2\%$
4	U_2 , 8V at 310V DC
5	capacitor for mains switch-on time $t_1 \approx 350$ ms
6	I_2 DC link current
7	GND1 \perp
8	U_{Gmax} : -7.5V = OFF, +6.5V = ON
9	U_{Gmin} : -7.5V = OFF, +6.5V = ON

hybrid 6031BH

supervision logic

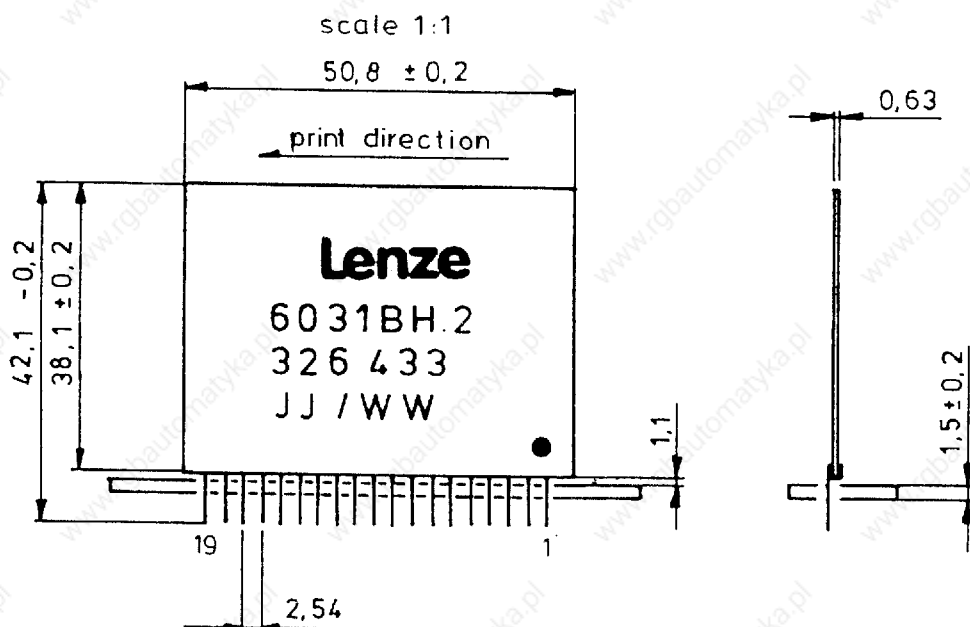

connecting pins are crimped

part no. 326 433

pin	
1	+V _{CC2} = 15V ± 5%
2	GND2 ⊥
3	-V _{CC2} = -15V ± 5%
4	f _{set} : 0 ÷ 11V
5	f _{set} : 0 ÷ 11V
6	RFR: L = 0V = ON, H = 15V = OFF
7	CW/CCW: CW = H = 15V, CCW = L = 0V
8	set value decrease: 0V = active
9	CW/CCW: CW = H = 15V, CCW = L = 0V
10	Q _{min} : f < Q _{min} ≈ 13V, f > Q _{min} = 0V
11	RFR: L = 0V = ON, H = 15V = OFF
12	U _{Gmin} : L = 0V, H = 12V = OFF
13	U _{Gmax} : L = 0V, H = 12V = OFF
14	∅ : L = 0V, H = 12V = OFF
15	capacitor for mains switch-on time t ₂ ≈ 150ms
16	TRIP memory = 15V
17	TRIP indication: L = 0V = OFF, H = 15V = ON
18	IMP: L = 0V = OFF, H = 15V = ON
19	IMP: L = 0V = ON, H = 15V = OFF

Lenze

hybrid 7063BH

voltage controller

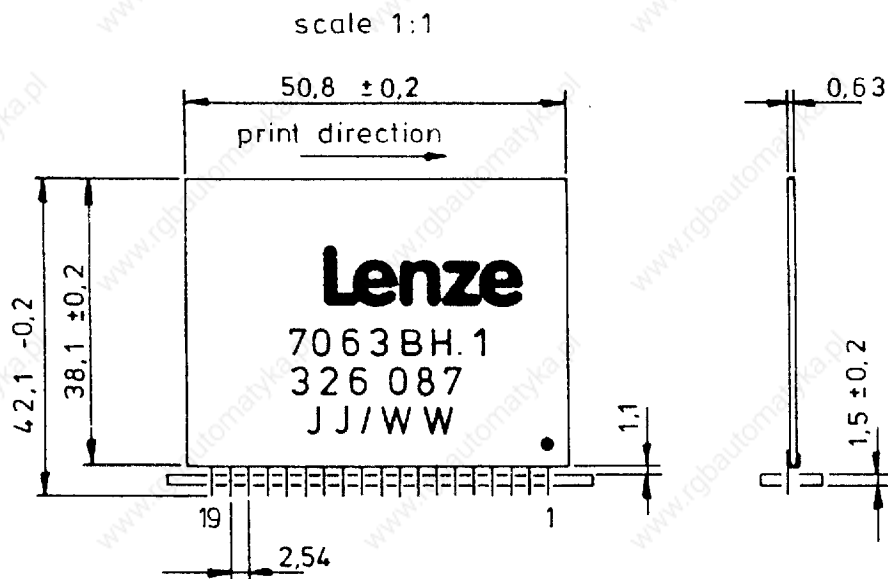

connecting pins are crimped

part no. 326 087

pin

1	+V _{cc2} = 15V ± 5%
2	GND2 ⊥
3	-V _{cc2} = -15V ± 5%
4	-U _{actual} : 0 ÷ -7.5V
5	-n _{nominal} : 0 ÷ -11V
6	summation point: 0V
7	IMP: L = 0V = ON, H = 15V = OFF
8	+n _{nominal} : 0 ÷ 11V
9	IMP: -13V = OFF, +13V = ON
10	n.c.
11	U _{min} : 0 ÷ 0.8V
12	U _{min} : 0 ÷ 0.8V
13	n.c.
14	n.c.
15	-V _{cc2} = -15V
16	n.c.
17	PI connection U controller
18	n.c.
19	U _{nominal} : 0 - 10V

hybrid 7063DH

sinus 1

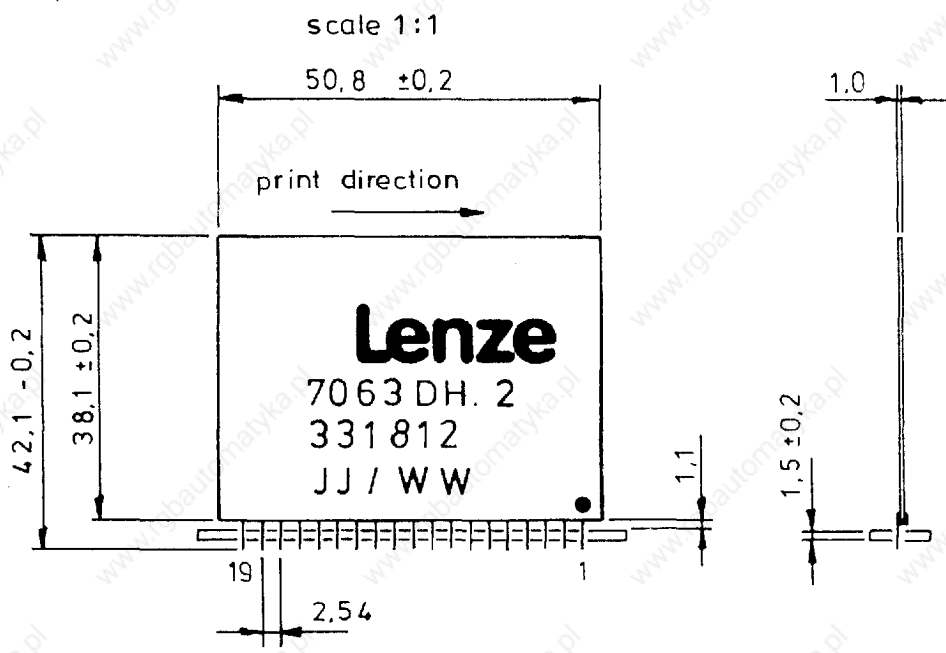

connecting pins are crimped

part no. 331 812

pin

1	+V _{CC} = 15V ± 5%
2	GND2 ⊥
3	-V _{CC} = -15V ± 5%
4	+V _{CC} = 15V
5	96 fd 0 ÷ 10.5 kHz
6	96 fd 0 ÷ 10.5 kHz
7	phase T:
8	phase R:
9	phase S:
10	phase T:
11	phase S: } \hat{U} 0 ÷ 10V ⊥
12	phase R: }
13	6xfd: 0 ÷ 660 Hz
14	- ⁿ nominal: 0 ÷ -11V
15	saw tooth: 96 fd -10V
16	0V
17	one shot: 96 fd 10V
18	U _{nominal} : 0 ÷ 10V
19	1xfd: 0 ÷ 110 Hz

hybrid 7063EH.2

sinus 2

scale 1:1

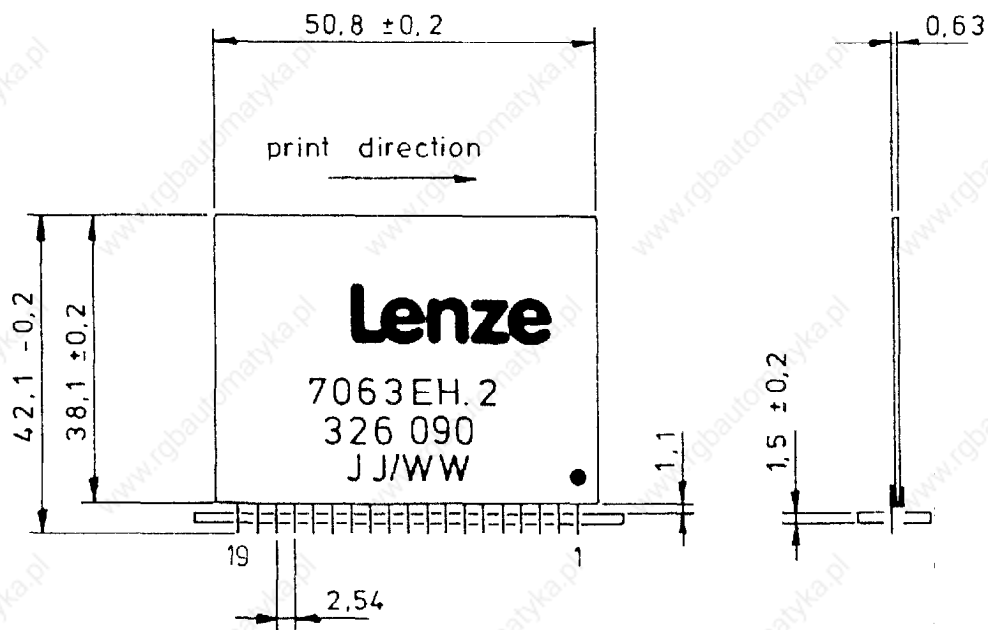

connecting pins are crimped

part no. 326 090

pin

1	$+V_{CC} = 15V \pm 5\%$	
2	GND2 \perp	
3	$-V_{CC} = -15V \pm 5\%$	
4	square wave: 350 Hz ÷ 4 kHz, $\pm (2V \div 8V)$	
5	0V	
6	fch ≈ 350 Hz ÷ 4 kHz	
7	phase T:	
8	phase R:	
9	phase S:	
10	phase T:	
11	phase S:	
12	phase R:	
13	f _{cmin} : -1.95V	
14	+n _{nominal} : 0 ÷ +5.5V	
15	n.c.	
16	fch: 350 Hz ÷ 4 kHz	
17	phase T:	
18	phase S:	
19	phase R:	

hybrid 7063FH

sinus 3

scale 1:1

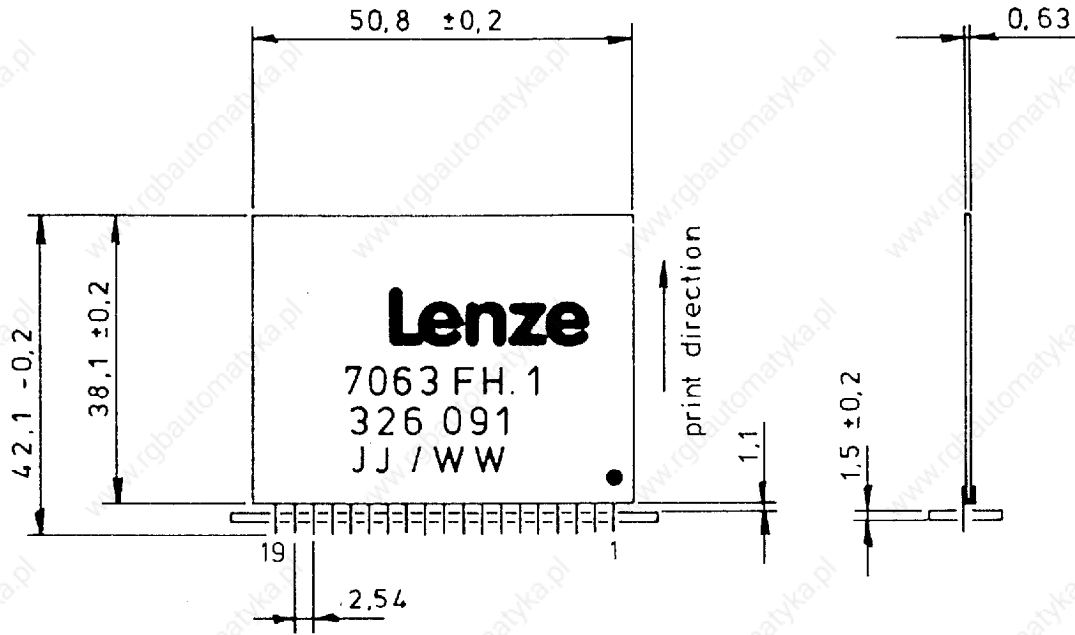

connecting pins are crimped

part no. 326 091

pin

1	+V _{CC} = 15V ± 5%
2	GND2 ⊥
3	-V _{CC} = -15V ± 5%
4	-V _{CC} = -15V
5	IMP: L = 0V = ON, H = 15V = OFF
6	IMP: L = 0V = ON, H = 15V = OFF
7	CW/CCW: CW = H = 15V, CCW = L = 0V
8	0V
9	n.c.
10	-U _{actual} : 0 ÷ -7.5V
11	phase V+
12	phase V-
13	phase U+
14	phase U-
15	phase W+
16	phase W-
17	phase T
18	phase S
19	phase R



10.4 Power semiconductors

Switch mode power supply transistor S911T (BU908)

part no. 328 635

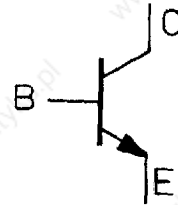
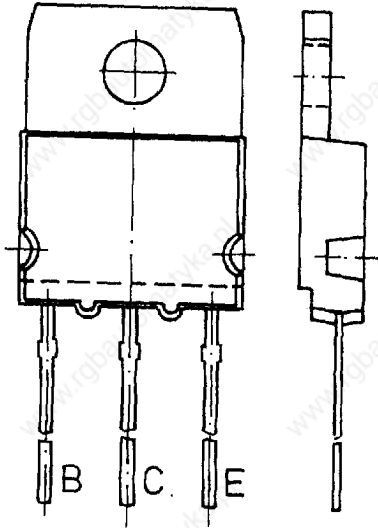

mains rectifier 36MB80A

part no. 308 302

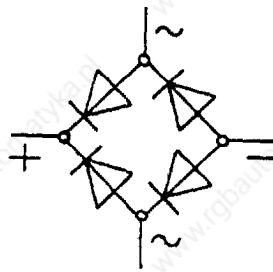
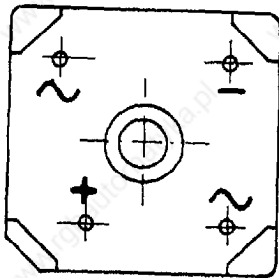

Transistor modules (only use modules according to Lenze specification with Lenze part no.)

Transistor module 631

Fuji 6DI15A-050

part no. 326 537

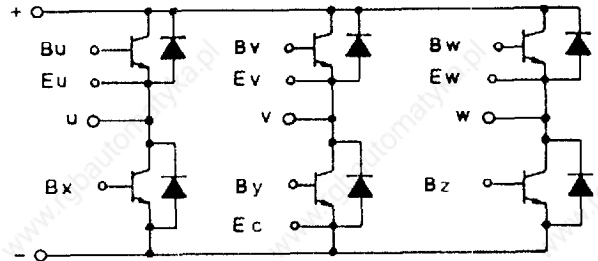
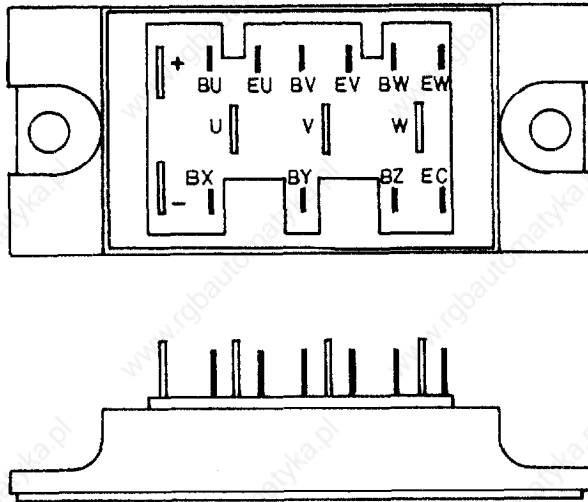

Toshiba: MG15G6EL1

part no. 326 538

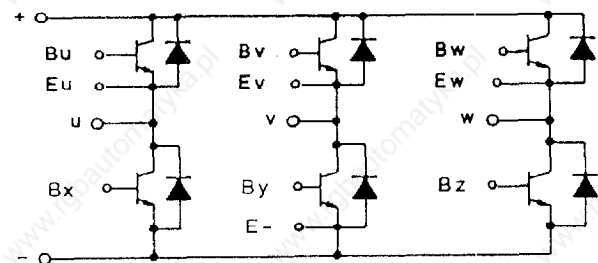
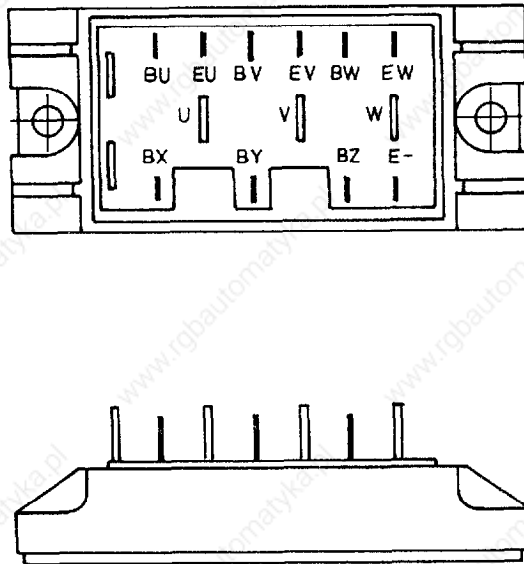

Mitsubishi: QM10TB-H

part no. 326 530

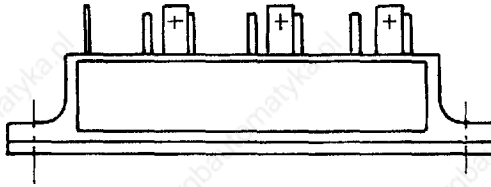
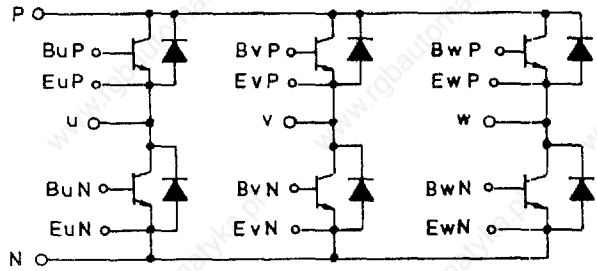
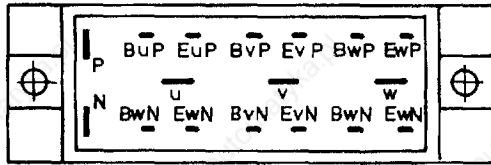

Transistor modules 632

Fuji 6DI15A-050

part no. 326 537

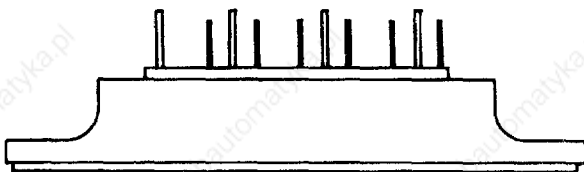
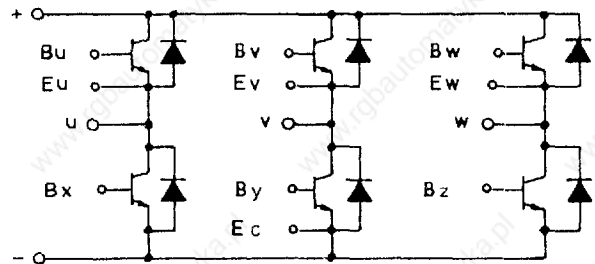
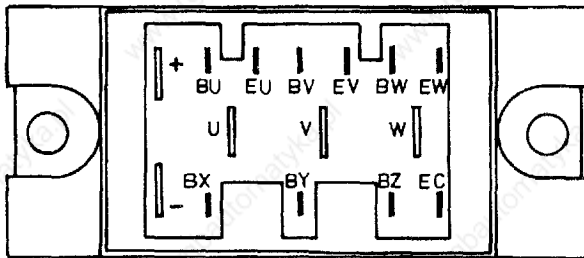

Toshiba: MG15G6EL1

part no. 326 538

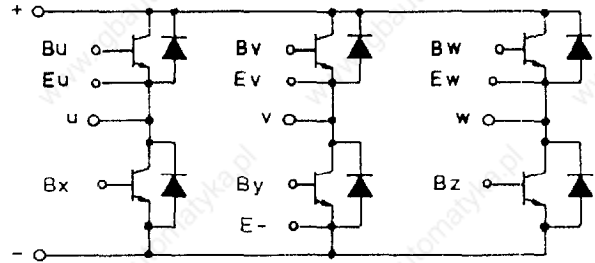
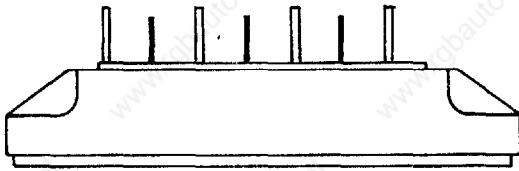
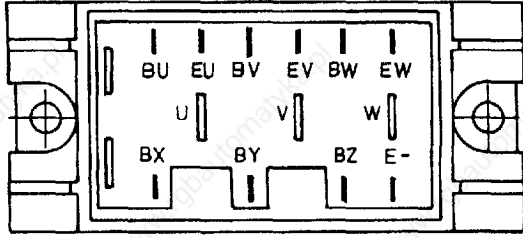

Mitsubishi: QM15TB-H

part no. 326 531

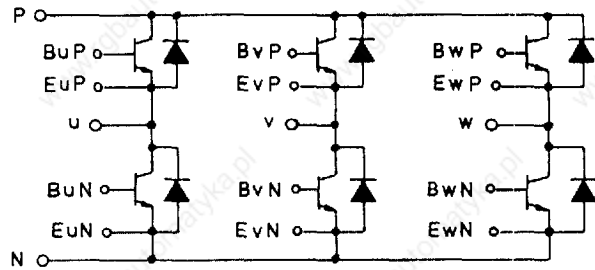
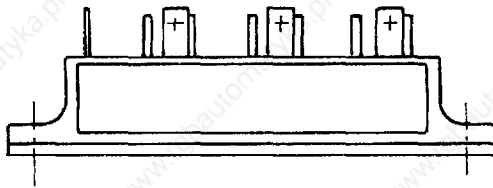
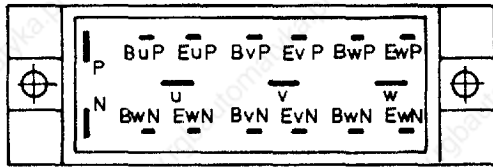

Transistor modules 633

Fuji: 6DI20B-050

part no. 326 539

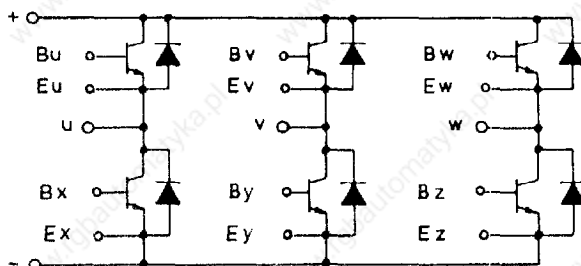
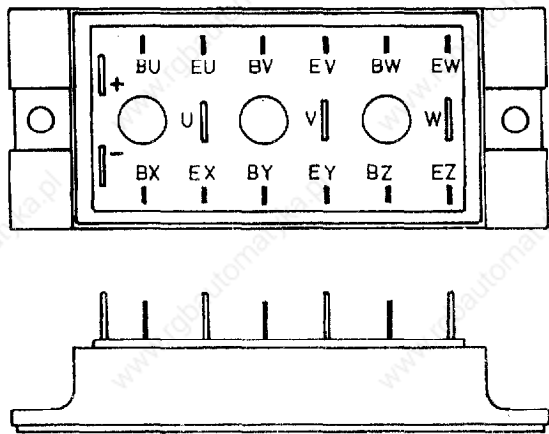

Fuji: 6DI20C-050

part no. 326 540

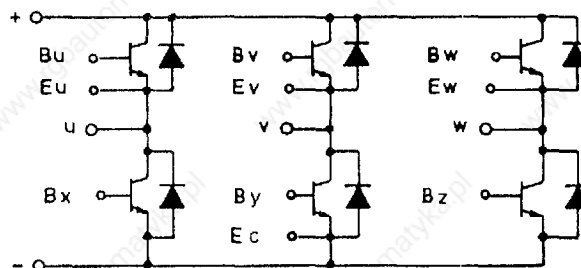
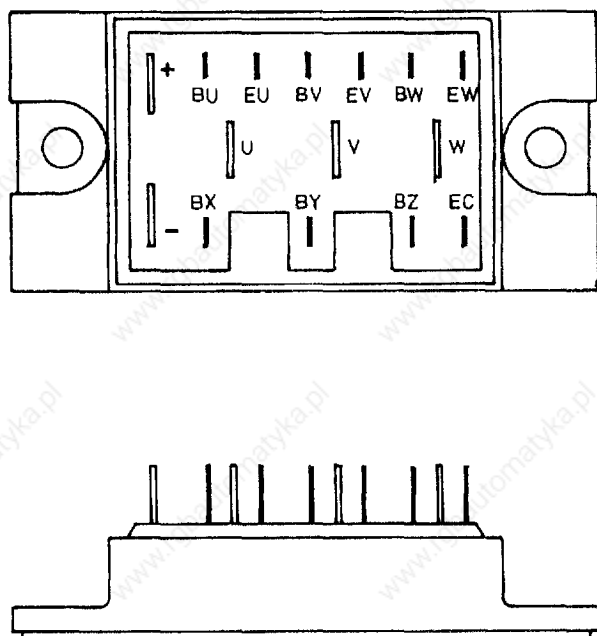

Transistor modules 633

Mitsubishi: QM20TB-H

part no.

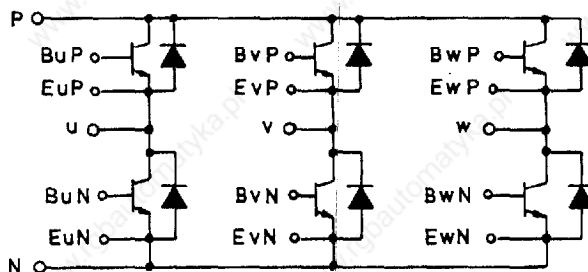
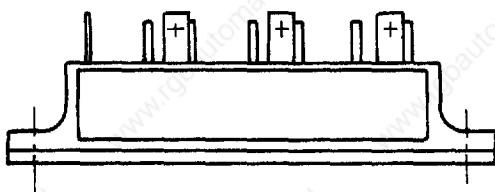
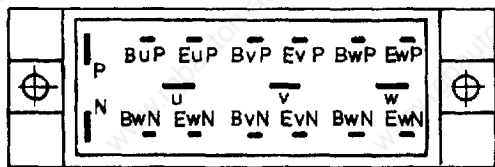

Toshiba: MG20G6EL1

part no.

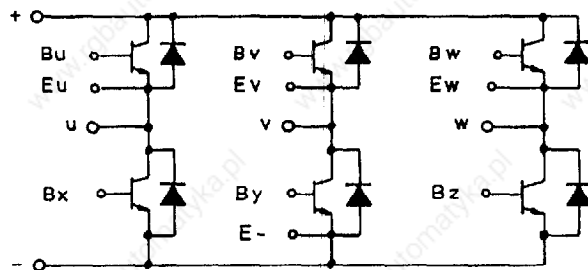
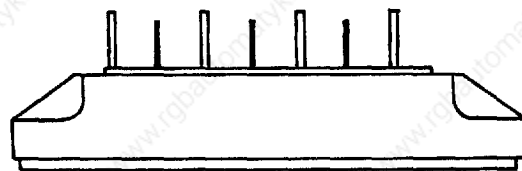
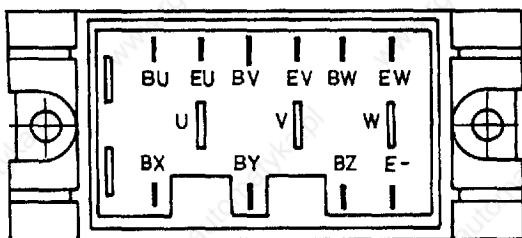

Transistor modules 634

Fuji: 6DI30B-050

part no. 326 541

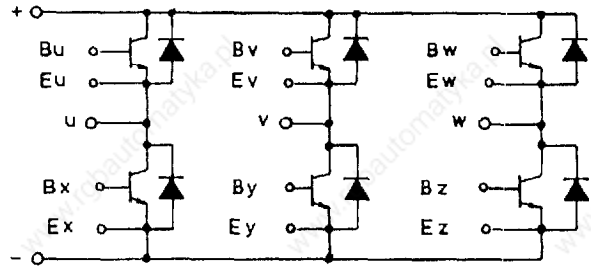
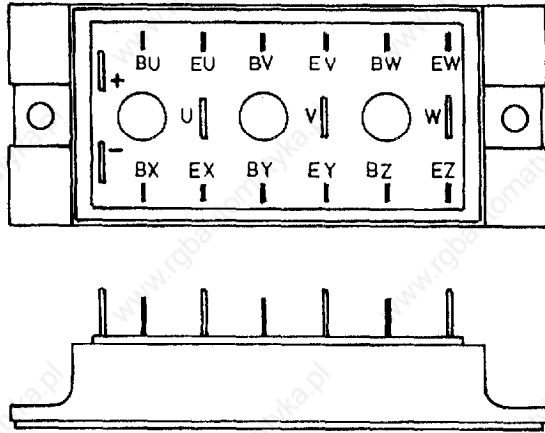

Toshiba: MG30G6EL2

part no. 326 534

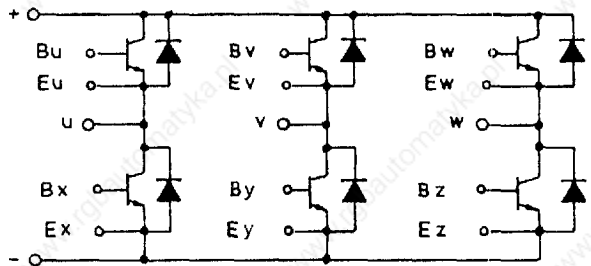
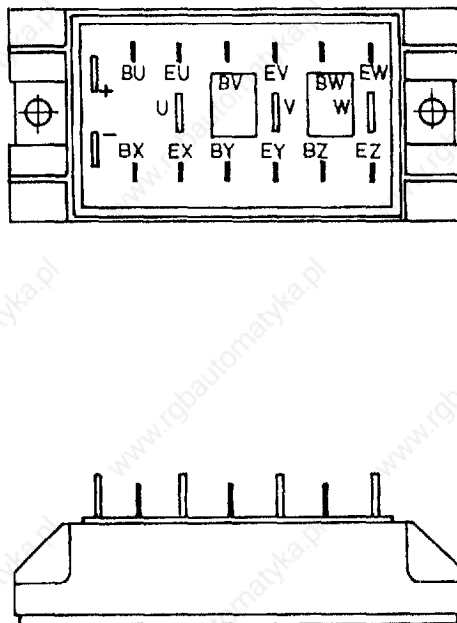

Lenze

In aller Welt
Worldwide
Dans le
monde
entier

Ägypten

Farid Hassanen & Co.
81, Matbaa Ahleia Str.
ET-Boulaac-Cairo
☎ 76 46 56, 76 56 15,
76 91 44, 77 48 97, 76 94 01
Telex 22 936 - F.H.C. UN,
22 125 AFC UN
Telegr. FAMEC
Telefax (02) 76 97 41

Australien

F C R Control Systems Pty. Ltd.
P.O. Box 46, 108 Somerville RD
AUS-Yarraville, 3013
☎ (03) 3 14 12 22
Telefax (03) 3 14 18 56

Belgien

Lenze p.v.b.a.
Noorderlaan 133, bus 15
B-2030 Antwerpen
☎ (03) 5 42 62 00
Telex 32 340 lenze b
Telefax (03) 5 41 37 54

Bulgarien

siehe Österreich

China V.R.

siehe Hong Kong

CSSR

siehe Österreich

Dänemark

Leomotor A/S
Ingenior- & Handelsfirma
Stubmøllevej 35
Postbox 438
DK-2450 Kopenhagen SV
☎ 31 30 66 66
Telex 19 166
Telefax 31 30 64 33
Them
☎ 86 84 75 33
Telefax 86 84 83 53

Berlin-West

Lenze GmbH & Co KG
Antriebstechnik Nordwest
Niederlassung Berlin-West
Terrassenstraße 27
1000 Berlin-West 38
☎ (0 30) 8 02 54 76
Telefax (0 30) 8 02 54 75

Hamburg

Lenze GmbH & Co KG
Antriebstechnik Nordwest
Niederlassung Hamburg
Tonndorfer Hauptstraße 126
2000 Hamburg 70
☎ (0 40) 66 91 91
Telefax (0 40) 66 25 90

Bad Nenndorf

Lenze GmbH & Co KG
Antriebstechnik Nordwest
Im Niedernfeld 1-3
3052 Bad Nenndorf 1
☎ (0 57 23) 20 17-19, Telex 9 72 283
Telefax (0 57 23) 68 08

Hamel/ Stammerwerk

Lenze GmbH & Co KG Aerzen
Postfach 10 13 52
3250 Hameln 1
Sitz: Aerzen 2 / Gr. Berkel
Hans-Lenze-Straße 1
☎ (0 51 54) 82-0, Telex 9 2 853
Teletex 51 54 11, Telefax (0 51 54) 40 40

Moers

Lenze GmbH & Co KG
Antriebstechnik West
Postfach 18 09, Uerdinger Straße 48
4130 Moers 1
☎ (0 28 41) 2 39 06, Telex 8 121 244
Telefax (0 28 41) 1 83 42

Herborn

Lenze GmbH & Co KG
Antriebstechnik Mitte
Postfach 14 63
Westerwaldstraße 36
6348 Herborn
☎ (0 27 72) 5 30 75-8, Telex 8 73 411
Telefax (0 27 72) 5 30 75-8

DDR

Lenze GmbH & Co KG
Antriebstechnik Nordwest
Niederlassung Berlin-West
Terrassenstraße 27
D-1000 Berlin-West 38
☎ (0 30) 8 02 54 76

Finnland

Refimex Oy
P.O. Box 35
SF-02271 Espoo
Hannuksentie 1
SF-02270 Espoo
☎ (0) 80 48 61
Telex 125 252, Telefax (0) 88 09 41

Frankreich

Lenze S.A.
Z.A. de Chanteloup
Rue Albert Einstein
F-93603 Aulnay s/s Bois Cedex
☎ (1) 48 66 28 18
Telex 232 214
Telefax (1) 48 69 40 99
Agences:
Décines-Charpieu:
☎ 72 37 05 50
Telefax 375 438
Strasbourg:
☎ 88 62 44 16
Telex 890 146
Telefax 88 81 22 13
Villeneuve sur Lot:
☎ 53 40 20 97
Telefax 53 40 21 04

Griechenland

Georg P. Alexandris AG
K. Mavromichali Str. 12
P.O. Box 86 009
GR-185 03 Piräus
☎ (1) 4 11 18 41, Telex 212 79 6
Telefax (1) 4 12 70 58
Monastiriou Str. 153
GR-546 27 Thessaloniki
☎ (31) 52 75 21-2, Telex 418 300

Großbritannien/N.-Irland

Simplatrol Ltd.
Caxton Road
GB-Bedford MK 41 OHT
☎ (02 34) 4 61 61, Telex 825 308
Telefax (02 34) 26 18 15

Hong Kong

Laden Trading Company Ltd.
RM 1134-5 Nan Fung Center
246-298 Castle Peak Road
Tsuen Wan, N.T.
P.O. Box 70 669 KCL
Hong Kong
☎ (0) 4 99 29 23
Telex 36 863 laden hx
Telefax (0) 4 11 40 27

Indien

Control Logic
Electronics & Instrumentation
23 Seaface House, Worli Seaface
IND-Bombay 400 018
☎ (22) 4 94 86 53
Telex 011-71 899 Roy in
Telefax (22) 4 94 11 63

Waiblingen

Lenze GmbH & Co KG Südtechnik
Postfach 17 91, Schänzle 8
Industriegebiet Eisental
7050 Waiblingen 1
☎ (0 71 51) 5 20 94, Telex 7 245 855
Telefax (0 71 51) 1 85 86

Rottweil

Lenze GmbH & Co KG
Antriebstechnik Süd
Niederlassung Rottweil
Zimmerer Straße 54-56
7210 Rottweil
☎ (07 41) 85 20
Telefax (07 41) 4 29 01

Karlsruhe

Lenze GmbH & Co KG
Antriebstechnik Süd
Niederlassung Karlsruhe
Saarlandstraße 83-91
7500 Karlsruhe 21
☎ (07 21) 55 70 41
Teletex 72 16 88
Telefax (07 21) 55 70 46

München

Lenze GmbH & Co KG
Antriebstechnik Süd
Niederlassung München
Erlenstraße 1
8032 Lochham
☎ (0 89) 8 54 40 10
Teletex 89 89 27
Telefax (0 89) 8 54 41 98

Ansbach

Lenze GmbH & Co KG
Antriebstechnik Süd
Niederlassung Ansbach
Schloßberg 31
8802 Sachsen
☎ (0 98 27) 74 01
Telefax (0 98 27) 64 41

Island

siehe Dänemark

Israel

Greenshpon Eng. Works Ltd.
P.O. Box 10 108
IL-Haifa-Bay
☎ (4) 72 14 72
Telex 45 108 green il
Telefax 972 - 4 - 72 62 31

Italien

Gerit Trasmissioni S.p.A.
Viale Monza 338
I-20128 Milano
☎ (02) 26 00 04 56
Telex 320 017 gerit i
Telefax (02) 2 55 29 70

Japan

Miki Pulley Co. Ltd.
461 Imai-Minami-Cho, Nakahara-Ku
J-Kawasaki-City
☎ (0 44) 7 33 - 51 51, Telex 03 842 110
Telefax (0 44) 7 11 24 31, 7 33 12 41

Jugoslawien

siehe Österreich

Kanada

siehe USA

Korea

In Kok Trading Company
Room No. 101
Solpyo Choseon Mooyack Bldg.
339-1, Daë Bang Dong
Dong Jack Gu
C.P.O. Box 37 21
R.o.K.-Seoul/Korea
☎ (02) 8 16-06 52-5
Telex K 26 919 inkoktd
Telefax (02) 8 16-50 16

Kuwait

Ammar & Partners Electrical Co.
P.O. Box 1871, Safat
KT-Kuwait
☎ 83 01 22
Telex 44 486 a/b APPECO

Luxemburg

siehe Belgien

Malaysia / Asean

Asia-Tech Engineering Sdn. Bhd.
No. 2 Jalan 8/1e, 46050 Petaling Jaya
MAL-Selangor
☎ 7 55 31 86

Mexico

siehe USA

Neuseeland

Byron Machinery Company Ltd.
P.O. Box 21-041
3a Waipareira Avenue
Henderson
NZ-Auckland 8
☎ (09) 8 37 - 12 96
Telex NZ 21 057 (Byrod)
Telefax (09) 8 34 - 74 57

Niederlande

Lenze B.V.
Postbus 31 01
NL-5203 DC 's-Hertogenbosch
Ploegweg 15
NL-5232 BR 's-Hertogenbosch
☎ (0 73) 41 00 96
Telex 50 160 lenze nl
Telefax (0 73) 41 15 45

Norwegen

DtC-Lenze A/S
Fjellhamarveien 56 B
N-1472 Fjellhamar
☎ (02) 97 19 50
Telefax (02) 97 20 25

Österreich

Lenze Antriebstechnik Ges.m.b.H.
Postfach 21
Mühlenstraße 3, A-4470 Enns
☎ (0 72 23) 34 21-0
Telex 229 371, 229 166
Telefax (0 72 23) 32 80

Polen

siehe Österreich

Rumänien

siehe Österreich

Schweden

Lenze Transmitter AB
Box 10 74
S-58110 Linköping
☎ (0 13) 11 14 70
Telex 50 033, Telefax (0 13) 10 36 23

Schweiz

Lenze Bachofen AG
Ackerstraße 42, Postfach
CH-8610 Uster-Zürich
☎ (01) 9 44 12 12
Telex 826 107, Telefax (01) 9 44 12 33

Singapur / Asean

Asia-Mech Engineering Pte Ltd.
67, Tuas Avenue 1
SGP-Singapore 2263
☎ 86 22 511 (5 Lines), 86 22 051
Telex rs 34 883, Telefax 86 24 551

Spanien

S.A. Sistel
Santanac, 25
E-08206 Sabadell (Barcelona)
☎ (93) 7 27 00 74
Telex 54 885 SEKT
Telefax (93) 7 25 35 76

Republik Südafrika

Integrated Machines (Pty.) Ltd.
P.O. Box 72 01, ZA-Ravenmoor 1469
1; Brakpan Road, Boksburg-South
☎ (0 11) 52-79 38 / 9
Telefax (0 11) 52-79 39

Taiwan

Joint Glory International Co. Ltd.
5th Fl., No 56, Nan King E. Road, Sec. 5
P.O. Box 36-739
Taipei, Taiwan
☎ (02) 7 69-4009, 7 69-9414, 7 69-9415
Telex 25 618 jointgl

Thailand

Weinmann & Schneider Co., Ltd.
G.P.O. Box 845
T-Bangkok 10501
☎ (2) 3 94 33 22
Telex 87 973 alucon th
Telefax (2) 3 84 04 47

Ungarn

siehe Österreich

USA

Lenze Corporation
311 Route 46 West
USA-Fairfield, NJ 07006
☎ (2 01) 2 27 - 53 11
Telex 642 520, Telefax (2 01) 2 27 74 23

Venezuela

Textiltec S.R.L.
Urbanizacion San Rafael
Parcela No. 5
YV-Charallave
☎ (0 39) 9 72 51
Maracay
YV-Calle Urdanetta 153
☎ (0 43) 83 83 76

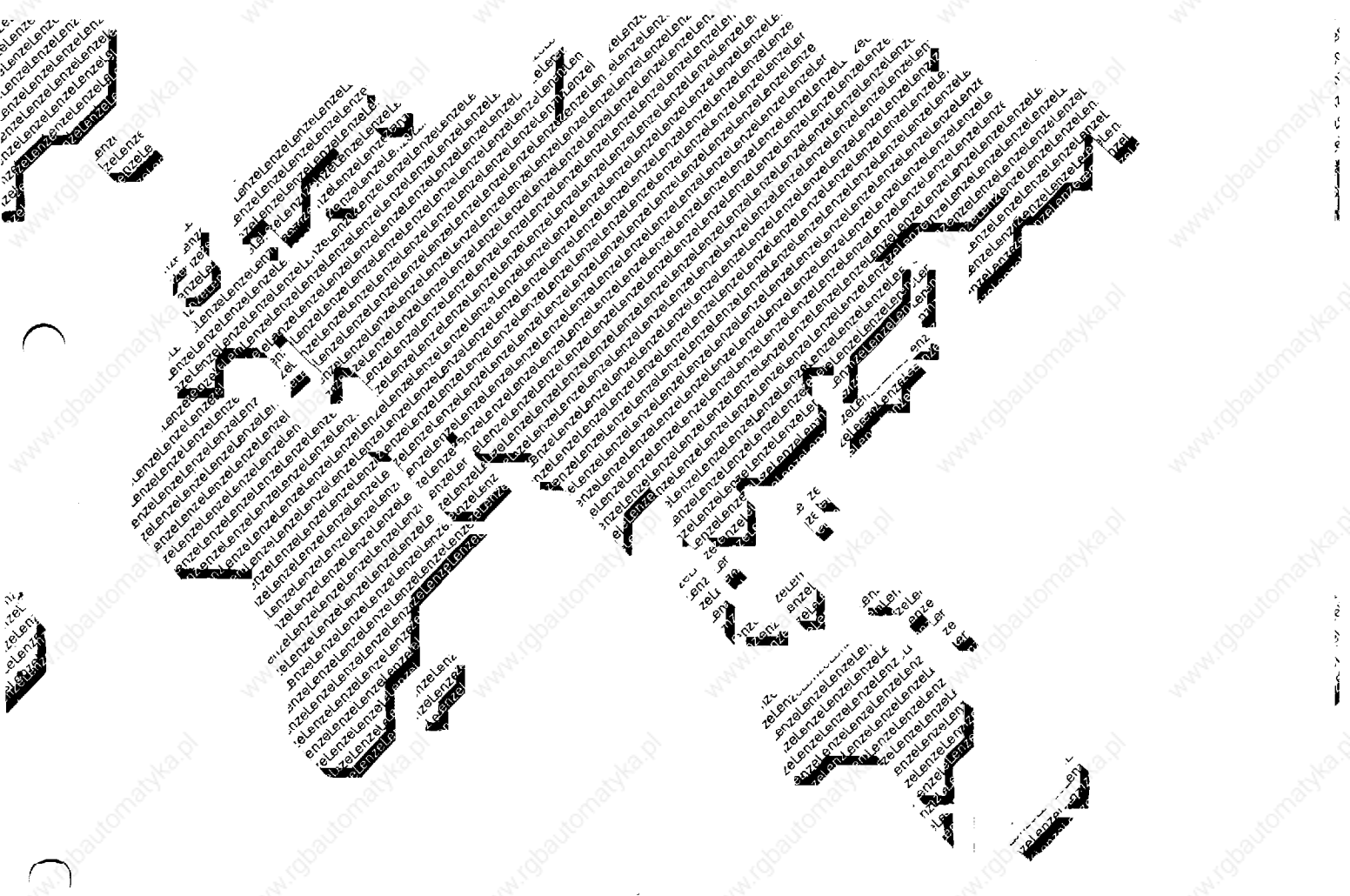

Lenze GmbH & Co KG Aenzen, Postfach 10 13 52, D-3250 Hameln 1, Sitz: Aenzen 2 / Gr. Berkel, Hans-Lenze-Straße 1
Telefon (0 51 54) 82 - 0, Telex 9 2 853, Teletex 51 54 11, Telefax (0 51 54) 40 49

Technische Änderungen vorbehalten - Technical alterations reserved - Sous réserve de modifications techniques