

C200H Temperature Sensor Unit

Operation Manual

Revised April 2000

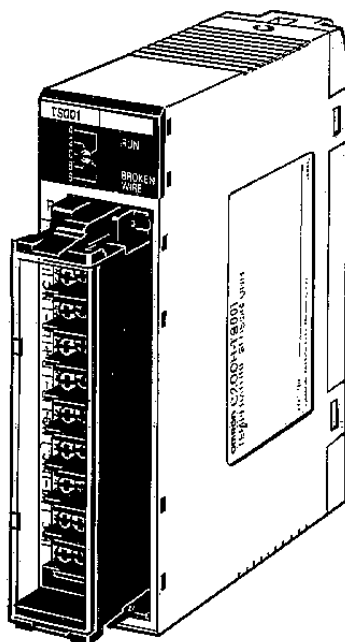

Read and Understand this Manual

Please read and understand this manual before using the product. Please consult your OMRON representative if you have any questions or comments.

Warranty and Limitations of Liability

WARRANTY

OMRON's exclusive warranty is that the products are free from defects in materials and workmanship for a period of one year (or other period if specified) from date of sale by OMRON.

OMRON MAKES NO WARRANTY OR REPRESENTATION, EXPRESS OR IMPLIED, REGARDING NON-INFRINGEMENT, MERCHANTABILITY, OR FITNESS FOR PARTICULAR PURPOSE OF THE PRODUCTS. ANY BUYER OR USER ACKNOWLEDGES THAT THE BUYER OR USER ALONE HAS DETERMINED THAT THE PRODUCTS WILL SUITABLY MEET THE REQUIREMENTS OF THEIR INTENDED USE. OMRON DISCLAIMS ALL OTHER WARRANTIES, EXPRESS OR IMPLIED.

LIMITATIONS OF LIABILITY

OMRON SHALL NOT BE RESPONSIBLE FOR SPECIAL, INDIRECT, OR CONSEQUENTIAL DAMAGES, LOSS OF PROFITS OR COMMERCIAL LOSS IN ANY WAY CONNECTED WITH THE PRODUCTS, WHETHER SUCH CLAIM IS BASED ON CONTRACT, WARRANTY, NEGLIGENCE, OR STRICT LIABILITY.

In no event shall the responsibility of OMRON for any act exceed the individual price of the product on which liability is asserted.

IN NO EVENT SHALL OMRON BE RESPONSIBLE FOR WARRANTY, REPAIR, OR OTHER CLAIMS REGARDING THE PRODUCTS UNLESS OMRON'S ANALYSIS CONFIRMS THAT THE PRODUCTS WERE PROPERLY HANDLED, STORED, INSTALLED, AND MAINTAINED AND NOT SUBJECT TO CONTAMINATION, ABUSE, MISUSE, OR INAPPROPRIATE MODIFICATION OR REPAIR.

Application Considerations

SUITABILITY FOR USE

OMRON shall not be responsible for conformity with any standards, codes, or regulations that apply to the combination of products in the customer's application or use of the products.

At the customer's request, OMRON will provide applicable third party certification documents identifying ratings and limitations of use that apply to the products. This information by itself is not sufficient for a complete determination of the suitability of the products in combination with the end product, machine, system, or other application or use.

The following are some examples of applications for which particular attention must be given. This is not intended to be an exhaustive list of all possible uses of the products, nor is it intended to imply that the uses listed may be suitable for the products:

- Outdoor use, uses involving potential chemical contamination or electrical interference, or conditions or uses not described in this manual.
- Nuclear energy control systems, combustion systems, railroad systems, aviation systems, medical equipment, amusement machines, vehicles, safety equipment, and installations subject to separate industry or government regulations.
- Systems, machines, and equipment that could present a risk to life or property.

Please know and observe all prohibitions of use applicable to the products.

NEVER USE THE PRODUCTS FOR AN APPLICATION INVOLVING SERIOUS RISK TO LIFE OR PROPERTY WITHOUT ENSURING THAT THE SYSTEM AS A WHOLE HAS BEEN DESIGNED TO ADDRESS THE RISKS, AND THAT THE OMRON PRODUCTS ARE PROPERLY RATED AND INSTALLED FOR THE INTENDED USE WITHIN THE OVERALL EQUIPMENT OR SYSTEM.

PROGRAMMABLE PRODUCTS

OMRON shall not be responsible for the user's programming of a programmable product, or any consequence thereof.

Disclaimers

CHANGE IN SPECIFICATIONS

Product specifications and accessories may be changed at any time based on improvements and other reasons.

It is our practice to change model numbers when published ratings or features are changed, or when significant construction changes are made. However, some specifications of the products may be changed without any notice. When in doubt, special model numbers may be assigned to fix or establish key specifications for your application on your request. Please consult with your OMRON representative at any time to confirm actual specifications of purchased products.

DIMENSIONS AND WEIGHTS

Dimensions and weights are nominal and are not to be used for manufacturing purposes, even when tolerances are shown.

PERFORMANCE DATA

Performance data given in this manual is provided as a guide for the user in determining suitability and does not constitute a warranty. It may represent the result of OMRON's test conditions, and the users must correlate it to actual application requirements. Actual performance is subject to the OMRON Warranty and Limitations of Liability.

ERRORS AND OMISSIONS

The information in this manual has been carefully checked and is believed to be accurate; however, no responsibility is assumed for clerical, typographical, or proofreading errors, or omissions.

Notice:

OMRON products are manufactured for use according to proper procedures by a qualified operator and only for the purposes described in this manual.

The following conventions are used to indicate and classify precautions in this manual. Always heed the information provided with them. Failure to heed precautions can result in injury to people or damage to property.

 **DANGER** Indicates an imminently hazardous situation which, if not avoided, will result in death or serious injury.

 **WARNING** Indicates a potentially hazardous situation which, if not avoided, could result in death or serious injury.

 **Caution** Indicates a potentially hazardous situation which, if not avoided, may result in minor or moderate injury, or property damage.

OMRON Product References

All OMRON products are capitalized in this manual. The word “Unit” is also capitalized when it refers to an OMRON product, regardless of whether or not it appears in the proper name of the product.

The abbreviation “Ch,” which appears in some displays and on some OMRON products, often means “word” and is abbreviated “Wd” in documentation in this sense.

The abbreviation “PC” means Programmable Controller and is not used as an abbreviation for anything else.

Visual Aids

The following headings appear in the left column of the manual to help you locate different types of information.

Note Indicates information of particular interest for efficient and convenient operation of the product.

1,2,3... 1. Indicates lists of one sort or another, such as procedures, checklists, etc.

© OMRON, 1989

All rights reserved. No part of this publication may be reproduced, stored in a retrieval system, or transmitted, in any form, or by any means, mechanical, electronic, photocopying, recording, or otherwise, without the prior written permission of OMRON.

No patent liability is assumed with respect to the use of the information contained herein. Moreover, because OMRON is constantly striving to improve its high-quality products, the information contained in this manual is subject to change without notice. Every precaution has been taken in the preparation of this manual. Nevertheless, OMRON assumes no responsibility for errors or omissions. Neither is any liability assumed for damages resulting from the use of the information contained in this publication.

TABLE OF CONTENTS

PRECAUTIONS	xi
1 Intended Audience	xii
2 General Precautions	xii
3 Safety Precautions	xii
4 Operating Environment Precautions	xiii
5 Application Precautions	xiii
SECTION 1	
Introduction	1
1-1 Nomenclature and Features	2
1-2 System Configuration	4
SECTION 2	
Wiring	7
2-1 Setup	8
SECTION 3	
I/O Allocation	11
3-1 Word Allocation	12
3-2 Bit Allocation	13
SECTION 4	
Settings and Displays	15
4-1 Temperature Specification Settings	16
4-2 Temperature Data Display	19
Appendices	
A Troubleshooting	23
B Standard Models	25
C Specifications	27
D Table of TemperatureSensing Elements	29
E Using the C200H Temperature Sensor Unit with CS1-series PCs	35
Glossary	37
Index	45
Revision History	47

About this Manual:

This manual describes the installation and operation of the C200H Temperature Sensor Unit and includes the sections described below.

Please read this manual carefully and be sure you understand the information provided before attempting to install and operate the C200H Temperature Sensor Unit.

Section 1 provides an introduction to the C200H Temperature Sensor Unit and includes details on nomenclature and functions as well as the system configuration.

Section 2 explains the wiring procedure required when setting up the Unit.

Section 3 gives details on the word and bit allocations for the Unit.

Section 4 explains how to make temperature settings and how to read the display.

Appendices, a **Glossary**, and an **Index** are also included.



WARNING Failure to read and understand the information provided in this manual may result in personal injury or death, damage to the product, or product failure. Please read each section in its entirety and be sure you understand the information provided in the section and related sections before attempting any of the procedures or operations given.

PRECAUTIONS

This section provides general precautions for using the C200H Temperature Sensor Unit and related devices.

The information contained in this section is important for the safe and reliable application of the C200H Temperature Sensor Unit. You must read this section and understand the information contained before attempting to set up or operate the C200H Temperature Sensor Unit.

1	Intended Audience	xii
2	General Precautions	xii
3	Safety Precautions.....	xii
4	Operating Environment Precautions	xiii
5	Application Precautions	xiii

1 Intended Audience

This manual is intended for the following personnel, who must also have knowledge of electrical systems (an electrical engineer or the equivalent).

- Personnel in charge of installing FA systems.
- Personnel in charge of designing FA systems.
- Personnel in charge of managing FA systems and facilities.

2 General Precautions

The user must operate the product according to the performance specifications described in the relevant manuals.

Before using the product under conditions which are not described in the manual or applying the product to nuclear control systems, railroad systems, aviation systems, vehicles, combustion systems, medical equipment, amusement machines, safety equipment, and other systems, machines, and equipment that may have a serious influence on lives and property if used improperly, consult your OMRON representative.

Make sure that the ratings and performance characteristics of the product are sufficient for the systems, machines, and equipment, and be sure to provide the systems, machines, and equipment with double safety mechanisms.

This manual provides information for programming and operating the Unit. Be sure to read this manual before attempting to use the Unit and keep this manual close at hand for reference during operation.

 **WARNING** It is extremely important that a PC and all PC Units be used for the specified purpose and under the specified conditions, especially in applications that can directly or indirectly affect human life. You must consult with your OMRON representative before applying a PC system to the above-mentioned applications.

3 Safety Precautions

 **WARNING** Do not attempt to take any Unit apart while the power is being supplied. Doing so may result in electric shock.

 **WARNING** Do not touch any of the terminals or terminal blocks while the power is being supplied. Doing so may result in electric shock.

 **WARNING** Do not attempt to disassemble, repair, or modify any Units. Any attempt to do so may result in malfunction, fire, or electric shock.

 **WARNING** Provide safety measures in external circuits (i.e., not in the Programmable Controller), including the following items, in order to ensure safety in the system if an abnormality occurs due to malfunction of the PC or another external factor affecting the PC operation. Not doing so may result in serious accidents.

- Emergency stop circuits, interlock circuits, limit circuits, and similar safety measures must be provided in external control circuits.

- The PC will turn OFF all outputs when its self-diagnosis function detects any error or when a severe failure alarm (FALS) instruction is executed. As a countermeasure for such errors, external safety measures must be provided to ensure safety in the system.
- The PC outputs may remain ON or OFF due to deposition or burning of the output relays or destruction of the output transistors. As a countermeasure for such problems, external safety measures must be provided to ensure safety in the system.
- When the 24-VDC output (service power supply to the PC) is overloaded or short-circuited, the voltage may drop and result in the outputs being turned OFF. As a countermeasure for such problems, external safety measures must be provided to ensure safety in the system.

4 Operating Environment Precautions

 **Caution** Do not operate the control system in the following locations:

- Locations subject to direct sunlight.
- Locations subject to temperatures or humidity outside the range specified in the specifications.
- Locations subject to condensation as the result of severe changes in temperature.
- Locations subject to corrosive or flammable gases.
- Locations subject to dust (especially iron dust) or salts.
- Locations subject to exposure to water, oil, or chemicals.
- Locations subject to shock or vibration.

 **Caution** Take appropriate and sufficient countermeasures when installing systems in the following locations:

- Locations subject to static electricity or other forms of noise.
- Locations subject to strong electromagnetic fields.
- Locations subject to possible exposure to radioactivity.
- Locations close to power supplies.

 **Caution** The operating environment of the PC system can have a large effect on the longevity and reliability of the system. Improper operating environments can lead to malfunction, failure, and other unforeseeable problems with the PC system. Be sure that the operating environment is within the specified conditions at installation and remains within the specified conditions during the life of the system.

5 Application Precautions

Observe the following precautions when using the PC system.

 **WARNING** Always heed these precautions. Failure to abide by the following precautions could lead to serious or possibly fatal injury.

- Always ground the system to 100 Ω or less when installing the Units. Not connecting to a ground of 100 Ω or less may result in electric shock.
- Always turn OFF the power supply to the PC before attempting any of the following. Not turning OFF the power supply may result in malfunction or electric shock.
 - Mounting or dismounting I/O Units, CPU Units, Memory Units, or any other Units.
 - Assembling the Units.
 - Setting DIP switches or rotary switches.
 - Connecting cables or wiring the system.
 - Connecting or disconnecting the connectors.

 **Caution** Failure to abide by the following precautions could lead to faulty operation of the PC or the system, or could damage the PC or PC Units. Always heed these precautions.

- Fail-safe measures must be taken by the customer to ensure safety in the event of incorrect, missing, or abnormal signals caused by broken signal lines, momentary power interruptions, or other causes.
- Always use the power supply voltages specified in this manual. An incorrect voltage may result in malfunction or burning.
- Take appropriate measures to ensure that the specified power with the rated voltage and frequency is supplied. Be particularly careful in places where the power supply is unstable. An incorrect power supply may result in malfunction.
- Install external breakers and take other safety measures against short-circuiting in external wiring. Insufficient safety measures against short-circuiting may result in burning.
- Do not apply voltages to the Input Units in excess of the rated input voltage. Excess voltages may result in burning.
- Do not apply voltages or connect loads to the Output Units in excess of the maximum switching capacity. Excess voltage or loads may result in burning.
- Disconnect the functional ground terminal when performing withstand voltage tests. Not disconnecting the functional ground terminal may result in burning.
- Be sure that all the mounting screws, terminal screws, and cable connector screws are tightened to the torque specified in this manual. Incorrect tightening torque may result in malfunction.
- Leave the label attached to the Unit when wiring. Removing the label may result in malfunction if foreign matter enters the Unit.
- Remove the label after the completion of wiring to ensure proper heat dissipation. Leaving the label attached may result in malfunction.
- Double-check all wiring and switch settings before turning ON the power supply. Incorrect wiring may result in burning.
- Wire correctly. Incorrect wiring may result in burning.
- Mount Units only after checking terminal blocks and connectors completely.

- Be sure that the terminal blocks, Memory Units, expansion cables, and other items with locking devices are properly locked into place. Improper locking may result in malfunction.
- Check the user program for proper execution before actually running it on the Unit. Not checking the program may result in an unexpected operation.
- Confirm that no adverse effect will occur in the system before attempting any of the following. Not doing so may result in an unexpected operation.
 - Changing the operating mode of the PC.
 - Force-setting/force-resetting any bit in memory.
 - Changing the present value of any word or any set value in memory.
- Resume operation only after transferring to the new CPU Unit the contents of the DM Area, HR Area, and other data required for resuming operation. Not doing so may result in an unexpected operation.
- Do not pull on the cables or bend the cables beyond their natural limit. Doing either of these may break the cables.
- Do not place objects on top of the cables or other wiring lines. Doing so may break the cables.
- Use crimp terminals for wiring. Do not connect bare stranded wires directly to terminals. Connection of bare stranded wires may result in burning.
- When replacing parts, be sure to confirm that the rating of a new part is correct. Not doing so may result in malfunction or burning.
- Before touching a Unit, be sure to first touch a grounded metallic object in order to discharge any static built-up. Not doing so may result in malfunction or damage.

SECTION 1

Introduction

1-1	Nomenclature and Features	2
1-2	System Configuration	4

1-1 Nomenclature and Features

The Temperature Sensor Unit detects temperatures and sends the resultant BCD (Binary Coded Decimal) data to the PC (Programmable Controller). This data can be further manipulated and transferred to other I/O Units for extended system control.

The C200H Temperature Sensor Unit is available in four models. The C200H-TS001/002 are for use with thermocouples, and can be used with K (CA), J (IC) and L (Fe-CuNi) thermocouples. The C200H-TS101/102 are for use with platinum resistance sensors.

The Unit has the following components:

Front Panel

**C200H-TS001/002
(Thermocouple)**

**C200H-TS101/102
(Platinum RTD)**

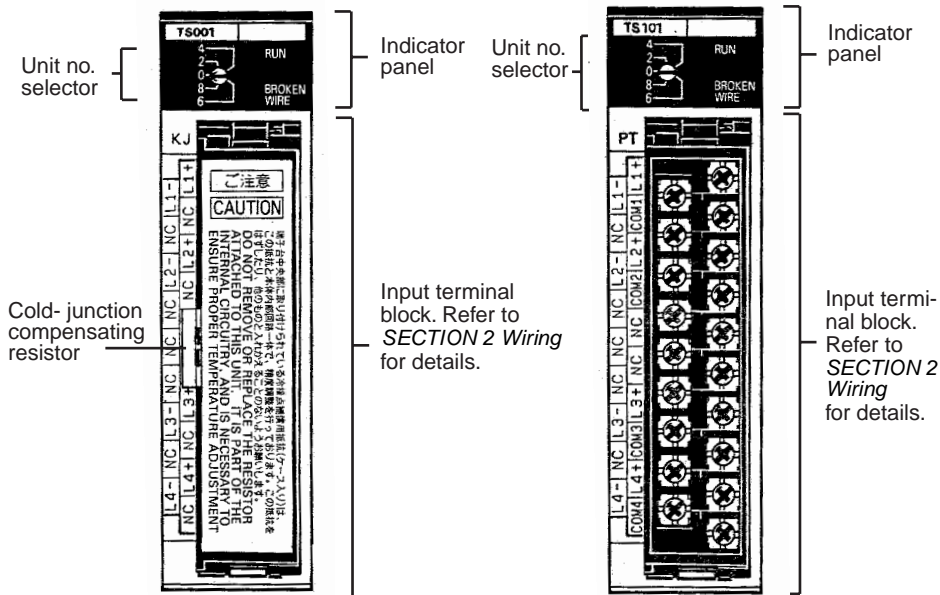

Unit Number Selector

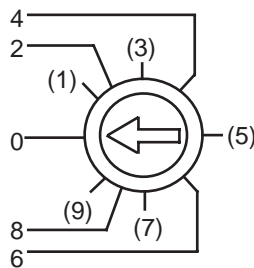

The arrow on the selector indicates the unit number. Use a standard screwdriver to rotate the switch and set the desired unit number. Be sure to set different unit numbers from those of other Special I/O Units connected to the same PC. Otherwise, an "I/O Unit Over" error is generated and the Unit will not operate properly. IR word numbers are assigned as shown in the following table.

Unit no.	IR word
0	100 through 109
1	110 through 119
2	120 through 129
3	130 through 139
4	140 through 149
5	150 through 159
6	160 through 169
7	170 through 179
8	180 through 189
9	190 through 199

Indicator panel

There are two LEDs in the indicator panel, which function as follows:

Indicator	Color	Function
RUN	Green	Lit during normal operation. Unlit during errors.
BROKEN WIRE	Red	Lit when input is disconnected. Blinks when data is outside of set range.

DIP Switch Setting

C200H-TS001/002

All switches are OFF before shipment from the factory.

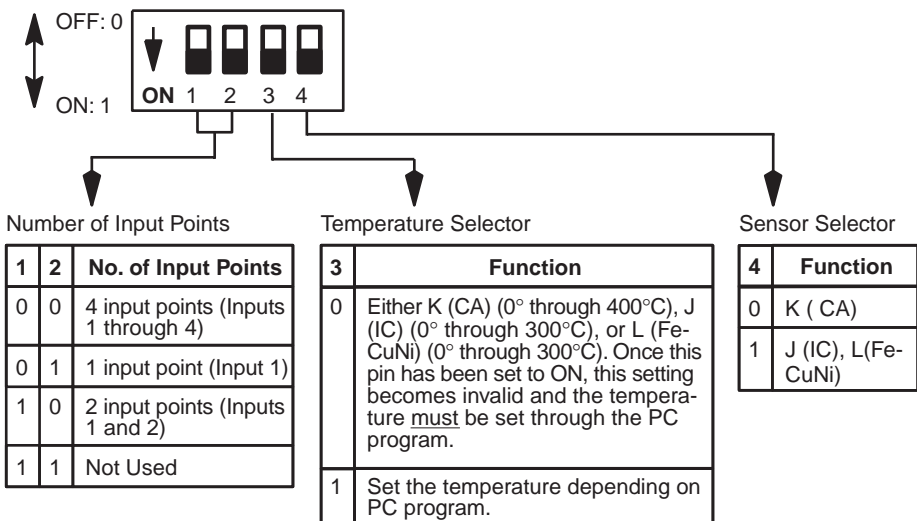

The temperature specifications must be set identically for all four points. These points cannot be used for different thermocouples or with different temperature specifications.

The cold-junction compensating resistor connected to the C200H-TS001/002 terminal block (for the thermocouple) has been preset to the Unit's internal circuits. Do not remove or replace it. If it is necessary to remove it, when re-attaching, confirm that the number marked on the resistor matches the number

on the Unit, as shown in the following diagram. The output temperature data may be incorrect if the numbers do not match.

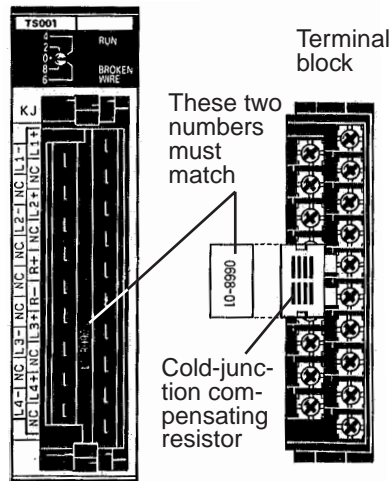

**DIP Switch Setting
C200H-TS101/102**

All switches are set to OFF before shipment from the factory.

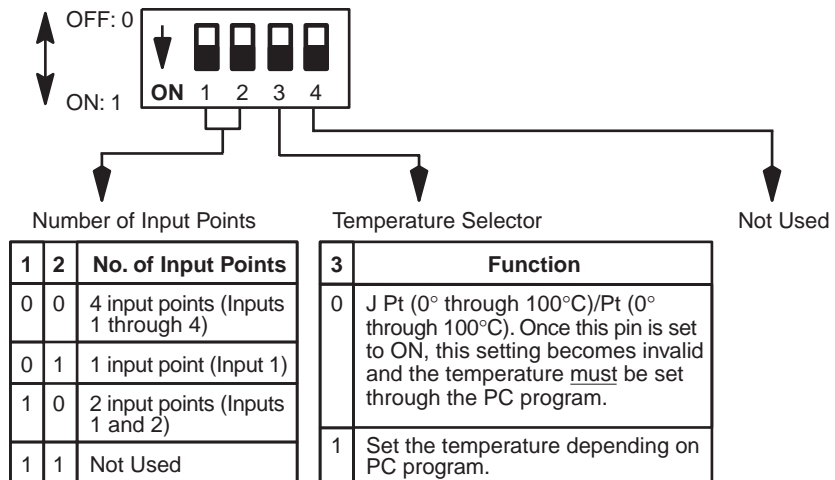

1-2 System Configuration

The Special I/O Units are not allocated the word number of the slot they are mounted to. They are allocated word numbers according to the unit number setting on the front panel (refer to page 2).

If possible, avoid mounting the Temperature Sensor Units in either of the two rightmost CPU Rack slots. However, if this is unavoidable, use one of the Programming Console Base Units (C200H-BP001 or C200H-BP002) when mounting peripheral devices to the PC.

No Special I/O Units can be mounted on a C200H Slave Rack connected to a Master on a PC other than a C200H.

The thermocouple or RTD registers the temperature and sends the data through the Temperature Sensor Unit to the PC in 4-digit BCD. After the PC

processes this data, the data can be output to a display, or used for controlling system devices.

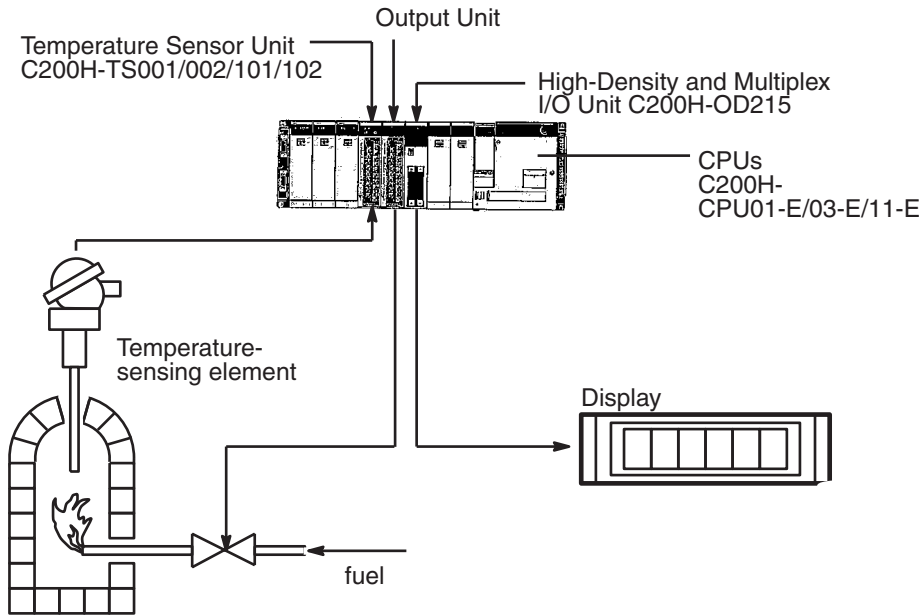

Mounting Temperature Sensor Units

A maximum of 10 Special I/O Units (including the PC Link Units) can be mounted on the CPU Rack, Expansion I/O Rack, or Slave Rack. However, the maximum current supplied or consumed may limit the actual number of I/O Units that can be connected. Refer to the C200H Installation Guide for maximum current levels. Note that the specific limit, resulting from data transmission, placed on the Slave Rack is as shown in the following table.

Special I/O Units on Slave Racks

The number of Special I/O Units that can be mounted on a Slave Rack is limited. The table below shows the maximum number of Special I/O Units that can be mounted to one Slave Rack.

A	B	C	D
Maximum number of High-Speed Counter Units, Position Control Units (NC111/NC112), ASCII Units, Analog I/O Units, and ID Sensor Units	Maximum number of High-Density and Multiplex I/O Units.	Maximum number of Voice and Temperature Sensor Units.	Maximum number of Position Control Units (NC211)
4 Units	8 Units	6 Units	2 Units

- Note**
1. When using a combination of Units, use the following formula: $3A+B+2C+6D \leq 12$ and, $A+B+C+D \leq 8$
 2. These Units can be used on other Racks, but the total number cannot exceed 10.

SECTION 2

Wiring

2-1 Setup	8
-----------------	---

2-1 Setup

External Connections

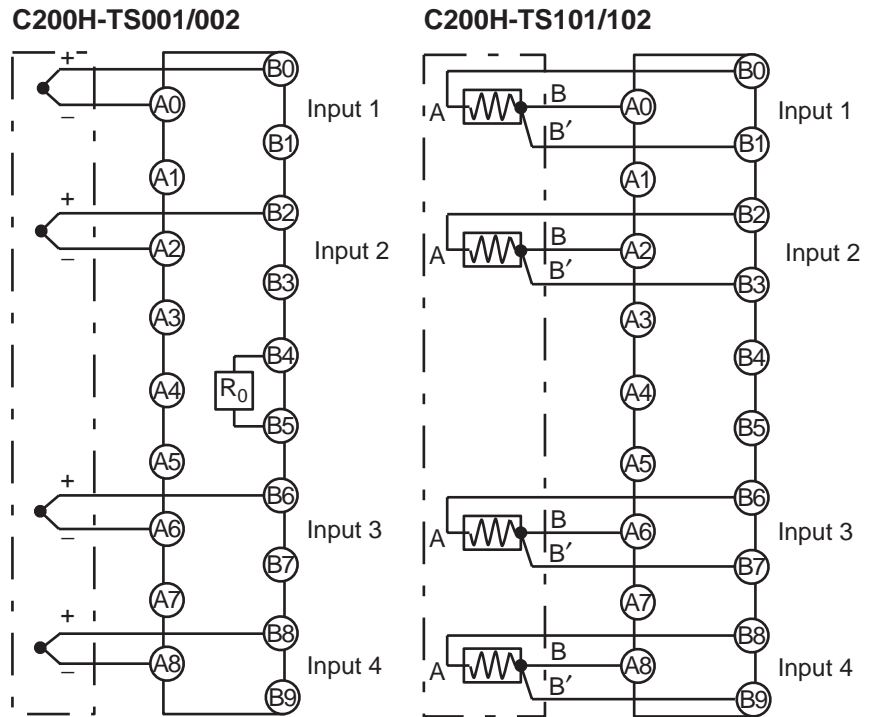

⚠ Caution R_0 : Cold-junction compensating resistor

The cold-junction compensating resistor connecting terminals B4 and B5 on the C200H-TS001/002 is fully integrated in the internal circuitry of the Unit and serves to maintain accuracy. Be careful not to remove this resistor and be sure the screws are always tight.

Unused Input Terminals

For TS001/002 (thermocouple input), short the positive and negative poles of the thermocouple inputs (for example, terminals A8 and B8 in Input 4).

For TS101/102 (platinum RTD input), short the B and B' terminals (for example, terminals A8 and B9 for Input 4), and connect a 100 Ω (1/8 W minimum) resistor between terminals A and B. (For example, A8 and B8 for input 4.)

Removable Terminal Block Connections

When Using Solderless Crimp Leads

Use M3.5 screws (with self-rising pressure plates) for mounting solderless crimp terminals.

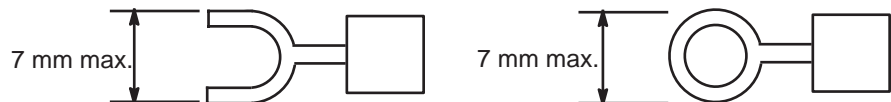

Soldered leads

Carefully tin the 5- to 7-mm exposed end of the lead wire.

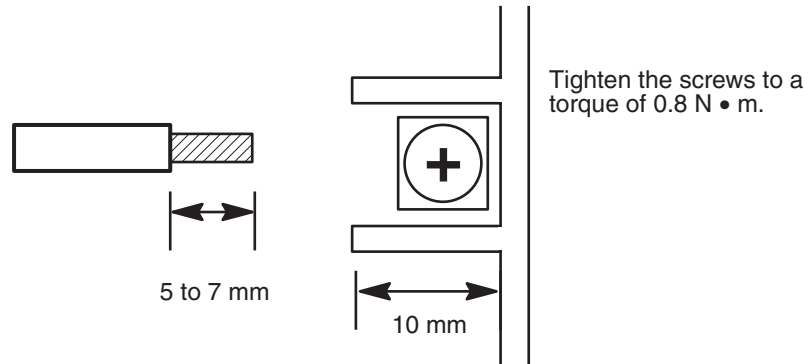

Wiring Notes

To avoid influence from induced noise, keep the input signal wires (compensating wires or lead wires) away from the power source line or load line by at least 300 mm. Also be sure not to lay them parallel to, or in the same cable as, the power line. Using shield wires in separated ducts or pipes is also an effective way to reduce influence from noise. Attach surge absorbers or noise filters to peripheral devices that generate noise (in particular, devices that possess inductance components, such as motors, transistors, solenoids, or magnet coils). Install away from devices that generate strong, high-frequency waves or that generate surges.

Connect the thermocouples with the compensating wires as shown in the following diagram. Connect platinum RTDs with lead wires of low resistance (for example, copper wires). Make the three lead wires extending from the platinum RTDs equal in length. Do not short-circuit the B wire and B' wire near the terminal block connector, because it causes measurement errors.

Input Signal Wire Extension

The input signal wire should be as short as possible so that the effect of outside noise is minimized. The following table has more information on type and length of the signal wire.

Sensor-Input	Wire	Configuration	Maximum Extension Length
K (CA)	Compensating conductor WX-H, WX-H6	0.3 mm ² x 7 leads	80 m
J (IC)	Compensating conductor JX-H, JX-H6	0.3 mm ² x 7 leads	70 m
L (Fe-CuNi)	Compensating conductors JX	0.3 mm ² x 7 leads	70 m
JPt 100 ΩPt 100Ω	Copper wire	0.5 mm ²	120 m

SECTION 3

I/O Allocation

3-1	Word Allocation	12
3-2	Bit Allocation	13

3-1 Word Allocation

The unit number setting (on the front panel of the Temperature Sensor Unit) determines the words allocated to the Unit. Ten words are assigned to any given Special I/O Unit, but only six words are actually used by the Temperature Sensor Unit. The following figure shows which words are available according to the unit number setting.

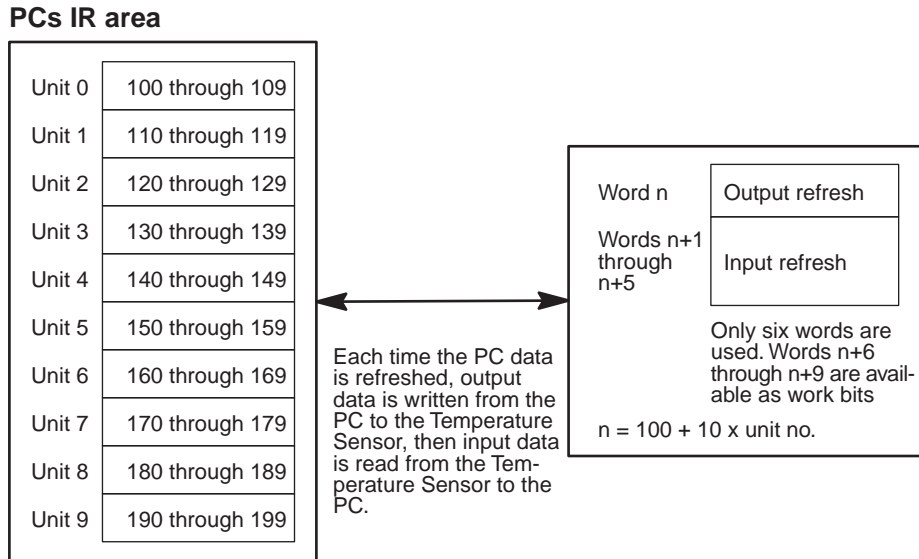

Note When setting a unit number, be sure not to select the same number used for another Special I/O Unit. Otherwise, an “I/O UNIT OVER” error is generated and the Sensor Unit will not operate properly.

3-2 Bit Allocation

Direction	Word no.	Bit																	
		15	14	13	12	11	10	09	08	07	06	05	04	03	02	01	00		
Output	n	Temperature specification enable	Temperature specification code no.: 00 through 25																Data hold
			$\times 10^1$				$\times 10^0$												
Input	n + 1	Code 0: positive 1: negative	Conversion data of Input 1																
			$\times 10^3$				$\times 10^2$				$\times 10^1$				$\times 10^0$				
	n + 2	Code 0: positive 1: negative	Conversion data of Input 2																
			$\times 10^3$				$\times 10^2$				$\times 10^1$				$\times 10^0$				
	n + 3	Code 0: positive 1: negative	Conversion data of Input 3																
$\times 10^3$				$\times 10^2$				$\times 10^1$				$\times 10^0$							
n + 4	Code 0: positive 1: negative	Conversion data of Input 4																	
		$\times 10^3$				$\times 10^2$				$\times 10^1$				$\times 10^0$					
n + 5	Running		Temperature specification code no.: 00 through 25								Data invalid	Stand by for setting	Memory error	Disconnection detected				Setting error	
			$\times 10^1$				$\times 10^0$							Input 4	Input 3	Input 2	Input 1		

Note $n = 100 + 10 \times \text{unit no.}$
 The four words from words n+6 through n+9 can be used as work bits. Refer to the *C200H Operation Manual* for details.

IR Bit Allocation

IR		Name	Function	
Word	Bit			
Output	n	00	Data hold	When this bit is turned ON, conversion of the temperature input data is stopped and data is returned to its status just prior to turning the bit ON. When this bit is turned OFF, the temperature input data is converted to BCD data in cycles.
		01 through 07	---	Always turned OFF.
		08 through 13	Temperature specification code number	These bits specify the temperature specification code number of the temperature sensing element used in the Unit. A total of 41 code numbers (thermocouple K (CA) = 11, thermocouple J (IC) = 4, L(Fe-CuNi) = 4, platinum RTD JPt = 11, platinum RTD Pt= 11 numbers) can be specified in 2-digit BCD from 00 through 25. (Refer to pages 3 and 16 for details.) The temperature specification code number becomes valid after the temperature specification setting flag (word n bit 15) is turned ON.
		14	---	Not used. Always turned OFF.
		15	Temperature specification enable	When this bit is turned ON, the temperature specification code number specified for word n bits 08 through 13 becomes valid. Be sure to confirm beforehand that the temperature specification switch (pin 3) on the back panel has been set to the ON position and that the setting standby flag (word n+5 bit 06) has also been turned ON. Otherwise the code number is invalid.

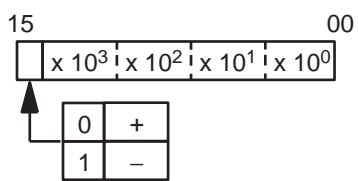
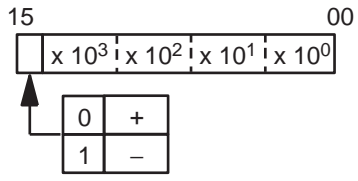
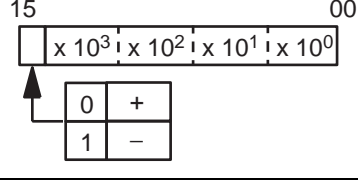
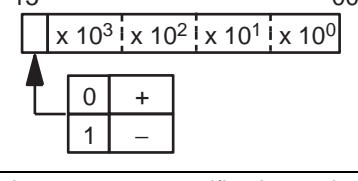
IR		Name	Function
Word	Bit		
Input	n + 1	00 through 15	Input 1 conversion The temperature input data of input 1 is displayed in BCD. 
	n + 2	00 through 15	Input 2 conversion The temperature input data of input 2 is displayed in BCD. 
	n + 3	00 through 15	Input 3 conversion The temperature input data of input 3 is displayed in BCD. 
	n + 4	00 through 15	Input 4 conversion data The temperature input data of input 3 is displayed in BCD. 
n + 5	00	Setting Error	This bit turns ON when the specified temperature specification code number (word n bits 08 through 13) results in one of the following: 1) a figure above 26; or 2) the temperature sensing element corresponds to a different specified code number than the one actually connected to the Temperature Sensor Unit. For example, if pin 4 is set for K(CA) and the temperature specification code number is set to 11-25, a setting error is generated.
	01	Input 1	Disconnection detected If a disconnection is detected in one of the inputs, the bit corresponding to that particular input turns ON. The conversion data of the word corresponding to the disconnected input (words n+1 through n+4) becomes "E039."
	02	Input 2	
	03	Input 3	
	04	Input 4	
	05	Memory error	Whenever an error occurs in the Temperature Sensor's internal memory (the memory storing the conversion data from each of the four inputs), this bit turns ON.
	06	Setting standby	This bit keeps the setting of the temperature specification code number on standby. After the temperature specification switch (pin 3) on the back panel is set to the ON position, and while the power supply is ON or during Restart, this bit remains ON until the setting is completed. When setting the temperature specification, turn the temperature specification setting flag (word n bit 15) ON. Refer to page 18 <i>Temperature specification setting flag</i> .
	07	Data invalid	After the power supply is turned ON, or after restart, the conversion data remains unstable for several seconds; during this period, this bit turns ON. Once all the data stabilizes, the bit turns OFF. While this bit is OFF, program with the conversion data from words n+1 through n+3. Refer to page 21 for conversion data listing.
08 through 13	Temperature specification code number	These bits pinpoint the current settings of the temperature specification code number and represent the confirmation area (00 through 25).	
14	---	Not used	
15	Running	Turns ON while the Unit is operating.	

SECTION 4

Settings and Displays

4-1	Temperature Specification Settings.	16
4-2	Temperature Data Display.	19

4-1 Temperature Specification Settings

Before shipment from the factory, the Temperature Sensor Unit's temperature specifications are preset for the parameters shown in the following table. If using the Unit according to these settings, keep pin 3 of the DIP switch on the back panel in the OFF position. When using the C200H-TS001 with the J-type (0° through 300°C) sensing element, or when using C200H-TS002 with the L-type (0° through 300°C) sensing element, set the K (CA)/J (IC) and K (CA)/L (Fe-CuNi) selector (pin 4) on the back panel DIP switch to the ON position.

Model	Sensor-input	Default range	Temperature specification code number
C200H-TS001	K (CA)	0° through 400°C	02
	J (IC)	0° through 300°C	12
C200H-TS002	K (CA)	0° through 400°C	02
	L (Fe-CuNi)	0° through 300°C	12
C200H-TS101	Pt 100 Ω	0° through 100°C	18
C200H-TS102	Pt 100 Ω	0° through 100°C	18

If using temperature specifications as shown in the above table, the setting sequence described in the next paragraph can be ignored. However, note that programming the temperature specification code is necessary even when one of the codes listed in the above table is used after turning ON the temperature specification selector DIP switch (pin 3) on the back panel.

Setting Temperature Specification Codes

For operation at temperatures other than those specified in the above table, program the temperature specification codes according to the following sequence:

1,2,3...

1. First set the temperature specification selector on the back panel (pin 3) to the ON position. For TS001/002, set the K (CA)/J (IC) , and K (CA) L (Fe-CuNi) selector on the back panel (pin 4) to the name of the temperature-sensing element in actual use.

OFF	K (CA) used
ON	J (IC) / L (Fe-CuNi) used

2. Set the program to the new temperature specification code of the sensing element using word n bits 13 to 08. Reset the Unit with the restart flag and check that the standby flag (word n+5 bit 06) is turned ON. Then set the program that turns ON the temperature specification setting flag (word n bit 15). Refer to page 18 for a programming example based on the above sequence.

Note Whenever the temperature specification selector (pin 3) on the back panel is set to OFF, the temperature specification code cannot be set. When the temperature specification code is set at a number beyond 26, or when a code corresponding to a temperature-sensing element that cannot be used with the Temperature Sensor Unit is selected, the setting error flag (word n+5 bit 00) turns ON to signal an alarm. Especially when using TS001/002, be sure to confirm that the K (CA)/J (IC), and K (CA)/L (Fe-CuNi) selector (pin 4) on the back panel are correctly set.

The reset flags range from AR0100 through AR0109, and correspond to respective Special I/O Unit numbers. For example, unit number 3 corresponds to reset flag AR0103.

Temperature Specification Codes

The C200H-TS001 offers 15 ranges for thermocouple input: 11 for type K (CA) sensors and 4 for type J (IC) sensors. The C200H-TS002 offers 15 ranges for thermocouple input: 11 for type K (CA) sensors, and 4 for type L (Fe-CuNi) sensors. The C200H-TS101 offers 11 ranges for platinum-RTD (JPt) input. The C200H-TS102 offers 11 ranges for platinum-RTD (PT) input. A separate code number from 00 through 25 is assigned to each Temperature Sensor/range specification.

C200H-TS001/002

Temperature-sensing element	Thermocouple		
	K (CA): chromel-alumel		J (IC): iron-constantan/ L (Fe-CuNi)
Measuring unit	°C	°F	°C
Measuring range			
Temperature specification code (2-digit BCD)	00 01 02 05 06 07 08	03 04 09 10	11 12 13 14

C200H-TS101/102

Temperature sensing element	Platinum RTD	
	JPt 100 Ω/Pt 100 Ω	
Measuring unit	°C	°F
Measuring range		
Temperature specification code (2-digit BCD)	15 16 17 18 21 22 23	19 20 24 25

Programming Example

In this example, the temperature specification code of the temperature sensing element is programmed. For this example a thermocouple K (CA), 0° through 800°C (Code 07) is used, and the Temperature Sensor Unit is set to 0.

C200H-TS001

DIP Switch Setting



OFF: Thermocouple K (CA).

ON: Temperature specification selector.

Set the temperature specification code 07 (word data #0700) for K (CA), 0° through 800°C to word 100. The specified data (code 07) is transferred to word 100.

Unit 0 restart flag

Turns ON the restart flag (AR 0100 for unit 0) during RUN and after 1 scan when (25315) or starting input (0000) is ON, then resets the Unit.

Temperature specification setting flag (sets code to 07 when this flag rises)

Confirms that the signal setting on standby (10506) is ON. Provided the alarm setting error flag (10500) is OFF, turns the temperature specification setting flag (10015) ON, and executes the setting. After the setting, the signal setting on standby turns OFF and the temperature specification setting process is ended.

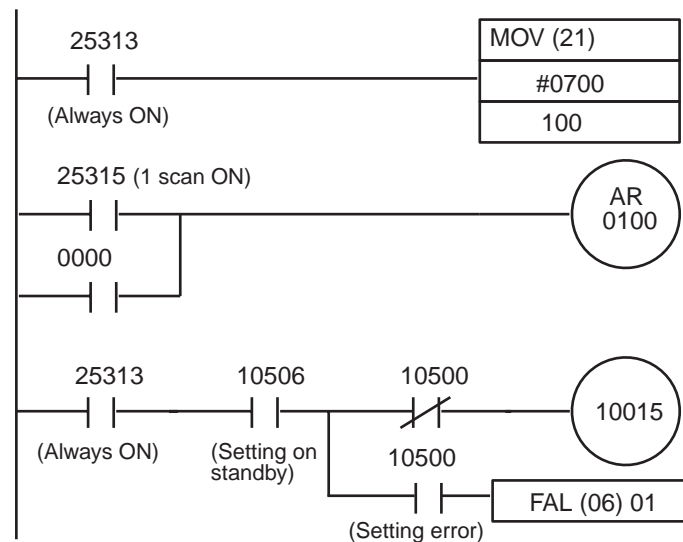

C200H-TS101

The setting switch on the back panel (pin 4) is not used. Otherwise, programming and operating functions follow the pattern described for the C200H-TS001.

Note Whenever setting the temperature specification code, be sure to turn ON DIP switch pin 3 (temperature specification selector) on the back panel. If the switch is OFF, the setting is invalid. Before setting the temperature specification, be sure the setting standby flag (10506) is ON and the setting error flag (10500) is OFF, then turn the temperature specification setting flag (10015) ON.

4-2 Temperature Data Display

The following example describes the display of temperature data when a Display Unit is connected to the Transistor Output Unit C200H-OD215. The C200H-OD215 is set as unit 2 and the C200H-TS001 is set as unit 0.

C200H-TS001 DIP Switch Setting

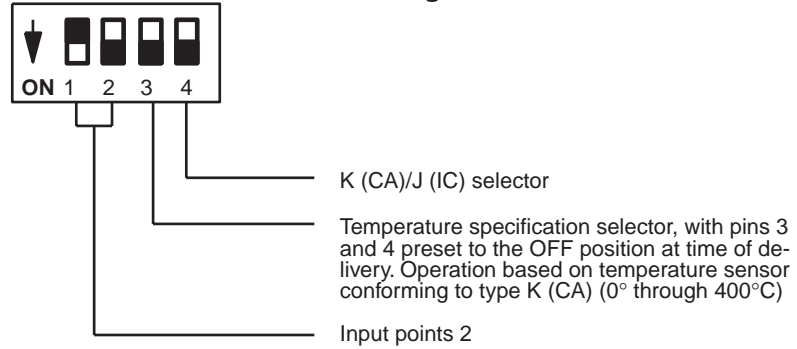

C200H-OD215 DIP Switch Setting

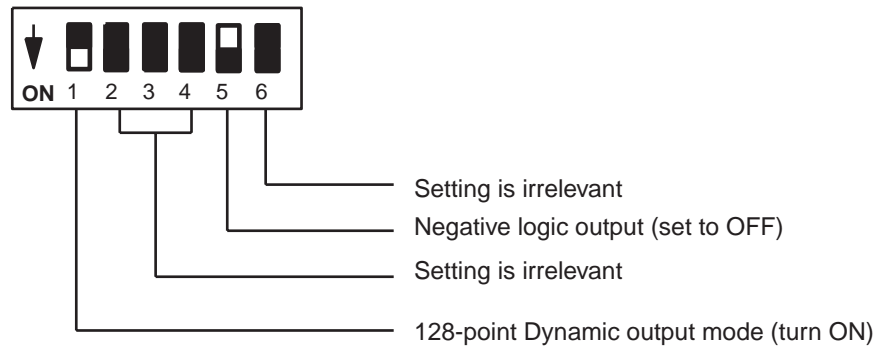

Connections

Transistor Output Unit
C200H-OD215

CN 1

Signal	Pin No.
Data 0	A1
DATA 1	A2
DATA 2	A3
DATA 3	A4
DATA 4	A5
DATA 5	A6
DATA 6	A7
DATA 7	A8
COM 0	A9
+V0	A10
NC	A11
NC	A12
STB 0	B1
STB 1	B2
STB 2	B3
STB 3	B4
STB 4	B5
STB 5	B6
STB 6	B7
STB 7	B8
COM 1	B9
+V1	B10
NC	B11
NC	B12

Display Unit

(Negative logic input,
power supply 24 VDC)

Signal
Display Data 0
Display Data 1
Display Data 2
Display Data 3
Display Data 4
Display Data 5
Display Data 6
Display Data 7
Ground
24 V
NC
NC
Output Strobe 4
Output Strobe 3
Output Strobe 2
Output Strobe 1

Signal
Display Data 0
Display Data 1
Display Data 2
Display Data 3
Display Data 4
Display Data 5
Display Data 6
Display Data 7
Ground
24 V
NC
NC
Output Strobe 4
Output Strobe 3
Output Strobe 2
Output Strobe 1

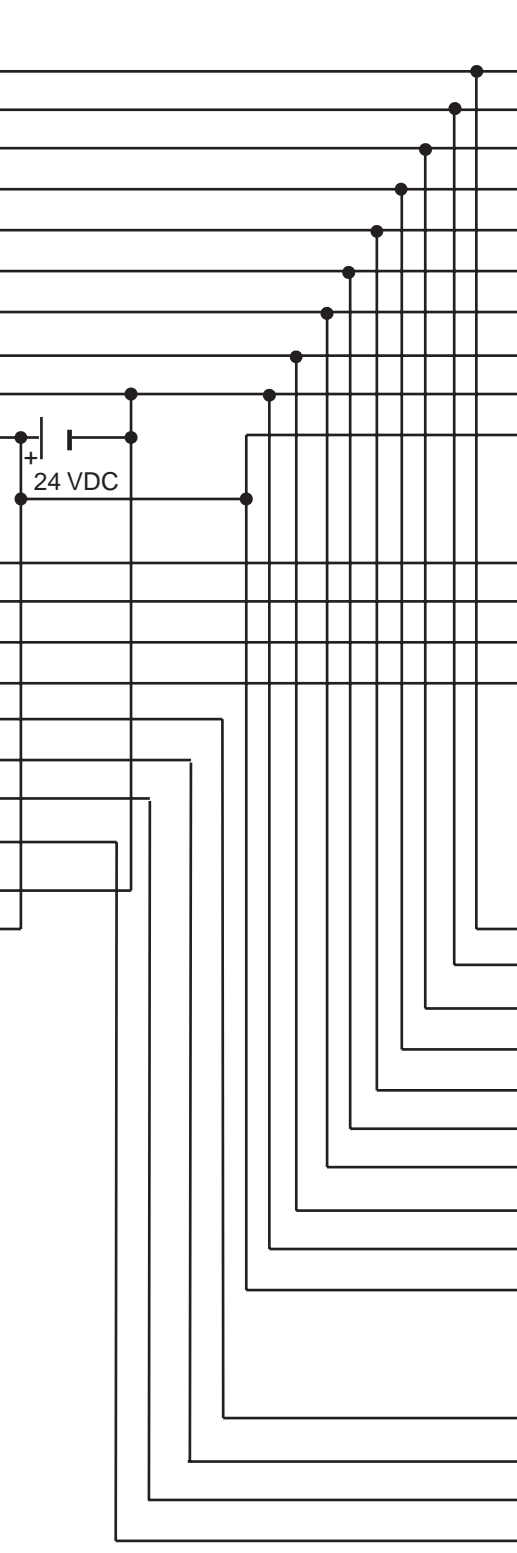

Note As the operating current is extremely small, use shielded cables for connections and/or keep wiring as distant as possible from power lines. Furthermore, keep all connections as short as possible, and not more than 10 meters in length.

Program

Masks the signal bit (10115) corresponding to the temperature data (word 101) of Input 1, and outputs to word 120 of the High-Density and Multiplex I/O Unit.

When the temperature is negative (when bit 10115 is ON), word 121 bit 15 (of the High-Density and Multiplex I/O Unit) turns ON. A negative sign is then shown on the display.

The above also applies to temperature data (word 102) of Input 2.

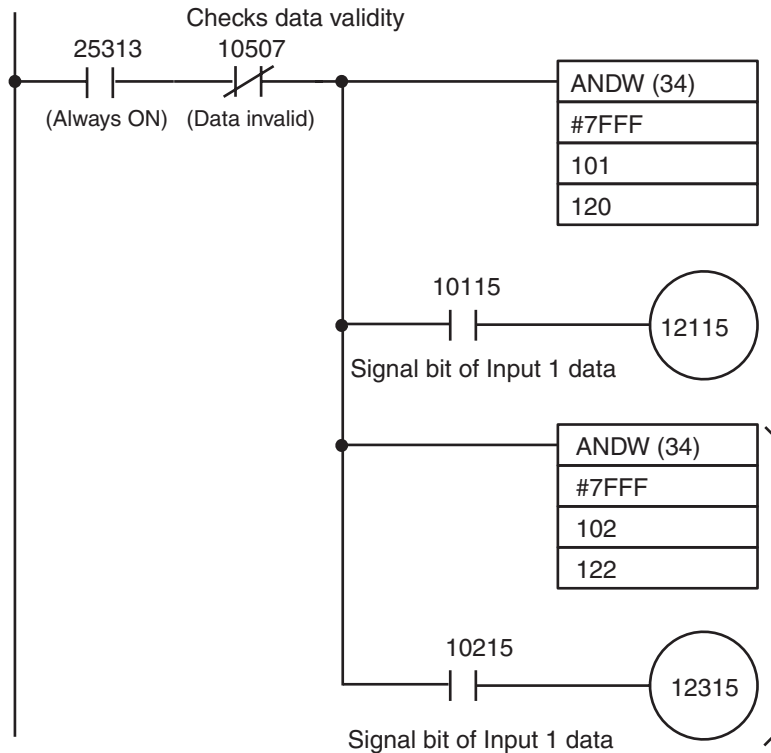

Note The Display Unit displays numerical data only if each digit is in BCD. Otherwise, the display remains blank. The display range is -9,999,999 to 9,999,999. Refer to each manual for more details on the Transistor Output Unit C200H-OD215 and Display Unit.

Input Data Conversion

The temperature data to be input is converted to 4-digit BCD in the Master and then output to the conversion words, n+1 through n+4. This conversion data has an error tolerance of 10 beyond the standard temperature range. When the conversion result is not within the tolerance range, the data of words n+1 through n+4 becomes FFFF. If the input temperature is negative, bit 15 for each of the conversion words (n+1 through n+4) turns ON and the data becomes 8XXX.

Model	Temperature-sensing element	Temperature range	Code	Conversion data (words n+1 through n+4, BCD)						
C200H-TS001/TS002	K(CA)	°C	0 to 200	00	FFFF	8020 to 8001	0000 to 0200	to 0220	FFFF	
			0 to 300	01		8030 to 8001	0000 to 0300	to 0330		
			0 to 400	02		8040 to 8001	0000 to 0400	to 0440		
			0 to 500	05		8050 to 8001	0000 to 0500	to 0550		
			0 to 600	06		8060 to 8001	0000 to 0600	to 0660		
			0 to 800	07		8080 to 8001	0000 to 0800	to 0880		
			0 to 1000	08		8100 to 8001	0000 to 1000	to 1100		
			0 to 400	03		8040 to 8001	0000 to 0400	to 0440		
	°F	0 to 500	04	8050 to 8001		0000 to 0500	to 0550			
		0 to 1000	09	8100 to 8001		0000 to 1000	to 1100			
		0 to 1600	10	8160 to 8001		0000 to 1600	to 1760			
		J (IC)/ L(Fe-Cu Ni)	°C	0 to 200		11	8020 to 8001	0000 to 0200		to 0220
				0 to 300		12	8030 to 8001	0000 to 0300		to 0330
				0 to 400		13	8040 to 8001	0000 to 0400		to 0440
0 to 500	14			8050 to 8001	0000 to 0500	to 0550				
C200H-TS101/TS102	Jpt100/ pt100	°C	-50 to 50	15	8060 to	0000 to 0050	to 0060			
			-50 to 100	16	8065 to	0000 to 0100	to 0115			
			-20 to 80	17	8030 to	0000 to 0080	to 0090			
			0 to 100	18	8010 to 8001	0000 to 0100	to 0110			
			0 to 200	21	8020 to 8001	0000 to 0200	to 0220			
			0 to 300	22	8030 to 8001	0000 to 0300	to 0330			
			0 to 400	23	8040 to 8001	0000 to 0400	to 0440			
			°F	-50 to 100	19	8065 to	0000 to 0100	to 0115		
		0 to 200		20	8020 to 8001	0000 to 0200	to 0220			
		0 to 400		24	8040 to 8001	0000 to 0400	to 0440			
		0 to 500		25	8050 to 8001	0000 to 0500	to 0550			

The diagram illustrates the range of values for the conversion data. It shows a central range from -10% F.S. to +10% F.S. with a central box labeled 'F.S.'. Arrows point to the left and right from the -10% F.S. and +10% F.S. marks, respectively, with the label 'Outside range'.

Appendix A

Troubleshooting

Should you encounter any errors during operation of the Temperature Sensor Unit, refer to the following table for corrective measures.

Error	LED indicator		Input flag word n+5			IR Words n+1 through n+4	Possible cause	Remedy
	RUN	BROKEN WIRE	05	01 to 04	00			
			Memory error	Disconnection detected	Setting error			
Outside range	Lit	Blinking	OFF	OFF	OFF	FFFF	Input exceeds tolerance of $\pm 10\%$ for the temperature specification range.	Confirm that the temperatures to be measured are within the specified range.
Disconnection	Lit	Lit	OFF	ON	OFF	E039	Disconnection detected in input. (See note 1.)	Check both the sensing element and the wiring.
Temperature specification setting error	Unlit	Unlit	OFF	OFF	ON	---	Error detected in setting of temperature specification.	Recheck the K (CA)/J (IC) selection (pin 4) on the back panel of the Unit, the specified area (word n bits 08 through 13) for the temperature specification codes, and the setting program.
Memory error	Unlit	Unlit	ON	OFF	OFF	E003 E004 E005	Internal memory (storing modified data) of Unit defective.	Disturbance from noise or irregularity in hardware are possible causes. If alarm flag does not light after removing
CPU error	Unlit	Unlit	---	---	---	---	Error detected in the watchdog timer of the Temperature Sensor. The PC registers a Special I/O Unit error.	disturbance and/or turning power ON and OFF repeatedly, call sales agent. Replacement may be necessary. (See note 2.)

- Note**
1. A broken wire is detected if the positive or negative wires of the thermocouple, or the internal A or B wires of the platinum RTD are disconnected. In this case, the input data becomes "E039." However, be careful not to confuse the B wire of the platinum RTD with the B' wire leading out from the same sensor. If the B' wire is disconnected, the input data will be FFFF.
 2. When returning the C200H-TS001/002 Temperature Sensor for repair, assemble the main body of the Unit to the terminal block connector (as originally delivered.)

C200H-TS101/102

Temperature sensing element	Platinum RTD	
	JPt 100 Ω/Pt 100 Ω	
Measuring unit	°C	°F
Measurement range	500	
	400	
	300	
	200	
	150	
	100	
	80	
	50	
	0	
	-20	
-50		
Temperature specification code (2-digit BCD)	15, 16, 17, 18, 21, 22, 23	19, 20, 24, 25

Dimensions

C200H-TS001/002/101/102

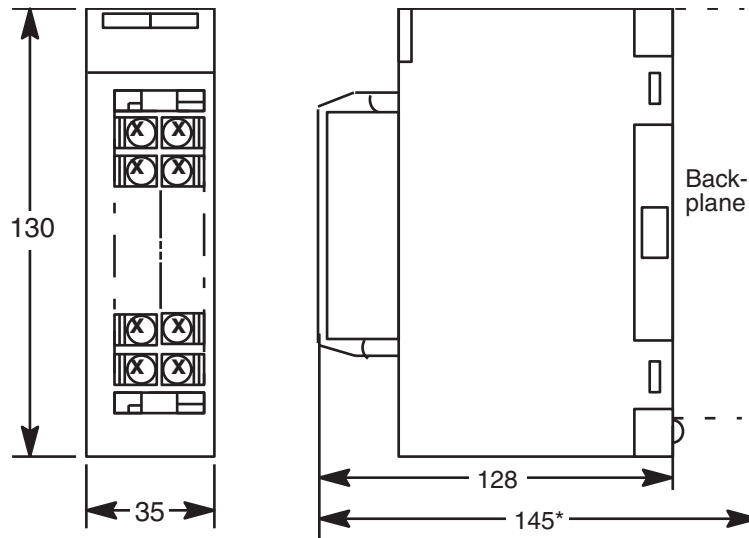

*When mounted to Backplane.

(unit: mm)

Appendix B

Standard Models

Product Name	Description	Model
Temperature Sensor	Thermocouple: K(CA) or J(IC)	C200H-TS001
	Thermocouple: K(CA) or L(Fe-CuNi) (DIN)	C200H-TS002
	Platinum resistance thermometer bulb: JPt 100 Ω	C200H-TS101
	Platinum resistance thermometer bulb: Pt 100 Ω (DIN/1989JIS)	C200H-TS102

Appendix C

Specifications

Item	C200H-TS001	C200H-TS002	CS200H-TS101	CS200H-TS102
External input signal (type of temperature sensing element).	Thermocouple: K (CA) or J (IC) Selectable	Thermocouple: K (CA) or L (Fe-CuNi) (DIN) Selectable	Platinum resistance thermometer bulb: JPt 100 Ω	Platinum resistance thermometer bulb: Pt 100 Ω (DIN/ 1989 JIS)
External input points	4 points max. per Unit (1, 2, or 4 points selectable)			
Output code to PC	4-digit BCD			
Accuracy	± (1% Full scale + 1°C) max. (See note.)			
Conversion time	1.2 sec max. per point			
Conversion cycle	4.8 sec max. at 4 points per Unit 2.4 sec max. at 2 points per Unit 1.2 sec max. at 1 point per Unit			
PC booting time	Conversion cycle + 1 PC scan time			
Terminal connections	Terminal block (removable)			
Insulation mode	Non-insulated between words. Insulated by photocoupler between input terminal and PC signals.			
Internal power supply	450 mA max. at 5 VDC			
External dimensions	35 (W) x 130 (H) x 128 (D)			
Weight	400 g max.			

Note For example, at a specification of 0° through 400°C, 400°C x 1% + 1°C = ±5°C max.

Input Specifications





C200H-TS001/002

Temperature sensing element	Thermocouple		
	K (CA): chromel-alumel		J (IC): iron-constantan/ L (Fe-CuNi)
Measuring unit	°C	°F	°C
Measurement range			
Temperature specification code (2-digit BCD)	00, 01, 02, 05, 06, 07, 08	03, 04, 09, 10	11, 12, 13, 14

Appendix D

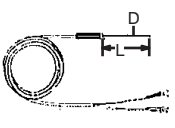
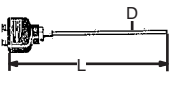
Table of Temperature Sensing Elements

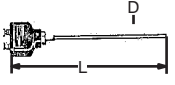
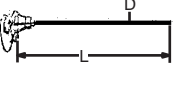
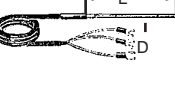
General Purpose

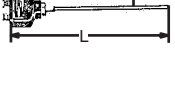
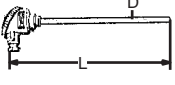
Appearance	Model no.	Length (L) of protecting tube (mm)	Diameter (D) of protecting tube (mm)
	E52-__15A	150	1, 1.6, 3.2
	E52-__20A	200	1, 1.6, 3.2, 4.8, 6.4, 8
	E52-__35A	350	1, 1.6, 3.2, 4.8, 6.4, 8
	E52-__50A	500	3.2, 4.8, 6.4, 8
	E52-__20B	200	3.2, 4.8, 6.4,
	E52-__35B	350	3.2, 4.8, 6.4, 8
	E52-__50B	500	3.2, 4.8, 6.4, 8
	E52-__75B	750	4.8, 6.4, 8
	E52-__20C	200	3.2, 4.8, 6.4
	E52-__35C	350	3.2, 4.8, 6.4, 8
	E52-__50C	500	3.2, 4.8, 6.4, 8
	E52-__75C	750	4.8, 6.4, 8
	E52-__35B	350	10, 12, 15
	E52-__50B	500	10, 12, 15 22
	E52-__75B	750	10, 12, 15 22
	E52-__100B	1000	10, 12, 15 22
	E52-__35C	350	10, 12, 15
	E52-__50C	500	10, 12, 15 22
	E52-__75C	750	10, 12, 15 22
	E52-__100C	1000	10, 12, 15 22
	E52-PT15A	150	3.2
	E52-PT20A	200	3.2, 4.8, 6.4
	E52-PT35A	350	3.2, 4.8, 6.4
	E52-PT50A	500	4.8, 6.4
	E52-PT20C	200	3.2, 4.8, 6.4
	E52-PT35C	350	3.2, 4.8, 6.4
	E52-PT50C	500	3.2, 4.8, 6.4
	E52-PT75C	750	4.8, 6.4
	E52-PT20B	200	8
	E52-PT35B	350	8, 10
	E52-PT50B	500	8, 10
	E52-PT75B	750	10
	E52-PT100B	1000	10
	E52-PT20C	200	8
	E52-PT35C	350	8, 10
	E52-PT50C	500	8, 10
	E52-PT75C	750	10
	E52-PT100C	1000	10

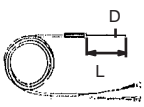
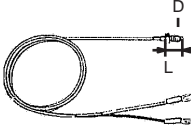
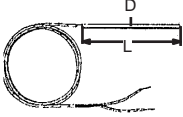
Appearance	Model no.	Length (L) of protecting tube (mm)	Diameter (D) of protecting tube (mm)
	E52-__6AS	60	4.8
	E52-__10AS	100	4.8
	E52-__15AS	150	4.8
	E52-__20AS	200	4.8
	E52-__1D	10	Screw pitch W1/4, M6, M8
	E52-__6F	60	4
	E52-__6D	60	4
	E52-__10AE	100	3.2
	E52-PT10AE	100	3.2
	E52-PT6D	60	4
	E52-PT6F	60	4

Sensor	Element	Style	Grade	Model no.	Shape of terminal box	Quality of tube	Temperature range**			
Sheathed thermocouple	K (CA) J (IC) (See note 1.)	No ground	0.75	E52-__15A	Open lead wire	SUS 316 Inconel (See note 3.)	0° to 1050°C			
				E52-__20A						
				E52-__35A						
				E52-__50A						
				E52-__20B	Exposed terminal					
				E52-__35B						
				E52-__50B						
				E52-__75B	Covered terminal					
				E52-__20C						
				E52-__35C						
				E52-__50C						
Universal thermocouple				E52-__75C						
				E52-__35B				Exposed terminal		
				E52-__50B						
				E52-__75B						
				E52-__100B				Covered terminal		
				E52-__35C						
				E52-__50C						
E52-__75C										
				E52-__100C						
				E52-PT15A				Open lead wire	SUS 316	-200° to 450°C
				E52-PT20A						
				E52-PT35A						
				E52-PT50A						
				E52-PT20C				Covered terminal		
				E52-PT35C						
E52-PT50C										
E52-PT75C										
Universal platinum resistance thermometer bulb	JPt 100 Ω	Three-wire	0.5	E52-PT20B	Exposed terminal	SUS 316	0° to 400°C			
				E52-PT35B						
				E52-PT50B						
				E52-PT75B						
				E52-PT100B						
				E52-PT20C	Covered terminal					
				E52-PT35C						
				E52-PT50C						
				E52-PT75C						
				E52-PT100C						

Sensor	Element	Style	Grade	Model no.	Shape of terminal box	Quality of tube	Temperature range**
Low-cost Thermocouple	K (CA) J (IC) (See note 1.)	No ground	0.75	E52-__6AS	Open lead wire	SUS 304	0° to 400°C
				E52-__10AS			
				E52-__15AS			
		Ground		E52-__20AS			
				E52-__1D			
				E52-__6F			
		No ground		E52-__6D			
				E52-__10AE			
Low-cost Platinum resistance thermometer bulb	JPt 100 Ω	Three-wire	0.5	E52-__PT10AE			-50° to 250°C
				E52-__PT6D			
				E52-__PT6F			

- Note**
1. In this table, each model number preceded by a dash, e.g., E52-__15A, can be either K(CA) or J(IC).
 2. JIS standard signals
 3. Actual temperature range will vary with the diameter of the protecting tube.
 4. K(CA) only

K Standard Thermoelectromotive Force

JIS-C 1602-1981 Unit: μV

Temperature (°C)	0	10	20	30	40	50	60	70	80	90	Temperature (°C)
0	0	397	798	1203	1611	2022	2436	2850	3266	3681	0
100	4095	4508	4919	5327	5733	6137	6539	6939	7338	7737	100
200	8137	8537	8938	9341	9745	10151	10560	10969	11381	11793	200
300	12207	12623	13039	13456	13874	14292	14712	15132	15552	15974	300
400	16395	16818	17241	17664	18088	18513	18938	19363	19788	20214	400
500	20640	21066	21493	21919	22346	22772	23198	23624	24050	24476	500
600	24902	25327	25751	26176	26599	27022	27445	27867	28288	28709	600
700	29128	29547	29965	30383	30799	31214	31629	32042	32455	32866	700
800	33277	33686	34095	34502	34909	35314	35718	36121	36524	36925	800
900	37325	37724	38122	38519	38915	39310	39703	40096	40488	40879	900
1000	41269	41657	42045	42432	42817	43202	43585	43968	44349	44729	1000
1100	45108	45486	45863	46238	46612	46985	47356	47726	48095	48462	1100
1200	48828	49192	49555	49916	50276	50633	50990	51344	51697	52049	1200
1300	52398	52747	53093	53439	53782	54125	54466	54807	---	---	1300

J Standard Thermoelectromotive Force

JIS-C 1602-1981 Unit: μV

Temperature (°C)	0	10	20	30	40	50	60	70	80	90	Temperature (°C)
0	0	507	1019	1536	2058	2585	3115	3649	4186	4725	0
100	5268	5812	6359	6907	7457	8008	8560	9113	9667	10222	100
200	10777	11332	11887	12442	12998	13553	14108	14663	15217	15771	200
300	16325	16879	17432	17984	18537	19089	19640	20192	20743	21295	300
400	21846	22397	22949	23501	24054	24607	25161	25716	26272	26829	400
500	27388	37949	28511	29075	29642	30210	30782	31356	31933	32513	500
600	33096	33683	34273	34867	35464	36066	36671	37280	37893	38510	600
700	39130	39754	40382	41013	41647	42283	42922	43563	44207	44852	700
800	45498	46144	46790	47434	48076	48716	49354	49989	50621	51249	800
900	51875	52496	53115	53729	54351	54948	55553	56155	56753	57349	900
1000	57942	58533	59121	59708	60293	60876	61459	62039	62619	63199	1000
1100	63777	64355	64933	65510	66087	66664	67240	67815	68390	68964	1100
1200	69536	---	---	---	---	---	---	---	---	---	1200

Note The temperature of standard contact should be 0°C.

L (Fe-CuNi) Standard Thermoelectromotive Force

DIN 1985 43710 Unit: μV

Temperature (°C)	0	10	20	30	40	50	60	70	80	90	Temperature (°C)
0	0	520	1050	1580	2110	2650	3190	3730	4270	4820	0
100	5370	5920	6470	7030	7590	8150	8710	9270	9830	10390	100
200	10950	11510	12070	12630	13190	13750	14310	14880	15440	16000	200
300	16560	17120	17680	18240	18800	19360	19920	20480	21040	21600	300
400	22160	22720	23290	23860	24430	25000	25570	26140	26710	27280	400
500	27850	28430	29010	29590	30170	30750	31330	31910	32490	33080	500
600	33670	34260	34850	35440	36040	36640	37250	37850	38470	39090	600
700	39720	40350	40980	41620	42270	42920	43570	44230	44890	45550	700
800	46220	46890	47570	48250	48940	49630	50320	51020	51720	52430	800

Note The temperature of standard contact should be 0°C.

Platinum Resistance Thermometer Bulb JPt 100 Ω Standard Thermoelectromotive Force ($R_0 = 100 \Omega$ $R_{100}/R_0 = 1.3916$)

JIS C1604 1989 Unit: Ω

Temperature (°C)	-100	0	Temperature (°C)	0	100	200	300	400	500
0	59.57	100.00	0	100.00	139.16	177.13	213.93	249.56	284.02
-10	55.44	96.02	10	103.97	143.01	180.86	217.54	253.06	---
-20	51.29	92.02	20	107.93	146.85	184.58	221.15	256.55	---
-30	47.11	88.01	30	111.88	150.67	188.29	224.74	260.02	---
-40	42.91	83.99	40	115.81	154.49	191.99	228.32	263.49	---
-50	38.68	79.96	50	119.73	158.29	195.67	231.89	266.94	---
-60	34.42	75.91	60	123.64	162.08	199.35	235.45	270.38	---
-70	30.12	71.85	70	127.54	165.86	203.01	238.99	273.80	---
-80	25.80	67.77	80	131.42	169.63	206.66	242.53	277.22	---
-90	21.46	63.68	90	135.30	173.38	210.30	246.05	280.63	---
-100	17.14	59.57	100	139.16	177.13	213.93	249.56	284.02	---

Note The temperature of standard contact should be 0°C.

Platinum Resistance Thermometer Bulb Pt 100 Ω Standard Thermoelectromotive Force ($R_0 = 100 \Omega$ $R_{100}/R_0 = 1.3850$)

DIN 43760 1980, JIS C1604 1989 Unit: Ω

Temperature (°C)	-100	0	Temperature (°C)	0	100	200	300	400	500	600
0	60.25	100.00	0	100	138.50	175.84	212.02	247.04	280.90	313.59
-10	56.19	96.09	10	103.90	142.29	179.51	215.57	250.48	284.22	316.80
-20	52.11	92.16	20	107.79	146.06	183.17	219.12	253.90	287.53	319.99
-30	48.00	88.22	30	111.67	149.82	186.82	222.65	257.32	290.83	323.18
-40	43.87	84.27	40	115.54	153.58	190.45	226.17	260.72	294.11	326.35
-50	39.71	80.31	50	119.40	157.31	194.07	229.67	264.11	297.39	329.51
-60	35.53	76.33	60	123.24	161.04	197.69	233.17	267.49	300.65	---
-70	31.32	72.33	70	127.07	164.76	201.29	236.65	270.86	303.91	---
-80	27.08	68.33	80	130.89	168.46	204.88	240.13	274.22	307.15	---
-90	22.80	64.30	90	134.70	172.16	208.45	243.59	277.56	310.38	---
-100	18.49	60.25	100	138.50	175.84	212.02	247.04	280.90	313.59	---

Note The temperature of standard contact should be 0°C.

Appendix E

Using the C200H Temperature Sensor Unit with CS1-series PCs

I/O Allocation

When using the C200H Temperature Sensor Unit with a CS1-series PC, the first word, n, of I/O memory allocated to a Unit will be given by $n = 2000 + \text{unit no.} \times 10$ (not $n = 100 + 10 \times \text{unit no.}$). Other than this, there are no points that need particular attention.

Data Configuration

Bit Allocation

The following table shows the bit allocation for the Temperature Sensor Unit when using a CS1-series PC.

Word no.	Bit	Allocation	Contents	Direction
n	0 to 15	Commands from CPU Unit	Temperature specification code no.	CPU to Temperature Sensor Unit
n + 1		Analog input status	Conversion data of input 1	Temperature Sensor Unit to CPU
n + 2			Conversion data of input 2	
n + 3			Conversion data of input 3	
n + 4			Conversion data of input 4	
n + 5			Disconnection detection, setting errors etc.	

Note In the above table, $n = 2000 + \text{unit no.} \times 10$.

DM Area allocation

The DM area is not used.

Settings and Operation

Initial Settings (Hardware Settings)

Make the following settings before using the Temperature Sensor Unit.

- 1,2,3...**
1. Using the DIP switch on the back panel of the Temperature Sensor Unit, set the number of input points and the sensor type.
 2. Using the switch on the front panel, set the unit number.
 3. Mount to a CS1 CPU Rack, a C200H Expansion I/O Rack, a CS1 Expansion I/O Rack or a SYSMAC BUS Remote I/O Slave Unit. In the basic configuration up to 10 Units can be mounted. (There are no restrictions with regard to mounting position.)
 4. Connect the Temperature Sensor.
 5. Connect the Programming Device to the PC.
 6. Turn ON power for the PC.
 7. Create I/O tables.

Ladder Program

Make the following settings using the ladder program.

- 1,2,3...**
1. Set the temperature specification code (range) using the MOV instruction.
 2. Read temperature data using the MOV instruction.

Ladder Program

The ladder program is used in the following way.

- 1,2,3...**
1. The temperature specification code (word n) is set with the MOV instruction using the always ON flag as the input condition.
 2. If the signal setting on standby (word n + 5, bit 06) is ON and the setting error flag (word n + 5, bit 00) is OFF, the temperature specification setting flag (word n, bit 15) will be turned ON, using for example, the OUT instruction.

Programming Example

The following example shows how to set the temperature specification code using the ladder program, when using the C200H-TS001.

In this example, the temperature specification code of the temperature sensing element is programmed. For this example a thermocouple K (CA), 0° through 800°C (Code 07) is used and the unit number of the Temperature Sensor Unit is set to 0.

DIP Switch Setting

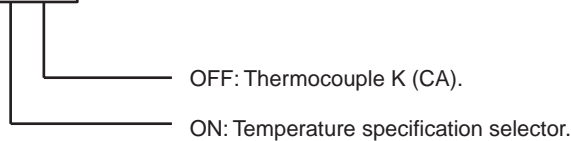

Set the temperature specification code 07 (word data #0700) for K (CA), 0° through 800°C to word 2000 (word n). The specified data (code 07) is transferred to word 2000.

Unit 0 Restart Flag

Turns ON the restart flag and turns ON the Temperature Sensor Unit after one scan at startup or when starting input “a” is ON.

Temperature Specification Setting flag (Sets Code to 07 when this Flag Rises)

Confirms that the signal setting on standby (200506) is ON. Provided the alarm setting error flag (200500) is OFF, turns the temperature specification setting flag (200015) ON, and executes the setting. After the setting, the signal setting on standby turns OFF, the temperature specification setting flag turns OFF, and the temperature specification setting process ends. If a setting error (200500) occurs, the FAL instruction will be executed, and a user-defined non-fatal error will be generated.

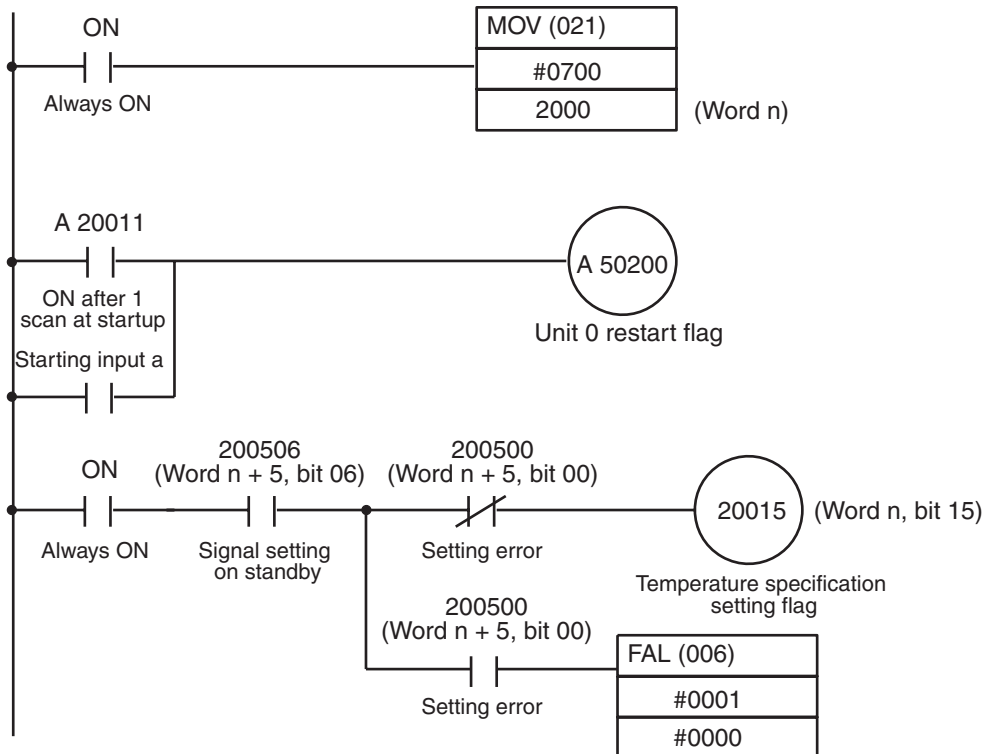

Glossary

address	The location in memory where data is stored. For data areas, an address consists of a two-letter data area designation and a number that designate the word and/or bit location. For the UM area, an address designates the instruction location (UM area); for the FM area, the block location (FM area), etc.
allocation	The process by which the PC assigns certain bits or words in memory for various functions. This includes pairing I/O bits to I/O points on Units.
AR area	A PC data area allocated to flags, control bits, and word bits.
ASCII	Short for American Standard Code for Information Interchange. ASCII is used to code characters for output to printers and other external devices.
Backplane	A base to which Units are mounted to form a Rack. Backplanes provide a series of connectors for these Units along with wiring to connect them to the CPU and Power Supply. Backplanes also provide connectors used to connect them to other Backplanes. In some Systems, different Backplanes are used for different Racks; in other Systems, Racks differ only by the Units mounted to them.
back-up	A copy of existing data which is valuable if data is accidentally erased.
BCD	Short for binary-coded decimal.
BCD calculation	An arithmetic calculation that uses numbers expressed in binary-coded decimal.
binary-coded decimal	A system used to represent numbers so that each four binary bits is numerically equivalent to one decimal digit.
bit	The smallest piece of information that can be represented on a computer. A bit has the value of either zero or one, corresponding to the electrical signals ON and OFF. A bit is one binary digit.
bit address	The location in memory where a bit of data is stored. A bit address must specify (sometimes by default) the data area and word that is being addressed as well as the number of the bit.
bit number	A number that indicates the location of a bit within a word. Bit 00 is the rightmost (least-significant) bit; bit 15 is the leftmost (most-significant) bit.
block instruction	A special class of instruction used within ladder-diagram programming to allow flowchart-like coding, which is often difficult to write with ladder diagrams. Function codes for block instructions are indicated between pointed parentheses<like this>.
block program	A section of program written within a ladder diagram but based on block instructions. Block programs can also contain some, but not all, of the ladder-diagram instructions.
building-block PC	A PC that is constructed from individual components, or“ building blocks.” With building- block PCs, there is no one Unit that is independently identifiable as a PC. The PC is rather a functional assembly of components.

Glossary

carry flag	A flag that is used with arithmetic operations to hold a carry from an addition or multiplication operation, or to indicate that the result is negative in a subtraction operation. The carry flag is also used with certain types of shift operations.
central processing unit	A device that is capable of storing a program and data, and executing the set of instructions contained in the program. In a PC System, the central processing unit executes the program, processes I/O signals, communicates with external devices, etc.
channel	See "word"
control bit	A bit in a memory area that is set either through the program or via a Programming Device to achieve a specific purpose, e.g., a Result bit is turned ON and OFF to restart a Unit.
counter	A PC function that counts the number of occurrences of a certain event.
CPU	An acronym for central processing unit.
CPU Backplane	A Backplane used to create a CPU Rack.
CPU Rack	Part of a Rack PC, the CPU Rack contains the CPU, a Power Supply, and other Units.
data area	An area in the PC's memory that is designed to hold a specific type of data, e.g., the LR area is designed to hold common data in a PC Link System. Memory areas that hold programs are not considered data areas.
data area boundary	The highest address available in a data area. When designating an operand that requires multiple words, it is necessary that the highest address in the data area is not exceeded.
default condition	The original condition of a function or system. For example, the FIT's default condition is to start from its hard drive, but this default condition can be changed so that it starts from a floppy disk drive.
digit	A unit of storage in memory that consists of four bits.
DM area	A data area used to hold word data. A word in the DM area cannot be accessed bit by bit.
EEPROM	[E(lectrically) E(rasable) P(rogrammable) R(ead) O(nly) M(emory)] A type of ROM in which stored data can be erased and reprogrammed. This is accomplished using a special control lead connected to the EEPROM chip and can be done without having to remove the EEPROM chip from the device in which it is mounted.
EPROM	[E(rasable) P(rogrammable) R(ead) O(nly) M(emory)] A type of ROM in which stored data can be erased, by ultraviolet light or other means, and reprogrammed.
Expansion I/O Backplane	A Backplane used to create an Expansion I/O Rack.
Expansion I/O Rack	Part of a Rack PC, an Expansion I/O Rack is connected to a CPU Rack to increase the number of slots available for mounting Units.

Glossary

Expansion I/O Unit	An I/O Unit for a Packagetype PC that provides more I/O points to the PC.
expansion slot	Allows FIT to be modified by addition of optional circuit cards. These circuit cards are made by OMRON and other companies to customize systems for particular functions.
flag	A bit that is turned ON and OFF automatically by the system in order to provide status information.
hardware error	An error originating in the hardware structure (electronic components) of the PC, as opposed to a software error, which originates in software (i.e., programs).
hexadecimal	Number system used to represent numbers in base 16 with digits 0,1,2...9,A,B...F.
increment	Increasing a numeric value.
indirect address	An address whose contents indicates another address. The contents of the second address will be used as the operand. Indirect addressing is possible in the DM area only.
instruction execution time	The time required to execute an instruction. The execution time for any one instruction can vary with the execution conditions for the instruction and the operands used within it.
instruction line	A group of conditions that lie together on the same horizontal line of a ladder diagram. Instruction lines can branch apart or join together to form instruction blocks.
interface	An interface is the conceptual boundary between systems or devices and usually involves changes in the way the communicated data is represented. Interface devices such as NSBs perform operations like changing the coding, format, or speed of the data.
I/O capacity	The number of inputs and outputs that a PC is able to handle. This number ranges from around one hundred for smaller PCs to two thousand for the largest ones.
I/O Control Unit	A Unit mounted to the CPU Rack in certain PCs to monitor and control I/O points on Expansion I/O Units.
I/O point	The place at which an input signal enters the PC System or an output signal leaves the PC System. In physical terms, an I/O point corresponds to terminals or connector pins on a Unit; in terms of programming, an I/O point corresponds to an I/O bit in the IR area.
I/O Unit	The most basic type of Unit mounted to a Backplane. I/O Units include Input Units and Output Units, each of which is available in a range of specifications. I/O Units do not include Special I/O Units, Link Units, etc.
I/O word	A word in the IR area that is allocated to a Unit in the PC System.
IR area	A data area whose principal function is to hold the status of inputs coming into the system and that of outputs that are to be set out of the system. Bits and

Glossary

words in the IR that are used this way are called I/O bits and I/O words. The remaining bits in the IR area are work bits.

ladder diagram (program)	A form of program arising out of relay- based control systems that uses circuit- type diagrams to represent the logic flow of programming instructions. The appearance of the program is similar to a ladder, and thus the name.
ladder diagram symbol	A symbol used in a ladder diagram program.
ladder instruction	An instruction that represents the “rung” portion of a ladder- diagram program. The other instructions in a ladder diagram fall along the right side of the diagram and are called terminal instructions.
LOAD instruction	Starts the operation of a line of programming. Each new line off the bus bar has an address number, a LD instruction, and a relay number.
LR area	A data area that is used in a PC Link System so that data can be transferred between two or more PCs. If a PC Link System is not used, the LR area is available for use as work bits.
Master	Short for Remote I/O Master Unit.
normal condition	A condition that produces an ON execution condition when the bit assigned to it is ON, and an OFF execution condition when the bit assigned to it is OFF.
OFF	The status of an input or output when a signal is said not to be present. the OFF state is generally represented by a low voltage or by non-conductivity, but can be defined as the opposite of either.
OFF delay	The delay between the time when a signal is switched OFF (e.g., by an input device or PC) and the time when the signal reaches a state readable as an OFF signal (i.e., as no signal) by a receiving party (e.g., output device or PC).
ON	The status of an input or output when a signal is said to be present. The ON state is generally represented by a high voltage or by conductivity, but can be defined as the opposite of either.
ON delay	The delay between the time when an ON signal is initiated (e.g., by an input device or PC) and the time when the signal reaches a state readable as an ON signal by a receiving party (e.g., output device or PC).
operating error	An error that occurs during actual PC operation as opposed to an initialization error, which occurs before actual operations can begin.
OR	A logic operation whereby the result is true if either of two premises is true, or if both are true. In ladder-diagram programming the premises are usually ON/ OFF states of bits or the logical combination of such states called execution conditions.
output	The signal sent from the PC to an external device. The term output is often used abstractly or collectively to refer to outgoing signals.
output bit	A bit in the IR area that is allocated to hold the status to be sent to an output device.

Glossary

output signal	A signal being sent to an external device. Generally an output signal is said to exist when, for example, a connection point goes from low to high voltage or from a nonconductive to a conductive state.
parity	Adjustment of the number of ON bits in a word or other unit of data so that the total is always an even number or always an odd number. Parity is generally used to check the accuracy of data after being transmitted by confirming that the number of ON bits is still even or still odd.
PC	An acronym for Programmable Controller.
peripheral device	Devices connected to a PC System to aid in system operation. Peripheral devices include printers, programming devices, external storage media, etc.
port	A connector on a PC or computer that serves as a connection to an external device.
Power Supply	A Unit that mounts to a Backplane in a Rack PC. It provides power at the voltage required by the other Units on the Rack.
present value	The current value registered in a device at any instant during its operation. Present value is abbreviated as PV.
Programmable Controller	A small, computer-like device that can control peripheral equipment, such as an electric door or quality control devices, based on programming and peripheral input devices. Any process that can be controlled using electrical signals can be controlled by a PC. PCs can be used independently or networked together into a system to control more complex operations.
programmed alarm	An alarm given as a result of the execution of an instruction designed to generate the alarm in the program, as opposed to one generated by the system.
programmed error	An error arising as a result of the execution of an instruction designed to generate the error in the program, as opposed to one generated by the system.
programmed message	A message generated as a result of execution of an instruction designed to generate the message in the program, as opposed to one generated by the system.
PROM	[P(rogrammable) R(ead) O(nly) M(emory)] A type of ROM into which the program or data may be written after manufacture, by a customer, but which is fixed from that time on.
PROM programmer	A PROM programmer is a device used to write data to ROM, PROM, and EPROM storage devices.
Rack	An assembly that forms a functional unit in a Rack PC System. A Rack consists of a Backplane and the Units mounted to it. These Units include the Power Supply, CPU, and I/O Units. Racks include CPU Racks, Expansion I/O Racks, and I/O Racks. The CPU Rack is the Rack with the CPU mounted to it. An Expansion I/O Rack is an additional Rack that holds extra I/O Units. An I/O Rack is used in the C2000H Duplex System, because there is no room for any I/O Units on the CPU Rack in this System.

Glossary

Rack PC	A PC that is composed of Units mounted to one or more Racks. This configuration is the most flexible, and most large PCs are Rack PCs. A Rack PC is the opposite of a Package-type PC, which has all of the basic I/O, storage, and control functions built into a single package.
refresh	The process of updating output status sent to external devices so that it agrees with the status of output bits held in memory and of updating input bits in memory so that they agree with the status of inputs from external devices.
reset	The process of turning a bit or signal OFF or of changing the present value of a timer or counter to its set value or to zero.
RUN mode	The operating mode used by the PC for normal control operations.
scan	The process used to execute a ladder-diagram program. The program is examined sequentially from start to finish and each instruction is executed in turn based on execution conditions.
scan time	The total time it takes the PC to perform internal operations, i.e., reset the watchdog timer, read the program, receive input data, send output data, and execute instructions. Scan time is monitored by the watchdog timer within the PC, and if it takes longer than a certain specified amount of time, an error message may be generated, or the CPU may just stop. Scan times will differ depending on the configuration of the system.
sensor	An input device that “senses” a property of the real world and relays it to the Control System. The property can be a measurement of an object, or simply a signal indicating the presence of the object.
Slave	Short for Remote I/O Slave Unit.
Slave Rack	A rack containing a Remote I/O Slave Unit and controlled through a remote I/O Master Unit. Slave Racks are generally located away from the CPU Rack.
Special I/O Unit	A dedicated Unit that is designed for a specific purpose. Special I/O Units include Position Control Units, High-Speed Counters, Analog I/O Units, etc.
switch	An input device that sends either an ON or OFF signal to the Control System. A switch can be operated either by a person or by the movement of a piece of equipment or material.
TC area	A data area that can be used only for timers and counters. Each bit in the TC area serves as the access point for the SV, PV, and Completion flag for the timer or counter defined with that bit.
TC number	A definer that corresponds to a bit in the TC area and used to define the bit as either a timer or counter.
TM area	A memory area used to store the results of a trace.
TR area	A data area used to store execution conditions so that they can be reloaded later for use with other instructions.
UM area	The memory area used to hold the active program, i.e., the program that is being currently executed.

Glossary

Unit	In OMRON PC terminology, the word Unit is capitalized to indicate any product sold for a PC System. Though most of the names of these products end with the word Unit, not all do, e.g., a Remote Terminal is referred to in a collective sense as a Unit. Context generally makes any limitations of this word clear.
unit number	A number assigned to some Link Units and Special I/O Units to facilitate identification when assigning words or other operating parameters to it.
watchdog timer	A timer within the system that ensures that the scan time stays within specified limits. When limits are reached, either warnings are given or PC operation is stopped depending on the particular limit that is reached.
word	In digital circuits, a group of bits. Usually a word consists of four, eight, or sixteen bits. In C-series PCs, a word consists of sixteen bits. Words can be used to store data, or they can be used for I/O.
work bit	A bit in a work word.

Index

Symbols

"I/O Unit Over" error, 12

A–C

applications

precautions, xiii

Binary Coded Decimal, 2, 4, 13, 21

cold-junction compensating resistor, 3, 8

D–H

DIP switch setting, 3–4, 16, 18

CS1 Series, 36

Display Unit, 19, 21

error flag, 16, 18

High-Density and Multiplex I/O Unit, 21

I

input points, 3

inputs

RTD, 8

thermocouple, 8

installation

precautions, xiii

IR word numbers, 2

L–N

LEDs, 3

Master, 21

mounting, 4–5

noise, 9

nomenclature, 2

O–P

operating environment

precautions, xiii

platinum resistance sensors, 2

precautions

applications, xiii

general, xii

operating environment, xiii

safety, xii

Programmable Controller, 2, 4

R

Racks, 5

reset flag, 16

restart flag, 16

S

safety precautions

See also precautions

signal wire, 9

Slave Rack, 5

Special I/O Units, 2, 5

standby flag, 16, 18

T

temperature selector, 3

temperature specification code number, 14

temperature specification setting flag, 16, 18

thermocouple, 2

Transistor Output Unit, 20–21

U–W

unit number, 4, 12

unit number selector, 2

work bits, 13

Revision History

A manual revision code appears as a suffix to the catalog number on the front cover of the manual.

Cat. No. W124-E1-5

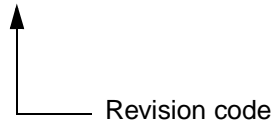

The following table outlines the changes made to the manual during each revision. Page numbers refer to the previous version.

Revision code	Date	Revised content
1	February 1989	Original production
2	July 1989	Redundancies removed, and general cleaning of text and graphics.
3	December 1990	The C200H-TS002/102 were added.
	May 1991	Reformatted.
4	September 1999	Page ix : <i>About this Manual</i> corrected. Page xi : <i>PRECAUTIONS</i> added. Page 9 : Tightening torque changed from 0.8 kg/cm to 0.8 N • m in the diagram. Page 39 : Appendix E added to provide information relating to CS1-series PCs.
5	April 2000	Front cover : "GUIDE" changed to "MANUAL." Page 9 : Information on reducing noise added.

