

# SIEMENS

## SIMATIC

## C7-635 Control System

### Manual

Preface, Contents

---

Document Guide

---

Product Overview

---

Installing and Wiring the C7-635

---

Special Features of the C7-635

---

Maintenance

---

### Appendices

---

Technical Specifications

---

Index



The following supplement is part of this documentation:

| No. | Designation         | Drawing number | Edition |
|-----|---------------------|----------------|---------|
| 1   | Product information | A5E00861679-01 | 07/2006 |

This manual is part of the documentation package with the order number:  
**6ES7635-1EA00-8BA0**

This manual has the order number:  
**6ES7635-1AA00-8BA0**

**Edition 03/2004**

A5E00155581-04

**1**

**2**

**3**

**4**

**5**

**A**

## Safety Guidelines

This manual contains notices intended to ensure personal safety, as well as to protect the products and connected equipment against damage. These notices are highlighted by the symbols shown below and graded according to severity by the following texts:

---



### Danger

indicates that death, severe personal injury or substantial property damage will result if proper precautions are not taken.

---



### Warning

indicates that death, severe personal injury or substantial property damage can result if proper precautions are not taken.

---



### Caution

indicates that minor personal injury can result if proper precautions are not taken.

---

### Caution

indicates that property damage can result if proper precautions are not taken.

---

### Notice

draws your attention to particularly important information on the product, handling the product, or to a particular part of the documentation.

---

## Qualified Personnel

Only **qualified personnel** should be allowed to install and work on this equipment. Qualified persons are defined as persons who are authorized to commission, to ground and to tag circuits, equipment, and systems in accordance with established safety practices and standards.

## Correct Usage

Note the following:

---



### Warning

This device and its components may only be used for the applications described in the catalog or the technical description, and only in connection with devices or components from other manufacturers which have been approved or recommended by Siemens.

This product can only function correctly and safely if it is transported, stored, set up, and installed correctly, and operated and maintained as recommended.

---

## Trademarks

SIMATIC®, SIMATIC HMI® and SIMATIC NET® are registered trademarks of SIEMENS AG.

Third parties using for their own purposes any other names in this document which refer to trademarks might infringe upon the rights of the trademark owners.

## Copyright Siemens AG 2002-2004 All rights reserved

The reproduction, transmission or use of this document or its contents is not permitted without express written authority. Offenders will be liable for damages. All rights, including rights created by patent grant or registration of a utility model or design, are reserved.

Siemens AG  
Bereich Automation and Drives  
Geschäftsgebiet Industrial Automation Systems  
Postfach 4848, D- 90327 Nuernberg

Siemens Aktiengesellschaft

## Disclaimer of Liability

We have checked the contents of this manual for agreement with the hardware and software described. Since deviations cannot be precluded entirely, we cannot guarantee full agreement. However, the data in this manual are reviewed regularly and any necessary corrections included in subsequent editions. Suggestions for improvement are welcomed.

© Siemens AG 2002-2004  
Technical data subject to change.

---

A5E00155581-04

# Preface

## Purpose of this Manual

This manual provides a complete overview of the **C7-635 Control System** and assistance with its installation and commissioning. Options for connecting additional devices are explained, and the required components are presented.

## Scope of Manual

This manual is applicable to the following:

| C7           | Order Number        | As of Version<br>Firmware/Hardware         |
|--------------|---------------------|--|
| C7-635 Touch | 6ES7 635-2EB01-0AE3 | CPU V2.0.7 / 01<br>HMI V 6.0.2.23 (Win CE) |
| C7-635 Key   | 6ES7 635-2EC01-0AE3 | CPU V2.0.7 / 01<br>HMI V 6.0.2.23 (Win CE) |

## Audience and Knowledge Requirements

This manual is intended for persons having the required qualifications to commission, operate, and program the hardware product described.

You should be familiar with the use of computers or similar tools (such as programming devices) under the Windows 98/2000/NT 4.0/XP operating system and be knowledgeable regarding the basic STEP 7 software and ProTool configuration software and their documentation.









## C7-635 Documentation Package

The C7-635 consists of the following individual components:

- SIMATIC S7-CPU 314C-2 DP
- SIMATIC Touch Panel TP170 B (C7-635 Touch) and Operator Panel OP170 B (C7-635 Key)



Manuals providing detailed information on these individual components are included in this documentation package. These manuals are essential when working with the C7-635.

The documentation package consists of seven manuals and an instruction list:

|                              |   |   |
|------------------------------|---|---|
| You are reading this manual. | <b>C7-635 Control System</b>  | Description of:   |
|                              | →  Manual  | <ul style="list-style-type: none"> <li>• Installation and wiring</li> <li>• Operator input</li> <li>• Technical Specifications of the C7-635</li> </ul>   |
|                              | <b>Touch Panel “TP170 A”, “TP170 B”,<br/>Operator Panel “OP170 B”</b>   | Provides information about:   |
|                              |  Manual  | <ul style="list-style-type: none"> <li>• Functionality</li> <li>• Device description</li> <li>• Operating modes and operation of the OP/TP</li> </ul>   |
|                              | <b>Communication for<br/>Windows-Based Systems</b>  | Includes:   |
|                              |  Manual  | <ul style="list-style-type: none"> <li>• Connection to S7-200, S7-300, and S7-400 by means of MPI and PROFIBUS</li> <li>• User data areas for communication between CPU and Touch Panel/Operator Panel</li> </ul> |
|                              | <b>CPU 31xC and CPU 31x, Technical data</b>   | Description of operator input, the functions, and the technical specifications of the CPU.  |
|                              |  Manual  |   |
|                              | <b>CPU 31xC Technological Functions</b>   | Description of the Individual Technological Functions<br>Positioning, Counting, and Control   |
|                              |  Manual  | The CD contains examples of the technological functions.  |
|                              |  Examples  |   |
|                              | <b>S7-300, CPU 31xC and CPU 31x:<br/>Hardware and Installation</b>  | Description of how to configure, install, wire, network, and commission the S7-300.   |
|                              |  Operating Instructions  |   |
|                              | <b>S7-300 Module Data</b>   | Function description and technical specifications of the signal modules, power supply modules, and interface modules.   |
|                              |  Reference Manual  |   |
|                              | <b>S7-300 Instruction List</b>  | List of CPU instruction sets and their execution times.<br>List of executable blocks (OBs/SFCs/SFBs) and their execution times.   |
|                              |  CPU 31xC, CPU 31x,<br>IM 151-7 CPU, BM 147-1 CPU,<br>BM 147-2 CPU |   |

## Additional Documentation

To assist you in programming and configuring a C7, there is a wide range of user documentation for specific applications. The following information will help you when consulting the user documentation.

|   |   |
|---|---|
| <p><b>ProTool<br/>Configuring Windows-based systems</b></p> <p> Manual</p>   | <p>Manual for creating configurations with ProTool</p> <ul style="list-style-type: none"> <li>• Operation of ProTool</li> <li>• Configuration</li> <li>• Screens and messages</li> <li>• Downloading configuration to the C7</li> </ul> |
| <p><b>Programming with STEP 7</b></p> <p> Manual</p>   | <p>Basics for programming in STEP 7</p>   |
| <p><b>Instruction list (IL) for S7-300/400 PLCs</b></p> <p>or</p> <p><b>Ladder diagram (LAD) for S7-300/400 PLCs</b></p> <p>or</p> <p><b>Function block diagram (FBD) for S7-300/400 PLCs</b></p> <p> Reference manual</p> | <p>Manual for programming in STL, LAD, or FBD</p>   |

## Approbation

For detailed information on approvals and standards, refer to Appendix A, Technical data.

## Standards

The C7-635 meets the requirements and criteria of IEC 61131-2.

## Guide

This manual contains the following elements to help you access particular information quickly and easily:

- Complete table of contents at the front of the manual
- Information located in the left-justified headings of each chapter page providing an overview of section contents.
- Detailed keyword index at the back of the manual

## Recycling and disposal

The C7-635 system can be recycled due to its low-contaminant equipment. Contact a certified company for the environment-friendly recycling disposal of your electronic waste.

## Additional Support

If you have questions regarding the use of the products described in the manual and are unable to find an answer here, please contact your nearest Siemens representative.

<http://www.ad.siemens.com/automation/partner>

You will find a guide to the technical documentation offered for the individual SIMATIC Products and Systems here at:

<http://www.siemens.com/simatic-tech-doku-portal>

## Training Center

To facilitate getting started with the SIMATIC C7 automation system, we offer suitable courses. Please contact your regional Training Center or the main Training Center in D90327 Nuremberg, Germany.

Telephone: +49 (911) 895-3200

Internet: <http://www.sitrain.com>

## A&D Technical Support

Worldwide, available 24 hours a day:



|  |   |  |
|--|---|--|
| <p><b>Worldwide (Nuernberg)</b><br/><b>Technical Support</b></p> <p>24 hours a day, 365 days a year<br/>Phone: +49 (180) 5050-222<br/>Fax: +49 (180) 5050-223<br/>mailto:adsupport@siemens.com<br/>GMT: +1:00</p>                |   |  |
| <p><b>Europe / Africa (Nuernberg)</b><br/><b>Authorization</b></p> <p>Local time: Mon.-Fri.<br/>8:00 AM to 5:00 PM<br/>Phone: +49 (180) 5050-222<br/>Fax: +49 (180) 5050-223<br/>mailto:adsupport@siemens.com<br/>GMT: +1:00</p> | <p><b>United States (Johnson City)</b><br/><b>Technical Support and Authorization</b></p> <p>Local time: Mon.-Fri.<br/>8:00 AM to 5:00 PM<br/>Phone: +1 (423) 262 2522<br/>Fax: +1 (423) 262 2289<br/>mailto:simatic.hotline@sea.siemens.com<br/>GMT: -5:00</p> | <p><b>Asia / Australia (Beijing)</b><br/><b>Technical Support and Authorization</b></p> <p>Local time: Mon.-Fri.<br/>8:00 AM to 5:00 PM<br/>Phone: +86 10 64 75 75 75<br/>Fax: +86 10 64 74 74 74<br/>mailto:adsupport.asia@siemens.com<br/>GMT: +8:00</p> |
| <p>The languages of the SIMATIC Hotlines and the authorization hotline are generally German and English.</p>   |   |  |

## **Service & Support on the Internet**

In addition to our documentation, we offer our Know-how online on the internet at:

<http://www.siemens.com/automation/service&support>

where you will find the following:

- The newsletter, which constantly provides you with up-to-date information on your products.
- The right documents via our Search function in Service & Support.
- A forum, where users and experts from all over the world exchange their experiences.
- Your local representative for Automation & Drives.
- Information on field service, repairs, spare parts and more under "Services".



# Contents

|          |   |                |
|----------|---|----------------|
| <b>1</b> | <b>Document Guide</b> .....   | <b>1-1</b>     |
| <b>2</b> | <b>Product Overview</b> .....   | <b>2-1</b>     |
| 2.1      | Configuration and Structure .....                                       | 2-1            |
| 2.2      | C7-635 Components and Accessories .....                                 | 2-8            |
| <b>3</b> | <b>Installing and Wiring the C7-635</b> .....                           | <b>3-1</b>     |
| 3.1      | Labeling Strips (C7-635 Key only) Labeling Strips .....                 | 3-1            |
| 3.2      | Mechanical Installation .....   | 3-3            |
| 3.3      | Locating the C7-635 in a Mechanical Environment .....                   | 3-10           |
| 3.4      | Setting Up the Electrical Configuration and Connector Pin Assignment .. | 3-11           |
| 3.5      | Guidelines for Fail-Safe Construction .....                             | 3-22           |
| 3.6      | Connecting Shielded Cables .....  | 3-24           |
| 3.7      | Coding Connector Parts to Prevent Incorrect Usage .....                 | 3-25           |
| <b>4</b> | <b>Special Features of the C7-635</b> .....                             | <b>4-1</b>     |
| 4.1      | Operating Mode Selection .....  | 4-2            |
| 4.2      | Status and Error Displays of the C7-635 .....                           | 4-5            |
| 4.3      | Arrangement of additional S7-300 modules .....                          | 4-5            |
| 4.4      | Status Display of the Digital Onboard I/O .....                         | 4-9            |
| <b>5</b> | <b>Maintenance</b> .....  | <b>5-1</b>     |
| 5.1      | Cleaning the Monitor .....  | 5-1            |
| 5.2      | Replacing the C7-635 .....  | 5-2            |
| <b>A</b> | <b>Technical Specifications</b> .....                                   | <b>A-1</b>     |
| A.1      | Technical Specifications for Complete Apparatus .....                   | A-1            |
| A.2      | Technical Specifications for TP/OP .....                                | A-3            |
| A.3      | Technical Specifications for CPU .....                                  | A-7            |
| A.4      | Technical Specifications for Integrated I/O .....                       | A-14           |
| A.5      | Notes on Power Supply .....   | A-23           |
| A.6      | Approvals .....   | A-23           |
| A.7      | Notes on CE Marking .....   | A-25           |
| A.8      | Notes for Machine Manufacturers .....                                   | A-26           |
|          | <b>Index</b> .....  | <b>Index-1</b> |

**Figure**

|      |   |      |
|------|---|------|
| 2-1  | C7-635 Touch .....  | 2-1  |
| 2-2  | C7-635 Key .....  | 2-2  |
| 2-3  | Components and interfaces of the C7-635 .....   | 2-4  |
| 3-1  | Inserting labeling strips for C7-635 Key .....  | 3-2  |
| 3-2  | Mechanically Fastening the C7-635 Touch .....   | 3-4  |
| 3-3  | Dimension Drawings for the C7-635 Touch (Measurements in mm) .....                              | 3-4  |
| 3-4  | Dimension Drawings for the C7-635 Key (Measurements in mm) .....                                | 3-5  |
| 3-5  | Dimension Drawings for the C7-635 Touch (Measurements in mm) .....                              | 3-6  |
| 3-6  | Dimension Drawings for the C7-635 Touch (Measurements in mm) .....                              | 3-7  |
| 3-7  | Dimension Drawings for the C7-635 Key (Measurements in mm) .....                                | 3-8  |
| 3-8  | Dimension Drawings for the C7-635 Key (Measurements in mm) .....                                | 3-9  |
| 3-9  | Installation Clearances When Mounting the C7-635 Touch .....                                    | 3-10 |
| 3-10 | Installation Clearances when Mounting the C7-635 Key .....                                      | 3-10 |
| 3-11 | C7-635 Touch with Connectors and Sockets, Front View .....                                      | 3-11 |
| 3-12 | C7-635 with Connectors and Sockets, Back View .....   | 3-12 |
| 3-13 | C7-635 Layout of Connector Pin Assignment .....   | 3-13 |
| 3-14 | C7-635 with Connectors and Sockets, Side View .....   | 3-13 |
| 3-15 | C7-635 with Connectors and Sockets, Bottom View .....   | 3-15 |
| 3-16 | C7-635 with Connectors and Sockets, Side View .....   | 3-19 |
| 3-17 | C7-635 with grounding busbar, shielding terminals,<br>and terminal for functional ground .....  | 3-24 |
| 3-18 | Preventing Incorrect Usage of Connectors .....  | 3-25 |
| 4-1  | C7-635 Touch .....  | 4-2  |
| 4-2  | Connecting Additional S7-300 Modules Directly on the Device Using<br>the 2-Module I/O Set ..... | 4-6  |
| 4-3  | Connecting Additional S7-300 Modules Directly on the Device Using<br>the 2-Module I/O Set ..... | 4-7  |
| 4-4  | Connecting Additional S7-300 Modules at a Distance of Up to 1.5 m ...                           | 4-8  |
| 4-5  | DI/DO Status Display .....  | 4-9  |

**Table**

|      |   |      |
|------|---|------|
| 3-1  | Mechanical Installation .....                               | 3-3  |
| 3-2  | Supply Connector X1 .....                                   | 3-14 |
| 3-3  | Programming Device Connection (MPI) 2 .....                 | 3-14 |
| 3-4  | DP Connection X3 .....                                      | 3-14 |
| 3-5  | RS232 Connection X4 .....                                   | 3-15 |
| 3-6  | Connector Pin Assignment I/O Connector X10 .....            | 3-16 |
| 3-7  | Connector Pin Assignments I/O Connector X11 .....           | 3-17 |
| 3-8  | Connector Pin Assignments I/O Connector X12 .....           | 3-18 |
| 3-9  | Connector Pin Assignment I/O Connector X13 .....            | 3-19 |
| 3-10 | Connector Pin Assignments Analog Output X 14 .....          | 3-20 |
| 3-11 | Cables for Connection to C7-635 .....                       | 3-21 |
| 4-1  | Operating Mode Keys .....                                   | 4-3  |
| 4-2  | Description of the DI/DO Status Display in Figure 4-5 ..... | 4-9  |
| A-1  | Technical Specifications for C7-635 .....                   | A-1  |
| A-2  | Functional Scope of TP/OP .....                             | A-3  |

# Document Guide

# 1

This guide lists the most important topics and indicates which manuals in the documentation package contain relevant information for each topic.

| Information   | Location<br>(This Manual) | Reference   |
|---|---------------------------|---|
| <b>Product Overview</b>   | Chapter 2                 |   |
| <b>Mounting and Wiring</b>  | Chapter 3                 |   |
| <b>Special Features of the C7-635</b>   | Chapter 4                 |   |
| <b>Control and Display Elements</b>   |                           | <i>CPU 31xC and CPU 31x,<br/>Technical data</i>                                 |
| <b>Memory</b>   |                           |   |
| <ul style="list-style-type: none"> <li>• SIMATIC Micro Memory Card (MMC) for the CPU</li> </ul> |                           | <i>CPU 31xC and CPU 31x,<br/>Technical data</i>                                 |
| <ul style="list-style-type: none"> <li>• CPU Memory Concept</li> </ul>                          |                           | <i>CPU 31xC and CPU 31x,<br/>Technical data</i>                                 |
| <ul style="list-style-type: none"> <li>• Compact Flash Card (CF-Card) for the TP/OP</li> </ul>  |                           | <i>Touch Panel TP170 A, TP170 B,<br/>Operator Panel OP170 B,<br/>Chapter 12</i> |
| <b>Commissioning the HMI Portion</b>  |                           | <i>Touch Panel TP170 A, TP170 B,<br/>Operator Panel OP170 B,<br/>Chapter 3</i>  |
| <b>Operating the Device</b>   |                           | <i>Touch Panel TP170 A, TP170 B,<br/>Operator Panel OP170 B,<br/>Chapter 4</i>  |
| <b>Data Areas for Communication between C7-OP and C7-CPU</b>                                    |                           | <i>SIMATIC HMI, Communication for<br/>Windows-Based Systems,<br/>Chapter 7</i>  |
| <b>Screen Objects</b>   |                           | <i>Touch Panel TP170 A, TP170 B,<br/>Operator Panel OP170 B,<br/>Chapter 7</i>  |
| <b>System Settings</b>  |                           | <i>Touch Panel TP170 A, TP170 B,<br/>Operator Panel OP170 B,<br/>Chapter 9</i>  |
| <b>Maintenance</b>  | Chapter 5                 |   |
| <b>Technological Functions</b>  |                           | <i>S7-300 Automation System<br/>CPU 31xC<br/>Technological Functions</i>        |
| <b>Technical Specifications</b>   | Appendix A                |   |
| <b>Scope of Functions</b>   | Appendix A                |   |



# Product Overview

# 2

## 2.1 Configuration and Structure



Figure 2-1 C7-635 Touch

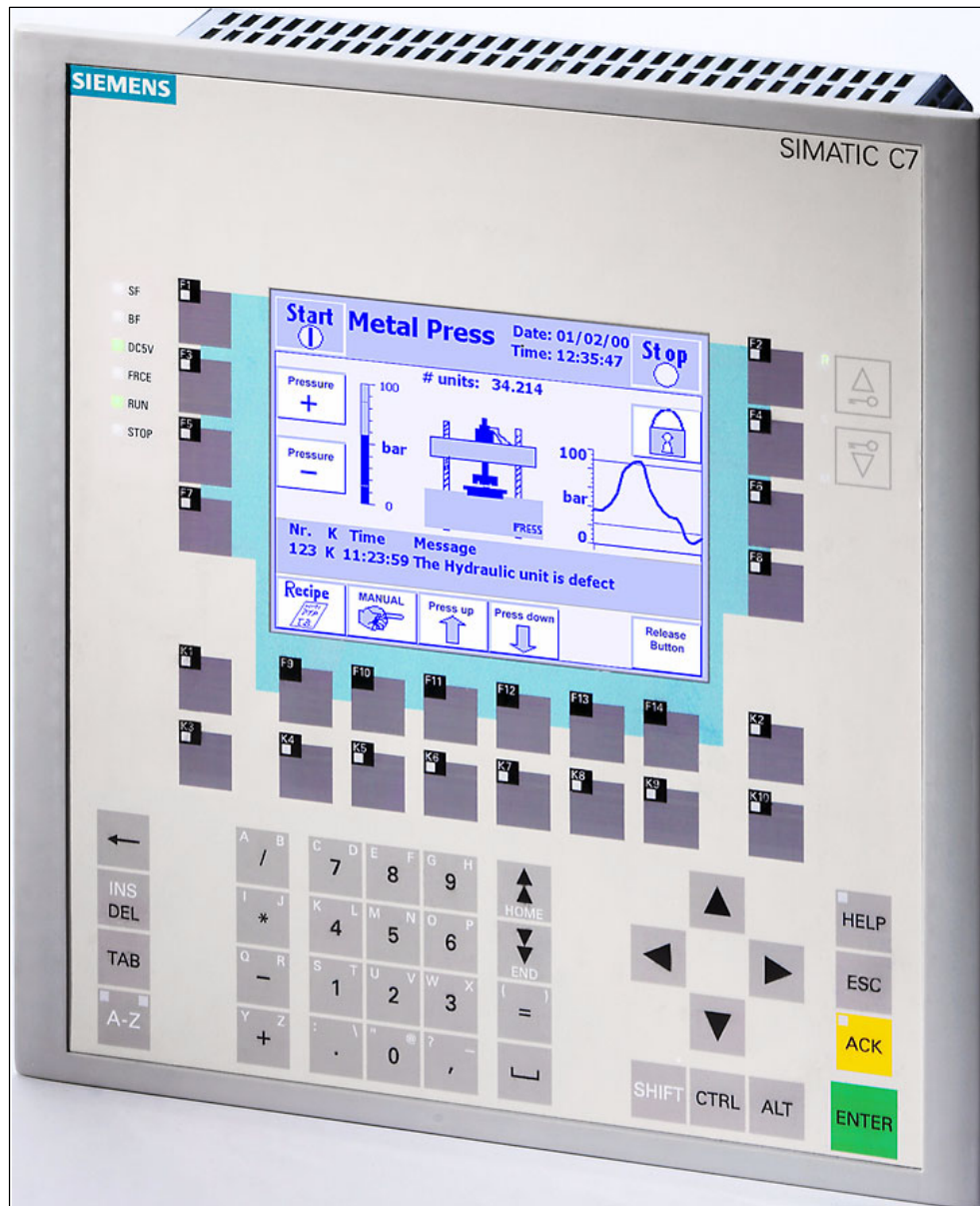

Figure 2-2 C7-635 Key

## Components

The SIMATIC C7-635 consists of the following components:

- SIMATIC S7 314C-2 DP CPU
- SIMATIC touch panel TP170 B or operator panel OP170 B

## Interfaces

SIMATIC C7-635 interfaces:

- An interface for connecting up to four S7-300 modules via the S7-300 I/O bus
- Integrated digital and analog I/O (CPU 314C-2DP I/O)
- DP interface for the communication with nodes on a PROFIBUS DP network
- MPI interface for the communication with a PG/PC and further S7 CPUs, C7 control systems and OPs
- RS232 interface (e.g. as printer port)
- Micro Memory Card (MMC)
- Compact Flash Card (CF Card)

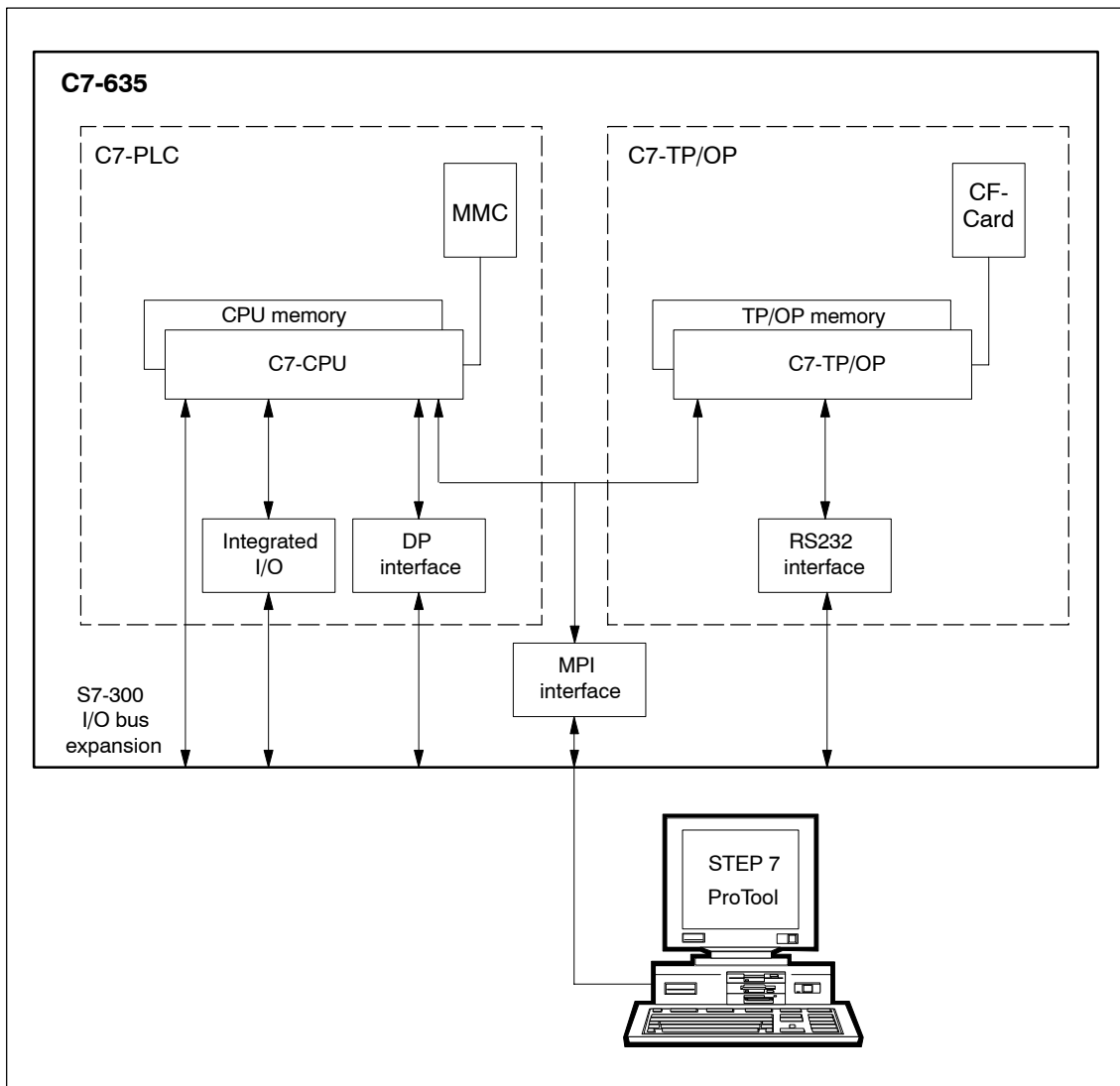

Figure 2-3 Components and interfaces of the C7-635

### Plug-In Modules on the S7-300 I/O Bus

**Note**

I/O expansions can be interconnected via the S7 300 I/O bus without IM interface module using the following accessories:

- 2-module I/O set: Expansion with up to two S7 300 modules
- 4-module I/O set: Expansion with up to four S7 300 modules

You can add an IM-360 interface module in order to connect up to three expansion rows for a maximum of 23 S7 300 modules.



## Interplay of CPU and TP/OP

The individual components integrated in the SIMATIC C7-635 correspond to the components that can also be used for modular configurations consisting of CPU-314C-2DP, TP170 B, and OP170 B.

The basic mode of operation is also similar to operation of a configuration with standard modules from the programmable controller and TP/OP family; the individual components function independently, and each processor has its own dedicated memory.

The C7-CPU and the C7-TP/OP communicate internally over the MPI interface.

The C7-CPU is independent of the C7-TP/OP. The C7-TP/OP continues to run, for example, if the C7-CPU enters the STOP mode.

## Programming and Configuration

---

### Note

The C7-CPU and the C7-TP/OP each have their own MPI address. Therefore, you program and configure these components in exactly the same way as independent CPU and TP/OP components.

These items are addressed explicitly in the manual, as necessary.

---

You program the C7-635 Touch with STEP 7 as of V 5.2 + Service Pack 1 + Hardware Update C7-635 Touch V2.0.

You program the C7-635 Key with STEP 7 as of V 5.2 + Service Pack 1 + Hardware Update C7-635 Key V2.0.

The programming languages you can use are listed in the *CPU 31xC and CPU 31x, Technical data* manual.

The C7-635 is configured with ProTool, ProTool/Lite, or ProTool/Pro starting with V 6.0 + Service Pack 1.

The tools run on a programming device or PC under Windows.

## CPU

The user program controlling the process runs on the C7-635.

The following functional units determine the mode of operation of the C7-635:

- Loading memory  
The loading memory is located on the Micro Memory Card (MMC) and contains the user program.
- Processor  
The processor executes the program cyclically:
  - At the beginning of the cycle, the processor reads the signal states on all inputs and generates a process image of the inputs (PII).
  - The program is executed step-by-step using internal counters, bit memory, and timers.
  - The processor stores the calculated signal states in the process output image (POI). At the end of the cycle, the process image is transmitted to the outputs.

## Touch Panel/Operator Panel

The touch panel and the operator panel of the C7-635 are based on the standard Windows CE operating system. You can visually display operating modes, current process values, and faults. You can also make entries on the C7-635. Simple machine diagnostic functions are also possible.

You can also incorporate your own graphics, digital pictures, and scanned images into your project. Moreover, you can represent elements such as temperature variations graphically using bar graphs and diagrams.

## Scope of Functions

### CPU

- 64 Kbytes of CPU user memory
- Various sizes of loading memory and retentive memory in the Micro Memory Card
- Integrated I/O
  - 24 DI
  - 16 DO
  - 4 AI
  - 2 AO
  - 1 PT 100

- Technological functions
  - Positioning with an analog output or digital outputs
  - Counting, frequency measurements, or pulse width modulation (only two channels are available when the positioning function is used)
  - Closed loop control
- PROFIBUS-DP interface

#### **Touch Panel/Operator Panel**

- 32 Kbytes of internal memory for recipes can be expanded with Compact Flash Card (CF Card); 768 Kbytes of internal configuration memory.
- Password Protection
- Input/output fields for displaying and modifying process parameters
- Configurable buttons and function keys (C7-635 Key) for controlling input/output and data bits
- Bar graphs for graphics-based display of dynamic values
- Standard library for graphics and buttons that can be used in ProTool CS
- Graphics that can be used to label buttons or configured as format-filling background images
- Permanent text for labelling buttons, process images, and process values in any font size
- Print functions
- Message editing
- Curves
- Interrupt timer
- Recipe management
- Backup of recipe data and configurations on optional memory card (CF card)

You will find a complete overview of the scope of functions in Appendix A.

## 2.2 C7-635 Components and Accessories

### Components

The following components are supplied with the C7-635:

- 1 C7-635 Touch (6ES7635-2EB01-0AE3) with sealing or  
1 C7-635 Key (6ES7635-2EC01-0AE3) with sealing
- 1 grounding busbar, including two mounting screws and six shielding terminals
- 10 brackets

### Additional Devices and Tools Required to Operate the C7-635

You need the following devices and tools:

- A Micro Memory Card (MMC) to store the CPU user program that is programmed with STEP 7. The C7-635 can only be operated with an MMC.
- A Compact Flash Card (CF Card) for the TP/OP if you require more than 32 Kbytes of memory for recipes or if the C7-635 is to be replaceable without a programming device/PC
- 24 V power supply
- Connector set (screw terminals or spring-type terminals) for C7 I/O with coding profiles and coding tabs
- C7-635 accessory for I/O expansion (directly on the device, or at a distance of 1.5 m), in case you would like to expand the I/O.
- A programming device or PC with:
  - An MPI interface and an MPI cable to generate the user program, or alternatively, a programming device/PC with the capability of reading and writing to a CF Card
  - An RS232 interface and RS232 cable (zero modem cable)
- For C7-635 Touch, STEP 7 as of Version 5.2 + Service Pack 1 + Hardware Update C7-635 Touch V2.0
- For C7-635 Key, STEP 7 as of Version 5.2 + Service Pack 1 + Hardware Update C7-635 Key V2.0
- The configuration tool ProTool, ProTool/Lite or ProTool/Pro starting with V 6.0 + Service Pack 1

## Accessories

The following components can be ordered as **C7-635 accessories**:

- **I/O set with two modules** for I/O expansion directly on the device  
6ES7635-0AA00-6AA0

Consisting of:

- A cable, approximately 0.25 m (for connecting the C7-635 to the S7 module)
- A cable, approximately 0.08 m (for connecting the S7 module to the S7 module)
- Mounting plate with S7 DIN rails including four Kombitorx screws (screwed to the back of the device)

- **I/O set with four modules** for I/O expansion directly on the device  
6ES7635-0AA00-6BA0

Consisting of:

- A cable, approximately 0.20 m
- S7 DIN rail, 190 mm including 4 countersunk screws (screwed to the back of the device)

- **Cable, 1.5 m**, for I/O expansion up to a maximum distance of 1.5 m  
6ES7635-0AA00-6CA0

You must order a **standard DIN rail** for the **S7-300** programmable controller in addition.

- **Connector set with screw terminals** for C7 I/O with coding profiles and coding carriers 6ES7635-0AA00-4AA0 or
- **Connector set with spring-loaded terminals** for C7 I/O with coding profiles and coding carriers 6ES7635-0AA00-4BA0
- **Grounding bar with shielding terminals** for analog I/O  
6ES7635-0AA00-6EA0
- **Protective film** for the C7-635 display  
6AV6574-1AD00-4AX0

- **Paper documentation *C7-635 control system***

Consisting of:

- *C7-635 manual* in the following languages:
 

|          |                    |
|----------|--------------------|
| German:  | 6ES7635-1AA00-8AA0 |
| English: | 6ES7635-1AA00-8BA0 |
| French:  | 6ES7635-1AA00-8CA0 |
| Spanish: | 6ES7635-1AA00-8DA0 |
| Italian: | 6ES7635-1AA00-8EA0 |

- **Paper documentation C7-635 control system documentation package**

Consisting of:

- *C7-635 manual*
- *Manuals for CPU 314C-2 DP*
- *Touch Panel TP170 A TP170 B, Operator Panel OP170 B manual*
- *Communication for Windows-Based Systems manual*)

in the following languages:

|          |                    |
|----------|--------------------|
| German:  | 6ES7635-1EA00-8AA0 |
| English: | 6ES7635-1EA00-8BA0 |
| French:  | 6ES7635-1EA00-8CA0 |
| Spanish: | 6ES7635-1EA00-8DA0 |
| Italian: | 6ES7635-1EA00-8EA0 |

The following components can be ordered as **C7 accessories**:

- **MPI cable** 6ES7901-0BF00-0AA0 (for connecting the C7 to the programming device)
- **PC adapter** 6ES7972-0CA23-0XA0 (for connecting the C7 to the PC)
- **RS232 cable** 6ES7901-1BF00-0XA0 (zero modem cable)

### Spare Parts

- **Service pack (gasket and 10 mounting supports)** 6ES7635-0AA00-3AA0.  
The gasket has to be replaced every time the C7-635 is installed/uninstalled.

## Installing and Wiring the C7-635

### 3.1 Labeling Strips (C7-635 Key only) Labeling Strips

The function keys can be labeled individually with labeling strips that are inserted in the keyboard from below.

#### System-Specific Labeling

The template for the labeling strips is provided with ProTool (V6.0 + Service Pack 2, directory Utilities) or can be obtained from the Internet. With it, you can design and print out system-specific labeling strips easily.

Internet address: [www.siemens.com/automation/service&support](http://www.siemens.com/automation/service&support)

The file "SLIDE635.DOC" with the labeling strips can be obtained by selecting Product Support > Automation Systems > SIMATIC Industrial Automation Systems > PLC > SIMATIC C7 > Control Systems > Downloads

To make your own labeling strips, use transparent film (0.1 to 0.15 mm thick) so that the LEDs in the function keys remain visible. Label the film using either a printer or a wipe-resistant foil pen.



---

#### Caution

To prevent the keyboard from smudging on the inside, the labeling must be covered with a transparent adhesive strip or a transparent adhesive film. Otherwise, operating pressure causes the labeling color to rub off on the inside of the key. A key that has been smudged from the inside cannot be cleaned and can only be replaced at the factory.

---

The labeling strips have to be cut exactly along the indicated cutting edge. If the labeling strip is cut too large, it cannot be inserted.

The strip is inserted as follows:

| Step | Action  |
|------|---|
| 1.   | Place the device with the front plate facing downward.  |
| 2.   | Remove any labeling strips that have been previously inserted.  |
| 3.   | With the labeling pointing downward, insert the new labeled strips into the slits on the front panel (use tweezers, if necessary). The position of the eight labeling strips is marked in Figure 3-1 with arrows. |

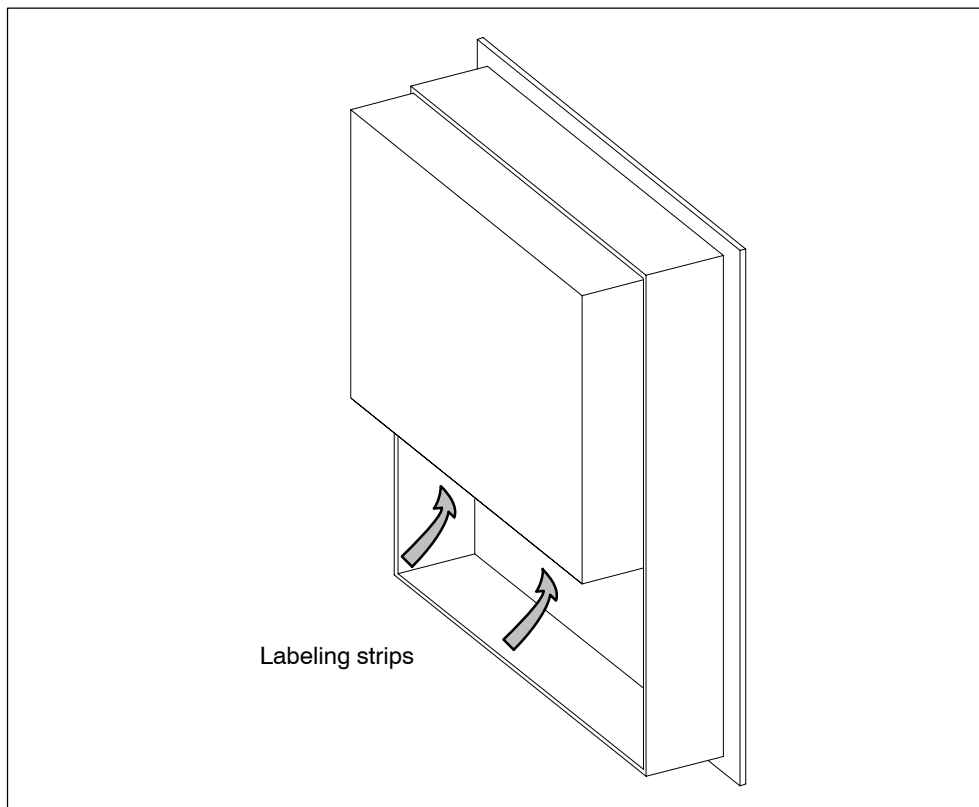

Figure 3-1 Inserting labeling strips for C7-635 Key



### 3.2 Mechanical Installation

#### Mounting

The C7-635 is intended for stationary and enclosed installation in a control cabinet door.

**Note**

You can only achieve the degree of protection IP65/NEMA 4X if you follow steps 1 through 5 during installation.



**Caution**

The inserted CF card protrudes from the C7-635 and could therefore be damaged. Prior to the removal and installation of the device, remove the Micro Memory Card (MMC) of the CPU and the Compact Flash Card (CF Card) of the OP.



**Caution**

Condensation may develop on the device when you take it from a cold environment to the operating area. Before you start it, allow the device to become acclimatized to room temperature. If condensation has developed, the device may not be switched on until it is completely dry.

Mounting is performed as follows:

Table 3-1 Mechanical Installation

| Step | Action  |
|------|---|
| 1.   | C7-635 Touch:<br>Make a cutout in the control cabinet door (dimensions 231+1.0 x 183+1.0 mm). See Figure 3-3.<br>C7-635 Key:<br>Make a cutout in the control cabinet door (dimensions 231+1.0 x 257+1.0 mm). See Figure 3-4.  |
| 2.   | Ensure that no Compact Flash Card (CF Card) is inserted into the C7-635. The CF Card protrudes from the C7-635 and could be damaged when the device is installed.   |
| 3.   | Place the C7-635 in the prepared cutout in the control cabinet door. Ensure that the gasket is applied evenly to the metal plate.   |
| 4.   | Guide the fastening hooks of the provided mounting supports ① (for the C7-635 Touch, 8 mounting supports; for the C7-635 Key, 10 mounting supports) into the intended recesses in the C7-635 housing. Figure 3-2 provides an example of the mechanical fastening of the C7-635 Touch. |

Table 3-1 Mechanical Installation, continued

| Step | Action  |
|------|---|
| 5.   | Using a screwdriver, tighten the C7-635 evenly and crosswise from behind in the control cabinet door until the front panel of the C7-635 rests on the control cabinet door ②. Situate the device so that there is even spacing on all sides between the housing and the cutout section ③. |

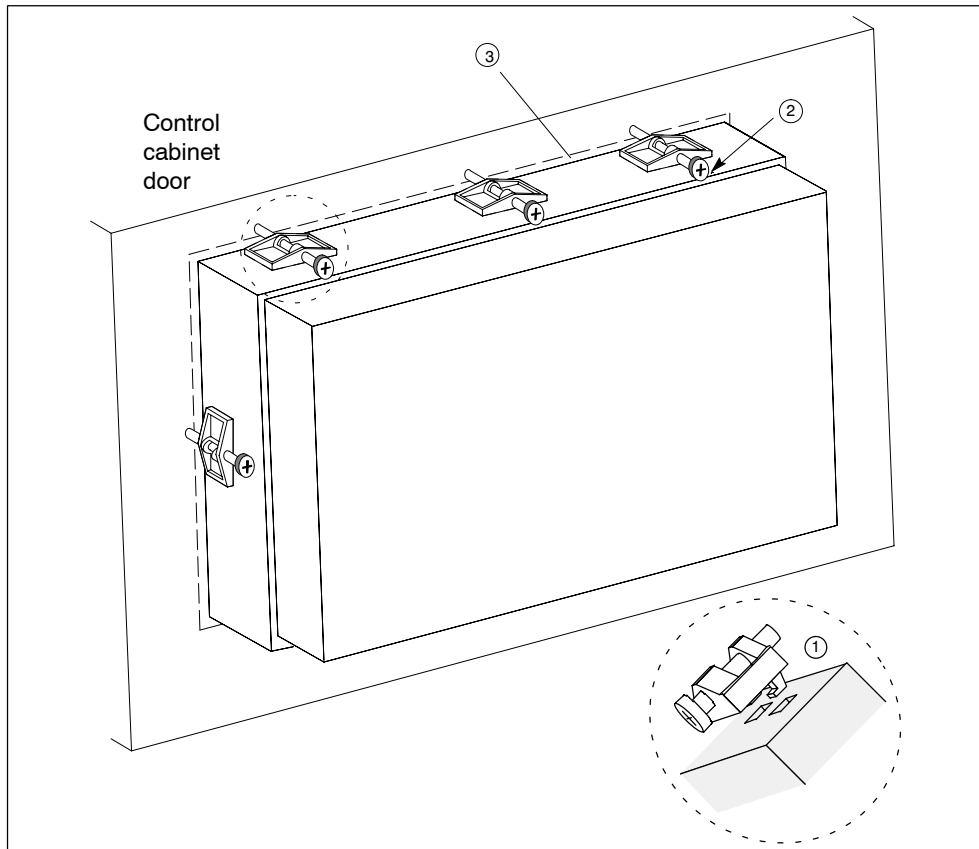

Figure 3-2 Mechanically Fastening the C7-635 Touch

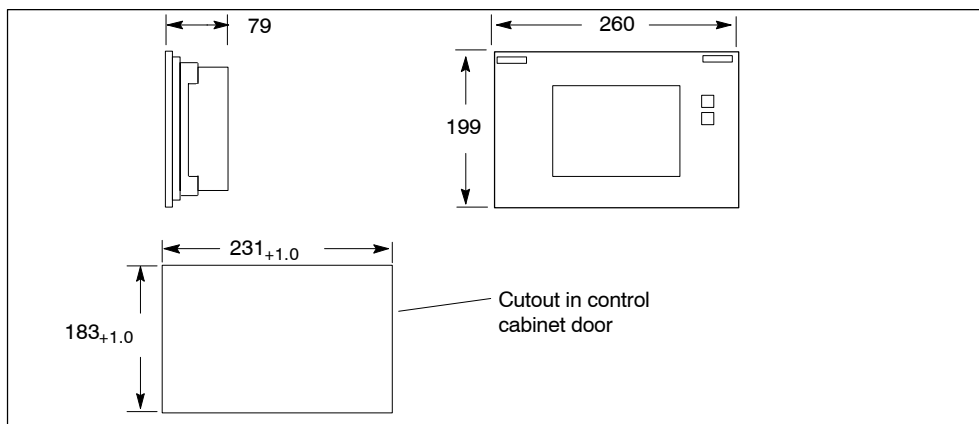

Figure 3-3 Dimension Drawings for the C7-635 Touch (Measurements in mm)

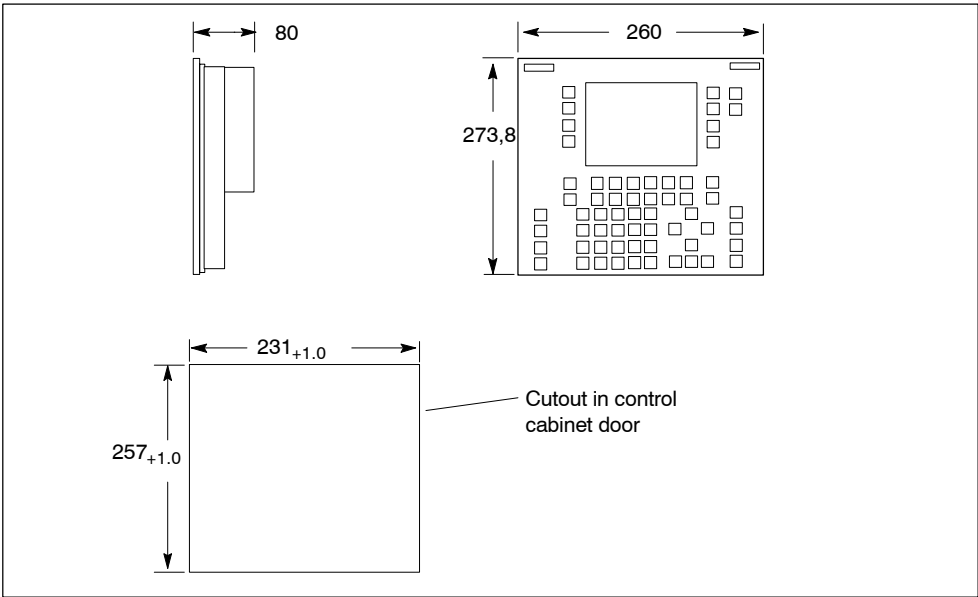

Figure 3-4 Dimension Drawings for the C7-635 Key (Measurements in mm)

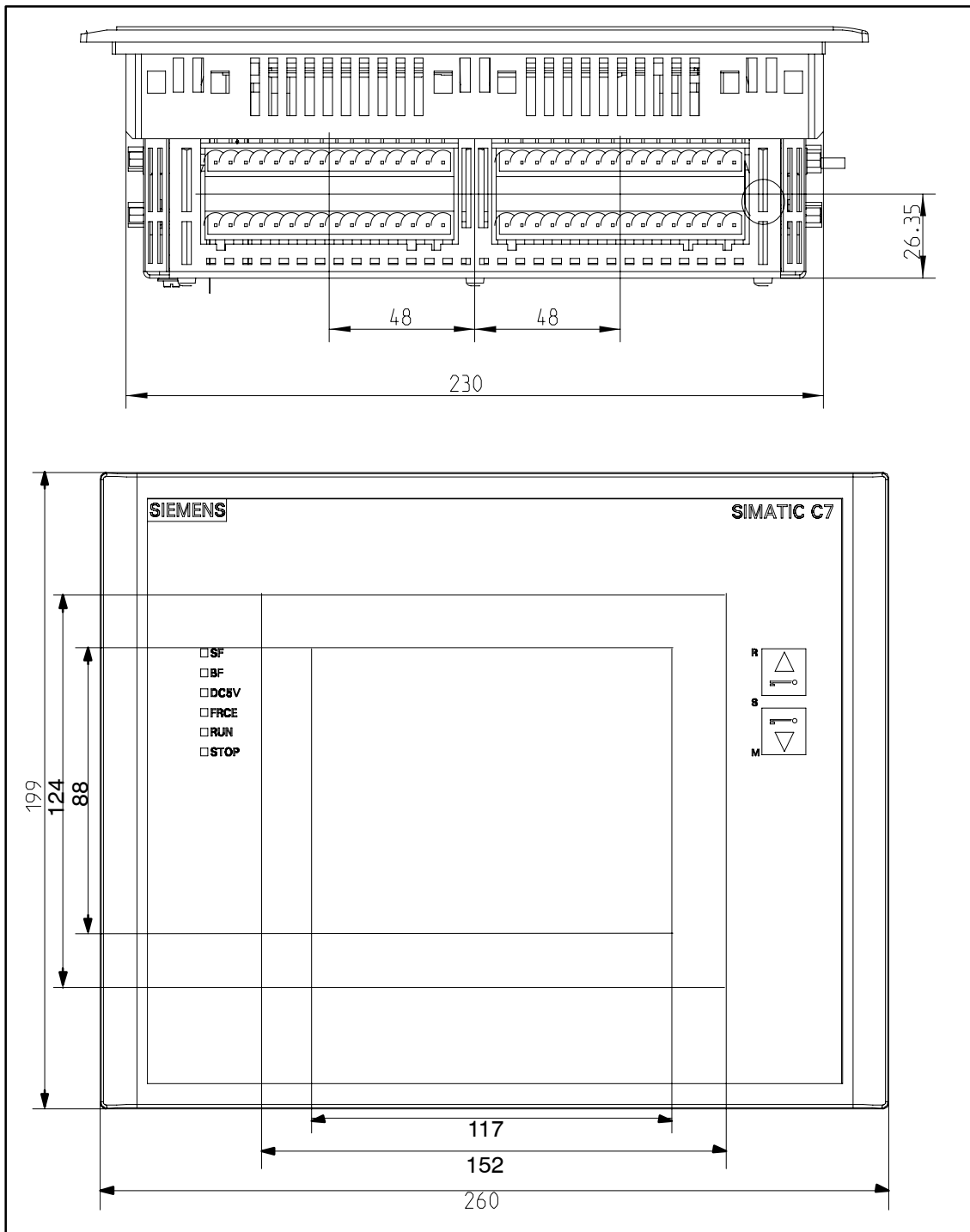

Figure 3-5 Dimension Drawings for the C7-635 Touch (Measurements in mm)

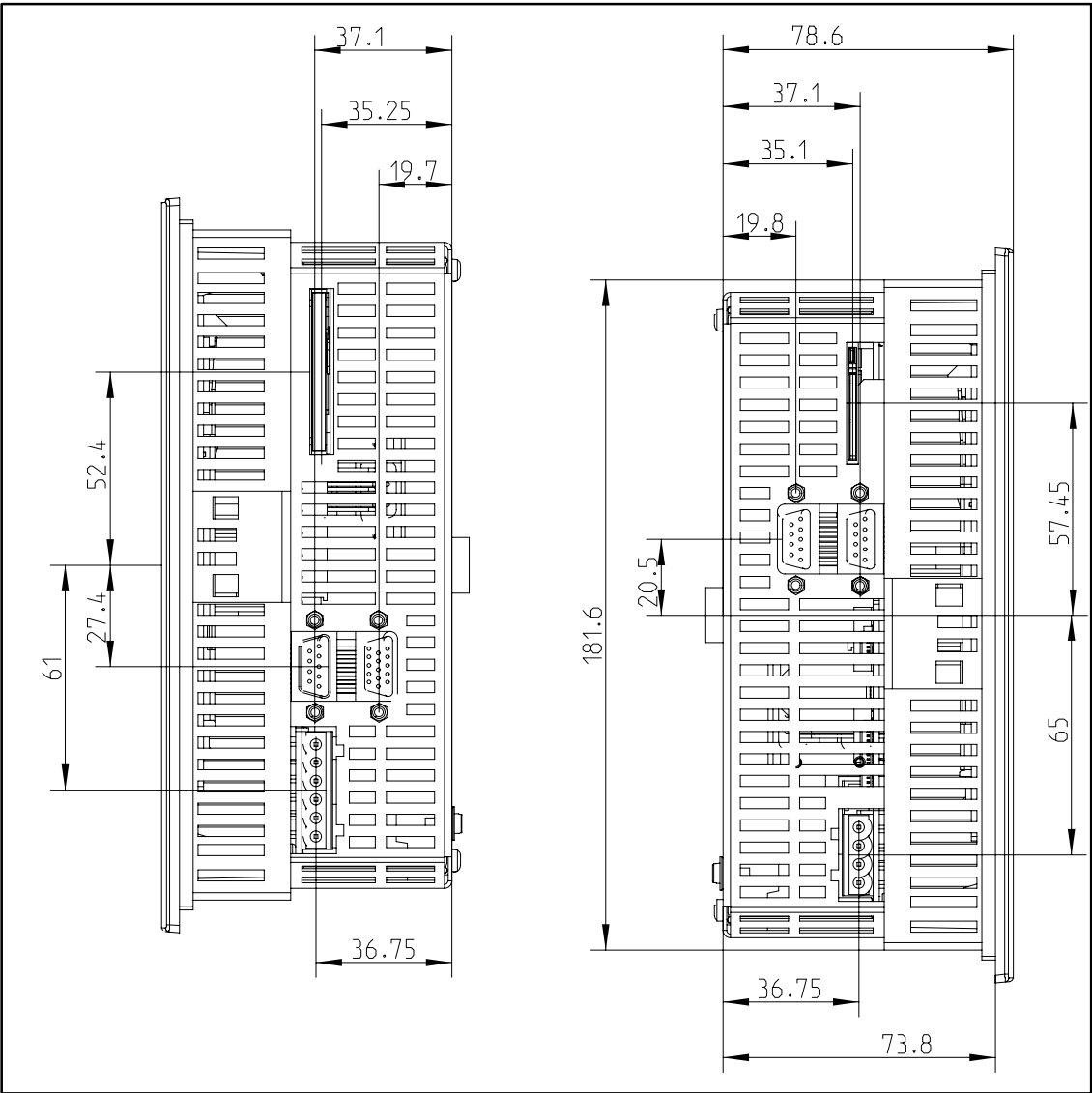

Figure 3-6 Dimension Drawings for the C7-635 Touch (Measurements in mm)

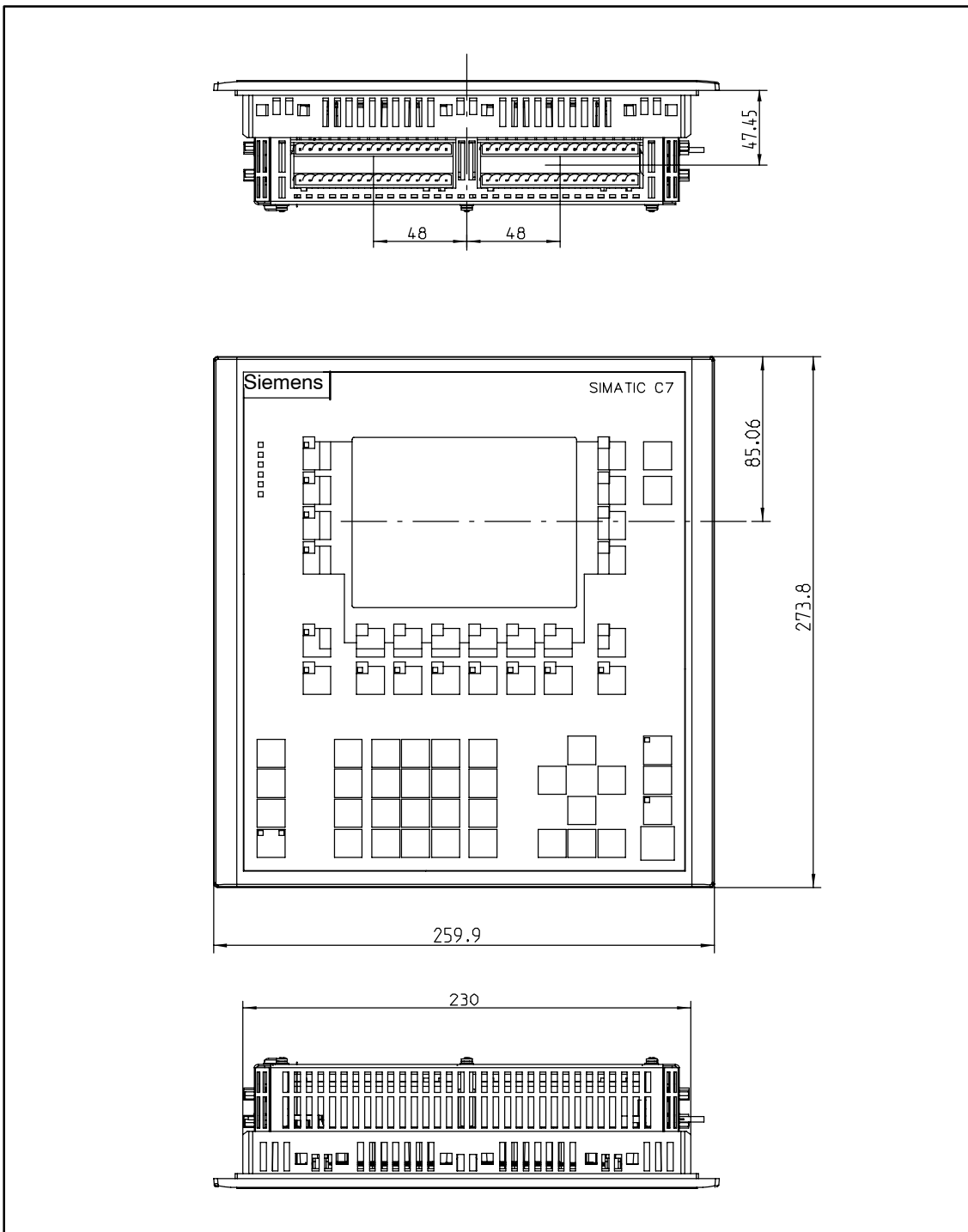

Figure 3-7 Dimension Drawings for the C7-635 Key (Measurements in mm)

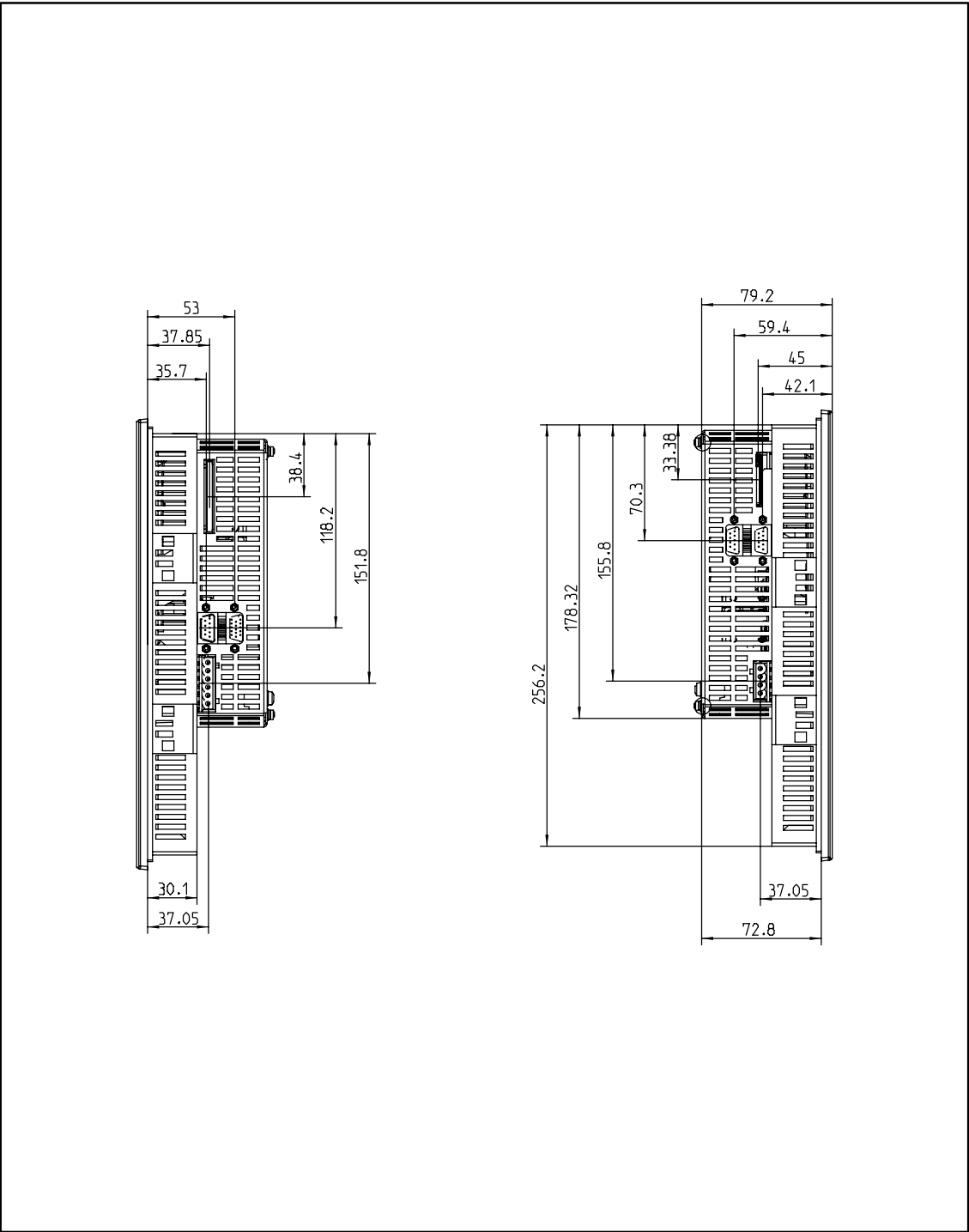

Figure 3-8 Dimension Drawings for the C7-635 Key (Measurements in mm)

### 3.3 Locating the C7-635 in a Mechanical Environment

#### Locating the C7-635

When installing a C7-635, pay attention to the following:

- The sheet thickness of a control cabinet door can be 2 to 4 mm. You must ensure that the gasket seals tightly around the entire device.
- A distance of at least 50 mm and 70 mm respectively must be maintained on the sides of the C7-635 for outgoing cables and to allow for air circulation, as is shown in Figure 3-9.
- Make sure the gasket is correctly seated on the front panel.
- The C7-635 must be protected from direct exposure to sunlight (the device should not be operated outside of enclosed areas).

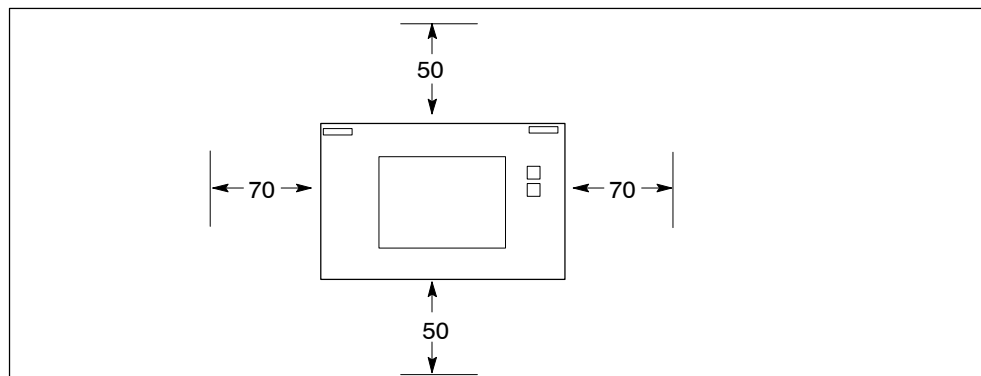

Figure 3-9 Installation Clearances When Mounting the C7-635 Touch

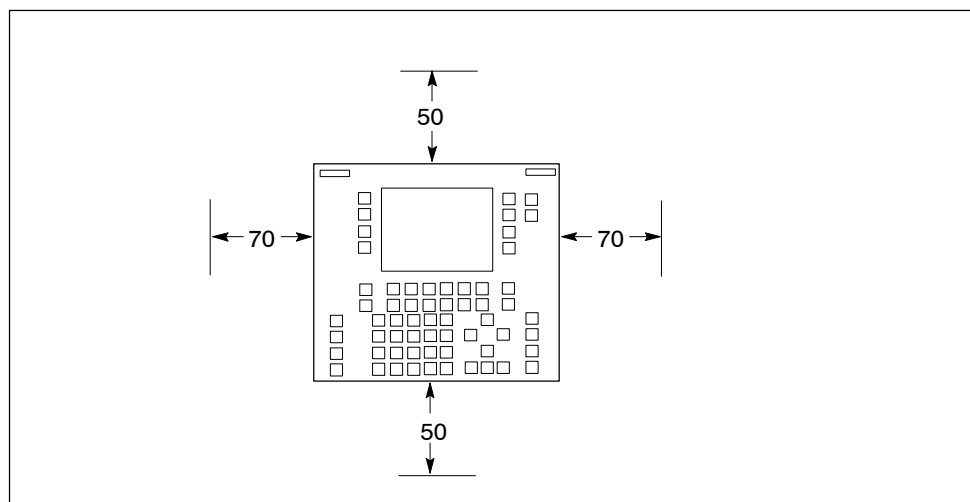

Figure 3-10 Installation Clearances when Mounting the C7-635 Key



### 3.4 Setting Up the Electrical Configuration and Connector Pin Assignment

#### Connector Pin Assignment of the C7-635

Tables 3-2 to 3-10 indicate the connector pin assignment of the C7-635. The figures show the C7-635 Touch as an example. Connector and socket positions are identical for the C7-635 Key.



**Caution**

For functional reasons, the connector pin assignment is not compatible with predecessor products C7-621, C7-623, C7-626, C7-633, and C7-634.

**Note**

The C7-635 cannot be used in an ungrounded configuration.

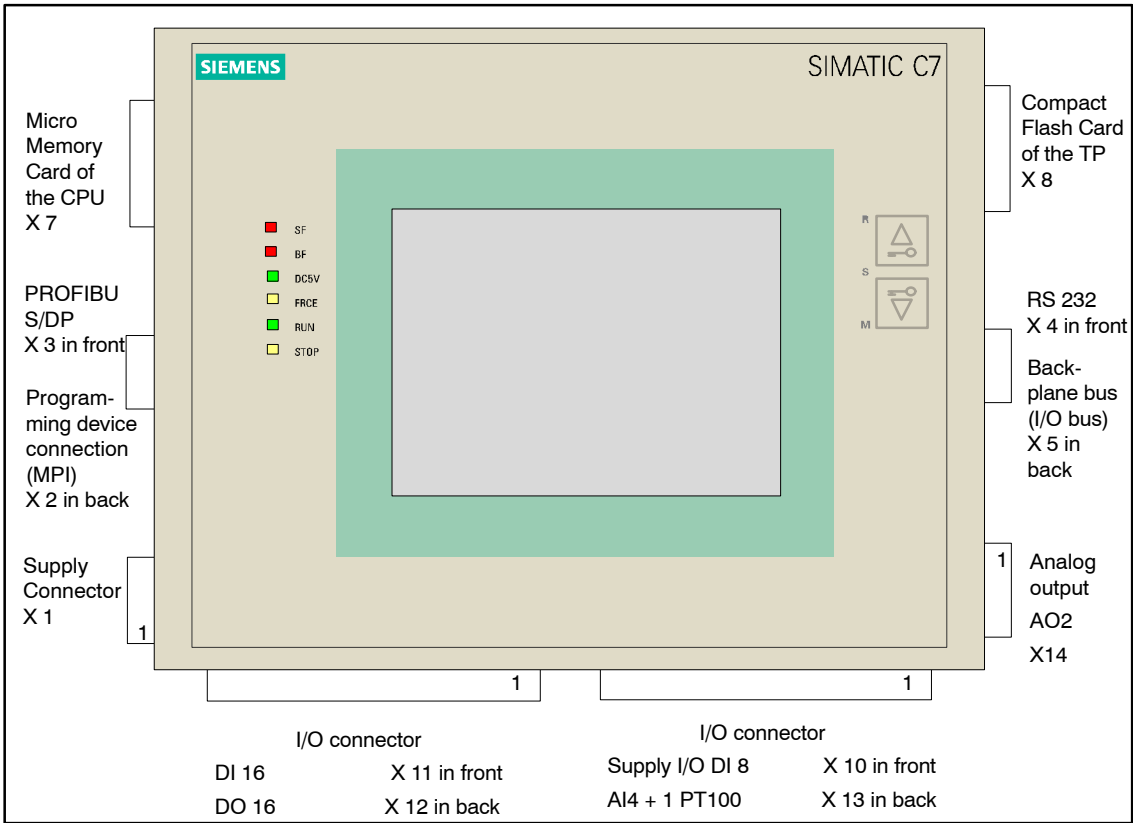

Figure 3-11 C7-635 Touch with Connectors and Sockets, Front View

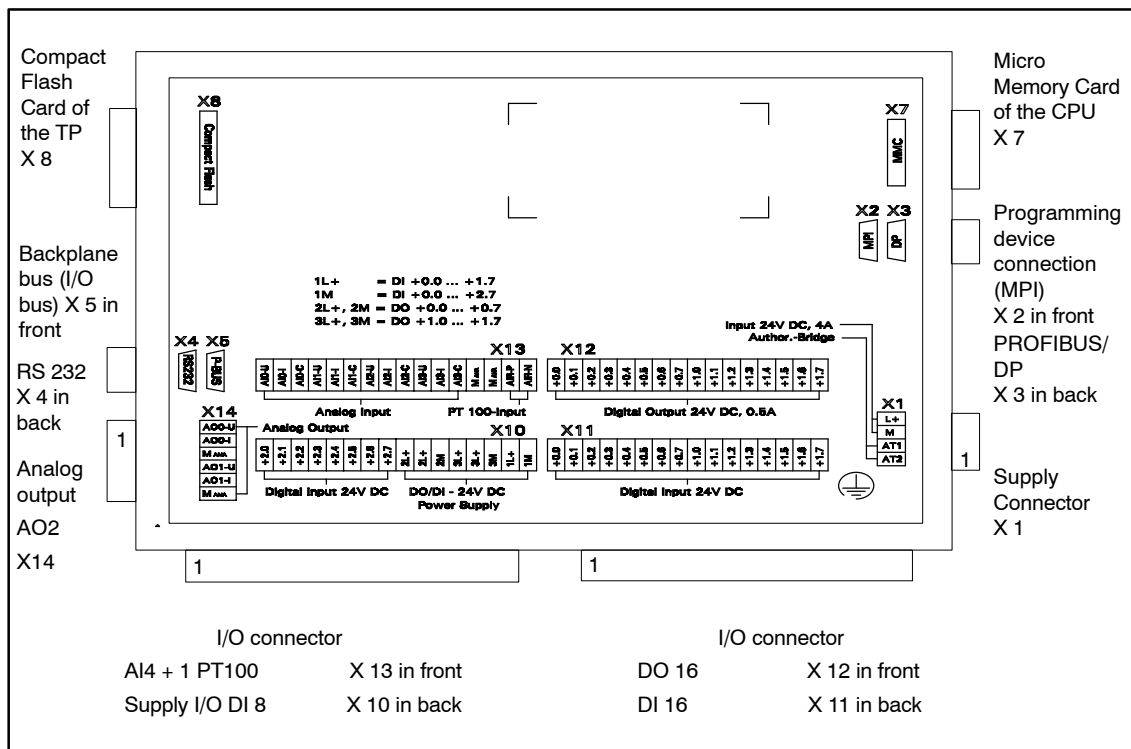

Figure 3-12 C7-635 with Connectors and Sockets, Back View

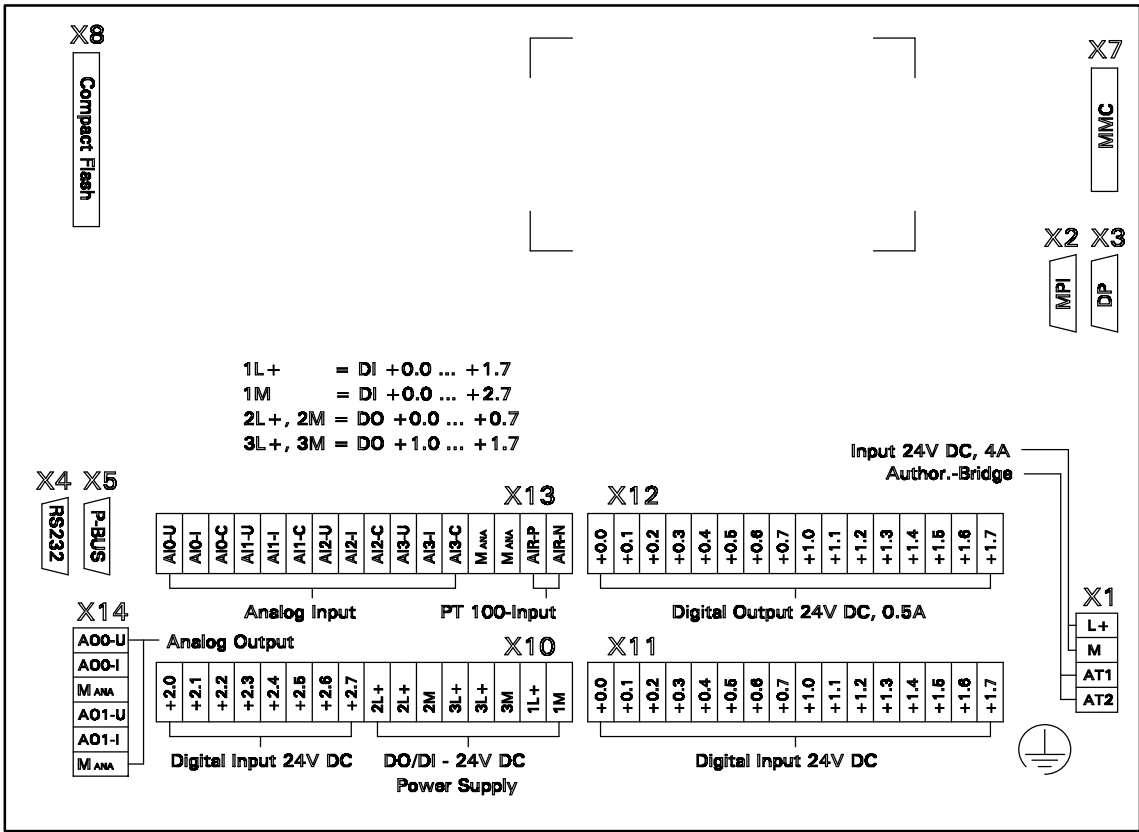

Figure 3-13 C7-635 Layout of Connector Pin Assignment

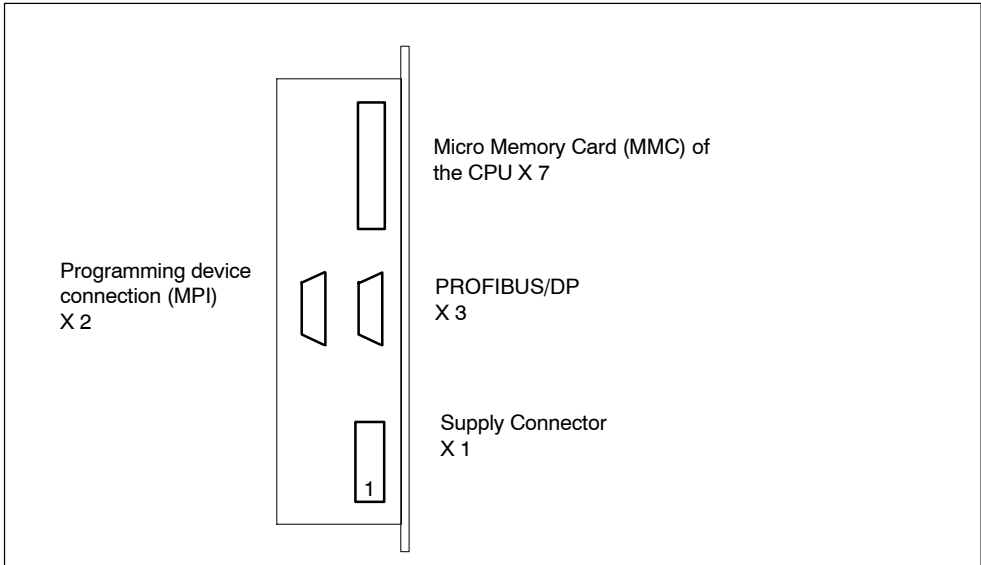

Figure 3-14 C7-635 with Connectors and Sockets, Side View

### Supply connector X1

Table 3-2 Supply Connector X1

| Pin Name | Signal | Description  |
|----------|--------|--|
| 1        | AT2    | Authorization input (for example, for external switch) |
| 2        | AT1    | Authorization input (for example, for external switch) |
| 3        | M      | Ground 24 V  |
| 4        | L+     | Supply voltage 24 VDC                                  |

### Programming Device Connection (MPI) 2

Table 3-3 Programming Device Connection (MPI) 2

| Pin Name | Signal   | Description             |
|----------|----------|-------------------------|
| 1        | NC       | Not connected           |
| 2        | M24V     | Ground 24 V             |
| 3        | B        | RS 485 cable B          |
| 4        | RTS      | RTS                     |
| 5        | M5V      | Ground 5 V              |
| 6        | P5V      | Supply voltage 5 V      |
| 7        | P24V MPI | Supply voltage 24 V MPI |
| 8        | A        | RS 485 cable A          |
| 9        | NC       | Not connected           |

### DP Connection X3

Table 3-4 DP Connection X3

| Pin Name | Signal  | Description            |
|----------|---------|------------------------|
| 1        | NC      | Not connected          |
| 2        | M24V    | Ground 24 V            |
| 3        | B       | RS 485 cable B         |
| 4        | RTS     | RTS                    |
| 5        | M5V     | Ground 5 V             |
| 6        | P5V     | Supply voltage 5 V     |
| 7        | P24V DP | Supply voltage 24 V DP |
| 8        | A       | RS 485 cable A         |
| 9        | NC      | Not connected          |

**RS 232 X4**

Table 3-5 RS232 Connection X4

| Pin Name | Signal | Description         |
|----------|--------|---------------------|
| 1        | DCD    | Received detector   |
| 2        | RXD    | Received data       |
| 3        | TXD    | Transmitted data    |
| 4        | DTR    | Data terminal ready |
| 5        | GND    | Ground 5 V          |
| 6        | DSR    | Data set ready      |
| 7        | RTS    | Request to send     |
| 8        | CTS    | Clear to send       |
| 9        | NC     | Not connected       |

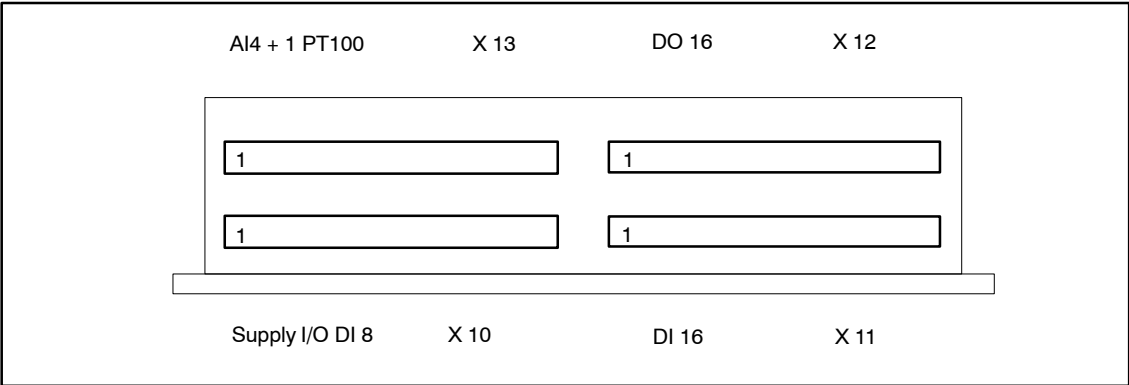

Figure 3-15 C7-635 with Connectors and Sockets, Bottom View

### I/O connector X10

Table 3-6 Connector Pin Assignment I/O Connector X10

| Pin Name | Signal | Description                           |
|----------|--------|---------------------------------------|
| 1        | DI+2.0 | Digital input 16                      |
| 2        | DI+2.1 | Digital input 17                      |
| 3        | DI+2.2 | Digital input 18                      |
| 4        | DI+2.3 | Digital input 19                      |
| 5        | DI+2.4 | Digital input 20                      |
| 6        | DI+2.5 | Digital input 21                      |
| 7        | DI+2.6 | Digital input 22                      |
| 8        | DI+2.7 | Digital input 23                      |
| 9        | 2L+    | 24 V supply voltage for DO 0.0 to 0.7 |
| 10       | 2L+    | 24 V supply voltage for DO 0.0 to 0.7 |
| 11       | 2M     | Ground for DO 0.0 to 0.7              |
| 12       | 3L+    | 24 V supply voltage for DO 1.0 to 1.7 |
| 13       | 3L+    | 24 V supply voltage for DO 1.0 to 1.7 |
| 14       | 3M     | Ground for DO 1.0 to 1.7              |
| 15       | 1L+    | 24 V supply voltage for DI 0.0 to 1.7 |
| 16       | 1M     | Ground for DI 0.0 to 2.7              |

**I/O Connector X 11**

For the technological functions, the meaning of the inputs is described in the columns "Counting", "Frequency Measuring", "Pulse Width Modulation", "Analog Positioning", and "Digital Positioning".

Table 3-7 Connector Pin Assignments I/O Connector X11

| Pin Name | Signal | Description      | Counting                     | Frequency Measuring | Pulse Width Modulation | Analog Positioning   | Digital Positioning |
|----------|--------|------------------|------------------------------|---------------------|------------------------|----------------------|---------------------|
| 1        | DI+0.0 | Digital input 0  | Channel 0: Trace A/Pulse     |                     | –                      | Sensor Signal A      |                     |
| 2        | DI+0.1 | Digital input 1  | Channel 0: Trace B/Direction |                     | –                      | Sensor Signal B      |                     |
| 3        | DI+0.2 | Digital input 2  | Channel 0: Hardware Gate     |                     |                        | Sensor Signal N      |                     |
| 4        | DI+0.3 | Digital input 3  | Channel 1: Trace A/Pulse     |                     |                        | Length Measurement   |                     |
| 5        | DI+0.4 | Digital input 4  | Channel 1: Trace B/Direction |                     | –                      | Home position switch |                     |
| 6        | DI+0.5 | Digital input 5  | Channel 1: Hardware Gate     |                     |                        | –                    |                     |
| 7        | DI+0.6 | Digital input 6  | Channel 2: Trace A/Pulse     |                     | –                      | –                    |                     |
| 8        | DI+0.7 | Digital input 7  | Channel 2: Trace B/Direction |                     | –                      | –                    |                     |
| 9        | DI+1.0 | Digital input 8  | Channel 2: Hardware Gate     |                     |                        | –                    |                     |
| 10       | DI+1.1 | Digital input 9  | Channel 3: Trace A/Pulse     |                     | –                      | –                    |                     |
| 11       | DI+1.2 | Digital input 10 | Channel 3: Trace B/Direction |                     | –                      | –                    |                     |
| 12       | DI+1.3 | Digital input 11 | Channel 3: Hardware Gate     |                     |                        | –                    |                     |
| 13       | DI+1.4 | Digital input 12 | Channel 0: Latch             | –                   |                        | –                    |                     |
| 14       | DI+1.5 | Digital input 13 | Channel 1: Latch             | –                   |                        | –                    |                     |
| 15       | DI+1.6 | Digital input 14 | Channel 2: Latch             | –                   |                        | –                    |                     |
| 16       | DI+1.7 | Digital input 15 | Channel 3: Latch             |                     |                        | –                    |                     |

### I/O Connector X 12

For the technological functions, the meaning of the outputs is described in the columns “Counting”, “Frequency Measuring”, “Pulse Width Modulation”, “Analog Positioning”, and Digital Positioning”.

Table 3-8 Connector Pin Assignments I/O Connector X12

| Pin Name | Signal | Description       | Counting          | Frequency Measuring | Pulse Width Modulation | Analog Positioning               | Digital Positioning |
|----------|--------|-------------------|-------------------|---------------------|------------------------|----------------------------------|---------------------|
| 1        | DO+0.0 | Digital output 0  | Channel 0: Output |                     |                        | –                                | –                   |
| 2        | DO+0.1 | Digital output 1  | Channel 1: Output |                     |                        | –                                | –                   |
| 3        | DO+0.2 | Digital output 2  | Channel 2: Output |                     |                        | –                                | –                   |
| 4        | DO+0.3 | Digital output 3  | Channel 3: Output |                     |                        | –                                | –                   |
| 5        | DO+0.4 | Digital output 4  | –                 | –                   | –                      | –                                |                     |
| 6        | DO+0.5 | Digital output 5  | –                 | –                   | –                      | –                                |                     |
| 7        | DO+0.6 | Digital output 6  | –                 | –                   | –                      | CONV_ EN<br>Enable power section | –                   |
| 8        | DO+0.7 | Digital output 7  | –                 | –                   | –                      | –                                | –                   |
| 9        | DO+1.0 | Digital output 8  | –                 | –                   | –                      | –                                | Q0                  |
| 10       | DO+1.1 | Digital output 9  | –                 | –                   | –                      | –                                | Q1                  |
| 11       | DO+1.2 | Digital output 10 | –                 | –                   | –                      | –                                | Q2                  |
| 12       | DO+1.3 | Digital output 11 | –                 | –                   | –                      | –                                | Q3                  |
| 13       | DO+1.4 | Digital output 12 | –                 | –                   | –                      | –                                | –                   |
| 14       | DO+1.5 | Digital output 13 | –                 | –                   | –                      | –                                | –                   |
| 15       | DO+1.6 | Digital output 14 | –                 | –                   | –                      | –                                | –                   |
| 16       | DO+1.7 | Digital output 15 | –                 | –                   | –                      | –                                | –                   |



I/O connector X13

Table 3-9 Connector Pin Assignment I/O Connector X13

| Pin Name | Signal | Description                          |
|----------|--------|--------------------------------------|
| 1        | AI0-U  | Analog voltage input channel 0       |
| 2        | AI0-I  | Analog current input channel 0       |
| 3        | AI0-C  | Analog reference potential channel 0 |
| 4        | AI1-U  | Analog voltage input channel 1       |
| 5        | AI1-I  | Analog current input channel 1       |
| 6        | AI1-C  | Analog reference potential channel 1 |
| 7        | AI2-U  | Analog voltage input channel 2       |
| 8        | AI2-I  | Analog current input channel 2       |
| 9        | AI2-C  | Analog reference potential channel 2 |
| 10       | AI3-U  | Analog voltage input channel 3       |
| 11       | AI3-I  | Analog current input channel 3       |
| 12       | AI3-C  | Analog reference potential channel 3 |
| 13       | MANA   | Analog ground                        |
| 14       | MANA   | Analog ground                        |
| 15       | AIR-P  | PT100_OUT                            |
| 16       | AIR-N  | PT100_IN                             |

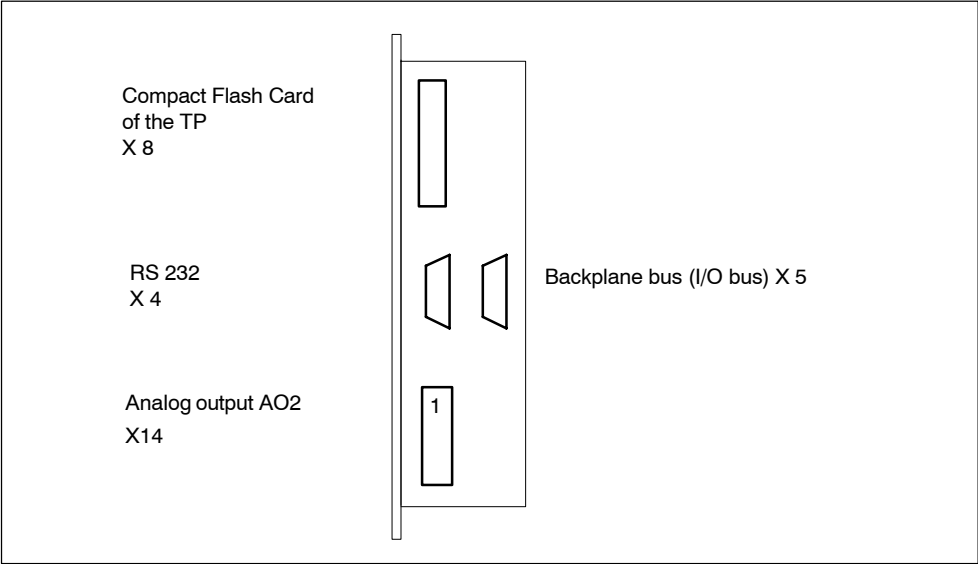

Figure 3-16 C7-635 with Connectors and Sockets, Side View

### Analog output X14

For the technological functions, the meaning of the outputs is described in the column "Analog Positioning".

Table 3-10 Connector Pin Assignments Analog Output X 14

| Pin Name | Signal | Description                     | Analog Positioning              |
|----------|--------|---------------------------------|---------------------------------|
| 1        | AO0_U  | Analog voltage output channel 0 | Voltage output<br>Power section |
| 2        | AO0_I  | Analog current output channel 0 | Current output<br>Power section |
| 3        | MANA   | Analog ground                   | Analog ground                   |
| 4        | AO1_U  | Analog voltage output channel 1 | –                               |
| 5        | AO1_I  | Analog current output channel 1 | –                               |
| 6        | MANA   | Analog ground                   | Analog ground                   |

**C7-635 Device Connections**

You can use the following cables to connect the C7-635 to other components:

Table 3-11 Cables for Connection to C7-635

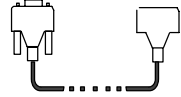
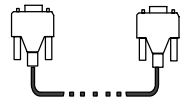
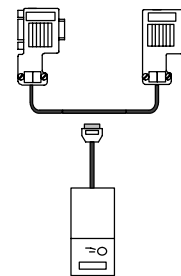
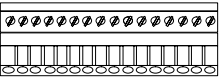
| Connecting Cable   | Length          | Special Features  | Illustration   | Connection  |
|--|-----------------|---|--|---|
| <b>S7-300 I/O Bus</b>  |                 |   |  |   |
| I/O expansion cable  | 0.25 m<br>1.5 m | -   |    | C7-635 — S7-300 rack  |
| <b>MPI Interface</b>   |                 |   |  |   |
| Programming device (PG) cable  | 5 m             | -   |    | For example:<br>C7-635 — PG<br>C7-635 — S7-300<br>C7-635 — S7-400 |
| <b>PROFIBUS-DP interface</b>   |                 |   |  |   |
| PROFIBUS bus cable<br>Indoor cable,<br>buried cable,<br>and bus connector,<br>without programming port,<br>with programming port<br>and PROFIBUS bus terminal RS 485,<br>with 1.5 m cable, with 3 m cable,<br>with programming port and<br>1.5 m cable | -               | Self-made<br>cable  |   | C7 — PG/PC<br>C7 — C7<br>C7 — S7-300<br>C7 — S7-400               |
| <b>Serial interface (RS 232 (V.24))</b>  |                 |   |  |   |
| Serial cable (printer cable)   |                 | See cata-<br>log<br>ST80.1                                |  | C7 — printer  |
| <b>IM361</b>   |                 |   |  |   |
| IM361 cable  |                 | -   |  | C7 — Additional I/O<br>(S7-300)                                   |
| <b>C7-635 I/O connections</b>  |                 |   |  |   |
| Connectors for C7-635 I/O<br><br>Cable cross section   |                 | 16-pin<br>6-pin<br>4-pin<br>0.2 to 2.5<br>mm <sup>2</sup> |  | C7 — External<br>sensing elements/<br>actuators                   |

## 3.5 Guidelines for Fail-Safe Construction

### Overview

Shielding measures must be implemented in an automation system to prevent faults. This can only be ensured by use of an enclosed metal construction (cabinet mounting, for example).

Low frequency (LF) or high frequency (HF) interference signals can reach the internal bus of the controller if the system is not grounded or shielded properly, causing a malfunction.

Interference signals can also be caused when relays or contactors switch (very rapid changes in current or voltage; HF interference signals) or when two components of system have different grounding potentials (LF interference signals).

---

### Note

You can find additional information about construction guidelines in the *S7-300, CPU 31xC and CPU 31x: Hardware and Installation* manual.

---

### Use/Installation of Fail-Safe Cables

- Only shielded cables are permitted for all analog signals.
- Cable shielding must be grounded on both sides for:
  - Controller cables
  - Bus cables
  - I/O device cables
- Standard cables from Siemens comply with these requirements.
- All plug connections must be screwed or clamped into place.
- Signal lines must not be laid parallel to heavy current lines. A separate cable channel must be used that is separated from heavy current lines by at least 50 cm.

## Cabinet Design

Devices that could introduce interference signals from outside into the cabinet must be placed far below the cabinet. The grounding terminal must be placed immediately at the cabinet entrance to directly ground cables capable of carrying interference signals. All shielded cables must be laid here with the shield. For double-shielded signal lines, only the outer shield is to be laid here.

Long signal lines must be installed along the cabinet walls. It is important to use an EMC-compliant cabinet construction to reduce disturbance variables. All chassis ground connections in the cabinet are to be made with a large cable cross section and laid over a large surface.

Analog devices located in the control cabinet must be isolated and grounded at a point in the cabinet (use a copper strip).

The materials used should always contain the same type of metal (as a rule, do not use aluminum due to the risk of oxidation).

All doors and plates (side walls, back wall, and ceiling) of the cabinet must be connected at least three times with cabinet framework (short, unpainted connections over a large surface).

---

### Note

The following applies for systems that generate large amounts of electrostatic energy (such as textile machines and special construction machines): The grounding conductors of the machine parts exposed to interference signals are to be connected to a special functional ground separated from the central grounding point of the cabinet (surface grounding with building construction, sheathing).

---

## Functional Ground

Connect the functional ground  (see Figure 3-17) to the cabinet ground with a cable lug and a cable with a minimum cross section of 4 mm<sup>2</sup>.

### 3.6 Connecting Shielded Cables

#### Overview

This section describes how to connect the shield of shielded signal lines to the ground. A grounding terminal is used to connect the shield directly to the ground of the C7-635.

#### Procedure

Proceed as follows to install the grounding terminal supplied with the C7-635 and the shield terminals:

1. Mount the grounding busbar at the position shown in Fig. 3-17, using the included screws (1) or, as an alternative, at this position (2).
2. Install the shielding terminals on the grounding busbar as shown in Fig. 3-17.
3. Push the stripped ends of the cable shielding into the shielding terminals.

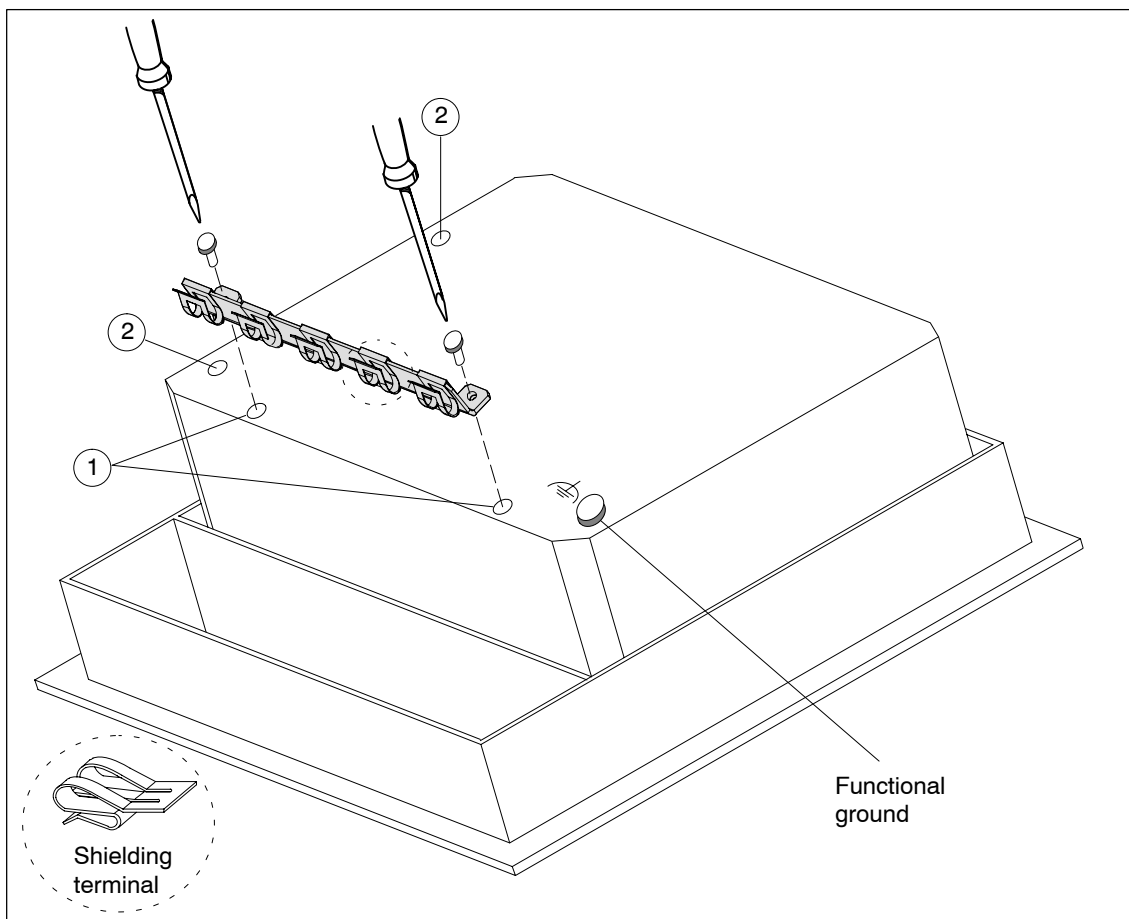

Figure 3-17 C7-635 with grounding busbar, shielding terminals, and terminal for functional ground

### 3.7 Coding Connector Parts to Prevent Incorrect Usage

You can order a connector set with coding profiles and coding tabs as an accessory for the C7-635 (see accessories in Section 2.2).



#### Caution

It is highly recommended that you code the connectors, as unintentionally using the wrong connector may damage the device.

#### Coding the Connectors

The coding profiles ① and coding tabs ② (see Figure 3-18) enable you to code connectors without loss of pole to prevent incorrect usage. Use the following procedure:

1. Insert coding profile ① on connector part ① into the slots provided.
2. Insert coding carrier ② on the main housing ② into the corresponding recesses.

A coding profile and a coding tab facing one another prevent the connector part from being inserted.

If a coding profile and coding carrier do not face one another, the connector part can be inserted without difficulty.

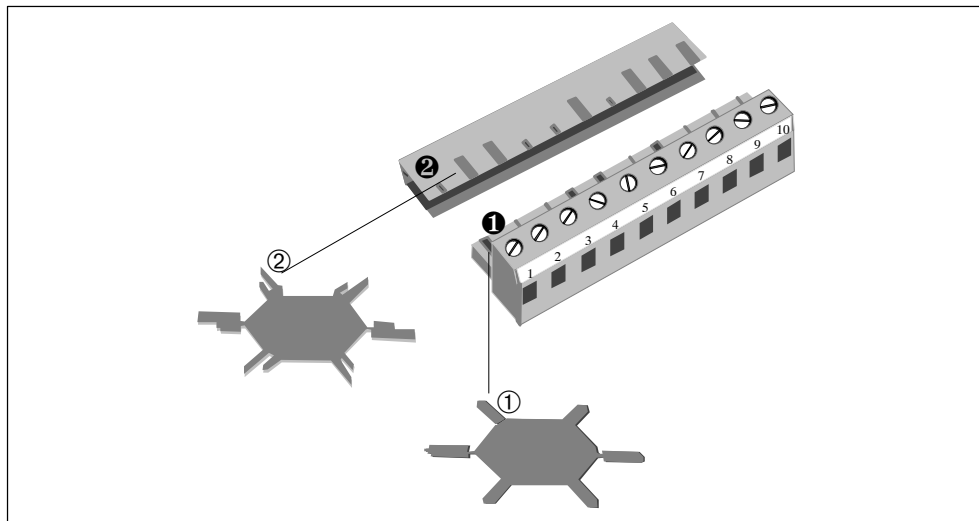

Figure 3-18 Preventing Incorrect Usage of Connectors





## Special Features of the C7-635

### Deviations from the CPU314C-2 DP

- Operating mode selection
- Arrangement of additional S7-300 modules
- Status display of the digital onboard I/O
- User memory expanded from 48 Kbytes to 64 Kbytes
- All integrated I/O inputs have a common reference ground

### Deviations from TP170 /OP170 B

- RS 485 interface (MPI) can not be switched to RS 422 interface
- No second RS 232 interface
- No DP interface to TP/OP

## 4.1 Operating Mode Selection

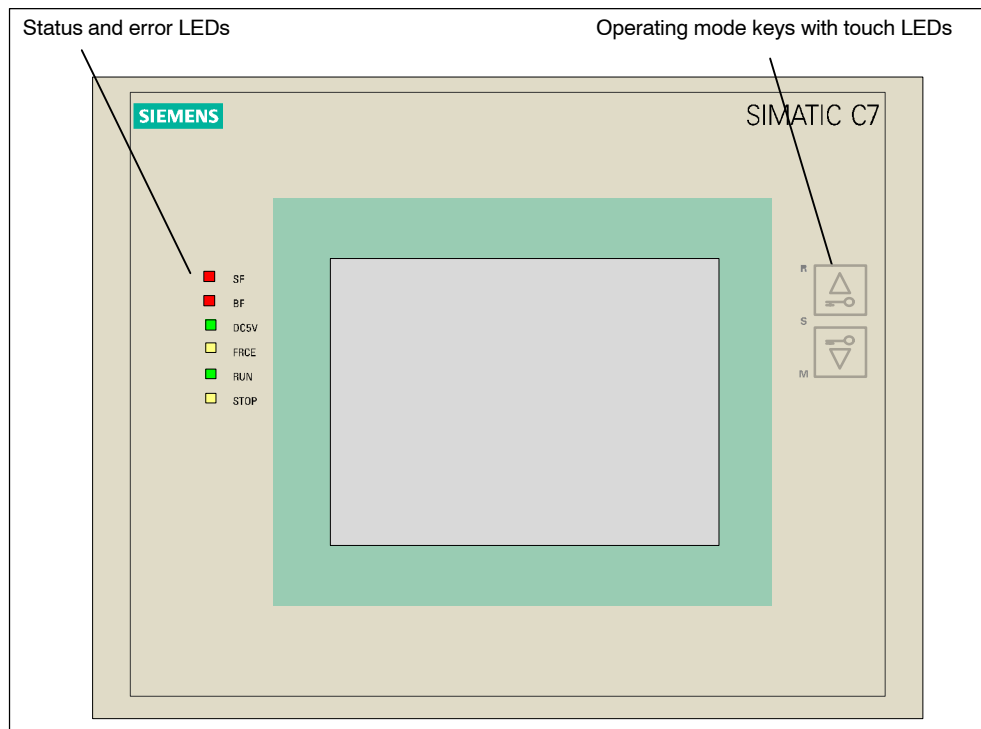

Figure 4-1 C7-635 Touch

### Changing the C7-CPU Operating Mode

The figure above uses the C7-635 Touch as an example. The function and position of the operating mode keys and the status and error LEDs are the same for the C7-635 Key.

Select the CPU operating modes RUN, STOP, and MRES as follows using the operating mode keys:

Each time you press a key, the CPU mode changes. The key must be pressed for at least 500 ms for the change to take place and the corresponding key LED (R, S, M) to illuminate. **The key LEDs do not reflect the CPU operating mode, rather, they indicate the setting of the operating mode keys.**

The key function can be activated and deactivated by means of the external authorization inputs AT1 and AT2 to prevent the C7-CPU operating modes from being changed in an uncontrolled manner (for example, by unauthorized operating staff).

The following applies for activated operating mode selection:

- You must have bridged the authorization inputs AT1/AT2
- The key LEDs alongside the operating mode keys indicate the mode selector setting
- The current CPU operating status is indicated by the status LEDs

The following applies to deactivated operating mode selection:

- You must leave the authorization inputs AT1 and AT2 open
- The key LEDs alongside the operating mode keys are switched off
- The current CPU operating status is indicated by the status LEDs

The authorization inputs are located on supply connector X1 of the C7-635 (see also Table 3-2).

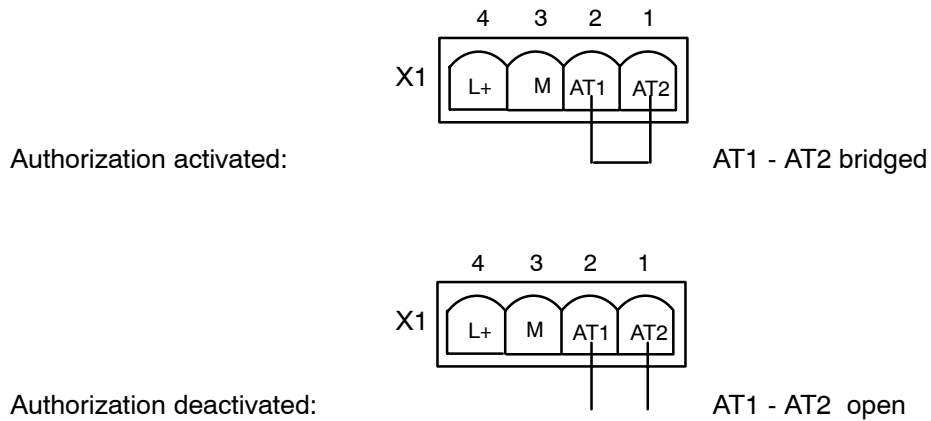
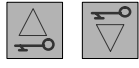

Table 4-1 Operating Mode Keys

| Operating Mode | Key | Description/Procedure   |
|----------------|-----|---|
| RUN<br>(R)     |     | The C7-CPU executes the user program.<br>Programs and data: <ul style="list-style-type: none"> <li>• Can be read out from the C7-CPU with the programming device/PC (C7 → programming device).</li> <li>• Can be transmitted to the S7-CPU or changed there (programming device/PC → C7).</li> </ul>  |
| STOP<br>(S)    |     | The C7-CPU does not execute user programs.<br>Programs: <ul style="list-style-type: none"> <li>• Can be read out from the C7-CPU with the programming device/PC (C7 → programming device/PC)</li> <li>• Can be transmitted to the C7-CPU and changed there (programming device/PC → C7).</li> </ul> <p><b>Note:</b><br/>STOP mode is only valid for the C7-CPU. It does not apply to the C7-TP/OP. It is always possible to continue working with the C7-TP/OP.</p> |

Table 4-1 Operating Mode Keys, continued

| Operating Mode | Key   | Description/Procedure   |
|----------------|---|---|
| MRES<br>(M)    |  | <p><b>General reset</b></p> <p>Performing a general reset of the C7-CPU (clearing the memory and reloading the user program from the MMC) requires a special operating mode key procedure:</p> <ol style="list-style-type: none"> <li>1. Select STOP mode by pressing the DOWN key. <ul style="list-style-type: none"> <li>– The key LED “S” illuminates, and</li> <li>– the CPU status LED “STOP” illuminates.</li> </ul> </li> <li>2. Select MRES mode by pressing the UP key and the DOWN key at the same time. The “M” key LED illuminates.</li> <li>3. Hold the keys down until the status LED “STOP” illuminates for the second time and remains lit (this occurs after 3 seconds).</li> <li>4. Now release the keys.</li> <li>5. You must repeat pressing both keys within 3 seconds.</li> <li>6. Release the keys when the “STOP” status LED flashes rapidly (at 2 Hz).</li> </ol> <p>When the CPU has finished the general reset operation, the “STOP” status LED stops flashing and remains lit. The CPU is now reset and in STOP mode.</p> |

The operator actions described in the table above are only required if:

- The user wants to perform a general reset of the C7-635 without the C7-635 itself giving a general reset prompt (indicated by slow flashing of the “STOP” status LED).
- The C7-635 requests a general reset itself, pressing both keys briefly is sufficient to start the general reset process.

If the C7-635 requests a new general reset after a general reset operation has been performed, the MMC may require formatting in certain cases. You will find information on this subject in the *S7-300, CPU 31xC and CPU 31x: Hardware and Installation* manual.

If the group error (SF) display is illuminated on the C7-635, its diagnostic buffer has to be evaluated with the programming device/PC. More information about the entries in the diagnostic buffer is provided in the STEP 7 Online Help.

## 4.2 Status and Error Displays of the C7-635

### Meaning of the Status and Error Displays

The status and error displays are explained in the sequence in which they are arranged on the C7-635.

| Display       | Meaning                     | Description   |
|---------------|-----------------------------|---|
| SF (red)      | C7-635 group error (SF)     | <b>Illuminates</b> if there are: <ul style="list-style-type: none"> <li>• Hardware errors</li> <li>• Firmware errors</li> <li>• Programming errors</li> <li>• Parameter assignment errors</li> <li>• Calculation errors</li> <li>• Time errors</li> <li>• I/O errors during internal I/O functions</li> <li>• For exact error determination, a programming device/PC has to be used, and the diagnostic buffer has to be read out.</li> </ul> |
| BF (red)      | Bus error indication        | <b>Illuminates</b> when there are <ul style="list-style-type: none"> <li>• bus errors (physical errors)</li> <li>• DP interface errors</li> </ul>   |
| 5 VDC (green) | 5 VDC supply for the C7-635 | <b>Illuminates</b> if internal 5 VDC supply is okay.  |
| FRCE (yellow) | Reserved                    | <b>Illuminates</b> when a force request is active.  |
| RUN (green)   | RUN mode of the C7-635      | <b>Illuminates</b> when the C7-635 is processing the user program.<br><b>Flashes</b> (2 Hz) during the C7-635 startup (in addition, the STOP display illuminates; after the STOP display goes out, the outputs are enabled).  |
| STOP (yellow) | STOP mode of the C7-635     | <b>Illuminates</b> when the C7-635 is not executing a user program<br><b>Flashes</b> slowly when the C7-635 requests a general reset<br><b>Flashes</b> rapidly when the C7-635 is performing a general reset.   |

## 4.3 Arrangement of additional S7-300 modules

### Additional S7-300 Modules

You have the option of connecting up to four additional S7-300 modules to the C7-635 by means of the S7-300 I/O bus. These modules can be connected either directly on the device or at a distance of up to 1.5 m.

If you insert an IM-360 interface module, you can use it to connect additional modules.

You will find a description of how to install S7-300 modules in the *S7-300, CPU 31xC and CPU 31x: Hardware and Installation* manual.

### Connecting Additional S7-300 Modules Directly on the Device

In the figures below, the C7-635 Touch is used as an example. The installation steps are the same for the C7-635 Key.

#### 2-Module I/O set

As a prerequisite, you must have the “2-module I/O set” accessory specifically for the C7-635.

Use the following procedure to connect the additional S7-300 modules:

1. Screw the mounting plate to the back wall of the C7-635 housing.
2. Install the C7-635 in the control cabinet door. Refer to the notes in Chapter 3.2 for this.
3. Connect the C7-635 to the module (inserted on the left in the figure) using the connecting cable (0.25 m).
4. Connect the two modules using the connecting cable (0.08m).
5. Mount the modules on the S7 DIN rail.

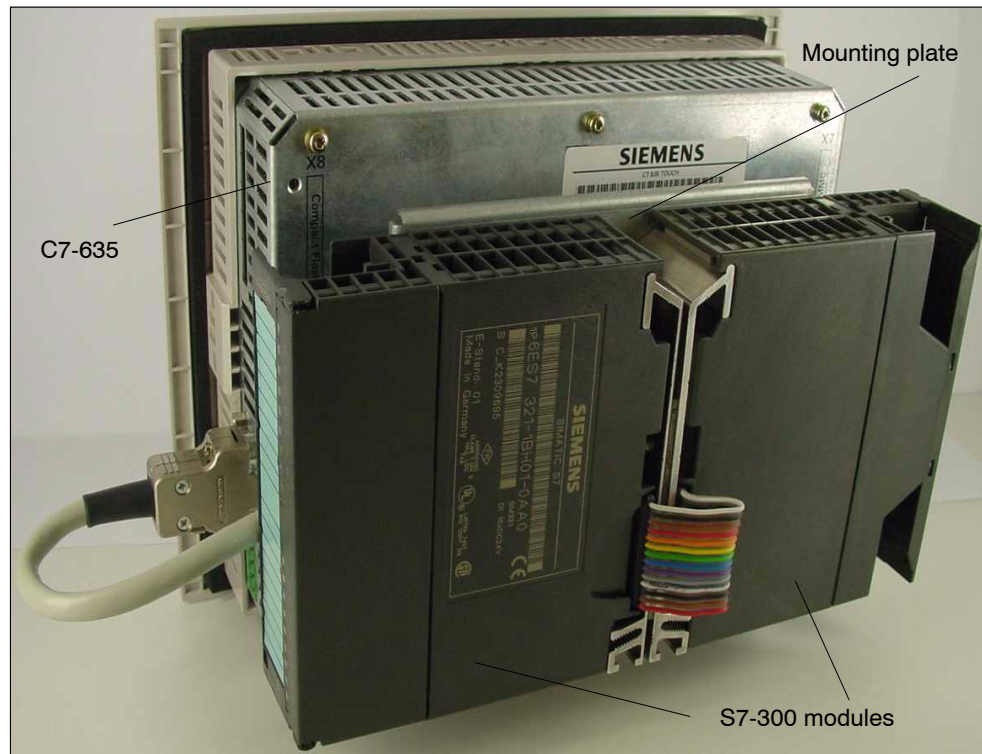

Figure 4-2 Connecting Additional S7-300 Modules Directly on the Device Using the 2-Module I/O Set

#### 4-Module I/O Set

As a prerequisite, you must have the “4-module I/O set” accessory specifically for the C7-635.

Use the following procedure to connect the additional S7-300 modules:

1. Bolt the S7 DIN rail (190 mm) to the back wall of the C7-635.
2. Install the C7-635 in the cabinet door. Follow the instructions in chapter 3.2
3. Connect the C7-635 to the outermost modules on the left-hand side using the connecting cable.
4. Mount the modules on the S7 DIN rail (190 mm).

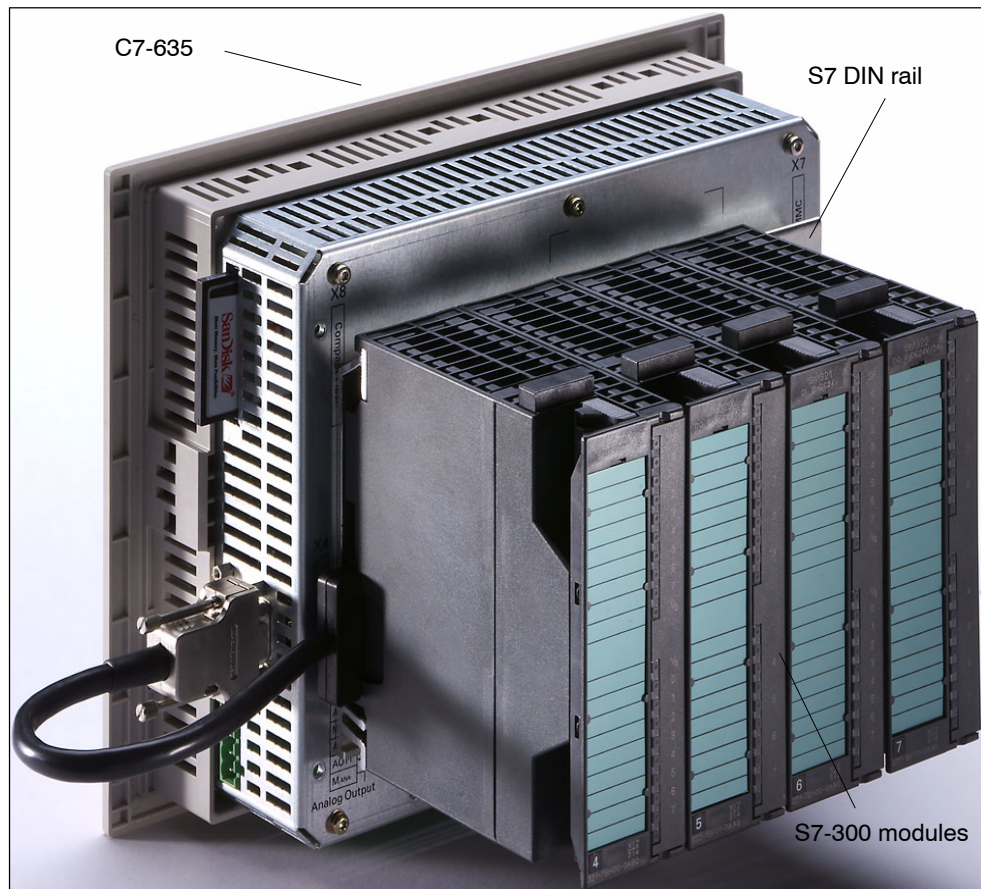

Figure 4-3 Connecting Additional S7-300 Modules Directly on the Device Using the 2-Module I/O Set

### Connecting Additional S7-300 Modules at a Distance of Up to 1.5 m

As a prerequisite, you must have the “1.5 m cable” accessory specifically for the C7-635 and a standard DIN rail.

Use the following procedure to connect the additional modules:

1. Connect the C7-635 to the outermost modules on the left-hand side by means of the connecting cable.
2. Mount the modules on an S7 standard DIN rail of the S7-300 programmable controller.
3. Using the cable clamp, connect the shield support of the I/O bus cable to the S7 DIN rail.

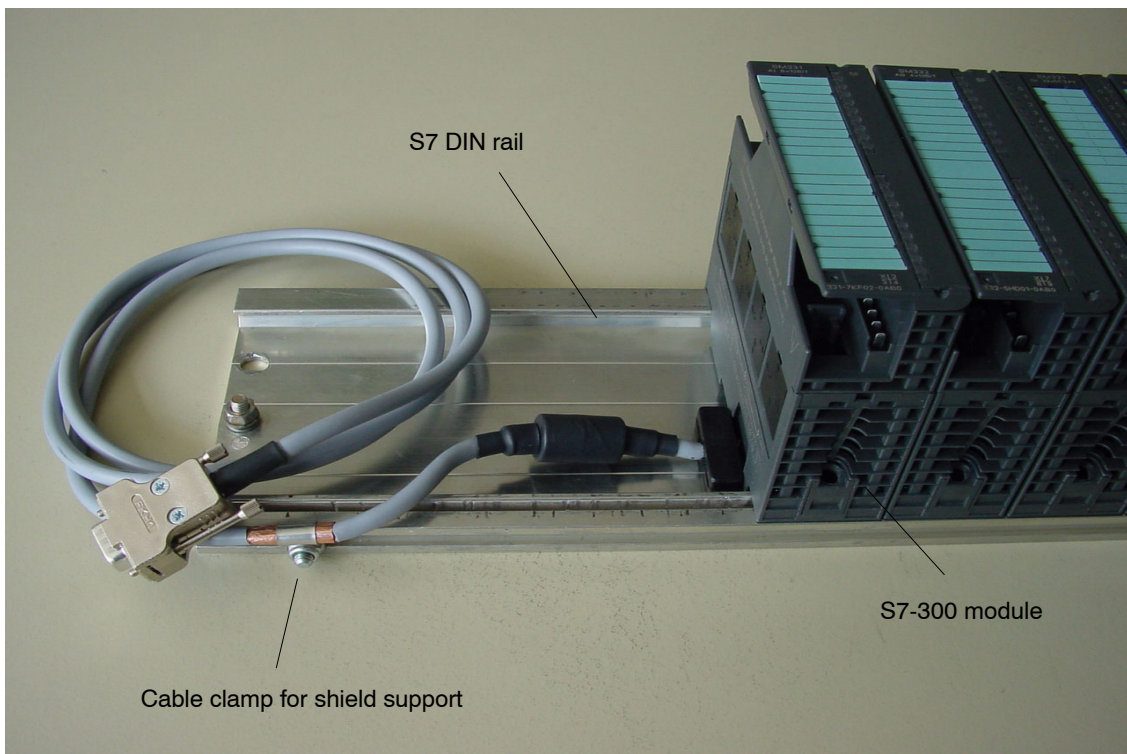

Figure 4-4 Connecting Additional S7-300 Modules at a Distance of Up to 1.5 m



## 4.4 Status Display of the Digital Onboard I/O

### I/O Status Display

There are no LEDs for displaying the status of the C7-635 I/O. You can configure a screen to display the I/O status (see Figure 4-5).

The represented values must be read as a direct **process image** of the DI and an internal process image of the DO of the digital C7-635 I/O, and displayed in the BIN format.

Note that when the C7-CPU is in STOP mode, the real process status DO is 0. However, the last process status set by the program is displayed.

The following data are displayed:

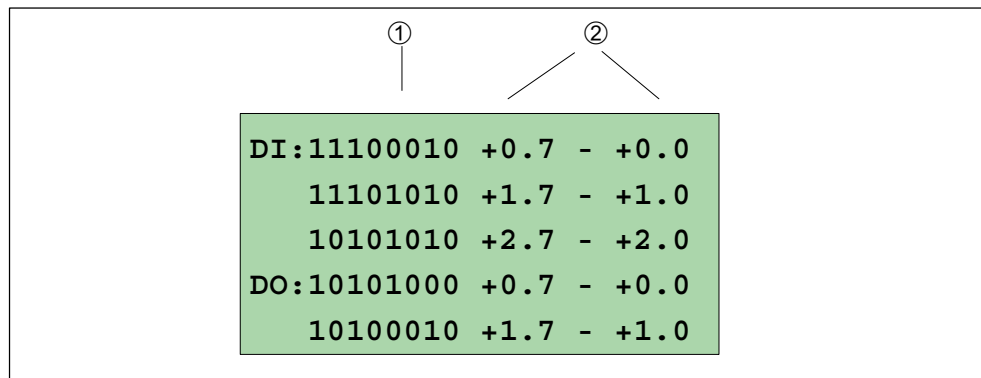

Figure 4-5 DI/DO Status Display

Table 4-2 Description of the DI/DO Status Display in Figure 4-5

| Item | Description   |
|------|---|
| ①    | Signal status of the DI/DO <ul style="list-style-type: none"> <li>• 1 DI/DO set</li> <li>• 0 DI/DO reset</li> </ul> |
| ②    | Pin Name DI/DO  |

### Note

The values of the DI/DO are read in and displayed in the time configured with ProTool. Changes made between these two occurrences are not displayed.



## Maintenance

The operator panel is designed for low-maintenance operation. Maintenance is limited to the following:

- Regular cleaning of the monitor
- Replacement in case of a defect

### 5.1 Cleaning the Monitor

#### Preparation

Clean the monitor of your device at regular intervals using a damp cloth. Switch the device off or select the configured cleaning screen. This ensures that you do not unintentionally delete functions.

#### Cleaning Screen

If the cleaning screen function is configured in your project, you can clean the monitor of the C7-635 Touch while it is switched on during the time displayed (in the progress bar) without unintentionally deleting functions. All inputs are disabled during this time.

#### Protective Film

A protective film is available for the C7-635 Touch. This film protects the monitor from scratches and smudges.

#### Cleaning Solution

Use only water and cleaning solution or a foaming screen cleaner to dampen the cloth. Spray the cleaning solution onto the cloth, rather than directly onto the monitor.

---

#### Note

If you use a harsh solvent or scouring solution, the keyboard can rub off or the touch screen can be damaged.

---

## 5.2 Replacing the C7-635

### Introduction

A C7-635 is not designed for onsite repair. Therefore, a defective C7-635 must be replaced.

To save the configuration of the TP/OP, you should have a Compact Flash Card (CF Card). You should make a backup of the configuration on the CF card as soon as you have finished commissioning the device, so that you can restore the configuration if the device becomes defective.



### Caution

Prior to installing and uninstalling the device, remove the Micro Memory Card (MMC) of the CPU and the Compact Flash Card (CF Card) of the TP/OP.

The inserted CF card protrudes from the C7-635 and could therefore be damaged.

How you proceed depends on whether you have backed up the TP/OP configuration on a CF Card.

### With CF Card

#### Requirements

- You have inserted a CF Card.
- You have a new gasket. The gasket must be replaced each time the C7-635 is installed or uninstalled. The gasket is part of the service pack (see Section 2.2).

#### Assembly

| Step | Action   |
|------|--|
| 1.   | Create a backup of the TP/OP configuration on the CF card. You should create the backup immediately prior to uninstalling the device so that current data (such as recipes) are included. Refer to the "Touch Panel TP170 A, TP 170 B, Operator Panel OP170 B" manual for information about how to make a backup copy. |
| 2.   | You do not need to take special action to back up the user program on the CPU. It is saved as a non-volatile program on the MMC.   |
| 3.   | Switch off the power supply.   |
| 4.   | Loosen the cables from the shielding terminals and remove all connectors.  |
| 5.   | Remove the MMC and the CF Card.  |
| 6.   | Loosen the mounting supports with a screwdriver and remove the device from the control cabinet.  |

## Installation

| Step | Action  |
|------|---|
| 1.   | Complete the mechanical installation as described in Section 3.2. Be sure to observe the relevant notes.  |
| 2.   | Insert the MMC and the CF Card.   |
| 3.   | Insert the cables and press the bare cables into the shielding terminals, as described in Section 3.6.  |
| 4.   | Switch on the power supply.   |
| 5.   | Reload the saved data of the TP/OP configuration to the internal memory (Restore). You will find a description of this procedure in the "Touch Panel TP170 A, TP170B, Operator Panel OP170 B" manual. |
| 6.   | Perform a general reset of the C7-CPU.  |
| 7.   | Switch the CPU to RUN mode.   |

## Without CF Card

### Requirements

- You have a new gasket. The gasket must be replaced each time the C7-635 is installed or uninstalled. The gasket is part of the service pack (see Section 2.2).
- Programming device/PC with MPI interface
- Corresponding connecting cable (MPI)
- ProTool

### Assembly

| Step | Action  |
|------|---|
| 1.   | Connect a programming device/PC to the MPI interface.   |
| 2.   | Save the TP/OP configuration in the C7-635 with ProTool. If the C7-635 is defective and the configuration cannot be read, uninstall the C7-635 without any additional safety precautions. |
| 3.   | You do not need to take special action to back up the user program on the CPU. It is saved as a non-volatile program on the MMC.  |
| 4.   | Switch off the power supply.  |
| 5.   | Loosen the cables from the shielding terminals and remove all connectors.   |
| 6.   | Remove the MMC.   |
| 7.   | Loosen the mounting supports with a screwdriver and remove the device from the control cabinet.   |

### Installation

| Step | Action   |
|------|--|
| 1.   | Complete the mechanical installation as described in Section 3.2. Be sure to observe the relevant notes.         |
| 2.   | Insert the MMC.  |
| 3.   | Insert the cables and press the bare cables into the shielding terminals, as described in Section 3.6.           |
| 4.   | Switch on the power supply.  |
| 5.   | Connect the C7-635 to the MPI interface of the programming device/PC.  |
| 6.   | Make sure that in the "Control Panel" in the menu "Transfer > Transfer Settings" the MPI interface is activated. |
| 7.   | Activate the transfer mode and download the backed-up TP/OP configuration with ProTool.                          |
| 8.   | Clear and reset the C7-CPU.  |
| 9.   | Switch the CPU to RUN mode.  |

# Technical Specifications

# A

## A.1 Technical Specifications for Complete Apparatus

In this table, you will find the technical specifications for the complete apparatus.

Table A-1 Technical Specifications for C7-635

| General Specifications                                   | C7-635 Touch  | C7-635 Key  |
|--|---|---|
| Order No.  | 6ES7635-2EB01-0AE3  | 6ES7635-2EC01-0AE3  |
| Dimensions<br>Mounting dimensions                        | 260 x 199 x 79 mm (WxHxD)<br>231 x 183 mm<br>(tolerance: +1 mm) | 260 x 274 x 80 mm (WxHxD)<br>231 x 257 mm<br>(tolerance: +1 mm) |
| Mounting depth for 2-module I/O set:                     | 144 mm (measured from the outer metal edge of the cutout)       |   |
| Mounting depth for 4-module I/O set:                     | 195 mm (measured from the outer metal edge of the cutout)       |   |
| Weight   | 1,380 g   | 1,500 g   |
| Display<br>Active screen surface<br>Resolution<br>Colors | 116 x 87 mm<br>320 x 240<br>Blue mode in 4 shades               |   |
| Keyboard   | Resistive touch<br>Two-key membrane keyboard                    | Matrix keyboard<br>61-key membrane keyboard                     |

| Power Supply  | C7-635 Touch  | C7-635 Key   |
|---|---|--|
| Supply voltage ( $U_N$ )<br><br><ul style="list-style-type: none"> <li>• Polarized input voltage</li> <li>• Voltage interruption (can be jumpered)</li> </ul> | 24 VDC; (20.4 VDC to 28.8 VDC, Safety Extra Low Voltage, SELV)<br>The C7-635 has no integrated protection against high-energy interfering pulses in the $\mu$ s-range (surge pulse). Consult the <i>S7-300, CPU 31xC and CPU 31x: Hardware and Installation</i> manual for the required protective specifications.<br>Yes<br>$\geq 20$ ms |  |
| Current consumption   | Typically 350 mA in no-load operation<br>1 A maximum  | Typically 350 mA in no-load operation<br>1 A maximum |
| Inrush current  | 2 A for 70 ms   | 2 A for 70 ms  |
| Power losses  | 14 W  | 14 W   |
| Ungrounded configuration  | Not possible  |  |

| Software                        | C7-635 Touch  | C7-635 Key    |
|---------------------------------|---------------|---------------|
| TP/OP operating system platform | MS Windows CE | MS Windows CE |

| Safety  | C7-635 Touch  | C7-635 Key  |
|---|---|---|
| Standard references   | DIN EN 61131-2 corresponds to IEC 61131-2   |   |
| Protection against ingress of solid foreign bodies and water <ul style="list-style-type: none"> <li>• Front panel</li> <li>• Housing</li> </ul> | IP 65 in accordance with IEC 60529, NEMA 4X<br>IP 20 in accordance with IEC 60529 | IP 65 in accordance with IEC 60529, NEMA 4X<br>IP 20 in accordance with IEC 60529 |

| Electromagnetic Compatibility (EMC)          | C7-635 Touch  | C7-635 Key |
|--|---|------------|
| Emitted interference<br>Limit class          | A in accordance with EN55011  |            |
| Cable-fed disturbances on DC supply cables   | ±2 kV (in accordance with IEC 61000-4-4; burst)<br>Surge measurements with additional protective elements:<br>±1 kV (in accordance with IEC 61000-4-5; µs-pulse/cable to cable)<br>±2 kV (in accordance with IEC 61000-4-5; µs-pulse/cable to ground)   |            |
| Interference immunity on signal cables       | ±2 kV (in accordance with IEC 61000-4-4; burst)   |            |
| Interference immunity from static discharges | ±6 kV, contact discharge (in accordance with IEC 61000-4-2; ESD)<br>±8 kV, air discharge (in accordance with IEC 61000-4-2; ESD)  |            |
| Immunity to high-frequency radiation         | 10 V/m, with 80% amplitude modulation at 1 kHz, 10 kHz to 80 MHz (in accordance with IEC 61000-4-6)<br>10 V/m, with 80% amplitude modulation at 1 kHz, 80 MHz to 1 GHz (in accordance with IEC 61000-4-3)<br>10 V/m, pulse-modulated 50% ED at 900 MHz and 1.89 GHz (in accordance with IEC61000-4-3) |            |

| Climatic Conditions                                 | C7-635 Touch   | C7-635 Key |
|---|--|------------|
| Temperature<br>Operation                            | Tested in accordance with IEC 60068-2-1 and IEC 60068-2-2:<br>0 °C to +40 °C in horizontal mounting position<br>0 °C to +45 °C in 45° mounting position<br>0 °C to +50 °C in vertical mounting position  |            |
| Storage/transport                                   | <b>Note:</b> <ul style="list-style-type: none"> <li>• When the device is in a horizontal mounting position, display readability is limited.</li> <li>• At temperatures &lt; 10°C, rapidly changing displays do not appear correctly.</li> </ul> -20 °C to +70 °C |            |
| Relative humidity<br>Operation<br>Storage/transport | Tested in accordance with IEC 60068-2-3<br>5% to 95% at 25 °C (no condensation)<br>5% to 95% at 25 °C (no condensation)  |            |
| Air pressure<br>Operation<br>Storage/transport      | 1080-795 hPa (corresponds to -1000 m to +2000 m)<br>1080-660 hPa (corresponds to -1000 m to +3500 m)   |            |

| Mechanical Environmental Conditions | C7-635 Touch | C7-635 Key |
|-------------------------------------|--------------|------------|
|-------------------------------------|--------------|------------|



| Mechanical Environmental Conditions                                | C7-635 Touch   | C7-635 Key |
|--|--|------------|
| Vibration<br>Operation<br>Storage/transport in packaging           | Tested in accordance with IEC 60068-2-6<br>10 to 58 Hz, amplitude 0.075<br>58 to 150 Hz, acceleration 9.8 m/s <sup>2</sup><br>5 to 9 Hz, amplitude 3.5 mm<br>9 to 500 Hz, acceleration 9.8 m/s |            |
| Shock test<br>Operation<br>Storage/transport                       | Tested in accordance with IEC 60068-2-29<br>Half-sine: 150 m/s <sup>2</sup> (15 g), 11 ms, 18 shocks<br>250 m/s <sup>2</sup> (25 g), 6 ms, 1,000 shocks  |            |
| Resistance to fire:<br>Terminal strips<br>Master strips in housing | FV2 (tested in accordance with IEC 60707)<br>FV0   |            |

## A.2 Technical Specifications for TP/OP

The table below summarizes the TP/OP scope of functions for the C7-635. The values provided for HMI functions are maximum values that can be managed by the C7-635. These values are limited by the size of the internal configuration memory and the size of the Compact Flash Card (CF Card) of the TP.

Table A-2 Functional Scope of TP/OP

| Function                    |                                 | C7-635 Touch (TP)   | C7-635 Key (OP) |
|-----------------------------|---------------------------------|---|-----------------|
| <b>Memory</b>               | Configuration of the TP         | 768 Kbytes internal   |                 |
|                             | Recipes                         | 32 Kbytes internal, expandable by means of Compact Flash Card (CF card) |                 |
| <b>Operational messages</b> | Number                          | 400 <sup>1)</sup>   |                 |
|                             | Display                         | Message line, message window/<br>message page, message display          |                 |
|                             | View all pending messages       | Message page/message display  |                 |
|                             | Length of message text per line | 70 characters   |                 |
|                             | Process values in message text  | 8   |                 |
|                             | Edit message                    | ✓   |                 |

Table A-2 Functional Scope of TP/OP, continued

| Function                       |  | C7-635 Touch (TP)                           | C7-635 Key (OP)  |
|--------------------------------|--|---|--|
| <b>Error messages</b>          | Number   | 400 <sup>1)</sup>                           |  |
|                                | Display  | Message window/message page/message display | Message line/Message window/Message page/Message display |
|                                | Display type   | First/last, selectable                      |  |
|                                | Display all pending messages   | inmessage page/message display              |  |
|                                | Length of message text per line  | 70 characters                               |  |
|                                | Process values in message text   | 8   |  |
|                                | Acknowledge individual error messages                                      | ✓   |  |
|                                | Acknowledge multiple error messages simultaneously (group acknowledgement) | 16 acknowledgement groups                   |  |
|                                | Edit message   | ✓   |  |
| <b>Alarm_S</b>                 | Display S7 messages  | ✓   |  |
| <b>Message printout</b>        | Printer output   | ✓   |  |
| <b>Volatile message buffer</b> | Capacity   | 128 message events                          |  |
|                                | View status/error messages   | ✓   |  |
|                                | Delete   | ✓   |  |
|                                | Print  | ✓   |  |
|                                | Simultaneously pending message events (maximum)                            | 64  |  |
| <b>Message recording</b>       | Time of occurrence   | Date/time                                   |  |
|                                | Message event  | Incoming, outgoing, acknowledged            |  |

Table A-2 Functional Scope of TP/OP, continued

| Function                      |                             | C7-635 Touch (TP) | C7-635 Key (OP) |
|-------------------------------|-----------------------------|-------------------|-----------------|
| <b>Screens</b>                | Number                      | 100               |                 |
|                               | Fields per screen           | 50                |                 |
|                               | Variables per screen        | 50                |                 |
|                               | Complex elements per screen | 5                 |                 |
|                               | Displays                    | ✓                 | ✓               |
|                               | Print (hard copy)           | ✓                 | ✓               |
|                               | Screen objects              |                   |                 |
|                               | • Graphics                  | ✓                 | ✓               |
|                               | • Text                      | ✓                 | ✓               |
|                               | • Output field              | ✓                 | ✓               |
|                               | • Input field               | ✓                 | ✓               |
|                               | • Symbolic output field     | ✓                 | ✓               |
|                               | • Select field              | ✓                 | ✓               |
|                               | • Date/time                 | ✓                 | ✓               |
|                               | • Graphic list              | ✓                 | ✓               |
|                               | • Vector graphic            | ✓                 | ✓               |
|                               | • Button                    | ✓                 | ✓               |
|                               | • Status button             | ✓                 | ✓               |
|                               | • Switch                    | ✓                 | ✓               |
|                               | • Invisible switch          | ✓                 | ✓               |
|                               | • Curve display             | ✓                 | ✓               |
| • Bar graph                   | ✓                           | ✓                 |                 |
| • Message display             | ✓                           | ✓                 |                 |
| • Simple message display      | ✓                           | ✓                 |                 |
| • Password list               | ✓                           | ✓                 |                 |
| • Recipe display              | ✓                           | ✓                 |                 |
| Operator prompting            |                             |                   |                 |
| • Dynamic attributes          | ✓                           | ✓                 |                 |
| • Show/hide objects           | ✓                           | ✓                 |                 |
| • Help text                   | ✓                           | ✓                 |                 |
| • TAB sequence                | -                           | ✓                 |                 |
| • Pictograms for softkeys     | -                           | ✓                 |                 |
| • LEDs in function keys       | -                           | ✓                 |                 |
| Permanent window              | ✓                           | ✓                 |                 |
| <b>Limit-value monitoring</b> | Inputs/outputs              | ✓                 | ✓               |
| <b>Conversion functions</b>   | Inputs/outputs              | ✓                 | ✓               |
| <b>Variables</b>              | Number                      | 250               |                 |

Table A-2 Functional Scope of TP/OP, continued

| Function                         |   | C7-635 Touch (TP) | C7-635 Key (OP) |
|----------------------------------|---|-------------------|-----------------|
| <b>Help text</b>                 | Lines/characters                          | 7/35              |                 |
|                                  | For messages                              | ✓                 | ✓               |
|                                  | For screens                               | ✓                 | ✓               |
|                                  | For screen objects                        |                   |                 |
|                                  | • Input field                             | ✓                 | ✓               |
|                                  | • Select field                            | ✓                 | ✓               |
|                                  | • Button                                  | -                 | ✓               |
|                                  | • Status button                           | -                 | ✓               |
| • Switch                         | -   | ✓                 |                 |
| • Invisible button               | -   | ✓                 |                 |
| <b>Curves</b>                    | Number                                    | 50                |                 |
| <b>Graphic objects</b>           | Number                                    | 50                |                 |
| <b>Text elements</b>             | Number                                    | 1000              |                 |
| <b>Print functions</b>           | Screen capture                            | ✓                 | ✓               |
|                                  | Direct message listing                    | ✓                 | ✓               |
| <b>Password protection</b>       | Number of passwords                       | 50                |                 |
|                                  | Password level                            | 10 (0 to 9)       |                 |
| <b>Recipes</b>                   | Number                                    | 20                |                 |
|                                  | Data records per recipe                   | 50 <sup>2)</sup>  |                 |
|                                  | Entries per recipe                        | 60                |                 |
| <b>Online language selection</b> | Number of languages                       | 3                 |                 |
| <b>Screen settings</b>           | Contrast                                  | ✓                 | ✓               |
| <b>Timer</b>                     | Triggers functions cyclically or one time | ✓                 | ✓               |

1) Total number for operational and fault messages

2) Limited by memory medium

### A.3 Technical Specifications for CPU

| Memory         |                                     |
|----------------|-------------------------------------|
| User memory    |                                     |
| • Integrated   | 64 KB                               |
| • Expandable   | No                                  |
| Loading memory | Plug-in (MMC)                       |
| Backup         | Ensured with MMC (maintenance-free) |

| Processing Times         |                     |
|--------------------------|---------------------|
| • Bit operation          | Minimum 0.1 $\mu$ s |
| • Word instructions      | Minimum 0.2 $\mu$ s |
| • Fixed-point arithmetic | Minimum 2 $\mu$ s   |
| • Floating-point maths   | Minimum 6 $\mu$ s   |

| Timers/Counters and their Retentivity |   |
|---------------------------------------|---|
| S7 counters                           | 256                                     |
| • Retentivity                         | Adjustable                              |
| • Default                             | From C 0 to C 7                         |
| • Counting range                      | 0 to 999                                |
| IEC Counters                          | Yes                                     |
| • Type                                | SFB                                     |
| • Number                              | Unlimited (limited only by user memory) |
| S7 timers                             | 256                                     |
| • Retentivity                         | Adjustable                              |
| • Default                             | No retentivity                          |
| • Timing range                        | 10 ms to 9,990 s                        |
| IEC timers                            | Yes                                     |
| • Type                                | SFB                                     |
| • Number                              | Unlimited (limited only by user memory) |

| <b>Data Areas and their Retentive Characteristics</b>               |                   |
|---|-------------------|
| Total retentive data area (including memory bits; timers; counters) | All               |
| Bit memories  | 256 bytes         |
| • Retentivity   | Adjustable        |
| • Retentivity preset  | MB 0 to MB 15     |
| Clock memories  | 8 (1 memory byte) |
| Data blocks   | Maximum 511       |
| • Size  | Maximum 16 Kbytes |
| Local data per priority class                                       | Maximum 510 bytes |

| <b>Blocks</b>                                  |  |
|--|--|
| Total  | 1024 (DBs, FCs, FBs, OBs, SDBs)<br>The maximum number of blocks that can be loaded is depending on the MMC used. |
| OBs  | See instruction list   |
| Size   | Maximum 16 Kbytes  |
| Nesting depth                                  |  |
| • Per priority class                           | 8  |
| • Additional nesting depths within an error OB | 4  |
| FBs  | Maximum 512 (FB 0 to FB 511)   |
| • Size   | Maximum 16 Kbytes  |
| FCs  | Maximum 512 (FC 0 to FC 511)   |
| • Size   | Maximum 16 Kbytes  |

| <b>Address Areas (I/O)</b>           |  |
|--------------------------------------|--|
| I/O address area overall             | Maximum 1024 bytes/1024 bytes (can be addressed by user) |
| • Distributed                        | Maximum 1,000 bytes                                      |
| I/O process image                    | 128 bytes/128 bytes                                      |
| Digital channels                     | Maximum 8,192  |
| • Of total, number of local channels | Maximum 992  |
| • Integrated channels                | 24 DI / 16 DO  |
| Analog channels                      | Maximum 512  |
| • Of total, number of local channels | Maximum 248  |
| • Integrated channels                | 4 + 1 AI/2 AO  |

| <b>Configuration</b>   |            |
|--|------------|
| Rack   | Maximum 4  |
| Modules in rack 0  | Maximum 4  |
| Modules in racks 1 and 2   | Maximum 8  |
| Modules in rack 3  | Maximum 7  |
| Number of DP masters   |            |
| • Integrated   | 1          |
| • By means of CP   | Maximum 1  |
| Function modules and communication processors that can be operated |            |
| • FM   | Maximum 8  |
| • CP (PtP)   | Maximum 8  |
| • CP (LAN)   | Maximum 10 |

| <b>Time</b>             |  |
|-------------------------|--|
| Realtime clock          | Yes (HW clock)   |
| • Buffered              | Yes  |
| • Backup period         | 6 weeks, typically (at an ambient temperature of 40°C) |
| • Accuracy              | Deviation per day < 10 s                               |
| Operating hours counter | 1  |
| • Number                | 0  |
| • Value range           | 0 to 2 <sup>31</sup> hours (when using SFC 101)        |
| • Selectivity           | 1 hour   |
| • Retentive             | Yes; requires restarting at every restart              |
| Clock synchronization   | Yes  |
| • In PLC                | Master   |
| • On MPI                | Master/slave   |

| <b>S7 Message Functions</b>  |  |
|--|--|
| Number of stations that can log in for message functions (for example, OS) | Maximum 12<br>(depends on the number of connections configured for PG/OP and S7 basic communication) |
| Process diagnostic messages  | Yes  |
| • Simultaneously active alarm S-blocks                                     | Maximum 40   |

| <b>Testing and Commissioning Functions</b> |   |
|--|---|
| Status/control variable                    | Yes   |
| • Variable                                 | Inputs, outputs, flags, DBs, timers, counters |
| • Number of variables                      | Maximum 30                                    |
| Of total, number of status variables       | Maximum 30                                    |
| Of total, number of control variables      | Maximum 14                                    |
| Force                                      | Yes   |
| • Variables                                | Inputs, outputs                               |
| • Number of variables                      | Maximum 10                                    |
| Status block                               | Yes   |
| Single sequence                            | Yes   |
| Breakpoint                                 | 2   |
| Diagnostic buffer                          | Yes   |
| • Number of entries (cannot be set)        | Maximum 100                                   |

| <b>Communication Functions</b>       |   |
|--------------------------------------|---|
| Programming device/OP communication  | Yes   |
| Global data communication            | Yes   |
| • Number of global data packets      | Maximum 4   |
| Sending station                      | Maximum 4   |
| Receiving station                    | Maximum 4   |
| • Size of global data packets        | Maximum 22 bytes  |
| Of total, number of consistent bytes | 22 bytes  |
| S7 standard communication            | Yes   |
| • Useful data per job                | Maximum 76 bytes  |
| Of total, number of consistent bytes | 76 bytes (with X_SEND or X_RCV)<br>64 bytes (with X_PUT or X_GET as server) |
| S7 communication                     |   |
| • As Server                          | Yes   |
| • As Client                          | Yes (with CP and loadable FB)   |
| • Useful data per job                | Maximum 180 bytes (with PUT/GET)  |
| Of total, number of consistent bytes | 64 bytes  |
| S5-compatible communication          | Yes (via CP and loadable FCs)   |
| Number of connections                | Maximum 12  |
| Usable for                           |   |
| • Programming device communication   | Maximum 11  |
| Reserved (default)                   | 1   |
| Adjustable                           | From 1 to 11  |
| • OP communication                   | Maximum 11  |
| Reserved (default)                   | 1   |



| <b>Communication Functions</b> |              |
|--------------------------------|--------------|
| Adjustable                     | From 1 to 11 |
| • S7 basic communication       | Maximum 8    |
| Reserved (default)             | 8            |
| Adjustable                     | From 0 to 8  |
| Routing                        | Maximum 4    |

| <b>MPI</b>                                  |                               |
|---|-------------------------------|
| Type of interface                           | Integrated RS 485 interface   |
| Physics                                     | RS 485                        |
| Galvanically isolated                       | No                            |
| Interface current supply (15 VDC to 30 VDC) | Maximum 200 mA                |
| Number of connections                       | 12                            |
| <b>Services</b>                             |                               |
| • Programming device/OP communication       | Yes                           |
| • Routing                                   | Yes                           |
| • Global data communication                 | Yes                           |
| • S7 standard communication                 | Yes                           |
| • S7 communication                          |                               |
| As server                                   | Yes                           |
| As client                                   | Yes (with CP and loadable FB) |
| • Transmission rates                        | Maximum 187.5 kbaud           |

| <b>PROFIBUS-DP</b>                          |                             |
|---|-----------------------------|
| Type of interface                           | Integrated RS 485 interface |
| Physics                                     | RS 485                      |
| Galvanically isolated                       | Yes                         |
| Interface current supply (15 VDC to 30 VDC) | Maximum 200 mA              |
| Number of connections                       | 12                          |
| <b>DP master</b>                            |                             |
| Number of connections                       | 12                          |
| <b>Services</b>                             |                             |
| • Programming device/OP communication       | Yes                         |
| • Routing                                   | Yes                         |
| • Global data communication                 | No                          |
| • S7 standard communication                 | No                          |
| • S7 communication                          | No                          |
| • Equidistance                              | Yes                         |
| • SYNC/FREEZE                               | Yes                         |
| • Activate/deactivate DP slaves             | Yes                         |
| • Transmission rates                        | Up to 12 Mbaud              |

| <b>PROFIBUS-DP</b>                |                                   |
|-----------------------------------|-----------------------------------|
| • Number of DP slaves per station | Maximum 32;                       |
| • Address area                    | Maximum 1 Kbyte I / 1 Kbyte O     |
| • Useful data per DP slave        | Maximum 244 bytes I / 244 bytes O |

| <b>DP slave</b>                       |  |
|---------------------------------------|--|
| Number of connections                 | 12   |
| Services                              |  |
| • Programming device/OP communication | Yes  |
| • Routing                             | Yes (only with active interface)           |
| • Global data communication           | No   |
| • S7 standard communication           | No   |
| • S7 communication                    | No   |
| • Direct data exchange                | Yes  |
| • Transmission rates                  | Up to 12 Mbaud                             |
| • Transfer memory                     | 244 bytes I / 244 bytes O                  |
| • Automatic baud rate search          | Yes (only if interface is passive)         |
| • Address areas                       | Maximum 32 with a maximum of 32 bytes each |
| • DPV 1                               | No   |

| <b>Programming</b>            |                      |
|-------------------------------|----------------------|
| Programming language          | LAD/FBD/STL          |
| Stored instructions           | See instruction list |
| Nesting levels                | 8                    |
| System functions (SFCs)       | See instruction list |
| System function blocks (SFBs) | See instruction list |
| User program security         | Yes                  |

| <b>Integrated I/O</b>   |                |
|---|----------------|
| <ul style="list-style-type: none"> <li>• Default addresses of the integrated</li> </ul> |                |
| Digital inputs  | 124.0 to 126.7 |
| Digital outputs   | 124.0 to 125.7 |
| Analog inputs   | 752 to 761     |
| Analog outputs  | 752 to 755     |

| <b>Integrated Functions</b> (see the <i>CPU 31xC Technological Functions</i> manual) |  |
|--|--|
| Counters,<br>Frequency meters,<br>Pulse outputs (pulse width modulation)             | 4 channels in total,<br>Frequency meter up to 60 kHz, maximum,<br>Pulse outputs up to 2.5 kHz, maximum |
| Controlled positioning   | 1 channel  |
| Integrated SFB "controlling"   | PID controller   |

## A.4 Technical Specifications for Integrated I/O

### Digital inputs

| Number                                      |    |
|---|----|
| Number of inputs                            | 24 |
| • inputs usable for technological functions | 16 |

| Cable Length (for Standard DI /Technological Functions) |                               |
|---|-------------------------------|
| • Unshielded  | Maximum 600 m / No            |
| • Shielded  | Maximum 1000 m / Maximum 50 m |

| Voltage, Currents, Potentials                         |               |
|---|---------------|
| Rated load current L+                                 | 24V DC        |
| • Polarity reversal protection                        | Yes           |
| Number of inputs that can be triggered simultaneously |               |
| • Vertical mounting position                          |               |
| Up to 40°C  | 18            |
| Up to 50°C  | 12            |
| • 45° mounting position                               |               |
| Up to 45°C  | 12            |
| • Horizontal mounting position                        |               |
| Up to 40°C  | 12            |
| Galvanic isolation                                    |               |
| • Between channels and I/O bus                        | Yes           |
| • Between channels                                    | No            |
| Permissible potential difference                      |               |
| • Between different circuits                          | 75 VDC/60 VAC |
| Insulation tested at                                  | 500 VDC       |
| Current consumption                                   |               |
| • From power voltage L+ (no-load)                     | Maximum 70 mA |

| Status, Interrupts, Diagnostics |   |
|---------------------------------|---|
| Interrupts                      | <ul style="list-style-type: none"> <li>• Yes, if the corresponding channel is configured as an interrupt input</li> <li>• When using the technological functions, see <i>CPU 31xC Technological Functions</i> manual</li> </ul> |
| Diagnostic functions            | <ul style="list-style-type: none"> <li>• No diagnostics when operated as standard I/O</li> <li>• When using the technological functions, see <i>CPU 31xC Technological Functions</i> manual</li> </ul>                          |

| Data for Selecting an Encoder for Standard DI                             |  |
|---|--|
| Input voltage   |  |
| • Rated value   | 24 VDC   |
| • for signal "1"  | 15 V to 30 V   |
| • for signal "0"  | -3 V to 5 V  |
| Input current   |  |
| • for signal "1"  | 7 mA, typically  |
| Delay of the standard inputs  |  |
| • Configurable  | Yes (0.1 / 0.5 / 3 / 15 ms)<br>You may change the delay time of standard inputs while the program is being executed. Please note that your new filter time may not be effective until the next filter cycle. |
| • Rated value   | 3 ms   |
| Input delay when using technological functions                            | 8 $\mu$ s  |
| • Minimum pulse width / minimum pulse interval at maximum count frequency |  |
| Input characteristic  | According to IEC 1131, Type 1  |
| Connection of 2-wire BEROs  | Possible   |
| • Permissible quiescent current   | Maximum 1.5 mA   |

## Digital outputs

### Note

Technological functions utilize **fast digital outputs**. These outputs must only be connected to resistive loads.

---

| Number   |    |
|--|----|
| Number of outputs  | 16 |
| <ul style="list-style-type: none"> <li>Of total, number of fast outputs</li> </ul> | 4  |

| Cable length   |                           |
|--|---------------------------|
| <ul style="list-style-type: none"> <li>Unshielded</li> </ul> | Maximum 600 m             |
| <ul style="list-style-type: none"> <li>Shielded</li> </ul>   | Maximum 1,000 m (109 yd.) |

| Voltage, Currents, Potentials  |                         |
|--|-------------------------|
| Rated load current L+  | 24 VDC                  |
| <ul style="list-style-type: none"> <li>Polarity reversal protection</li> </ul> | Yes                     |
| Total current of outputs (per group)   |                         |
| <ul style="list-style-type: none"> <li>Vertical mounting position</li> </ul>   |                         |
| Up to 40°C   | Maximum 3.0 A           |
| Up to 50°C   | Maximum 2.0 A           |
| <ul style="list-style-type: none"> <li>45°C mounting position</li> </ul>       |                         |
| Up to 45°C   | Maximum 2.0 A           |
| <ul style="list-style-type: none"> <li>Horizontal mounting position</li> </ul> |                         |
| Up to 40°C   | Maximum 2.0 A           |
| Galvanic isolation   |                         |
| <ul style="list-style-type: none"> <li>Between channels and I/O bus</li> </ul> | Yes                     |
| <ul style="list-style-type: none"> <li>Between channels</li> </ul>             | Yes                     |
| In groups of   | 8                       |
| Permissible potential difference   |                         |
| <ul style="list-style-type: none"> <li>Between different circuits</li> </ul>   | 75 VDC/60 VAC           |
| Insulation tested at   | 500V DC                 |
| Current consumption  |                         |
| <ul style="list-style-type: none"> <li>From load voltage L+</li> </ul>         | Maximum 20 mA per group |

| Status, Interrupts, Diagnostics |  |
|---------------------------------|--|
| Interrupts                      | <ul style="list-style-type: none"> <li>No interrupts when operated as standard I/O</li> <li>When using the technological functions, see <i>CPU 31xC Technological Functions</i> manual</li> </ul>  |
| Diagnostic functions            | <ul style="list-style-type: none"> <li>No diagnostics when operated as standard I/O</li> <li>When using the technological functions, see <i>CPU 31xC Technological Functions</i> manual</li> </ul> |

| Data for Selecting an Actuator for Standard DO  |                        |
|---|------------------------|
| Output voltage  |                        |
| <ul style="list-style-type: none"> <li>for signal "1"</li> </ul>                                  | Minimum L+ (-0.8 V)    |
| Output current  |                        |
| <ul style="list-style-type: none"> <li>for signal "1"</li> </ul>                                  |                        |
| Rated value   | 0.5 A                  |
| Permissible range   | 5 mA to 0.6 A          |
| <ul style="list-style-type: none"> <li>for signal "0" (residual current)</li> </ul>               | Maximum 0.5 mA         |
| Load impedance range  | 48 Ω to 4 kΩ           |
| Lamp load   | Maximum 5 W            |
| Parallel connection of 2 outputs  |                        |
| <ul style="list-style-type: none"> <li>For redundant load control</li> </ul>                      | Possible               |
| <ul style="list-style-type: none"> <li>For performance increase</li> </ul>                        | Not possible           |
| Triggering of a digital input   | Possible               |
| Switching frequency   |                        |
| <ul style="list-style-type: none"> <li>For resistive load</li> </ul>                              | Maximum 100 Hz         |
| <ul style="list-style-type: none"> <li>For inductive load according to IEC 947-5, DC13</li> </ul> | Maximum 0.5 Hz         |
| <ul style="list-style-type: none"> <li>For lamp load</li> </ul>                                   | Maximum 100 Hz         |
| <ul style="list-style-type: none"> <li>Fast outputs with resistive load</li> </ul>                | Maximum 2.5 kHz        |
| Inductive breaking voltage limited internally to  | (L+) – 48 V, typically |
| Short-circuit protected output  | Yes, electronic        |
| <ul style="list-style-type: none"> <li>Response threshold</li> </ul>                              | 1 A, typically         |

## Analog inputs

| Number  |            |
|---|------------|
| Number of inputs  |            |
| <ul style="list-style-type: none"> <li>• Current / voltage input</li> </ul> | 4 channels |
| <ul style="list-style-type: none"> <li>• Resistance input</li> </ul>        | 1 channel  |

| Cable length   |                         |
|--|-------------------------|
| <ul style="list-style-type: none"> <li>• Shielded</li> </ul> | Maximum 100 m (109 yd.) |

| Voltage, Currents, Potentials   |                             |
|---|-----------------------------|
| Resistance input  |                             |
| <ul style="list-style-type: none"> <li>• No-load voltage</li> </ul>   | 2.5 V, typically            |
| <ul style="list-style-type: none"> <li>• Measured current</li> </ul>  | 1.8 mA to 3.3 mA, typically |
| Galvanic isolation  |                             |
| <ul style="list-style-type: none"> <li>• Between channels and I/O bus</li> </ul>  | Yes                         |
| <ul style="list-style-type: none"> <li>• Between channels</li> </ul>  | No                          |
| Permissible potential difference  |                             |
| <ul style="list-style-type: none"> <li>• Between inputs and <math>M_{ANA}</math> (<math>V_{CM}</math>)</li> </ul>                     | 8.0 VDC                     |
| <ul style="list-style-type: none"> <li>• Between <math>M_{ANA}</math> and <math>M_{internal}</math> (<math>V_{ISO}</math>)</li> </ul> | 75 VDC/60 VAC               |
| Insulation tested at  | 500 VDC                     |

| Analog Value Generation  |   |
|--|---|
| Measuring principle  | Momentary value encoding (successive approximation) |
| Integration time/conversion time/resolution (per channel)  |   |
| <ul style="list-style-type: none"> <li>• Configurable</li> </ul>   | Yes   |
| <ul style="list-style-type: none"> <li>• Integration time in ms</li> </ul>                                 | 2.5 / 16.6 / 20                                     |
| <ul style="list-style-type: none"> <li>• Permissible input frequency</li> </ul>                            | Maximum 400 Hz                                      |
| <ul style="list-style-type: none"> <li>• Resolution (including overdrive)</li> </ul>                       | 11 bits + sign bit                                  |
| <ul style="list-style-type: none"> <li>• Suppression of interference frequency <math>f_1</math></li> </ul> | 400 / 60 / 50 Hz                                    |
| Time constant of the input filter  | 0.38 ms   |
| Basic execution time   | 1 ms  |



| <b>Interference Suppression, Error Limits</b>  |               |
|--|---------------|
| Interference voltage suppression for $f = n \times (f_1 \pm 1\%)$ ,<br>( $f_1 =$ interference frequency), $n = 1, 2$ |               |
| • Common mode interference<br>( $V_{CM} < 8.0\text{ V}$ )  | > 40 dB       |
| • Feedback interference (peak<br>value of the interference <<br>rated value of the input range)                      | > 30 dB       |
| Crosstalk between the inputs   | > 50 dB       |
| Operational error limits (throughout temperature range, relative to input range)                                     |               |
| • Voltage/current  | < 1 %         |
| • Resistance   | < 5%          |
| Basic error limits (operational limit at 25°C, relative to input range)  |               |
| • Voltage/current  | < 0.7%        |
| • Resistance   | < 3%          |
| Temperature error (related to input<br>range)  | +/- 0.006 %/K |
| Linearity error (related to input<br>range)  | +/- 0.06%     |
| Accuracy of reproducibility (in<br>steady state at 25 ° C, relative to<br>input range)                               | +/-0.06%      |

| <b>Status, Interrupts, Diagnostics</b> |   |
|--|---|
| Interrupts                             | <ul style="list-style-type: none"> <li>• No interrupts when operated as standard I/O</li> <li>• When using the technological functions,<br/>see <i>CPU 31xC Technological Functions</i> manual</li> </ul> |
| Diagnostic functions                   | <ul style="list-style-type: none"> <li>• No diagnostics when operated as standard I/O</li> <li>• When using the technological functions,<br/>see <i>CPU 31x Technological Functions</i> manual</li> </ul> |

| <b>Encoder Selection Data</b>                 |   |
|---|---|
| Input ranges (rated value)/input resistance   |   |
| • Voltage                                     | +/- 10 V/100 k $\Omega$<br>0 V to 10 V/100 k $\Omega$                           |
| • Current                                     | +/- 20 mA/50 $\Omega$<br>0 mA to 20 mA/50 $\Omega$<br>4 mA to 20 mA/50 $\Omega$ |
| • Resistance                                  | 0 $\Omega$ to 600 $\Omega$ /10 M $\Omega$                                       |
| • Resistive thermometer                       | Pt 100/10 M $\Omega$  |
| Permissible input voltage (destruction limit) |   |
| • For voltage input                           | Maximum 30 V continuous;  |
| • For current input                           | Maximum 2.5 V continuous, maximum 24 V transient                                |
| Permissible input current (destruction limit) |   |
| • for voltage input                           | Maximum 0.5 mA continuous;  |
| • For current input                           | Maximum 50 mA continuous;   |
| Connection of signal encoders                 |   |
| • For voltage measurement                     | Possible  |
| • For current measurement                     |   |
| As 2-wire measuring transducer                | Possible, with external power supply  |
| As 4-wire measuring transducer                | Possible  |
| • For measuring resistance                    |   |
| With 2-wire connection                        | Possible, without cable resistance compensation                                 |
| With 3-wire connection                        | Not possible  |
| With 4-wire connection                        | Not possible  |
| Linearization of characteristic curve         | By software   |
| • For resistive thermometer                   | Pt 100  |
| Temperature compensation                      | No  |
| Technical unit for temperature measurement    | Degrees Centigrade/Fahrenheit/Kelvin  |

## Analog outputs

| Number            |   |
|-------------------|---|
| Number of outputs | 2 |

| Cable length |               |
|--------------|---------------|
| • Shielded   | Maximum 200 m |

| Voltage, Currents, Potentials  |               |
|--|---------------|
| Rated load current L+  | 24 VDC        |
| • Polarity reversal protection   | Yes           |
| Galvanic isolation   |               |
| • Between channels and I/O bus   | Yes           |
| • Between channels   | No            |
| Permissible potential difference   |               |
| • between M <sub>ANA</sub> and M <sub>internal</sub> (V <sub>iso</sub> ) | 75 VDC/60 VAC |
| Insulation tested at   | 500 VDC       |

| Analog Value Generation            |                    |
|------------------------------------|--------------------|
| • Resolution (including overdrive) | 11 bits + sign bit |
| Conversion time (per channel)      | 1 ms               |
| Settling time                      |                    |
| • For resistive load               | 0.6 ms             |
| • For capacitive load              | 1.0 ms             |
| • For inductive load               | 0.5 ms             |

| Interference Suppression, Error Limits  |             |
|---|-------------|
| Crosstalk between the outputs   | > 60 dB     |
| Operational error limits (throughout temperature range, relative to output range) |             |
| • Voltage/current   | +/- 1%      |
| Basic error limits (operational limit at 25°C, relative to output range )         |             |
| • Voltage/current   | +/- 0.7%    |
| Temperature error (relative to output range)                                      | +/-0.01 %/K |
| Linearity error (relative to output range)  | +/-0.15%    |

| Status, Interrupts, Diagnostics |  |
|---------------------------------|--|
| Interrupts                      | <ul style="list-style-type: none"> <li>• No interrupts when operated as standard I/O</li> <li>• When using the technological functions, see <i>CPU 31xC Technological Functions</i> manual</li> </ul>  |
| Diagnostic functions            | <ul style="list-style-type: none"> <li>• No diagnostics when operated as standard I/O</li> <li>• When using the technological functions, see <i>CPU 31xC Technological Functions</i> manual</li> </ul> |

| Actuator Selection Data                                    |   |
|--|---|
| Output range (rated values)                                |   |
| • Voltage  | +/- 10 V<br>0 V to 10 V                         |
| • Current  | +/- 20 mA<br>0 mA to 20 mA<br>4 mA to 20 mA     |
| Load resistance<br>(in the rated range of the output)      |   |
| • Voltage outputs  |   |
| – ohmic load   | Minimum 1 kΩ                                    |
| – capacitive load  | Maximum 0.1 μF                                  |
| • Current outputs  |   |
| – ohmic load   | Maximum 300 Ω                                   |
| – inductive load   | Max. 0.1 mH                                     |
| Voltage output   |   |
| • Short-circuit protection                                 | Yes   |
| • Short-circuit current                                    | 55 mA, typically                                |
| Current output   |   |
| • No-load voltage  | 17 V, typically                                 |
| Destruction limit for externally applied voltages/currents |   |
| Output voltage to M <sub>ANA</sub>                         | Maximum 16 V continuous;                        |
| • Current  | Maximum 50 mA continuous;                       |
| Connection of actuators                                    |   |
| • For voltage output                                       |   |
| 2-wire connection  | Possible, without cable resistance compensation |
| 4-wire connection (measuring line)                         | Not possible                                    |
| • For current output                                       |   |
| 2-wire connection  | Possible  |

## A.5 Notes on Power Supply

### 24 VDC Supply

For the C7-635, the entire supply has to be generated with DC 24 V (operating voltage, load voltage, relay supply, etc.) as Safety Extra-Low Voltage (SELV).



#### Warning

Personal injury and property damage can occur.

If you do not configure the 24 VDC power supply of the C7-635 correctly, you can incur damage to the components of your automation system and personal injury.

For the 24 VDC power supply of the C7-635, use only safety extra-low voltage (SELV).

## A.6 Approvals

### Approvals for USA and Canada

#### Note

Which one of the approvals (UL/CSA or cULus) listed below is relevant for your product is indicated on the rating plate.

#### UL approval



Underwriters Laboratories Inc. to

- UL 508 (Industrial Control Equipment)

#### CSA approval



Canadian Standards Association to

- C22.2 No. 142 (Process Control Equipment)

or

Underwriters Laboratories Inc. to



- UL 508 (Industrial Control Equipment)
- CSA C22.2 No. 142 (Process Control Equipment)

or



Underwriters Laboratories Inc. to

- UL 508 (Industrial Control Equipment)
- CSA C22.2 No. 142 (Process Control Equipment)
- UL 1604 (Hazardous Location)
- CSA-213 (Hazardous Location)

APPROVED for use in  
Class I, Division 2, Group A, B, C, D Tx;  
Class I, Zone 2, Group IIC Tx

### FM Approval



FM standards 3611, 3600, and 3810 APPROVED for use in Class I, Division 2, Group A, B, C, D indoor hazardous locations.



### Warning

Personal injury and material damage may be incurred.

In hazardous areas, personal injury or property damage can result if you disconnect any plug-it connections while the system is in operation.

Always deenergize the C7-635 in hazardous areas before removing plug-it connectors.

---



### Warning

WARNING - DO NOT DISCONNECT WHILE CIRCUIT IS LIVE UNLESS LOCATION IS KNOWN TO BE NONHAZARDOUS

---

### Marine approval

Approvals by the following classification authorities are pending:

- ABS (American Bureau of Shipping)
- BV (Bureau Veritas)
- DNV (Det Norske Veritas)
- GL (Germanischer Lloyd)
- LRS (Lloyds Register of Shipping)
- Class NK (Nippon Kaiji Kyokai)

## A.7 Notes on CE Marking

### EC Guideline 89/336/EEC EMC Guidelines



This product complies with the requirements of the EC guideline 89/336/EEC “Electromagnetic Compatibility”.

The EC declarations of conformity and their associated documentation are available to the proper authorities in accordance with the above-mentioned EC Guideline, Article 10 (1) at the following address:

Siemens AG  
Automation and Drives Division  
A&D AS RD 42  
P.O. Box 1963  
D-92209 Amberg, Federal Republic of Germany

### Range of Application

The following range of application applies for the C7-635 control system, in accordance with this CE marking:

| Range of Application    | Requirements         |                          |
|-------------------------|----------------------|--------------------------|
|                         | Emitted Interference | Immunity to Interference |
| Industrial applications | EN 50081-2: 1993     | EN 61000-6-2: 1999       |

### Installation Guidelines

The installation guidelines and safety notes provided in the documentation are to be adhered to during commissioning and operation.

## A.8 Notes for Machine Manufacturers

### Introduction

The SIMATIC automation system is not a machine in the sense of the EC guideline "Machinery". Consequently, no declaration of conformity exists with regard to the EC guideline 89/392/EEC "Machinery".

### EC Guideline 89/392/EEC "Machinery"

EC guideline 89/392/EEC "Machinery" regulates the requirements of machinery. In this guideline, machinery is considered to include all associated parts or mechanisms (see also EN 292-1, Section 3.1).

SIMATIC is a part of the electrical equipment of machinery and must therefore be included by the machine manufacturer in the declaration of conformity process.

### Electrical Equipment of Machinery in Accordance with EN 60204

The standard EN 60204-1 (Safety of Machinery, General Requirements of the Electrical Equipment of Machinery) is applicable for the electrical equipment of machinery.

The following table is provided to help you with the declaration of conformity; it indicates which criteria are applicable for SIMATIC in accordance with EN 60204-1 (June 1993 edition).

| EN 60204-1   | Subject/Criterion               | Comments   |
|--------------|---------------------------------|--|
| Section 4    | General Requirements            | The requirements are satisfied if the devices are assembled/installed in accordance with the mounting guidelines. You must also take into account the explanations provided on previous pages. |
| Section 11.2 | Digital Input/Output Interfaces | The requirements are satisfied.  |
| Section 12.3 | Programmable Equipment          | The requirements are satisfied if devices for protection against changes to memory by unauthorized persons are installed in lockable cabinets.   |
| Section 20.4 | Dielectric Tests                | The requirements are satisfied.  |



# Index

## A

- Accessories, 2-9
- Additional devices and tools required to operate the C7-635, 2-8
- Additional S7-300 modules, 4-5
- Approval
  - CSA, A-23
  - Marine, A-24
  - UL, A-23
- Approvals, A-23
- Authorization inputs AT1/AT2, 4-3

## B

- Backup, 5-2
- Backup battery, replacing, 5-1
- BF, 4-5
- Bus connector, 3-21

## C

- C7, installing, 3-3
- C7 accessories, 2-9
- C7 minimum distance, 3-10
- C7 operation, requirements, 2-8
- C7-635 components, 2-8
- C7-CPU, selecting operating mode, 4-2
- Cabinet design, 3-23
- CE Marking, A-23, A-25
- Cleaning solution, 5-1
- Cleaning the monitor, 5-1
- Coding connectors, 3-25
- Coding profile, 3-25
- Components, 2-3, 2-8
- Connecting Cables, 3-21
- Connector pin assignment, 3-11
- Construction, fail-safe, 3-22
- Construction guidelines, 3-22
- CSA, approval, A-23

## D

- Degree of protection IP65, 3-3
- Deviations from CPU314C-2 DP, 4-1
- Deviations from TP 170 B, 4-1
- Dewing, 3-3

- DI/DO-status display
  - description, 4-9
  - explanation, 3-3
- Digital input, 3-16, 3-19
- Digital output, 3-17, 3-18

## E

- EC-guideline, Machinery, A-26

## F

- Fail-safe construction, 3-22
- FM-approval, A-24
- FRCE, 4-5
- Function keys, labeling, 3-1
- Functional ground, 3-23

## G

- General reset, MRES, 4-4
- Grounding, 3-22, 3-23
- Grounding terminal, 3-23, 3-24
  - installing, 3-24
- Group error, CPU, 4-5

## I

- I/O expansion directly on the device, 4-6, 4-7
- I/O status display, 4-9
- IM361-cable, 3-21
- Installation of fail-safe cables, 3-22
- Integrated I/O, 2-6
- Interfaces, 2-3
- Interference signals, 3-22
- IP65, 3-3

## K

- Key-LEDs, 4-2
- Keyboard, C7-635, 3-11, 3-12, 3-13, 3-15, 3-19

## L

- Labeling strips, 3-1

## **M**

Machinery, with SIMATIC, A-26  
Maintenance, 5-1  
Manufacturers of machines, A-26  
Marine, approval, A-24  
Mechanical installation, 3-3  
Minimum distance, C7, 3-10  
Mounting depth, A-1  
    2-module I/O set, A-1  
    4-module I/O set, A-1  
Mounting the C7, 3-3  
MPI-address, 2-5  
MRES, 4-4

## **N**

Notes on power supply, A-23

## **O**

Operating mode selection, 4-2  
Operating modes, 4-2  
Operation of C7, requirements, 2-8

## **P**

Plug-In S7-300 modules, 2-4  
PROFIBUS-Bus cable, 3-21  
PROFIBUS-Bus terminal, 3-21  
PROFIBUS-DP interface, 2-7  
Programming device (PG)-cable, 3-21  
Protective film, 5-1

## **R**

Replacing the C7-635, 5-2  
Restore, 5-3  
RUN, 4-3, 4-5

## **S**

S7-300 modules, 4-5  
SF, 4-5  
Shielded cables, 3-24  
Shielding, 3-22  
Shielding terminal, 3-24  
Spare parts, 2-10  
Special features of the C7-635, 4-1  
Status-LEDs, 4-3  
STOP, 4-3, 4-5

## **T**

Technical specifications for complete apparatus, A-1  
Technical specifications for CPU, A-7  
Technical specifications for integrated I/O, A-14  
Technical specifications TP, A-3  
Technological functions, 2-7

## **U**

UL, Approval, A-23  
User memory, 2-6

---

### Device Manual C7-613 Control System

### Device Manual C7-635 Control System

### Device Manual C7-636 Control System

---

This product information contains important information about the documentation mentioned above. It is to be regarded as a separate component. Its specifications and information have a higher binding nature than those of other manuals, instruction lists and Getting Starteds.

#### **New C7 devices with larger working memory**

The working memory of the following C7 devices was extended. The CPUs can now execute larger user programs.

Due to these improvements, the order number of the CPUs were changed.

The new C7 devices are:

- contained in STEP7 V5.4 Service Pack 1
- configurable with the older STEP7 versions:

The C7 devices with the new order number can be downloaded from the Internet as a hardware update (0109).

Requirement is STEP7 V5.2, Service Pack1.

- configurable with the corresponding previous C7 devices
- compatible with the previous C7 devices

#### **Non-retentive data blocks**

In opposition to the data in the S7-300, CPU 31xC and CPU 31x manual, Technical data", chapter 4.1.2, the C7 devices with firmware V2.0.12 are no longer supported by retentive data blocks. Non-retentive data blocks and code blocks can be loaded to the maximum limit of the working memory. Retentive data blocks can be loaded to the maximum retentive limit of the working memory (see the following table).

| Product description | Previous order nr. | Firmware < | Previous Working memory | Previous Working memory retentive ** | New order nr.      | Firmware ≙ | Working memory new | Working memory retentive ** new | Hard-ware update |
|---------------------|--------------------|------------|-------------------------|--------------------------------------|--------------------|------------|--------------------|---------------------------------|------------------|
| C7-613              | 6ES7613-1CA01-0AE3 | V2.0.12    | 48 KB                   | 48 KB                                | 6ES7613-1CA02-0AE3 | V2.0.12    | 80 KB              | 64 KB                           | 0109             |
| C7-635 Touch        | 6ES7635-2EB01-0AE3 | V2.0.12    | 64 KB                   | 64 KB                                | 6ES7635-2EB02-0AE3 | V2.0.12    | 96 KB              | 64 KB                           | 0109             |
| C7-635 Key          | 6ES7635-2EC01-0AE3 | V2.0.12    | 64 KB                   | 64 KB                                | 6ES7635-2EC02-0AE3 | V2.0.12    | 96 KB              | 64 KB                           | 0109             |
| C7-636 Touch*       | 6ES7636-2EB00-0AE3 | V2.0.12    | 128 KB                  | 128 KB                               | 6ES7636-2EB00-0AE3 | V2.0.12    | 128 KB             | 128 KB                          | -                |
| C7-636 Key*         | 6ES7636-2EC00-0AE3 | V2.0.12    | 128 KB                  | 128 KB                               | 6ES7636-2EC00-0AE3 | V2.0.12    | 128 KB             | 128 KB                          | -                |

\* not affected by the extension of the memory

\*\* Maximum size for retentive working memory for retentive data blocks