

SIEMENS

SIMATIC

Diagnostic Repeater for PROFIBUS-DP

Manual

Preface, Contents

Product Overview

Functions

Configuration Options

Installation

Wiring

Commissioning

Diagnostics

Technical Specifications

Appendices

Order Numbers

Dimension Drawings

User Questions

Glossary, Index

1

2

3

4

5

6

7

8

A

B

C



The following supplement is part of this documentation:

No.	Product Information	Drawing number	Edition
1	Use of subassemblies/modules in a Zone 2 Hazardous Area	A5E00352937-03	12/2006
2	DP cycle time measurement; Time synchronization; Support of the I&M function; Firmware update; Supplement to the manual	A5E00821386-01	07/2006

This manual has the order number:

6ES7972-0AB00-8BA0

Edition 12/2002

A5E00103899-02

Safety Guidelines

This manual contains notices intended to ensure personal safety, as well as to protect the products and connected equipment against damage. These notices are highlighted by the symbols shown below and graded according to severity by the following texts:



Danger

indicates that death, severe personal injury or substantial property damage will result if proper precautions are not taken.



Warning

indicates that death, severe personal injury or substantial property damage can result if proper precautions are not taken.



Caution

indicates that minor personal injury can result if proper precautions are not taken.

Caution

indicates that property damage can result if proper precautions are not taken.

Notice

draws your attention to particularly important information on the product, handling the product, or to a particular part of the documentation.

Qualified Personnel

Only **qualified personnel** should be allowed to install and work on this equipment. Qualified persons are defined as persons who are authorized to commission, to ground and to tag circuits, equipment, and systems in accordance with established safety practices and standards.

Correct Usage

Note the following:



Warning

This device and its components may only be used for the applications described in the catalog or the technical description, and only in connection with devices or components from other manufacturers which have been approved or recommended by Siemens.

This product can only function correctly and safely if it is transported, stored, set up, and installed correctly, and operated and maintained as recommended.

Trademarks

SIMATIC®, SIMATIC HMI® and SIMATIC NET® are registered trademarks of SIEMENS AG.

Third parties using for their own purposes any other names in this document which refer to trademarks might infringe upon the rights of the trademark owners.

Copyright © Siemens AG 2001-2002 All rights reserved

The reproduction, transmission or use of this document or its contents is not permitted without express written authority. Offenders will be liable for damages. All rights, including rights created by patent grant or registration of a utility model or design, are reserved.

Disclaimer of Liability

We have checked the contents of this manual for agreement with the hardware and software described. Since deviations cannot be precluded entirely, we cannot guarantee full agreement. However, the data in this manual are reviewed regularly and any necessary corrections included in subsequent editions. Suggestions for improvement are welcomed.

Preface

Purpose of the manual

This manual provides an overview of the diagnostic repeater for PROFIBUS-DP. It supports you in the configuration, installation and commissioning.

It is intended for persons working in the fields of configuring, commissioning and servicing automation systems.

Required knowledge

A general knowledge of automation technology is required in order to understand the manual.

Validity of the manual

The manual is valid for the diagnostic repeater for PROFIBUS-DP with the order number 6ES7 972-0AB01-0XA0.

Changes since the previous version

The following chapters have been revised and added to since the previous edition of the manual "Diagnostic Repeater for PROFIBUS-DP":

- Chapter 2, "Functions"
- Chapter 3, "Configuration Options"
- Chapter 7, "Diagnostics"
- Chapter 8, "Technical Specifications"

Note: You can identify the previous version of this manual by its number in the footer on each page: A5E00103899-01.

The number now is: A5E00103899-02.

Approvals

See Chapter 8.1, Standards and Approvals.

CE marking

See Chapter 8.1, Standards and Approvals.

Marking for Australia (C-Tick Mark)

See Chapter 8.1, Standards and Approvals.

Standards

See Chapter 8.1, Standards and Approvals.

Guide

In order to facilitate rapid access to special information the manual has the following access aids:

- The manual begins with a table of contents.
- The chapters contain intermediate headlines which provide an overview of the contents of the section.
- At the end of the appendix there is a glossary which defines the technical terms used in the manual.
- At the end of the manual there is a detailed index which allows you rapid access to the desired information.
- You can get direct access to information on the diagnostic repeater on the Internet at <http://www.siemens.com/Diagnostic-Repeater>

Recycling and disposal

The diagnostic repeater is low in contaminants and can thus be recycled. To recycle and dispose of your old equipment in an environmentally friendly manner, contact a company that is certified to dispose of electronic waste.

Further support

Please contact your local Siemens representative if you have any queries about the products described in this manual.

<http://www.siemens.com/automation/partner>

Training center

We offer corresponding courses to help familiarize you with the SIMATIC S7 PLC. Please contact your regional training center or the central training center in D 90327 Nuremberg.

Phone: +49 (911) 895-3200.

Internet: <http://www.sitrain.com>

A&D Technical Support

Worldwide, available 24 hours a day:



<p>Worldwide (Nuernberg) Technical Support</p> <p>24 hours a day, 365 days a year Phone: +49 (0) 180 5050-222 Fax: +49 (0) 180 5050-223 E-Mail: adsupport@siemens.com GMT: +1:00</p>		
<p>Europe / Africa (Nuernberg) Authorization</p> <p>Local time: Mon.-Fri. 8:00 AM to 5:00 PM Phone: +49 (0) 180 5050-222 Fax: +49 (0) 180 5050-223 E-Mail: adsupport@siemens.com GMT: +1:00</p>	<p>United States (Johnson City) Technical Support and Authorization</p> <p>Local time: Mon.-Fri. 8:00 AM to 5:00 PM Phone: +1 (0) 423 262 2522 Fax: +1 (0) 423 262 2289 E-Mail: simatic.hotline@sea.siemens.com GMT: -5:00</p>	<p>Asia / Australia (Beijing) Technical Support and Authorization</p> <p>Local time: Mon.-Fri. 8:00 AM to 5:00 Phone: +86 10 64 75 75 75 Fax: +86 10 64 74 74 74 E-Mail: adsupport.asia@siemens.com GMT: +8:00</p>
<p>The languages of the SIMATIC Hotlines and the authorization hotline are generally German and English.</p>		

Service & Support on the Internet

In addition to our documentation, we offer our Know-how online on the internet at:

<http://www.siemens.com/automation/service&support>

where you will find the following:

- The newsletter, which constantly provides you with up-to-date information on your products.
- The right documents via our Search function in Service & Support.
- A forum, where users and experts from all over the world exchange their experiences.
- Your local representative for Automation & Drives via our representatives database.
- Information on field service, repairs, spare parts and more under "Services".

Contents

1	Product Overview	1-1
1.1	What are distributed I/O devices?	1-1
1.2	What is a diagnostic repeater?	1-3
1.2.1	Functions and range of applications	1-3
1.2.2	View of the diagnostic repeater	1-5
1.2.3	How the diagnostic repeater works	1-7
1.3	Enhancements and compatibility with the predecessor module	1-10
2	Functions	2-1
2.1	Repeater function	2-1
2.2	Topology data: bus topology and topology table	2-2
2.3	Diagnostic buffer	2-2
2.4	Statistics buffer	2-3
2.5	Time	2-3
2.5.1	Setting the time	2-3
2.5.2	Time record format	2-4
2.6	Identification data	2-5
2.7	Monitoring functions for the clocked PROFIBUS bus system	2-6
3	Configuration Options	3-1
3.1	Design guidelines for diagnostic repeaters	3-1
3.1.1	PROFIBUS networks	3-1
3.1.2	PROFIBUS components	3-2
3.1.3	Bus connectors and cables	3-3
3.1.4	Line length and cascading depth	3-5
3.1.5	Spur lines	3-6
3.1.6	Only one measuring circuit at a segment	3-7
3.1.7	Arrangement of the DP master	3-8
3.1.8	Example configuration	3-10
3.2	Limitations when using components with repeater function	3-12
3.2.1	Network design with an RS 485 repeater	3-15
3.2.2	Network design with an Optical Link Module (OLM)	3-17
3.3	Recommendations for structuring a new plant	3-19
3.4	Use in an existing plant	3-20
4	Installation	4-1
4.1	Mounting rules	4-1
4.2	Mounting the diagnostic repeater on a mounting rail for S7-300	4-2
4.3	Mounting the diagnostic repeater on a DIN rail	4-3
5	Wiring	5-1
5.1	Basis	5-1
5.2	Connecting the supply voltage	5-2
5.3	Connecting the PROFIBUS cables	5-3
5.4	Block diagram of the diagnostic repeater	5-5

6	Commissioning	6-1
6.1	Addressing	6-1
6.2	Configuration	6-3
6.2.1	Configuration for standard operation.....	6-4
6.2.2	Configuring the monitoring functions for the clocked PROFIBUS bus system.....	6-5
6.3	Parameter assignment with STEP 7	6-6
6.3.1	Parameterizing the diagnostic message frame length.....	6-6
6.3.2	Parameter assignment when using components with a repeater function	6-7
6.3.3	Parameter assignment of the monitoring functions for the clocked PROFIBUS bus system.....	6-7
6.3.4	Parameter assignment of DP interrupt mode in STEP 7	6-7
6.4	Commissioning: Determining the topology	6-8
7	Diagnostics	7-1
7.1	Overview	7-1
7.1.1	Diagnosis through LED display.....	7-2
7.1.2	Diagnosis with STEP 7 and COM PROFIBUS.....	7-4
7.2	Structure of the diagnosis	7-5
7.2.1	Structure of the slave diagnosis	7-5
7.2.2	Node status 1 to 3	7-6
7.2.3	Master PROFIBUS address	7-7
7.2.4	Manufacturer identifier	7-8
7.2.5	Structure of the module diagnosis.....	7-8
7.2.6	Structure of the device-specific diagnosis.....	7-9
7.2.7	Monitoring function of the clocked PROFIBUS bus system.....	7-13
7.3	Reading data out in the user program	7-14
7.3.1	Topology table.....	7-14
7.3.2	Diagnostic buffer	7-17
7.3.3	Statistics buffer.....	7-20
7.4	Topology display in STEP 7	7-24
7.4.1	Topology data: bus topology and topology table	7-24
7.4.2	Diagnostic buffer	7-26
7.4.3	Statistics buffer.....	7-28
7.4.4	Error messages.....	7-30
7.5	Diagnostic messages and fault elimination.....	7-31
7.5.1	Design guidelines not observed.....	7-31
7.5.2	Message frame error rate in the segment is critical.....	7-33
7.5.3	Break in the signal wire A or B.....	7-34
7.5.4	Short circuit in the signal wire A and B or short circuit in the signal wire A or B to screen.....	7-34
7.5.5	Terminator	7-35
7.5.6	Segment of diagnostic repeater de-activated automatically	7-35
7.5.7	Fault cause or fault location not clear	7-36
7.5.8	Fault cannot be evaluated.....	7-36
7.5.9	Topology determination not possible	7-37
8	Technical Specifications	8-1
8.1	Standards and approvals	8-1
8.1.1	Electromagnetic compatibility of the diagnostic repeater.....	8-4
8.1.2	Mechanical and climatic ambient conditions for transportation and storage	8-6
8.1.3	Mechanical and climatic ambient conditions in operation.....	8-6
8.1.4	Information on nominal voltages, dielectric tests, safety class and degree of protection.....	8-8
8.2	Technical data of the diagnostic repeater	8-9

8.3	Records used in the diagnostic repeater	8-11
8.4	Use of the Diagnostic Repeater in a Zone 2 Hazardous Area	8-12
8.4.1	Einsatz des Diagnose-Repeater im explosionsgefährdeten Bereich Zone 2	8-12
8.4.2	Use of the Diagnostic Repeater in a Zone 2 Hazardous Area	8-14
8.4.3	Utilisation du répéteur de diagnostic dans un environnement à risque d'explosion en zone 2	8-16
8.4.4	Aplicación del repetidor para diagnóstico en áreas con peligro de explosión, zona 2	8-18
8.4.5	Impiego del repeater di diagnostica nell'area a pericolo di esplosione zona 2	8-20
8.4.6	Gebruik van de diagnose-repeater in het explosieve gebied zone 2	8-22
8.4.7	Brug af diagnose-repeateren i det eksplosionsfarlige område zone 2	8-24
8.4.8	Diagnoosi-toistimen käyttö räjähdysvaarannetuilla alueilla, vyöhyke 2	8-26
8.4.9	Användning av diagnosrepeater i explosionsriskområde zon 2	8-28
8.4.10	Uso do Diagnose-Repeater em área exposta ao perigo de explosão, zona 2	8-30
8.4.11	Χρήση του επαναλήπτη διάγνωσης σε επικίνδυνη για έκρηξη περιοχή, ζώνη 2	8-32
A	Order Numbers	A-1
B	Dimension Drawings	B-1
C	User Questions	C-1
C.1	Topology and fault point determination	C-1
C.2	Diagnostic repeater / RS 485 repeater	C-3
C.3	Diagnostic repeater with different order numbers	C-4
C.4	Diagnostic messages	C-5
	Glossary	Glossary-1
	Index	Index-1

1 Product Overview

1.1 What are distributed I/O devices?

Distributed I/O devices - area of application

When designing a plant the inputs and outputs from and to the process are often included centrally in the automation system. If the distances between the inputs/outputs and the automation system are great, the wiring can become very extensive and muddled, electromagnetic disturbances can influence the reliability and functionality.

Distributed I/O devices are ideal for plants like this: The controller CPU is at a central point.

The I/O devices (inputs and outputs) operate locally on a distributed basis

With its high data transfer speed the powerful PROFIBUS-DP ensures that the control CPU and I/O devices communicate without problems.

What is PROFIBUS-DP?

PROFIBUS-DP is an open bus system on the basis of the IEC 61158:Ed3 Type 3 standard with the "DP" transmission protocol (DP is a German abbreviation standing for distributed I/O).

Physically the PROFIBUS-DP is either an electrical network on the basis of a shielded-two-wire cable (RS 485) or an optical network on the basis of an optical fiber cable.

The "DP" transmission protocol allows rapid cyclic and - if required - acyclic data exchange between the controller CPU and the distributed I/O devices

What are DP master and DP slave?

The DP master is the link between the control CPU and distributed I/O devices. The DP master exchanges the data with the distributed I/O devices via the PROFIBUS-DP and monitors the PROFIBUS-DP.

The distributed I/O devices (= DP-Slaves) condition the data of the sensors and actuating elements locally so that they can be transferred via PROFIBUS-DP to the control CPU.

Which devices can be connected to PROFIBUS-DP?

A wide variety of devices can be connected to the PROFIBUS-DP bus system as DP masters or DP slaves, provided they behave in accordance with the IEC 61158:Ed3 Type 3 standard. Devices of the following product families, among others, can be used:

- SIMATIC S5
- SIMATIC S7/C7
- SIMATIC PC/PG (programming devices)
- SIMATIC HMI (operator control and monitoring devices)
- Distributed I/O devices
- Devices of other manufacturers

Structure of a PROFIBUS-DP network

The following figure shows the possible structure of a PROFIBUS-DP network. The DP masters are integrated in the relevant device. For example, the S7-400 has a PROFIBUS-DP interface, and the IM 308-C master interface module is inserted in an S5-115U. The DP slaves are the distributed I/O devices which are connected via PROFIBUS-DP to the DP masters.

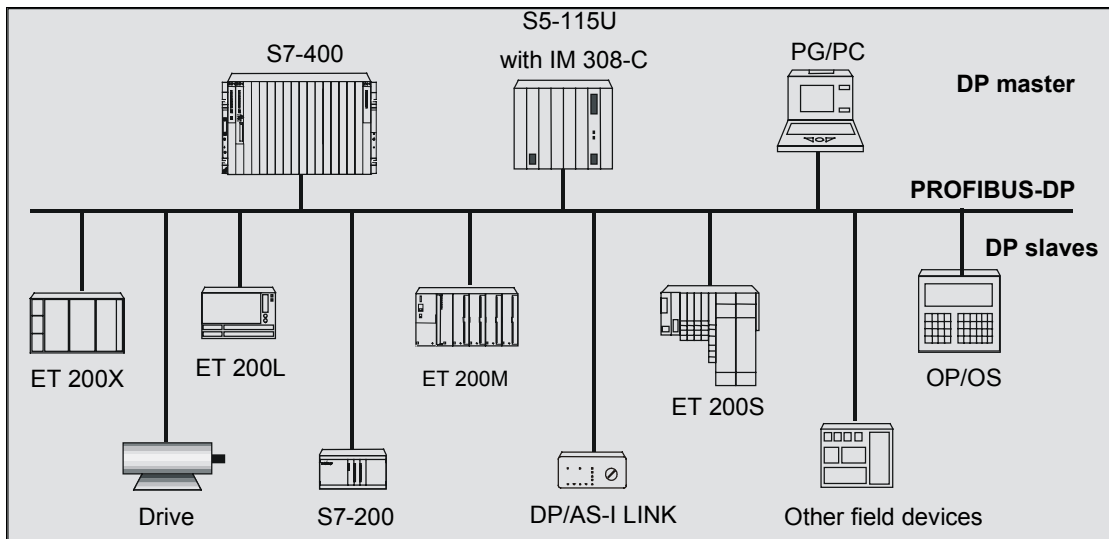

1.2 What is a diagnostic repeater?

1.2.1 Functions and range of applications

Definition

The diagnostic repeater is a repeater with the ability to monitor a segment of an RS 485 PROFIBUS subnet (copper wire) during running operation and to signal line faults via diagnostic message to the DP master. By means of STEP 7, COM PROFIBUS and operator interface systems (SIMATIC HMI) the location and cause of fault can be displayed in plain text.

Through its line diagnostics during operation the diagnostic repeater allows line faults to be rapidly detected, localized, and visualized. In this way, problems in plants can be detected in good time and system standstills minimized.

Functions of the diagnostic repeater

The diagnostic repeater fulfills the following tasks:

- Diagnostic function for two PROFIBUS segments (DP2 and DP3):
The diagnostic function supplies the fault location and the fault cause of line faults, such as a wire break or missing matching resistors.
The fault location is specified relative to the existing nodes, for example "Short-circuit in the signal line A against shield between Nodes 12 and 13".
- Repeater function for three PROFIBUS segments (DP1, DP2 and DP3):
The diagnostic repeater amplifies data signals on bus lines and links individual RS 485 segments.
- Programming device isolated galvanically or electrically from the other bus segments. When the programming-device line is withdrawn/plugged, no fault is caused at the other segments of the PROFIBUS-DP, even at high baud rates.
- The diagnostic repeater is a DP slave with an IP 20 degree of protection.

New functions of the diagnostic repeater

The diagnostic repeater with the order number 6ES7 972-0AB01-0XA0 offers the following new functions:

- It allows the stored topology table to be read out and the bus topology to be visualized via STEP 7.
- It allows stored diagnostic and statistical information to be read out.
- It maintains a clock that can be set and read by the user program.
- It offers monitoring functions for the clocked PROFIBUS bus system.
- It makes identification data available.

Range of application of the diagnostic repeater

A diagnostic repeater is required for:





















- Line diagnostics of the PROFIBUS network during running operation
- The connection of more than 32 nodes to the bus
- The implementation of branches
- The control-to-load isolation between two segments
- The ungrounded operation of bus segments
- The visualization of the bus topology via STEP 7 as of V5.2

1.2.2 View of the diagnostic repeater

Display and operating elements

View	No.	Function
	1	Status and error LEDs (See Section 7.1.1)
	2	Switch for setting the PROFIBUS address
	3	DR switch for activating the repeater function
	4	Turn switch for separating segment DP3
	5	Interface for PG with integrated terminating resistor
	6	Turn switch terminator for segment DP1
	7	Connection A1/B1 for the incoming bus cable of segment DP1
	8	Connection A1'/B1' for the outgoing bus cable of segment DP1
	9	Version of the firmware and order number
	10	Connection for the power supply
	11	Connection A2/B2 for the bus cable of segment DP2, with measuring circuit for line diagnostics
	12	Connection A3/B3 for the bus cable of segment DP3, with measuring circuit for line diagnostics
	13	Fixing screws for mounting to mounting rail S7-300

Switches and their functions

Switch	Setting	Description
SEGMENT DP3 OFF  ON 	ON	Segment DP3 is activated and can be diagnosed.
	OFF	Segment DP3 is de-activated. Select this switch setting if no bus line is connected to segment DP3 or if the bus line for this segment is to be disconnected.
TERMINATOR DP1 OFF  ON 	ON	The terminating resistor is connected at DP1. Segment DP1 is interrupted. The right-hand part of the connector is passivated. Select this switch position if no outgoing bus line is connected at A1'/B1' to segment DP1.
	OFF	The terminator is not connected at segment DP1. Select this switch position if no outgoing bus line is connected at A1'/B1' to segment DP1.
64  32  16  8  4  2  1  DR  ON	ON (switch on left depressed)	Switch contributes to the formation of the PROFIBUS address. The address results from the addition of the numbers which are assigned to the switches. The addresses 1 to 125 are permitted. In the example the address $64 + 16 + 8 + 2 = 90$ results.
	OFF (switch on right depressed)	Switch does not contribute to the formation of the PROFIBUS address.
64  32  16  8  4  2  1  DR  ON	ON (switch on left depressed, state on delivery)	The repeater function is activated. <ul style="list-style-type: none"> It is activated if the diagnostic repeater has found the baud rate. It is de-activated if the diagnostic repeater has lost the baud rate.
	OFF (switch on right depressed)	The repeater function is not activated (for commissioning and service purposes): <ul style="list-style-type: none"> The repeater function is not activated. The DR LED is off. Segments DP1, DP2 and DP3 of the diagnostic repeater are separated from each other. The diagnostic repeater can only be addressed via the programming-device interface. The diagnostic repeater carries out an active line check at segments DP2 and DP3.

Status and error LEDs

LED	Color	Description
SF	Red	Group error
BF	Red	Bus fault
DR	Green	Repeater function
ON	Green	Voltage
PG	Yellow	Bus activity at the programming-device interface
DP1	Yellow	Bus activity at segment DP1
DP2	Yellow	Bus activity at segment DP2
DP3	Yellow	Bus activity at segment DP3
ERR DP2	Red	Line fault at segment DP2
ERR DP3	Red	Line fault at segment DP3

1.2.3 How the diagnostic repeater works

Prerequisites

- Line diagnostics is possible for nodes that are connected to the PROFIBUS segments DP2 and DP3.
- In order to use a diagnostic repeater you require a programming device/PC and STEP 7 as of V5.1 Service Pack 2 or COM PROFIBUS V5.1 Service Pack 2.
- To start topology determination from the user program, an S7 CPU/CP is required that supports the integrated system function SFC 103 "DP_TOPOL" (e.g. integrated DP interfaces of S7-400 CPUs as of FW 3.1).

Line diagnostic

The line diagnostic is carried out in two steps:

- **Determining the topology**
The diagnostic repeater determines the PROFIBUS addresses and the distance of the nodes and draws up a topology table.
- **Determining the fault point**
The diagnostic repeater checks the lines during bus operation. It determines the distance of the fault point, determines the cause of the fault and emits a diagnostic message with relative specification of the fault location.

Determining the topology

The topology is determined by measuring the reflection. The diagnostic repeater (DR) enters the PROFIBUS addresses and the absolute distance of the nodes from itself in a topology table.

The topology table can be read out, printed and exported using STEP 7 or the user program (see Section 7.3.1).

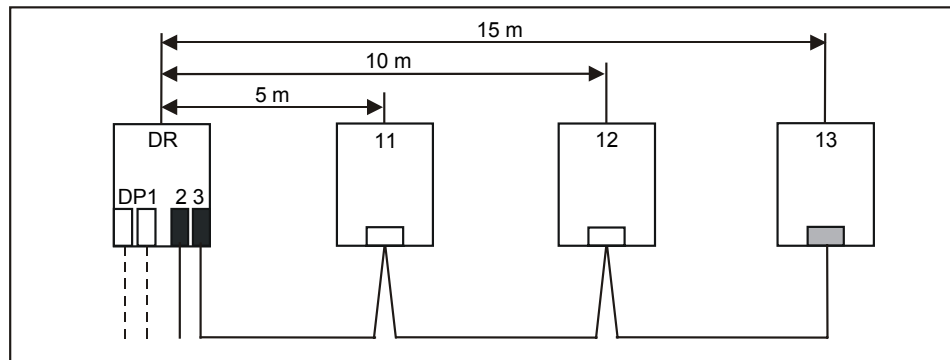

PROFIBUS address	Distance from the diagnostic repeater
11	5 m
12	10 m
13	15 m

Carrying out the determination of the topology

After setting up a plant and after making any changes to it, the user carries out topology determination on the selected DP master system:

- Using the programming device/PC with STEP 7:
PLC > PROFIBUS > Prepare Line Diagnostics
- Using the programming device/PC with COM PROFIBUS:
Service > Prepare Line Diagnostic
- Using SFC 103 "DP_TOPOL" in the user program of an S7 CPU

The topology table is kept retentively in the diagnostic repeater, even if the supply voltage fails, until topology determination is restarted.

Determining the fault location

While the operation is running, the diagnostic repeater analyses and evaluates the signals at segments DP2 and DP3 and determines the distance and the type of the fault points. The fault location is specified relative to the existing nodes on the basis of the topology table (for example, "Short-circuit in signal line A to shield between nodes 12 and 13").

The bus operation is not influenced by additional messages.

If bus operation does not take place, the diagnostic repeater carries out an active check of the line at specific intervals. Faults on segments DP2 and DP3 are detected by the diagnostic repeater and can be read out via the programming device interface.

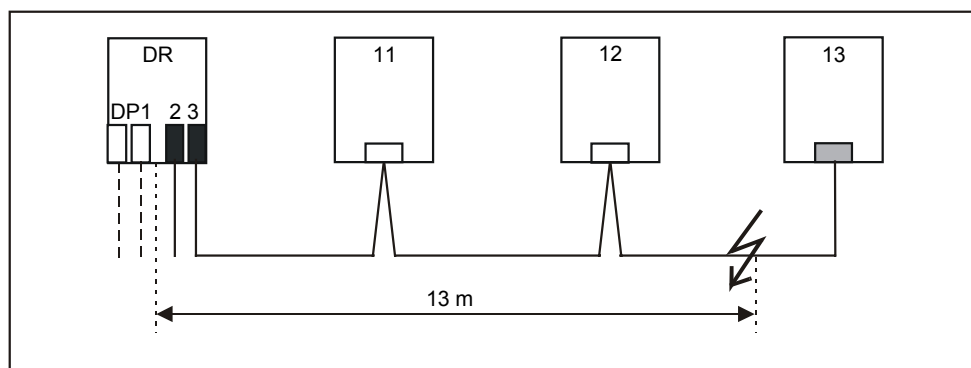

Distance specifications

All distance specifications have a tolerance of ± 1 m. The error can therefore also have occurred at neighboring nodes which lie within the tolerance to the specified node.

1.3 Enhancements and compatibility with the predecessor module

The diagnostic repeater with the order number 6ES7 972-0AB01-0XA0 can be used to replace the predecessor with the order number 6ES7 972-0AB00-0XA0.

Enhancements:

- Topology determination
- Graphical diagnostic display
- Text-based diagnostic display
- Display of topology, diagnostic buffer, statistics
- Identification data
- Monitoring function for the clocked PROFIBUS bus system

Updating the firmware of the diagnostic repeater

As of the order number 6ES7 972-0AB01-0XA0, the firmware can be upgraded via PROFIBUS and STEP 7 as of V5.2.

The appropriate files (*.UPD) are required in order to update the firmware.

Requirements

- The diagnostic repeater whose firmware is to be updated must be accessible online.
- The files with the current firmware version must be available in the file system of your programming device/PC.

Procedure

You will find information on the procedure in the online help system of STEP 7.

Note

When the firmware is activated, the topology table in the diagnostic repeater is deleted (automatically or after power off/on). Carry out topology determination after activation.

Note

If the firmware is activated automatically after loading, the diagnostic repeater carries out a restart. The repeater function is not available during this time. As a result, the diagnostic repeater and parts of the network are temporarily inaccessible.

2 Functions

2.1 Repeater function

Prerequisites

- The repeater function supports all three PROFIBUS segments of the diagnostic repeater: DP1, DP2, and DP3.
- The DR switch must be set to ON.

Fundamentals

The diagnostic repeater can connect individual segments via the repeater function. It allows the connection of 31 nodes each per segment, meaning that up to 62 nodes can be connected behind each diagnostic repeater. As a DP slave the diagnostic repeater also counts itself as a node.

The diagnostic repeater starts with the automatic search for the baud rate. The repeater function is activated as soon as a valid baud rate was found and the DR switch is positioned to ON. The DR LED then lights up green.

Behavior in the event of an error

If the diagnostic repeater does not receive any correct messages at one of the three segments DP1, DP2 and DP3 or at the programming-device interface (no signal level or signal level instable), the corresponding segment switches off. Faults can thus not have any effect on the other segments.

The SF, ERR DP2 or ERR DP3 LEDs light up red. The diagnostic signals that the respective segment is switched off.

The repeater function is reactivated as soon as the fault has been eliminated.

Deactivating the repeater function: DR switch to OFF

The repeater function can be deactivated for commissioning and service purposes:

- The repeater function is not activated. The DR LED is off.
- Segments DP1, DP2 and DP3 of the diagnostic repeater are separated from each other.
- The diagnostic repeater can only be addressed via the programming-device interface.
- The diagnostic repeater carries out an active line check on segments DP2 and DP3 if there are no active nodes in these segments.

2.2 Topology data: bus topology and topology table

The diagnostic repeater supplies data on the bus topology that consist of PROFIBUS addresses of the nodes and of relative distances of the nodes to the diagnostic repeater.

The data on the bus topology can be read out by STEP 7, displayed graphically or in tabular form, printed out, and exported as a CSV file.

It is also possible in the user program to read out the topology data from the diagnostic repeater as records and format them for visualization.

2.3 Diagnostic buffer

For each of segments DP1, DP2, and DP3 as well as the programming device interface, the diagnostic repeater contains a diagnostic buffer in which the last 10 results are saved together with their date and time.

The diagnostic buffers can be read out, displayed graphically, printed out, and exported as a CSV file by STEP 7.

It is also possible in the user program to read out the diagnostic data from the diagnostic repeater as records and format them for visualization.

The information in the diagnostic buffers of the diagnostic repeater, unlike that in the diagnostic buffer of the CPU, is non-retentive.

2.4 Statistics buffer

For segments DP2 and DP3 the diagnostic repeater contains two statistics buffers in which information on the reflection error rate and message frame error rate is saved together with the date and time. The statistics buffers allow conclusions to be drawn about the quality of the bus system.

Reflection errors occur, for example, when the signal is reflected by a disturbed or defective line.

Message frame errors are detected, for example, when message frames with parity errors occur. Parity errors can be caused by a defective node, for example.

The statistics buffers can be read out, displayed graphically, printed out, and exported as a CSV file by STEP 7.

It is also possible in the user program to read out the statistics buffers from the diagnostic repeater as records and format them for visualization.

2.5 Time

The diagnostic repeater with the order number 6ES7 972-0AB01-0XA0 maintains a clock in order to time-stamp diagnostic events, statistical data, and topology data.

The time format corresponds to the S7 format "DATE_AND_TIME".

The time after power on is DT#1994-01-01-00:00:00.000.

The maximum possible end time is DT#2089-12-31-23:59:59.999.

2.5.1 Setting the time

To set the time in the diagnostic repeaters, read out the time from the CPU in the user program with SFC 1 "READ_CLK", and write this time "cyclically" to the diagnostic repeaters on the selected DP master system using SFC 58 "WR_REC" or SFB 53 "WRREC".

The time can also be read out from the diagnostic repeater using SFC 59 "RD_REC" or SFB 52 "RDREC" via the "Time" record.

The time reference should be set at regular intervals in order to ensure accuracy.

2.5.2 Time record format

Record 60 "Time" can be read and written. It consists of the version number and the S7 data format DATE_AND_TIME:

Byte	"Time" record		Format
	Bits 4-7	Bits 0-3	
0	Constant 02		hex
1	Year	Year	BCD
2	Month	Month	BCD
3	Day	Day	BCD
4	Hour	Hour	BCD
5	Minute	Minute	BCD
6	Second	Second	BCD
7	Millisecond (high)	Millisecond	BCD
8	Millisecond (low)	Day of the week: 1 = Sunday 2 = Monday 3 = Tuesday 4 = Wednesday 5 = Thursday 6 = Friday 7 = Saturday	BCD

Note

Assign a time to all the diagnostic repeaters with the order number 6ES7 972-0AB01-0XA0 in the network.

Note

The diagnostic repeater does not have any power failure buffering. After power off/on, the clock starts again at DT#1994-01-01-00:00:00:000.

User program example

STL	Description
CALL "READ_CLK"	SFC1 Read out the time from the CPU
RET_VAL :=MW100	Error handling
CDT :=#datum_zeit	Time, variable in the format DATE_AND_TIME
CALL "WR_REC"	SFC58 Write record
REQ :=M1.0	Write time to the DR
IOID :=B#16#54	ID of the address range
LADDR :=W#16#3FE	Diagnostic address of the DR
RECNUM :=B#16#3C	Record number 60dec
RECORD :=#datum_zeit	Time
RET_VAL :=MW102	Error output
BUSY :=M104.0	Job is being processed

2.6 Identification data

The identification data contain information on the diagnostic repeater and can be read with STEP 7 and partially written. The identification data are saved retentively in the diagnostic repeater.

Identification data	Value range	Default
Device		
Manufacturer	Read	SIEMENS AG
Device designation	Read	Order number
Device serial number	Read	Dependent on version
Hardware revision	Read	
Software revision	Read	
Installation date	Read/write (max. 16 characters)	-
Static revision no.	Read	
Operating unit		
TAG	Read/write (max. 32 characters)	-
Description	Read/write (max. 54 characters)	-

Explanations

Identification data	Description
Manufacturer	The name of the manufacturer is stored here.
Device designation	This is the order number of the diagnostic repeater.
Device serial number	The serial number of the diagnostic repeater is stored here. This permits it to be identified uniquely.
Hardware revision	Provides information on the version of the diagnostic repeater. Is incremented when the version and/or firmware of the diagnostic repeater changes.
Software revision	Provides information on the firmware version of the diagnostic repeater. When the firmware version is incremented, the hardware version of the diagnostic repeater is also incremented.
Static revision no.	Provides information on the parameterized changes on the diagnostic repeater. The static revision number is incremented after every change.
Installation date	Contains the date on which the diagnostic repeater was installed. Enter the date here. Format: DD.MM.YYYY
TAG	LID (location) of the diagnostic repeater. Enter a unique ID for the diagnostic repeater here.
Description	Freely definable text that is saved in the diagnostic repeater. You can enter additional information on the features of the diagnostic repeater here.

2.7 Monitoring functions for the clocked PROFIBUS bus system

Features of the clocked PROFIBUS bus system

Reproducible response times (e.g. of the same length) are achieved in SIMATIC with an equidistant DP bus cycle and the synchronization of the following free-running individual cycles:

- Free-running cycle of the user program. The length of the cycle time can vary on the basis of acyclic program branching.
- Free-running, variable DP cycle on the PROFIBUS subnet
- Free-running cycle on the DP slave backplane bus.
- Free-running cycle at signal conditioning and conversion in the electronic modules of the DP slaves.

All the affected cycles run with equidistance and clock synchronization. The process response times thus have the same length and are shorter because of the lack of cycle jumps.

Monitoring functions of the diagnostic repeater

The diagnostic repeater offers functions for detecting errors in an equidistance DP bus cycle and reporting them to the associated DP master.

The following errors are detected:

- Violation of the equidistant DP cycle (T_{DP})
- Violation of the time T_{DX} (cyclic part of the equidistant DP cycle)

T_{DX} monitoring establishes whether or not the I/O data have been received with the "expected" time in relation to the beginning of the current cycle.

The violation of the time T_{DX} can only be detected if the diagnostic repeater is handled as the last node in the cyclic part of the equidistant DP cycle of the DP master.

You achieve this by:

- Assigning the diagnostic repeater the highest node address in the DP master system and
- Using a DP master system in which the nodes are always processed in the same order.

To find out whether the DP master system used does this, refer to the corresponding technical specifications.

Monitoring function data

The diagnostic repeater can monitor an equidistant DP bus cycle (T_{DP}) from 1 ms to 32 ms.

The diagnostic repeater is synchronized with the current, equidistant DP bus cycle after 150 cycles. Diagnostic messages about equidistance violations are thus avoided in the startup phase.

The diagnostic repeater monitors the set or determined equidistant DP bus cycle with a tolerance range of $\pm 2 \mu\text{s}$ and the time T_{DX} with a tolerance range of $\pm 10 \mu\text{s}$.

Prerequisites

- As of STEP 7 V5.1 with Service Pack 3
- The equidistance master must be a DP master class 1 (i.e. a programming device/PC cannot be an equidistance master).
- In equidistance mode only one DP master (class 1) can be active on the PROFIBUS-DP. Programming devices/PCs (class 2) can be connected additionally.

3 Configuration Options

3.1 Design guidelines for diagnostic repeaters

3.1.1 PROFIBUS networks

Design guidelines for PROFIBUS networks

When designing a PROFIBUS network with diagnostic repeaters the design guidelines and the information given in the manual *SIMATIC NET PROFIBUS Networks* (Order No. 6GK1970-5CA20-0AA1) apply.

MPI networks

Line diagnostics are not possible in pure MPI networks.

Mixed copper and fiber-optic cable networks

If it is possible to do without the full functionality (diagnostic functionality) of the diagnostic repeater, diagnostic repeaters can be used in mixed copper and fiber-optic cable networks.

PROFIBUS FDL/FMS networks

Line diagnostics are in principle possible in PROFIBUS FDL/FMS networks. Under some circumstances, however, nodes may not be detected or they may be subjected to interference during topology determination. Topology determination should therefore not be carried out in PROFIBUS FDL/FMS networks. The diagnostic repeater used must not contain any topology data.

Diagnostic information can only be displayed through direct access to the diagnostic repeater from STEP 7 or COM PROFIBUS.

3.1.2 PROFIBUS components

RS 485 bus terminal

The RS 485 bus terminal must **not** be used together with the diagnostic repeater.

Lightning protection elements

The diagnostic repeater can be used with the lightning protection elements approved for the PROFIBUS-DP.

Isolating transformer

The diagnostic repeater may only be used at the non-intrinsically-safe end of an isolating terminator.

The same limitations apply to the isolating terminator as for components with repeater function.

ET 200U

The ET 200U module is not detected during topology determination. In other words, it is not displayed in diagnostic messages in STEP 7 or COM PROFIBUS and is shown in the topology display as a node that cannot be assigned. Nevertheless, line diagnostics are still possible on the corresponding segment without restrictions.

3.1.3 Bus connectors and cables

PROFIBUS-DP bus connectors

See the list of permissible PROFIBUS-DP bus connectors in Appendix A.

Requirements to be met by bus connectors

If you use other connectors, the design guidelines for the diagnostic repeater require bus connectors with integrated series inductance in accordance with IEC 61158:Ed3 Type 3:

- Inductance (L1 to L4): 110 nH \pm 20 %
- Resistor between A and A', as well as between B and B': \leq 0.35 Ohm

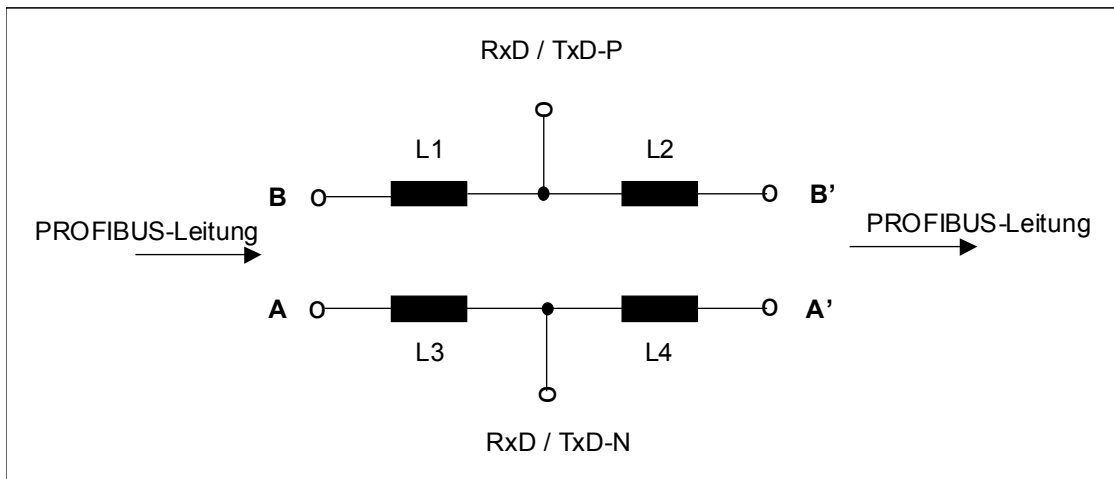

SIMATIC NET PROFIBUS cables

See Appendix A for a list of permissible SIMATIC NET PROFIBUS cables.

Requirements to be met by cables

Note

If you are using cables that are not designed for the Fast Connect connection system, you will have to convert to FastConnect cables.

If you are using other cables, the design guidelines for the diagnostic repeater require them to comply with the technical specifications in the table below:

Technical specifications	Values
Attenuation	
At 16 MHz	< 42 dB/km
At 4 MHz	< 22 dB/km
At 38.4 kHz	< 4 dB/km
At 9.6 kHz	< 2.5 dB/km
Characteristic impedance	
At 3 to 20 MHz	150 ± 15 Ω
At 38.4 kHz	185 ± 18.5 Ω
At 9.6 kHz	270 ± 27 Ω
Rated value	150 Ω
Loop resistance	≤ 110 Ω/km
Shield resistance	≤ 9.5 Ω/km
Working capacity	Approx. 28.5 nF/km

If you are using a cable that does not comply with the specifications in the table, get in touch with your SIEMENS contact.

3.1.4 Line length and cascading depth

Maximum monitorable line length

If you are using standard cables, at baud rates of 9.6 kbps to 12 Mbps the diagnostic repeater can monitor a maximum of 100 m of cable per segment (DP2, DP3).

The monitorable line length of some cable types is limited (see Appendix A).

Cascading depth

Up to nine diagnostic repeaters can be connected in series.

A diagnostic message is produced if more than nine diagnostic repeaters are connected in series.

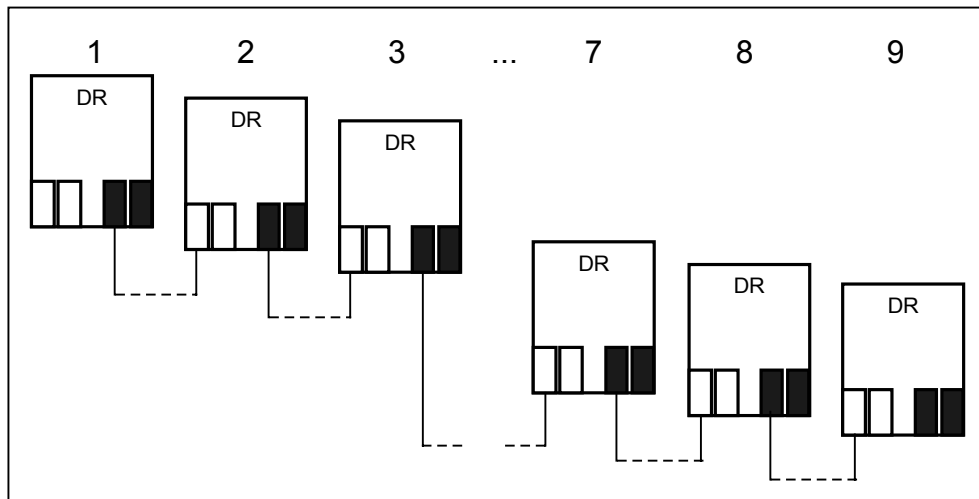

3.1.5 Spur lines

Spur lines, including those within devices, are not permissible. The party line of the S7-300 corresponds, for example, to an internal device spur line with a length of up to 0.6 m.

Caution

Spur lines are not allowed at segments DP2 and DP3 of diagnostic repeaters since they prevent correct determination of the topology and fault points.

Avoiding spur lines

Spur lines arise, for example, when programming devices or nodes are connected as a branching or when PROFIBUS if connectors are stacked over each other.

Methods of avoiding spur lines:

- Connect the programming devices directly to the programming device interface of the diagnostic repeater or
- To connect programming devices, use only the SIMATIC S5/S7 spur line for 12 Mbps ("active cable").
- The RS 485 bus terminal may not be used.

Arrangement of the nodes without spur lines

The following example shows an illegal arrangement since Node 14 is connected via a spur line, for example by stacking two connectors over each other.

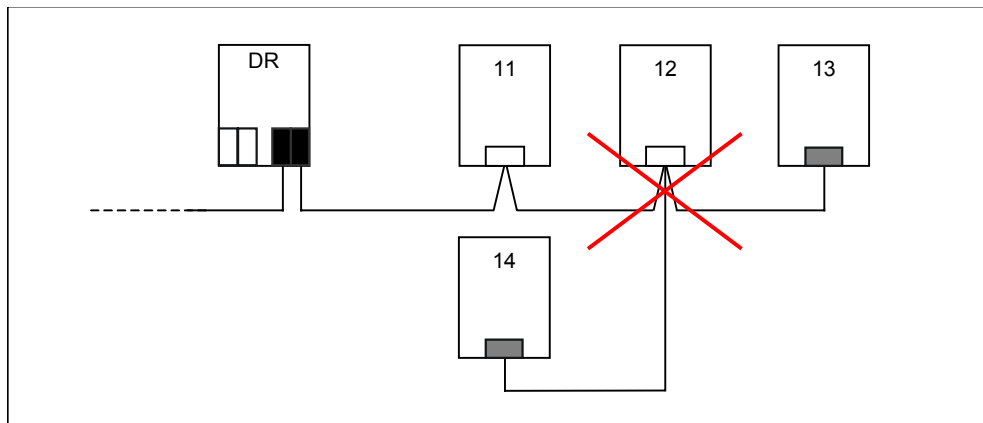

3.1.6 Only one measuring circuit at a segment

Invalid arrangement

Diagnostic repeaters have to be circuited so that a segment has a maximum of one measuring circuit. The diagnostic repeater has two interfaces with measuring circuits (DP2 and DP3) as well as one interface without measuring circuit (DP1). A diagnostic repeater may only be connected to segment DP2 or DP3 with the interface DP1.

A diagnostic message is issued if two or more measuring circuits exist at one segment.

The following examples show invalid interconnections between two diagnostic repeaters:

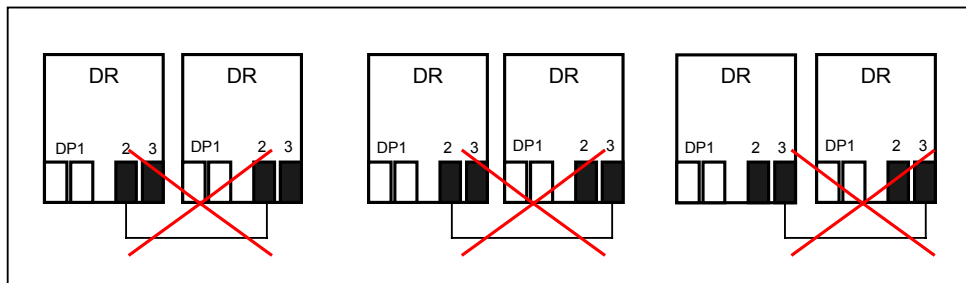

Permissible arrangement

The following examples show valid interconnections between two diagnostic repeaters. Up to 30 nodes can be positioned between the diagnostic repeaters.

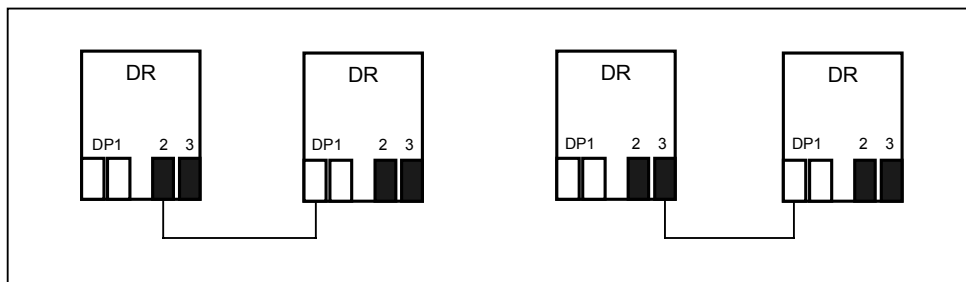

3.1.7 Arrangement of the DP master

Prerequisite for topology determination

For topology determination, a DP master is required that initiates the required measurements and that can be used by the diagnostic repeater to make its diagnostic information available.

Arrangement of the DP master

It is advisable to connect the DP master to the connections A1/B1 of segment DP1 of a diagnostic repeater.

Arrangement with one segment (DP2)

If only one diagnosable segment is to be used, segment DP2 of the diagnostic repeater has to be used. If there is no bus cable connected to segment DP3, the SEGMENT DP3 rotary switch must be switched to OFF.

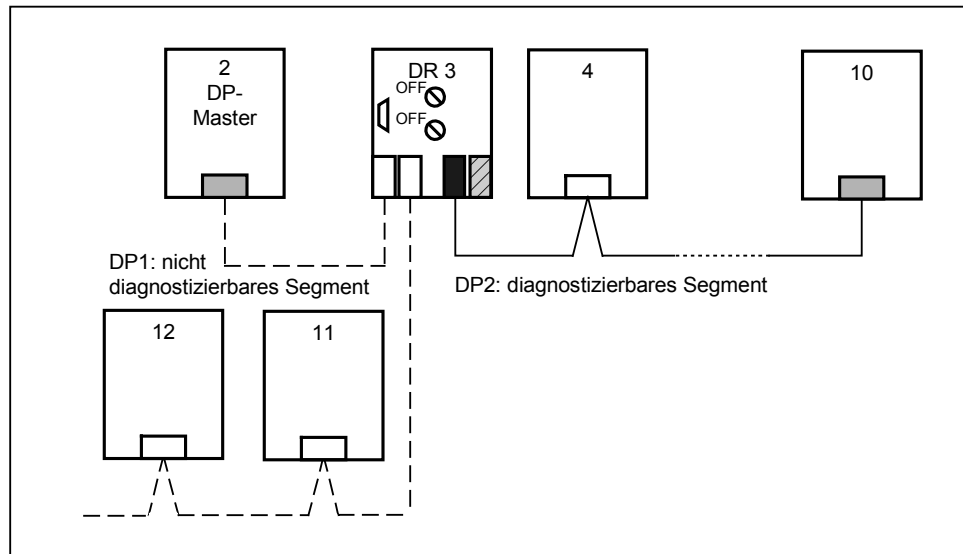

3.1.8 Example configuration

Example configuration

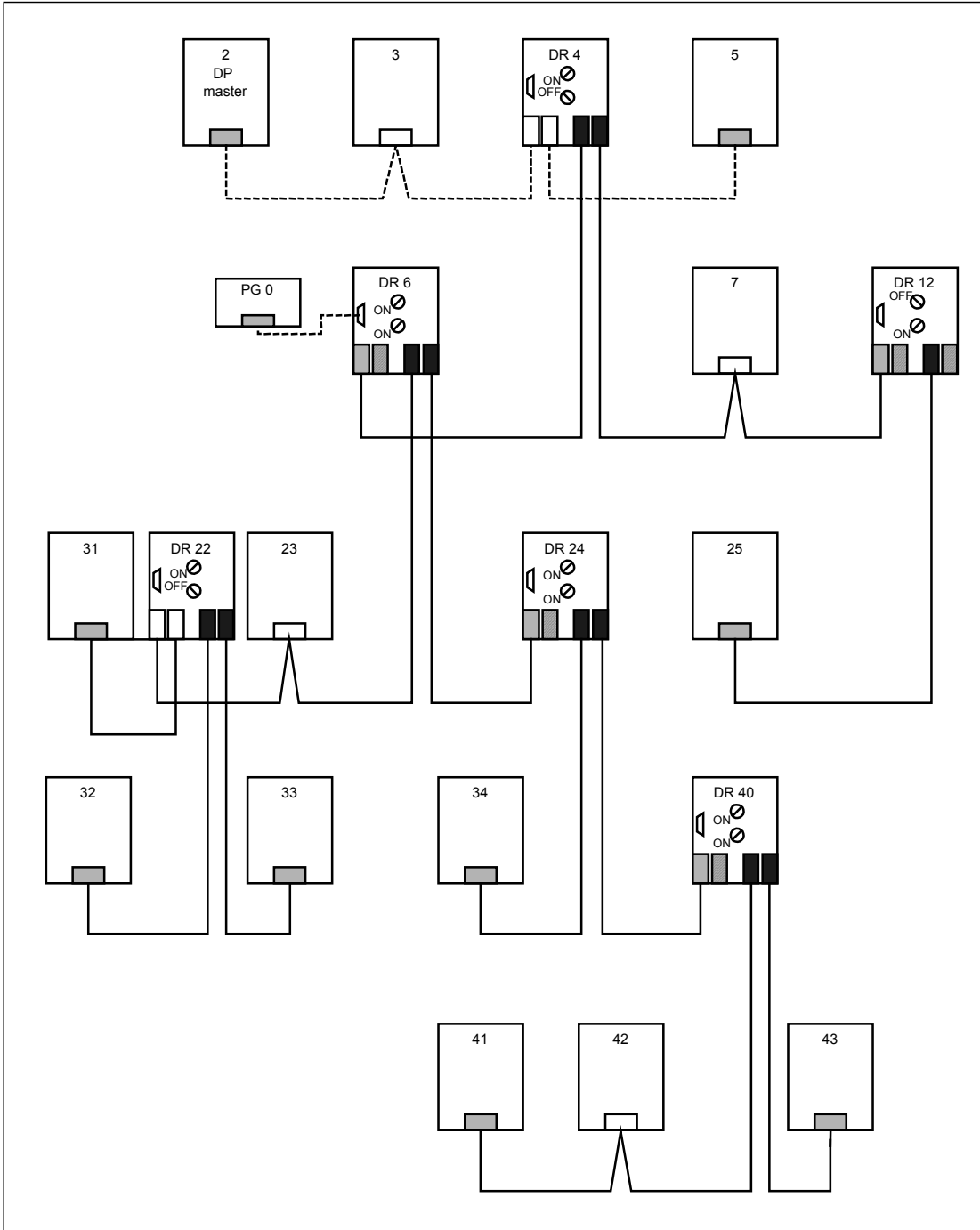

Notes

Six diagnostic repeaters (DR) are used in the example. Of these four are switched in series (DR 4, 6, 24 and 40). DP3 of the DR 12 is de-activated. At the diagnostic repeaters DR 6, 12, 24 and 40 the terminators for segment DP1 are connected, since no outgoing bus lines are connected to DP1.

Segment DP1 of the DR 4 and the line to the programming device cannot be diagnosed. Line faults can be recognized and localized in all other segments.

Figure	Description		
	PG	Interface for PG with integrated terminating resistor	
	SEGMENT DP3	Activate/deactivate segment DP3 ON = activate segment DP3 OFF = deactivate segment DP3	
	TERMINATOR DP1	Terminating resistor for segment DP1 ON = terminating resistor connected OFF = terminating resistor not connected (if both connections to DP1 are used)	
	DP1	Connections for segment DP1	
		Connection A1'/B1' of segment DP1 de-activated	
	DP2	Connections for segment DP2, with measuring circuit for line diagnostics	
	DP3	Connection for segment DP3, with measuring circuit for line diagnostics	
		Segment DP3 de-activated	
			Terminator at Node x not connected
			Terminator connected
	PG	PG, terminator connected	

3.2 Limitations when using components with repeater function

Note

Components with repeater function can be used if partially faulty determination of the topology is acceptable and if it is possible to do without line diagnostics **after** the component with repeater function.

Rule

Components with a repeater function can be used:

- Without limitations in **segment DP1** and **at the end** of segments DP2 and DP3 of a diagnostic repeater
- In segments DP2 and DP3, when topology determination with some errors is acceptable and it is possible to do without line diagnostics in the corresponding segment **after** the component with a repeater function.

PROFIBUS components with a repeater function

The following PROFIBUS components can be used, for example, in connection with the diagnostic repeater:

- RS 485 repeater
- Optical Link Module (OLM),
- Optical Bus Terminal (OBT),
- Infrared Link Module (ILM),
- Power Rail Booster,
- Data photoelectric barriers via PROFIBUS-DP.

Explanation

The line diagnostic only functions up to the component with repeater function. Every downstream node is indicated with the distance of the component with repeater function.

Consequences:

- The nodes are entered with incorrect specification of the distance in the topology table.
- The relative specification of the error can possibly not be indicated correctly.
- All the nodes lying before and after the component with repeater function are counted as nodes of **one** PROFIBUS-DP segment. This can lead to the error message "More than 32 nodes connected to a measuring segment". This error message can be suppressed by de-activating the determination of the topology for this segment in the configuration of the diagnostic repeater.

Components with integrated section monitoring

Caution

Components with integrated section monitoring, such as the Optical Link Module (OLM), can lead to segments being broken and thus to bus faults and interruptions while the topology is being determined.

Deactivate the determination of the topology for that segment of the diagnostic repeater to which components with integrated section monitoring are connected (see Section 6.3.2).

Network design with component with repeater function

The following example shows a possible network design with a component with repeater function (R).

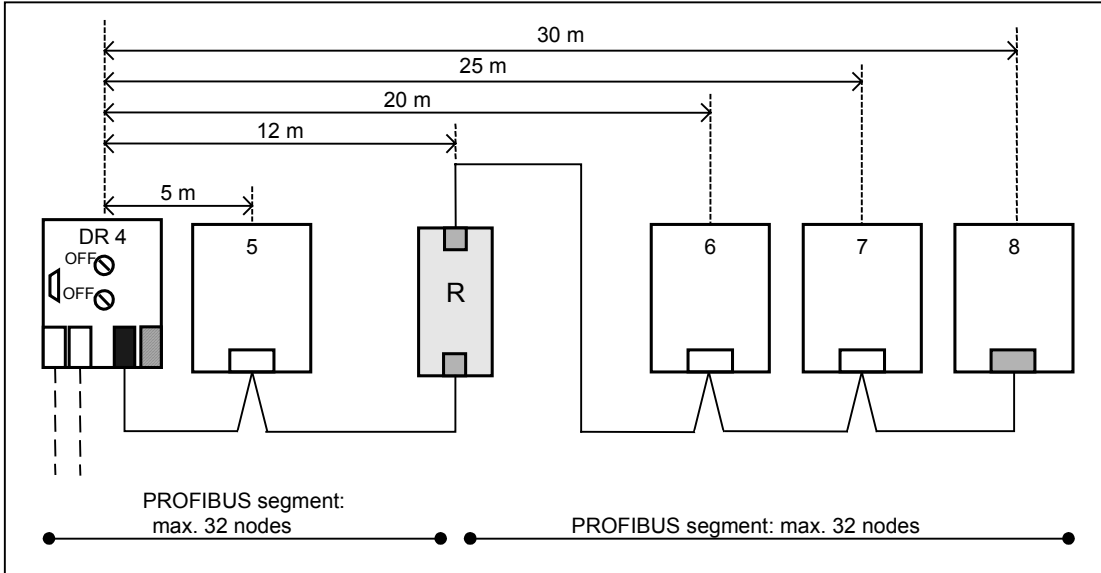

The component with a repeater function is not detected as a node (no PROFIBUS address of its own) and is thus not listed in the topology table.

The diagnostic repeater 4 determines the following data for segment DP2:

PROFIBUS address	Distance from diagnostic repeater 4	Topology determination
5	5 m	Correct
6	12 m !	Faulty
7	12 m !	Faulty
8	12 m !	Faulty

3.2.1 Network design with an RS 485 repeater

Possible network design

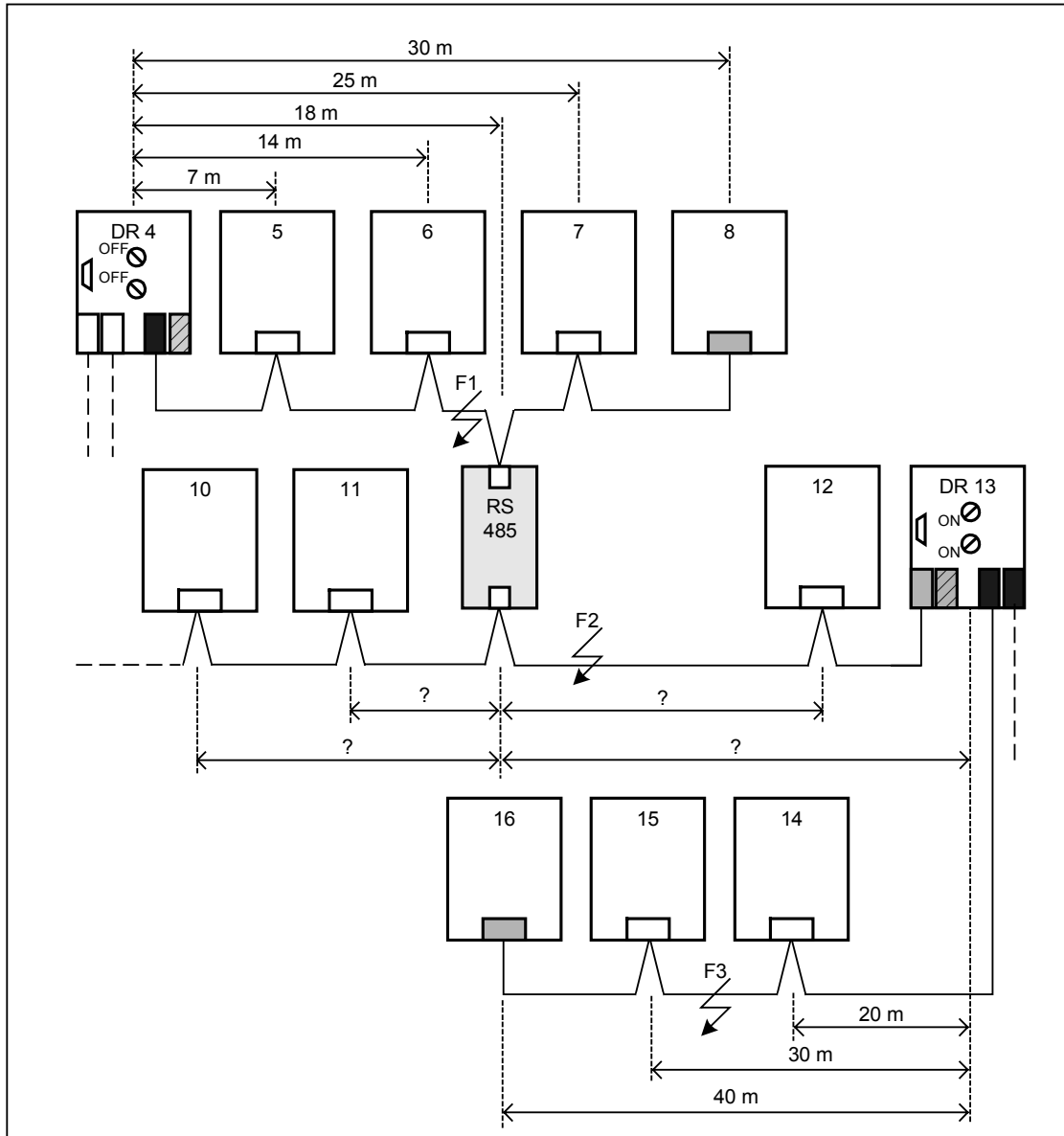

Topology table diagnostic repeater 4

The diagnostic repeater 4 determines the following data:

PROFIBUS address	Distance from diagnostic repeater 4	Topology determination
5	7 m	Correct
6	14 m	Correct
7	25 m	Correct
8	30 m	Correct
10	18 m !	Faulty
11	18 m !	Faulty
12	18 m !	Faulty
DR 13	18 m !	Faulty

Explanation

- Nodes 10, 11, 12 and DR 13 are assigned to segment DP2 of the diagnostic repeater DR 4.
- Nodes 10, 11, 12 and DR 13 are all indicated at the distance of the RS 485 repeaters (18 m).
- Error F1 is recognized and specified with the absolute distance to the DR 4 (16 m), but specified between Nodes 6 and 10.

Topology table diagnostic repeater 13

The diagnostic repeater 13 determines the following data:

PROFIBUS address	Distance from diagnostic repeater 13	Topology determination
14	20 m	Correct
15	30 m	Correct
16	40 m	Correct

Explanation

- Error F2 is not recognized since it occurred at segment DP1 of the DR 13 which cannot be diagnosed.
- Error F3 is recognized and specified correctly between Nodes 14 and 15.
- Errors occurring at segment DP3 of DR 13 are recognized correctly and located correctly.

3.2.2 Network design with an Optical Link Module (OLM)

Possible network design

If you use an Optical Link Module (OLM) with integrated section monitoring in your plant, you must de-activate the determination of the topology for segment (DP2) of the diagnostic repeater (DR 4) to which the module is connected.

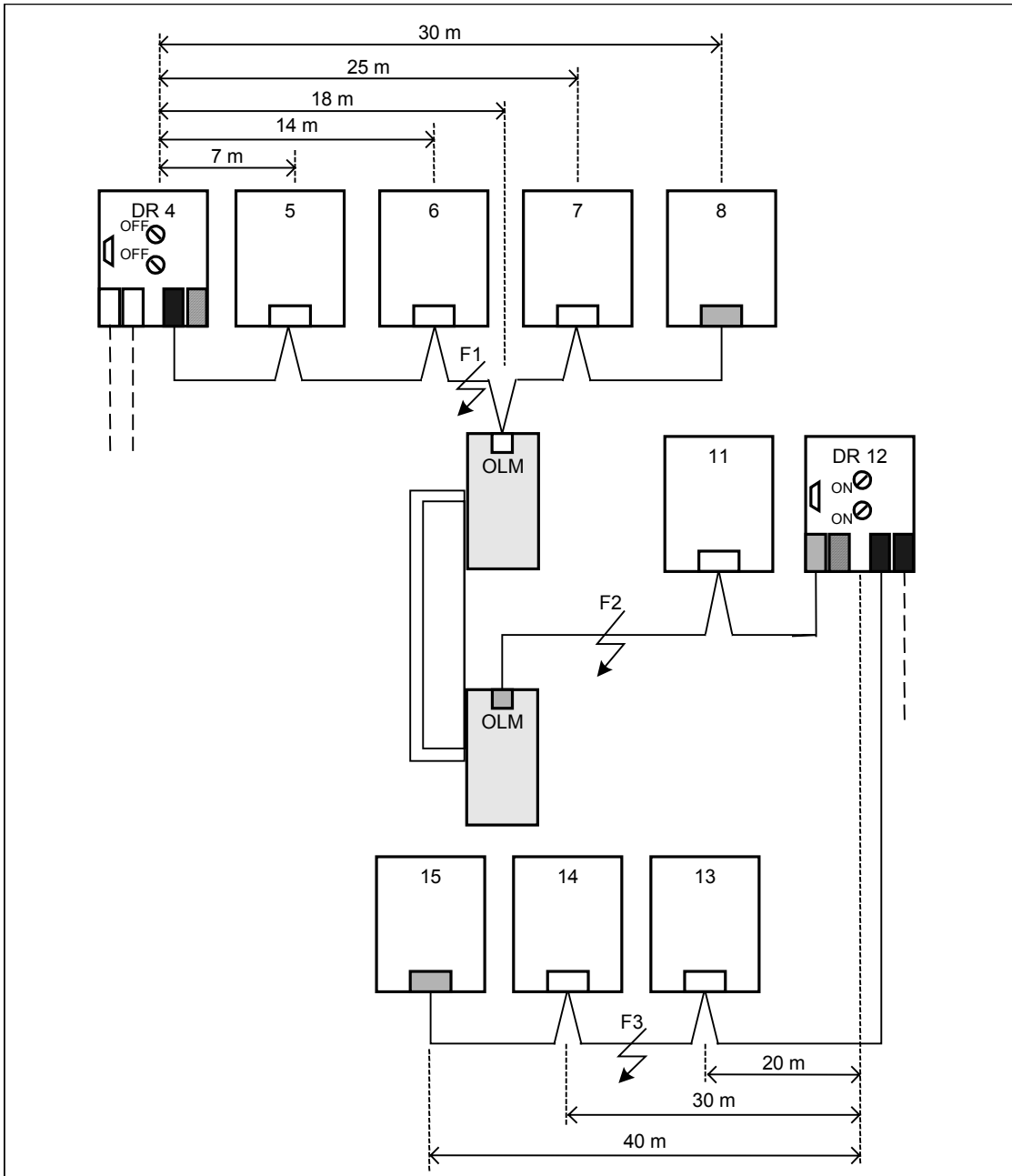

Topology table diagnostic repeater 4

The topology determination function of the diagnostic repeater 4 has to be deactivated for segment DP2 by means of the configuration (see Section 6.3.2). No data are determined.

Caution

Components with integrated section monitoring, such as the Optical Link Module (OLM), can lead to segments being broken and thus to bus faults and interruptions while the topology is being determined.

Explanation

- The topology cannot be determined for segment DP2 due to the connected Optical Link Module.
- Nodes 11 and DR 12 are assigned to segment DP2 of the diagnostic repeater DR 4.
- Error F1 is recognized and specified with the absolute distance to the diagnostic repeater DR 4 (16 m).

Topology table diagnostic repeater 12

The diagnostic repeater 12 determines the following data for segment DP2:

PROFIBUS address	Distance from diagnostic repeater 12	Topology determination
13	20 m	Correct
14	30 m	Correct
15	40 m	Correct

Explanation

- The topology can be determined correctly for segments DP2 and DP3.
- Error F2 is not recognized since it occurred at segment DP1 of the DR 12 which cannot be diagnosed.
- Error F3 is recognized and specified correctly between Nodes 13 and 14.
- Errors occurring at segment DP3 of DR 12 are recognized correctly and located correctly.

3.3 Recommendations for structuring a new plant

Multiple-stage diagnostic concept

A multiple-stage diagnostic concept allows monitoring of a PROFIBUS network during every plant phase. It provides for the following procedure for structuring and operating a new plant:

- **Installation:** avoiding errors in the physical structure of the bus by using the Fast Connect system
- **Installation/commissioning:** checking the physical structure of the bus with the BT 200 test device in offline mode
- **Current operation:** line diagnostics through the use of the diagnostic repeater

Fast Connect system

PROFIBUS Fast Connect is a system for preparing copper PROFIBUS cables quickly and easily.

The system consists of three components suited to each other:

- Fast Connect bus lines for rapid mounting,
- Fast Connect Stripping Tool,
- Fast Connect bus connector for PROFIBUS (with insulation piercing).

PROFIBUS test device BT 200

During the installation phase the test device BT 200 can be used to check the PROFIBUS line even when the nodes are plugged. Installation errors are found and logged rapidly. The person installing does not require any special PROFIBUS knowledge.

The test device BT 200 can check the following points:

- Wire break, shield break, missing or too many terminators,
- Short circuit (A to B, A/B to shield),
- Reflection points which cause faults,
- Interchanged signal lines A/B,
- Specification of the length of the laid line,
- Availability of the slaves,
- PROFIBUS interface of the nodes.

3.4 Use in an existing plant

Points to be observed when extending an existing plant

If you want to add diagnostic repeaters to an existing plant, you must:

- Observe the design guidelines for the diagnostic repeater,
- Use a programming device/PC with STEP 7 or COM PROFIBUS or an S7 CPU with the integrated system function SFC 103 "DP_TOPO", in order to be able to carry out topology determination,
- Re-configure the DP master used in order to include the diagnostic repeater as a new DP slave and in order to be able to access the diagnostic information of the diagnostic repeater.

Points to be observed when replacing a diagnostic repeater

You only receive correct diagnostic messages and distance specifications if you determine the topology after replacing a diagnostic repeater. Otherwise the information provided will be incorrect or incomplete.

Using a brand-new diagnostic repeater

The topology table of a brand-new diagnostic repeater is empty at first. In other words, the diagnostic repeater can only supply the distance of a fault location in absolute terms (e.g. the fault location is 30 meters from the diagnostic repeater).

Using a diagnostic repeater that has already been used

The topology table of a diagnostic repeater that has already been used contains information on the plant from which it has been taken.

This means that the diagnostic repeater can specify the distance to a fault point absolutely and relatively. However, as a rule this information is not suitable for the new plant.

Changes to plants

The topology must always be determined when a plant is changed, meaning when you

- Add nodes,
- Exchange nodes,
- Remove nodes,
- Change PROFIBUS addresses,
- Change the line length.

4 Installation

4.1 Mounting rules

Mounting dimensions

Installation height: 125 mm

Installation width: 80 mm

Installation depth without rail: 66.3 mm

Installation depth with rail: 72.2 mm

Mounting position

Permissible mounting positions are horizontal and vertical mounting on a vertical level.

Mounting rail

The diagnostic repeater can be mounted on the following mounting rails:

- Mounting rail for S7-300 or
- DIN rail conforming to EN 50022 (35 x 15 mm)

Required tool

Screw driver 4 mm

Prerequisites

The mounting rail is mounted.

4.2 Mounting the diagnostic repeater on a mounting rail for S7-300

In order to mount the diagnostic repeater on a mounting rail for S7-300, the slide on the rear of the diagnostic repeater has to be removed.

1. Insert a screwdriver under the shoulder of the latch element (1) and
2. Move the screwdriver to the module rear.
Keep this position!
Result: The slide is unlatched from the diagnostic repeater.
3. Use the free hand to move the slide (2) upwards until the stop position and remove the slide.
Result: The slide is removed from the diagnostic repeater.
4. Hang the diagnostic repeater into the mounting rail for S7-300 (3).
5. Swivel it backwards until the stop (4) is reached.
6. Screw the two fixing screws fast with a torque of 80 to 110 Ncm (5).

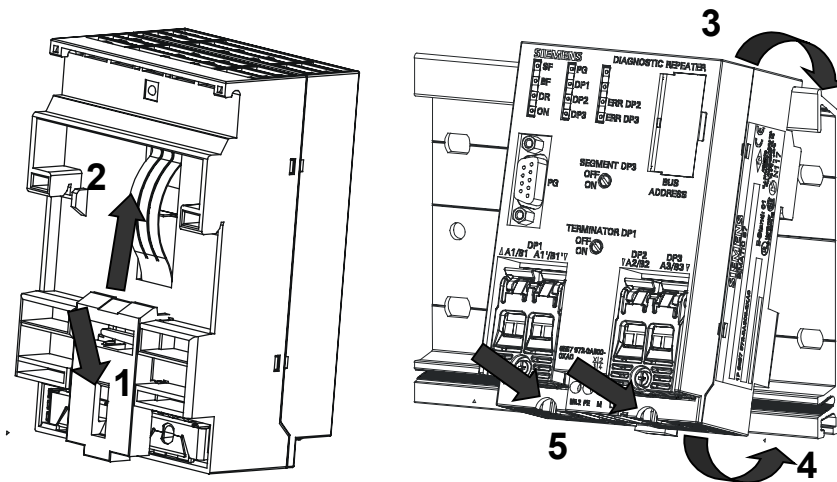

Dismantling the diagnostic repeater from the mounting rail for S7-300

In order to dismantle the diagnostic repeater from the mounting rail:

1. Loosen the fixing screw of the diagnostic repeater and
2. Swing the diagnostic repeater upwards and out.

4.3 Mounting the diagnostic repeater on a DIN rail

Mounting the diagnostic repeater on a DIN rail

In order to mount the diagnostic repeater on a DIN rail the slide must be positioned on the rear of the diagnostic repeater.

1. Hang the diagnostic repeater into the DIN rail and
2. Swivel it backwards until the slide latches in.

Dismantling the diagnostic repeater from the DIN rail

In order to dismantle the diagnostic repeater from the DIN rail:

3. Use a screwdriver to press the slide at the bottom of the diagnostic repeater downwards and
4. Swing the diagnostic repeater upwards and out of the DIN rail.

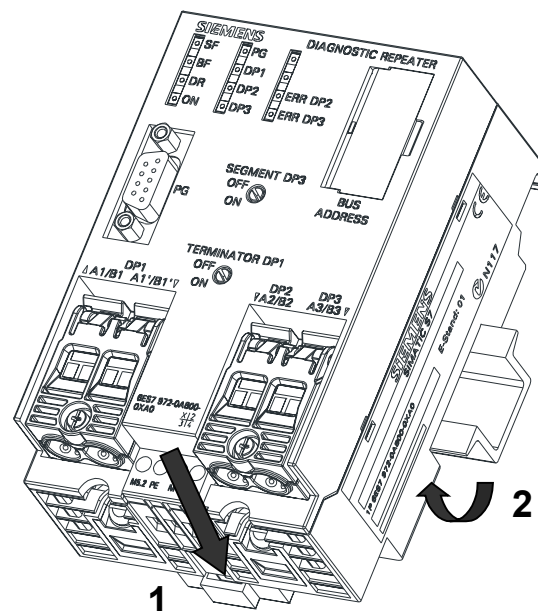

5 Wiring

5.1 Basis

Prerequisites

The diagnostic repeater is mounted on the mounting rail.

Particular points when wiring

All the lines are connected from below. The bus cables are connected by means of an insulation piercing technique (Fast Connect connection system). The insulation piercing connecting devices are designed for 10 connecting cycles.

Note

Insulation residues can remain in the insulation piercing connecting device during opening.

This can cause problems during the next connection process.

Therefore ensure that no insulation residues remain when you withdraw the line while opening the insulation piercing connecting device.

Required tool

- Use, for example, the Fast Connect stripping tool (order no. 6GK1905-6AA00)
- Screw driver 4 mm.

5.2 Connecting the supply voltage

Cable types

The following cables can be used to connect the 24 V DC supply cables:

- Rigid cable: 0.14 mm² to 2.5 mm²
- Flexible cable with wire end ferrule: 0.25 mm² to 1.5 mm²
- Flexible cable without wire end ferrule from 0.14 mm² to 2.5 mm²

Connecting the power supply

Connect the power supply of the diagnostic repeater as follows:

1. Bare the cable for the 24 V DC supply voltage.
2. Connect the cable to the terminals "PE", "M" and "L+".

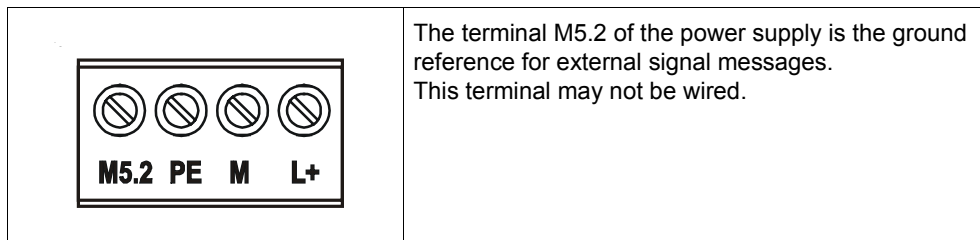

5.3 Connecting the PROFIBUS cables

Prerequisites: bus connectors and cables

Note the requirements placed on the bus connectors and cables that you use in your plant with the diagnostic repeater (see Section 3.1.3).

Overview of the procedure

- Connecting the PROFIBUS cables
- Connecting or disconnecting the terminator DP1
- Connecting or disconnecting segment DP3

Connecting the PROFIBUS cables

Connect the PROFIBUS cable to the diagnostic repeater as follows:

1. Cut the PROFIBUS cable to the required length.
2. Bare the PROFIBUS cable in accordance with the figure.
3. Screw open the black strain relief.
4. Open the transparent contacting cover for the insulation piercing connecting device.
5. Insert the incoming cable of segment DP1 into the contacting cover A1/B1, the outgoing cable into the contacting cover A1'/B1'. Insert the outgoing cables of segments DP2 and DP3 into the contacting cover A2/B2 and A3/B3. Terminate red to red and green to green.
6. Press the contacting cover firmly downwards.
7. Screw the black strain relief closed.

Stripping

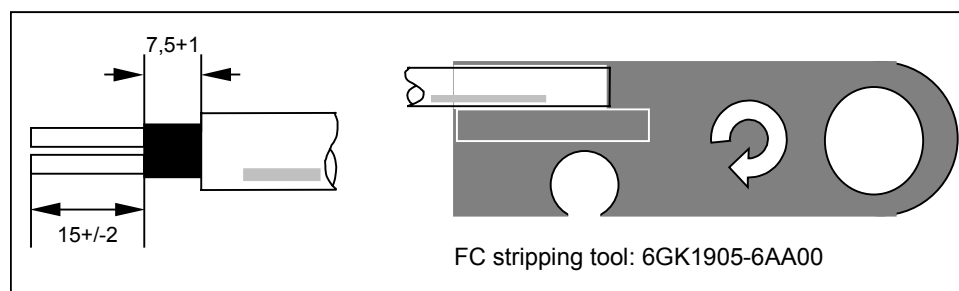

Connections

- Connection A1/B1 for the feeding bus line of segment DP1
- Connection A1/B1 for the outgoing bus line of segment DP1
- Connection A2/B2 for the bus cable of segment DP2
- Connection A3/B3 for the bus cable of segment DP3
- Connections for the power supply

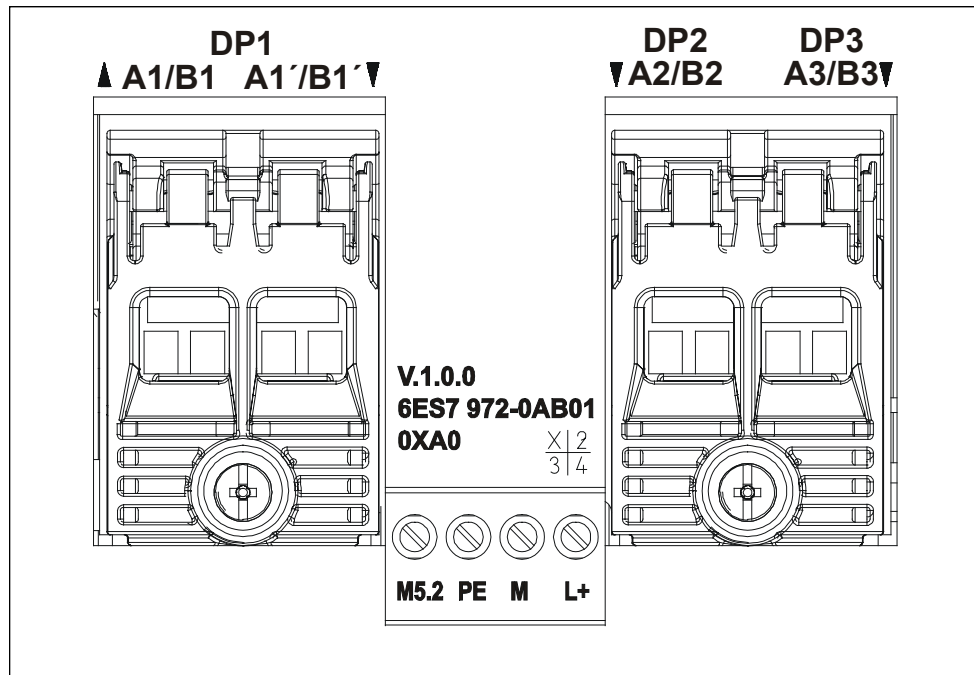

Connecting/disconnecting TERMINATOR DP1

If no outgoing bus cable is connected to the connections A1'/B1' of segment DP1, set the turn screw TERMINATOR DP1 to ON on the diagnostic repeater.

Connecting/disconnecting SEGMENT DP3

If no bus cable is connected to segment DP3, set the turn switch SEGMENT DP3 to OFF on the diagnostic repeater.

5.4 Block diagram of the diagnostic repeater

Block diagram

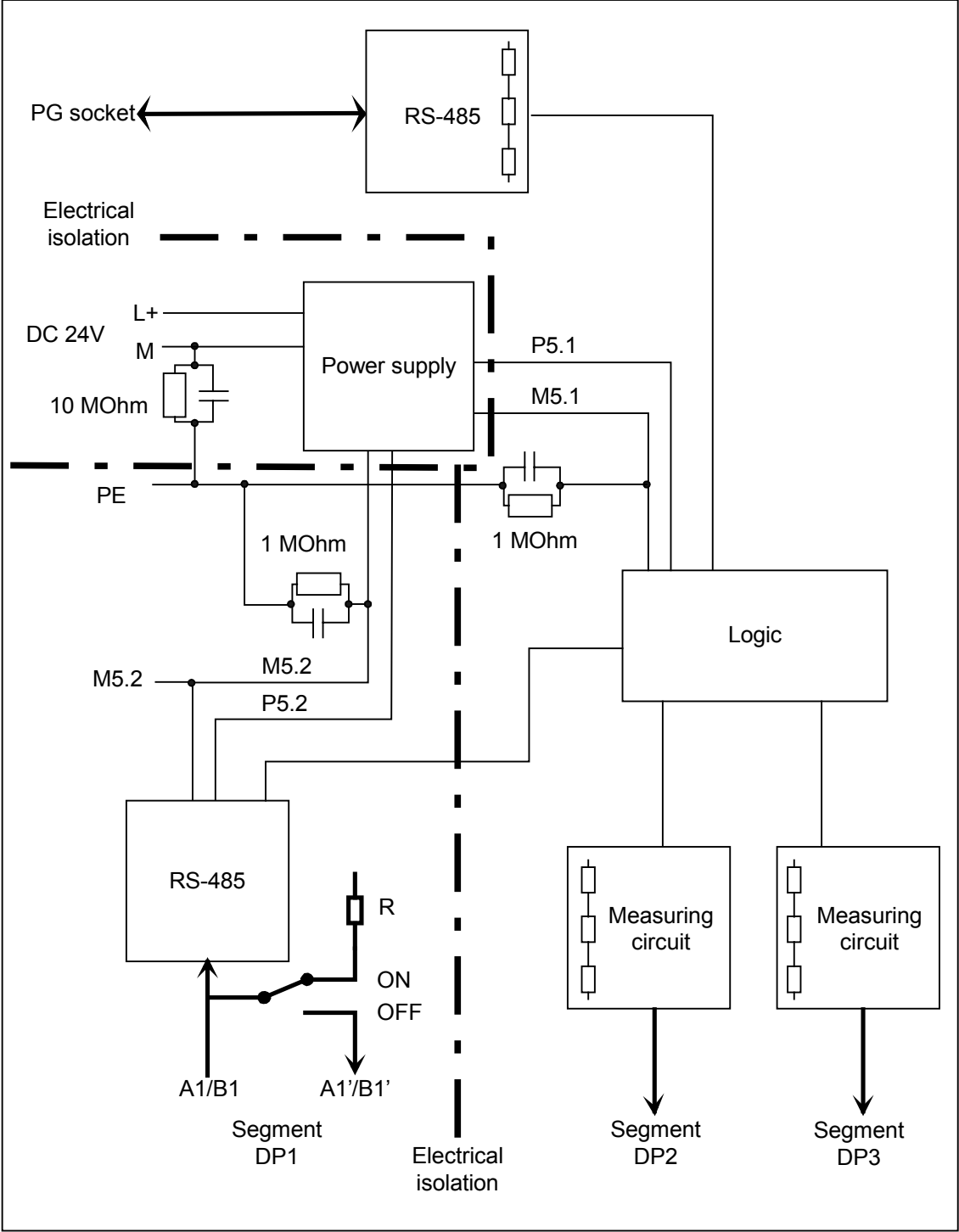

Control-to-load isolation

- Segment DP1 which cannot be diagnosed is isolated from segments DP2, DP3 which can be diagnosed and from the programming-device interface
- The power supply is isolated.
- Segments DP2, DP3 and the programming-device interface are non-isolated to each other.

Earth-free operation

Earth-free operation means that the ground and the PE are not connected to each other.

Earth-free operation of the diagnostic repeater means that bus segments can be operated isolated.

Designing a diagnostic repeater earth-free

In order to ensure earth-free operation of the diagnostic repeater you have to ensure earth-free power supply of the diagnostic repeater.

The PE terminal must always be connected.

Programming device connection of the diagnostic repeater

The programming device connection is only available for one node (programming device or OP) and is **not** designed for networking. The terminating resistor is firmly integrated in the programming device interface of the diagnostic repeater.

When using cables with bus connectors you should therefore switch the terminating resistor on the diagnostic repeater side to OFF and on the programming device/OP side, as usual, to ON.

Pin assignment of the cannon connector (PG socket)

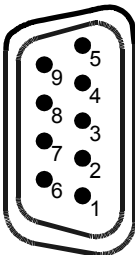
View	Pin No.	Signal name	Designation
	1	-	-
	2	M24 V	Ground 24 V
	3	RxD/TxD-P	Data line B
	4	RTS	Request to Send
	5	M5V2	Data reference potential (from node)
	6	P5V2	Supply plus (from node)
	7	P24V	24 V
	8	RxD/TxD-N	Data line A
	9	-	-

6 Commissioning

6.1 Addressing

Prerequisites

The diagnostic repeater is designed as a DP slave and therefore has its own PROFIBUS address. This specifies under which address the diagnostic repeater is addressed at the PROFIBUS-DP.

- The PROFIBUS address is set by means of switches. They are positioned on the front of the diagnostic repeater, protected by a hinged window.
- The PROFIBUS addresses 1 to 125 are permitted.
- Each address may only be assigned once at the PROFIBUS-DP.

Note

The LEDs SF, BF and DR flash if the illegal PROFIBUS addresses 0, 126 and 127 are set.

Required Tool

Screw driver 4 mm

Setting a PROFIBUS address

The PROFIBUS address results from the addition of the numbers which are assigned to the switches.

1. Swivel open the window at the diagnostic repeater.
2. Use the switches to set the desired PROFIBUS address.
3. Close the window.

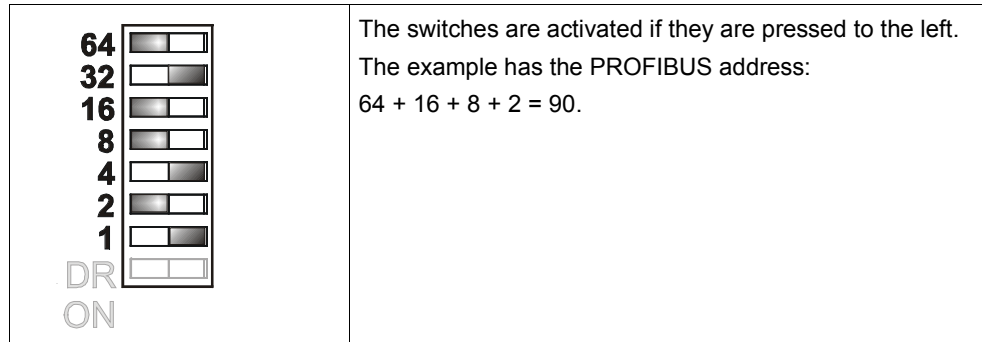

Changing the PROFIBUS address

You can change the set PROFIBUS address at any time. The diagnostic repeater takes over the modified PROFIBUS address after the 24 V DC supply has been switched off and on.

6.2 Configuration

Prerequisites

The diagnostic repeater is configured with STEP 7 or COM PROFIBUS.

The diagnostic repeater is connected to the DP master system as a DP slave.

- STEP 7

As of STEP 7 V5.1 with Service Pack 2, the diagnostic repeater appears in the hardware catalog of STEP 7 under PROFIBUS-DP / Network Components / Diagnostic Repeaters.

In older versions of STEP 7, the diagnostic repeater is integrated via the DDB file. In this case, it appears in the hardware catalog under PROFIBUS-DP / Additional Field Devices / General.

- COM PROFIBUS

As of COM PROFIBUS V5.1 with Service Pack 2, the repeater appears under DP slave / General / Network Components / Diagnostic Repeaters.

In older versions of COM PROFIBUS, the diagnostic repeater is integrated via the DDB file.

Available functions with STEP 7

Diagnostic repeater	6ES7972-0AB00-0XA0			6ES7972-0AB01-0XA0		
	STEP 7			STEP 7		
Functions	≤V5.1 SP1	V5.1 SP2	≥V5.2	≤V5.1 SP1	V5.1 SP2	≥V5.2
Topology determination	-	x	x	-	x	x
Graphical diagnostic display	-	x	x	-	x	x
Text-based diagnostic display	x	x	x	x	x	x
Display of topology, diagnostic buffer, statistics	-	-	-	-	-	x
Identification data	-	-	-	-	-	x
Monitoring function for the clocked PROFIBUS bus system	-	-	-	-	-	x
Firmware update	-	-	-	-	-	x

Available functions with COM PROFIBUS

Diagnostic repeater	6ES7972-0AB00-0XA0		6ES7972-0AB01-0XA0	
	COM PROFIBUS		COM PROFIBUS	
Functions	≤V5.1 SP1	V5.1 SP2	≤V5.1 SP1	V5.1 SP2
Topology determination	-	x	-	x
Graphical diagnostic display	-	x	-	x
Text-based diagnostic display	x	x	x	x

Diagnostic repeater	6ES7972-0AB00-0XA0		6ES7972-0AB01-0XA0	
Display of topology, diagnostic buffer, statistics	-	-	-	-
Identification data	-	-	-	-
Monitoring function for the clocked PROFIBUS bus system	-	-	-	-
Firmware update	-	-	-	-

Downloading Service Pack 2 for COM PROFIBUS V5.1

The COM PROFIBUS version for the diagnostic repeater can be found in the Internet under

<http://www4.ad.siemens.de/view/cs/de/7256370>

DDB file for non-Siemens master

The diagnostic repeater is configured via the GSD file. The Siemens GSD can be found in the Internet under

<http://www.ad.siemens.de/csi/gsd>

Topology determination is not possible with non-Siemens masters. Line faults are displayed as text rather than graphically.

6.2.1 Configuration for standard operation

Configuration

- STEP 7

In STEP 7 the "DR-CfgData" module is entered in the configuration table automatically.

- COM PROFIBUS

Drag the "DR-CfgData" module from the hardware catalog to the configuration table.

6.2.2 Configuring the monitoring functions for the clocked PROFIBUS bus system

Configuration

- STEP 7

Drag the TSYNC diagnostic module from the hardware catalog to the configuration table.

This allows you to detect, in addition to the diagnostic data in the input data of the diagnostic repeater, T_{DX} violations and/or T_{DP} violations, including the associated cycle. The structure of the input data is identical to that of the diagnostic message (see Chapter 7.2.7).

- COM PROFIBUS

Monitoring functions for the clocked PROFIBUS bus system are not available.

Procedure for setting clock synchronization (equidistance)

1. Settings on the CPU:
 - Set a CPU clocked interrupt ("Clocked Interrupts" tab)
 - Select the DP master system used.
 - Select the desired process image partition.
2. Settings on the DP master system:
 - Activate equidistance on the DP master system ("General" tab > Properties > "Network Settings" tab > Options)
 - Set the length of the equidistant DP cycle (min. 1 ms, max. 32 ms)
3. Settings on the diagnostic repeater:
 - Activate "Synchronize DP slave with DP cycle".
 - Enter the times T_i and T_o (unless "Times T_i and T_o same for all slaves" is set on the DP master system).
Recommendation: Accept the defaults for T_i and T_o .

6.3 Parameter assignment with STEP 7

Prerequisites

If you are using a SIMATIC S7 DP master from Siemens and you comply with the design guidelines of the diagnostic repeater (see Section 3.1), you do not have to assign any parameters.

It is possible that you may have to parameterize the diagnostic message frame length if you are not using a SIMATIC S7 DP master.

If you use components with repeater function, you may have to de-activate the topology determination function of the diagnostic repeater.

6.3.1 Parameterizing the diagnostic message frame length

Some DP masters are limited with regard to the diagnostic message frame length. The diagnostic display may therefore not be possible for all segments. Check the supported diagnostic message frame length on the basis of the technical data of the DP master and, if necessary, change the parameter configuration of the diagnostic repeater.

Set the parameter to the value which the used DP master can fulfill in the "Properties - DP slave" dialog box.

Parameters	Value	Byte
Diagnostic message frame length for	Segment DP2, DP3, DP1, PG, TSYNC	91
	Segment DP2, DP3, DP1, PG	84 (default)
	Segment DP2, DP3, DP1	65
	Segment DP2, DP3	46
	Segment DP2	27

6.3.2 Parameter assignment when using components with a repeater function

If you use an Optical Link Module (OLM) with integrated section monitoring in your plant, you **must** de-activate the determination of the topology for the segment of the diagnostic repeater to which the module is connected.

If you use an RS 485 repeater in your plant, you **should** deactivate topology determination for the segment of the diagnostic repeater to which the RS 485 repeater is connected.

To do so, set the corresponding parameter to **OFF** in the "Properties - DP slave" dialog box.

Parameters	Value
Topology determination DP2	ON / OFF
Topology determination DP3	ON / OFF

6.3.3 Parameter assignment of the monitoring functions for the clocked PROFIBUS bus system

To activate the monitoring functions for the clocked PROFIBUS bus system, in the "Properties - DP slave" dialog box, set the TDP_Monitoring parameter or the TDX_Monitoring parameter to ON.

Parameters	Value
TDP_Monitoring	ON / OFF
TDX_Monitoring	ON / OFF

6.3.4 Parameter assignment of DP interrupt mode in STEP 7

On the "Parameter Assignment" tab you can select DP interrupt mode.

In the case of DPV0, the diagnostic interrupt OB (OB82) is called if diagnostic events occur in the S7 PLC.

In the case of DPV1, the diagnostic interrupt OB (OB82) is **not** called if diagnostic events occur in the S7 PLC. It is therefore advisable to keep the setting DPV0.

Parameters	Value
DP interrupt mode	DPV0 (default) DPV1

6.4 Commissioning: Determining the topology

Prerequisites

- The diagnostic repeater is mounted and wired.
- The PROFIBUS address is set.
- The diagnostic repeater is configured and parameterized.
- The DR switch behind the hinged window is set to ON (state of delivery).
- The power supply for the DP master is switched on.

Preparing for topology determination with programming device/PC

A programming device/PC can be connected to the PROFIBUS network whose topology is to be determined. If there are several PROFIBUS networks, for example at S7-CPU's, the topology has to be determined at each network.

- Connect the programming device/PC to the programming-device interface of a diagnostic repeater of the corresponding network or
- Only use the SIMATIC S5/S7 connecting cable for 12 Mbps ("active cable") in order to connect the programming device/PC.
- The programming device/PC may not be connected at an MPI interface.

Topology determination with STEP 7

Proceed as follows:

1. In SIMATIC Manager select the PROFIBUS network which contains the diagnostic repeater with the connected programming device/PC.
2. Choose the following menu command:
PLC > PROFIBUS > Prepare Line Diagnostics
3. Select the "Start Measuring" command button in the dialog box then displayed.

Topology determination with COM PROFIBUS

Select the menu command **Service > Prepare Line Diagnostics**.

Topology determination with SFC 103 "DP_TOPOL"

Alternatively, the topology can also be determined with an S7 CPU that supports the integrated system function SFC 103 "DP_TOPOL".

SFC 103 "DP_TOPOL" starts topology determination for a selected DP master system. When SFC 103 is called, all the diagnostic repeaters on **one** DP master system are addressed.

Note

Note that only one topology determination operation can be active at any one time in a PROFIBUS network.

User program example

STL	Description
CALL "DP_TOPOL"	SFC103 Call topology determination
REQ :=M2.0	Start topology determination (bool)
R :=M2.1	=1: Cancel topology determination (bool)
DP_ID :=1	ID of the DP master system whose topology is to be determined (int)
RET_VAL :=MW110	Return value of the job status (int)
BUSY :=M112.0	=1: Topology determination is not yet concluded. (bool)
DPR :=MB124	PROFIBUS address of the error-reporting diagnostic repeater (byte)
DPRI :=MB125	Measuring segment of the error-reporting diagnostic repeater (byte)

Duration of the topology determination

The duration of the topology determination depends on the design of your plant and the transfer rate. The topology determination is aborted if its duration exceeds the limits specified in the table.

Transfer rate	Limits
12 MB	5 min
6 MB	5 min
3 MB	5 min
1.5 MB	8 min
500 kB	12 min
187.5 kB	16 min
93.75 kB	32 min
45.45 kB	64 min
19.2 kB	160 min
9.6 kB	320 min

Topology determination in the case of a pending line fault

Topology determination can only be carried out when there are no line faults in the network.

If line faults exist at power on, topology determination cannot be carried out successfully. The distance of the fault location to the diagnostic repeater is, however, always recorded and displayed.

The topology determination cannot be carried out until the fault has been eliminated by the user.

7 Diagnostics

7.1 Overview

Overview

The diagnostic repeater allows rapid localization of line faults which occur during the operation at the PROFIBUS-DP.

Line faults are made visible by the LEDs at the diagnostic repeater.

A detailed diagnostic display is carried out via STEP 7 or COM PROFIBUS.

With STEP 7 it is possible to display the following information for the diagnostic repeater with the order number 6ES7 972-0AB01-0XA0:

- The topology as a graphic or in tabular form
- Diagnostic buffer
- Statistics buffer

In the user program this information can be read out and displayed on an HMI device, for example.

Which faults can the diagnostic repeater diagnose?

The diagnostic repeater recognizes the following types of faults:

- Break in the signal line A or B,
- Short-circuit in the signal line A or B to shield,
- Missing terminators,
- Loose contacts,
- Invalid cascading depth,
- Two or more measuring circuits in a segment,
- Too many nodes in a segment,
- Node too far away from the diagnostic repeater,
- Faulty messages.

What cannot be diagnosed with certainty by the diagnostic repeater?

The following faults are not recognized with certainty:

- Non-energized terminators,
- Terminator connected, but there is no node,
- Additional terminator in a segment,
- Short circuit between signal line A and B.

7.1.1 Diagnosis through LED display

Status and fault displays through LEDs

LED	Color	State	Description
SF	Red	Off	No fault
		On	Group error
BF	Red	Off	No bus fault
		Flashing	<ul style="list-style-type: none"> Slave is not configured or incorrectly Incorrect but still valid PROFIBUS address set Actual design does not agree with specified design
		On	Bus fault
DR	Green	Off	Repeater function off (DR switch to OFF).
		Flashing	Baud rate search running.
		On	Baud rate found and repeater function on.
ON	Green	Off	No voltage.
		On	Voltage is applied.
PG	Yellow	Off	No bus activity at the programming-device interface.
		Flashing	Segment at the programming-device interface de-activated.
		On	Bus activity at the programming-device interface.
DP1	Yellow	Off	No bus activity at segment DP1.
		Flashing	The diagnostic repeater switched off segment DP1 automatically since it cannot detect any correct message frames (no signal level or signal level unstable).
		On	Bus activity at segment DP1.
DP2	Yellow	Off	No bus activity at segment DP2.
		Flashing	The diagnostic repeater switched off segment DP2 automatically since it cannot detect any correct message frames (no signal level or signal level unstable).
		On	Bus activity at segment DP2.
DP3	Yellow	Off	No bus activity on segment DP3 or segment DP3 switched off.
		Flashing	The diagnostic repeater switched off segment DP3 automatically since it cannot detect any correct message frames (no signal level or signal level unstable).
		On	Bus activity at segment DP3 recognized.
ERR DP2	Red	Off	There is no line fault at segment DP2.
		Flashing	The diagnostic repeater carries out an active line check at segment DP2.
		On	There is a line fault at segment DP2.
ERR DP3	Red	Off	There is no line fault at segment DP3.
		Flashing	The diagnostic repeater carries out an active line check at segment DP3.
		On	There is a line fault at segment DP3.

Fault displays through LEDs

LED				Meaning	Cause
SF	BF	DR	ON		
Off	Off	Off	Off	No voltage	Voltage not applied.
Off	On	Flashing	On	No connection to DP master	<ul style="list-style-type: none"> • Bus connection interrupted • DP master does not exist / is deactivated
Off	Flashing	On	On	Parameter assignment error, there is no data exchange taking place.	<ul style="list-style-type: none"> • Slave is not configured or incorrectly • Incorrect but still valid PROFIBUS address set • Actual design does not agree with specified design
On	Off	On	On	Error in the slave	There is (at least) one diagnosis in the slave - the slave is exchanging data
Off	Off	On	On	Data exchange	No fault
Flashing	Flashing	Flashing	On	PROFIBUS address	Impermissible PROFIBUS address set: 0, 126, 127
Off/on	Off/on/flashing	Off	On	Repeater function off	DR switch to OFF

7.1.2 Diagnosis with STEP 7 and COM PROFIBUS

Requirements

In order to receive correct distance specifications in the diagnostic messages the topology determination has to be updated after every change in the bus structure!

Visualizing the diagnosis

The diagnostic messages can be visualized for example by means of the following tools and menu commands:

- STEP 7: **PLC > Module Information**
- Signal System Faults (at operator control and monitoring device)
- COM PROFIBUS: **Service > Slave Diagnostics**
- PROFIBUS Diagnostic Package (S7 diagnostic block FB 125)

Reporting system faults

Operator control and monitoring devices, for example OPs, are connected at the PROFIBUS or via the MPI interface to the CPU of the DP master. The operator control and monitoring device fetches the diagnostic information from this CPU. The message texts are generated in STEP 7 and can be visualized with the operator control and monitoring devices.

Further information can be found in the manual *Programming with Step 7 V 5.1* in the section "Signaling System Faults"

Reading out current diagnostic messages

The diagnostic messages of the diagnostic repeater can be read out in the user program using SFC 13 "DP NRM_DG" and stored in the data area.

Further information can be found in the on-line help system of STEP 7.

S7 diagnostic block FB 125

The S7 diagnostic block can be found in the Internet under

<http://www4.ad.siemens.de/view/cs/de/387257>

7.2 Structure of the diagnosis

7.2.1 Structure of the slave diagnosis

Byte 0	Station status 1
Byte 1	Station status 2
Byte 2	Node status 3
Byte 3	Master PROFIBUS address
Byte 4	Manufacturer identifier (high byte)
Byte 5	Manufacturer identifier (low byte)
Byte 6	Identifier-specific diagnosis
Byte 7	Identifier-specific diagnosis
Byte 8 . .	Device-specific diagnosis: line fault status segment DP2
Byte 26	
Byte 27 . .	Device-specific diagnosis: line fault status segment DP3
Byte 45	
Byte 46 . .	Device-specific diagnosis: line fault status segment DP1
Byte 64	
Byte 65 . .	Device-specific diagnosis: line fault status programming device interface
Byte 83	
Byte 84 . .	Device-specific diagnosis: TSYNC diagnostic module
Byte 90	

Note

The length of the diagnostic frame varies between 6, 27, 46, 65, 84 or 91 bytes. You can find out the length of the last diagnostic frame received in STEP 7 from the "RET_VAL" parameter of SFC 13.

7.2.2 Node status 1 to 3

Definition

The node status 1 to 3 provides an overview of the state of a DP slave.

Station status 1

Bit	Meaning	Cause/remedy
0	1: The DP slave cannot be addressed by the DP master.	<ul style="list-style-type: none"> • Correct PROFIBUS address set at the DP slave? • Bus connector connected? • Voltage at DP slave? • RS 485 repeater set correctly? • Reset carried out at DP slave?
1	1: The DP slave is not yet ready for the data exchange.	<ul style="list-style-type: none"> • Wait, since the DP slave is just starting up.
2	1: The configuration data sent from the DP master to the DP slave do not agree with the design of the DP slave.	<ul style="list-style-type: none"> • Correct design of the DP slave entered in the configuration software? Evaluate the identifier-specific diagnosis.
3	1: There is an extended diagnosis available. (group diagnosis display)	<ul style="list-style-type: none"> • Evaluate the device-specific diagnosis (line fault status). Bit 3 is reset as soon as all the faults have been eliminated. The bit is set again when a new diagnostic message exists in the bytes of the device-specific diagnosis.
4	1: The requested function is not supported by the DP slave (e.g. changing the PROFIBUS address via the software).	<ul style="list-style-type: none"> • Check the configuration.
5	1: DP master cannot interpret the answer of the DP slave.	<ul style="list-style-type: none"> • Check the bus design.
6	1: The DP slave type does not agree with the software configuration.	<ul style="list-style-type: none"> • Correct node type entered in the configuration software?
7	1: The DP slave has been configured from a different DP master (not from the DP master which currently has access to the DP slave).	<ul style="list-style-type: none"> • Bit is always 1 when you are e.g. accessing the DP slave with the PG or with another DP master. The PROFIBUS address of the DP master which configured the DP slave is contained in the diagnostic byte "Master PROFIBUS address".

Station status 2

Bit	Meaning	
0	1:	The DP slave has to be configured again.
1	1:	There is a diagnostic message. The DP slave does not function until the fault has been eliminated (static diagnostic message).
2	1:	The bit is always set to 1 in the DP slave.
3	1:	The response monitoring is activated at this DP slave.
4	1:	The DP slave has received the control command "FREEZE". ¹
5	1:	The DP slave has received the control command "SYNC". ¹
6	0:	Bit is always set to 0.
7	1:	The DP slave is de-activated, meaning that it has been removed from the current processing.

¹ The bit is updated only if another diagnostic message changes, too.

Node status 3

Bit	Meaning	
0 to 6	0:	Bits are always set to 0.
7	1:	<ul style="list-style-type: none"> There are more diagnostic messages than the DP slave can save. The DP master cannot enter all the diagnostic messages sent by the DP slave in its diagnostic buffer (device-specific diagnosis)

7.2.3 Master PROFIBUS address

Definition

The diagnostic byte Master PROFIBUS address is contained in the PROFIBUS address of the DP master:

- Which has configured the DP slave and
- Which has reading and writing access to the DP slave.

The Master PROFIBUS address is contained in Byte 3 of the Slave diagnosis.

7.2.4 Manufacturer identifier

Definition

The manufacturer ID contains a code that describes the type of the DP slave.

Manufacturer identifier

Byte 4	Byte 5	Manufacturer identifier for
80H	A7H	Diagnostic repeater

7.2.5 Structure of the module diagnosis

Definition

The identifier-specific diagnosis provides information on whether the diagnostic repeater has been configured incorrectly or not. The identifier-specific diagnosis encompasses bytes 6 and 7.

Identifier-specific diagnosis

The identifier-specific diagnosis for the diagnostic repeater has the following structure:

Byte	MSB							LSB		
	7	6	5	4	3	2	1	0		
6	0	1	0	0	0	0	1	0		
	Code for identifier-specific diagnosis		Length of the identifier-specific diagnosis (2 bytes)							
7	0	0	0	0	0	0	0	1		
	Events on the module are signaled by set bits.									

7.2.6 Structure of the device-specific diagnosis

Line fault status

The following section describes the structure of the line fault status of segments DP1, DP2, and DP3 and of the programming device interface.

Byte	MSB							LSB		
	7	6	5	4	3	2	1	0		
1	0	0	Block length = 19							Length
2	1	Status type line fault = 32							Type	
3	0: Slot number								Slot	
4	res.								Specifier	
5	Segment				res.	res.	res.	res.	Error information	
6	Version		res.	res.	LD	Topology ON/ OFF	Segment ON/ OFF	res.		
7	Fault rate									
8	Node x								Fault location	
9	Node y									
10	Distance [0] from station x (high byte)									
11	Distance [1] from station x (low byte)									
12	Distance [0] from station y (high byte)									
13	Distance [1] from station y (low byte)									
14	Distance [0] from the diagnostic repeater (high byte)									
15	Distance [1] from the diagnostic repeater (low byte)									
16	A.7	A.6	A.5	A.4	A.3	A.2	A.1	A.0	Error cause	
17	B.7	B.6	B.5	B.4	B.3	B.2	B.1	B.0		
18	C.7	C.6	C.5	C.4	C.3	C.2	C.1	C.0		
19	res.									

res. Reserved bits are occupied with "0".

Error information

Range	Description		
Segment	Bit 4		Segment DP3
	Bit 5		Segment DP2
	Bit 6		Segment DP1
	Bit 7		Programming device interface
Segment ON/OFF	Bit 1	0	Segment DP3 ON
		1	Segment DP3 OFF
Topology ON/OFF	Bit 2	0	Topology determination on DP2 or DP3 ON
		1	Topology determination on DP2 or DP3 OFF
LD (line diagnosis)	Bit 3	0	There is no fault in the affected segment (all bits A.0 to C.7 = 0)
		1	There is a fault in the affected segment (at least one bit from A.0 to C.7 = 1)
Version	Bit 6	0	DR 6ES7 972-0AB00-0XA0
		1	DR 6ES7 972-0AB01-0XA0
	Bit 7	0	On the basis of the version, a software package can identify whether or not the LD bit is to be evaluated. –
Fault rate	Bit 0 to 6		Value range from 0 to 100% The value FF _H means that there is no error rate for the relevant diagnostic event.

Fault location

The information on the fault location is only relevant to segments DP2 and DP3.

Range	Description		
Station x, Station y	Bit 0 to 6		Addresses of the stations between which there is a line fault.
	Bit 7	0	The distance specification of the node is not up to date. The distance specification of a node is not up to date if topology determination has not been carried out after voltage recovery or for a certain period.
		1	The distance specification of the node is up to date.
Distance [0, 1] from x	Bit 0 to 7		Distance of the reflection point from node x. The specification is made in the unit "decimeters". If either 7FH or FFH is entered in "station x", the parameter "Distance [0, 1] from x" cannot be evaluated.
Distance [0, 1] from y	Bit 0 to 7		Distance of the reflection point from node y. The specification is made in the unit "decimeters". If either 7FH or FFH is entered in "station y", the parameter "Distance [0, 1] from y" cannot be evaluated.
Distance [0, 1] from DR	Bit 0 to 7		Distance of the reflection point from the diagnostic repeater. The specification is made in the unit "decimeters". The value FFH means that the distance from the fault location to the diagnostic repeater cannot be specified for the relevant diagnostic event.

Special cases: area station x, station y

Special case	Station x = ...	Station y = ...
Fault point for one or more nodes to do with \leq measurement accuracy	Address of a node (representative)	FFH
Fault location before the first station	Separate address	First station
Fault location after the last station	Last station	7FH
Fault location at a node	Address of the node	FFH
Fault location unknown	FFH	FFH
Further measuring circuit in the segment	Separate station address	Station connected to separate station by means of measuring circuit
Node too far away	Separate station address	Node too far away
Maximum cascade depth exceeded	Separate station address	Station at other end of the cascade

Error cause

Bit	Description	
A.0	1:	Fault location and cause not clear (possibly electromagnetic interference).
A.1	1:	-
A.2	1:	-
A.3	1:	Further measuring circuits at the segment, the other diagnostic repeater is connected with its segment DP2.
A.4	1:	Further measuring circuits at the segment, the other diagnostic repeater is connected with its segment DP3.
A.5	1:	–
A.6	1:	Error cause is not clear.
A.7	1:	Message fault rate is critical.
B.0	1:	Break in the signal line A.
B.1	1:	Short circuit between signal line B to screen.
B.2	1:	–
B.3	1:	Short circuit between signal line A to screen.
B.4	1:	Break in the signal line B.
B.5	1:	–
B.6	1:	Break in signal line A and/or B or no terminating resistor.
B.7	1:	Short circuit between signal line A and/or B or an additional terminating resistor has been inserted.
C.0	1:	Segment de-activated automatically, because line level constantly zero.
C.1	1:	Segment de-activated automatically, because line level constantly unsteady.
C.2	1:	–
C.3	1:	–
C.4	1:	More than 32 nodes are connected to the measuring segment.
C.5	1:	The distance of the node to the diagnostic repeater exceeds the permitted line length.
C.6	1:	The maximum permitted number of diagnostic repeaters connected in series is exceeded.
C.7	1:	The diagnostic repeater has recognized further faults.

7.2.7 Monitoring function of the clocked PROFIBUS bus system

Diagnostic message

If the diagnostic repeater detects a T_{DX} and/or T_{DP} violation, it generates a corresponding diagnostic message. The diagnostic for the display of the T_{DX} or T_{DP} violation is structured as follows:

Byte	MSB	6	5	4	3	2	1	LSB		
	7							0		
1	0	0	Block length = 7							Length
2	1	Status type TSYNC fault = 33 (dec)								Type
3	Slot number = 0								Slot	
4	Reserved = 0								Specifier	
5	Cycle counter [high]								Cycle counter	
6	Cycle counter [low]									
7	TSYNC diagnostic status								Error information	

Structure of error information: TSYNC diagnostic status

Bit		Meaning
Bit 0	1	T_{DP} violation detected in the cycle (see cycle counter)
	0	No T_{DP} violation detected
Bit 1	1	T_{DX} violation detected in the cycle (see cycle counter)
	0	No T_{DX} violation detected
Bit 2	1	TSYNC parameter block error (times are not correct)
	0	TSYNC parameter block without error
Bits 3 to 7	0	Reserved

Structure of input data: TSYNC diagnostic module

In order to establish a defined assignment from the diagnostic event to the relevant cycle, the cycle counter and a status byte can be displayed in the input area of the diagnostic repeater through the TSYNC diagnostic module.

The input data of the diagnostic repeater with the configured TSYNC diagnostic module are structured as follows:

Byte	MSB	6	5	4	3	2	1	LSB	
	7							0	
1	Cycle counter [high]								Cycle counter
2	Cycle counter [low]								
3	TSYNC diagnostic status								Error information

The TSYNC diagnostic module has an output byte whose content is not evaluated. This is required for the detection of the T_{DX} violation.

7.3 Reading data out in the user program

The topology table, the diagnostic buffer, and the statistics buffer can be read out in the user program using SFC 59 "RD_REC" or SFB 52 "RDREC".

7.3.1 Topology table

Records

Record number (hex)	Record number (dec)	Writable/readable W / R	Function
32H	50	R	1st part of the topology table Nodes 0 to 31; length = 170 bytes
33H	51	R	2nd part of the topology table Nodes 32 to 63; length = 170 bytes
34H	52	R	3rd part of the topology table Nodes 64 to 95; length = 170 bytes
35H	53	R	4th part of the topology table Nodes 96 to 126; length = 165 bytes

Structure of the topology table

	Topology table record x	Number of bytes
	Constant 02	1 byte
	Status information ¹	1 byte
	Time stamp ²	8 bytes
Topology entry x	Status/substatus	1 byte
	Distance (in decimeters)	2 bytes
	Segment	1 byte
	DR information	1 byte
Topology entry x + 1	...	
Topology entry	
Topology entry x + n (n = max. 32)	...	

1 The status information is only contained in the first record. In the other records of the topology table this byte is occupied with 00H.

2 The time stamp is only contained in the first record. In the other records of the topology table this entry is occupied with 00H.

Status information

Bit 0	1	Topology determination on segment DP2 or DP2 OFF
	0	Topology determination on segment DP2 ON
Bit 1	1	Topology determination on segment DP3 OFF
	0	Topology determination on segment DP3 ON
Bit 2	1	Segment DP3 OFF
	0	Segment DP3 ON
Bit 3	0	Reserved
Bit 4	0	No topology data available.
	1	Topology data available in the topology table.
Bits 5 to 7	0	Reserved

Time stamp

Byte	Time stamp		Format
	Bits 4-7	Bits 0-3	
x	Year	Year	BCD
x+1	Month	Month	BCD
x+2	Day	Day	BCD
x+3	Hour	Hour	BCD
x+4	Minute	Minute	BCD
x+5	Second	Second	BCD
x+6	Millisecond (high)	Millisecond	BCD
x+7	Millisecond (low)	Day of the week: 1 = Sunday 2 = Monday 3 = Tuesday 4 = Wednesday 5 = Thursday 6 = Friday 7 = Saturday	BCD

Status/substatus

MSB							LSB
7	6	5	4	3	2	1	0
0	0	S1	S0	D11	D10	D9	0

Status		Substatus				
S1	S0	D11	D10	D9	Status of the node	Substatus
0	0	–	–	–	"Open"	For example, node is currently being measured.
0	1	0	0	0	Node not found	Node is connected at another segment.
0	1	0	0	1	Node not found	Distance is too great.
0	1	0	1	0	Node not found	Node not responding.
0	1	1	0	0	Node not found	Response indicates node cannot be measured or does not exist.
1	0	–	–	–	Node found	Node could not be measured. The entry Distance contains the distance to the diagnostic repeater.
1	1	–	–	–	Reserved	–

– Not relevant

Distance

The distance (i.e. the distance of a node) is specified in the topology table in decimeters. The high-byte portion is stored in byte x and the low-byte portion is stored in byte x+1.

Segment

MSB							LSB
7	6	5	4	3	2	1	0
0	0	0	0	0	0	SG1	SG0

Segment	SG1	SG0
DP1	0	1
DP2	1	0
DP3	1	1
Programming device interface	0	0

DR information

MSB							LSB
7	6	5	4	3	2	1	0
DS1	DS0	ME	KF	0	0	0	DR

DR - Diagnostic repeater

This bit is set when the response of a diagnostic repeater has been received.

KF - Cascade depth error

This bit is relevant only when DR=1. In this case, the relevant node is a diagnostic repeater where the maximum permissible cascade depth has been exceeded.

ME - Measuring circuit

This bit is relevant only when DR=1. In this case, the node is a diagnostic repeater connected to this diagnostic repeater and its segment SG1, SG0. If the bit is set, there are two measuring circuits in this segment.

DS0, DS1 - Diagnostic repeater segment

These bits are relevant only when DR=1. In this case, these bits indicate which segment of the other diagnostic repeater is connected to this diagnostic repeater.

Segment	DS1	DS0
DP1	0	1
DP2	1	0
DP3	1	1
Programming device interface	0	0

7.3.2 Diagnostic buffer

Records

Record number (hex)	Record number (dec)	Writable/readable W / R	Function
1EH	30	R	Diagnostic buffer DP1
1FH	31	R	Diagnostic buffer DP2
20H	32	R	Diagnostic buffer DP3
21H	33	R	Diagnostic buffer PG (programming device)

Structure of the diagnostic buffer

For each PROFIBUS segment the diagnostic repeater supplies a diagnostic buffer in which the last 10 events are stored together with their date and time.

	Diagnostic buffer DPx	Number of bytes
	Constant 02	1 byte
	Status information	1 byte
	Segment data	1 byte
	Number of entries	1 byte
Entry 1	Time stamp	8 bytes
	Diagnostic entry x	15 bytes
Entry 2	Time stamp	8 bytes
	Diagnostic entry x+1	15 bytes
Entry ...	Time stamp	8 bytes
	Diagnostic entry ...	15 bytes
Entry x + n (n = max. 10)	Time stamp	8 bytes
	Diagnostic entry y	15 bytes

Status information

Bit 0	1	Topology determination on segment DP2 OFF
	0	Topology determination on segment DP2 ON
Bit 1	1	Topology determination on segment DP3 OFF
	0	Topology determination on segment DP3 ON
Bit 2	1	Segment DP3 OFF
	0	Segment DP3 ON
Bit 3	1	Segment disturbed (at least one incoming error has yet not been reported as departed)
	0	Segment not disturbed (all errors departed)
Bit 4 to 7	0	Reserved

The status information is kept in accordance with the segment affected.

Segment	Bit 0	Bit 1	Bit 2	Bit 3
DP1	0	0	0	1/0
DP2	1/0	0	0	1/0
DP3	0	1/0	1/0	1/0
Programming device interface	0	0	0	1/0

Segment data

Bit 0 to 3	0	Reserved
Bit 4	1	Segment: DP3
Bit 5	1	Segment: DP2
Bit 6	1	Segment: DP1
Bit 7	1	Programming device interface

Number of entries

The "Number of entries" parameter indicates how many entries are contained in the buffer. This information is necessary since, for a read request of 240 bytes, the diagnostic repeater always returns the full length of 234 bytes, regardless of the number of entries that exist.

If a read request is made and there is no entry in the buffer, the parameter "Number of entries" = 0, and the other bytes are filled with "0".

Time stamp

Time stamp		Number of bytes
Bits 4-7	Bits 0-3	
Year	Year	1 byte
Month	Month	1 byte
Day	Day	1 byte
Hour	Hour	1 byte
Minute	Minute	1 byte
Second	Second	1 byte
Millisecond (high)	Millisecond	1 byte
Millisecond (low)	Day of the week: 1 = Sunday 2 = Monday 3 = Tuesday 4 = Wednesday 5 = Thursday 6 = Friday 7 = Saturday	1 byte

Diagnostic entry

Byte	MSB								LSB	
	7	6	5	4	3	2	1	0		
1	Segment				res.	res.	res.	I/O	Error information	
2	Version		res.	res.	LD	Topology ON/OFF	Segment ON/OFF	res.		
3	Fault rate									
4	Node x								Fault location	
5	Node y									
6	Distance [0] from station x (high byte)									
7	Distance [1] from station x (low byte)									
8	Distance [0] from station y (high byte)									
9	Distance [1] from station y (low byte)									
10	Distance [0] from the diagnostic repeater (high byte)									
11	Distance [1] from the diagnostic repeater (low byte)									
12	A.7	A.6	A.5	A.4	A.3	A.2	A.1	A.0	Error cause	
13	B.7	B.6	B.5	B.4	B.3	B.2	B.1	B.0		
14	C.7	C.6	C.5	C.4	C.3	C.2	C.1	C.0		
15	res.									

I/O Diagnostic event **incoming** (0)/**outgoing** (1)

res. Reserved bits are occupied with "0".

The meaning of the remaining bits is described in Section 7.2.6.

7.3.3 Statistics buffer

Records

Record number (hex)	Record number (dec)	Writable/readable W / R	Function
28H	40	R	Reflection error rate DP2
29H	41	R	Message frame error rate DP2
2AH	42	R	Reflection error rate DP3
2BH	43	R	Message frame error rate DP3

Structure of the statistics buffer

	Statistics buffer DPx	Number of bytes
	Constant 02	1 byte
	Status information	1 byte
	Segment data	1 byte
	Number of entries	1 byte
Entry 1	Time stamp	8 bytes
	Statistics entry x	1 byte
Entry 2	Time stamp	8 bytes
	Statistics entry x+1	1 byte
Entry ...	Time stamp	8 bytes
	Statistics entry ...	1 byte
Entry x + n (n = max. 26)	Time stamp	8 bytes
	Statistics entry y	1 byte

Status information

Bit 0	1	Topology determination on segment DP2 or DP2 OFF
	0	Topology determination on segment DP2 ON
Bit 1	1	Topology determination on segment DP3 OFF
	0	Topology determination on segment DP3 ON
Bit 2	1	Segment DP3 OFF
	0	Segment DP3 ON
Bit 3	1	Segment disturbed (at least one incoming error has yet not been reported as departed)
	0	Segment not disturbed (all errors departed)
Bit 4 to 7	0	Reserved

The status information is kept in accordance with the segment affected.

Segment	Bit 0	Bit 1	Bit 2	Bit 3
DP1	0	0	0	1/0
DP2	1/0	0	0	1/0
DP3	0	1/0	1/0	1/0
Programming device interface	0	0	0	1/0

Segment data

Bit 0 to 3	0	Reserved
Bit 4	1	Segment: DP3
Bit 5	1	Segment: DP2
Bit 6	1	Segment: DP1
Bit 7	1	Programming device interface

Number of entries

The "Number of entries" parameter indicates how many entries are contained in the buffer. This information is necessary since, for a read request of 240 bytes, the diagnostic repeater always returns the full length of 238 bytes, regardless of the number of entries that exist.

If a read request is made and there is no entry in the buffer, the parameter "Number of entries" = 0, and the other bytes are filled with "0".

Time stamp

Byte	Time stamp		Format
	Bits 4-7	Bits 0-3	
x	Year	Year	BCD
x+1	Month	Month	BCD
x+2	Day	Day	BCD
x+3	Hour	Hour	BCD
x+4	Minute	Minute	BCD
x+5	Second	Second	BCD
x+6	Millisecond (high)	Millisecond	BCD
x+7	Millisecond (low)	Day of the week: 1 = Sunday 2 = Monday 3 = Tuesday 4 = Wednesday 5 = Thursday 6 = Friday 7 = Saturday	BCD

Statistics entry

The statistics entry contains the number of errored message frames as a percentage.

The statistics entries are formed as follows:

Reflection error rate =

Message frames with reflections/number of message frames sent * 100

Message frame error rate =

Message frames with bit errors/number of message frames received * 100

The entries in the statistics buffer (message frame and reflection errors) occur at regular intervals. The following update times apply between two entries, depending on the baud rate:

Baud rate	Update time
12 Mbps	Approx. 300 ms
1.5 Mbps	Approx. 180 ms
500 kbps	Approx. 1.54 s
187.5 kbps	Approx. 1.54 s
19.2 kbps	Approx. 3.2 s
9.6 kbps	Approx. 3.2 s

7.4 Topology display in STEP 7

7.4.1 Topology data: bus topology and topology table

Bus topology

The bus topology contains the following information:

- Nodes (master, slaves, diagnostic repeaters)
- Distance of the nodes from the diagnostic repeaters

The following functions are available:

- Show/hide segments
- Search for nodes
- Select nodes

The bus topology can be printed out and exported as a CSV file.

Procedure

1. In STEP 7 select the DP master system whose data you want to read.
2. Start the function by choosing the menu command **View > Display > All Stations/Only Diagnostic Repeater with Stations/All Diagnostic Repeaters Only**.

Bus topology example

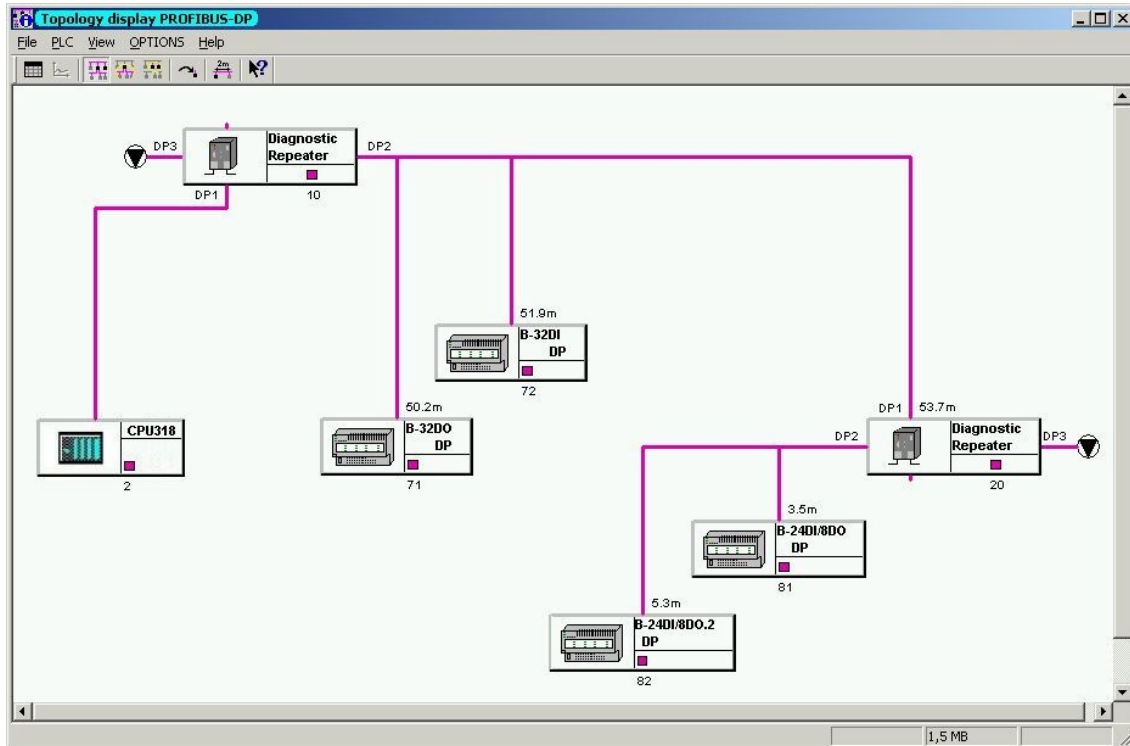

Topology table

The topology table contains the following information:

- PROFIBUS address of the node.
- The designation of the node, if ascertainable.
- Address of the associated diagnostic repeater to whose measurement segment the node is connected.
- Distance in relation to the associated diagnostic repeater.
- Segment of the diagnostic repeater to which the node is connected.
- The time at which the topology was last determined.

The topology table can be printed out. It can be exported as a CSV file and then read into Microsoft Excel and evaluated.

It can also be read out using the user program (see Section 7.3.1).

Procedure

1. In the topology display, select the diagnostic repeater whose data you want to read.
2. Start the function by choosing the **View > Topology table** menu command.

Topology table example

Address	Designation	DR	Distance	Segment	Topology determination
2	---	10	0m	DP1	1994.01.02 06:38:18:770
10	Diagnostic Repeater	20	0m	DP1	1994.01.02 06:46:25:710
20	Diagnostic Repeater	10	53.7m	DP2	1994.01.02 06:38:18:770
71	B-32DO DP	10	50.2m	DP2	1994.01.02 06:38:18:770
72	B-32DI DP	10	51.9m	DP2	1994.01.02 06:38:18:770
81	B-24DI/8DO DP	20	3.5m	DP2	1994.01.02 06:46:25:710
82	B-24DI/8DO.2 DP	20	5.3m	DP2	1994.01.02 06:46:25:710

7.4.2 Diagnostic buffer

For each of segments DP1, DP2, and DP3 as well as the programming device interface, the diagnostic repeater contains a diagnostic buffer in which the last 10 results are saved. The buffer contains the time, date, and a brief description of the results. Incoming errors are marked with K or I, and outgoing errors are marked with G or O.

The diagnostic buffers can be printed out. They can be exported as a CSV file and then read into Microsoft Excel and evaluated.

The diagnostic buffers can also be read out using the user program (see Section 7.3.2).

Procedure

1. In the topology display, select the diagnostic repeater whose data you want to read.
2. Start the function by choosing the **Options > Diagnostic buffer** menu command.

Diagnostic buffer example

Diagnostic buffer - DIAGNOSTIC REPEATER (10)

DP1 DP2 DP3 PG

Events:

No.	Time of day	Date	I,O	Event
1	06:55:10	1994.01.02	O	Break on signal line A and/or B or the terminator is missing.
2	06:42:18	1994.01.02	I	Break on signal line A and/or B or the terminator is missing.
3	06:42:18	1994.01.02	I	Break on signal line A and/or B or the terminator is missing.
4	06:42:17	1994.01.02	I	Break on signal line A and/or B or the terminator is missing.
5	06:36:07	1994.01.02	O	Break on signal line A.
6	06:36:05	1994.01.02	O	Break on signal line A and/or B or the terminator is missing.
7	06:35:59	1994.01.02	I	Break on signal line A and/or B or the terminator is missing.
8	06:35:58	1994.01.02	I	Break on signal line A and/or B or the terminator is missing.
9	06:27:41	1994.01.02	O	Short-circuit on signal line A and/or B or an additional terminator is activated.
10				

Detailed display for the selected event (Event leaving state):

Error location:

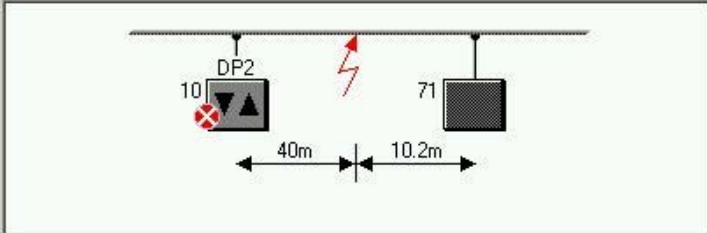

Error:

Break on signal line A and/or B or the terminator is missing.
Reflection error rate is 100%

Remedy:

Check the PROFIBUS cable for the problem at the indicated distance from the nodes shown.

Details...

Close Update Print... Export... Help

7.4.3 Statistics buffer

For each of segments DP2 and DP3 the diagnostic repeater contains a statistics buffer in which information on the reflection error rate and message frame error rate is saved.

Reflection errors occur, for example, when the signal is reflected by a disturbed or defective line.

Message frame errors are detected, for example, when message frames with parity errors occur. Parity errors can be caused by a defective node, for example.

The values are displayed for a period of 60 seconds as of the point at which the dialog is opened. Other values are saved internally beyond this period.

The statistics buffers can be printed out. They can be exported as a CSV file and then read into Microsoft Excel and evaluated.

The statistics buffers can also be read out using the user program (see Section 7.3.3).

Procedure

1. In the topology display, select the diagnostic repeater whose data you want to read.
2. Start the function by choosing the **Options > Statistics** menu command.

Procedure in the event of line problems

If there are line problems, change to the diagnostic buffer to get information on the location and cause of the problem.

Statistics buffer example

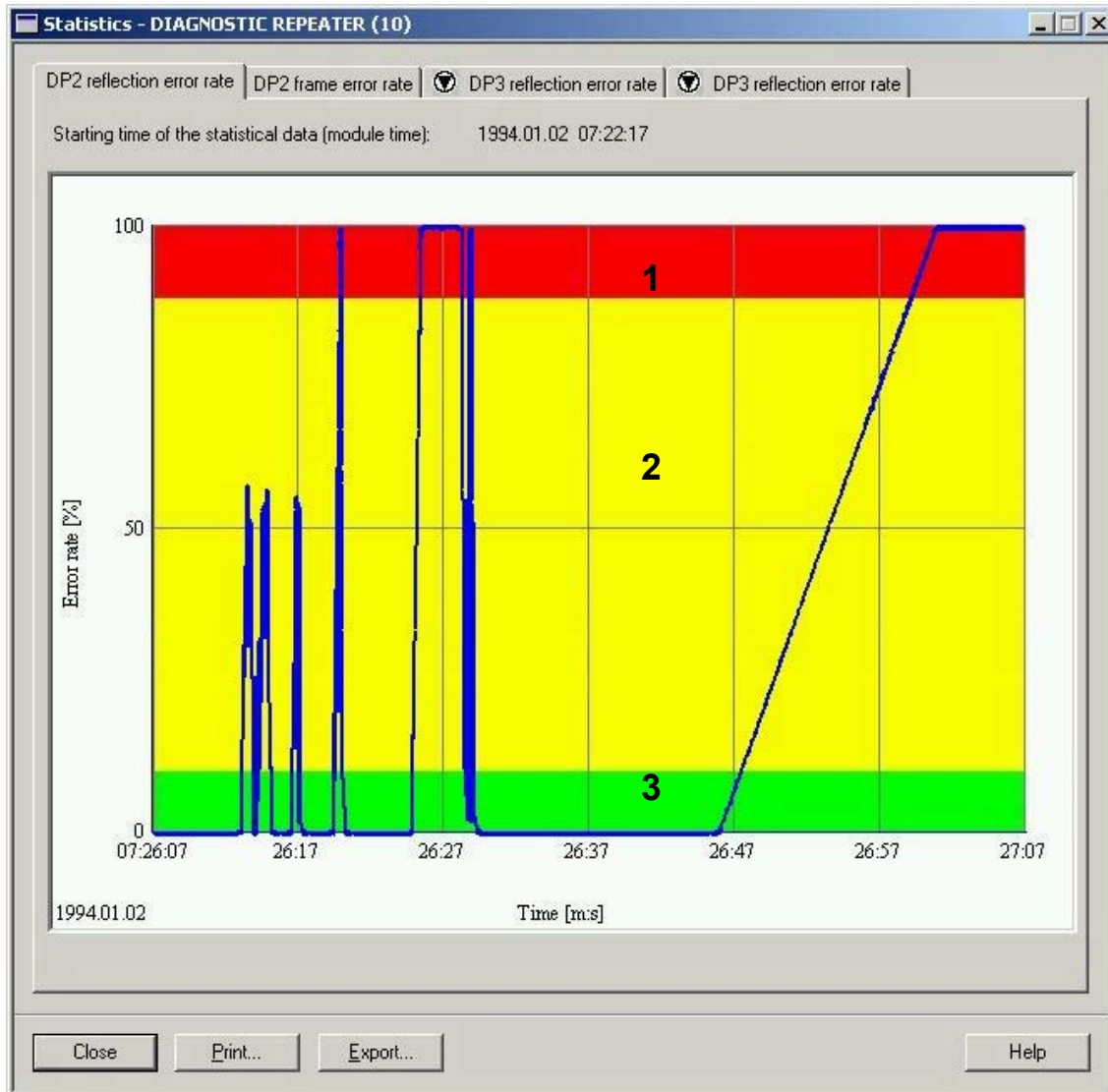

The statistics buffer reflects the quality of the bus system:

- (1) There are too many problems on the line. Operation of the segment is no longer possible.
 - (2) There are problems on the line. Operation of the segment is still possible. However, it is possible that nodes may fail.
 - (3) There are few problems on the line. Operation of the segment is optimal.
- In addition, the color coding helps you estimate the severity of the problems.

7.4.4 Error messages

Example of an error message

The figure below indicates how an error message is structured in STEP 7.

The tab cards DP1, DP2, DP3 and PG each contain the diagnostic information for the corresponding segment. An icon indicates whether the segment is faulty or not and whether it is de-activated.

Three output fields contain graphic and text information on the fault location, type of fault, remedy and, if appropriate, information on the reflection fault rate.

The "Details" command button leads to further information on the faults, fault cause and remedy.

The screenshot displays the 'Module Information - Diagnostic Repeater ONLINE' interface. At the top, the path is 'D:\SIMATIC300(1)\PB_Netz(4)' and the status is 'Error'. The CPU is in 'RUN' mode. The 'DP Slave Diagnostics' tab is active, showing four segments: DP1 (OK), DP2 (Faulty), DP3 (OK), and PG (OK). The 'Error location' field shows a graphical representation of a bus segment with three DP slaves (16, 3, 6) and their distances (25m, 22m, 3m). A red lightning bolt indicates a fault on the line between DP2 and DP3. The 'Error' field contains the message: 'Short-circuit to shield on signal line A. Reflection error rate is 100%'. The 'Remedy' field contains the instruction: 'Check the fault in the area indicated as the fault location in the segment.' The 'Details...' button is visible at the bottom right of the main content area. The bottom of the window has 'Close', 'Update', 'Print...', and 'Help' buttons.

Fault location: how exact is the distance information?

All distance specifications have a tolerance of ± 1 m. The error can therefore also have occurred at neighboring nodes which lie within the tolerance to the specified node.

Reflection fault rate

The reflection fault rate specifies the number of messages at which a reflection occurred in the form of a percentage.

The reflection fault rate is indicated at the diagnostic messages.

7.5 Diagnostic messages and fault elimination

7.5.1 Design guidelines not observed

The following tables contain the diagnostic messages which are displayed in STEP 7 and COM PROFIBUS.

More than 32 nodes are connected to the measuring segment

Description	Remedy
<p>A maximum of 32 nodes may be connected at a PROFIBUS segment. If this maximum is exceeded, the message traffic in this segment is no longer ensured. The diagnostic repeater itself also counts as a node.</p> <p>Note: The SF LED shines red as soon as topology determination has been carried out.</p>	<p>Reduce the number of nodes at this segment.</p> <p>If you use a further diagnostic repeater, you can create two further segments for 31 nodes each. A maximum of 9 diagnostic repeaters can be connected in series.</p> <p>Carry out the topology determination again after completing the changes.</p>
<p>If, contrary to the design guidelines of the diagnostic repeater, this segment contains a component with repeater function, such as an RS 485 repeater or an Optical Link Module (OLM), the nodes behind it are counted as well. This then also causes a fault message.</p> <p>Note: The line diagnostic only functions up to the component with repeater function. Every downstream node is indicated with the distance of the component with repeater function.</p>	<p>Suppressing the fault message: In this case, you can suppress the error message by switching off topology determination for this segment when configuring the diagnostic repeater (see Section 6.3.2).</p>

The maximum permitted number of diagnostic repeaters connected in series is exceeded

Description	Remedy
<p>A maximum of 9 diagnostic repeaters can be connected in series.</p> <p>Note: The SF LED shines red as soon as topology determination has been carried out.</p>	<p>Limit the number of diagnostic repeaters connected in series to a maximum of 9.</p> <p>Carry out the topology determination again after completing the changes.</p>

The distance of the node to the diagnostic repeater exceeds the permitted line length

Description	Remedy
<p>The diagnostic repeater signals when a node is too far away from it.</p> <p>Note: The SF LED shines red as soon as topology determination has been carried out.</p>	<p>Insert one or more diagnostic repeaters into the segment so that the maximum line length which is permissible and can be monitored of 100 m per segment is not exceeded.</p>

More than one measurement circuit in segment

Description	Remedy
<p>A further diagnostic repeater with the interface DP2 or DP3 is connected.</p> <p>The diagnostic repeater has two interfaces with measuring circuits (DP2 and DP3) and an interface without measuring circuit (DP1). No further measuring circuit may be connected to segment DP2 or DP3. Further diagnostic repeaters may only still be connected with the interface DP1.</p> <p>Note: The SF LED shines red as soon as topology determination has been carried out.</p>	<p>Change the network design so that further diagnostic repeaters at this segment are only connected with the interface DP1.</p> <p>The programming device interface may only be used to connect a programming device.</p>

7.5.2 Message frame error rate in the segment is critical

Description	Remedy
This fault occurs when the message traffic is no longer free of errors, e.g. due to faulty bits. In this case the data exchange is no longer ensured.	<p>Check whether the PROFIBUS cable conforms to the design guidelines (e.g. shielding, grounding and terminators, see Section 3.1) and that there are no loose contacts.</p> <p>Hint: The cause of the fault can possibly be isolated by checking the segment section-by-section. To do so, cut in the terminator at the PROFIBUS connectors so that the outgoing line is separated.</p>
Possible causes:	
<ul style="list-style-type: none"> • Several nodes have the same PROFIBUS address. 	Correct the PROFIBUS addresses of the nodes. Typically the set PROFIBUS address is not accepted by the node until after a Power OFF/ON.
<ul style="list-style-type: none"> • Nodes at this segment operate with different baud rates. Not all the PROFIBUS nodes find the baud rate automatically. 	Check whether all the bus nodes in this segment operate with the same baud rate. Set the baud rate at the node and/or in the configuration correctly. At some devices the baud rate is set by means of switches on the device or configuration.
<ul style="list-style-type: none"> • Defective PROFIBUS interface at a node. 	
<ul style="list-style-type: none"> • The PROFIBUS interface can be damaged by potential differences or overvoltages. 	Check whether a sufficiently high equipotential bonding is installed in order to avoid equipotential differences.
<ul style="list-style-type: none"> • Electromagnetic interference. 	Eliminate any possible sources of electromagnetic interference.

7.5.3 Break in the signal wire A or B

Description	Remedy
<p>A wire break has occurred at the displayed location.</p> <p>Possible causes:</p> <ul style="list-style-type: none"> • Damaged wire (e.g. high mechanical stress, vibration, bending radius too narrow), • A signal wire not connected properly in the PROFIBUS connector, • Mechanical stress can cause the signal wires in the PROFIBUS connector to break or no longer to contact, • Defective PROFIBUS connector. 	<p>In the area of the displayed fault location check the segment for:</p> <ul style="list-style-type: none"> • Damage to the wire, • Correct mounting of the PROFIBUS connectors/connections, • Defective PROFIBUS node (e.g. through the device being switched off or my removing the PROFIBUS connector).

7.5.4 Short circuit in the signal wire A and B or short circuit in the signal wire A or B to screen

Description	Remedy
<p>A wire short circuit has occurred at the displayed location.</p> <p>Possible causes:</p> <ul style="list-style-type: none"> • Damaged wire (e.g. high mechanical stress, vibration, pinching, bending radius too narrow), • Signal wires not connected properly in the PROFIBUS connector, • Ingress of conductive liquids, • Badly stripped or loose braided shield contacts the signal wire, • Defective PROFIBUS interface at the connected node, • Existing spur lines. 	<p>In the area of the displayed fault location check the segment for:</p> <ul style="list-style-type: none"> • Damage to the wire, • Correct mounting of the PROFIBUS connectors connections, • Defective PROFIBUS node (e.g. through the device being switched off or my removing the PROFIBUS connector), • Spur lines.

7.5.5 Terminator

Description	Remedy
Terminator missing: Terminator was not connected at a node.	Connect the terminator at the respective node.
Additional terminator inserted: Terminator was connected at a node at which it is not permitted. This fault is recognized as a wire short circuit.	Disconnect the terminator at the respective node.

7.5.6 Segment of diagnostic repeater de-activated automatically

Description	Remedy
The segment was de-activated automatically by the diagnostic repeater because no correct messages could be recognized.	Check the segment for:
<p>a) No signal level recognizable (permanent zero) on the PROFIBUS line. This means that no messages are received.</p> <p>Possible causes:</p> <ul style="list-style-type: none"> • Short circuit in signal line A and B. • Defective PROFIBUS interface at a node. 	<ul style="list-style-type: none"> • Damage to the wire, • Correct mounting of the PROFIBUS connectors/connections, • Defective PROFIBUS node (e.g. through the device being switched off or my removing the PROFIBUS connector).
<p>b) The signal level. This means that no correct messages can be recognized.</p> <p>Possible causes:</p> <ul style="list-style-type: none"> • Short circuit in signal line A and B, • Defective PROFIBUS interface at a node, • Nodes which operate with different baud rates, • Electromagnetic interference. 	<ul style="list-style-type: none"> • Damage to the wire, • Correct mounting of the PROFIBUS connectors/connections, • Defective PROFIBUS node (e.g. through the device being switched off or the PROFIBUS connector being removed), • Set the baud rate at the node and/or in the configuration correctly. At some devices the baud rate is set by means of switches on the device or configuration. • Eliminate any possible sources of electromagnetic interference. <p>The segment is activated automatically by the diagnostic repeater as soon as correct messages are recognized again.</p> <p>Hint: Check the segment section-by-section in order to isolate the fault location. To do so, cut in the terminator at the PROFIBUS connectors so that the outgoing line is separated.</p>

7.5.7 Fault cause or fault location not clear

The cause of the fault in the segment is not clear

Description	Remedy
<p>The reflection does not allow a clear fault recognition.</p> <p>There may be a loose contact or a multiple fault.</p>	<p>In the area of the displayed fault location check the segment for:</p> <ul style="list-style-type: none"> • Damage to the wire, • Correct mounting of the PROFIBUS connectors/connections, • Defective PROFIBUS node (e.g. through the device being switched off or the PROFIBUS connector being removed).

The location and cause of the fault in the segment are not clear

Description	Remedy
<p>The reflection does not allow a clear fault recognition.</p> <p>There may be a loose contact or an electromagnetic interference.</p>	<p>Check whether the segment corresponds to the specified guidelines (e.g. shielding, grounding or terminators, see Section 3.1).</p> <p>Hint:</p> <p>Check the segment section-by-section in order to isolate the fault location. To do so, cut in the terminator at the PROFIBUS connectors so that the outgoing line is separated.</p>

7.5.8 Fault cannot be evaluated

Description	Remedy
<p>The diagnostic repeater signals faults which cannot be displayed by the version used of the configuration software.</p> <p>The error types A.1, A.5, etc. are reserved for future enhancements.</p>	<p>Update your configuration software.</p>

7.5.9 Topology determination not possible

Errors in topology determination with STEP 7 or SFC 103 "DP_TOPOLOG" are displayed in conjunction with the diagnostic repeater with the order number 6ES7972-0AB01-0XA0 and thus permit specific errors to be corrected.

- The list of "affected" diagnostic repeaters and the affected segment are displayed in STEP 7.
- When an S7 CPU is used with the integrated system function SFC 103 "DP_TOPOLOG", the diagnostic repeater with the lowest address that has an error is output in the user program.

This display is not possible with COM PROFIBUS or the diagnostic repeater with the order number 6ES7972-0AB00-0XA0.

8 Technical Specifications

8.1 Standards and approvals

CE marking



Our products fulfill the requirements and protective aims of the following EU guidelines and conform to the harmonized European Standards (EN) which were published for programmable logic controllers in the gazettes of the European Union:

73/23/EEC "Electrical equipment for use within certain voltage limits" (low-voltage guideline)

89/336/EEC "Electromagnetic compatibility" (EMC guideline)

94/9/EC "Equipment and protective systems for use in explosive atmospheres" (explosion protection guideline)

The EU declarations of conformity are kept available for the corresponding authorities at:

Siemens Aktiengesellschaft
Bereich Automatisierungs- und Antriebstechnik
A&D AS RD 4
Postfach 1963
D-92209 Amberg

Underwriters Laboratories Inc. in accordance with



1. UL 508 (Industrial Control Equipment)
2. CSA C22.2 No. 142 (Process Control Equipment)
3. UL 1604 (Hazardous Location)
4. CSA-213 (Hazardous Location)

APPROVED for use in
Class I, Division 2, Group A, B, C, D T4A;
Class I, Zone 2, Group IIC T4

Note

You will find the currently valid certificates and approvals on the type plate of the diagnostic repeater.

FM approval



Factory Mutual Research (FM) in accordance with
Approval Standard Class Number 3611, 3600, 3810

APPROVED for use in
Class I, Division 2, Group A, B, C, D T4A
Class I, Zone II, Group IIC T4



In accordance with EN 50021 (Electrical apparatus for potentially explosive
atmospheres; Type of protection "n")



II 3 G EEx nA II T4

Marking for Australia



The diagnostic repeater fulfills the requirements of the standard
AS/NZS 2064 (Class A).

IEC 61131

The diagnostic repeater fulfills the requirements and criteria of the IEC 61131-2
standard (Programmable controllers, Part 2: Equipment requirements and tests).

PROFIBUS-DP

The diagnostic repeater fulfills the requirements and criteria of the PROFIBUS-
DPV1 standard in accordance with IEC 61158:Ed3 Type 3 or
IEC 61784-1:2002 Ed1 CP 3/1.

Approval for shipbuilding

Classification organizations:

ABS (American Bureau of Shipping)

BV (Bureau Veritas)

DNV (Det Norske Veritas)

GL (Germanischer Lloyd)

LRS (Lloyds Register of Shipping)

Class NK (Nippon Kaiji Kyokai)

Use in industrial environments

SIMATIC products are designed for the use in industrial environments.

Area of application	Requirements	
	Emitted interference	Noise immunity
Industry	EN 61000-6-4: 2001	EN 61000-6-2: 2001

Use in residential environments

If you use the diagnostic repeater in residential areas, you must ensure it meets the requirements of limit value class B in accordance with EN 55011 with regard to the emission of radio interference.

Suitable measures for meeting the requirements of limit value class B are:

Installation of the diagnostic repeater in grounded switch cabinets/boxes

Use of filters in supply lines



Warning

Damage to persons and material can occur.

In hazardous areas damage to persons and material can occur if you disconnect connectors while operation is running.

Always de-energize the diagnostic repeater in hazardous areas before separating connectors.

8.1.1 Electromagnetic compatibility of the diagnostic repeater

Definition

The electromagnetic compatibility is the ability of an electrical device to function satisfactorily in its electromagnetic environment without influencing this environment.

The diagnostic repeater also fulfills the requirements of the EMC legislation of the European Union.

The following sections provide information on the immunity to interference and on the interference suppression.

Pulse-shaped interferences

The following table shows the electromagnetic compatibility of the diagnostic repeater with regard to the pulse-shaped interferences. Prerequisite is that the system conforms to the specification and guidelines on electrical design.

Pulse-shaped interference	Tested with	Corresponds to severity
Electrostatic discharge in accordance with IEC 61000-4-2	8 kV 4 kV	3 (air discharge) 2 (contact discharge)
Burst pulse (rapid transient disturbances) to IEC 61000-4-4	2 kV (supply cable) 2 kV (signal cable)	3
Surge to IEC 61000-4-5 Only with protective elements <ul style="list-style-type: none"> • Asymmetrical coupling • Symmetric coupling 	2 kV (supply cable) 2 kV (signal line/data line) 1 kV (supply line) 1 kV (signal line/data line)	3

Sine-shaped interference

RF irradiation to the device in accordance with IEC 61000-4-3:

Electromagnetic RF field, amplitude-modulated

- From 80 to 1000 MHz
- 10 V/m
- 80% AM (1 kHz)

Electromagnetic RF field, pulse-modulated

- 900 \pm 5 MHz
- 10 V/m
- 50% ED
- 200 Hz repetition frequency

RF interference on signal and data cables, etc. to IEC 61000-4-6:

Radio frequency, asymmetrical, amplitude-modulated

- From 0.15 to 80 MHz
- 10 V root-mean-square value, unmodulated
- 80% AM (1 kHz)
- 150 Ohm source impedance

Emission of radio interferences

Emitted interference of electromagnetic fields in accordance with EN55011:
Limit value class A, group 1 (measured at a distance of 30 m)

From 20 to 230 MHz < 30 dB (μ V/m)Q

From 230 to 1000 MHz < 37 dB (μ V/m)Q

Emitted interference via a.c. supply current to EN 55011: Limit value A, Group 1.

From 0.15 to 0.5 MHz < 79 dB (μ V)Q, < 66 dB (μ V)M

From 0.5 to 5 MHz < 73 dB (μ V)Q, < 60 dB (μ V)M

From 5 to 30 MHz < 73 dB (μ V)Q, < 60 dB (μ V)M

8.1.2 Mechanical and climatic ambient conditions for transportation and storage

Diagnostic repeater

The diagnostic repeater exceeds the requirements of IEC 61131-2 with regard to shipping and storage conditions. The following information applies to diagnostic repeaters that are transported and stored in the original packaging.

Ambient conditions	Range of application	Remarks
Free fall	0.3 m	–
Temperature	From -40 to 70°C	–
Relative humidity	From 5 to 95 %	Without condensation
Air pressure	From 1080 to 660 hPa	Corresponds to a height of -1000 to 3500 m

8.1.3 Mechanical and climatic ambient conditions in operation

Conditions of use

The diagnostic repeater is intended for sheltered stationary use. The conditions of use exceed the requirements of IEC 61131-2.

The diagnostic repeater fulfills the conditions of use of Class 3C3 to DIN EN 60721 3-3 (points of use with high traffic density and directly adjacent to industrial plants with chemical emissions).

Limitations

The diagnostic repeater may **not** be used without additional measures

At sites with a high share of ionizing radiation

At sites with severe operation conditions, for example by

- Dust development
- Corrosive vapors or gases.

In plants which require particular monitoring, such as for example

- Elevator plants
- Electrical plants in particularly hazardous areas.

An additional measure for the use can be, for example, the installation of the diagnostic repeater in a cabinet.

Climatic environmental conditions

The diagnostic repeater may be used under the following ambient conditions:

Ambient conditions	Range of application	Remarks
Temperature: <ul style="list-style-type: none"> • Horizontal installation: • Vertical installation: 	From 0 to 60 °C From 0 to 40 °C	–
Relative humidity	From 5 to 95 %	Without condensation
Air pressure	From 1080 to 795 hPa	Corresponds to a height of –1000 to 2000 m
Pollutant concentration	SO ₂ : < 0.5 ppm; relative humidity < 60 %, no condensation H ₂ S: < 0.1 ppm; relative humidity < 60 %, no condensation	Test: 10 ppm; 4 days 1 ppm; 4 days

Mechanical ambient conditions

The mechanical ambient conditions of the diagnostic repeater are specified in the following table in the form of sinusoidal oscillation.

Frequency range (Hz)	Continuous	Occasional
10 ≤ f ≤ 58	0.0375 mm amplitude	0.075 mm amplitude
58 ≤ f ≤ 150	0.5 g constant acceleration	1 g constant acceleration

Reducing oscillations

If the diagnostic repeater is subject to larger impacts or oscillations, you have to take suitable measures to reduce the acceleration or the amplitude.

Tests for mechanical ambient conditions

The following table provides information on the type and extent of the tests for mechanical ambient conditions.

Test for	Test standard	Remarks
Oscillations	Oscillation test in accordance with IEC 68-2-6 (sine)	Vibration type: frequency sweeps with a rate of change of 1 octave per minute. 5 Hz \leq f \leq 9 Hz, constant amplitude 7 mm 9 Hz \leq f \leq 150 Hz, constant acceleration 2 g Vibration duration: 10 frequency sweeps per axis in each of the 3 vertically arranged axes
Bump	Impact test in accordance with IEC 68-2-27	Type of impact: half-sine Strength of impact: 15 g peak value, 11 ms duration Direction of impact: 3 impacts in +/- direction in each of the 3 axes vertical in relation to each other
Endurance bump	Impact test in accordance with IEC 68-2-29	Type of impact: half-sine Strength of impact: 25 g peak value, 6 ms duration Direction of impact: 1000 impacts in +/- direction in each of the 3 axes vertical in relation to each other

8.1.4 Information on nominal voltages, dielectric tests, safety class and degree of protection

Nominal voltages for operation

The diagnostic repeater works with a rated voltage of 24 VDC.
The tolerance range is 20.4 to 28.8 VDC.

Test voltages

The insulation resistance is checked in the routine test with a test voltage of 500 VDC in accordance with IEC 61131-2. Circuits with a rated voltage of U_e to other circuits or to ground: $0 \text{ V} < U_e \leq 50 \text{ V}$

Safety class

Safety class I in accordance with IEC 536 (VDE 0106-1), i.e. ground terminal to rail required.

Protection against foreign bodies and water

IP 20 protection in accordance with IEC 529, i.e. protection against contact with standard probes.

In addition: protected against solid bodies greater than 12.5 mm.

No particular protection against water.

8.2 Technical data of the diagnostic repeater

Dimensions and weight	
Dimensions W x H x D (mm)	
<ul style="list-style-type: none"> Without rail With rail 	80 x 125 x 66.3 80 x 125 x 72.2
Weight	Approximately 300 g
Module-specific data	
Bus protocol	PROFIBUS-DP
Transfer rate to PROFIBUS-DP	9.6 kbps to 12 Mbps
Maximum permissible deviation between bit-sending and bit-receiving timing	±0.3% at 9.6 kbps to 500 kbps ±0.03% at 1.5 Mbps to 12 Mbps
Maximum cascading depth	9 diagnostic repeaters
Redundant operation	No
Distance information for line diagnostics	
Resolution	0.5 m
Accuracy	±1 m
Clock	
Resolution	10 ms
Accuracy	Typically 5 s/h slow
Repeater throughput time	
<ul style="list-style-type: none"> Baud rates ≥ 1.5 Mbps Baud rates < 1.5 Mbps 	2.5 T _{BIT} + 153 ns 0.5 T _{BIT} + 173 ns
Jitter	1T = 1/48 MHz = 20.83 ns
Monitoring function of the clocked PROFIBUS bus system	
DP bus cycle (T _{DP})	min. 1 ms, max. 32 ms
Tolerance range T _{DP} monitoring	±2 μs
Tolerance range T _{DX} monitoring	±10 μs
Mechanical properties	
Mounting possibilities	DIN or S7-300 mounting rail
Degree of protection	IP20
Bus cables	
Termination system	Fast Connect (insulation piercing technique, 10 connecting cycles possible)
Suitable cables	SIMATIC NET PROFIBUS cables See Appendix A
Cables for power supply	
Termination system	Screw clamping
Suitable cables	Solid and flexible cables
<ul style="list-style-type: none"> Solid cable Flexible cable with wire end ferrule Flexible cable without wire end ferrule 	0.14 mm to 2.5 mm ² 0.25 mm to 1.5 mm ² 0.14 mm to 2.5 mm ²

Dimensions and weight	
Ambient conditions	
Operating temperature	
• Horizontal installation	0 to 60°C
• Vertical installation	0 to 40°C
Storage temperature	-40 to +70°C
Heat dissipation	Via housing without forced ventilation
Voltages, currents, potentials	
Nominal supply voltage	24 VDC
• Static limits	1. - 20.4 VDC to 28.8 VDC
• Dynamic limits	- 18.5 VDC to 30.2 VDC
• Reverse polarity protection	Yes
• Power failure overriding	5 ms
Control-to-load isolation	
• Between the power supply and the PROFIBUS-DP	Yes
• Between segments DP1 and DP2, DP3 and programming device interface	Yes
• Between segments DP2, DP3 and programming device interface	No
Insulation tested with	500 V DC
Power consumption at nominal voltage (24V DC)	
• Without load at programming device interface	150 mA
• Load at programming device interface (5V/90mA)	170 mA
• Load at programming device interface (24V/100mA)	250 mA
Power loss of the module	Typically 4 W
Status, alarms, diagnosis	
Status display	Yes
Alarms	None
Diagnostic function	Yes
• Group error	Red LED SF
• Bus fault	Red LED BF
• Repeater function monitoring	Green LED DR
• 24V voltage supply monitoring	Green LED ON
• Bus activity programming device	Yellow LED PG
• Bus activity segment DP1	Yellow LED DP1
• Bus activity segment DP2	Yellow LED DP2
• Bus activity segment DP3	Yellow LED DP3
• Monitoring segment DP2	Red LED ERR DP2
• Monitoring segment DP3	Red LED ERR DP3

8.3 Records used in the diagnostic repeater

The table contains the records of the diagnostic repeater with the order number 6ES7 972-0AB01-0XA0 that can be used by STEP 7 or in the user program. Other records cannot be used.

Record number (hex)	Record number (dec)	Writable/readable W / R	Function
1E _H	30	R	Diagnostic buffer DP1
1F _H	31	R	Diagnostic buffer DP2
20 _H	32	R	Diagnostic buffer DP3
21 _H	33	R	Diagnostic buffer PG (programming device)
28 _H	40	R	Reflection error rate DP2
29 _H	41	R	Message frame error rate DP2
2A _H	42	R	Reflection error rate DP3
2B _H	43	R	Message frame error rate DP3
32 _H	50	R	1st part of the topology table: nodes 0 to 31
33 _H	51	R	2nd part of the topology table: nodes 32 to 63
34 _H	52	R	3rd part of the topology table: nodes 64 to 95
35 _H	53	R	4th part of the topology table: nodes 96 to 126
3C _H	60	W / R	Time

The records can be accessed both via the C1 channel and the C2 channel on slot 0 or via the corresponding logical address (corresponds to the diagnostic address in STEP 7).

8.4 Use of the Diagnostic Repeater in a Zone 2 Hazardous Area 2

8.4.1 Einsatz des Diagnose-Repeaters im explosionsgefährdeten Bereich Zone 2

Zone 2

Explosionsgefährdete Bereiche werden in Zonen eingeteilt. Die Zonen werden nach der Wahrscheinlichkeit des Vorhandenseins einer explosionsfähigen Atmosphäre unterschieden.

Zone	Explosionsgefahr	Beispiel
2	explosive Gasatmosphäre tritt nur selten und kurzzeitig auf	Bereiche um Flanschverbindungen mit Flachdichtungen bei Rohrleitungen in geschlossenen Räumen
sicherer Bereich	nein	<ul style="list-style-type: none"> • außerhalb der Zone 2 • Standardanwendungen von dezentraler Peripherie

Nachfolgend finden Sie wichtige Hinweise für die Installation des Diagnose-Repeaters im explosionsgefährdeten Bereich.

Weitere Informationen

Weitere Informationen zum Diagnose-Repeater und zu den verschiedenen Komponenten finden Sie im Handbuch.

Fertigungsort

Siemens AG, Bereich A&D
 Werner-von-Siemens-Straße 50
 92224 Amberg
 Germany

Zulassung

 II 3 G EEx nA II T4 nach EN 50021 : 1999
 Prüfnummer: **KEMA 02ATEX1096 X**

Hinweis

Baugruppen mit der Zulassung  II 3 G EEx nA II T3 .. T6 dürfen nur in Automatisierungssysteme SIMATIC S7-300 / ET 200M der Gerätekategorie 3 eingesetzt werden.

Instandhaltung

Für eine Reparatur muss die betroffene Komponente an den Fertigungsort geschickt werden. Nur dort darf die Reparatur durchgeführt werden.

Besondere Bedingungen

1. Der Diagnose-Repeater muss in einen Schaltschrank oder ein metallisches Gehäuse eingebaut werden. Diese müssen mindestens die Schutzart IP 54 (nach EN 60529) gewährleisten. Dabei sind die Umgebungsbedingungen zu berücksichtigen, in denen das Gerät installiert wird. Für das Gehäuse muss eine Herstellererklärung für Zone 2 vorliegen (gemäß EN 50021).
2. Wenn am Kabel bzw. an der Kabeleinführung dieses Gehäuses unter Betriebsbedingungen eine Temperatur $> 70\text{ °C}$ erreicht wird oder wenn unter Betriebsbedingungen die Temperatur an der Aderverzweigung $> 80\text{ °C}$ sein kann, müssen die Temperatureigenschaften der Kabel mit den tatsächlich gemessenen Temperaturen übereinstimmen.
3. Die eingesetzten Kabeleinführungen müssen der geforderten IP-Schutzart und dem Abschnitt 7.2 (gemäß EN 50021) entsprechen.
4. Alle Geräte, einschließlich Schalter etc., die an den Ein- und Ausgängen von Diagnose-Repeatern angeschlossen werden, müssen für den Explosionsschutz Typ EEx nA oder EEx nC genehmigt sein.
5. Es müssen Maßnahmen getroffen werden, dass die Nennspannung durch Transienten um nicht mehr als 40 % überschritten werden kann.
6. Umgebungstemperaturbereich: 0 °C bis 60 °C
7. Innerhalb des Gehäuses ist an einem nach dem Öffnen gut sichtbaren Platz ein Schild mit folgender Warnung anzubringen:

Warnung

Das Gehäuse darf nur kurze Zeit geöffnet werden, z. B. für visuelle Diagnose. Betätigen Sie dabei keine Schalter, ziehen oder stecken keine Baugruppen und trennen keine elektrischen Leitungen (Steckverbindungen). Diese Warnung kann unberücksichtigt bleiben, wenn bekannt ist, dass keine explosionsgefährdete Atmosphäre herrscht.

Liste der zugelassenen Baugruppen

Die Liste mit den zugelassenen Baugruppen finden Sie im Internet:

<http://www4.ad.siemens.de/view/cs/>

unter der Beitrags-ID 13702947.

8.4.2 Use of the Diagnostic Repeater in a Zone 2 Hazardous Area

Zone 2

Hazardous areas are divided up into zones. The zones are distinguished according to the probability of the existence of an explosive atmosphere.

Zone	Explosion Hazard	Example
2	Explosive gas atmosphere occurs only seldom and for a short time	Areas around flange joints with flat gaskets in pipes in enclosed spaces
Safe area	No	<ul style="list-style-type: none"> • Outside zone 2 • Standard distributed I/O applications

Below you will find important information on the installation of the diagnostic repeater in a hazardous area.

Further Information

You will find further information on the diagnostic repeater and the various components in the manual.

Production Location

Siemens AG, Bereich A&D
 Werner-von-Siemens-Straße 50
 92224 Amberg
 Germany

Certification



II 3 G

EEx nA II T4

to EN 50021 : 1999

Test number: **KEMA 02ATEX1096 X**

Note

Modules with II 3 G EEx nA II T3 .. T6 certification can only be used in SIMATIC S7-300/ET 200M automation systems belonging to equipment category 3.

Maintenance

If repair is necessary, the affected component must be sent to the production location. Repairs can only be carried there.

Special Conditions

1. The diagnostic repeater must be installed in a cabinet or metal housing. These must comply with the IP 54 degree of protection as a minimum. The environmental conditions under which the equipment is installed must be taken into account. There must be a manufacturer's declaration for zone 2 available for the housing (in accordance with EN 50021).
2. If a temperature of $> 70\text{ °C}$ is reached in the cable or at the cable entry of this housing under operating conditions, or if a temperature of $> 80\text{ °C}$ can be reached at the junction of the conductors under operating conditions, the temperature-related properties of the cables must correspond to the temperatures actually measured.
3. The cable entries used must comply with the required IP degree of protection and Section 7.2 (in accordance with EN 50021).
4. All devices (including switches, etc.) that are connected to the inputs and outputs of fail-safe signal modules must be approved for EEx nA or EEx nC explosion protection.
5. Steps must be taken to ensure that the rated voltage through transients cannot be exceeded by more than 40 %.
6. Ambient temperature range: 0 °C to 60 °C
7. A sign containing the following warning must be put up inside the housing in an easily visible position when the housing is opened:

Warning

The housing can only be opened for a short time (e.g. for visual diagnostics). If you do this, do not operate any switches, remove or install any modules or disconnect any electrical cables (plug-in connections).
You can disregard this warning if you know that the atmosphere is not hazardous (i.e. there is no risk of explosion).

List of Approved Modules

You will find the list of approved modules under the ID 13702947 on the Internet:

<http://www4.ad.siemens.de/view/cs/>.

8.4.3 Utilisation du répéteur de diagnostic dans un environnement à risque d'explosion en zone 2

Zone 2

Les environnements à risque d'explosion sont répartis en zones. Les zones se distinguent par la probabilité de présence d'une atmosphère explosive.

Zone	Risque d'explosion	Exemple
2	Formation rare et brève d'une atmosphère gazeuse explosive	Environnement de raccords à joints plats dans le cas de conduites dans des locaux fermés
Zone sûre	Non	<ul style="list-style-type: none"> • A l'extérieur de la zone 2 • Utilisation standard de périphérie décentralisée

Vous trouverez ci-après des remarques importantes pour l'installation du répéteur de diagnostic dans un environnement présentant un risque d'explosion.

Informations complémentaires

Des informations complémentaires sur le répéteur de diagnostic et les diverses composantes se trouvent dans le manuel.

Lieu de production

Siemens AG, Bereich A&D
 Werner-von-Siemens-Straße 50
 92224 Amberg
 Germany

Homologation

 II 3 G EEx nA II T4 selon EN 50021 : 1999

Numéro de contrôle : **KEMA 02ATEX1096 X**

Nota

Les modules homologués  II 3 G EEx nA II T3 .. T6 ne peuvent être utilisés que dans des automates SIMATIC S7-300 / ET 200M de catégorie 3.

Entretien

Si une réparation est nécessaire, la composante concernée doit être expédiée au lieu de production. La réparation ne doit être effectuée qu'en ce lieu.

Conditions particulières

1. Le répéteur de diagnostic doit être installé dans une armoire ou un boîtier métallique. Ceux-ci doivent assurer au moins l'indice de protection IP 54. Il faut alors tenir compte des conditions d'environnement dans lesquelles l'appareil est installé. Le boîtier doit faire l'objet d'une déclaration de conformité du fabricant pour la zone 2 (selon EN 50021).
2. Si dans les conditions d'exploitation, une température $> 70\text{ °C}$ est atteinte au niveau du câble ou de l'entrée du câble dans ce boîtier, ou bien si la température au niveau de la dérivation des conducteurs peut être $> 80\text{ °C}$, les capacités de résistance thermique des câbles doivent correspondre aux températures effectivement mesurées.
3. Les entrées de câbles utilisées doivent avoir le niveau de protection IP exigé et être conformes au paragraphe 7.2 (selon EN 50021).
4. Tous les appareillages (y compris les interrupteurs, etc.) raccordés aux entrées et sorties de modules de signaux à sécurité intrinsèque doivent être homologués pour la protection antidéflagrante type EEx nA ou EEx nC.
5. Il faut prendre des mesures pour que la tension nominale ne puisse pas être dépassée de plus de 40% sous l'influence de transitoires.
6. Plage de température ambiante : 0 °C à 60 °C
7. A l'intérieur du boîtier, il faut placer, à un endroit bien visible après ouverture, une plaquette comportant l'avertissement suivant :

Avertissement

Ouvrir le boîtier le moins longtemps possible, par exemple pour effectuer un diagnostic visuel. Ce faisant, n'actionnez aucun commutateur, ne déconnectez aucun module et ne débranchez pas de câbles électriques (connexions). Le respect de cet avertissement n'est pas impératif s'il est certain que l'environnement ne présente pas de risque d'explosion.

Liste des modules homologués

Vous trouverez sur Internet la liste des modules homologués :

<http://www4.ad.siemens.de/view/cs/>

référence ID 13702947.

8.4.4 Aplicación del repetidor para diagnóstico en áreas con peligro de explosión, zona 2

Zona 2

Las áreas con peligro de explosión se clasifican en zonas. Las zonas se diferencian según la probabilidad de la existencia de una atmósfera capaz de sufrir una explosión.

Zona	Peligro de explosión	Ejemplo
2	La atmósfera explosiva de gas sólo se presenta rara vez y muy brevemente	Áreas alrededor de uniones abridadas con juntas planas en tuberías en locales cerrados
Área segura	no	<ul style="list-style-type: none"> • fuera de la zona 2 • Aplicaciones estándar de la periferia descentralizada

A continuación encontrará importantes informaciones para la instalación del repetidor para diagnóstico en áreas con peligro de explosión.

Otras informaciones

Encontrará otras informaciones relativas al repetidor para diagnóstico y a los distintos componentes en el Manual.

Lugar de fabricación

Siemens AG, Bereich A&D
 Werner-von-Siemens-Straße 50
 92224 Amberg
 Germany

Homologación

 II 3 G EEx nA II T4 según norma EN 50021 : 1999

Número de comprobación: **KEMA 02ATEX1096 X**

Nota

Los módulos con la homologación  II 3 G EEx nA II T3 .. T6 pueden utilizarse únicamente en los autómatas programables SIMATIC S7-300 / ET 200M de la categoría de equipo 3.

Mantenimiento

Para una reparación se ha de remitir el componente afectado al lugar de fabricación. Sólo allí se puede realizar la reparación.

Condiciones especiales

1. El repetidor para diagnóstico se ha de montar en un armario eléctrico de distribución o en una carcasa metálica. Éstos deben garantizar como mínimo el grado de protección IP 54. Para ello se han de tener en cuenta las condiciones ambientales, en las cuales se instala el equipo. La caja deberá contar con una declaración del fabricante para la zona 2 (conforme a EN 50021).
2. Si durante la operación se alcanzara una temperatura $> 70^{\circ}\text{C}$ en el cable o la entrada de cables de esta caja o bien una temperatura $> 80^{\circ}\text{C}$ en la bifurcación de hilos, deberán adaptarse las propiedades térmicas de los cables a las temperaturas medidas efectivamente.
3. Las entradas de cable utilizadas deben cumplir el grado de protección IP exigido y lo expuesto en el apartado 7.2 (conforme a EN 50021).
4. Todos los dispositivos –inclusive interruptores, etc.– conectados a las entradas y salidas de módulos de señales de alta disponibilidad deben estar homologados para la protección contra explosiones del tipo EEx nA o EEx nC.
5. Es necesario adoptar las medidas necesarias para evitar que la tensión nominal pueda rebasar en más del 40 % debido a efectos transitorios.
6. Margen de temperatura ambiente: 0°C hasta 60°C
7. Dentro de la caja deberá colocarse en un lugar perfectamente visible tras su apertura un rótulo con la siguiente advertencia:

Precaución

Abrir la caja sólo brevemente, p.ej. para el diagnóstico visual. Durante este tiempo Ud. no deberá activar ningún interruptor, desenchufar o enchufar módulos ni separar conductores eléctricos (conexiones enchufables). Esta advertencia puede ignorarse si Ud. sabe que en la atmósfera existente no hay peligro de explosión.

Lista de los módulos homologados

En la internet hallará Ud. una lista con los módulos homologados:

<http://www4.ad.siemens.de/view/cs/>

bajo el ID de asignación 13702947.

8.4.5 Impiego del repeater di diagnostica nell'area a pericolo di esplosione zona 2

Zona 2

Le aree a pericolo di esplosione vengono suddivise in zone. Le zone vengono distinte secondo la probabilità della presenza di un'atmosfera esplosiva.

Zona	Pericolo di esplosione	Esempio
2	L'atmosfera esplosiva si presenta solo raramente e brevemente	Aree intorno a collegamenti a flange con guarnizioni piatte nelle condotte in ambienti chiusi
Area sicura	No	<ul style="list-style-type: none"> • Al di fuori della zona 2 • Applicazioni standard di periferia decentrata

Qui di seguito sono riportate delle avvertenze importanti per l'installazione del repeater di diagnostica nell'area a pericolo di esplosione.

Ulteriori informazioni

Ulteriori informazioni sul repeater di diagnostica e sui diversi componenti si trovano nel manuale.

Luogo di produzione

Siemens AG, Bereich A&D
 Werner-von-Siemens-Straße 50
 92224 Amberg
 Germany

Autorizzazione



II 3 G

EEx nA II T4

secondo EN 50021 : 1999

Numero di controllo:

KEMA 02ATEX1096 X

Avvertenza

Le unità con l'autorizzazione II 3 G EEx nA II T3 .. T6 possono essere impiegate solo nei sistemi di controllori programmabili SIMATIC S7-300 / ET 200M della categoria di apparecchiature 3.

Manutenzione

Per una riparazione, il componente interessato deve essere inviato al luogo di produzione. La riparazione può essere effettuata solo lì.

Condizioni particolari

1. Il repeater di diagnostica deve essere montata in un armadio elettrico o in un contenitore metallico. Questi devono assicurare almeno il tipo di protezione IP 54. In questo caso bisogna tenere conto delle condizioni ambientali nelle quali l'apparecchiatura viene installata. Per il contenitore deve essere presente una dichiarazione del costruttore per la zona 2 (secondo EN 50021).
2. Se nei cavi o nel loro punto di ingresso in questo contenitore viene raggiunta in condizioni di esercizio una temperatura $> 70\text{ °C}$ o se in condizioni di esercizio la temperatura nella derivazione dei fili può essere $> 80\text{ °C}$, le caratteristiche di temperatura dei cavi devono essere conformi alla temperatura effettivamente misurata.
3. Gli ingressi dei cavi usati devono essere conformi al tipo di protezione richiesto e alla sezione 7.2 (secondo EN 50021).
4. Tutte le apparecchiature, inclusi interruttori, ecc. che vengono collegati agli ingressi/uscite di unità di segnale ad elevata sicurezza, devono essere stati omologati per la protezione da esplosione tipo EEx nA o EEx nC.
5. Devono essere prese delle misure per evitare che la tensione nominale possa essere superata per più del 40% da parte di transienti.
6. Campo termico ambientale: da 0 °C a 60 °C
7. All'interno del contenitore va appostata, in un luogo ben visibile dopo l'apertura, una targhetta con il seguente avvertimento:

Attenzione

Il contenitore può rimanere aperto solo per breve tempo, ad esempio per una diagnostica a vista. In tal caso non azionare alcun interruttore, non disinnestare o innestare unità e non staccare connessioni elettriche (connettori).

Non è necessario tenere conto di questo avvertimento se è noto che non c'è un'atmosfera a rischio di esplosione.

Elenco delle unità abilitate

La lista con le unità omologate si trova in Internet al sito:

<http://www4.ad.siemens.de/view/cs/>

all'ID di voce 13702947.

8.4.6 Gebruik van de diagnose-repeater in het explosieve gebied zone 2

Zone 2

Explosieve gebieden worden ingedeeld in zones. Bij de zones wordt onderscheiden volgens de waarschijnlijkheid van de aanwezigheid van een explosieve atmosfeer.

Zone	Explosion Hazard	Example
2	Een explosieve gasatmosfeer treedt maar zelden op en voor korte duur	Gebieden rond flensverbindingen met pakkingen bij buisleidingen in gesloten vertrekken
Veilig gebied	neen	<ul style="list-style-type: none"> • Buiten de zone 2 • Standaardtoepassingen van decentrale periferie

Hierna vindt u belangrijke aanwijzingen voor de installatie van de diagnose-repeater in een explosief gebied.

Verdere informatie

In het handboek vindt u verdere informatie over de diagnose-repeater en de verschillende componenten.

Productieplaats

Siemens AG, Bereich A&D
 Werner-von-Siemens-Strasse 50
 92224 Amberg
 Germany

Vergunning

 II 3 G EEx nA II T4 conform EN 50021 : 1999

Keuringsnummer: **KEMA 02ATEX1096 X**

Opmerking

Modulen met de vergunning  II 3 G EEx nA II T3 .. T6 mogen slechts worden gebruikt in automatiseringssystemen SIMATIC S7-300 / ET 200M van de apparaatcategorie 3.

Instandhouding

De te herstellen component moet voor reparatie naar de plaats van vervaardiging worden gestuurd. Alleen daar mag de reparatie worden uitgevoerd.

Speciale voorwaarden

1. De diagnose-repeater moet worden ingebouwd in een schakelkast of in een behuizing van metaal. Deze moeten minstens de veiligheidsgraad IP 54 waarborgen. Hierbij dient rekening te worden gehouden met de omgevingsvoorwaarden waarin het apparaat wordt geïnstalleerd. Voor de behuizing dient een verklaring van de fabrikant voor zone 2 te worden ingediend (volgens EN 50021).
2. Als aan de kabel of aan de kabelinvoering van deze behuizing onder bedrijfsomstandigheden een temperatuur wordt bereikt $> 70\text{ °C}$ of als onder bedrijfsomstandigheden de temperatuur aan de adertakking $> 80\text{ °C}$ kan zijn, moeten de temperatureigenschappen van de kabel overeenstemmen met de werkelijk gemeten temperaturen.
3. De aangebrachte kabelinvoeringen moeten de vereiste IP-veiligheidsgraad hebben en in overeenstemming zijn met alinea 7.2 (volgens EN 50021).
4. Alle apparaten, schakelaars enz. inbegrepen, die worden aangesloten op de in- en uitgangen van tegen fouten beveiligde signaalmodulen, moeten zijn goedgekeurd voor de explosiebeveiliging type EEx nA of EEx nC.
5. Er dienen maatregelen te worden getroffen, zodat de nominale spanning door transiënten met niet meer dan 40 % kan worden overschreden.
6. Omgevingstemperatuurbereik: 0 °C tot 60 °C
7. Binnen de behuizing dient op een na het openen goed zichtbare plaats een bord te worden aangebracht met de volgende waarschuwing:

Waarschuwing

De behuizing mag slechts voor korte tijd worden geopend, bijv. voor een visuele diagnose. Bedien hierbij geen schakelaar, trek of steek geen modulen en ontkoppel geen elektrische leidingen (steekverbindingen).

Deze waarschuwing kan buiten beschouwing blijven, indien bekend is dat er geen explosieve atmosfeer heerst.

Lijst van de toegelaten modulen

De lijst met de toegelaten modulen vindt u in het internet:

<http://www4.ad.siemens.de/view/cs/>

onder de bijdrage-ID 13702947.

8.4.7 Brug af diagnose-repeateren i det eksplosionsfarlige område zone 2

Zone 2

Eksplionsfarlige områder inddeles i zoner. Zonerne adskiller sig indbyrdes efter hvor sandsynligt det er, at der er en eksplosiv atmosfære.

Zone	Eksplionsfare	Eksempel
2	Eksplions gasatmosfære optræder kun sjældent og varer kort	Områder rundt om flangeforbindelser med flade pakninger ved rørledninger i lukkede rum
Sikkert område	Nej	<ul style="list-style-type: none"> • Uden for zone 2 • Standardanvendelser decentral periferi

I det følgende findes vigtige henvisninger vedr. installation af diagnose-repeateren i eksplosionsfarligt område.

Yderligere informationer

Yderligere informationer om diagnose-repeateren og de forskellige komponenter findes i manualen.

Produktionssted

Siemens AG, Bereich A&D
 Werner-von-Siemens-Straße 50
 92224 Amberg
 Germany

Godkendelse

 II 3 G EEx nA II T4 efter EN 50021 : 1999

Kontrolnummer: **KEMA 02ATEX1096 X**

Bemærk

Komponenter med godkendelsen  II 3 G EEx nA II T3 .. T6 må kun monteres i automatiseringssystemer SIMATIC S7-300 / ET 200M - udstyrskategori 3.

Vedligeholdelse

Skal den pågældende komponent repareres, bedes De sende den til produktionsstedet. Reparation må kun udføres der.

Særlige betingelser

1. Diagnose-repeateren skal monteres i et kontrolskab eller et metalkabinet. Disse skal mindst kunne sikre beskyttelsesklasse IP 54. I denne forbindelse skal der tages højde for de omgivelsestemperaturer, i hvilke udstyret er installeret. Der skal være udarbejdet en erklæring fra fabrikanten for kabinettet for zone 2 (iht. EN 50021).
2. Hvis kablet eller kabelindføringen på dette hus når op på en temperatur på $> 70\text{ }^{\circ}\text{C}$ under driftsbetingelser eller hvis temperaturen på åreforegreningen kan være $> 80\text{ }^{\circ}\text{C}$ under driftsbetingelser, skal kablernes temperaturegenskaber stemme overens med de temperaturer, der rent faktisk måles.
3. De benyttede kabelindføringer skal være i overensstemmelse med den krævede IP-beskyttelsestype og afsnittet 7.2 (iht. EN 50021).
4. Alle apparater, inkl. kontakter osv., der forbindes med ind- og udgangene til fejlsikre signalkomponenter, skal være godkendt til eksplosionsbeskyttelse af type EEx nA eller EEx nC.
5. Der skal træffes foranstaltninger, der sørger for, at den nominelle spænding via transienter ikke kan overskrides mere end 40 %.
6. Omgivelsestemperaturområde: 0°C til 60°C
7. I kabinettet skal der anbringes et skilt, der skal kunne ses, når kabinettet åbnes. Dette skilt skal have følgende advarsel:
Advarsel
Kabinettet må kun åbnes i kort tid, f.eks. til visuel diagnose. Tryk i denne forbindelse ikke på kontakter, træk eller isæt ikke komponenter og afbryd ikke elektriske ledninger (stikforbindelser).
Denne advarsel skal der ikke tages højde for, hvis man ved, at der ikke er nogen eksplosionsfarlig atmosfære.

Liste over godkendte komponenter

Listen med de godkendte komponenter findes på internettet:

<http://www4.ad.siemens.de/view/cs/>

under bidrags-ID 13702947.

8.4.8 Diagnoosi-toistimen käyttö räjähdysvaarannetuilla alueilla, vyöhyke 2

Vyöhyke 2

Räjähdysvaarannetut alueet jaetaan vyöhykkeisiin. Vyöhykkeet erotellaan räjähdyskelpoisen ilmakehän olemassa olon todennäköisyyden mukaan.

Vyöhyke	Räjähdysvaara	Esimerkki
2	Räjähävä kaasuilmakehä ilmaantuu vain harvoin ja lyhytaikaisesti	Alueet putkistojen lattatiivisteillä varustuilla laippaliitoksilla suljetuissa tiloissa
turvallinen alue	ei	<ul style="list-style-type: none"> vyöhykkeen 2 ulkopuolella Hajautetun ulkopiirin vakiosovellukset

Seuraavasta löydätte tärkeitä ohjeita diagnoosi-toistimen asennukseen räjähdysvaarannetuilla alueilla.

Lisätietoja

Lisätietoja diagnoosi-toistimeen ja erilaisiin komponentteihin löydätte ohjekirjasta.

Valmistuspaikka

Siemens AG, Bereich A&D
Werner-von-Siemens-Straße 50
92224 Amberg
Germany

Hyväksyntä



II 3 G

EEx nA II T4

EN 50021 mukaan: 1999

Tarkastusnumero: **KEMA 02ATEX1096 X**

Ohje

Rakenneryhmät hyväksynnän II 3 G EEx nA II T3 .. T6 kanssa saadaan käyttää ainoastaan laitekategorian 3 automatisointijärjestelmissä SIMATIC S7-300 / ET 200M.

Kunnossapito

Korjausta varten täytyy kyseinen komponentti lähettää valmistuspaikkaan. Korjaus voidaan suorittaa ainoastaan siellä.

Erityiset vaatimukset

1. Diagnoosi-toistin täytyy asentaa kytkentäkaappiin tai metalliseen koteloon. Näiden täytyy olla vähintään kotelointiluokan IP 54 mukaisia. Tällöin on huomioitava ympäristöolosuhteet, johon laite asennetaan. Kotelolle täytyy olla valmistajaselvitys vyöhykettä 2 varten (EN 50021 mukaan).
2. Kun johdolla tai tämän kotelon johdon sisäänviennillä saavutetaan $> 70^{\circ}\text{C}$ lämpötila tai kun käyttöolosuhteissa lämpötila voi pihajautuksella olla $> 80^{\circ}\text{C}$, täytyy johdon lämpötilaominaisuuksien vastata todellisesti mitattuja lämpötiloja.
3. Käytettyjen johtojen sisäänohjauksien täytyy olla vaaditun IP-kotelointiluokan ja kohdan 7.2 (EN 50021 mukaan) mukaisia.
4. Kaikkien laitteiden, kytkimet jne. mukaan lukien, jotka liitetään virheiltä suojattujen signaalirakenneryhmien tuloille ja lähdöille, täytyy olla hyväksytyjä tyyppiin EEx nA tai EEx nC räjähdysuojausta varten.
5. Toimenpiteet täytyy suorittaa, ettei nimellisjännite voi transienttien kautta ylittyä enemmän kuin 40 %.
6. Ympäristölämpötila-alue: $0^{\circ}\text{C} \dots 60^{\circ}\text{C}$
7. Kotelon sisälle, avauksen jälkeen näkyvälle paikalle, on kiinnitettävä kilpi, jossa on seuraava varoitus:

Varoitus

Kotelo saadaan avata ainoastaan lyhyeksi ajaksi, esim. visuaalista diagnoosia varten. Älä tällöin käytä mitään kytkimiä, vedä tai liitä mitään rakenneryhmiä, äläkä erota mitään sähköjohtoja (pistoliittimiä).

Tätä varoitusta ei tarvitse huomioida, kun on tiedossa, että minkäänlaista räjähdysvaarannettua ilmakehää ei ole olemassa.

Hyväksytyjen rakenneryhmien lista

Lista hyväksytyistä rakennesarjoista löytyy internetistä osoitteesta:

<http://www4.ad.siemens.de/view/cs/>

käyttäjätunnuksella 13702947.

8.4.9 Användning av diagnosrepeater i explosionsriskområde zon 2

Zon 2

Explosionsriskområden delas in i zoner. Zonerna delas in enligt sannolikheten att en atmosfär med explosionsfara föreligger.

Zon	Explosionsfara	Exempel
2	Explosiv gasatmosfär uppstår endast sällan eller kortvarigt	Områden kring flänsförbindelser med packningar vid rörledningar i slutna utrymmen
Säkert område	Nej	<ul style="list-style-type: none"> • Utanför zon 2 • Standardanvändning av decentral periferi

Nedan följer viktiga anvisningar om installationen av diagnosrepeaters komponenter i ett explosionsriskområde.

Ytterligare information

Ytterligare information om diagnosrepeatern finner du i handboken.

Tillverkningsort

Siemens AG, Bereich A&D
 Werner-von-Siemens-Straße 50
 92224 Amberg
 Germany

Godkännande



II 3 G

EEx nA II T4

enligt EN 50021 : 1999

Kontrollnummer: **KEMA 02ATEX1096 X**

Anvisning

Komponentgrupper med godkännande II 3 G EEx nA II T3 .. T6 får endast användas i automatiseringssystemen SIMATIC S7-300 / ET²200M från apparatgrupp 3.

Underhåll

Vid reparation måste den aktuella komponenten insändas till tillverkaren. Reparationer får endast genomföras där.

Särskilda villkor

1. Diagnosrepeatern måste monteras i ett kopplingskåp eller metallhus. Dessa måste minst vara av skyddsklass IP 54. Därvid ska omgivningsvillkoren där enheten installeras beaktas. För kåpan måste en tillverkardeklaration för zon 2 föreligga (enligt EN 50021).
2. Om en temperatur på $> 70^{\circ}\text{C}$ uppnås vid husets kabel resp kabelinföring under driftvillkor eller om temperaturen vid trådförgreningen kan vara $> 80^{\circ}\text{C}$ under driftvillkor, måste kabelns temperaturegenskaper överensstämma med den verkliga uppmätta temperaturen.
3. De använda kabelinföringarna måste uppfylla kraven i det krävda IP-skyddsutförandet och i avsnitt 7.2 (enligt EN 50021).
4. Alla apparater, inklusive brytare osv, som ansluts till felsäkrade signalenheters in- och utgångar, måste vara godkända för explosionsskydd av typ EEx nA eller EEx nC.
5. Åtgärder måste vidtas så, att märkspänningen ej kan överskridas med mer än 40% genom transienter.
6. Omgivningstemperatur: 0°C till 60°C
7. När huset öppnats ska en skylt med följande varning monteras på ett tydligt synligt ställe huset:

Varning

Huset får endast öppnas under kort tid, t ex för visuell diagnos. Använd därvid inga brytare, lossa eller anslut inga enheter och frånskilj inga elektriska ledningar (insticksanslutningar). Ingen hänsyn måste tas till denna varning om det är säkert att det inte råder någon explosionsfarlig atmosfär.

Lista över godkända komponentgrupper

Lista över godkända enheter återfinns i Internet:

<http://www4.ad.siemens.de/view/cs/>

under bidrags-ID 13702947.

8.4.10 Uso do Diagnose-Repeaters em área exposta ao perigo de explosão, zona 2

Zona 2

As áreas expostas ao perigo de explosão são divididas em zonas. As zonas são diferenciadas de acordo com a probabilidade da existência de uma atmosfera explosiva.

Zona	Perigo de explosão	Exemplo
2	Só raramente e por um breve período de tempo surgem atmosferas explosivas	Áreas em torno de ligações flangeadas com vedações chatas em tubulações em recintos fechados
Área segura	não	<ul style="list-style-type: none"> • fora da zona 2 • Aplicações descentralizadas de periferia descentralizada

A seguir, encontrará avisos importantes para a instalação do repetidor para diagnóstico em área exposta ao perigo de explosão.

Mais informações

Para obter mais informações sobre o Diagnose-Repeater e sobre os diversos componentes, consulte o manual.

Local de produção

Siemens AG, Bereich A&D
 Werner-von-Siemens-Straße 50
 92224 Amberg
 Germany

Licença



II 3 G

EEx nA II T4

seg. EN 50021 : 1999

Número de ensaio: **KEMA 02ATEX1096 X**

Aviso

Componentes com a licença II 3 G EEx nA II T3 .. T6 só podem ser aplicados em sistemas de automação SIMATIC S7-300 / ET 200M da categoria de aparelho 3.

Reparo

Os componentes em questão devem ser remetidos para o local de produção a fim de que seja realizado o reparo. Apenas lá deve ser efetuado o reparo.

Condições especiais

1. O repetidor para diagnóstico deve ser montado em um armário de distribuição ou em uma caixa metálica. Estes devem garantir no mínimo o tipo de proteção IP 54. Durante este trabalho deverão ser levados em consideração as condições locais, nas quais o aparelho será instalado. Para a caixa deverá ser apresentada uma declaração do fabricante para a zona 2 (de acordo com EN 50021).
2. Caso no cabo ou na entrada do cabo desta carcaça sob as condições operacionais seja atingida uma temperatura de $> 70^{\circ}\text{C}$, ou caso sob condições operacionais a temperatura na ramificação do fio poderá atingir $> 80^{\circ}\text{C}$, as características de temperatura deverão corresponder às temperaturas realmente medidas.
3. As entradas de cabo utilizadas devem corresponder ao tipo exigido de proteção IP e à seção 7.2 (de acordo com o EN 50021).
4. Todos os aparelhos, inclusive as chaves, etc., que estejam conectadas em entradas e saídas de módulos de sinais protegidos contra erro, devem possuir a licença para a proteção de explosão do tipo EEx nA ou EEx nC.
5. Precisam ser tomadas medidas para que a tensão nominal através de transitórios não possa ser ultrapassada em mais que 40 %.
6. Área de temperatura ambiente: 0°C até 60°C
7. No âmbito da carcaça deve ser colocada, após a abertura, em um ponto bem visível uma placa com a seguinte advertência:

Advertência

A carcaça deve ser aberta apenas por um breve período de tempo, por ex. para diagnóstico visual. Não acione nenhum interruptor, não retire ou conecte nenhum módulo e não separe nenhum fio elétrico (ligações de tomada). Esta advertência poderá ser ignorada caso se saiba que não há nenhuma atmosfera sujeita ao perigo de explosão.

Lista dos componentes autorizados

A lista com os módulos autorizados encontram-se na Internet:

<http://www4.ad.siemens.de/view/cs/>

sob o número de ID 13702947.

8.4.11 Χρήση του επαναλήπτη διάγνωσης σε επικίνδυνη για έκρηξη περιοχή, ζώνη 2

Ζώνη 2

Οι επικίνδυνες για έκρηξη περιοχές χωρίζονται σε ζώνες. Οι ζώνες διαφέρουν σύμφωνα με την πιθανότητα ύπαρξης ενός ικανού για έκρηξη περιβάλλοντος.

Ζώνη	Κίνδυνος έκρηξης	Παράδειγμα
2
.....	...	<ul style="list-style-type: none"> 2

Στη συνέχεια θα βρείτε σημαντικές υποδείξεις για την εγκατάσταση του επαναλήπτη διάγνωσης σε επικίνδυνη για έκρηξη περιοχή.

Επιπλέον πληροφορίες

Επιπλέον πληροφορίες για τον επαναλήπτη διάγνωσης και για τα διάφορα εξαρτήματα θα βρείτε στο εγχειρίδιο.

Τόπος κατασκευής

Siemens AG, Bereich A&D
Werner-von-Siemens-Straße 50
92224 Amberg
Germany

Άδεια

 II 3 G EEx nA II T4 σύμφωνα με το πρότυπο
EN 50021 : 1999

Αριθμός ελέγχου: **KEMA 02ATEX1096 X**

Υπόδειξη

Τα δομικά συγκροτήματα με την άδεια  II 3 G EEx nA II T3 .. T6 επιτρέπεται να τοποθετηθούν μόνο σε συστήματα αυτοματισμού SIMATIC S7-300 / ET 200M της κατηγορίας συσκευής 3.

Συντήρηση

Για μια επισκευή πρέπει να σταλθεί το αντίστοιχο εξάρτημα στον τόπο κατασκευής. Μόνο εκεί επιτρέπεται να γίνει η επισκευή.

Ιδιαίτερες προϋποθέσεις

1. Ο επαναλήπτης διάγνωσης πρέπει να ενσωματωθεί σε ένα ερμάριο ζεύξης ή σε ένα μεταλλικό περίβλημα. Αυτά πρέπει να εξασφαλίζουν το λιγότερο το βαθμό προστασίας IP 54. Σε αυτήν την περίπτωση πρέπει να ληφθούν υπόψη οι περιβαλλοντικές συνθήκες, στις οποίες θα εγκατασταθεί η συσκευή. Για το περίβλημα πρέπει να προβλέπεται δήλωση του κατασκευαστή για τη ζώνη 2 (σύμφωνα με το πρότυπο EN 50021).
2. Εάν στο καλώδιο ή στην είσοδο του καλωδίου αυτού του περιβλήματος κάτω από συνθήκες λειτουργίας η θερμοκρασία ξεπεράσει τους 70 °C ή όταν κάτω από συνθήκες λειτουργίας η θερμοκρασία στη διακλάδωση του σύρματος μπορεί να είναι μεγαλύτερη από 80 °C, πρέπει οι θερμοκρασιακές ιδιότητες των καλωδίων να ταυτίζονται με τις πραγματικά μετρημένες θερμοκρασίες.
3. Οι χρησιμοποιούμενες εισόδους καλωδίων πρέπει να συμμορφώνονται με το βαθμό προστασίας IP 54 στην ενότητα 7.2 (σύμφωνα με το πρότυπο EN 50021).
4. Όλες οι συσκευές, συμπεριλαμβανομένων διακοπών κ.α., που συνδέονται στις εισόδους και εξόδους δομικών συγκροτημάτων ασφαλών σημάτων, πρέπει να φέρουν εγκριμένη προστασία κατά έκρηξης τύπου EEx nA ή EEx nC.
5. Πρέπει να ληφθούν μέτρα, να μην μπορεί να γίνει υπέρβαση της ονομαστικής τάσης μέσω αιφνίδιας μεταβολής της τάσης πάνω από 40 %.
6. Περιοχή θερμοκρασίας περιβάλλοντος: 0° C έως 60° C
7. Πρέπει να τοποθετηθεί μέσα στο περίβλημα σε ευδιάκριτο σημείο μετά το άνοιγμα μία πινακίδα με την ακόλουθη προειδοποίηση:
Προειδοποίηση
 Το περίβλημα επιτρέπεται να ανοίγει μόνο για μικρό χρονικό διάστημα, π.χ. για τη διενέργεια οπτικής διάγνωσης. Μην κάνετε χρήση διακοπών, μην τραβάτε ή εμβυσματώνετε δομικά συγκροτήματα και μη διαχωρίζετε ηλεκτροφόρους αγωγούς (εμβυσματώσιμες συνδέσεις).
 Η προειδοποίηση αυτή δε χρειάζεται να ληφθεί υπ' όψιν, εάν είναι γνωστό ότι δεν υφίσταται ατμόσφαιρα παρουσιάζουσα κίνδυνο έκρηξης.

Κατάλογος των εγκεκριμένων δομικών συγκροτημάτων

Η λίστα με τα εγκεκριμένα δομικά συγκροτήματα υπάρχει στο διαδίκτυο:

<http://www4.ad.siemens.de/view/cs/>

με τον κωδικό συνδρομής 13702947.

A Order Numbers

Diagnostic repeater and accessories

Designation	Order number
Diagnostic repeater	6ES7972-0AB01-0XA0
SIMATIC S5/S7 connecting cable for 12 Mbps Programming device connection to PROFIBUS-DP (active cable)	6ES7901-4BD00-0XA0
Fast-Connect stripping tool	6GK1905-6AA00
BT200 Bus physics testing device for PROFIBUS-DP	6ES7181-0AA01-0AA0

PROFIBUS-DP bus connector

Designation	Order number
PROFIBUS-DP bus connector (12 Mbps)	6ES7972-0BA12-0XA0
PROFIBUS-DP bus connector (12 Mbps)	6ES7972-0BB12-0XA0
PROFIBUS-DP bus connector (12 Mbps)	6ES7972-0BA41-0XA0
PROFIBUS-DP bus connector (12 Mbps)	6ES7972-0BB41-0XA0
PROFIBUS-DP bus connector (12 Mbps) Without programming device connector	6ES7972-0BA50-0XA0
PROFIBUS-DP bus connector (12 Mbps) With programming device connector	6ES7972-0BB50-0XA0
PROFIBUS-DP bus connector (12 Mbps) (with straight outgoing feeder)	6GK1500-0FC00

Note

If you are using other connectors, the design guidelines for the diagnostic repeater require them to meet particular requirements (see Section 3.1.3).

SIMATIC NET PROFIBUS cables

The table below shows the SIMATIC NET PROFIBUS cables that can be used in conjunction with the diagnostic repeater or are not permissible as well as the permissible line lengths in segments DP2 and DP3.

Designation	Order number	Maximal permissible line length
FC Standard Cable	6XV1 830-0EH10	100 m
FC FRNC Cable	6XV1 830-0LH10	100 m
FC Food Cable	6XV1 830-0GH10	100 m
FC Robust Cable	6XV1 830-0JH10	100 m
FC Underground Cable ¹	6XV1 830-3FH10	100 m
FC Trailing Cable	6XV1 830-3EH10	80 m
Festoon Cable ²	6XV1 830 -3GH10	80 m
Flexible Cable ²	6XV1830-0PH10	80 m
SIENOPYRFR shipboard cable ³	6XV1830-0MH10	80 m
FC Process Cable for IEC 61158-2	6XV1 830-5EH10 6XV1 830-5FH10	Not permissible
Cable for festoon attachment	6XV1 830-3CH10	Not permissible

¹ Outside diameter > 8 mm, connection to the diagnostic repeater only possible after removal of the outer sheath.

² Direction connection possible to the diagnostic repeater.

³ Convert to a FastConnect cable.

Note

If you are using other cables, the design guidelines for the diagnostic repeater require them to meet particular requirements (see Section 3.1.3).

Manuals

Designation	Order number
Diagnostic Repeater for PROFIBUS-DP German Manual	6ES7 972-0AB00-8AA0
Diagnostic Repeater for PROFIBUS-DP English Manual	6ES7 972-0AB00-8BA0
Diagnostic Repeater for PROFIBUS-DP French Manual	6ES7 972-0AB00-8CA0
SIMATIC NET PROFIBUS Networks	6GK1970-5CA20-0AA1
Programming with STEP 7 V5.1	6ES7 810-4CA05-8BA0
SIMATIC Manual Collection 08/2002	6ES7 998-8XC01-8YE0

B Dimension Drawings

Diagnostic repeater

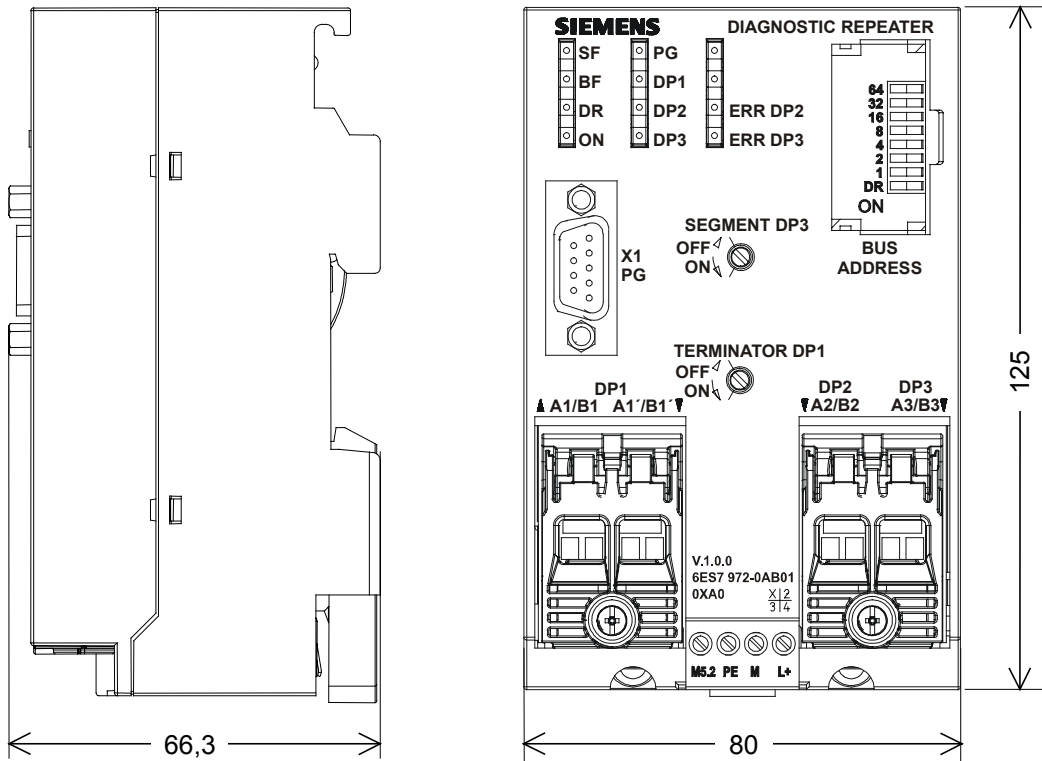

C User Questions

C.1 Topology and fault point determination

Is the topology determined automatically?

When an S7 CPU is used with the integrated system function SFC 103 "DP_TOPO", the topology can be determined automatically in the user program.

When any other CPU is used, the topology must be determined by the user using STEP 7 or COM PROFIBUS after any change to the plant. To do so use the menu commands

- **PLC > PROFIBUS > Prepare Line Diagnostics** in STEP 7 or
- **Service > Prepare Line Diagnostics** in COM PROFIBUS.

Can I read out the topology table?

In the case of diagnostic repeaters with the order number 6ES7 972-0AB01-0XA0 you can read out the topology table.

If you do not want to use the tabular rather than the graphical topology display, choose the following menu command in STEP 7 **View > Topology table**.

The topology table can also be read out with SFC 59 "RD_REC" or SFB 52 "RDREC" using the user program (see Section 7.3).

What is the effect of an excessive line length?

The diagnostic repeater can monitor a maximum line length of 100 m per segment (DP2, DP3) at baud rates of 9.6 kbps to 12 Mbps.

If this length is exceeded, the following diagnostic message appears: "The distance from the node to the diagnostic repeater exceeds the permitted cable length".

This diagnosis is generated the first time the topology is determined on the bus. The SF LED shines red. If the diagnostic repeater is switched off and on again, the LED goes out. The diagnostic message is not issued again until the next time the topology is determined.

Remedy:

Insert one or more diagnostic repeaters into the segment so that the maximum line length which is permissible and can be monitored of 100 m per segment is not exceeded.

What effect does a shield break have?

A shield break is not detected by the diagnostic repeater.

How does topology determination take place when there are several diagnostic repeaters in the line?

Up to nine diagnostic repeaters can be connected in series. Topology determination only has to be carried once for each PROFIBUS network.

The programming device/PC can be connected to any of the diagnostic repeaters in the PROFIBUS network.

A diagnostic repeater recognizes when it has another diagnostic repeater under it.

Can the diagnostic repeater diagnose two or more fault occurring simultaneously at one segment?

The diagnostic repeater diagnoses the faults in the order in which they occur. As soon as a signaled fault has been eliminated, the next one can be diagnosed.

A second fault which lies closer to the diagnostic repeater takes the place of the current message.

In diagnostic repeaters as of order number 6ES7 972-0AB01-0XA0 there is an integrated diagnostic buffer that stores the most recent diagnostic events for each PROFIBUS segment (DP1, DP2, DP3, and programming device). This diagnostic buffer can be read out from the CPU with SFC 59 "RD_REC" or SFB 52 "RDREC" using the user program (see Section 7.3).

C.2 Diagnostic repeater / RS 485 repeater

What is the difference to the RS 485 repeater?

The diagnostic has new features not shared by the RS 485 repeater: the diagnostic function and the modeling as a DP slave.

The slave functionality is required in order for the diagnostic repeater to send its diagnostic messages to the DP master.

Unlike the RS 485 repeater, the diagnostic repeater serves three segments: two diagnostics-capable segments (each with 31 nodes) and one non-diagnostics-capable segment.

Can an RS 485 repeater simply be replaced by a diagnostic repeater?

Basically, yes. However, the diagnostic repeater requires more mounting space and can only be used with certain restrictions together with RS 485 repeaters. The diagnostic repeater has to be configured in the DP master and uses a PROFIBUS address. At a substitution the design guidelines of the diagnostic repeater have to be observed (see Section 3.1).

Is it possible to use diagnostic repeaters and RS 485 repeater together in one plant?

Yes, if partially imperfect topology determination is acceptable and it is possible to do without line diagnostics **after the RS 485 repeater** (see Section 3.2).

Are there restrictions in comparison to the RS 485 repeater?

All the restrictions apply irrespective of the set baud rate:

- Components with a repeater function such as the RS 485 repeater and OLM can be used if partially imperfect topology determination is acceptable and it is possible to do without line diagnostics after the component with a repeater function.
- The maximum number of nodes at the PROFIBUS is reduced by the number of diagnostic repeaters used since the diagnostic repeater is itself a node and thus has its own PROFIBUS address and has to be configured via the DP master.
- The maximum permissible cable length amounts to 100 m per segment (DP2, DP3).
- The diagnostic repeater may only be used in FMS and FDL networks with certain limitations.
- The diagnostic repeater may not be used in pure MPI networks.

C.3 Diagnostic repeater with different order numbers

Can diagnostic repeaters (6ES7972-0AB00-0XA0) be upgraded?

A firmware update is not possible to the functionality of the diagnostic repeater with the order number 6ES7972-0AB01-0XA0.

What are the points to observe when replacing diagnostic repeaters?

When replacing a diagnostic repeater with the order number 6ES7972-0AB00-0XA0 with a diagnostic repeater with the order number 6ES7972-0AB01-0XA0, proceed as follows:

- Set the address on the diagnostic repeater,
- Switch the DR switch to ON,
- Carry out topology determination.

What should you watch out for when using diagnostic repeaters with different versions in the same network?

The topology display in STEP 7 may be incomplete because the diagnostic repeater with the order number 6ES7972-0AB00-0XA0 does not support the reading out of the topology.

If errors occur during topology determination, there is no feedback with the diagnostic repeater with the order number 6ES7972-0AB00-0XA0.

C.4 Diagnostic messages

Why does the diagnostic repeater signal faults between nodes which do not exist?

The physical structure of the segment has possibly changed since the last determination of the topology. The topology table of the diagnostic repeater has not been updated yet.

The following are to be understood as changes in the physical structure:

- Change in the line lengths,
- Addition, removal of nodes or components with a repeater function,
- Change in node addresses.

Remedy:

Update the topology table of the diagnostic repeater.

- To do this, choose **PLC > PROFIBUS > Prepare Line Diagnostics** in STEP 7 or
- in COM PROFIBUS **Service > Prepare Line Diagnostics**,
- When using an S7 CPU that supports the integrated system function SFC 103 "DP_TOPO", by using the user program.

Why is the specification of the distance inexact?

All distance specifications have a tolerance of ± 1 m. The error can therefore also have occurred at neighboring nodes which lie within the tolerance to the specified node.

Why can the cause of the fault not always be determined?

Some reflections do not allow a clear conclusion of what the cause of the fault is. The cause of the fault can be isolated by checking the respective segment section-by-section. To do so, cut in the terminator at the PROFIBUS connectors so that the outgoing line is separated.

Why is the distance to the fault point not specified exactly?

Every PROFIBUS node corresponds to an additional cable length of approx. 0.7 m which is contained in the distance specification. With certain diagnostic messages, for technical reasons the system may only be able to determine an absolute distance between the diagnostic repeater and fault point, not taking into account the additional line length. The system indicates if the distance specification needs to be corrected.

Correction: Determine the number of nodes between the diagnostic repeater and the fault location. Subtract 0.7 m per node from the distance specification.

Fault point = Distance specification – (0.7 m * Number of determined nodes)

Example: fault location = 25 m – (0.7 m x 10 nodes) = 18 m

Behavior of the diagnostic repeater after power on in the event of an error

Example:

- A node is removed from a plant during Power-off.
- During the work a line fault occurs at a point in the network due to a line break, without being noticed.
- The plant is switched on again.

The diagnostic repeater detects the line break. However, because of the change to the plant, the distance specifications may not be correct.

The topology determination cannot be carried out until the fault has been eliminated by the user.

Glossary

Baud rate

The baud rate of a data transfer is measured in bits transmitted per second. In the case of the diagnostic repeater transmission rates of 9.6 kbps to 12 Mbps are possible.

Bus

A common transfer route connecting all nodes and having two defined ends.

Bus connector

A physical connection between the bus nodes and the bus line.

Configuration

The systematic arrangement of the different modules (setup).

CSV file

File format that can be read in and further processed by various applications, including Microsoft Excel.

Device Database File (GSD File)

A device database file (GSD file) contains the general master and slave properties as well as the performance parameter. The format of the GSD file is specified in the PROFIBUS Guideline "GSD-Specification for PROFIBUS-DP" and in ISO 15745-3.

Diagnostics

Diagnostics involves the identification, localization, classification, display and further evaluation of errors, faults and messages.

Diagnostics includes monitoring functions that run automatically while the system is in operation. This increases the availability of systems by reducing setup times and downtimes.

DP master

The DP master carries out the communication with the DP slaves in the DP system in accordance with a specified algorithm. To this purpose the DP master uses the functions specified at the PROFIBUS DP for communicating with the DP slaves.

DP slave

The DP slave can be addressed by the DP master. The DP slave makes specified functionalities (I/O data, diagnostics, etc.) available to the DP masters.

Electromagnetic compatibility

Electromagnetic compatibility is the ability of an electrical device to function fault-free in a specified environment without influencing the environment in a manner which is not permissible.

Equipotential bonding

Electrical connection (equipotential bonding conductor) that brings the exposed conductive parts of electrical equipment and other conductive parts to the same or approximately the same potential in order to prevent troublesome or dangerous voltages arising between these parts.

Ground

The conductive mass of earth, the electrical potential of which is equivalent to zero. In the vicinity of grounding electrodes, the potential may not be zero. The term "reference ground" is often used here.

HMI

Abbreviation for Human Machine Interface. Operator control and monitoring device for effective dialog between humans and machine, for example, SIMATIC Operator Panels (OP), SIMATIC Touch Panels (TP).

Master

When it has a token, a master can send data to and request data from other nodes (active nodes). The CPU 315–2 DP is an example of a DP master.

Node

Device which can send and/or receive data via the bus, for example a DP master or a DP slave. This device requires a unique PROFIBUS address to this purpose.

Parameter configuration

Parameter configuration is the setting of parameters for the slave, master or further ones for modules.

PROFIBUS

PROcess Field BUS; field bus standard defined in IEC 61158:Ed3 Type 3 and IEC 61784-1:2002 Ed1 CP 3/1. It defines the functional, electrical, and mechanical properties of a bit serial field bus system.

PROFIBUS address

Each bus node must receive a PROFIBUS address so that it can be uniquely identified on PROFIBUS-DP.

PCs/programming devices have the PROFIBUS address "0".

DP masters and DP slaves have a PROFIBUS address in the range of 1 to 125.

PROFIBUS DP

PROFIBUS bus system with the protocol DP. DP stands for Distributed I/O devices.

Reference potential

Potential from which the voltages of the circuits involved can be observed and/or measured.

Segment

The bus line between two terminating resistors forms a segment. A segment can contain up to 32 bus nodes. Segments can be connected, for example, via RS 485 Repeaters or diagnostic repeaters.

Slave

A slave may only exchange data with a master after it has been prompted by the master to do so. Slaves are, for example, all the DP slaves such as ET 200B, ET 200X, ET 200M, ET 200S, diagnostic repeater.

Terminator

A terminator is a resistor used to terminate the data transfer cable in order to avoid reflections.

Ungrounded

Without electrical connection to ground.

Index

A

Absolute distance	1-8
Absolute distance specification	3-20
Absolute distance specification, example	7-30
Accessories	A-1
Active cables	3-6
Addressing	6-1
Alarms	8-10
Ambient conditions	8-10
Approvals	8-1
Arrangement of the DP master	3-8
Available functions	
with COM PROFIBUS	6-3
with STEP 7	6-3

B

Baud rate	8-9
correct	7-35
search	2-1
Behavior in the event of an error	2-1
Block diagram	5-5
Break in the signal wire	7-34
BT 200	3-19
BUS ADDRESS (switch)	1-6
Bus cables	5-3, 8-9
Bus components	
with a repeater function	3-12
with repeater function	3-12
Bus connectors	3-3
Bus faults	3-13
Bus terminal	
RS 485	3-2, 3-6

C

Cable length	
maximum	3-5
Cable types	5-2, A-2
power supply	8-9
Cables	3-3
Cascading depth	3-5
CE marking	8-1
Changes	
to plants	1-8, 3-20
Changes in the physical structure	C-5
Changing the address	6-2
Classification organizations	8-3
Clock synchronization	6-5

Clocked interrupt	6-5
Clocked PROFIBUS bus system	
features	2-6
COM PROFIBUS	
menu command for diagnostics	7-4
menu command for topology determination	1-8
versions	6-3
Commissioning	6-8
Commissioning/service	2-2
Components	
with integrated section monitoring	3-13
with repeater function	3-12
Components with a repeater function	C-3
Components with repeater function	3-12
Conditions of use during operation	8-6
Configuration	6-5
example	3-10
Connecting PG/PC	6-8
Connecting PGs	6-8
Connecting PROFIBUS bus lines	5-3
Connections	5-4
Contacting cover	5-3
Control-to-load isolation	5-6
Conversion to FC cables	3-4
Copper networks	3-1
Correction of the distance specification	C-6
CSV file	2-2
C-Tick mark	8-2
Currents	8-10

D

Data photoelectric barriers	3-12
DDB	6-4
Degree of protection	1-3
Design guidelines	
diagnostic repeaters	3-1
PROFIBUS networks	3-1
Determining the topology	
carrying out	1-8
deactivating	3-13
Diagnosable faults	7-1
Diagnostic block FB 125	7-4
Diagnostic buffer	2-2
example	7-27
STEP 7	7-26
user program	7-17
Diagnostic concept	3-19
Diagnostic message	
reading out	7-4
Diagnostic message frame length	6-6
Diagnostic package	7-4

Diagnostics	
menu commands	7-4
Difference to the RS 485 repeater	C-3
Dimension drawings	B-1
Dimensions and weight	8-9
Dismantling the diagnostic repeater	4-2
Display elements	1-5
Distance	
absolute	1-8
relative	1-9
Distance specification	
absolute	3-20, C-6
absolute, example	7-30
correction	C-6
relative	3-20
relative, example	7-30
Distance specifications	1-9
Download	
COM PROFIBUS	6-4
DDB	6-4
DP interrupt mode	6-7
DP master from other vendor	6-6
DPV0	6-7
DPV1	6-7
DR ON (switch)	1-6
DR-CfgData	6-4

E

Earth-free operation	5-6
Electromagnetic compatibility	8-4
Equidistance	6-5, 8-9
master	2-7
mode	2-7
Equipotential bonding	7-33
Error message - example	7-30
ET 200U	3-2
Evaluation of data	7-25, 7-26, 7-28
Example configuration	3-10
Excel	7-25, 7-26, 7-28
Explosionsgefährdeter Bereich	8-12

F

Fast Connect connection system	3-4
Fast Connect system	3-19
Fault cause not clear	7-36
Fault elimination	7-31
Fault LEDs	7-2, 7-3
Fault location determination	
how it works	1-9
Fault location not clear	7-36
FB 125	7-4
FC stripping tool	5-1, 5-3
FDL/FMS networks	3-1
Fiber-optic cable networks	3-1
Firmware update	1-10
Functionality	1-7

H

HMI	1-3
-----	-----

I

Identification data	2-5
IEC 529	8-8
IEC 536	8-8
IEC 61000	8-4, 8-5
IEC 61131	8-2, 8-6, 8-8
IEC 61158	1-1, 1-2, 3-3, 8-2, A-2
IEC 61784-1	8-2
IEC 68	8-8
Infrared Link Module	3-12
Installation	3-19
Insulation piercing	5-1
Interconnections	3-7
Invalid arrangements	3-7
Isolating transformer	3-2

J

Jitter	8-9
--------	-----

L

LEDs	1-7, 7-2, 7-3
Lightning protection elements	3-2
Line diagnostic	1-7
Line diagnostics preparation	1-8
Line length	
changing	3-20
monitorable	3-5

M

Manufacturer ID	7-8
Marine approvals	8-3
Measuring circuit	3-7
Menu command	
Determine Topology	1-8
diagnostics	7-4
Messages	7-35
Microsoft Excel	7-25, 7-26, 7-28
Module diagnosis	7-8
Monitoring function	
clocked PROFIBUS bus system	6-7, 8-9
data	2-7
diagnostic message	7-13
Monitoring functions	
diagnostic repeater	2-6
More than one measuring circuit	
in segment	7-32
Mounting	
DIN rail	4-3
mounting rail for S7-300	4-2
Mounting dimensions	4-1
Mounting position	4-1

- Mounting rail
 DIN rail 4-1
 S7-300 4-1
 MPI interface 6-8
 MPI networks 3-1
 Multiple fault 7-36
 Multiple-stage diagnostic concept 3-19
- N**
- Network design
 with component with repeater function 3-14
 with OLM 3-17
 with RS 485 repeater 3-15
 Nodes
 adding 3-20
 exchanging 3-20
 removing 3-20
 Non-Siemens DP master 6-6
 Note
 activating the firmware 1-10
 addressing 6-1
 cables without the Fast Connect
 connection system 3-4
 certificates and approvals 8-2
 components with repeater function 3-12
 diagnostic frame 7-5
 insulation piercing technique 5-1, A-1, A-2
 time 2-4
 topology determination 6-9
 Zone 2 8-14
- O**
- Operating elements 1-5
 Operator interface systems 1-3
 Optical Bus Terminal 3-12
 Optical Link Module 3-12
 Order numbers A-1
 diagnostic repeater and accessories A-1
 manuals A-2
 PROFIBUS-DP bus connectors A-1
 SIMATIC NET PROFIBUS cables A-2
 Overvoltages 7-33
- P**
- Parameter assignment 6-6
 Parameters 6-6
 Party line of the S7-300 3-6
 Permissible arrangements 3-7
 PG socket 5-6
 Pin assignment of the Cannon connector 5-6
 Plant
 changing 3-20
 design 3-19
 extending 3-20
 Potential difference 7-33
 Potentials 8-10
 Power consumption 8-10
 Power loss 8-10
 Power Rail Booster 3-12
 Power supply 5-2
 Prerequisites
 addressing 6-1
 bus connectors 5-3
 cables 5-3
 commissioning 6-8
 configuration 6-3
 monitoring function 2-7
 parameter assignment 6-6
 repeater function 2-1
 PROFIBUS address
 changing 6-2
 PROFIBUS address 1-6
 setting 6-2
 PROFIBUS addresses
 changing 3-20
 PROFIBUS cables A-2
 Programming device connection
 diagnostic repeater 5-6
 integrated terminating resistor 5-6
- R**
- Range of application of the
 diagnostic repeater 1-4
 Records 8-11
 Reflection fault rate 7-31
 Relative distance 1-9
 Relative distance specification 3-20
 Relative distance specification, example 7-30
 Repeater function 1-6
 deactivating 2-2
 fundamentals 2-1
 Repeating bus components 3-12, C-3
 Replacement 3-20
 Requirements
 bus connectors 3-3
 cables 3-4
 updating the firmware 1-10
 RS 485 repeater 3-12
 Rules for design 3-1
- S**
- Screen short circuit 7-34
 Section monitoring 3-13
 Segment de-activated 7-35
 SEGMENT DP3
 connecting/disconnecting 5-4
 example 3-8
 SEGMENT DP3 (switch) 1-6
 Service 2-2
 SFB 52 "RDREC" 7-14
 SFC 103 "DP_TOPOL" 1-7
 SFC 59 "RD_REC" 7-14
 Shipping and storage conditions 8-6
 Short circuit 7-34
 Signal level

- no signal level 2-1, 7-35
 - unstable 7-35
 - Signal level instable 2-1
 - Signaling system faults 7-4
 - SIMATIC NET 3-1
 - SIMATIC NET PROFIBUS cables..... 3-4, A-2
 - Slide 4-2
 - Spur lines 3-6
 - Standards 8-1
 - Statistics buffer 2-3
 - example 7-29
 - STEP 7 7-28
 - user program 7-20
 - Status LEDs 7-2
 - STEP 7
 - menu command for diagnostics 7-4
 - menu command for topology determination 1-8
 - versions 6-3
 - Strain relief 5-3
 - Stripping 5-3
 - Stripping tool 5-1
 - Stripping Tool 3-19
 - Supply voltage 5-2
 - Switch
 - BUS ADDRESS 1-6
 - DR ON 1-6
 - SEGMENT DP3 1-6
 - TERMINATOR DP1 1-6
 - System problems 1-3
- T**
- TAG 2-5
 - TDP_Monitoring 6-7
 - TDX_monitoring 2-6
 - TDX_Monitoring 6-7
 - Terminals 5-2
 - TERMINATOR DP1
 - connecting/disconnecting 5-4
 - example 3-9
 - TERMINATOR DP1 (switch) 1-6
 - Test device BT 200 3-19
 - Throughput time 8-9
 - Time
 - record format 2-4
 - setting 2-3
 - user program 2-4
 - Time stamp 7-15
- Tool
 - for mounting 4-1
 - for wiring 5-1
 - Topology determination
 - limits 6-9
 - Topology determination
 - carrying out 6-8
 - deactivating 6-7
 - Duration 6-9
 - how it works 1-8
 - not possible 7-37
 - preparation 6-8
 - user program 6-9
 - with COM PROFIBUS 6-8
 - with SFC 103 6-9
 - with STEP 7 6-8
 - Topology table
 - example 7-25
 - STEP 7 7-24
 - user program 7-14
 - Transfer rate 8-9
 - TSYNC diagnostic module 6-5, 7-13
 - TSYNC diagnostic status 7-13
- U**
- Ungrounded design 5-6
 - User questions
 - diagnostic messages C-5
 - difference to the RS 485 repeater C-3
 - topology and fault point determination C-1
- V**
- Valid interconnections 3-7
 - Voltages 8-10
- W**
- Weight 8-9
 - Wire break 7-34
 - Wire short circuit 7-34
- Z**
- Zone 2 8-12

SIEMENS

SIMATIC

Product Information

12/2006

Use of subassemblies/modules in a Zone 2 Hazardous Area

Language	Titel	Page
Deutsch	Einsatz der Baugruppen/Module im explosionsgeschützten Bereich Zone 2	2
English	Use of subassemblies/modules in a Zone 2 Hazardous Area	5
Français	Utilisation des modules / coupleurs dans la zone à risque d'explosion 2	8
Español	Aplicación de los módulos / tarjetas en áreas con peligro de explosión, zona 2	11
Italiano	Impiego delle unità/moduli nell'area a pericolo di esplosione zona 2	14
Nederlands	Gebruik van de componenten/modulen in het explosief gebied zone 2	17
Dansk	Brug af komponenter/moduler i det eksplosionsfarlige område zone 2	20
Suomi	Rakenneryhmien/moduulien käyttö räjähdysvaaranneuilla alueilla, vyöhyke 2	23
Svenska	Användning av komponentgrupperna/modulerna i explosionsriskområde zon 2	26
Português	Uso de grupos construtivos/módulos em área exposta ao perigo de explosão 2	29
Ελληνικά	Χρήση των δομικών συγκροτημάτων/μονάδων σε επικίνδυνη για έκρηξη περιοχή, ζώνη 2	32
Česky	Použití konstrukčních skupin / modulů v prostředí s nebezpečím výbuchu Zóna 2	35
Estnisch	Sõlmede/moodulite kasutamise plahvatusohtliku piirkonna tsoonis 2	38
Latviski	Ierīču/moduļu pielietojums sprādzienbīstamas teritorijas zonā 2	41
Lietuviška	Konstrukcinių grupių/modulių panaudojimas sprogioje 2 zonos aplinkoje	44
Magyar	A főegységek/modulok alkalmazása a 2. zóna robbanásveszélyes környezetben	47
Malti	Tqegħid tal-Komponenti / Modules fiż-Zona 2, fejn hemm Riskju ta' Splużjoni	50
Polski	Zastosowanie grup konstrukcyjnych / modułów w 2 strefie zagrożenia wybuchem	53
Slovensky	Použitie konštrukčných skupín / modulov v prostredí s nebezpečenstvom výbuchu zóny 2	56
Slovensko	Uporaba sklopov/modulov v eksplozivno ogroženem območju cone 2	59
Türkçe	Patlama tehlikesi olan Alan 2 bölgesinde ünite gruplarının/modüllerin kullanılması	62
Български	Използване на електронни блокове/модули във взривоопасната област Зона 2	65
Română	Utilizarea unităților constructive/modulelor în domeniul cu potențial exploziv din zona 2	68

Einsatz der Baugruppen/Module im explosionsgefährdeten Bereich Zone 2

Zugelassene Baugruppen/Module

Nachfolgend finden Sie wichtige Hinweise für die Installation der Baugruppen/Module im explosionsgefährdeten Bereich.

Die Liste mit den zugelassenen Baugruppen/Module finden Sie im Internet:

<http://support.automation.siemens.com/WW/view/de/>

Geben Sie auf dieser Webseite (im Suchfenster) die dazugehörige Beitrags-ID ein, *siehe Tabelle*.

Fertigungsort / Zulassung



II 3 G EEx nA II T3 .. T6 nach EN 60079-15 : 2003

Prüfnummer: siehe Tabelle

Fertigungsort	Baugruppen/Module	Prüfnummer	Beitrags-ID
Siemens AG, Bereich A&D Werner-von-Siemens- Straße 50 92224 Amberg Germany	ET 200S ET 200S Fehlersichere Module	KEMA 01 ATEX 1238X	24037700
	S7-300 ET 200M Buskopplung DP/PA Diagnoserepeater S7-300 Fehlersichere Baugruppen	KEMA 02 ATEX 1096X	24038475
	PROFIBUS- Busanschlussstecker	KEMA 04 ATEX 1151X	24028800
Siemens AG, Bereich A&D Östliche Rheinbrücken- straße 50 76187 Karlsruhe Germany	S7-400	KEMA 03 ATEX 1125X	21479867
	S7-300 CP TS Adapter II TS Adapter IE	KEMA 03 ATEX 1228X	21497622
	SIMATIC NET	KEMA 03 ATEX 1226X	21089482
	ET 200M Marshalled Termination Assemblies	KEMA 05 ATEX 1137X	24193554

Hinweis

Baugruppen/Module mit der Zulassung II 3 G EEx nA II T3 .. T6 dürfen nur in SIMATIC-Systemen der Gerätekategorie 3 eingesetzt werden.

Instandhaltung

Für eine Reparatur müssen die betroffene Baugruppen/Module an den Fertigungsort geschickt werden. Nur dort darf die Reparatur durchgeführt werden.

Besondere Bedingungen für:

KEMA 01 ATEX 1238X

KEMA 02 ATEX 1096X

KEMA 03 ATEX 1125X, ATEX 1226X, ATEX 1228X

1. Baugruppen/Module müssen in ein geeignetes Gehäuse eingebaut werden. Dieses Gehäuse muss mindestens die Schutzart IP 54 (nach EN 60529) gewährleisten. Dabei sind die Umgebungsbedingungen zu berücksichtigen, in denen das Gerät installiert wird. Für das Gehäuse muss eine Herstellererklärung für Zone 2 vorliegen (gemäß EN 60079-15).
2. Wenn am Kabel bzw. an der Kabeleinführung dieses Gehäuses unter Betriebsbedingungen eine Temperatur $> 70\text{ °C}$ erreicht wird oder wenn unter Betriebsbedingungen die Temperatur an der Aderverzweigung $> 80\text{ °C}$ sein kann, müssen die Temperatureigenschaften der Kabel mit den tatsächlich gemessenen Temperaturen übereinstimmen.
3. Die eingesetzten Kabeleinführungen müssen der geforderten IP-Schutzart und dem Abschnitt 6.2 (gemäß EN 60079-15) entsprechen.
4. Es müssen Maßnahmen getroffen werden, dass die Nennspannung durch Transienten um nicht mehr als 40 % überschritten werden kann.

Besondere Bedingungen für KEMA 04 ATEX 1151X

1. Die PROFIBUS-Busanschlussstecker müssen so installiert werden, dass sie vor mechanischer Gefahr geschützt sind.
2. Wenn das Eindringen von Feuchtigkeit und Staub nicht auszuschließen ist, sind die PROFIBUS-Busanschlussstecker Serie 6ES7972-... in ein geeignetes Gehäuse einzubauen. Dieses Gehäuse muss mindestens die Schutzart IP 54 (nach EN 60529) gewährleisten.
3. Die PROFIBUS-Busanschlussstecker müssen mit den mitgelieferten Schrauben vorschriftsgemäß befestigt werden.
4. Das Anschließen bzw. Trennen von spannungsführenden Leitern oder der Betätigung Geräteschalter, z.B Installations- oder Wartungszwecken, ist nur erlaubt wenn sichergestellt ist, dass der Bereich nicht explosionsgefährdet ist.

Besondere Bedingungen für KEMA 05 ATEX 1137X

1. Baugruppen/Module müssen in ein geeignetes Gehäuse eingebaut werden. Dieses Gehäuse muss mindestens die Schutzart IP 54 (nach EN 60529) gewährleisten. Dabei sind die Umgebungsbedingungen zu berücksichtigen, in denen das Gerät installiert wird. Für das Gehäuse muss eine Herstellererklärung für Zone 2 vorliegen (gemäß EN 60079-15).
2. Wenn am Kabel bzw. an der Kabeleinführung dieses Gehäuses unter Betriebsbedingungen eine Temperatur $> 70\text{ °C}$ erreicht wird oder wenn unter Betriebsbedingungen die Temperatur an der Aderverzweigung $> 80\text{ °C}$ sein kann, müssen die Temperatureigenschaften der Kabel mit den tatsächlich gemessenen Temperaturen übereinstimmen.
3. Es müssen Maßnahmen getroffen werden, dass die Nennspannung durch Transienten um nicht mehr als 40 % überschritten werden kann.

Weitere Informationen

Weitere Informationen zu den Baugruppen/Modulen finden Sie im dazugehörigen Handbuch.

Use of subassemblies/modules in a Zone 2 Hazardous Area

Approved devices/modules

Below you will find important information on the installation of the subassemblies/modules in a hazardous area.

You can find the list of approved devices/modules on the Internet:

<http://support.automation.siemens.com/WW/view/en/>

Enter the associated article ID in the search window on this website, see table.

Production Location / Certification



II 3 G

EEx nA II T3 .. T6

to EN 60079-15 : 2003

Test number: *see table below*

Production Location	Subassemblies/Modules	Test Number	Article ID
Siemens AG, Bereich A&D Werner-von-Siemens- Straße 50 92224 Amberg Germany	ET-200S ET 200S fault-tolerant modules	KEMA 01 ATEX 1238X	24037700
	S7-300 ET-200M DP/PA bus interface Diagnostics repeater S7-300 fault-tolerant modules	KEMA 02 ATEX 1096X	24038475
	PROFIBUS Bus Connector Plug	KEMA 04 ATEX 1151X	24028800
Siemens AG, Bereich A&D Östliche Rheinbrücken- straße 50 76187 Karlsruhe Germany	S7-400	KEMA 03 ATEX 1125X	21479867
	S7-300 CP TS Adapter II TS Adapter IE	KEMA 03 ATEX 1228X	21497622
	SIMATIC NET	KEMA 03 ATEX 1226X	21089482
	ET 200M Marshalled Termination Assemblies	KEMA 05 ATEX 1137X	24193554

Note

Subassemblies/modules with II 3 G EEx nA II T3 .. T6 certification can only be used in SIMATIC systems rated as category 3 equipment.

Maintenance

If repair is necessary, the affected subassemblies/modules must be sent to the production location. Repairs can only be carried out there.

Special conditions for:

KEMA 01 ATEX 1238X

KEMA 02 ATEX 1096X

KEMA 03 ATEX 1125X, ATEX 1226X, ATEX 1228X

1. Subassemblies/modules must be installed in an adequate housing. This must comply with the IP 54 degree of protection (according to EN 60529) as a minimum. The environmental conditions under which the equipment is installed must be taken into account. There must be a manufacturer's declaration for zone 2 available for the housing (in accordance with EN 60079-15).
2. If a temperature of > 70 °C is reached in the cable or at the cable entry of this housing under operating conditions, or if a temperature of > 80 °C can be reached at the junction of the conductors under operating conditions, the temperature-related properties of the cables must correspond to the temperatures actually measured.
3. The cable entries used must comply with the required IP degree of protection and Section 6.2 (in accordance with EN 60079-15).
4. Steps must be taken to ensure that the rated voltage through transients cannot be exceeded by more than 40 %.

Special Conditions for KEMA 04 ATEX 1151X

1. The PROFIBUS bus connector plugs must be installed so that they are protected from mechanical hazards.
2. If the ingress of moisture and dust cannot be ruled out, the PROFIBUS bus connection plugs series 6ES7972 ... are to be installed in a suitable housing. This housing must guarantee at least the protection type IP 54 (according to EN 60529).
3. The PROFIBUS bus connection plugs must be attached according to instructions using the supplied screws.
4. The connecting or disconnecting of live conductors or operation of device switches, e.g. for installation or servicing purposes is only allowed when it has been ensured that the area is not explosive.

Special Conditions for KEMA 05 ATEX 1137X

1. Subassemblies/modules must be installed in an adequate housing. This must comply with the IP 54 degree of protection (according to EN 60529) as a minimum. The environmental conditions under which the equipment is installed must be taken into account. There must be a manufacturer's declaration for zone 2 available for the housing (in accordance with EN 60079-15).
2. If a temperature of $> 70\text{ }^{\circ}\text{C}$ is reached in the cable or at the cable entry of this housing under operating conditions, or if a temperature of $> 80\text{ }^{\circ}\text{C}$ can be reached at the junction of the conductors under operating conditions, the temperature-related properties of the cables must correspond to the temperatures actually measured.
3. Steps must be taken to ensure that the rated voltage through transients cannot be exceeded by more than 40 %.

Further Information

You can find further information on devices/modules in the associated handbook.

Utilisation des modules / coupleurs dans la zone à risque d'explosion 2

Les modules de construction agréés

Vous trouverez ci-après des informations importantes pour l'installation de la station de périphérie décentralisée des modules / coupleurs dans la zone à risque d'explosion.

Vous trouverez une liste de modules de construction agréés sur internet

<http://support.automation.siemens.com/WW/view/fr/>

Entrez sur le site internet (dans la fenêtre de recherche), le numéro d'identification correspondant de l'article, voir tableau.

Lieu de fabrication / Homologation



II 3 G

EEx nA II T3 .. T6

selon EN 60079-15 : 2003

Numéro de contrôle : *voir tableau*

Lieu de fabrication	Modules de construction	Numéro de contrôle	Numéro d'ident. de l'article
Siemens AG, Bereich A&D Werner-von-Siemens- Straße 50 92224 Amberg Germany	ET 200S ET 200S Fehlersichere Module	KEMA 01 ATEX 1238X	24037700
	S7-300 ET 200M Buskopplung DP/PA Diagnoserepeater S7-300 Modules de sécurité anti-erreurs	KEMA 02 ATEX 1096X	24038475
	PROFIBUS-connecteur de bus	KEMA 04 ATEX 1151X	24028800
Siemens AG, Bereich A&D Östliche Rheinbrücken- straße 50 76187 Karlsruhe Germany	S7-400	KEMA 03 ATEX 1125X	21479867
	S7-300 CP TS Adapter II TS Adapter IE	KEMA 03 ATEX 1228X	21497622
	SIMATIC NET	KEMA 03 ATEX 1226X	21089482
	ET 200M Marshalled Termination Assemblies	KEMA 05 ATEX 1137X	24193554

Note

Les modules / coupleurs homologués  II 3 G EEx nA II T3 .. T6 ne peuvent être utilisés que dans des systèmes SIMATIC de catégorie 3.

Entretien

Si une réparation est nécessaire, le module / coupleur concerné doit être expédié au lieu de production. La réparation ne doit être effectuée qu'en ce lieu.

Conditions particulières pour :

KEMA 01	ATEX 1238X
KEMA 02	ATEX 1096X
KEMA 03	ATEX 1125X, ATEX 1226X, ATEX 1228X

1. Les modules / coupleurs doivent être installés dans un boîtier approprié. Celui-ci doit assurer au moins l'indice de protection IP 54 (selon EN 60529). Il faut alors tenir compte des conditions d'environnement dans lesquelles l'appareil est installé. Le boîtier doit faire l'objet d'une déclaration de conformité du fabricant pour la zone 2 (selon EN 60079-15).
2. Si dans les conditions d'exploitation, une température > 70 °C est atteinte au niveau du câble ou de l'entrée du câble dans ce boîtier, ou bien si la température au niveau de la dérivation des conducteurs peut être > 80 °C, les capacités de résistance thermique des câbles doivent correspondre aux températures effectivement mesurées.
3. Les entrées de câbles utilisées doivent avoir le niveau de protection IP exigé et être conformes au paragraphe 6.2 (selon EN 60079-15).
4. Il faut prendre des mesures pour que la tension nominale ne puisse pas être dépassée de plus de 40% sous l'influence de transitoires.

Conditions particulières pour KEMA 04 ATEX 1151X

1. Les connecteurs de bus PROFIBUS doivent être installés de manière à ce qu'ils soient protégés contre les dangers d'ordre mécanique.
2. Lorsqu'on ne peut éviter l'infiltration de l'humidité et de la poussière, il est indispensable de monter les connecteurs de bus PROFIBUS Série 6ES7972-... dans un boîtier approprié. Ce boîtier doit au moins répondre aux exigences du type de protection IP 54 (d'après la norme EN 60529).
3. Les connecteurs de bus PROFIBUS doivent être fixés de manière conforme, avec leurs vis correspondantes, disponibles lors de la livraison des produits.
4. la connexion ou la séparation des conducteurs sous tension électrique ou l'actionnement de commutateurs d'appareils comme par exemple lors des installations ou des maintenances n'est permise que lorsqu'on s'est assuré que la zone n'est pas sujette à des risques d'explosion.

Conditions particulières pour KEMA 05 ATEX 1137X

1. Les modules / coupleurs doivent être installés dans un boîtier approprié. Celui-ci doit assurer au moins l'indice de protection IP 54 (selon EN 60529). Il faut alors tenir compte des conditions d'environnement dans lesquelles l'appareil est installé. Le boîtier doit faire l'objet d'une déclaration de conformité du fabricant pour la zone 2 (selon EN 60079-15).
2. Si dans les conditions d'exploitation, une température > 70 °C est atteinte au niveau du câble ou de l'entrée du câble dans ce boîtier, ou bien si la température au niveau de la dérivation des conducteurs peut être > 80 °C, les capacités de résistance thermique des câbles doivent correspondre aux températures effectivement mesurées.
3. Il faut prendre des mesures pour que la tension nominale ne puisse pas être dépassée de plus de 40% sous l'influence de transitoires.

Informations supplémentaires

Vous trouverez des informations supplémentaires sur les modules de construction dans le manuel correspondant.

Aplicación de los módulos / tarjetas en áreas con peligro de explosión, zona 2

Grupos / Módulos permitidos

A continuación encontrará importantes informaciones para la instalación de los módulos / tarjetas en áreas con peligro de explosión.

Podrá encontrar la lista con los grupos y módulos en Internet:

<http://support.automation.siemens.com/WW/view/es/>

Indique en esta página Web (en la ventana de búsqueda) el ID del artículo correspondiente, véase *tabla*.

Lugar de fabricación / Homologación



II 3 G EEx nA II T3 .. T6

según la norma EN 60079-15 : 2003

Número de comprobación: véase *tabla*

Lugar de fabricación	Módulos / tarjetas	Número de comprobación	ID del artículo
Siemens AG, Bereich A&D Werner-von-Siemens- Straße 50 92224 Amberg Germany	ET 200S Grupos ET 200S a prueba de fallos	KEMA 01 ATEX 1238X	24037700
	S7-300 ET 200M Acoplamiento de bus DP/PA Repetidor de diagnóstico Grupos S7-300 a prueba de fallos	KEMA 02 ATEX 1096X	24038475
	Clavija de conexión de PROFIBUS	KEMA 04 ATEX 1151X	24028800
Siemens AG, Bereich A&D Östliche Rheinbrücken- straße 50 76187 Karlsruhe Germany	S7-400	KEMA 03 ATEX 1125X	21479867
	S7-300 CP TS Adapter II Adaptador TS IE	KEMA 03 ATEX 1228X	21497622
	SIMATIC NET	KEMA 03 ATEX 1226X	21089482
	ET 200M Marshallled Termination Assemblies	KEMA 05 ATEX 1137X	24193554

Nota

Los grupos y módulos con la autorización II 3 G EEx nA II T3 . T6 sólo podrán emplearse en sistemas SIMATIC de la categoría de equipos 3.

Mantenimiento

Para una reparación se ha de remitir el módulo / tarjeta afectado al lugar de fabricación. Sólo allí se puede realizar la reparación.

Condiciones especiales para:

KEMA 01 ATEX 1238X

KEMA 02 ATEX 1096X

KEMA 03 ATEX 1125X, ATEX 1226X, ATEX 1228X

1. Los módulos / tarjetas se han de montar en una carcasa apropiada. Esta carcasa debe garantizar como mínimo el grado de protección IP 54 (conforme a EN 60529). Para ello se han de tener en cuenta las condiciones ambientales, en las cuales se instala el equipo. La caja deberá contar con una declaración del fabricante para la zona 2 (conforme a EN 60079-15).
2. Si durante la operación se alcanzara una temperatura > 70° C en el cable o la entrada de cables de esta caja o bien una temperatura > 80° C en la bifurcación de hilos, deberán adaptarse las propiedades térmicas de los cables a las temperaturas medidas efectivamente.
3. Las entradas de cable utilizadas deben cumplir el grado de protección IP exigido y lo expuesto en el apartado 6.2 (conforme a EN 60079-15).
4. Es necesario adoptar las medidas necesarias para evitar que la tensión nominal pueda rebasar en más del 40 % debido a efectos transitorios.

Condiciones especiales para KEMA 04 ATEX 1151X

1. Las clavijas de conexión del PROFIBUS deberán instalarse de tal modo que queden protegidas de cualquier peligro mecánico.
2. Cuando no se pueda excluir la posibilidad de que la humedad y el polvo penetren en la clavija de conexión del PROFIBUS serie 6ES7972-... deberá montarla en una carcasa adecuada. Esta carcasa deberá garantizar como mínimo el tipo de protección IP 54 (según EN 60529).
3. Las clavijas de conexión del PROFIBUS deberán fijarse con los tornillos incluidos según lo previsto.
4. La conexión o la desconexión de conductores con energía aplicada o la activación de interruptores del aparato, p. ej., con fines de instalación o mantenimiento, sólo se permite si se garantiza que el área no sea potencialmente explosiva.

Condiciones especiales para KEMA 05 ATEX 1137X

1. Los módulos / tarjetas se han de montar en una carcasa apropiada. Esta carcasa debe garantizar como mínimo el grado de protección IP 54 (conforme a EN 60529). Para ello se han de tener en cuenta las condiciones ambientales, en las cuales se instala el equipo. La caja deberá contar con una declaración del fabricante para la zona 2 (conforme a EN 60079-15).
2. Si durante la operación se alcanzara una temperatura > 70° C en el cable o la entrada de cables de esta caja o bien una temperatura > 80° C en la bifurcación de hilos, deberán adaptarse las propiedades térmicas de los cables a las temperaturas medidas efectivamente.
3. Es necesario adoptar las medidas necesarias para evitar que la tensión nominal pueda rebasar en más del 40 % debido a efectos transitorios.

Otras informaciones

Encontrará otras informaciones relativas a los grupos y módulos en el manual correspondiente.

Impiego di unità/moduli nell'area a pericolo di esplosione zona 2

Unità/moduli omologati

Qui di seguito sono riportate delle avvertenze importanti per l'installazione delle unità/moduli nell'area a pericolo di esplosione.

L'elenco di unità/moduli omologati è reperibile in Internet:

<http://support.automation.siemens.com/WW/view/it/>

In questa pagina web (nella maschera di ricerca), inserire il relativo codice articolo, *vedi tabella*.

Luogo di produzione / Omologazione



II 3 G EEx nA II T3 .. T6 secondo EN 60079-15 : 2003

Numero di controllo: *vedi tabella*

Luogo di produzione	Unità/moduli	Numero di controllo	Codice articolo
Siemens AG, Bereich A&D Werner-von-Siemens- Straße 50 92224 Amberg Germany	ET 200S Unità ad elevata sicurezza ET 200S	KEMA 01 ATEX 1238X	24037700
	S7-300 ET 200M Accoppiamento di bus DP/PA Repeater di diagnostica Unità ad elevata sicurezza S7-300	KEMA 02 ATEX 1096X	24038475
	Connettore bus PROFIBUS	KEMA 04 ATEX 1151X	24028800
Siemens AG, Bereich A&D Östliche Rheinbrücken- straße 50 76187 Karlsruhe Germany	S7-400	KEMA 03 ATEX 1125X	21479867
	S7-300 CP TS Adapter II TS Adapter IE	KEMA 03 ATEX 1228X	21497622
	SIMATIC NET	KEMA 03 ATEX 1226X	21089482
	ET 200M Marshalled Termination Assemblies	KEMA 05 ATEX 1137X	24193554

Avvertenza

Le unità/moduli con l'omologazione  II 3 G EEx nA II T3 .. T6 possono essere impiegati solo nei sistemi SIMATIC della categoria di apparecchiature 3.

Manutenzione

Per una riparazione, le unità/i moduli interessati devono essere inviati al luogo di produzione. La riparazione può essere effettuata solo lì.

Condizioni particolari per:

KEMA 01 ATEX 1238X

KEMA 02 ATEX 1096X

KEMA 03 ATEX 1125X, ATEX 1226X, ATEX 1228X

1. Le unità/i moduli devono essere montati in un contenitore adatto. Questo contenitore deve assicurare almeno il tipo di protezione IP 54. In questo caso bisogna tenere conto delle condizioni ambientali nelle quali l'apparecchiatura viene installata. Per il contenitore deve essere presente una dichiarazione del costruttore per la zona 2 (secondo EN 60079-15).
2. Se nei cavi o nel loro punto di ingresso in questo contenitore viene raggiunta in condizioni di esercizio una temperatura > 70 °C o se in condizioni di esercizio la temperatura nella derivazione dei fili può essere > 80 °C, le caratteristiche di temperatura dei cavi devono essere conformi alla temperatura effettivamente misurata.
3. Gli ingressi dei cavi usati devono essere conformi al tipo di protezione richiesto e alla sezione 6.2 (secondo EN 60079-15).
4. Devono essere prese delle misure per evitare che la tensione nominale possa essere superata per più del 40% da parte di transienti.

Condizioni particolari per KEMA 04 ATEX 1151X

1. I connettori bus PROFIBUS devono essere installati in modo tale da non essere esposti a pericolo meccanico.
2. Se è impossibile escludere la penetrazione di umidità e polvere, i connettori bus PROFIBUS della serie 6ES7972-... devono essere installati in un contenitore adatto. Questo contenitore deve essere conforme almeno al tipo di protezione IP 54 (secondo EN 60529).
3. I connettori bus PROFIBUS devono essere assicurati mediante le viti allegate e secondo le disposizioni.
4. La connessione o l'interruzione di conduttori in tensione oppure l'azionamento di interruttori, per es. per eseguire l'installazione o la manutenzione, sono consentiti solo previa verifica dell'assenza del pericolo di esplosione nell'area.

Condizioni particolari per KEMA 05 ATEX 1137X

1. Le unità/i moduli devono essere montati in un contenitore adatto. Questo contenitore deve assicurare almeno il tipo di protezione IP 54 (secondo EN 60529). In questo caso bisogna tenere conto delle condizioni ambientali nelle quali l'apparecchiatura viene installata. Per il contenitore deve essere presente una dichiarazione del costruttore per la zona 2 (secondo EN 60079-15).
2. Se nei cavi o nel loro punto di ingresso in questo contenitore viene raggiunta in condizioni di esercizio una temperatura $> 70\text{ °C}$ o se in condizioni di esercizio la temperatura nella derivazione dei fili può essere $> 80\text{ °C}$, le caratteristiche di temperatura dei cavi devono essere conformi alla temperatura effettivamente misurata.
3. Devono essere prese delle misure per evitare che la tensione nominale possa essere superata per più del 40% da parte di transienti.

Ulteriori informazioni

Ulteriori informazioni relative a unità/moduli sono reperibili nel relativo manuale.

Gebruik van de componenten/modulen in het explosief gebied zone 2

Toegelaten componenten/modulen

Hierna vindt u belangrijke aanwijzingen voor de installatie van de componenten/modulen in het explosief gebied.

De lijst met de toegelaten componenten/modulens vindt u in het internet:

<http://support.automation.siemens.com/WW/view/en/>

Voer op deze website (in het zoekvenster) de bijhorende bijdrage-ID in, *zie tabel*.

Productieplaats / Vergunning



II 3 G

EEx nA II T3 .. T6

conform EN 60079-15 : 2003

Keuringsnummer: *zie tabel*

Productieplaats	Componenten/modulen	Keuringsnummer	Bijdrage-ID
Siemens AG, Bereich A&D Werner-von-Siemens-Straße 50 92224 Amberg Germany	ET 200S ET 200S tegen fouten beveiligde componenten	KEMA 01 ATEX 1238X	24037700
	S7-300 ET 200 M Buskoppeling DP/PA Diagnoserepeater S7-300 tegen fouten beveiligde componenten	KEMA 02 ATEX 1096X	24038475
	PROFIBUS- busaansluitstekker	KEMA 04 ATEX 1151X	24028800
Siemens AG, Bereich A&D Östliche Rheinbrücken- straße 50 76187 Karlsruhe Germany	S7-400	KEMA 03 ATEX 1125X	21479867
	S7-300 CP TS Adapter II TS Adapter IE	KEMA 03 ATEX 1228X	21497622
	SIMATIC NET	KEMA 03 ATEX 1226X	21089482
	ET 200M Marshalled Termination Assemblies	KEMA 05 ATEX 1137X	24193554

Opmerking

Componenten/modulen met de vergunning II 3 G EEx nA II T3 .. T6 mogen slechts worden gebruikt in SIMATIC-systemen van de apparaatcategorie 3.

Instandhouding

Voor een reparatie moeten de betreffende componenten/modulen naar de plaats van vervaardiging worden gestuurd. Alleen daar mag de reparatie worden uitgevoerd.

Speciale voorwaarden voor:

KEMA 01	ATEX 1238X
KEMA 02	ATEX 1096X
KEMA 03	ATEX 1125X, ATEX 1226X, ATEX 1228X

1. Componenten/modulen moeten worden ingebouwd in een geschikte behuizing. Deze behuizing moet minstens de veiligheidsgraad IP 54 waarborgen. Hierbij dient rekening te worden gehouden met de omgevingsvoorwaarden waarin het apparaat wordt geïnstalleerd. Voor de behuizing dient een verklaring van de fabrikant voor zone 2 te worden ingediend (volgens EN 60079-15).
2. Als aan de kabel of aan de kabelinvoering van deze behuizing onder bedrijfsomstandigheden een temperatuur wordt bereikt $> 70\text{ °C}$ of als onder bedrijfsomstandigheden de temperatuur aan de adertakking $> 80\text{ °C}$ kan zijn, moeten de temperatureigenschappen van de kabel overeenstemmen met de werkelijk gemeten temperaturen.
3. De aangebrachte kabelinvoeringen moeten de vereiste IP-veiligheidsgraad hebben en in overeenstemming zijn met alinea 6.2 (volgens EN 60079-15).
4. Er dienen maatregelen te worden getroffen, zodat de nominale spanning door transiënten met niet meer dan 40 % kan worden overschreden.

Bijzondere voorwaarden voor **KEMA 04 ATEX 1151X**

1. De PROFIBUS-aansluitstekkers moeten dusdanig worden geïnstalleerd, dat zij tegen mechanisch gevaar beschermd zijn.
2. Als het binnendringen van vocht en stof niet kan worden uitgesloten, dienen de PROFIBUS-busaansluitstekkers van de serie 6ES7972-... in een geschikte behuizing te worden gemonteerd. Deze behuizing moet minstens de veiligheidsgraad IP 54 (volgens EN 60529) waarborgen.
3. De PROFIBUS-busaansluitstekkers moeten met de meegeleverde schroeven zoals voorgeschreven worden bevestigd.
4. Het aansluiten of scheiden van spanningvoerende geleiders of het activeren van apparaatschakelaars, bijv. voor installatie- of onderhoudsdoeleinden, is slechts toegestaan als kan worden gewaarborgd dat het gebied niet explosief is.

Bijzondere voorwaarden voor KEMA 05 ATEX 1137X

1. Componenten/modulen moeten worden ingebouwd in een geschikte behuizing. Deze behuizing moet minstens de veiligheidsgraad IP 54 waarborgen. Hierbij dient rekening te worden gehouden met de omgevingsvoorwaarden waarin het apparaat wordt geïnstalleerd. Voor de behuizing dient een verklaring van de fabrikant voor zone 2 te worden ingediend (volgens EN 60079-15).
2. Als aan de kabel of aan de kabelinvoering van deze behuizing onder bedrijfsomstandigheden een temperatuur wordt bereikt $> 70\text{ }^{\circ}\text{C}$ of als onder bedrijfsomstandigheden de temperatuur aan de adertakking $> 80\text{ }^{\circ}\text{C}$ kan zijn, moeten de temperatureigenschappen van de kabel overeenstemmen met de werkelijk gemeten temperaturen.
3. Er dienen maatregelen te worden getroffen, zodat de nominale spanning door transiënten met niet meer dan 40 % kan worden overschreden.

Verdere informatie

Verdere informatie over de componenten/modulen vindt u in het bijhorende handboek.

Brug af komponenter/moduler i det eksplosionsfarlige område zone 2

Tilladte komponenter/moduler

I det følgende findes vigtige henvisninger vedr. installation af komponenter/moduler i det eksplosionsfarlige område.

En liste med de tilladte komponenter/moduler findes på internettet:

<http://support.automation.siemens.com/WW/view/en/>

Indtast på denne webside (i søgevinduet) det pågældende bidrags-ID, se *tabel*.

Produktionssted / Godkendelse



II 3 G

EEx nA II T3 .. T6

efter EN 60079-15 : 2003

Kontrolnummer: se *tabel*

Produktionssted	Komponenter/moduler	Kontrolnummer	Bidrags-ID
Siemens AG, Bereich A&D Werner-von-Siemens- Straße 50 92224 Amberg Germany	ET 200S ET 200S fejlsikre komponenter	KEMA 01 ATEX 1238X	24037700
	S7-300 ET 200M Buskobling DP/PA Diagnoserepeater S7-300 fejlsikre komponenter	KEMA 02 ATEX 1096X	24038475
	PROFIBUS- busadapterstik	KEMA 04 ATEX 1151X	24028800
Siemens AG, Bereich A&D Östliche Rheinbrücken- straße 50 76187 Karlsruhe Germany	S7-400	KEMA 03 ATEX 1125X	21479867
	S7-300 CP TS Adapter II TS Adapter IE	KEMA 03 ATEX 1228X	21497622
	SIMATIC NET	KEMA 03 ATEX 1226X	21089482
	ET 200M Marshalled Termination Assemblies	KEMA 05 ATEX 1137X	24193554

Bemærk

Komponenter/moduler med godkendelsen II 3 G EEx nA II T3 .. T6 må kun monteres i SIMATIC-systemer for udstyrskategori 3.

Vedligeholdelse

Hvis de pågældende komponenter/moduler skal repareres, bedes De sende dem til produktionsstedet. Reparation må kun udføres der.

Særlige betingelser for:

KEMA 01 ATEX 1238X

KEMA 02 ATEX 1096X

KEMA 03 ATEX 1125X, ATEX 1226X, ATEX 1228X

1. Komponenterne/modulerne skal monteres i et egnet kabinet. Dette kabinet skal mindst kunne sikre beskyttelsesklasse IP 54 (efter EN 60529). I denne forbindelse skal der tages højde for de omgivelsestemperaturer, i hvilke udstyret er installeret. Der skal være udarbejdet en erklæring fra fabrikanten for kabinettet for zone 2 (iht. EN 60079-15).
2. Hvis kablet eller kabelindføringen på dette kabinet når op på en temperatur på > 70 °C under driftsbetingelser eller hvis temperaturen på åreforegreningen kan være > 80 °C under driftsbetingelser, skal kablernes temperaturegenskaber stemme overens med de temperaturer, der rent faktisk måles.
3. De benyttede kabelindføringer skal være i overensstemmelse med den krævede IP-beskyttelsestype og afsnit 6.2 (iht. EN 60079-15).
4. Der skal træffes foranstaltninger, der sørger for, at den nominelle spænding via transienter ikke kan overskrides mere end 40 %.

Særlige betingelser for KEMA 04 ATEX 1151X

1. PROFIBUS-busadapterstik skal installeres således, at de er sikret mod mekanisk fare.
2. Hvis indtrængen af fugtighed og støv ikke kan udelukkes, skal PROFIBUS-busadapterstik serie 6ES7972-... monteres i et egnet kabinet. Dette kabinet skal mindst kunne sikre beskyttelsesklasse IP 54 (efter EN 60529).
3. PROFIBUS-busadapterstik skal fastgøres korrekt med de medleverede skruer.
4. Tilslutning eller afbrydelse af spændingsførende ledere eller betjening af apparatkontakter, f.eks. ved installation eller vedligeholdelse, er kun tilladt, hvis det kan sikres, at området ikke er eksplosionsfarligt.

Besondere Bedingungen für KEMA 05 ATEX 1137X

1. Komponenterne/modulerne skal monteres i et egnet kabinet. Dette kabinet skal mindst kunne sikre beskyttelsesklasse IP 54 (efter EN 60529). I denne forbindelse skal der tages højde for de omgivelsestemperaturer, i hvilke udstyret er installeret. Der skal være udarbejdet en erklæring fra fabrikanten for kabinettet for zone 2 (iht. EN 60079-15).
2. Hvis kablet eller kabelindføringen på dette kabinet når op på en temperatur på > 70 °C under driftsbetingelser eller hvis temperaturen på åreforegningen kan være > 80 °C under driftsbetingelser, skal kablernes temperaturegenskaber stemme overens med de temperaturer, der rent faktisk måles.
3. Der skal træffes foranstaltninger, der sørger for, at den nominelle spænding via transienter ikke kan overskrides mere end 40 %.

Yderligere informationer

Yderligere informationer om komponenterne/modulerne findes i den pågældende manual.

Rakenneryhmien/moduulien käyttö räjähdysvaarannetuilla alueilla, vyöhyke 2

Sallitut rakenneryhmät/moduulit

Seuraavasta löydätte tärkeitä ohjeita rakenneryhmien/moduulien asennukseen räjähdysvaarannetuilla alueilla.

Uusi: Luettelo sallituista rakenneryhmistä/moduuleista on Internetissä:

<http://support.automation.siemens.com/WW/view/en/>

Syötä tällä Internet-sivulla (hakuikkunassa) kyseinen käyttäjätunnus (ks. taulukko).

Valmistuspaikka / Hyväksyntä



II 3 G EEx nA II T3 - T6

EN 60079-15 : 2003 -standardin mukaan

Tarkastusnumero: *katso taulukko*

Valmistuspaikka	Rakenneryhmät/ moduulit	Tarkastusnum- ero	Käyttäjätun- nus
Siemens AG, Bereich A&D Werner-von-Siemens-Straße 50 92224 Amberg Germany	ET 200S ET 200S läpi-iskuvarmat rakenneryhmät	KEMA 01 ATEX 1238X	24037700
	S7-300 ET 200M Väyläkytkin DP/PA Dignositoistin S7-300 läpi-iskuvarmat rakenneryhmät	KEMA 02 ATEX 1096X	24038475
	PROFIBUS- väyläliitäntäpistoke		24028800
Siemens AG, Bereich A&D Östliche Rheinbrücken- straße 50 76187 Karlsruhe Germany	S7-400	KEMA 03 ATEX 1125X	21479867
	S7-300 CP TS Adapter II TS Adapter IE	KEMA 03 ATEX 1228X	21497622
	SIMATIC NET	KEMA 03 ATEX 1226X	21089482
	ET 200M Marshallled Termination Assemblies		24193554

Ohje

Rakenneryhmiä/moduuleja hyväksynnän II 3 G EEx nA II T3 - T6 kanssa saa käyttää ainoastaan laitekategorian 3 SIMATIC-järjestelmissä.

Kunnossapito

Korjausta varten täytyy kyseinen rakenneryhmä/moduuli lähettää valmistuspaikkaan. Korjaus voidaan suorittaa ainoastaan siellä.

Erityiset vaatimukset:

KEMA 01 ATEX 1238X

KEMA 02 ATEX 1096X

KEMA 03 ATEX 1125X, ATEX 1226X, ATEX 1228X

1. Rakenneryhmät/moduulit täytyy asentaa sopivaan koteloon. Tämän kotelon täytyy olla vähintään kotelointiluokan IP 54 mukaisia. Tällöin on huomioitava ympäristöolosuhteet, johon laite asennetaan. Kotelolle täytyy olla valmistajaselvitys vyöhykettä 2 varten (EN 60079-15 mukaan).
2. Kun johdolla tai tämän kotelon johdon sisäänviennillä saavutetaan $> 70\text{ °C}$ lämpötila tai kun käyttöolosuhteissa lämpötila voi pihajajaotuksella olla $> 80\text{ °C}$, täytyy johdon lämpötilaominaisuuksien vastata todellisesti mitattuja lämpötiloja.
3. Käytettyjen johtojen sisäänohjauksien täytyy olla vaaditun IP-kotelointiluokan ja kohdan 6.2 (EN 60079-15 mukaan) mukaisia.
4. Toimenpiteet täytyy suorittaa, ettei nimellisjännite voi transienttien kautta ylittyä enemmän kuin 40 %.

Erityiset vaatimukset rakenneryhmille KEMA 04 ATEX 1151X

1. PROFIBUS-väyläliitäntäpistokkeet on asennettava niin, että ne on suojattu mekaaniselta vaaralta.
2. Mikäli kosteuden ja pölyn pääsyä laitteen sisään ei voida poissulkea, sarjan 6ES7972 PROFIBUS-väyläliitäntäpistokkeet on asennettava sopivaan koteloon. Tämän kotelon on oltava vähintään kotelointiluokan IP 54 (EN 60529) mukainen.
3. PROFIBUS-väyläliitäntäpistokkeet on kiinnitettävä määräysten mukaisesti mukana toimitetuilla ruuveilla.
4. Jännitettä johtavien johdinten liittäminen ja irrottaminen tai laitekytkinten käyttäminen esimerkiksi asennus- tai huoltotarkoituksiin on sallittu ainoastaan silloin, kun on varmistettu, että alue ei ole räjähdysherkkä.

Erityiset vaatimukset rakenneryhmille KEMA 05 ATEX 1137X

1. Rakenneryhmät/moduulit täytyy asentaa sopivaan koteloon. Tämän kotelon täytyy olla vähintään koteloiluokan IP 54 mukaisia. Tällöin on huomioitava ympäristöolosuhteet, johon laite asennetaan. Kotelolle täytyy olla valmistajaselvitys vyöhykettä 2 varten (EN 60079-15 mukaan).
2. Kun johdolla tai tämän kotelon johdon sisäänviennillä saavutetaan $> 70\text{ °C}$ lämpötila tai kun käyttöolosuhteissa lämpötila voi pihajäätöksellä olla $> 80\text{ °C}$, täytyy johdon lämpötilaominaisuuksien vastata todellisesti mitattuja lämpötiloja.
3. Toimenpiteet täytyy suorittaa, ettei nimellisjännite voi transienttien kautta ylittyä enemmän kuin 40 %.

Lisätietoja

Lisätietoja rakenneryhmistä/moduuleista on asianomaisessa käsikirjassa.

Användning av komponentgrupperna/modulerna i explosionsriskområde zon 2

Tillåtna komponentgrupper/moduler

Nedan följer viktiga anvisningar om installationen av komponentgrupperna/modulerna i ett explosionsriskområde.

En lista över de tillåtna komponentgrupperna/modulerna finns på internet:

<http://support.automation.siemens.com/WW/view/en/>

Ange aktuellt bidrags-ID på webbplatsen (i sökfönstret), se *tabell*.

Tillverkningsort / Godkännande



II 3 G

EEx nA II T3 .. T6

enligt EN 60079 : 2003

Kontrollnummer: se *tabell*

Tillverkningsort	Komponentgrupper/ moduler	Kontroll- nummer	Bidrags-ID
Siemens AG, Bereich A&D Werner-von-Siemens-Straße 50 92224 Amberg Germany	ET 200S ET 200S Felsäkra moduler	KEMA 01 ATEX 1238X	24037700
	S7-300 ET 200M Busskoppling DP/PA Diagnosrepeater S7-300 Felsäkra komponentgrupper	KEMA 02 ATEX 1096X	24038475
	PROFIBUS- bussanslutningskontakt	KEMA 04 ATEX 1151X	24028800
Siemens AG, Bereich A&D Östliche Rheinbrücken- straße 50 76187 Karlsruhe Germany	S7-400	KEMA 03 ATEX 1125X	21479867
	S7-300 CP TS Adapter II TS Adapter IE	KEMA 03 ATEX 1228X	21497622
	SIMATIC NET	KEMA 03 ATEX 1226X	21089482
	ET 200M Kontrollerade termineringsenheter	KEMA 05 ATEX 1137X	24193554

Anvisning

Komponentgrupper/moduler med godkännande II 3 G EEx nA II T3 .. T6 får endast användas i SIMATIC-system i apparatgrupp 3.

Underhåll

Vid reparation måste den aktuella komponentgrupperna/modulerna insändas till tillverkaren. Reparationer får endast genomföras där.

Särskilda villkor för:

KEMA 01 ATEX 1238X

KEMA 02 ATEX 1096X

KEMA 03 ATEX 1125X, ATEX 1226X, ATEX 1228X

1. Komponentgrupperna/modulerna måste monteras i ett lämpligt hus. Huset måste minst vara av skyddsklass IP 54 (enligt EN 60529). Därvid ska omgivningsvillkoren där enheten installeras beaktas. För kåpan måste en tillverkardeklaration för zon 2 föreligga (enligt EN 60079-15).
2. Om en temperatur på > 70°C uppnås vid husets kabel resp kabelinföring under driftvillkor eller om temperaturen vid trådföringen kan vara > 80°C under driftvillkor, måste kabelns temperaturegenskaper överensstämma med den verkliga uppmätta temperaturen.
3. De använda kabelinföringarna måste uppfylla kraven i det krävda IP-skyddsutförandet och i avsnitt 6.2 (enligt EN 60079-15).
4. Åtgärder måste vidtas så, att märkspänningen ej kan överskridas med mer än 40 % genom transienter.

Särskilda villkor för KEMA 04 ATEX 1151X

1. PROFIBUS-bussanslutningskontakten ska installeras så att den är skyddad mot mekaniska faror.
2. Om det inte går att utesluta att fukt och damm kan tränga in ska PROFIBUS-bussanslutningskontakten serie 6ES7972-... monteras i ett lämpligt hus. Huset måste vara av minst skyddsklass IP 54 (enligt EN 60529).
3. PROFIBUS-bussanslutningskontakten måste fästas enligt anvisningarna med de bifogade skruvarna.
4. Anslutning och frånskiljning av spänningsförande ledare eller aktivering av enhetsbrytare vid t.ex. installation eller underhåll får endast utföras om det är säkerställt att det inte föreligger explosionsrisk i området.

Särskilda villkor för KEMA 05 ATEX 1137X

1. Komponentgrupperna/modulerna måste monteras i ett lämpligt hus. Huset måste minst vara av skyddsklass IP 54 (enligt EN 60529). Därvid ska omgivningsvillkoren där enheten installeras beaktas. För kåpan måste en tillverkardeklaration för zon 2 föreligga (enligt EN 60079-15).
2. Om en temperatur på $> 70^{\circ}\text{C}$ uppnås vid husets kabel resp kabelinföring under driftvillkor eller om temperaturen vid trådföringen kan vara $> 80^{\circ}\text{C}$ under driftvillkor, måste kabelns temperaturegenskaper överensstämma med den verkliga uppmätta temperaturen.
3. Åtgärder måste vidtas så, att märkspänningen ej kan överskridas med mer än 40 % genom transienter.

Ytterligare information

Ytterligare information om komponentgrupperna/modulerna finns i tillhörande handbok.

Uso de grupos construtivos/módulos em área exposta ao perigo de explosão 2

Grupos construtivos/módulos permitidos

A seguir, o encontrará avisos importantes para a instalação de grupos construtivos/ módulos em área exposta ao perigo de explosão.

A lista com os grupos construtivos/módulos autorizados encontram-se na Internet:

<http://support.automation.siemens.com/WW/view/en/>

Insira nesta página de web (na jenal de busca) o respectivo número de ID, *veja a tabela*.

Local de produção / Licença



II 3 G

EEx nA II T3 .. T6

seg. EN 60079-15 : 2003

Número de ensaio: *veja a tabela*

Local de produção	Grupos construtivos/módulos	Nº de ensaio	Nº de ID
Siemens AG, Bereich A&D Werner-von-Siemens- Straße 50 92224 Amberg Alemanha	ET 200S ET 200S Grupos construtivos protegidos contra erro	KEMA 01 ATEX 1238X	24037700
	S7-300 ET 200M Acoplador bus DP/PA Repetidor de diagnóstico S7-300 Grupos construtivos protegidos contra erro	KEMA 02 ATEX 1096X	24038475
	Ficha de conexão do bus PROFIBUS	KEMA 04 ATEX 1151X	24028800
Siemens AG, Bereich A&D Östliche Rheinbrücken- straße 50 76187 Karlsruhe Alemanha	S7-400	KEMA 03 ATEX 1125X	21479867
	S7-300 CP TS Adapter II TS Adapter IE	KEMA 03 ATEX 1228X	21497622
	SIMATIC NET	KEMA 03 ATEX 1226X	21089482
	ET 200M Marshallled Termination Assemblies	KEMA 05 ATEX 1137X	24193554

Aviso

Os grupos construtivos/módulos com a licença II 3 G EEx nA II T3 .. T6 só podem ser aplicados em sistemas SIMATIC da categoria de aparelho 3.

Reparo

Os grupos construtivos/módulos em questão devem ser remetidos para o local de produção a fim de que seja realizado o reparo. Apenas lá deve ser efectuado o reparo.

Condições especiais para:

KEMA 01 ATEX 1238X

KEMA 02 ATEX 1096X

KEMA 03 ATEX 1125X, ATEX 1226X, ATEX 1228X

1. Os grupos construtivos/módulos devem ser montados em uma caixa adequada. Esta caixa deve garantir no mínimo o tipo de protecção IP 54 (seg. EN 60529). Durante este trabalho deverão ser levados em consideração as condições locais, nas quais o aparelho será instalado. Para a caixa deverá ser apresentada uma declaração do fabricante para a zona 2 (de acordo com EN 60079-15).
2. Caso no cabo ou na entrada do cabo desta carcaça sob as condições operacionais seja atingida uma temperatura de $> 70\text{ }^{\circ}\text{C}$, ou caso sob condições operacionais a temperatura na ramificação do fio poderá atingir $> 80\text{ }^{\circ}\text{C}$, as características de temperatura deverão corresponder às temperaturas realmente medidas.
3. As entradas de cabo utilizadas devem corresponder ao tipo exigido de protecção IP e à secção 6.2 (de acordo com o EN 60079-15).
4. Precisam ser tomadas medidas para que a tensão nominal através de transitórios não possa ser ultrapassada em mais que 40 %.

Condições especiais para KEMA 04 ATEX 1151X

1. As fichas de conexão do bus PROFIBUS devem ser instaladas de modo que fiquem protegidas contra perigo mecânico.
2. Se a entrada de humidade e poeira não puder ser excluída, as fichas de conexão de bus PROFIBUS série 6ES7972-... devem ser montadas em uma caixa adequada. Esta caixa deve garantir a protecção mínima IP 54 (seg. EN 60529).
3. As fichas de conexão de bus PROFIBUS deve ser fixadas com os parafusos fornecidos, de acordo com as prescrições.
4. A conexão ou separação de condutores de tensão ou o accionamento de interruptores de aparelhos, p. ex. para fins de reparação ou instalação, só é permitida quando se pode garantir que a área não está exposta ao risco de explosão.

Condições especiais para KEMA 05 ATEX 1137X

1. Os grupos construtivos/módulos devem ser montados numa caixa adequada. Esta caixa deve garantir a protecção mínima IP 54 (seg. EN 60529). Para isso, as condições de ambiente, nas quais o aparelho é instalado, devem ser consideradas. Para a caixa, deve haver uma declaração do fabricante para a zona 2 (seg. EN 60079-15).
2. Se no cabo ou condutor do cabo desta caixa, sob condições de serviço, uma temperatura de $> 70\text{ °C}$ for alcançada ou se, sob condições de serviço, a temperatura da derivação do condutor puder ser de $> 80\text{ °C}$, as características de temperatura dos cabos devem coincidir com as temperaturas reais medidas.
3. Precisam ser tomadas medidas para que a tensão nominal através de transitórios não possa ser ultrapassada em mais que 40 %.

Outras informações

Outras informações sobre os grupos construtivos/módulos podem ser encontradas no respectivo manual.

Χρήση των δομικών συγκροτημάτων/μονάδων σε επικίνδυνη για έκρηξη περιοχή, ζώνη 2

Επιτρεπόμενα δομικά συγκροτήματα/μονάδες

Στη συνέχεια θα βρείτε σημαντικές υποδείξεις για την εγκατάσταση των δομικών συγκροτημάτων/μονάδων σε επικίνδυνη για έκρηξη περιοχή.

Νέο: Τη λίστα με τα επιτρεπόμενα δομικά συγκροτήματα/μονάδες θα τη βρείτε στο διαδίκτυο (Internet):

<http://support.automation.siemens.com/WW/view/en/>

Εισάγετε σε αυτή την ιστοσελίδα (στο παράθυρο αναζήτησης) το αντίστοιχο ID άρθρου, βλέπε πίνακα.

Τόπος κατασκευής / Άδεια



II 3 G EEx nA II T3 .. T6 σύμφωνα με το πρότυπο EN 60079-15 : 2003

Αριθμός ελέγχου: βλέπε πίνακα

Τόπος κατασκευής	Δομικά συγκροτήματα/μονάδες	Αιθμ. ελέγχου	ID άρθρου
Siemens AG, Bereich A&D Werner-von-Siemens- Straße 50 92224 Amberg Germany	ET 200S ET 200S Ασφαλή σε περίπτωση βλάβης δομικά συγκροτήματα	KEMA 01 ATEX 1238X	24037700
	S7-300 ET 200M Σύζευξη διαύλου DP/PA Επαναλήπτης διάγνωσης S7-300 Ασφαλή σε περίπτωση βλάβης δομικά συγκροτήματα	KEMA 02 ATEX 1096X	24038475
	Φις σύνδεσης του διαύλου PROFIBUS	KEMA 04 ATEX 1151X	24028800
Siemens AG, Bereich A&D Östliche Rheinbrücken- straße 50 76187 Karlsruhe Germany	S7-400	KEMA 03 ATEX 1125X	21479867
	S7-300 CP TS προσαρμογέας II TS προσαρμογέας IE	KEMA 03 ATEX 1228X	21497622
	SIMATIC NET	KEMA 03 ATEX 1226X	21089482
	ET 200M Marshalled Termination Assemblies	KEMA 05 ATEX 1137X	24193554

Υπόδειξη

Δομικά συγκροτήματα/μονάδες με την έγκριση  II 3 G EEx nA II T3 .. T6 επιτρέπεται να χρησιμοποιούνται μόνο σε συστήματα SIMATIC της κατηγορίας συσκευής 3

Συντήρηση

Για μια επισκευή πρέπει να σταλθούν τα αντίστοιχα δομικά συγκροτήματα/μονάδες στον τόπο κατασκευής. Μόνο εκεί επιτρέπεται να γίνει η επισκευή.

Ιδιαίτερες προϋποθέσεις για:

KEMA 01 ATEX 1238X

KEMA 02 ATEX 1096X

KEMA 03 ATEX 1125X, ATEX 1226X, ATEX 1228X

1. Τα δομικά συγκροτήματα/μονάδες πρέπει να ενσωματωθούν σε ένα γειωμένο περίβλημα. Αυτό το περίβλημα πρέπει να εξασφαλίζει το λιγότερο το βαθμό προστασίας IP 54 (κατά EN 60529). Σε αυτήν την περίπτωση πρέπει να ληφθούν υπόψη οι περιβαλλοντικές συνθήκες, στις οποίες θα εγκατασταθεί η συσκευή. Για το περίβλημα πρέπει να προβλέπεται δήλωση του κατασκευαστή για τη ζώνη 2 (σύμφωνα με το πρότυπο EN 60079-15).
2. Εάν στο καλώδιο ή στην είσοδο του καλωδίου αυτού του περιβλήματος κάτω από συνθήκες λειτουργίας η θερμοκρασία ξεπεράσει τους 70 °C ή όταν κάτω από συνθήκες λειτουργίας η θερμοκρασία στη διακλάδωση του σύρματος μπορεί να είναι μεγαλύτερη από 80 °C, πρέπει οι θερμοκρασιακές ιδιότητες των καλωδίων να ταυτίζονται με τις πραγματικά μετρημένες θερμοκρασίες.
3. Οι χρησιμοποιούμενες εισόδους καλωδίων πρέπει να συμμορφώνονται με το βαθμό προστασίας IP 54 στην ενότητα 6.2 (σύμφωνα με το πρότυπο EN 60079-15).
4. Πρέπει να ληφθούν μέτρα, να μην μπορεί να γίνει υπέρβαση της ονομαστικής τάσης μέσω αιφνίδιας μεταβολής της τάσης πάνω από 40 %.

Ιδιαίτερες προϋποθέσεις για KEMA 04 ATEX 1151X

1. Τα φις σύνδεσης του διαύλου PROFIBUS πρέπει να εγκατασταθούν έτσι, ώστε να προστατεύονται από μηχανικό κίνδυνο.
2. Όταν η είσοδος υγρασίας και σκόνης δεν μπορεί να αποκλειστεί, τότε πρέπει τα φις σύνδεσης του διαύλου PROFIBUS σειρά 6ES7972-... να τοποθετηθούν σε ένα κατάλληλο περίβλημα. Αυτό το περίβλημα πρέπει να εξασφαλίζει το ελάχιστο το βαθμός προστασίας IP 54 (σύμφωνα με το πρότυπο EN 60529).
3. Τα φις σύνδεσης του διαύλου PROFIBUS πρέπει να στερεωθούν με τις συνημμένες βίδες σύμφωνα με τις προδιαγραφές.
4. Η σύνδεση ή η αποσύνδεση ηλεκτροφόρων αγωγών ή ο χειρισμός του διακόπτη της συσκευής, π.χ. για λόγους εγκατάστασης ή συντήρησης, επιτρέπεται μόνο, όταν είναι εξασφαλισμένο, ότι η περιοχή δεν είναι μια επικίνδυνη για έκρηξη περιοχή.

Ιδιαίτερες προϋποθέσεις για ΚΕΜΑ 05 ΑTEX 1137Χ

1. Τα δομικά συγκροτήματα/μονάδες πρέπει να ενσωματωθούν σε ένα γειωμένο περίβλημα. Αυτό το περίβλημα πρέπει να εξασφαλίζει το λιγότερο το βαθμό προστασίας IP 54 (κατά EN 60529). Σε αυτήν την περίπτωση πρέπει να ληφθούν υπόψη οι περιβαλλοντικές συνθήκες, στις οποίες θα εγκατασταθεί η συσκευή. Για το περίβλημα πρέπει να προβλέπεται δήλωση του κατασκευαστή για τη ζώνη 2 (σύμφωνα με το πρότυπο EN 60079-15).
2. Εάν στο καλώδιο ή στην είσοδο του καλωδίου αυτού του περιβλήματος κάτω από συνθήκες λειτουργίας η θερμοκρασία ξεπεράσει τους 70 °C ή όταν κάτω από συνθήκες λειτουργίας η θερμοκρασία στη διακλάδωση του σύρματος μπορεί να είναι μεγαλύτερη από 80 °C, πρέπει οι θερμοκρασιακές ιδιότητες των καλωδίων να ταυτίζονται με τις πραγματικά μετρημένες θερμοκρασίες.
3. Πρέπει να ληφθούν μέτρα, να μην μπορεί να γίνει υπέρβαση της ονομαστικής τάσης μέσω αιφνίδιας μεταβολής της τάσης πάνω από 40 %.

Περισσότερες πληροφορίες

Περαιτέρω πληροφορίες για τα δομικά συγκροτήματα/μονάδες θα βρείτε στο αντίστοιχο εγχειρίδιο.

Použití konstrukčních skupin / modulů v prostředí s nebezpečím výbuchu Zóna 2

Schválené konstrukční skupiny/moduly

Dále naleznete důležité pokyny pro instalaci konstrukčních skupin/modulů v oblastech s nebezpečím výbuchu.

Seznam schválených konstrukčních skupin/modulů naleznete na internetu:

<http://support.automation.siemens.com/WW/view/en/>

Na této internetové stránce zadejte do vyhledávacího okna příslušné identifikační číslo příspěvku. *Viz tabulka.*

Místo výroby / Registrace



II 3 G

EEx nA II T3 .. T6

dle EN 60079-15 : 2003

Zkušební číslo: viz tabulka

Místo výroby	Konstrukční skupiny/Moduly	Kontrolní číslo	ID příspěvku
Siemens AG, Bereich A&D Werner-von-Siemens- Straße 50 92224 Amberg Germany	ET 200S ET 200S Konstrukční skupiny odolné proti chybám	KEMA 01 ATEX 1238X	24037700
	S7-300 ET 200M Spojka sběrnice DP/PA Diagnostické translační relé S7-300 Konstrukční skupiny odolné proti chybám	KEMA 02 ATEX 1096X	24038475
	PROFIBUS- Busanschlussstecker	KEMA 04 ATEX 1151X	24028800
Siemens AG, Bereich A&D Östliche Rheinbrücken- straße 50 76187 Karlsruhe Germany	S7-400	KEMA 03 ATEX 1125X	21479867
	S7-300 CP TS Adapter II TS Adapter IE	KEMA 03 ATEX 1228X	21497622
	SIMATIC NET	KEMA 03 ATEX 1226X	21089482
	ET 200M Marshallled Termination Assemblies	KEMA 05 ATEX 1137X	24193554

Upozornění

Konstrukční skupiny/Moduly s osvědčením II 3 G EEx nA II T3 .. T6 smějí být použity pouze v systémech SIMATIC, přístrojové kategorie 3.

Údržba

K opravě musí být příslušné konstrukční skupiny/moduly zaslány do výrobního místa. Oprava smí být provedena pouze zde.

Zvláštní podmínky pro:

KEMA 01 ATEX 1238X

KEMA 02 ATEX 1096X

KEMA 03 ATEX 1125X, ATEX 1226X, ATEX 1228X

1. Konstrukční skupiny/moduly musí být zabudovány ve vhodném krytu. Tento kryt musí zajišťovat minimálně druh ochrany IP 54 (dle EN 60529). Přitom je nutno respektovat okolní podmínky, v nichž je přístroj instalován. Pro kryt musí být k dispozici prohlášení výrobce pro zónu 2 (dle EN 60079-15).
2. Pokud je na kabelu popř. kabelovém vedení tohoto krytu dosaženo za provozních podmínek teploty > 70 °C, nebo když za provozních podmínek může být na kabelových větvích teplota > 80 °C, musí teplotní vlastnosti kabelu souhlasit se skutečně naměřenými teplotami.
3. Použité kabelové přívody musí odpovídat požadovanému druhu krytí IP a odstavci 6.2 (dle EN 60079-15).
4. Musí být provedena opatření k zamezení přechodného překročení jmenovitého napětí, nepřesahující více než 40 %.

Zvláštní podmínky pro KEMA 04 ATEX 1151X

1. Přípojné konektory sběrnice PROFIBUS musí být nainstalovány tak, aby byly chráněny před mechanickým rizikem.
2. Pokud není možno zabránit průniku vlhkosti a prachu, je nutno přípojné konektory sběrnice PROFIBUS série 6ES7972-... zabudovat do vhodného krytu. Tento kryt musí zajišťovat minimálně druh krytí IP 54 (podle EN 60529).
3. Přípojné konektory sběrnice PROFIBUS musí být předpisově upevněny pomocí dodaných šroubů.
4. Připojení, popř. odpojení vodičů pod napětím nebo sepnutí spínačů přístrojů, např. za účelem instalace nebo údržby, je povoleno pouze tehdy, pokud je zajištěno, že oblast není ohrožena explozí.

Zvláštní podmínky pro KEMA 05 ATEX 1137X

1. Konstrukční skupiny/moduly musí být zabudovány ve vhodném krytu. Tento kryt musí zajišťovat minimálně druh krytí IP 54 (podle EN 60529). Přitom je nutno respektovat okolní podmínky, v nichž je přístroj instalován. Pro kryt musí být k dispozici prohlášení výrobce pro zónu 2 (dle EN 60079-15).
2. Pokud je na kabelu popř. kabelovém vedení tohoto krytu dosaženo za provozních podmínek teploty $> 70\text{ }^{\circ}\text{C}$, nebo když za provozních podmínek může být na kabelových větvích teplota $> 80\text{ }^{\circ}\text{C}$, musí teplotní vlastnosti kabelu souhlasit se skutečně naměřenými teplotami.
3. Musí být provedena opatření k zamezení přechodného překročení jmenovitého napětí, nepřesahující více než 40 %.

Další informace

Další informace ke konstrukčním skupinám/modulům naleznete v příslušné příručce.

Sõlmede/moodulite kasutamine plahvatusohtliku piirkonna tsoonis 2

Lubatud sõlmed/moodulid

Järgnevalt leiate Te olulisi juhiseid sõlmede/moodulite paigaldamiseks plahvatusohtlikus piirkonnas.

Üksikasjaliku teabe lubatud sõlmede/moodulite kohta leiate Internetist:

<http://support.automation.siemens.com/WW/view/en/>

Sisestage sellel veebilehel (otsinguaknasse) vastav kood, vt tabelit.

Valmistamiskoht / Kasutusluba



II 3 G EEx nA II T3 .. T6 vastavalt standardile 60079-15 : 2003

Katsetusnumber: vaadake tabelit

Valmistamiskoht	Sõlmed/moodulid	Katsetusnumber	Kood
Siemens AG, Bereich A&D Werner-von-Siemens-Straße 50 92224 Amberg Germany	ET 200S ET 200S rikkekindlad moodulid	KEMA 01 ATEX 1238X	24037700
	S7-300 ET 200M siiniühendus DP/PA diagnostikarepiiter S7-300 rikkekindlad sõlmed	KEMA 02 ATEX 1096X	24038475
	PROFIBUS-siiniühenduse pistik	KEMA 04 ATEX 1151X	24028800
Siemens AG, Bereich A&D Östliche Rheinbrücken- straße 50, 76187 Karlsruhe Germany	S7-400	KEMA 03 ATEX 1125X	21479867
	S7-300 CP TS adapter II TS adapter IE	KEMA 03 ATEX 1228X	21497622
	SIMATIC NET	KEMA 03 ATEX 1226X	21089482
	ET 200M juhitavad klemmliideste sõlmed	KEMA 05 ATEX 1137X	24193554

Juhis

Sõlmi/mooduleid kasutusloaga II 3 G EEx nA II T3 .. T6 tohib kasutada ainult SIMATIC-süsteemides, mille seadmeklass on 3.

Korrashoid

Parandamiseks tuleb sõlmed/moodulid saata valmistamiskohta. Parandustöid tohib teha ainult seal.

Eritingimused

KEMA 01	ATEX 1238X
KEMA 02	ATEX 1096X
KEMA 03	ATEX 1125X, ATEX 1226X, ATEX 1228X

kohta:

1. Sõlmed/moodulid tuleb monteerida sobivasse metallkorpusesse. Korpus peab tagama kaitseastme vähemalt IP 54 (vastavalt standardile EN 60529). Seejuures peab arvesse võtma seadme paigaldamise keskkonna tingimusi. Korpuse jaoks peab tsooni 2 jaoks olema tootja juhis (vastavalt standardile EN 60079-15).
2. Kui selle korpuse kaabli juures või kaabelvaheliku (kaabelsisestuse) juures töötingimustes saavutatakse temperatuur > 70 °C või, kui töötingimustes temperatuur soone hargnemiskoha juures võib olla > 80 °C, peavad kaabli termilised omadused olema vastavuses tegelikult mõõdetud temperatuuridega.
3. Kasutatavad kaabelvahelikud (kaabelsisestused) peavad vastama nõutud IP-kaitseastmele ja osas 6.2 toodud nõuetele (vastavalt standardile EN 60079-15).
4. Peab rakendama abinõusid, et nimipinget üleminekute tõttu ei saaks ületada üle 40 %.

Eritingimused KEMA 04 ATEX 1151X kohta

1. PROFIBUS-siiniühenduse pistik tuleb paigaldada selliselt, et see oleks kaitstud mehaanilise ohu eest.
2. Juhul kui niiskuse ja tolmu sissetungimist ei saa vältida, tuleb 6ES7972-... seeria PROFIBUS-siiniühenduse pistikud paigaldada sobivasse korpusesse. See korpus peab tagama vähemalt kaitseklassile IP 54 (vastavalt standardile EN 60529).
3. PROFIBUS-siiniühenduse pistikud tuleb kinnitada ettenähtud viisil kaasasolevate kruvidega.
4. Pinget juhtivate juhtide ühendamine või eemaldamine või seadme lüliti käivitamine, nt paigaldus- ja hoolduseesmärkidel, on lubatud ainult juhul, kui piirkond ei ole plahvatusohtlik.

Eritingimused KEMA 05 ATEX 1137X kohta

1. Sõlmed/moodulid tuleb monteerida sobivasse metallkorpusesse. Korpus peab tagama kaitseastme vähemalt IP 54 (vastavalt standardile EN 60529). Seejuures peab arvesse võtma seadme paigaldamise keskkonna tingimusi. Korpuse jaoks peab tsooni 2 jaoks olema tootja juhis (vastavalt standardile EN 60079-15).
2. Kui selle korpuse kaabli juures või kaabelvaheliku (kaabelsisestuse) juures töötingimustes saavutatakse temperatuur > 70 °C või, kui töötingimustes temperatuur soone hargnemiskoha juures võib olla > 80 °C, peavad kaabli termilised omadused olema vastavuses tegelikult mõõdetud temperatuuridega.
3. Peab rakendama abinõusid, et nimipinget üleminekute tõttu ei saaks ületada üle 40 %.

Täpsem teave

Täpsemat teavet sõlmede/moodulite kohta leiate kaasasolevast käsiraamatust.

Ierīču/moduļu pielietojums sprādzienbīstamas teritorijas zonā 2

Pieļaujamās ierīces/moduļi

Turpmāk atrodamas svarīgas norādes par ierīču/moduļu uzstādīšanu sprādzienbīstamajā zonā.

Sarakstu ar pieļaujamajām ierīcēm/moduļiem Jūs atradīsiet internetā:

<http://support.automation.siemens.com/WW/view/en/>

Ievadiet šajā mājas lapā (meklēšanas logā) attiecīgo lietotāja ID, *skatīt tabulu*

Izgatavošanas vieta / Atļauja



II 3 G

EEx nA II T3 .. T6

saskaņā ar EN 60079-15 : 2003

Pārbaudes numurs: *skatīt tabulu*

Izgatavošanas vieta	Ierīces/moduļi	Pārbaudes numurs	Lietotāja ID
Siemens AG, Bereich A&D Werner-von-Siemens-Straße 50 92224 Amberg Germany	ET 200S ET 200S Fehlersichere Module	KEMA 01 ATEX 1238X	24037700
	S7-300 ET 200M Kopnes savienotājs DP/PA Diagnostikas atkārtotājs S7-300 Pret kļūdām aizsargātas ierīces	KEMA 02 ATEX 1096X	24038475
	PROFIBUS slēdzis	KEMA 04 ATEX 1151X	24028800
Siemens AG, Bereich A&D Östliche Rheinbrückenstraße 50 76187 Karlsruhe Germany	S7-400	KEMA 03 ATEX 1125X	21479867
	S7-300 CP TS Adapter II TS Adapter IE	KEMA 03 ATEX 1228X	21497622
	SIMATIC NET	KEMA 03 ATEX 1226X	21089482
	ET 200M Marshalled Termination Assemblies	KEMA 05 ATEX 1137X	24193554

Norāde

Ierīces/moduļi ar atļauju  II 3 G EEx nA II T3 .. T6 var tikt pielietotas tikai 3.kategorijas SIMATIC sistēmās.

Tehniskā apkope

Attiecīgu ierīču/moduļu remontam tie ir jānosūta ražotājam. Remontu drīkst veikt tikai tur.

Īpaši apstākļi priekš

KEMA 01	ATEX 1238X
KEMA 02	ATEX 1096X
KEMA 03	ATEX 1125X, ATEX 1226X, ATEX 1228X

1. Ierīces/moduļi jāiebūvē piemērotā metāla korpusā. Tiem jānodrošina aizsardzības līmenis ne mazāks kā IP 54 (saskaņā ar EN 60529). Turklāt, ierīces uzstādīšanā jāievēro apkārtējas vides apstākļi. Korpusam ir nepieciešams izgatavotāja apliecinājums zonai 2 (saskaņā ar EN 60079-15).
2. Ja uz kabeļa vai šī korpusa kabeļu ievades ekspluatācijas apstākļos tiek sasniegta temperatūra > 70 °C vai ja ekspluatācijas apstākļos uz kabeļa atzariem var būt temperatūra > 80 °C, kabeļu temperatūras īpašībām jāatbilst faktiski nomērītām temperatūrām.
3. Pielietojamām kabeļu ievadēm jāatbilst nepieciešamajam aizsardzības veidam IP un sadaļai 6.2 (saskaņā ar EN 60079-15).
4. Nepieciešams veikt pasākumus, lai pārejas spriegums nepārsniegtu nominālo spriegumu vairāk kā par 40 %.

Īpašie noteikumi KEMA 04 ATEX 1151X

1. PROFIBUS slēdžus ir jāinstalē tā, lai tie būtu aizsargāti no mehāniskām briesmām
2. Ja nav iespējams izvairīties no šķidrumu un putekļu iekļūšanas, tad PROFIBUS slēdžus no sērijas 6ES7972-... ir jāiebūvē piemērotā korpusā. Šim korpusam ir jāatbilst vismaz drošības veids IP 54 (pēc E N 60529).
3. PROFIBUS slēdžus ir jāpiestiprina ar komplektā ietilpstošajām skrūvēm.
4. Spriegumu vadošu vadu pieslēgšana vai atslēgšana vai ierīces slēdža lietošana, piemēram, uzstādīšanas vai tehniskās apkopes dēļ, ir atļauta tikai tad, kad ir noskaidrots vai zonā nepastāv eksplodēšanas iespējamība.

Īpaši noteikumi KEMA 05 ATEX 1137X

1. Ierīces/moduļi ir jāiebūvē piemērotā korpusā. Šiem korpusiem ir jāatbilst vismaz drošības veids IP 54 (pēc E N 60529). Pie tam ir jāņem vērā apkārtnes faktori, kādā ierīce tiks uzstādīta. Korpusam jāatbilst ražotāja 2. zonas deklarācijai (saskaņā ar EN 60079-15).
2. Ja šī korpusa kabelis, respektīvi, kabeļa ievade darba laikā sasniedz $> 70\text{ °C}$ vai, ja darba laikā vadu sazarojums ir sasniedzis $> 80\text{ °C}$, tad kabeļa temperatūras īpašībām ir jāatbilst izmēritajām temperatūrām.
3. Ir jāveic pasākumi, lai nominālais spriegums caur pārejām nepārsniegtu 40%

Papildus informācija

Papildus informāciju par ierīcēm/moduļiem Jūs atradīsiet pievienotajā rokasgrāmatā.

Konstruktinių grupių / modulių panaudojimas sprogyje 2 zonos aplinkoje

Leistinos konstrukcinės grupės / moduliai

Toliau pateikiama svarbi informacija apie konstrukcinių grupių ir modulių montavimą sprogyje aplinkoje.

Leistinių konstrukcinių grupių / modulių sąrašą rasite interneto svetainėje:

<http://support.automation.siemens.com/WW/view/en/>

[veskite šioje svetainėje (į ieškos laukelį) atitinkamą kodą, žr. lentelę.

Pagaminimo vieta / Saugos reikalavimai



II 3 G

EEx nA II T3 .. T6

pagal EN 60079-15 : 2003

Patikros numeris: žr. lentelėje

Pagaminimo vieta	Konstrukcinės grupės / moduliai	Patikros numeris	Kodas
Siemens AG, Bereich A&D Werner-von-Siemens- Straße 50 92224 Ambergas Vokietija	ET 200S ET 200S nuo trukdžių apsaugotos konstrukcinės grupės	KEMA 01 ATEX 1238X	24037700
	S7-300 ET 200M Magistralinė jungtis DP/PA Diagnozės retransliatorius S7-300 nuo trukdžių apsaugotos konstrukcinės grupės	KEMA 02 ATEX 1096X	24038475
	PROFIBUS magistralinės jungties kištukas	KEMA 04 ATEX 1151X	24028800
Siemens AG, Bereich A&D Östliche Rheinbrücken- straße 50 76187 Karlsruhe Vokietija	S7-400	KEMA 03 ATEX 1125X	21479867
	S7-300 CP TS Adapter II TS Adapter IE	KEMA 03 ATEX 1228X	21497622
	SIMATIC NET	KEMA 03 ATEX 1226X	21089482
	ET 200M Marshallled Termination Assemblies	KEMA 05 ATEX 1137X	24193554

Nuoroda

Konstruktines grupes / modulius, kurių leidimas eksploatuoti yra II 3 G EEx nA II T3 .. T6, galima naudoti tik 3 kategorijos sistemose „SIMATIC“.

Priežiūra

Sugedusią konstrukcinę grupę / modulį išsiųskite gamintojui. Tik jis gali kvalifikuotai suremontuoti įtaisą.

Specialiosios sąlygos, taikomos

KEMA 01 ATEX 1238X

KEMA 02 ATEX 1096X

KEMA 03 ATEX 1125X, ATEX 1226X, ATEX 1228X

1. Konstrukcinės grupės / moduliai turi būti įrengiami tik tinkamuose korpusuose. Šio korpuso saugos klasė turi būti mažiausiai „IP 54“ (pagal EN 60529). Būtina atsižvelgti į kitas aplinkos, kurioje įrengtas įtaisas, sąlygas. Norint korpusą eksploatuoti zonoje 2, būtinas gamintojo pažymėjimas (pagal EN 60079-15).
2. Jei korpuso kabelio arba kabelio prijungimo temperatūra pakyla daugiau nei 70 °C arba laidų atšakoje temperatūra padidėja daugiau nei 80 °C, reikia naudoti kabelius, kurių terminės savybės atitinka išmatuotas temperatūros vertes.
3. Kabelių sujungimai turi būti saugos klasės IP ir atitikti 6.2 skyriaus (pagal EN 60079-15) reikalavimus.
4. Būtina imtis priemonių, kad pereinamųjų grandžių nominali įtampa neviršytų 40 %.

Specialiosios sąlygos, taikomos KEMA 04 ATEX 1151X

1. PROFIBUS magistralinės jungties kištukas turi būti įmontuotas taip, kad būtų apsaugotas nuo mechaninių pažeidimų.
2. Jeigu galimas drėgmės ir dulkių poveikis, 6ES7972-... serijos PROFIBUS magistralinės jungties kištukas įmontuojamas specialiaame korpuse. Šio korpuso saugos klasė turi būti mažiausiai „IP 54“ (pagal EN 60529).
3. PROFIBUS magistralinės jungties kištukas turi būti tvirtinamas pagal instrukciją, naudojant kartu pateikiamus varžtus.
4. Prijungti arba atjungti įtampos linijas arba naudotis prietaiso jungikliu, pvz., instaliavimo arba priežiūros darbų metu, leidžiama tik įsitikinus, kad aplinka nėra sprogi.

Specialiosios sąlygos, taikomos KEMA 05 ATEX 1137X

1. Konstrukcinės grupės / moduliai turi būti įrengiami tik tinkamuose korpusuose. Šio korpuso saugos klasė turi būti mažiausiai „IP 54“ (pagal EN 60529). Būtina atsižvelgti į kitas aplinkos, kurioje įrengtas įtaisas, sąlygas. Norint korpusą eksploatuoti zonoje 2, būtinas gamintojo pažymėjimas (pagal EN 60079-15).
2. Jei korpuso kabelio arba kabelio prijungimo temperatūra pakyla daugiau nei 70 °C arba laidų atšakoje temperatūra padidėja daugiau nei 80 °C, reikia naudoti kabelius, kurių terminės savybės atitinka išmatuotas temperatūros vertes.
3. Būtina imtis priemonių, kad pereinamųjų grandžių nominali įtampa neviršytų 40 %.

Papildoma informacija

Papildomos informacijos apie konstrukcines grupes / modulius rasite eksploatacijos vadove.

A főegységek/modulok alkalmazása a 2. zóna robbanásveszélyes környezetben

Engedélyezett főegységek/modulok

A következőkben fontos utasításokat talál a főegységek/modulok telepítéséhez a robbanásveszélyes környezetbe.

Az engedélyezett főegységek/modulok jegyzékét megtalálja az Interneten:

<http://support.automation.siemens.com/WW/view/en/>

Ezen a web-oldalon írja be a kereső ablakba a hozzá tartozó bejegyzés ID-t, *ld. a táblázatban.*

Gyártási hely / Engedélyezés



II 3 G EEx nA II T3 .. T6 az EN 60079-15 : 2003 szerint

Ellenőrző szám: lásd a táblázatot

Gyártási hely	Főegységek/modulok	Bevizsgálás száma	Bejegyzés száma
Siemens AG, Bereich A&D Werner-von-Siemens- Straße 50 92224 Amberg Germany	ET 200S ET 200S hibabiztos főegységek	KEMA 01 ATEX 1238X	24037700
	S7-300 ET 200M DP/PA buszcsatoló Diagnózisrepeater S7-300 hibabiztos főegységek	KEMA 02 ATEX 1096X	24038475
	PROFIBUS- busz csatlakozó dugó	KEMA 04 ATEX 1151X	24028800
Siemens AG, Bereich A&D Östliche Rheinbrücken- straße 50 76187 Karlsruhe Germany	S7-400	KEMA 03 ATEX 1125X	21479867
	S7-300 CP TS Adapter II TS Adapter IE	KEMA 03 ATEX 1228X	21497622
	SIMATIC NET	KEMA 03 ATEX 1226X	21089482
	ET 200M Marshalled Termination Assemblies	KEMA 05 ATEX 1137X	24193554

Utasítás

Csak a II 3 G EEx nA II T3 .. T6 engedélyezéssel rendelkező főegységeket/modulokat használhatja a 3. felszerelés-kategóriába tartozó SIMATIC rendszerekbe.

Karbantartás

Javításra küldje az érintett főegységeket/modulokat a gyártási helyre. Csak itt hajthatják végre a javítást.

Különleges feltételek a következők számára:

KEMA 01	ATEX 1238X
KEMA 02	ATEX 1096X
KEMA 03	ATEX 1125X, ATEX 1226X, ATEX 1228X

1. A főegységeket/modulokat egy erre alkalmas házba kell beszerelni. Ez a ház rendelkezzen legalább az IP 54 védetségű fokozattal (EN 60529 szerint). Itt figyelembe kell venni azokat a környezeti feltételeket, amelyek a készülék telepítésekor fellépnek. A ház rendelkezzen a 2. zónára vonatkozó gyártói nyilatkozat (az EN 60079-15 szerint).
2. Ha az adott ház kábelén ill. kábelvezetésén üzemi körülmények között a hőmérséklet $> 70\text{ °C}$, vagy ha az üzemi körülmények között az érelágazásokon a hőmérséklet $> 80\text{ °C}$, akkor a kábel hőmérsékleti tulajdonságai egyezzenek meg a ténylegesen mért hőmérsékletekkel.
3. Az alkalmazott kábelvezetések feleljenek meg az előírt IP védetségű fokozatnak és a 6.2. bekezdésnek (EN 60079-15 szerint).
4. Gondoskodjon róla, hogy a tranziensek a névleges feszültséget ne lépjék túl több mint 40 %-al.

Különleges feltételek a KEMA 04 ATEX 1151X-hez

1. A PROFIBUS busz csatlakozó dugót úgy kell beszerelni, hogy mechanikai veszélyeztetéstől védett legyen.
2. Ha por és nedvesség behatolását nem lehet kizárni, a 6ES7972-... sorozatú PROFIBUS busz csatlakozó dugót kell egy alkalmas házba beépíteni. Ez a ház rendelkezzen az IP 54 védetségű fokozattal (EN 60529 szerint).
3. A PROFIBUS busz csatlakozó dugót a vele szállított csavarokkal óvatosan kell rögzíteni.
4. A feszültséget vezető vezeték bekötése vagy leválasztása, vagy készülék kapcsolók működtetése (pl. szerelési- vagy gondozási célokból) csak akkor szabad, ha biztosították, hogy a terület ne legyen robbanásveszélyes.

Különleges feltételek a KEMA 05 ATEX 1137X-hez

1. A főegységeket/modulokat egy erre alkalmas házba kell beszerelni. Ez a ház rendelkezzen legalább az IP 54 védetség fokozattal (EN 60529 szerint). Itt figyelembe kell venni azokat a környezeti feltételeket, amelyek a készülék telepítésekor fellépnek. A ház rendelkezzen a 2. zónára vonatkozó gyártói nyilatkozat (az EN 60079-15 szerint).
2. Ha a jelen ház kábelén ill. kábelvezetésen üzemi körülmények között a hőmérséklet $> 70\text{ °C}$, vagy ha az üzemi körülmények között az érelágazásokon a hőmérséklet $> 80\text{ °C}$, akkor a kábel hőmérsékleti tulajdonságai legyenek azonosak a ténylegesen mért hőmérsékletekkel.
3. Gondoskodjon róla, hogy a transziensek ne lépjenek túl több mint 40 %-al a névleges feszültséget.

További információk

A főegységek/modulokról további információkat talál a hozzá tartozó kézikönyvben.

Tqeghid tal-Komponenti / Modules fiż-Żona 2, fejn hemm Riskju ta' Splużjoni

Komponenti/Moduli approvati

Hawn taħt għandek issib indikazzjonijiet importanti għall-installazzjoni ta' komponenti / *modules* f'żona fejn hemm riskju ta' splużjoni.

Ġdid: Tista' tara l-lista ta' komponenti/modules approvati fuq l-internet:

<http://support.automation.siemens.com/WW/view/en/>

Dañħal fis-*search window* ta' din il-websajt l-ID rispettiv ta' l-oġġett, *ara t-tabella*.

Post ta' Manifattura / Approvazzjoni



II 3 G EEx nA II T3 .. T6 b'mod konformi ma' EN 60079-15 : 2003

Numru tač-Ċertifikat: ara t-tabella

Post ta' Manifattura	Komponenti / Modules	Numru tač-Ċertifikat	Numru tač-Ċertifikat
Siemens AG, Bereich A&D Werner-von-Siemens-Straße 50 92224 Amberg Il-Ġermanja	ET 200S <i>Modules ET 200S fail-safe</i>	KEMA 01 ATEX 1238X	24037700
	S7-300 ET 200M <i>bus coupling DP/PA</i> Ripetitur ta' dijanjosi <i>Modules S7-300 fail-safe</i>	KEMA 02 ATEX 1096X	24038475
	PROFIBUS-Bus Connector Plug	KEMA 04 ATEX 1151X	24028800
Siemens AG, Bereich A&D Östliche Rheinbrücken- straße 50 76187 Karlsruhe Il-Ġermanja	S7-400	KEMA 03 ATEX 1125X	21479867
	S7-300 CP TS Adapter TS Adaptor IE	KEMA 03 ATEX 1228X	21497622
	SIMATIC NET	KEMA 03 ATEX 1226X	21089482
	ET 200M Marshalled Terminal Assemblies	KEMA 05 ATEX 1137X	24193554

Nota

Komponenti / *modules* approvati II 3 G EEx nA II T3 .. T6 jistgħu jintużaw biss f'sistemi SIMATIC li jappartienu għal appart ta' kategorija 3.

Manutenzjoni

Fil-każ li jkollhom bżonn tiswija, il-komponenti / *modules* ikkonċernati għandhom jintbagħtu fil-post ta' manifattura. It-tiswijiet jistgħu jsiru biss f'dan il-post.

Kundizzjonijiet Speċjali għal:

KEMA 01	ATEX 1238X
KEMA 02	ATEX 1096X
KEMA 03	ATEX 1125X, ATEX 1226X, ATEX 1228X

1. Komponenti / *modules* għandhom jiġu mmontati ġewwa l-qugħ addattat. Dan l-ilqugħ għandu jggarantixxi protezzjoni li tkun mill-inqas tat-tip IP 54 (skond EN 60529). Inti u tagħmel hekk, trid taħseb għall-kundizzjonijiet ambjentali ta' waqt l-installazzjoni ta' l-apparat. Għall-ilqugħ, irid ikun hemm dikjarazzjoni tal-fabbrikant li tgħid li dan huwa tajjeb għaż-żona 2 (skond EN 60079-15).
2. Jekk fil-kejbil, jew fil-kaxxa mad-daħla għall-kejbil, tintlaħaq temperatura ta' aktar minn 70 °C taħt kundizzjonijiet ta' ħidma, jew jekk fil-post fejn jinfirdu l-wajers jista' jkun hemm temperatura ogħla minn 80 °C, il-kejbil irid ikollu karatteristiċi li jfilu għal dawn it-temperaturi.
3. Id-daħliet għall-kejbil li jintużaw iridu jikkonformaw mat-tip ta' protezzjoni IP mitluba u mat-taqsim 6.2 (skond EN 60079-15).
4. Iridu jittieħdu miżuri biex il-vultaġġ nominali ma jinqabizx b'aktar minn 40%.

Kundizzjonijiet speċjali għal KEMA 04 ATEX 1151X

1. Il-plugs tat-tip PROFIBUS-Bus Connector jeħtieġu jiġu installati b'mod li jiżgura protezzjoni kontra kull periklu mekkaniku.
2. Jekk id-dħul ta' l-umdità jew tat-trab ma jistax jiġi eskluż, jeħtieġu jiġu installati plugs tat-tip PROFIBUS-Bus Connector tan-Numru Serjali 6ES7972-... f'ilqugħ adegwat. Dan l-ilqugħ jeħtieġ jissodisfa l-klassi ta' protezzjoni IP 54 (b'mod konformi ma' EN 60529) bħala standard minimu.
3. Il-plugs tat-tip PROFIBUS-Connector jeħtieġu jiġu installati skond l-istruzzjonijiet u bil-viti pprovduti.
4. It-tqabbid u/jew skonnettjar ta' wajers bil-kurrent fihom u l-użu ta' swiċċijiet, jiġifieri għal għanijiet ta' installazzjoni jew manutenzjoni huwa permess biss jekk iż-żona m'hijix waħda li fiha riskju ta' splużjoni.

Kundizzjonijiet speċjali għal KEMA 05 ATEX 1137X

1. Komponenti / *modules* għandhom jiġu mmontati ġewwa lqugħ addattat. Dan l-ilqugħ għandu jggarantixxi protezzjoni li tkun mill-inqas tat-tip IP 54 (skond EN 60529). Inti u tagħmel hekk, trid taħseb għall-kundizzjonijiet ambjentali ta' waqt l-installazzjoni ta' l-apparat. Għall-ilqugħ, irid ikun hemm dikjarazzjoni tal-fabbrikant li tgħid li dan huwa tajjeb għaż-żona 2 (skond EN 60079-15).
2. Jekk fil-kejbil, jew fil-kaxxa mad-daħla għall-kejbil, tintlaħaq temperatura ta' aktar minn 70 °C taħt kundizzjonijiet ta' ħidma, jew jekk fil-post fejn jinfirdu l-wajers jista' jkun hemm temperatura oġġla minn 80 °C, il-kejbil irid ikollu karatteristiċi li jifilħu għal dawn it-temperaturi.
3. Iridu jittieħdu miżuri biex il-vultaġġ nominali ma jinqabizx b'aktar minn 40%.

Aktar informazzjoni

Għal iktar informazzjoni dwar il-komponenti/moduli, jekk jogħġbok irreferi għall-manwal rispettiv.

Zastosowanie grup konstrukcyjnych / modułów w 2 strefie zagrożenia wybuchem

Dopuszczone grupy konstrukcyjne/moduły

Poniżej znajdują się ważne informacje dotyczące instalacji grup konstrukcyjnych modułów w strefie zagrożenia wybuchem.

Lista dopuszczonych grup konstrukcyjnych/modułów znajduje się w Internecie pod adresem <http://support.automation.siemens.com/WW/view/en/>

Na tej stronie należy wprowadzić odpowiedni ID udziału, patrz tabela.

Miejsce produkcji / Rejestracja



II 3 G EEx nA II T3 .. T6

stosownie do EN 60079-15 : 2003

Nr testu: zobacz tabela

Miejsce produkcji	Grupy konstrukcyjne/moduły	Nr testu	ID udziału
Siemens AG, Bereich A&D Werner-von-Siemens- Straße 50 92224 Amberg Niemcy	ET 200S ET 200S moduły odporne na uszkodzenia	KEMA 01 ATEX 1238X	24037700
	S7-300 ET 200M Zbierające łącze sprzężające DP/PA Powtarzacz diagnozy S7-300 grupy odporne na uszkodzenia	KEMA 02 ATEX 1096X	24038475
	PROFIBUS-szynowy wtyk przyłączeniowy	KEMA 04 ATEX 1151X	24028800
Siemens AG, Bereich A&D Östliche Rheinbrücken- straße 50 76187 Karlsruhe Niemcy	S7-400	KEMA 03 ATEX 1125X	21479867
	S7-300 CP TS Adapter II TS Adapter IE	KEMA 03 ATEX 1228X	21497622
	SIMATIC NET	KEMA 03 ATEX 1226X	21089482
	ET 200M Marshalled Termination Assemblies	KEMA 05 ATEX 1137X	24193554

Uwaga

Grupy konstrukcyjne / moduły zarejestrowane jako II 3 G EEx nA II T3 .. T6 wolno stosować jedynie w systemach SIMATIC o 3 kategorii urządzenia.

Konserwacja

W celu naprawy należy odpowiednie grupy konstrukcyjne / moduły przesać do miejsca produkcji. Jedynie serwis producenta jest upoważniony do dokonywania napraw.

Warunki szczególne dla:

KEMA 01 ATEX 1238X

KEMA 02 ATEX 1096X

KEMA 03 ATEX 1125X, ATEX 1226X, ATEX 1228X

1. Grupy konstrukcyjne / moduły muszą zostać zamontowane do odpowiedniej puszkii ochronnej. Puszki muszą spełniać wymagania co najmniej stopnia IP 54 (stosownie do EN 60529). Należy brać pod uwagę warunki otoczenia, w którym urządzenie będzie instalowane. Należy posiadać oświadczenie producenta dopuszczające puszkę do użytku w strefie 2 (stosownie do EN 60079-15).
2. W przypadku, gdyby na przewodzie tej puszkii podczas pracy temperatura mogła przekroczyć $> 70\text{ }^{\circ}\text{C}$, lub żyła przewodu mogłaby osiągnąć temperaturę $> 80\text{ }^{\circ}\text{C}$, właściwości cieplne przewodu muszą zostać dobrane do takich wartości.
3. Wszystkie stosowane przewody muszą odpowiadać właściwemu stopniowi ochrony IP oraz warunkom określonym w punkcie 6.2 (stosownie do EN 60079-15).
4. Muszą zostać spełnione takie warunki, aby napięcie miana w przejściach nie mogło przekroczyć więcej niż 40 %.

Warunki szczególne dla KEMA 04 ATEX 1151X

1. Wtyki przyłączeniowe PROFIBUS muszą być zamontowane w sposób chroniący przed uszkodzeniami mechanicznymi.
2. Jeżeli nie można wykluczyć wnikania wilgoci i kurzu wtyki przyłączeniowe PROFIBUS serii 6ES7972... należy zamontować w odpowiedniej puszcze. Puszki muszą spełniać wymagania co najmniej stopnia IP 54 (stosownie do EN 60529).
3. Wtyki przyłączeniowe PROFIBUS muszą być unieruchomione zgodnie z przepisami przy pomocy załączonych śrub.
4. Podłączanie lub rozłączanie przewodów będących pod napięciem lub uruchamianie przełączników urządzenia np. do prac instalacyjno - konserwacyjnych jest dozwolone wyłącznie po upewnieniu się, że obszar nie jest zagrożony wybuchem.

Warunki szczególne dla KEMA 05 ATEX 1137X

1. Grupy konstrukcyjne / moduły muszą zostać zamontowane do odpowiedniej puszkii ochronnej. Puszki muszą spełniać wymagania co najmniej stopnia IP 54 (stosownie do EN 60529). Należy brać pod uwagę warunki otoczenia, w którym urządzenie będzie instalowane. Należy posiadać oświadczenie producenta dopuszczające puszkę do użytku w strefie 2 (stosownie do EN 60079-15).
2. W przypadku, gdyby na przewodzie tej puszki podczas pracy temperatura mogła przekroczyć $> 70\text{ }^{\circ}\text{C}$, lub żyła przewodu mogłaby osiągnąć temperaturę $> 80\text{ }^{\circ}\text{C}$, właściwości cieplne przewodu muszą zostać dobrane do takich wartości.
3. Muszą zostać spełnione takie warunki, aby napięcie miana w przejściach nie mogło przekroczyć więcej niż 40 %.

Pozostałe informacje

Pozostałe informacje dotyczące grup konstrukcyjnych/modułów znajdują się w stosownych podręcznikach.

Použitie konštrukčných skupín / modulov v prostredí s nebezpečenstvom výbuchu zóny 2

Schválené konštrukčné skupiny / moduly

Ďalej nájdete dôležité pokyny pre inštaláciu konštrukčných skupín / modulov v prostredí s nebezpečenstvom výbuchu.

Zoznam schválených konštrukčných skupín / modulov nájdete na internete:

<http://support.automation.siemens.com/WW/view/en/>

Na tejto Web-stránke (v okienku vyhľadávania) zadajte príslušné identifikačné číslo danej položky, *pozri Tabuľku*.

Miesto vyhotovenia / Osvedčenie



II 3 G EEx nA II T3 .. T6

podľa EN 60079-15 : 2003

Číslo skúšky : *pozri tabuľka*

Miesto vyhotovenia	Konštrukčné skupiny / moduly	Číslo skúšky	Identifikačné číslo položky
Siemens AG, divízia A&D Werner-von-Siemens- Straße 50 92224 Amberg Nemecko	ET 200S ET 200S konštrukčné skupiny odolné voči poruchám	KEMA 01 ATEX 1238X	24037700
	S7-300 ET 200M Zbernicový väzbový člen DP/PA opakovač diagnózy S7-300 konštrukčné skupiny odolné voči poruchám	KEMA 02 ATEX 1096X	24038475
	PROFIBUS-Zbernicová ukončovacia prípojka	KEMA 04 ATEX 1151X	24028800
Siemens AG, divízia A&D Östliche Rheinbrücken- straße 50 76187 Karlsruhe Nemecko	S7-400	KEMA 03 ATEX 1125X	21479867
	S7-300 CP TS Adapter II TS Adapter IE	KEMA 03 ATEX 1228X	21497622
	SIMATIC NET	KEMA 03 ATEX 1226X	21089482
	ET 200M Marshalled Termination Assemblies	KEMA 05 ATEX 1137X	24193554

Upozornenie

Konštrukčné skupiny / moduly s osvedčením II 3 G EEx nA II T3 .. T6 sa smú používať len v systémoch SIMATIC kategórie zariadenia 3.

Údržba

Za účelom opravy sa musia príslušné konštrukčné skupiny / moduly zaslať na miesto vyhotovenia. Oprava sa smie vykonávať len na tomto mieste !

Špeciálne podmienky pre:

KEMA 01	ATEX 1238X
KEMA 02	ATEX 1096X
KEMA 03	ATEX 1125X, ATEX 1226X, ATEX 1228X

1. Konštrukčné skupiny / moduly sa musia vmontovať do vhodnej schránky. Táto schránka musí zabezpečovať druh ochrany minimálne IP 54 (podľa EN 60529). Pritom je potrebné zohľadniť podmienky prostredia, do ktorého sa bude zariadenie inštalovať. V prípade puzdra musí existovať vyhlásenie výrobcu pre zónu 2 (podľa EN 60079-15).
2. V prípade, že na kábli, prípadne na káblovom prívode tohto puzdra presiahne teplota pri prevádzkových podmienkach hodnotu > 70 °C, alebo ak na vetve žily môže byť pri prevádzkových podmienkach teplota > 80 °C, musia tepelné vlastnosti kábla vyhovovať skutočne nameraným hodnotám.
3. Všetky použité káblové prívody musia zodpovedať požadovanému druhu ochrany IP a odseku 6.2 (podľa EN 60079-15).
4. Musia sa vykonať také opatrenia, aby sa menovité napätie cez prechody nemohlo prekročiť o viac ako 40 %.

Špeciálne podmienky pre KEMA 04 ATEX 1151X:

1. Zbernicové ukončovacie prípojky musia byť namontované tak, aby boli chránené pred mechanickým poškodením.
2. Ak nie je úplne vylúčený prienik vlhkosti a prachu, zbernicové ukončovacie prípojky PROFIBUS série 6ES7972-... je potrebné zabudovať do vhodnej schránky. Táto schránka musí zabezpečovať druh ochrany minimálne IP 54 (podľa EN 60529).
3. Zbernicové ukončovacie prípojky PROFIBUS musia byť pripevnené s dodanými skrutkami podľa predpisov.
4. Pripojenie resp. odpojenie vodičov pod napätím alebo uvedenie prístrojového spínača do prevádzky, napr. na účely inštalácie alebo údržby je povolené len potom, ako bolo preverené, že v prostredí nehrozí nebezpečenstvo výbuchu.

Špeciálne podmienky pre KEMA 05 ATEX 1137X

1. Konštrukčné skupiny / moduly sa musia vmontovať do vhodnej schránky. Táto schránka musí zabezpečovať druh ochrany minimálne IP 54 (podľa EN 60529). Pritom je potrebné zohľadniť podmienky prostredia, do ktorého sa bude zariadenie inštalovať. V prípade puzdra musí existovať vyhlásenie výrobcu pre zónu 2 (podľa EN 60079-15).
2. V prípade, že na kábli, prípadne na káblovom prívode tohto puzdra presiahne teplota pri prevádzkových podmienkach hodnotu $> 70\text{ }^{\circ}\text{C}$, alebo ak na vetve žily môže byť pri prevádzkových podmienkach teplota $> 80\text{ }^{\circ}\text{C}$, musia tepelné vlastnosti kábla vyhovovať skutočne nameraným hodnotám.
3. Musia sa vykonať také opatrenia, aby sa menovité napätie cez prechody nemohlo prekročiť o viac ako 40 %.

Ďalšie informácie

Ďalšie o konštrukčných skupinách / moduloch nájdete v príslušnej príručke.

Uporaba sklopov/modulov v eksplozivno ogroženem območju cone 2

Dovoljeni sestavni sklopi / moduli

Sledijo pomembni napotki o inštalaciji sestavnih sklopov/modulov v eksplozivno ogroženem območju.

Seznami z dovoljenimi sestavnimi sklopi / moduli boste našli v medmrežju:

<http://support.automation.siemens.com/WW/view/en/>

Na tej spletni strani vnesite (v iskalnem okencu) pripadajoč ID prispevka, *glejte preglednico*.

Mesto izdelave / Dovoljenje - Atest



II 3 G

EEx nA II T3 .. T6

po EN 60079-15 : 2003

kontrolna številka: *glej tabelo*

Mesto izdelave	Sklopi/moduli	Kontrolna številka	ID prispevka
Siemens AG, Bereich A&D Werner-von-Siemens-Straße 50 92224 Amberg Germany	ET 200S ET 200S Sklopi varovani proti okvari	KEMA 01 ATEX 1238X	24037700
	S7-300 ET 200M vezava vodila DP/PA Diagnostni repeater S7-300 Sklopi varovani proti okvari	KEMA 02 ATEX 1096X	24038475
	VODILO PROFIL Priključni vtič vodila	KEMA 04 ATEX 1151X	24028800
Siemens AG, Bereich A&D Östliche Rheinbrückenstraße 50 76187 Karlsruhe Germany	S7-400	KEMA 03 ATEX 1125X	21479867
	S7-300 CP TS Adapter II TS Adapter IE	KEMA 03 ATEX 1228X	21497622
	SIMATIC NET	KEMA 03 ATEX 1226X	21089482
	ET 200M Marshalled Termination Assemblies	KEMA 05 ATEX 1137X	24193554

Opozorilo

Sestavni sklopi/moduli z dovoljenjem II 3 G EEx nA II T3 .. T6 se lahko uporabijo samo v SIMATIC-Sistemih kategorije naprav 3 .

Vzdrževanje

V primeru popravila pošljete sklope/module na kraj izdelave. Popravila lahko izvajajo samo na tem naslovu!

Posebni pogoji za:

KEMA 01	ATEX 1238X
KEMA 02	ATEX 1096X
KEMA 03	ATEX 1125X, ATEX 1226X, ATEX 1228X

1. Sestavni sklopi/moduli se morajo vgraditi v ustrezno ohišje. To ohišje mora zagotoviti najmanj vrsto zaščite IP 54 (po EN 60529). Pri tem je potrebno upoštevati tudi pogoje okolice, v kateri se naprava nahaja. Ohišje mora imeti izjavo (atest) proizvajalca za uporabo v coni 2 (po EN 60079-15).
2. Če na kablu oz. uvodnici tega ohišja v režimu obratovanja temperatura doseže vrednost $> 70\text{ }^{\circ}\text{C}$ ali če doseže na razcepkih vodnikov v obratovanju temperatura vrednost $> 80\text{ }^{\circ}\text{C}$, se morajo temperaturne lastnosti kablov skladati z dejansko namerjenimi.
3. Uporabljene uvodnice morajo ustrezati predpisani IP zaščiti in poglavju 6.2 (po EN 60079-15).
4. Sprejeti je potrebno ukrepe, da nazivna napetost zaradi tranzientov ne bo prekoračena za več kot 40%.

Posebni pogoji za KEMA 04 ATEX 1151X

1. Priključni vtiči vodila VODILO PROFIL morajo biti nameščeni tako, da so zaščiteni pred mehansko nevarnostjo..
2. Če ni mogoče izključiti vdiranje vlage in prahu, je priključne vtiče vodila VODILO PROFIL serije 6ES7972-... vgraditi v primerno ohišje. To ohišje mora zagotavljati najmanj vrsto zaščite IP 54 (po EN 60529).
3. Priključni vtiči vodila VODILO PROFIL morajo biti pritrjeni s priloženimi vijaki.
4. Priklop oz. ločevanje vodov pod napetostjo ali vklop stikala naprave, npr. zaradi instalacije ali vzdrževanja je dovoljeno, če je zagotovljeno, da območje ni eksplozijsko ogroženo.

Posebni pogoji za KEMA 05 ATEX 1137X

1. Sestavni sklopi/moduli se morajo vgraditi v ustrezno ohišje. To ohišje mora zagotoviti najmanj vrsto zaščite IP 54 (po EN 60529). Pri tem je potrebno upoštevati tudi pogoje okolice, v kateri se naprava nahaja. Ohišje mora imeti izjavo (atest) proizvajalca za uporabo v coni 2 (po EN 60079-15).
2. Če na kablu oz. uvodnici tega ohišja v režimu obratovanja temperatura doseže vrednost $> 70\text{ }^{\circ}\text{C}$ ali če doseže na razcepih vodnikov v obratovanju temperatura vrednost $> 80\text{ }^{\circ}\text{C}$, se morajo temperaturne lastnosti kablov skladati z dejansko namerjenimi.
3. Sprejeti je potrebno ukrepe, da nazivna napetost zaradi tranzientov ne bo prekoračena za več kot 40%.

Ostale informacije

Ostale informacije o sestavnih sklopih / modulih boste našli v ustreznem priročniku.

Patlama tehlikesi olan Alan 2 bölgesinde ünite gruplarının/modüllerin kullanılması

İzin verilen Ünite grupları/Modüller

Aşağıda, ünite gruplarının/modüllerin patlama tehlikesi olan bölgelerde kurulması için önemli bilgiler bulacaksınız.

İzin verilmiş olan ünite gruplarının/modüllerin listesi için internete bakınız:

<http://support.automation.siemens.com/WW/view/en/>

Bu web sitesinde (arama penceresinde) ilgili doküman ID'sini giriniz, *bakınız Tablo*.

İmalat yeri / Lisans



II 3 G

EEx nA II T3 .. T6

EN 60079-15 : 2003 standardına göre

Test numarası: *Bakınız tablo*

İmalat yeri	Ünite grupları/Modüller	Kontrol numarası	Doküman-ID
Siemens AG, Bereich A&D Werner-von-Siemens- Straße 50 92224 Amberg Germany	ET 200S ET 200S Hataya karşı emniyetli ünite grupları	KEMA 01 ATEX 1238X	24037700
	S7-300 ET 200M Bus koplajı DP/PA Diyagnoz repeater ünitesi S7-300 Hataya karşı emniyetli ünite grupları	KEMA 02 ATEX 1096X	24038475
	PROFIBUS-Bus bağlantı fişi	KEMA 04 ATEX 1151X	24028800
Siemens AG, Bereich A&D Östliche Rheinbrücken- straße 50 76187 Karlsruhe Germany	S7-400	KEMA 03 ATEX 1125X	21479867
	S7-300 CP TS Adaptör II TS Adaptör IE	KEMA 03 ATEX 1228X	21497622
	SIMATIC NET	KEMA 03 ATEX 1226X	21089482
	ET 200M Marshallled Termination Assemblies	KEMA 05 ATEX 1137X	24193554

Bilgi

II 3 G EEx nA II T3 .. T6 lisanslı ünite grupları/modüller sadece 3 numaralı cihaz kategorisine ait SIMATIC sistemlerinde kullanılabilir.

Bakım

Bir onarım gerekli olması halinde, ilgili ünite grupları/modüller imalat yerine gönderilmelidir. Onarım sadece orada yapılabilir ve yapılmalıdır.

Özel koşullar:

KEMA 01 ATEX 1238X

KEMA 02 ATEX 1096X

KEMA 03 ATEX 1125X, ATEX 1226X, ATEX 1228X

1. Ünite grupları/modüller uygun bir kasa içine monte edilmelidir. Bu kasa, en az IP 54 (EN 60529 standardına göre) koruma türüne sahip olmalıdır. Burada, cihazın kurulduğu çevre koşulları dikkate alınmalıdır. Kullanılacak kasa için, alan 2 için geçerli bir üretici beyanı mevcut olmalıdır (EN 60079-15 standardına göre).
2. Kabloda ya da bu kasanın kablo girişindeki işletme koşullarında sıcaklık > 70 °C oluyorsa veya işletme koşullarında kablo telleri (damarları) ayrılma noktasında sıcaklık > 80 °C olma ihtimali varsa, kablonun sıcaklık ile ilgili özellikleri, gerçekten ölçülmüş sıcaklıklara uygun olmalıdır.
3. Kullanılmış olan kablo girişleri, talep edilen IP koruma türüne ve bölüm 6.2 (EN 60079-15 standardına göre) dahilindeki taleplere uygun olmalıdır.
4. Nominal gerilimin transiyentlerden (hatlardaki dalgalanmalardan dolayı ani gerilim ve akım değişiklikleri) dolayı azami %40 aşılması için gerekli önlemler alınmalıdır.

KEMA 04 ATEX 1151X için özel koşullar:

1. PROFIBUS Bus bağlantı fişleri, mekanik tehlikeye karşı korunaklı olacak şekilde monte edilmelidir.
2. İçine toz ve nemin girmesi önlenemediğinde, 6ES7972-... serisi PROFIBUS Bus bağlantı fişleri uygun bir kasa içine monte edilmelidir. Bu kasa, en az IP 54 (EN 60529 standardına göre) koruma türüne sahip olmalıdır.
3. PROFIBUS Bus bağlantı fişleri birlikte verilen civatalarla talimatlara uygun olarak sabitlenmelidir.
4. Montaj veya bakım çalışmaları için elektrik ileten kabloların bağlanması veya sökülmesi ya da cihaz şalterine basılması işlemlerine, yalnızca ilgili sahada patlama tehlikesi bulunmadığı tespit edildiğinde izin verilir.

KEMA 05 ATEX 1137X için özel koşullar:

1. Ünite grupları/modüller uygun bir kasa içine monte edilmelidir. Bu kasa, en az IP 54 (EN 60529 standardına göre) koruma türüne sahip olmalıdır. Burada, cihazın kurulduğu çevre koşulları dikkate alınmalıdır. Kullanılacak kasa için, alan 2 için geçerli bir üretici beyanı mevcut olmalıdır (EN 60079-15 standardına göre).
2. Kabloda ya da bu kasanın kablo girişindeki işletme koşullarında sıcaklık $> 70\text{ }^{\circ}\text{C}$ oluyorsa veya işletme koşullarında kablo telleri (damarları) ayrılma noktasında sıcaklık $> 80\text{ }^{\circ}\text{C}$ olma ihtimali varsa, kablonun sıcaklık ile ilgili özellikleri, gerçekten ölçülmüş sıcaklıklara uygun olmalıdır.
3. Nominal gerilimin transiyentlerden (hatlardaki dalgalanmalardan dolayı ani gerilim ve akım değişiklikleri) dolayı azami %40 aşılması için gerekli önlemler alınmalıdır.

Daha başka bilgiler

Ünite grupları/modüller hakkında daha fazla bilgi için ilgili kılavuza bakınız.

Използване на електронни блокове/модули във взривоопасната област Зона 2

Допуснати до експлоатация електронни блокове/модули

По-нататък ще намерите важни указания за инсталирането на електронни блокове/модули във взривоопасната област.

Списъкът на допуснатите до експлоатация електронни блокове/модули ще намерите в интернет:

<http://support.automation.siemens.com/WW/view/en/>

В този уеб сайт въведете (в прозореца за търсене) съответния идентификационен номер, *вижте таблицата*.

Място на производство / Удостоверение за допускане в експлоатация



II 3 G

EEx nA II T3 .. T6

съгласно EN 60079-15 : 2003

Номер на изпитване: *вижте таблицата*

Място на производство	Електронни блокове/модули	Номер на изпитване	Идентификационен номер
Siemens AG, Bereich A&D Werner-von-Siemens- Straße 50 92224 Amberg Germany	ET 200S ET 200S модули, защитени по отношение на възникване на грешки	KEMA 01 ATEX 1238 X	24037700
	S7-300 ET 200M шинна връзка DP/PA повторител на диагнозата S7-300 електронни блокове, защитени по отношение на възникване на грешки	KEMA 02 ATEX 1096 X	24038475
	PROFIBUS- съединителен шинен щекер	KEMA 04 ATEX 1151 X	24028800
Siemens AG, Bereich A&D Östliche Rheinbrücken- straße 50 76187 Karlsruhe Germany	S7-400	KEMA 03 ATEX 1125X	21479867
	S7-300 CP TS адаптер II TS адаптер IE	KEMA 03 ATEX 1228X	21497622
	SIMATIC NET	KEMA 03 ATEX 1226X	21089482
	ET 200M Модулно разпределени входно- изходни системи	KEMA 05 ATEX 1137 X	24193554

Указание

Електронни блокове/модули с разрешение за допускане в експлоатация  II 3 G EEx nA II T3 .. T6 могат да се използват само в системи SIMATIC с категория на уреда 3.

Поддържане в изправност

За ремонт съответните електронни блокове/модули трябва да се изпратят до мястото на производство. Ремонтът може да се извърши само там.

Особени условия за:

КЕМА 01 АТЕХ 1238Х

КЕМА 02 АТЕХ 1096Х

КЕМА 03 АТЕХ 1125Х, АТЕХ 1226Х, АТЕХ 1228Х

1. Електронните блокове/модулите трябва да се монтират в подходящ корпус. Този корпус трябва да осигурява степен на защита най-малко IP 54 (съгласно EN 60529). При това трябва да се имат предвид условията на околната среда, в които се инсталира устройството. За корпуса трябва да има разяснение на производителя за зона 2 (съгласно EN 60079-15).
2. Когато на кабела или на кабелния вход на този корпус при работни условия се достигне температура > 70 °С, или когато при работни условия температурата на разклонението на жилата може да е > 80 °С, температурните свойства на кабелите трябва да се съгласуват с действително измерените температури.
3. Използваните кабелни входове трябва да съответстват на исканата степен на защита IP и на раздел 6.2 (съгласно EN 60079-15).
4. Трябва да се предприемат мерки номиналното напрежение да не се надхвърля с повече от 40 % чрез преходни процеси.

Особени условия за КЕМА 04 АТЕХ 1151Х

1. Съединителните шинни щекери PROFIBUS трябва да се инсталират така, че да са защитени от опасност за механични повреди.
2. Когато не може да се изключи проникването на влага и прах, съединителните шинни щекери PROFIBUS от серия 6ES7972 трябва да се монтират в подходящ корпус. Този корпус трябва да осигурява степен на защита най-малко IP 54 (съгласно EN 60529).
3. Съединителните шинни щекери PROFIBUS трябва да се закрепват с доставените винтове съгласно инструкцията.
4. Свързването или разделянето на токопроводящи жила, или на задействането на превключватели на устройствата, например за инсталационни цели или заради поддръжката, е разрешено, само ако е гарантирано, че областта не е взривоопасна.

Особени условия за КЕМА 05 АТЕХ 1137Х

1. Електронните блокове/модулите трябва да се монтират в подходящ корпус. Този корпус трябва да осигурява степен на защита най-малко IP 54 (съгласно EN 60529). При това трябва да се имат предвид условията на околната среда, в които се инсталира устройството. За корпуса трябва да има разяснение на производителя за зона 2 (съгласно EN 60079-15).
2. Когато на кабела или на кабелния вход на този корпус при работни условия се достигне температура $> 70\text{ }^{\circ}\text{C}$, или когато при работни условия температурата на разклонението на жилата може да е $> 80\text{ }^{\circ}\text{C}$, температурните свойства на кабелите трябва да се съгласуват с действително измерените температури.
3. Трябва да се предприемат мерки номиналното напрежение да не се надхвърля с повече от 40 % чрез преходни процеси.

Подробна информация

Подробна информация за електронните блокове/модулите ще намерите в съответния справочник.

Utilizarea unităților constructive/modulelor în domeniul cu potențial exploziv din zona 2

Unități constructive/module aprobate

În continuare veți găsi indicații importante pentru instalarea grupelor constructive/modulelor în domeniul cu potențial exploziv.

Lista cu unitățile constructive/modulele se află pe internet:

<http://support.automation.siemens.com/WW/view/en/>

Pe această pagină web (în fereastra de căutare) introduceți ID-ul articolului, vezi tabelul.

Locul de fabricație / aprobarea



II 3 G

EEx nA II T3 .. T6

conform EN 60079-15 : 2003

Număr verificare: vezi tabelul

Locul de fabricație	Unități constructive/module	Număr verificare	ID articol
Siemens AG, Bereich A&D Werner-von-Siemens- Straße 50 92224 Amberg Germany	ET 200S ET 200S Module de siguranță	KEMA 01 ATEX 1238 X	24037700
	S7-300 ET 200M Cuplaj magistrală DP/PA Repetor diagnoză S7-300 unități constructive de siguranță	KEMA 02 ATEX 1096 X	24038475
	Ștecher racord magistrală PROFIBUSr	KEMA 04 ATEX 1151 X	24028800
Siemens AG, Bereich A&D Östliche Rheinbrücken- straße 50 76187 Karlsruhe Germany	S7-400	KEMA 03 ATEX 1125X	21479867
	S7-300 CP TS adaptor II TS adaptor IE	KEMA 03 ATEX 1228X	21497622
	SIMATIC NET	KEMA 03 ATEX 1226X	21089482
	ET 200M Marshallled Termination Assemblies	KEMA 05 ATEX 1137 X	24193554

Indicație

Unitățile constructive/modulele cu aprobarea II 3 G EEx nA II T3 .. T6 se pot utiliza numai în sisteme SIMATIC din categoria de aparate 3.

Mentenanță

Pentru reparație, unitățile constructive/modulele respective se vor trimite la locul de fabricație. Reparația se poate efectua numai acolo.

Condiții speciale pentru:

KEMA 01 ATEX 1238X

KEMA 02 ATEX 1096X

KEMA 03 ATEX 1125X, ATEX 1226X, ATEX 1228X

1. Unitățile constructive/modulele se vor monta într-o carcasă adecvată. Această carcasă va garanta cel puțin tipul de protecție IP 54 (conform EN 60529). La aceasta se vor respecta condițiile de mediu în care se instalează dispozitivul. Pentru carcasă va fi disponibilă declarația producătorului pentru zona 2 (conform EN 60079-15).
2. Dacă la cablu, respectiv la intrarea cablului acestei carcase, în condiții de funcționare, este atinsă o temperatură $> 70\text{ }^{\circ}\text{C}$ sau dacă în condiții de funcționare, la derivația conductorilor poate fi o temperatură $> 80\text{ }^{\circ}\text{C}$, caracteristicile de temperatură ale cablurilor trebuie să corespundă temperaturilor reale măsurate.
3. Intrările de cablu utilizate vor corespunde tipului de protecție IP și secțiunii 6.2 (conform EN 60079-15).
4. Se vor lua măsuri pentru ca tensiunea nominală prin fenomene tranzitorii să nu depășească mai mult cu 40 %.

Condiții speciale pentru KEMA 04 ATEX 1151X

1. Ștecherele de conectare pentru magistrală PROFIBUS se vor instala astfel încât să fie protejate contra pericolelor mecanice.
2. Dacă nu se poate evita pătrunderea umezelii și a prafului, ștecherele de conectare pentru magistrală PROFIBUS, seria 6ES7972-... se vor monta într-o carcasă adecvată. Această carcasă va garanta cel puțin tipul de protecție IP 54 (conform EN 60529).
3. Ștecherele de conectare pentru magistrală PROFIBUS se vor fixa corespunzător cu șuruburile livrate.
4. Conectarea, resp. separarea firelor conducătoare de tensiune sau la acționarea comutatorului aparatului, de exemplu în scopuri de instalare sau întreținere, este permisă numai dacă se garantează că zona nu prezintă potențial exploziv.

Condiții speciale pentru KEMA 05 ATEX 1137X

1. Unitățile constructive/modulele se vor monta într-o carcasă adecvată. Această carcasă va garanta cel puțin tipul de protecție IP 54 (conform EN 60529). La aceasta se vor respecta condițiile de mediu în care se instalează dispozitivul. Pentru carcasă va fi disponibilă declarația producătorului pentru zona 2 (conform EN 60079-15).
2. Dacă la cablu, respectiv la intrarea cablului acestei carcase, în condiții de funcționare, este atinsă o temperatură $> 70\text{ }^{\circ}\text{C}$ sau dacă în condiții de funcționare, la derivația conductorilor poate fi o temperatură $> 80\text{ }^{\circ}\text{C}$, caracteristicile de temperatură ale cablurilor trebuie să corespundă temperaturilor reale măsurate.
3. Se vor lua măsuri pentru ca tensiunea nominală prin fenomene tranzitorii să nu depășească mai mult cu 40 %.

Informații suplimentare

Informații suplimentare cu privire la grupele constructive/module se află în manualul aferent.

SIMATIC

Product information

07/2006

for the *Diagnostic repeater for PROFIBUS-DP* manual

This production information contains **important information regarding the firmware version 2.0.0 of the diagnostic repeater, order number 6ES7972-0AB01-0XA0**. The product information is a constituent part of the supplied product and, in the case of doubt; , the statements made in it have priority over any other statements.

Contents

1	Introduction	2
2	DP cycle time measurement	3
3	Time synchronization by means of S7 system mechanisms	6
4	Support of the I&M function	7
5	Firmware update	10
6	Supplement to the manual	11

1 Introduction

In addition to the scope of performance given up until now, the diagnostic repeater, firmware version 2.0.0, modulehardware version 03, also offers the following additional function enhancements:

- DP cycle time measurement,
- Time synchronization by means of S7 system mechanisms and
- Support of the I&M function.

2 DP cycle time measurement

DP cycle time measurement

As an alternative to the existing clocked monitoring function (T_{DX} / T_{DP} monitoring, refer to chapter “Monitoring functions for the clocked PROFIBUS bus system“ in the *Diagnostic Repeater for PROFIBUS-DP* manual), as of firmware version 2.0.0 the diagnostic repeater offers the DP cycle time measurement of the DP system to which the diagnostic repeater is connected.

Note

The functions can only be used alternately. This means that you can use either

- the DP cycle time measurement
- or
- the equidistant error function is active.

You cannot operate both functions at the same time.

The following measured values are recorded by the DP cycle time measurement and are made available by the record “DP cycle time”.

- Minimum DP cycle time with time stamp (precision $\pm 0.5\%$, resolution $1\ \mu\text{s}$)
- Maximum DP cycle time with time stamp (precision $\pm 0.5\%$, resolution $1\ \mu\text{s}$)
- Average of the DP cycle time through the entire duration of the measurement (precision $\pm 0.5\%$, resolution $50\ \mu\text{s}$)
- Counter, how many measurements have been carried out

Requirements

- Integration of the diagnostic repeater via the GSD file revision 5, software release 2.0 with the file names si0380a7.gs?. For the GSD file, go to:
<http://www.ad.siemens.de/csi/gsd>
Entry ID: 113682
- The DP cycle time measurement is only possible in DP-V1 mode.
- The DP cycle time measurement is supported as of modulehardware version 2 of the diagnostic repeater with **MLFB 6ES7972-0AB01-0XA0**.
In modulehardware version 1, a read / write access via SFC 58 / SFC 59 or SFB 52 / SFB 53 to the record 70 will be acknowledged with a negative return value “0x80A9”.

Marginal conditions for the DP cycle time measurement

For the DP cycle time measurement, the diagnostic repeater must be configured as a DP slave.

For the DP cycle time measurement function you do not have to enter any parameters in the configuration.

The DP cycle time measurement can only be operatedis carried out only if the DP bus is working **non**-clocked.

Additional record in the diagnostic repeater

The table includes the records of the diagnostic repeater with order number 6ES7972-0AB01-0XA0, which can be used by *STEP 7* or in the application program. The record 70 (dec) has been added on account of the DP cycle time measurement. Use only those record numbers listed in the table.

R Record number (hex)	R Record number (dec)	Writable/readable Can be written to/read W / R	Function
1EH	30	R	Diagnostic buffer DP1
1FH	31	R	Diagnostic buffer DP2
20H	32	R	Diagnostic buffer DP3
21H	33	R	Diagnostic buffer PG (programming device) PD
28H	40	R	Reflection error rate DP2
29H	41	R	Message frame error rate DP2
2AH	42	R	Reflection error rate DP3
2BH	43	R	Message frame error rate DP3
32H	50	R	1st part 1. Part of the topology table: Nodes 0 to 31
33H	51	R	2nd part 2. Part of the topology table: Nodes 32 to 63
34H	52	R	3rd part 3. Part of the topology table: Nodes 64 to 95
35H	53	R	4th part 4. Part of the topology table: Nodes 96 to 126
3CH	60	W / R	Time
46H	70	R	DP cycle time

The records can be accessed both via the C1 as well as the C2 channel on slot 0 or via the corresponding logical address (corresponds to the diagnostic address in *STEP 7*).

DP cycle time record format

Record 70 comprises version number, status byte and the entries for the cycle time measurement; it is made up of a total of 44 bytes.

Byte	“DP cycle time” record	Format
0	Version (= 01)	BYTE
1	DP cycle time measurement status	BYTE
2	reserved	BYTE
3	reserved	BYTE
4...7	Baud rate in kBaud	REAL
8...11	Min. DP cycle (in ms) *	REAL
12...19	Time stamp	BCD
20...23	Max. DP cycle (in ms) *	REAL
24...31	Time stamp	BCD
32...35	Average DP cycle (in ms) *	REAL
36...39	Basic number of measurements +	UINT
40...43	Number of measurements carried forward +	UINT

* If the clocked monitoring function is active, the configured values will be displayed.

+ If the clocked monitoring function is active, these values will be set to “0”.

In the case of write access to the record 70, the values will be reset and the measurement restarted.

DP cycle time measurement status byte

The entry “DP cycle time measurement status byte” is structured as follows:

Byte	MSB							LSB
	7	6	5	4	3	2	1	0
5	Status_DPCycleTimeMeasurement							

The Status_DPCycleTimeMeasurement is structured as follows:

Bit		Meaning
Bit 0	1	The values are valid
	0	The values are invalid or frozen
Bit 1	1	Diagnostic repeater is in “Clocked monitoring function” mode
	0	Diagnostic repeater is in “DP cycle time measurement” mode
Bit 2	1	Clear function inactive (CPU in RUN)
	0	Clear function active (CPU in STOP)
Bits 3..0. 7	0	reserved

The DP cycle time measurement is carried out only in the CPU RUN mode.

3 Time synchronization by means of S7 system mechanisms

In addition to setting the time using the time reference form from the CPU with record 60, the diagnostic repeater as of firmware version 2.0.0 offers time synchronization by means of S7 system mechanisms.

Requirements

- You require a CPU or a CP that supports time synchronization (e.g. all the S7-400 CPUs do this). Please consult the specifications given in the manual for the module in question.
- Integration of Integrating the diagnostic repeater via the GSD file revision 5 (see above). Time synchronization is only possible in DP-V1 mode.

Marginal conditions for time synchronization by means of S7 system mechanisms

Depending on the scenario, you can synchronize the clock in the diagnostic repeater either via the “Time reference (DS 60)” or by means of time synchronization.

Both processes are “opened” parallel during the start-up of the diagnostic repeater. However, it isn’t practical to run both mechanisms at the same time, and this is acknowledged by a negative message. In such a case, the record 60 is rejected and the time synchronization is carried out via the S7 system mechanisms.

Parameter configuration / activating the time synchronization

When configuring parameters for the system in *STEP 7* you must enable / activate the time synchronization via the SIMATIC standard mechanism.

Reference

You will find more information on time synchronization in general in the Online help for *STEP 7*.

4 Support of the I&M function

In addition to the I&A data (refer to chapter "Identification data" in the *Diagnostic Repeater for PROFIBUS-DP* manual), as of firmware version 2.0.0 the diagnostic repeater offers support of the I&M function.

The access mechanism to the I&M data has been replaced supplemented in accordance with the PROFIBUS Guideline – order no. 3502, version 1.1 of May 2003.

Definition and features

Identification and maintenance data (I&M) is information stored in a module to support you in

- Checking the plant configuration
- Locating hardware modifications in a plant
- Correcting errors in a plant

Identification data (I data) is information regarding the module, like for example, order number and serial number, which are partly also printed on the housing of the module. I data is manufacturer's information on the module and can only be read.

Maintenance data (M data) is system-dependent information, like for example, installation location and date of location. M data is created during the configuration and written to the module.

I&M data enable modules to be uniquely identified online.

This data is available on the diagnostic repeater as of firmware version 2.0.0.

Note

Only one DP master can access the I&M data of a diagnostic repeater at any one pointtime.

Reading and writing the I&M data with *STEP 7*

STEP 7 outputs the I&M data to the "Module status – diagnostic repeater" and "Properties - DP Slave" tabs (see the *STEP 7* Online Help).

In the HW Config you can enter the modules' M data (e.g. in a dialog box during the configuration).

The access to the I&M data takes place in accordance with the IEC 61158 -6 standard.

Reading and writing the I&M data without *STEP 7*

If you wish to use the I&M data without using *STEP 7*, you must carry out the data access in accordance with the specifications of the PROFIBUS Guideline, Version version 1.1 of May 2003.

In the H system the diagnostic repeater from which the I&M data is to be read must be addressed.

Structure of the identification data

The following table explains the specific identification data of the diagnostic repeater.

Table: Identification data of the diagnostic diagnosis repeater			
I&M data	Access	Default	Explanation
Identification data: I&M0			
MANUFACTURER_ID	read (2 bytes)	2A hex (= 42 dec)	The name of the manufacturer is stored here (42 dec = Siemens AG).
ORDER_ID	read (20 bytes)	6ES7972-0AB01-0XA0	The order number of the module is stored saved here (= diagnostic repeater).
SERIAL_NUMBER	read (16 bytes)	The serial number of the module is stored saved here. This facilitates unique identification of the module.	
HARDWARE_REVISION	read (2 bytes)	The order hardware version of the module is stored here. Is increased when the hardware version product release or the firmware of the module changes.	
SOFTWARE_REVISION	read (4 bytes)	Gives information on the firmware version of the module. If the firmware version number is increased, then the hardware version product release of the module (HARDWARE_REVISION) is also increased.	
REVISION_COUNTER	read (2 bytes)	0000 hex	reserved
PROFILE_ID	read (2 bytes)	F600 hex	Generic Device
PROFILE_SPECIFIC_TYPE	read (2 bytes)	0006 hex (= 6 dec)	Internal parameters (in accordance with PROFIBUS DP)
IM_VERSION	read (2 bytes)	0101 hex	Provides information on the I&M data version (0101 hex = version 1.1).
IM_SUPPORTED	read (2 bytes)	000E hex	Provides information on available I&M data (I&M1 to I&M3).
Maintenance data 1: I&M1			
TAG_FUNCTION	read / write (32 bytes)	-	Enter a system-wide unique identification for the module here.
TAG_LOCATION	read / write (22 bytes)	-	Enter the installation location of the module here.
Maintenance data 2: I&M2			
INSTALLATION_DATE	read / write (16 bytes)	-	Enter the installation date for the module and, if necessary, the relevant time.
RESERVED	read / write (38 bytes)	-	reserved
Maintenance data 3: I&M3			
DESCRIPTOR	read / write (54 bytes)	-	Enter a comment on the module here.

5 Firmware update

Diagnostic repeater firmware update

You can download the function enhancements described - DP cycle time measurement, time synchronization by means of the S7 system mechanisms and support of the I&M function - to diagnostic repeaters as of order number 6ES7972-0AB01-0XA0 via the firmware update via *STEP 7* as of V5.2.

To update the firmware, you receive the *.UPD files containing the current firmware.

Requirements

- The diagnostic repeater, the firmware of which must be updated, must be accessible online.
- The files with the current firmware version must be available in the file system of your programming device or PC.

Procedure

For information on procedures, refer to the *STEP 7* Online Help.

Note

When the firmware is activated the topology table in the diagnostic repeater is deleted (automatically or after you switch the power off / on). After the activation, determine the topology.

Note

If the firmware is automatically activated after downloading, then the diagnostic repeater restarts, the repeater functions are not available during this time. This means the diagnostic repeater and parts of the network are temporarily unavailable.

To obtain the current firmware version go to:

<http://www.ad.siemens.de/csi/download>

Entry ID: 21186838

6 Supplement to the Manual

Chapter 7.4.3, Statistics buffer

Procedure

1. In the topology display, mark the diagnostic repeater, the data for which you want to read.
2. Start the function using the menu item **PLC > Statistics**.

