

SIEMENS

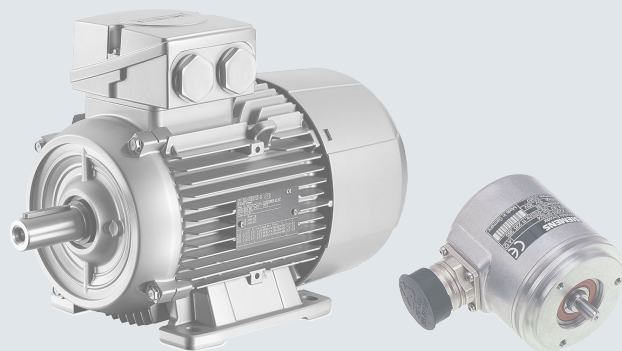
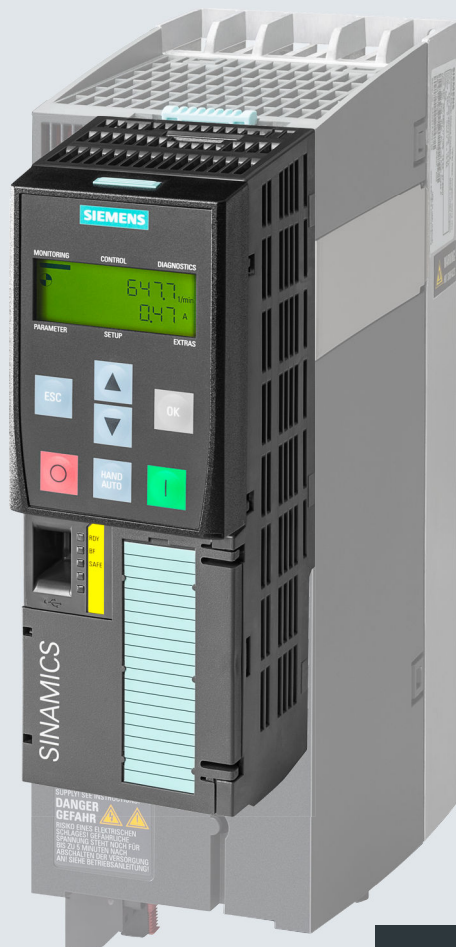

Operating instructions

SINAMICS

SINAMICS G120

Low voltage inverters
Built-in units with CU250S-2 Control Units and
encoder evaluation

Edition

04/2018

www.siemens.com/drives

SIEMENS

SINAMICS

SINAMICS G120 Converter with the CU250S-2 Control Units

Operating Instructions

Changes in the current edition

Fundamental safety instructions	1
Introduction	2
Description	3
Installing	4
Commissioning	5
Advanced commissioning	6
Saving the settings and series commissioning	7
Alarms, faults and system messages	8
Corrective maintenance	9
Technical data	10
Appendix	A

Edition 04/2018, Firmware V4.7 SP10

Legal information

Warning notice system

This manual contains notices you have to observe in order to ensure your personal safety, as well as to prevent damage to property. The notices referring to your personal safety are highlighted in the manual by a safety alert symbol, notices referring only to property damage have no safety alert symbol. These notices shown below are graded according to the degree of danger.

⚠ DANGER
indicates that death or severe personal injury will result if proper precautions are not taken.

⚠ WARNING
indicates that death or severe personal injury may result if proper precautions are not taken.

⚠ CAUTION
indicates that minor personal injury can result if proper precautions are not taken.

NOTICE
indicates that property damage can result if proper precautions are not taken.

If more than one degree of danger is present, the warning notice representing the highest degree of danger will be used. A notice warning of injury to persons with a safety alert symbol may also include a warning relating to property damage.

Qualified Personnel

The product/system described in this documentation may be operated only by **personnel qualified** for the specific task in accordance with the relevant documentation, in particular its warning notices and safety instructions. Qualified personnel are those who, based on their training and experience, are capable of identifying risks and avoiding potential hazards when working with these products/systems.

Proper use of Siemens products

Note the following:

⚠ WARNING
Siemens products may only be used for the applications described in the catalog and in the relevant technical documentation. If products and components from other manufacturers are used, these must be recommended or approved by Siemens. Proper transport, storage, installation, assembly, commissioning, operation and maintenance are required to ensure that the products operate safely and without any problems. The permissible ambient conditions must be complied with. The information in the relevant documentation must be observed.

Trademarks

All names identified by ® are registered trademarks of Siemens AG. The remaining trademarks in this publication may be trademarks whose use by third parties for their own purposes could violate the rights of the owner.





Disclaimer of Liability

We have reviewed the contents of this publication to ensure consistency with the hardware and software described. Since variance cannot be precluded entirely, we cannot guarantee full consistency. However, the information in this publication is reviewed regularly and any necessary corrections are included in subsequent editions.

Changes in the current edition

Essential changes with respect to Edition 09/2017





New hardware

- PM240-2 Power Module, FSG
 -  Power Module with IP20 degree of protection (Page 35)
 -  Dimensioned drawings, drilling dimensions for the PM240-2 Power Module, IP20 (Page 62)
 -  Specific technical data, 400 V inverters (Page 457)
 -  Specific technical data, 690 V inverters (Page 467)

New functions

-  Firmware version 4.7 SP10 (Page 481)

Corrections

- Article number of the PM240-2 PT Power Module, 132 kW, corrected.
 -  Technical data, PM240-2 Power Modules (Page 445)
- Dimensions of the PM240-2 Power Module corrected.
 -  Dimensioned drawings, drilling dimensions for the PM240-2 Power Module, IP20 (Page 62)
- Setting the feedback signal for the line contactor control corrected.
 -  Line contactor control (Page 355)
- SSI encoder and Endat 2.1 encoder are permissible for speed control.
 -  Installing encoders (Page 121)
- PROFIdrive control word 2, bit 8 corrected
PROFIdrive status word 2, bit 7 corrected
 -  Telegrams (Page 184)

Revised descriptions

- Only commissioning using the Startdrive PC-based tool is described. Commissioning with STARTER has been removed.
Exceptions: Write and know-how protection.
You can find information on commissioning with STARTER on the Internet:
 Operating Instructions, 09/2017 Edition (<https://support.industry.siemens.com/cs/ww/en/view/109751322>)

Table of contents

	Changes in the current edition.....	3
1	Fundamental safety instructions.....	13
1.1	General safety instructions.....	13
1.2	Equipment damage due to electric fields or electrostatic discharge.....	19
1.3	Warranty and liability for application examples.....	20
1.4	Industrial security.....	21
1.5	Residual risks of power drive systems.....	23
2	Introduction.....	25
2.1	About the Manual.....	25
2.2	Guide through the manual.....	26
3	Description.....	29
3.1	Identifying the converter.....	30
3.2	Directives and standards.....	31
3.3	Overview of Control Units.....	33
3.4	Power Modules.....	34
3.4.1	Power Module with IP20 degree of protection.....	35
3.4.2	Power Module with Push-Through technology.....	37
3.5	Components for the Power Modules.....	38
3.5.1	Accessories for shielding.....	38
3.5.2	Line filter.....	39
3.5.3	Line reactor.....	40
3.5.4	Output reactor.....	42
3.5.5	du/dt filter plus VPL.....	45
3.5.6	Sine-wave filter.....	47
3.5.7	Braking resistor.....	48
3.5.8	Brake Relay.....	50
3.5.9	Safe Brake Relay.....	50
3.6	Motors and multi-motor drives that can be operated.....	51
3.7	Encoder and Sensor Module.....	52
4	Installing.....	53
4.1	EMC-compliant installation of a machine or system.....	53
4.1.1	Control cabinet.....	54
4.1.2	Cables.....	55
4.1.3	Electromechanical components.....	58
4.2	Installing reactors, filters and braking resistors.....	59
4.3	Installing Power Modules.....	60

4.3.1	Basic installation rules for built-in units.....	60
4.3.2	Dimensioned drawings, drilling dimensions for the PM240-2 Power Module, IP20.....	62
4.3.3	Dimension drawings, drilling dimensions for PM240-2 Power Modules in push-through technology.....	65
4.3.4	Dimensioned drawings, drilling dimensions for the PM250 Power Module.....	69
4.4	Connecting the line supply and motor.....	72
4.4.1	Permissible line supplies.....	72
4.4.1.1	TN line system.....	73
4.4.1.2	TT line system.....	75
4.4.1.3	IT system.....	76
4.4.2	Protective conductor.....	77
4.4.3	Connecting an inverter with the PM240-2 Power Module.....	79
4.4.4	Connecting the inverter with the PM250 Power Module.....	84
4.4.5	Connecting the motor to the inverter in a star or delta connection.....	86
4.4.6	Connecting a motor holding brake.....	87
4.4.6.1	Installing a Brake Relay - PM250 Power Module.....	89
4.4.6.2	Installing a Brake Relay - PM240-2 Power Module.....	90
4.5	Connecting the interfaces for the inverter control.....	91
4.5.1	Overview of the interfaces on the front and upper side.....	92
4.5.2	Terminal strips behind the upper front door.....	93
4.5.3	Terminal strips behind the lower front door.....	94
4.5.4	Fieldbus and encoder interfaces on the lower side.....	95
4.5.5	Factory interface settings.....	96
4.5.6	Default setting of the interfaces.....	98
4.5.7	Fail-safe digital input.....	109
4.5.8	Wire up the terminal strip and connect the shield.....	110
4.5.9	Connecting the temperature contact of the braking resistor.....	113
4.5.10	Fieldbus interfaces.....	113
4.5.11	Connecting the inverter to PROFINET.....	114
4.5.11.1	Communication via PROFINET IO and Ethernet.....	114
4.5.11.2	Connecting the PROFINET cable to the inverter.....	115
4.5.11.3	What do you have to set for communication via PROFINET?.....	116
4.5.11.4	Installing GSDML.....	117
4.5.12	Connecting the inverter to PROFIBUS.....	117
4.5.12.1	Connecting the PROFIBUS cable to the inverter.....	118
4.5.12.2	What do you have to set for communication via PROFIBUS?.....	118
4.5.12.3	Installing the GSD.....	119
4.5.12.4	Setting the address.....	119
4.6	Installing encoders.....	121
5	Commissioning.....	125
5.1	Commissioning guidelines.....	125
5.2	Tools to commission the inverter.....	126
5.3	Preparing for commissioning.....	127
5.3.1	Collecting motor data.....	127
5.3.2	Forming DC link capacitors.....	128
5.3.3	Inverter factory setting.....	130
5.3.4	Inverter function modules.....	132
5.4	Quick commissioning with a PC.....	134

5.4.1	Creating a project.....	134
5.4.2	Transfer inverters connected via USB into the project.....	135
5.4.3	Starting wizards for the quick commissioning.....	136
5.4.4	Standard Drive Control.....	139
5.4.5	Dynamic Drive Control.....	141
5.4.6	Expert.....	143
5.4.7	Configuring encoders.....	147
5.4.8	Adapting the encoder data.....	148
5.4.9	Loading the settings into the inverter.....	149
5.4.10	Identify motor data.....	150
5.5	Restoring the factory setting.....	152
5.5.1	Resetting the safety functions to the factory setting.....	153
5.5.2	Restore the factory settings (without safety functions).....	155
6	Advanced commissioning.....	157
6.1	Overview of the converter functions.....	157
6.2	Sequence control when switching the motor on and off.....	161
6.3	Adapt the default setting of the terminal strip.....	164
6.3.1	Digital inputs.....	165
6.3.2	Digital outputs.....	168
6.3.3	Analog inputs.....	170
6.3.4	Analog outputs.....	174
6.4	Controlling clockwise and counter-clockwise rotation via digital inputs.....	177
6.4.1	Two-wire control, method 1.....	178
6.4.2	Two-wire control, method 2.....	179
6.4.3	Two-wire control, method 3.....	180
6.4.4	Three-wire control, method 1.....	181
6.4.5	Three-wire control, method 2.....	182
6.5	Drive control via PROFIBUS or PROFINET.....	183
6.5.1	Receive data and send data.....	183
6.5.2	Telegrams.....	184
6.5.3	Control and status word 1.....	187
6.5.4	Control and status word 2.....	190
6.5.5	Control and status word 3.....	191
6.5.6	NAMUR message word.....	193
6.5.7	Control and status word, encoder.....	194
6.5.8	Position actual value of the encoder.....	196
6.5.9	Parameter channel.....	198
6.5.10	Examples for using the parameter channel.....	201
6.5.11	Extending the telegram.....	203
6.5.12	Slave-to-slave communication.....	205
6.5.13	Acyclically reading and writing inverter parameters.....	205
6.6	Drive control via Modbus RTU.....	206
6.7	Drive control via USS.....	209
6.8	Drive control via Ethernet/IP.....	212
6.9	Drive control via CANopen.....	213
6.10	Jogging.....	214

6.11	Limit position control.....	216
6.12	Switching over the drive control (command data set).....	218
6.13	Motor holding brake.....	220
6.14	Free function blocks.....	224
6.14.1	Overview.....	224
6.14.2	Runtime groups and run sequence.....	224
6.14.3	List of the free function blocks.....	225
6.14.4	Scaling.....	236
6.14.5	Activating free function block.....	237
6.14.6	Further information.....	237
6.15	Selecting physical units.....	238
6.15.1	Motor standard.....	238
6.15.2	System of units.....	238
6.15.3	Technological unit of the technology controller.....	240
6.15.4	Setting the system of units and technology unit.....	240
6.16	Extended messages.....	242
6.17	Safe Torque Off (STO) safety function.....	244
6.17.1	Function description.....	244
6.17.2	Commissioning STO.....	246
6.17.2.1	Safety functions password.....	246
6.17.2.2	Configuring a safety function.....	248
6.17.2.3	Interconnecting the "STO active" signal.....	249
6.17.2.4	Setting the filter for fail-safe digital inputs.....	250
6.17.2.5	Setting the forced checking procedure (test stop).....	252
6.17.2.6	Finalizing online commissioning.....	254
6.17.2.7	Checking the assignment of the digital inputs.....	255
6.17.2.8	Acceptance - completion of commissioning.....	256
6.18	Setpoints.....	258
6.18.1	Overview.....	258
6.18.2	Analog input as setpoint source.....	260
6.18.3	Specifying the setpoint via the fieldbus.....	262
6.18.4	Motorized potentiometer as setpoint source.....	264
6.18.5	Fixed speed setpoint as setpoint source.....	267
6.18.6	Pulse input as source of setpoint value.....	271
6.19	Setpoint calculation.....	273
6.19.1	Overview.....	273
6.19.2	Invert setpoint.....	274
6.19.3	Inhibit direction of rotation.....	275
6.19.4	Skip frequency bands and minimum speed.....	276
6.19.5	Speed limitation.....	277
6.19.6	Ramp-function generator.....	278
6.20	PID technology controller.....	283
6.21	Motor control.....	288
6.21.1	Reactor, filter and cable resistance at the inverter output.....	288
6.21.2	V/f control.....	289
6.21.2.1	Characteristics of U/f control.....	291
6.21.2.2	Optimizing motor starting.....	294

6.21.2.3	Optimizing the motor startup for application class Standard Drive Control.....	296
6.21.3	Vector control.....	298
6.21.3.1	Structure of the vector control.....	298
6.21.3.2	Default setting as a result of the application class Dynamic Drive Control.....	300
6.21.3.3	Checking the encoder signal.....	300
6.21.3.4	Optimizing the speed controller.....	300
6.21.3.5	Advanced settings.....	303
6.21.3.6	Friction characteristic.....	306
6.21.3.7	Moment of inertia estimator.....	308
6.21.4	Torque control.....	314
6.21.5	Application examples for closed-loop motor control.....	315
6.22	Electrically braking the motor.....	316
6.22.1	DC braking.....	318
6.22.2	Compound braking.....	321
6.22.3	Dynamic braking.....	323
6.22.4	Braking with regenerative feedback to the line.....	325
6.23	Overcurrent protection.....	326
6.24	Inverter protection using temperature monitoring.....	327
6.25	Motor protection with temperature sensor.....	330
6.26	Motor protection by calculating the temperature.....	333
6.27	Motor and inverter protection by limiting the voltage.....	335
6.28	Monitoring the driven load.....	337
6.28.1	Breakdown protection.....	338
6.28.2	No-load monitoring.....	338
6.28.3	Blocking protection.....	339
6.28.4	Torque monitoring.....	340
6.28.5	Rotation monitoring.....	341
6.28.6	Speed deviation monitoring.....	342
6.29	Flying restart – switching on while the motor is running.....	344
6.30	Automatic restart.....	346
6.31	Kinetic buffering (V _{dc} min control).....	350
6.32	Efficiency optimization.....	352
6.33	Line contactor control.....	355
6.34	Calculating the energy saving for fluid flow machines.....	357
6.35	Switchover between different settings.....	359
7	Saving the settings and series commissioning.....	361
7.1	Saving settings on a memory card.....	362
7.1.1	Memory cards.....	362
7.1.2	Saving setting on memory card.....	365
7.1.3	Transferring the setting from the memory card.....	368
7.1.4	Safely remove the memory card.....	370
7.1.5	Activate message for a memory card that is not inserted.....	372
7.2	Saving settings on a PC.....	373

7.3	Saving settings to an operator panel.....	375
7.4	Other ways to back up settings.....	377
7.5	Write protection.....	378
7.6	Know-how protection.....	380
7.6.1	Extending the exception list for know-how protection.....	382
7.6.2	Activating and deactivating know-how protection.....	383
8	Alarms, faults and system messages.....	387
8.1	Operating states indicated on LEDs.....	388
8.2	System runtime.....	392
8.3	Identification & maintenance data (I&M).....	393
8.4	Alarms, alarm buffer, and alarm history.....	394
8.5	Faults, alarm buffer and alarm history.....	397
8.6	List of alarms and faults.....	401
9	Corrective maintenance.....	411
9.1	Spare parts compatibility.....	411
9.2	Replacing inverter components.....	412
9.2.1	Overview of replacing converter components.....	413
9.2.2	Replacing a Control Unit with enabled safety function.....	415
9.2.3	Replacing the Control Unit without the safety functions enabled.....	418
9.2.4	Replacing the Control Unit without data backup.....	421
9.2.5	Replacing a Control Unit with active know-how protection.....	421
9.2.6	Replacing a Power Module with enabled safety function.....	424
9.2.7	Replacing a Power Module without the safety function being enabled.....	425
9.3	Replacing an encoder.....	426
9.3.1	Replacing the encoder - same encoder type.....	426
9.3.2	Replacing the encoder - different encoder type.....	427
9.4	Firmware upgrade and downgrade.....	429
9.4.1	Upgrading the firmware.....	431
9.4.2	Firmware downgrade.....	433
9.4.3	Correcting an unsuccessful firmware upgrade or downgrade.....	435
9.5	Reduced acceptance after a component has been replaced and a firmware change.....	436
9.6	If the converter no longer responds.....	437
10	Technical data.....	439
10.1	Technical data, CU250S-2 Control Unit.....	439
10.2	Overload capability of the inverter.....	444
10.3	Technical data, PM240-2 Power Modules.....	445
10.3.1	High overload - low overload PM240-2.....	445
10.3.2	Ambient conditions.....	445
10.3.3	General technical data, 200 V inverters.....	447
10.3.4	Specific technical data, 200 V inverters.....	448
10.3.5	Current derating depending on the pulse frequency, 200 V inverters.....	455

10.3.6	General technical data, 400 V inverters.....	456
10.3.7	Specific technical data, 400 V inverters.....	457
10.3.8	Current derating depending on the pulse frequency, 400 V inverters.....	465
10.3.9	General technical data, 690 V inverters.....	466
10.3.10	Specific technical data, 690 V inverters.....	467
10.3.11	Current derating depending on the pulse frequency, 690 V inverters.....	470
10.4	Technical data, PM250 Power Module.....	471
10.4.1	Ambient conditions.....	472
10.4.2	General technical data, PM250.....	473
10.4.3	Specific technical data, PM250.....	474
10.4.4	Current reduction depending upon pulse frequency.....	476
10.5	Data regarding the power loss in partial load operation.....	477
10.6	Restrictions for special ambient conditions.....	478
A	Appendix.....	481
A.1	New and extended functions.....	481
A.1.1	Firmware version 4.7 SP10.....	481
A.1.2	Firmware version 4.7 SP9.....	483
A.1.3	Firmware version 4.7 SP6.....	485
A.1.4	Firmware version 4.7 SP3.....	486
A.1.5	Firmware version 4.7.....	489
A.1.6	Firmware version 4.6 SP6.....	490
A.1.7	Firmware version 4.6.....	491
A.2	Activating licensed functions.....	492
A.2.1	Licensing.....	492
A.2.2	Creating or displaying the license key.....	493
A.2.3	Writing the license key to the card.....	496
A.3	Handling the BOP 2 operator panel.....	498
A.3.1	Changing settings using BOP-2.....	499
A.3.2	Changing indexed parameters.....	500
A.3.3	Directly entering the parameter number and value.....	501
A.3.4	A parameter cannot be changed.....	502
A.4	Interconnecting signals in the inverter.....	503
A.4.1	Fundamentals.....	503
A.4.2	Application example.....	505
A.5	Application Examples.....	507
A.5.1	Setting an absolute encoder.....	507
A.5.2	Connecting a fail-safe digital input.....	511
A.6	Acceptance tests for the safety functions.....	513
A.6.1	Recommended acceptance test.....	513
A.6.2	Acceptance test STO (basic functions).....	514
A.6.3	Machine documentation.....	516
A.6.4	Documenting the settings for the basic functions, firmware V4.4 ... V4.7 SP6.....	518
A.7	Manuals and technical support.....	519
A.7.1	Overview of the manuals.....	519
A.7.2	Configuring support.....	521
A.7.3	Product Support.....	522

Index.....523

Fundamental safety instructions

1.1 General safety instructions



! WARNING

Electric shock and danger to life due to other energy sources

Touching live components can result in death or severe injury.

- Only work on electrical devices when you are qualified for this job.
- Always observe the country-specific safety rules.

Generally, the following six steps apply when establishing safety:

1. Prepare for disconnection. Notify all those who will be affected by the procedure.
2. Isolate the drive system from the power supply and take measures to prevent it being switched back on again.
3. Wait until the discharge time specified on the warning labels has elapsed.
4. Check that there is no voltage between any of the power connections, and between any of the power connections and the protective conductor connection.
5. Check whether the existing auxiliary supply circuits are de-energized.
6. Ensure that the motors cannot move.
7. Identify all other dangerous energy sources, e.g. compressed air, hydraulic systems, or water. Switch the energy sources to a safe state.
8. Check that the correct drive system is completely locked.

After you have completed the work, restore the operational readiness in the inverse sequence.



! WARNING

Risk of electric shock and fire from supply networks with an excessively high impedance

Excessively low short-circuit currents can lead to the protective devices not tripping or tripping too late, and thus causing electric shock or a fire.

- In the case of a conductor-conductor or conductor-ground short-circuit, ensure that the short-circuit current at the point where the inverter is connected to the line supply at least meets the minimum requirements for the response of the protective device used.
- You must use an additional residual-current device (RCD) if a conductor-ground short circuit does not reach the short-circuit current required for the protective device to respond. The required short-circuit current can be too low, especially for TT supply systems.



⚠ WARNING

Risk of electric shock and fire from supply networks with an excessively low impedance

Excessively high short-circuit currents can lead to the protective devices not being able to interrupt these short-circuit currents and being destroyed, and thus causing electric shock or a fire.

- Ensure that the prospective short-circuit current at the line terminal of the inverter does not exceed the breaking capacity (SCCR or I_{cc}) of the protective device used.



⚠ WARNING

Electric shock if there is no ground connection

For missing or incorrectly implemented protective conductor connection for devices with protection class I, high voltages can be present at open, exposed parts, which when touched, can result in death or severe injury.

- Ground the device in compliance with the applicable regulations.



⚠ WARNING

Electric shock due to connection to an unsuitable power supply

When equipment is connected to an unsuitable power supply, exposed components may carry a hazardous voltage that might result in serious injury or death.

- Only use power supplies that provide SELV (Safety Extra Low Voltage) or PELV- (Protective Extra Low Voltage) output voltages for all connections and terminals of the electronics modules.



⚠ WARNING

Electric shock due to equipment damage

Improper handling may cause damage to equipment. For damaged devices, hazardous voltages can be present at the enclosure or at exposed components; if touched, this can result in death or severe injury.

- Ensure compliance with the limit values specified in the technical data during transport, storage and operation.
- Do not use any damaged devices.



⚠ WARNING

Electric shock due to unconnected cable shield

Hazardous touch voltages can occur through capacitive cross-coupling due to unconnected cable shields.

- As a minimum, connect cable shields and the conductors of power cables that are not used (e.g. brake cores) at one end at the grounded housing potential.



⚠ WARNING

Arcing when a plug connection is opened during operation

Opening a plug connection when a system is operation can result in arcing that may cause serious injury or death.

- Only open plug connections when the equipment is in a voltage-free state, unless it has been explicitly stated that they can be opened in operation.



⚠ WARNING

Electric shock due to residual charges in power components

Because of the capacitors, a hazardous voltage is present for up to 5 minutes after the power supply has been switched off. Contact with live parts can result in death or serious injury.

- Wait for 5 minutes before you check that the unit really is in a no-voltage condition and start work.

NOTICE

Property damage due to loose power connections

Insufficient tightening torques or vibration can result in loose power connections. This can result in damage due to fire, device defects or malfunctions.

- Tighten all power connections to the prescribed torque.
- Check all power connections at regular intervals, particularly after equipment has been transported.

⚠ WARNING

Spread of fire from built-in devices

In the event of fire outbreak, the enclosures of built-in devices cannot prevent the escape of fire and smoke. This can result in serious personal injury or property damage.

- Install built-in units in a suitable metal cabinet in such a way that personnel are protected against fire and smoke, or take other appropriate measures to protect personnel.
- Ensure that smoke can only escape via controlled and monitored paths.

 **WARNING**

Active implant malfunctions due to electromagnetic fields

Inverters generate electromagnetic fields (EMF) in operation. People with active implants in the immediate vicinity of this equipment are at particular risk.

- As the operator of an EMF-emitting installation, assess the individual risks of persons with active implants. The following clearances are usually adequate:
 - No clearance to closed control cabinets and shielded MOTION-CONNECT supply cables
 - Forearm length (approx. 35 cm clearance) to distributed drive systems and open control cabinets

 **WARNING**

Unexpected movement of machines caused by radio devices or mobile phones

When radio devices or mobile phones with a transmission power > 1 W are used in the immediate vicinity of components, they may cause the equipment to malfunction. Malfunctions may impair the functional safety of machines and can therefore put people in danger or lead to property damage.

- If you come closer than around 2 m to such components, switch off any radios or mobile phones.
- Use the "SIEMENS Industry Online Support app" only on equipment that has already been switched off.

NOTICE

Damage to motor insulation due to excessive voltages

When operated on systems with grounded line conductor or in the event of a ground fault in the IT system, the motor insulation can be damaged by the higher voltage to ground. If you use motors that have insulation that is not designed for operation with grounded line conductors, you must perform the following measures:

- IT system: Use a ground fault monitor and eliminate the fault as quickly as possible.
- TN or TT systems with grounded line conductor: Use an isolating transformer on the line side.

 **WARNING**

Fire due to inadequate ventilation clearances

Inadequate ventilation clearances can cause overheating of components with subsequent fire and smoke. This can cause severe injury or even death. This can also result in increased downtime and reduced service lives for devices/systems.

- Ensure compliance with the specified minimum clearance as ventilation clearance for the respective component.

 WARNING**Unrecognized dangers due to missing or illegible warning labels**

Dangers might not be recognized if warning labels are missing or illegible. Unrecognized dangers may cause accidents resulting in serious injury or death.

- Check that the warning labels are complete based on the documentation.
- Attach any missing warning labels to the components, where necessary in the national language.
- Replace illegible warning labels.

NOTICE**Device damage caused by incorrect voltage/insulation tests**

Incorrect voltage/insulation tests can damage the device.

- Before carrying out a voltage/insulation check of the system/machine, disconnect the devices as all converters and motors have been subject to a high voltage test by the manufacturer, and therefore it is not necessary to perform an additional test within the system/machine.

 WARNING**Unexpected movement of machines caused by inactive safety functions**

Inactive or non-adapted safety functions can trigger unexpected machine movements that may result in serious injury or death.

- Observe the information in the appropriate product documentation before commissioning.
- Carry out a safety inspection for functions relevant to safety on the entire system, including all safety-related components.
- Ensure that the safety functions used in your drives and automation tasks are adjusted and activated through appropriate parameterizing.
- Perform a function test.
- Only put your plant into live operation once you have guaranteed that the functions relevant to safety are running correctly.

Note**Important safety notices for Safety Integrated functions**

If you want to use Safety Integrated functions, you must observe the safety notices in the Safety Integrated manuals.

 **WARNING**

Malfunctions of the machine as a result of incorrect or changed parameter settings

As a result of incorrect or changed parameterization, machines can malfunction, which in turn can lead to injuries or death.

- Protect the parameterization (parameter assignments) against unauthorized access.
- Handle possible malfunctions by taking suitable measures, e.g. emergency stop or emergency off.

1.2 Equipment damage due to electric fields or electrostatic discharge

Electrostatic sensitive devices (ESD) are individual components, integrated circuits, modules or devices that may be damaged by either electric fields or electrostatic discharge.



NOTICE

Equipment damage due to electric fields or electrostatic discharge

Electric fields or electrostatic discharge can cause malfunctions through damaged individual components, integrated circuits, modules or devices.

- Only pack, store, transport and send electronic components, modules or devices in their original packaging or in other suitable materials, e.g. conductive foam rubber or aluminum foil.
- Only touch components, modules and devices when you are grounded by one of the following methods:
 - Wearing an ESD wrist strap
 - Wearing ESD shoes or ESD grounding straps in ESD areas with conductive flooring
- Only place electronic components, modules or devices on conductive surfaces (table with ESD surface, conductive ESD foam, ESD packaging, ESD transport container).

1.3 Warranty and liability for application examples

Application examples are not binding and do not claim to be complete regarding configuration, equipment or any eventuality which may arise. Application examples do not represent specific customer solutions, but are only intended to provide support for typical tasks.

As the user you yourself are responsible for ensuring that the products described are operated correctly. Application examples do not relieve you of your responsibility for safe handling when using, installing, operating and maintaining the equipment.

1.4 Industrial security

Note

Industrial security

Siemens provides products and solutions with industrial security functions that support the secure operation of plants, systems, machines and networks.

In order to protect plants, systems, machines and networks against cyber threats, it is necessary to implement – and continuously maintain – a holistic, state-of-the-art industrial security concept. Siemens' products and solutions constitute one element of such a concept.

Customers are responsible for preventing unauthorized access to their plants, systems, machines and networks. Such systems, machines and components should only be connected to an enterprise network or the Internet if and to the extent such a connection is necessary and only when appropriate security measures (e.g. firewalls and/or network segmentation) are in place.

For additional information on industrial security measures that may be implemented, please visit:

Industrial security (<http://www.siemens.com/industrialsecurity>)

Siemens' products and solutions undergo continuous development to make them more secure. Siemens strongly recommends that product updates are applied as soon as they are available and that the latest product versions are used. Use of product versions that are no longer supported, and failure to apply the latest updates may increase customer's exposure to cyber threats.

To stay informed about product updates, subscribe to the Siemens Industrial Security RSS Feed at:

Industrial security (<http://www.siemens.com/industrialsecurity>)

Further information is provided on the Internet:

Industrial Security Configuration Manual (<https://support.industry.siemens.com/cs/ww/en/view/108862708>)



WARNING

Unsafe operating states resulting from software manipulation

Software manipulations (e.g. viruses, trojans, malware or worms) can cause unsafe operating states in your system that may lead to death, serious injury, and property damage.

- Keep the software up to date.
- Incorporate the automation and drive components into a holistic, state-of-the-art industrial security concept for the installation or machine.
- Make sure that you include all installed products into the holistic industrial security concept.
- Protect files stored on exchangeable storage media from malicious software by with suitable protection measures, e.g. virus scanners.
- Protect the drive against unauthorized changes by activating the "know-how protection" drive function.

1.5 Residual risks of power drive systems

When assessing the machine- or system-related risk in accordance with the respective local regulations (e.g., EC Machinery Directive), the machine manufacturer or system installer must take into account the following residual risks emanating from the control and drive components of a drive system:

1. Unintentional movements of driven machine or system components during commissioning, operation, maintenance, and repairs caused by, for example,
 - Hardware and/or software errors in the sensors, control system, actuators, and cables and connections
 - Response times of the control system and of the drive
 - Operation and/or environmental conditions outside the specification
 - Condensation/conductive contamination
 - Parameterization, programming, cabling, and installation errors
 - Use of wireless devices/mobile phones in the immediate vicinity of electronic components
 - External influences/damage
 - X-ray, ionizing radiation and cosmic radiation
2. Unusually high temperatures, including open flames, as well as emissions of light, noise, particles, gases, etc., can occur inside and outside the components under fault conditions caused by, for example:
 - Component failure
 - Software errors
 - Operation and/or environmental conditions outside the specification
 - External influences/damage
3. Hazardous shock voltages caused by, for example:
 - Component failure
 - Influence during electrostatic charging
 - Induction of voltages in moving motors
 - Operation and/or environmental conditions outside the specification
 - Condensation/conductive contamination
 - External influences/damage
4. Electrical, magnetic and electromagnetic fields generated in operation that can pose a risk to people with a pacemaker, implants or metal replacement joints, etc., if they are too close
5. Release of environmental pollutants or emissions as a result of improper operation of the system and/or failure to dispose of components safely and correctly
6. Influence of network-connected communication systems, e.g. ripple-control transmitters or data communication via the network

For more information about the residual risks of the drive system components, see the relevant sections in the technical user documentation.

Introduction

2.1 About the Manual

Who requires the operating instructions and what for?

These operating instructions primarily address fitters, commissioning engineers and machine operators. The operating instructions describe the devices and device components and enable the target groups being addressed to install, connect-up, set, and commission the converters safely and in the correct manner.

What is described in the operating instructions?

These operating instructions provide a summary of all of the information required to operate the converter under normal, safe conditions.

The information provided in the operating instructions has been compiled in such a way that it is sufficient for all standard applications and enables drives to be commissioned as efficiently as possible. Where it appears useful, additional information for entry level personnel has been added.

The operating instructions also contain information about special applications. Since it is assumed that readers already have a sound technical knowledge of how to configure and parameterize these applications, the relevant information is summarized accordingly. This relates, e.g. to operation with fieldbus systems and safety-related applications.

What is the meaning of the symbols in the manual?

 Reference to further information in the manual

 Download from the Internet

 DVD that can be ordered







End of a handling instruction.





Examples of inverter function symbols



2.2 Guide through the manual

Section	In this section you will find answers to the following questions:
 Description (Page 29)	<ul style="list-style-type: none"> • How is the inverter marked? • Which components make up the inverter? • Which optional components are available for the inverter? • What is the purpose of the optional components? • Which motors can be fed from the inverter? • Which commissioning tools are there?
 Installing (Page 53)	<ul style="list-style-type: none"> • Which sequence is recommended when installing the inverter? • What does EMC-compliant installation actually mean? • Which options are available to install optional components below the inverter? • What are the inverter dimensions? • Which mounting and installation materials are required when installing the inverter? • To which line supplies can the inverter be connected? • How is the inverter connected to the line supply? • How is the braking resistor connected to the inverter? • Which terminals and fieldbus interfaces does the inverter have? • What are the interface functions?
 Commissioning (Page 125)	<ul style="list-style-type: none"> • Which motor data is required for commissioning • How is the inverter set in the factory? • What is the commissioning procedure? • How do you restore the inverter factory settings?
 Advanced commissioning (Page 157)	<ul style="list-style-type: none"> • Which functions are included in the inverter firmware? • How do the functions interoperate with one another? • How are the functions set?
 Saving the settings and series commissioning (Page 361)	<ul style="list-style-type: none"> • Why is it necessary to back up the inverter settings? • Which options are available to back up the settings? • How does the data backup function? • How do you prevent the inverter settings from being changed? • How do you prevent the inverter settings from being read out?
 Corrective maintenance (Page 411)	<ul style="list-style-type: none"> • How are inverter components replaced? • How do you change the firmware version of the inverter?
 Alarms, faults and system messages (Page 387)	<ul style="list-style-type: none"> • What is the meaning of the LEDs provided on the inverter? • How does the system runtime respond? • How does the inverter save alarms and faults? • What do the inverter alarms and faults mean? • How are inverter faults resolved? • Which I&M data is saved in the inverter?

Section	In this section you will find answers to the following questions:
 Technical data (Page 439)	<ul style="list-style-type: none">• What is the inverter technical data?• What do "High Overload" and "Low Overload" mean?
 Appendix (Page 481)	<ul style="list-style-type: none">• What are the new functions of the current firmware?• What are the most important inverter parameters?• How is the inverter operated using the BOP-2 Operator Panel?• How does the device trace function in STARTER?• How can signal interconnections be changed in the inverter firmware?• What does "BiCo technology" mean?• Where can you find additional manuals and information about the inverter?

Description

Use for the intended purpose

The inverter described in this manual is a device to control a three-phase motor. The inverter is designed for installation in electrical installations or machines.

It has been approved for industrial and commercial use on industrial networks. Additional measures have to be taken when connected to public grids.

The technical specifications and information about connection conditions are indicated on the rating plate and in the operating instructions.

Use of third-party products

This document contains recommendations relating to third-party products. Siemens accepts the fundamental suitability of these third-party products.

You can use equivalent products from other manufacturers.

Siemens does not accept any warranty for the properties of third-party products.

Use of OpenSSL

This product contains software developed in the OpenSSL project for use within the OpenSSL toolkit.

This product contains cryptographic software created by Eric Young.

This product contains software developed by Eric Young.

Further information is provided on the Internet:

 OpenSSL (<https://www.openssl.org/>)

 Cryptsoft (<mailto:eay@cryptsoft.com>)

3.1 Identifying the converter

Main components of the inverter

Each SINAMICS G120 inverter comprises a Control Unit and Power Module.

- The Control Unit controls and monitors the Power Module and the connected motor.
- The Power Module provides the connections for line supply and motor.

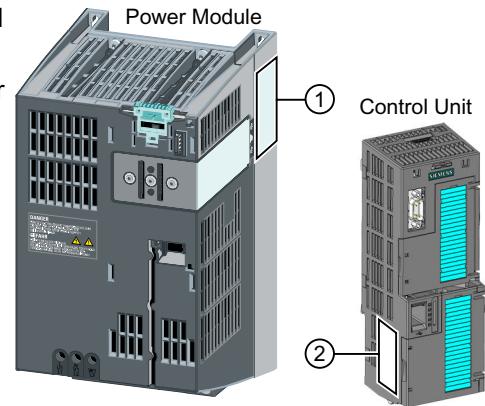

The following data is provided on the Power Module type plate (①):







- Designation, e.g. PM240-2 Power Module
- Technical data: Voltage, current and power
- Article number, e.g. 6SL3210-1PE21-1UL0
- Version, e.g. A02

The following data can be found on the Control Unit type plate (②):

- Designation, e.g. CU250S-2 DP Control Unit
- Article number, e.g. 6SL3246-0BA22-1PA0
- Version, e.g. 02 (hardware), 4.7 (firmware)

Further inverter components

The following components are available so that you can adapt the inverter to different applications and ambient conditions:

-  Line filter (Page 39)
-  Line reactor (Page 40)
-  Output reactor (Page 42)
-  Sine-wave filter (Page 47)
-  Braking resistor (Page 48)
-  Brake relay to control a motor holding brake (Page 50)

3.2 Directives and standards

Relevant directives and standards

The following directives and standards are relevant for the inverters:



European Low Voltage Directive

The inverters fulfil the requirements stipulated in the Low-Voltage Directive 2014/35/EU, if they are covered by the application area of this directive.

European Machinery Directive

The inverters fulfil the requirements stipulated in the Machinery Directive 2006/42/EU, if they are covered by the application area of this directive.

However, the use of the inverters in a typical machine application has been fully assessed for compliance with the main regulations in this directive concerning health and safety.

Directive 2011/65/EU

The inverter fulfills the requirements of Directive 2011/65/EU relating to the restriction of the use of certain hazardous substances in electrical and electronic devices (RoHS).

European EMC Directive

By completely complying with IEC/EN 61800-3, it has been proven that the inverter is in compliance with directive 2004/108/EC or 2014/30/EU.

Underwriters Laboratories (North American market)

Inverters provided with one of the test symbols displayed fulfil the requirements stipulated for the North American market as a component of drive applications, and are appropriately listed.



EMC requirements for South Korea

The inverters with the KC marking on the rating plate satisfy the EMC requirements for South Korea.

Eurasian conformity

The inverters comply with the requirements of the Russia/Belarus/Kazakhstan customs union (EAC).



Australia and New Zealand (RCM formerly C-Tick)

The inverters showing the test symbols fulfil the EMC requirements for Australia and New Zealand.





Immunity to voltage drop of semiconductor process equipment.

The inverters comply with the requirements of standard SEMI F47-0706.

Quality systems

Siemens AG employs a quality management system that meets the requirements of ISO 9001 and ISO 14001.

Certificates for download

-  EC Declaration of Conformity: (<https://support.industry.siemens.com/cs/ww/de/view/58275445>)
-  Certificates for the relevant directives, prototype test certificates, manufacturers declarations and test certificates for functions relating to functional safety ("Safety Integrated"): (<http://support.automation.siemens.com/WW/view/en/22339653/134200>)
-  Certificates for products that were certified by UL: (<http://database.ul.com/cgi-bin/XYV/template/LISEXT/1FRAME/index.html>)
-  Certificates for products that were certified by TÜV SÜD: (https://www.tuev-sued.de/industrie_konsumprodukte/zertifikatsdatenbank)

Standards that are not relevant



China Compulsory Certification

The inverters do not fall in the area of validity of the China Compulsory Certification (CCC).

3.3 Overview of Control Units

Versions

The CU250S-2 Control Units differ with regard to the type of fieldbus.

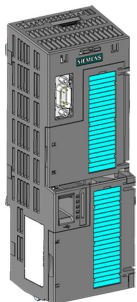
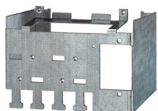

Table 3-1 Control Unit versions

Designation	Article number	Fieldbus
CU250S-2	6SL3246-0BA22-1BA0	USS, Modbus RTU
CU250S-2 DP	6SL3246-0BA22-1PA0	PROFIBUS
CU250S-2 PN	6SL3246-0BA22-1FA0	PROFINET, EtherNet/IP
CU250S-2 CAN	6SL3246-0BA22-1CA0	CANopen

Shield connection kit for the Control Unit



The shield connection kit is an optional component. The shield connection kit comprises the following components:

- Shield plate
- Elements for optimum shield support and strain relief of the signal and communication cables

Article number for the SINAMICS CU Screening Termination Kit 4: 6SL3264-1EA00-0LA0.

3.4 Power Modules

Important data on the Power Modules is provided in this section. Further information is contained in the Hardware Installation Manual of the Power Module.

 Overview of the manuals (Page 519)

All power data refers to rated values or to power for operation with low overload (LO).

You can operate the CU250S-2 Control Unit with the following Power Modules:

- PM240-2, in IP20 degree of protection and push-through technology
- PM240P-2
- PM250

3.4.1 Power Module with IP20 degree of protection



Figure 3-1 Examples of Power Modules with IP20 degree of protection

PM240-2 for standard applications

The PM240-2 Power Module is available without a filter or with an integrated class A line filter. The PM240-2 permits dynamic braking via an external braking resistor.

Table 3-2 1-phase/3-phase 200 VAC ... 240 VAC, article number 6SL3210-1PB... and 6SL3210-1PC...

Frame size	FSA	FSB	FSC	FSD	FSE	FSF
Power (kW)	0.55 ... 0.75	1.1 ... 2.2	3.0 ... 4.0	11 ... 18.5	22 ... 30	37 ... 55

Table 3-3 3-phase 380 VAC ... 480 VAC, article number 6SL3210-1PE...

Frame size	FSA	FSB	FSC	FSD	FSE	FSF	FSG
Power (kW)	0.55 ... 3.0	4.0 ... 7.5	11 ... 15	18.5 ... 37	45 ... 55	75 ... 132	160 ... 250

Table 3-4 3-phase 500 VAC ... 690 VAC, article number 6SL3210-1PH...

Frame size	FSD	FSE	FSF	FSG
Power (kW)	11 ... 37	45 ... 55	75 ... 132	160 ... 250

PM250 for standard applications with energy recovery

The PM250 Power Module is available without a filter or with integrated class A line filter. The PM250 permits dynamic braking with energy recovery into the line supply.

Table 3-5 3-phase 380 VAC ... 480 VAC, article number 6SL3225-0BE...

Frame size	FSC	FSD	FSE	FSF
Power (kW)	7.5 ... 15	18.5 ... 30	37 ... 45	55 ... 90

3.4.2 Power Module with Push-Through technology



Figure 3-2 Examples of Power Modules with Push-Through technology FSA ... FSC

PM240-2 with Push-Through technology for standard applications

The PM240-2 Power Module is available with Push-Through technology without a filter or with an integrated class A line filter. The PM240-2 allows dynamic braking using an external braking resistor.

Table 3-6 1-phase/3-phase 200 VAC ... 240 VAC, article number 6SL3211-1PB...

Frame size	FSA	FSB	FSC	FSD	FSE	FSF
Power (kW)	0.75	2.2	4.0	18.5	30	55

Table 3-7 3-phase 380 VAC ... 480 VAC, article number 6SL3211-1PE...

Frame size	FSA	FSB	FSC	FSD	FSE	FSF
Power (kW)	3.0	7.5	15	37	55	132

Table 3-8 3 AC 500 V ... 690 V, Article No. 6SL3211-1PH...

Frame size	FSD	FSE	FSF
Power (kW)	37	55	132

3.5 Components for the Power Modules

3.5.1 Accessories for shielding

Shield connection kit

Establish the shield and strain relief for the power connections using the shield connection kit.

The shield connection kit comprises a shield plate and serrated strips with screws.

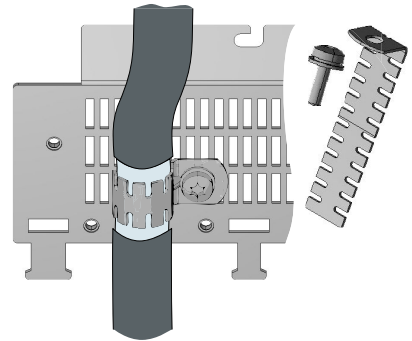

Table 3-9 Article numbers for the shield connection kit

Frame size	PM240-2	PM250 Power Module
FSA	The shield connection kit is included in the scope of delivery	6SL3262-1AA00-0BA0
FSB		6SL3262-1AB00-0DA0
FSC		6SL3262-1AC00-0DA0
FSD		6SL3262-1AD00-0DA0
FSE		6SL3262-1AD00-0DA0
FSF		6SL3262-1AF00-0DA0
FSG		---

3.5.2 Line filter

With a line filter, the inverter can achieve a higher radio interference class.

NOTICE
<p>Overloading the line filter when connected to line supplies that are not permissible</p> <p>The line filter is only suitable for operation on TN or TT line supplies with a grounded neutral point. If operated on other line supplies, the line filter will be thermally overloaded and will be damaged.</p> <ul style="list-style-type: none"> • For inverters equipped with line filter, only connect to TN or TT line supplies with a grounded neutral point.

External line filters for PM250

Power Module		Power	Class B line filter according to EN55011: 2009
FSC	6SL3225-0BE25-5AA0, 6SL3225-0BE27-5AA0, 6SL3225-0BE31-1AA0	7.5 kW ... 15.0 kW	6SL3203-0BD23-8SA0

3.5.3 Line reactor

The line reactor supports the overvoltage protection, smoothes the harmonics in the line supply and bridges commutation dips. For the Power Modules subsequently listed, a line reactor is suitable in order to dampen the specified effects.

The figure on the right-hand side shows as example the line reactors for the PM240-2 Power Modules, FSB.

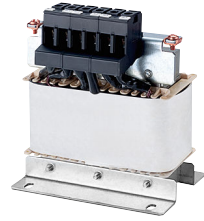

The line requirements for deployment of a line reactor depends on the Power Module:

 Technical data (Page 439)

NOTICE

Damage to the inverter as a result of a missing line reactor

Depending on the Power Module and line supply, if a line reactors is not used, this can result in damage to the inverter and other components in the electrical plant or system.

- Install a line reactor if the relative short-circuit voltage of the line supply is below 1%

Line reactors for PM240-2, 380 V ... 480 V

Power Module		Power	Line reactor
FSA	6SL3210-1PE11-8 . L1, 6SL3210-1PE12-3 . L1, 6SL3210-1PE13-2 . L1	0.55 kW ... 1.1 kW	6SL3203-0CE13-2AA0
FSB	6SL3210-1PE14-3 . L1, 6SL321 . -1PE16-1 . L1, 6SL321 . -1PE18-0 . L1	1.5 kW ... 3 kW	6SL3203-0CE21-0AA0
FSC	6SL3210-1PE21-1 . L0, 6SL3210-1PE21-4 . L0, 6SL321 . -1PE21-8 . L0	4 kW ... 7.5 kW	6SL3203-0CE21-8AA0
	6SL3210-1PE22-7 . L0, 6SL321 . -1PE23-3 . L0	11 kW ... 15 kW	6SL3203-0CE23-8AA0

FSD ... FSG: A line reactor is not required.

Line reactors for PM240-2 Power Module, 500 V ... 690 V

A line reactor is not required.

Line reactors for PM240-2, 200 V ... 240 V

Power Module		Power	Line reactor
FSA	6SL3210-1PB13-0 . L0, 6SL3210-1PB13-8 . L0	0.55 kW ... 0.75 kW	6SL3203-0CE13-2AA0
FSB	6SL3210-1PB15-5 . L0, 6SL3210-1PB17-4 . L0, 6SL321 . -1PB21-0 . L0	1.1 kW ... 2.2 kW	6SL3203-0CE21-0AA0
FSC	6SL3210-1PB21-4 . L0, 6SL321 . -1PB21-8 . L0	3 kW ... 4 kW	6SL3203-0CE21-8AA0
	6SL321 . -1PC22-2 . L0, 6SL3210-1PC22-8 . L0	5.5 kW ... 7.5 kW	6SL3203-0CE23-8AA0

FSD ... FSF: A line reactor is not required.

3.5.4 Output reactor

Output reactors reduce the voltage stress on the motor windings and the load placed on the inverter as a result of capacitive recharging currents in the cables. One or two output reactors are required for longer motor cables.

You will find more information about permissible motor cable lengths in the Hardware Installation Manual for the Power Module.

 Overview of the manuals (Page 519)

The figure on the right-hand side shows as example the output reactors for PM240-2 Power Modules, FSB and FSC.

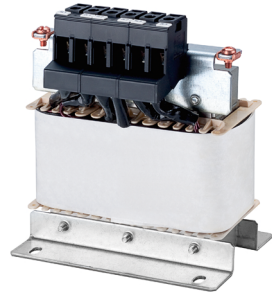

NOTICE

Overheating of the output reactor if the pulse frequency is too high

The output reactor is dimensioned for the inverter pulse frequency set in the factory. Inverter operation with pulse frequencies higher than the factory setting can result in thermal overload of the output reactor. Excessively high temperatures damage the output reactor.

- Operate the inverter with an output reactor with a maximum pulse frequency \leq factory setting.

Output reactors for PM240-2 Power Modules, 380 V ... 480 V

Power Module	Power	Output reactor
FSA 6SL3210-1PE11-8 . L1, 6SL3210-1PE12-3 . L1, 6SL3210-1PE13-2 . L1, 6SL3210-1PE14-3 . L1, 6SL3210-1PE16-1 . L1 6SL321 . -1PE18-0 . L1	0.55 kW ... 2.2 kW 3 kW	6SL3202-0AE16-1CA0 6SL3202-0AE18-8CA0
FSB 6SL3210-1PE21-1 . L0, 6SL3210-1PE21-4 . L0, 6SL321 . -1PE21-8 . L0	4 kW ... 7.5 kW	6SL3202-0AE21-8CA0
FSC 6SL3210-1PE22-7 . L0, 6SL321 . -1PE23-3 . L0	11 kW ... 15 kW	6SL3202-0AE23-8CA0
FSD 6SL3210-1PE23-8 . L0 6SL3210-1PE24-5 . L0 6SL3210-1PE26-0 . L0 6SL3210-1PE27-5 . L0	18.5 kW ... 37 kW	6SE6400-3TC07-5ED0
FSE 6SL3210-1PE28-8 . L0, 6SL3210-1PE31-1 . L0, 6SL3210-1PE31-5 . L0, 6SL3210-1PE31-8 . L0	45 kW ... 90 kW	6SE6400-3TC14-5FD0
FSF 6SL3210-1PE32-1 . L0 6SL3210-1PE32-5 . L0	110 kW 132 kW	6SL3000-2BE32-1AA0 6SL3000-2BE32-6AA0

Power Module		Power	Output reactor
FSG	6SL3210-1PE33-0 . L0	160 kW	6SL3000-2BE33-2AA0
	6SL3210-1PE33-7 . L0	200 kW	6SL3000-2BE33-8AA0
	6SL3210-1PE34-8 . L0	250 kW	6SL3000-2BE35-0AA0

Output reactors for PM240-2 Power Modules, 500 V ... 690 V

Power Module		Power	Output reactor
FSF	6SL3210-1PH28-0 . L0, 6SL3210-1PH31-0 . L0	75 kW ... 90 kW	6SL3000-2AH31-0AA0
	6SL3210-1PH31-2 . L0, 6SL3210-1PH31-4 . L0	110 kW ... 132 kW	6SL3000-2AH31-5AA0
FSG	6SL3210-1PH31-7CL0	160 kW	6SL3000-2AH31-8AA0
	6SL3210-1PH32-1CL0	200 kW	6SL3000-2AH32-4AA0
	6SL3210-1PH32-5CL0	250 kW	6SL3000-2AH32-6AA0

Output reactors for PM240-2 Power Modules, 200 V ... 240 V

Power Module		Power	Output reactor
FSA	6SL3210-1PB13-0 . L0, 6SL321 . -1PB13-8 . L0	0.55 kW ... 0.75 kW	6SL3202-0AE16-1CA0
FSB	6SL3210-1PB15-5 . L0	1.1 kW	
		6SL3210-1PB17-4 . L0	1.5 kW
FSB	6SL321 . -1PB21-0 . L0	2.2 kW	6SL3202-0AE21-8CA0
FSC	6SL3210-1PB21-4 . L0, 6SL321 . -1PB21-8 . L0	3 kW ... 4 kW	
		6SL321 . -1PC22-2 . L0, 6SL3210-1PC22-8 . L0	5.5 kw ... 7.5 kW
FSD	6SL3210-1PC24-2UL0, 6SL3210-1PC25-4UL0, 6SL3210-1PC26-8UL0	11 kW ... 18.5 kW	6SE6400-3TC07-5ED0
FSE	6SL3210-1PC28-0UL0, 6SL3210-1PC31-1UL0	22 kW ... 55 kW	6SE6400-3TC14-5FD0
FSF	6SL3210-1PC31-3UL0, 6SL3210-1PC31-6UL0, 6SL3210-1PC31-8UL0		

Output reactors for PM250 Power Module

Power Module		Power	Output reactor
FSC	6SL3225-0BE25-5 . A0, 6SL3225-0BE27-5 . A0, 6SL3225-0BE31-1 . A0	7.5 kW ... 15.0 kW	6SL3202-0AJ23-2CA0
FSD	6SL3225-0BE31-5 . A0	18.5 kW	6SE6400-3TC05-4DD0
	6SL3225-0BE31-8 . A0	22 kW	6SE6400-3TC03-8DD0
	6SL3225-0BE32-2 . A0	30 kW	6SE6400-3TC05-4DD0
FSE	6SL3225-0BE33-0 . A0	37 kW	6SE6400-3TC08-0ED0
	6SL3225-0BE33-7 . A0	45 kW	6SE6400-3TC07-5ED0
FSF	6SL3225-0BE34-5 . A0	55 kW	6SE6400-3TC14-5FD0
	6SL3225-0BE35-5 . A0	75 kW	6SE6400-3TC15-4FD0
	6SL3225-0BE37-5 . A0	90 kW	6SE6400-3TC14-5FD0

3.5.5 du/dt filter plus VPL

A combination of du/dt filter and a voltage peak limiter (VPL) – du/dt filter plus VPL – are available to suppress voltage peaks.

When using the du/dt filter plus VPL, the output frequency must not exceed 150 Hz. The pulse frequency may not exceed 4 kHz.

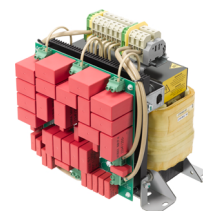

Further information is provided on the Internet:

 Sales Release and Operating Instructions (<https://support.industry.siemens.com/cs/ww/en/view/109756054>)

du/dt filters plus VPL for PM240-2 Power Modules, 380 V ... 480 V

Power Module		Power	du/dt filter plus VPL
FSA	6SL3210-1PE11-8 . L1, 6SL3210-1PE12-3 . L1, 6SL3210-1PE13-2 . L1, 6SL3210-1PE14-3 . L1, 6SL3210-1PE16-1 . L1, 6SL321 . -1PE18-0 . UL1	0.55 kW ... 3.0 kW	JTA:TEF1203-0GB
FSB	6SL3210-1PE21-1 . L0, 6SL3210-1PE21-4 . L0, 6SL321 . -1PE21-8 . L0	4.0 kW ... 7.5 kW	JTA:TEF1203-0GB
FSC	6SL3210-1PE22-7 . L0, 6SL321 . -1PE23-3 . L0	11 kW ... 15 kW	JTA:TEF1203-0HB
FSD	6SL3210-1PE23-8 . L0	18.5 kW	JTA:TEF1203-0HB
	6SL3210-1PE24-5 . L0, 6SL3210-1PE26-0 . L0	22 kW, 30 kW	JTA:TEF1203-0JB
FSD FSE	6SL321 . -1PE27-5 . L0, 6SL3210-1PE28-8 . L0	37 kW, 45 kW	JTA:TEF1203-0KB
FSE FSF	6SL321 . -1PE31-1 . L0, 6SL3210-1PE31-5 . L0	55 kW, 75 kW	JTA:TEF1203-0LB
FSF	6SL3210-1PE31-8 . L0, 6SL3210-1PE32-1 . L0, 6SL321 . -1PE32-5 . L0	90 kW ... 132 kW	JTA:TEF1203-0MB

du/dt filters plus VPL for PM240-2 Power Modules, 500 V ... 690 V

Power Module		Power	du/dt filter plus VPL
FSD	6SL3210-1PH21-4 . L0 6SL3210-1PH22-0 . L0 6SL3210-1PH22-3 . L0	11 kW ... 18.5 kW	JTA:TEF1203-0GB
	6SL3210-1PH22-7 . L0 6SL3210-1PH23-5 . L0 6SL3210-1PH24-2 . L0	22 kW ... 37 kW	JTA:TEF1203-0HB

Description

3.5 Components for the Power Modules

Power Module		Power	du/dt filter plus VPL
FSE	6SL3210-1PH25-2 . L0 6SL3210-1PH26-2 . L0	45 kW, 55 kW	JTA:TEF1203-0JB
FSF	6SL3210-1PH28-0 . L0 6SL3210-1PH31-0 . L0	75 kW, 90 kW	JTA:TEF1203-0KB
	6SL3210-1PH31-2 . L0 6SL3210-1PH31-4 . L0	110 kW, 132 kW	JTA:TEF1203-0LB
FSG	6SL3210-1PH31-7CLO 6SL3210-1PH32-1CLO 6SL3210-1PH32-5CLO	160 kW ... 250 kW	JTA:TEF1203-0MB

3.5.6 Sine-wave filter

The sine-wave filter at the inverter output limits the voltage rate-of-rise and the peak voltages at the motor winding. The maximum permissible length of motor feeder cables is increased to 300 m.

The following applies when using a sine-wave filter:

- Operation is only permissible with pulse frequencies from 4 kHz to 8 kHz.
From 110 kW power rating of the Power Modules (according to the type plate) only 4 kHz is permissible.
- The inverter power is reduced by 5%.
- The maximum output frequency of the inverter is 150 Hz at 380 V to 480 V.
- Operation and commissioning may only be performed with the motor connected, as the sine-wave filter is not no-load proof.
- An output reactor is superfluous.

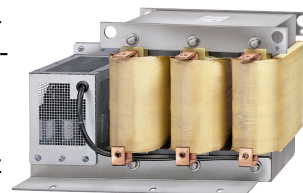

Sine-wave filter for PM250 Power Module

Power Module		Power	Sine-wave filter
FSC	6SL3225-0BE25-5 . A0	7.5 kW	6SL3202-0AE22-0SA0
	6SL3225-0BE27-5 . A0, 6SL3225-0BE31-1 . A0	11.0 kW ... 15.0 kW	6SL3202-0AE23-3SA0
FSD	6SL3225-0BE31-5 . A0, 6SL3225-0BE31-8 . A0	18.5 kW ... 22 kW	6SL3202-0AE24-6SA0
	6SL3225-0BE32-2 . A0	30 kW	6SL3202-0AE26-2SA0
FSE	6SL3225-0BE33-0 . A0, 6SL3225-0BE33-7 . A0	37 kW ... 45 kW	6SL3202-0AE28-8SA0
FSF	6SL3225-0BE34-5 . A0, 6SL3225-0BE35-5 . A0	55 kW ... 75 kW	6SL3202-0AE31-5SA0
	6SL3225-0BE37-5 . A0	90 kW	6SL3202-0AE31-8SA0

3.5.7 Braking resistor

The braking resistor allows loads with a high moment of inertia to be quickly braked.

The Power Module controls the braking resistor via its integrated braking module.

The figure shown on the right-hand side shows as example the braking resistor for a PM240-2 Power Module, FSB.

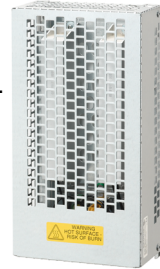

Braking resistors for PM240-2, 380 V ... 480 V

Power Module		Power	Braking resistor
FSA	6SL3210-1PE11-8 . L1, 6SL3210-1PE12-3 . L1, 6SL3210-1PE13-2 . L1, 6SL3210-1PE14-3 . L1	0.55 kW ... 1.5 kW	6SL3201-0BE14-3AA0
	6SL321 . -1PE16-1 . L1, 6SL321 . -1PE18-0 . L1	2.2 kW ... 3.0 kW	6SL3201-0BE21-0AA0
FSB	6SL3210-1PE21-1 . L0, 6SL3210-1PE21-4 . L0, 6SL321 . -1PE21-8 . L0	4 kW ... 7.5 kW	6SL3201-0BE21-8AA0
FSC	6SL3210-1PE22-7 . L0, 6SL321 . -1PE23-3 . L0	11 kW ... 15 kW	6SL3201-0BE23-8AA0
FSD	6SL3210-1PE23-8 . L0, 6SL3210-1PE24-5 . L0	18.5 kW ... 22 kW	JJY:023422620001
	6SL3210-1PE26-0 . L0, 6SL3210-1PE27-5 . L0	30 kW ... 37 kW	JJY:023424020001
FSE	6SL3210-1PE28-8 . L0, 6SL3210-1PE31-1 . L0	45 kW ... 55 kW	JJY:023434020001
FSF	6SL3210-1PE31-5 . L0, 6SL3210-1PE31-8 . L0,	75 kW ... 90 kW	JJY:023454020001
	6SL3210-1PE32-1 . L0, 6SL3210-1PE32-5 . L0	90 kW ... 132 kW	JJY:023464020001
FSG	6SL3210-1PE33-0AL0, 6SL3210-1PE33-7AL0, 6SL3210-1PE34-8AL0	160 kW ... 250 kW	6SL3000-1BE32-5AA0

Braking resistors for PM240-2, 500 V ... 690 V

Power Module		Power	Braking resistor
FSD	6SL3210-1PH21-4 . L0, 6SL3210-1PH22-0 . L0, 6SL3210-1PH22-3 . L0, 6SL3210-1PH22-7 . L0, 6SL3210-1PH23-5 . L0, 6SL3210-1PH24-2 . L0	11 kW ... 37 kW	JJY:023424020002
FSE	6SL3210-1PH25-2 . L0, 6SL3210-1PH26-2 . L0	45 kW ... 55 kW	JJY:023434020002
FSF	6SL3210-1PH28-0 . L0, 6SL3210-1PH31-0 . L0,	75 kW ... 90 kW	JJY:023464020002
	6SL3210-1PH31-2 . L0, 6SL3210-1PH31-4 . L0	110 kW ... 132 kW	JJY:023464020002
FSG	6SL3210-1PH31-7CL0, 6SL3210-1PH32-1CL0, 6SL3210-1PH32-5CL0	160 kW ... 250 kW	6SL3000-1BH32-5AA0

Braking resistors for PM240-2, 200 V ... 240 V

Power Module		Power	Braking resistor
FSA	6SL3210-1PB13-0 . L0, 6SL321 . -1PB13-8 . L0	0.55 kW ... 0.75 kW	JJY:023146720008
FSB	6SL3210-1PB15-5 . L0, 6SL3210-1PB17-4 . L0, 6SL321 . -1PB21-0 . L0	1.1 kW ... 2.2 kW	JJY:023151720007
FSC	6SL3210-1PB21-4 . L0, 6SL321 . -1PB21-8 . L0	3 kW ... 4 kW	JJY:02 3163720018
	6SL3210-1PC22-2 . L0, 6SL3210-1PC22-8 . L0	5.5 kW ... 7.5 kW	JJY:023433720001
FSD	6SL3210-1PC24-2UL0, 6SL3210-1PC25-4UL0, 6SL3210-1PC26-8UL0	11 kW ... 18.5 kW	JJY:023422620002
FSE	6SL3210-1PC28-0UL0, 6SL3210-1PC31-1UL0	22 kW ... 30 kW	JJY:023423320001
FSF	6SL3210-1PC31-3UL0, 6SL3210-1PC31-6UL0, 6SL3210-1PC31-8UL0	37 kW ... 55 kW	JJY:023434020003

3.5.8 Brake Relay



The Brake Relay has a switch contact (NO contact) for controlling a motor holding brake.

Article number: 6SL3252-0BB00-0AA0

The following Power Modules have a connection possibility for the Brake Relay:

- PM240-2
- PM240P-2
- PM250

3.5.9 Safe Brake Relay

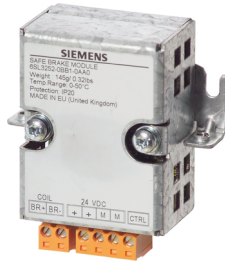

The Safe Brake Relay controls a 24 V motor brake and monitors the brake control for a short-circuit or interrupted cable.

Article number: 6SL3252-0BB01-0AA0

The following Power Modules have a connection possibility for the Brake Relay:

- PM240-2
- PM240P-2
- PM250

3.6 Motors and multi-motor drives that can be operated

Siemens motors that can be operated

You can connect standard induction motors to the inverter.

You can find information on further motors on the Internet:

 Motors that can be operated (<https://support.industry.siemens.com/cs/ww/en/view/100426622>)

Third-party motors that can be operated

You can operate standard asynchronous motors from other manufacturers with the inverter:

NOTICE
Insulation failure due to unsuitable third-party motor
A higher load occurs on the motor insulation in inverter mode than with line operation. Damage to the motor winding may occur as a result.
<ul style="list-style-type: none">• Please observed the notes in the System Manual "Requirements for third-party motors"

Further information is provided on the Internet:

 Requirements for third-party motors (<https://support.industry.siemens.com/cs/ww/en/view/79690594>)

Multi-motor operation

Multi-motor operation involves simultaneously operating several motors from one inverter. For standard induction motors, multi-motor operation is generally permissible.

Additional preconditions and restrictions relating to multi-motor operation are available on the Internet:



 Multi-motor drive (<http://support.automation.siemens.com/WW/view/en/84049346>)

3.7 Encoder and Sensor Module

You can connect the following encoders to the Control Unit:

- For the position or speed control
 - Resolver
 - HTL encoder
 - TTL encoder
 - Sine/cosine encoder
 - EnDat 2.1
- For the position control
 - SSI encoder

You require a Sensor Module to connect a non-DRIVE-CLiQ-capable encoder to the DRIVE-CLiQ interface of the inverter.

Sensor Module		Article number	Permissible encoders
	SMC10	6SL3055-0AA00-5AA3	Resolvers
	SMC20	6SL3055-0AA00-5BA3	sin/cos encoders, absolute encoders Endat 2.1, SSI encoders
	SMC30	6SL3055-0AA00-5CA2	HTL or TTL encoders, SSI encoders
	SME20	6SL3055-0AA00-5EA3	sin/cos encoder
	SME25	6SL3055-0AA00-5HA3	Absolute encoder Endat 2.1, SSI encoder

4.1 EMC-compliant installation of a machine or system

The inverter is designed for operation in industrial environments where strong electromagnetic fields are to be expected.

Reliable and disturbance-free operation is only guaranteed for EMC-compliant installation.

To achieve this, subdivide the control cabinet and the machine or system into EMC zones:

EMC zones

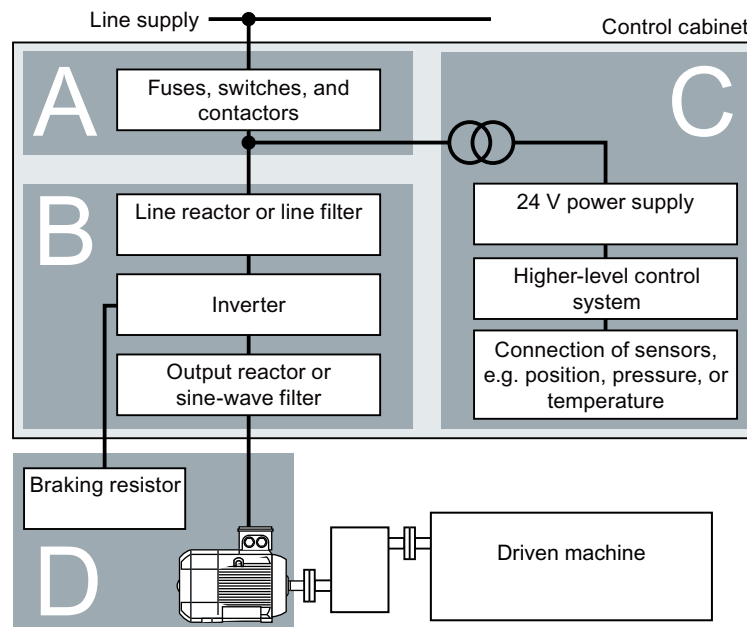

Figure 4-1 Example of the EMC zones of a plant or machine

Inside the control cabinet

- Zone A: Line supply connection
- Zone B: Power electronics
Devices in Zone B generate energy-rich electromagnetic fields.
- Zone C: Control and sensors
Devices in Zone C do not generate any energy-rich electromagnetic fields themselves, but their functions can be impaired by electromagnetic fields.

Outside the control cabinet

- Zone D: Motors, braking resistors
Devices in Zone D generate electromagnetic fields with a significant amount of energy

4.1.1 Control cabinet

- Assign the various devices to zones in the control cabinet.
- Electromagnetically uncouple the zones from each other by means of one of the following actions:
 - Side clearance ≥ 25 cm
 - Separate metal enclosure
 - Large-area partition plates
- Route cables of various zones in separate cable harnesses or cable ducts.
- Install filters or isolation amplifiers at the interfaces of the zones.

Control cabinet assembly

- Connect the door, side panels, top and base plate of the control cabinet with the control cabinet frame using one of the following methods:
 - Electrical contact surface of several cm^2 for each contact location
 - Several screw connections
 - Short, finely stranded, braided copper wires with cross-sections $\geq 95 \text{ mm}^2 / 000 (3/0) (-2) \text{ AWG}$
- Install a shield support for shielded cables that are routed out of the control cabinet.
- Connect the PE bar and the shield support to the control cabinet frame through a large surface area to establish a good electrical connection.
- Mount the control cabinet components on a bare metal mounting plate.
- Connect the mounting plate to the control cabinet frame and PE bar and shield support through a large surface area to establish a good electrical connection.
- For screw connections onto painted or anodized surfaces, establish a good conductive contact using one of the following methods:
 - Use special (serrated) contact washers that cut through the painted or anodized surface.
 - Remove the insulating coating at the contact locations.

Measures required for several control cabinets

- Install equipotential bonding for all control cabinets.
- Screw the frames of the control cabinets together at several locations through a large surface area using serrated washers to establish a good electrical connection.
- In plants and systems where the control cabinets are lined up next to one another, and which are installed in two groups back to back, connect the PE bars of the two cabinet groups at as many locations as possible.

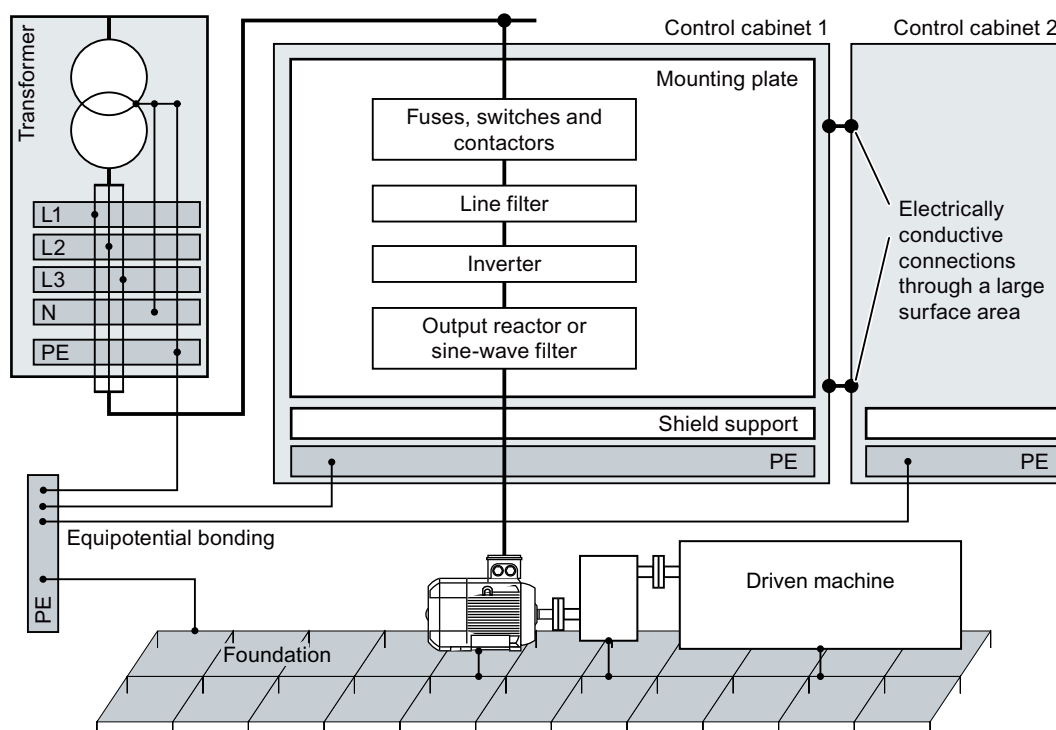

Figure 4-2 Grounding and high-frequency equipotential bonding measures in the control cabinet and in the plant/system

Further information

Additional information about EMC-compliant installation is available in the Internet:

 EMC installation guideline (<http://support.automation.siemens.com/WW/view/en/60612658>)

4.1.2 Cables

Cables with a high level of interference and cables with a low level of interference are connected to the inverter:

- Cables with a high level of interference:
 - Cable between the line filter and inverter
 - Motor cable
 - Cable at the inverter DC link connection
 - Cable between the inverter and braking resistor
- Cables with a low level of interference:
 - Cable between the line and line filter
 - Signal and data cables

Cable routing inside the cabinet

- Route the power cables with a high level of interference so that there is a minimum clearance of 25 cm to cables with a low level of interference.
If the minimum clearance of 25 cm is not possible, insert separating metal sheets between the cables with a high level of interference and cables with a low level of interference. Connect these separating metal sheets to the mounting plate to establish a good electrical connection.
- Cables with a high level of interference and cables with a low level of interference may only cross over at right angles:
- Keep all of the cables as short as possible.
- Route all of the cables close to the mounting plates or cabinet frames.
- Route signal and data cables - as well as the associated equipotential bonding cables - parallel and close to one another.
- Twist incoming and outgoing unshielded individual conductors. Alternatively, you can route incoming and outgoing conductors in parallel, but close to one another.
- Ground any unused conductors of signal and data cables at both ends.
- Signal and data cables must only enter the cabinet from one side, e.g. from below.
- Using shielded cables for the following connections:
 - Cable between the inverter and line filter
 - Cable between the inverter and output reactor or sine-wave filter

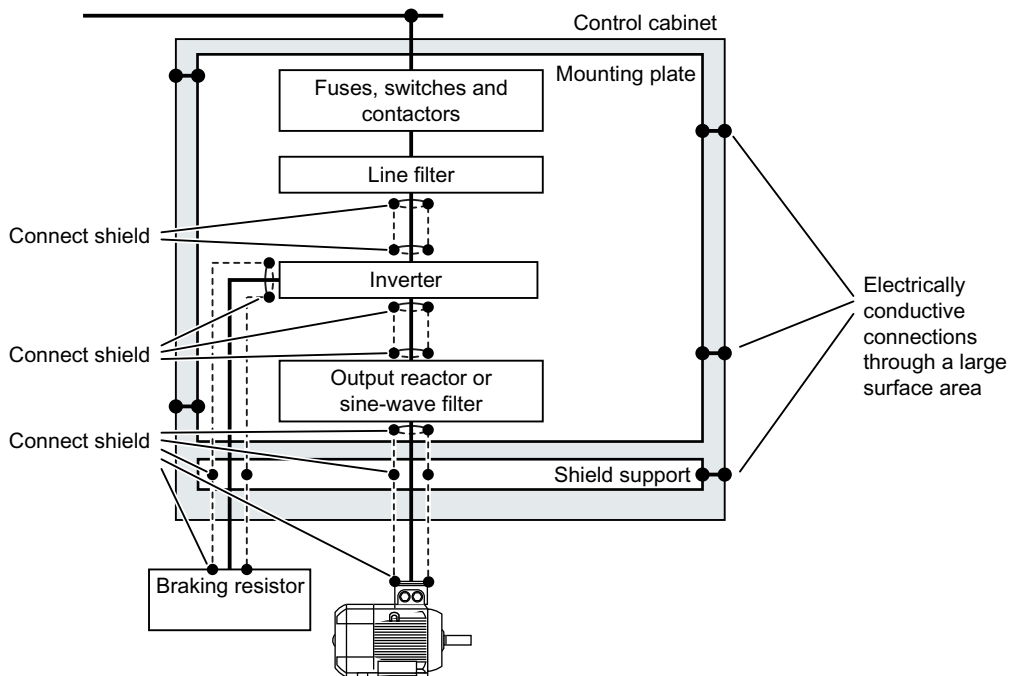

Figure 4-3 Routing inverter cables inside and outside a control cabinet

Routing cables outside the control cabinet

- Maintain a minimum clearance of 25 cm between cables with a high level of interference and cables with a low level of interference.
- Using shielded cables for the following connections:
 - Inverter motor cable
 - Cable between the inverter and braking resistor
 - Signal and data cables
- Connect the motor cable shield to the motor enclosure using a PG gland that establishes a good electrical connection.

Requirements relating to shielded cables

- Use cables with finely-stranded, braided shields.
- Connect the shield to at least one end of the cable.

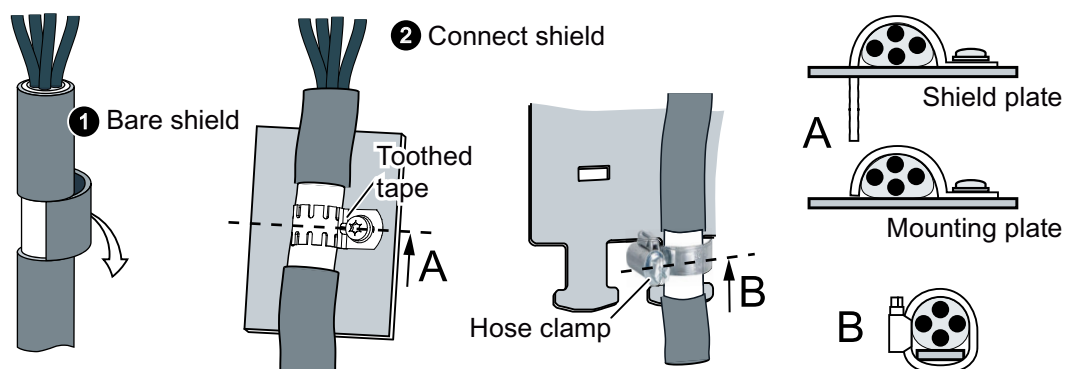

Figure 4-4 Examples for EMC-compliant shield support

- Attach the shield to the shield support directly after the cable enters the cabinet.
- Do not interrupt the shield.
- Only use metallic or metallized plug connectors for shielded data cables.

4.1.3 Electromechanical components

Surge voltage protection circuit

- Connect surge voltage protection circuits to the following components:
 - Coils of contactors
 - Relays
 - Solenoid valves
 - Motor holding brakes
- Connect the surge voltage protection circuit directly at the coil.
- Use RC elements or varistors for AC-operated coils and freewheeling diodes or varistors for DC-operated coils.

4.2 Installing reactors, filters and braking resistors

Installing reactors, filters and braking resistors

The following supplementary components may be required depending on the Power Modules and the particular application:

- Line reactors
- Filter
- Braking resistors
- Brake Relay

Installing these components is described in the documentation provided.

4.3 Installing Power Modules

4.3.1 Basic installation rules for built-in units

Protection against the spread of fire

The device may be operated only in closed housings or in control cabinets with protective covers that are closed, and when all of the protective devices are used. The installation of the device in a metal control cabinet or the protection with another equivalent measure must prevent the spread of fire and emissions outside the control cabinet.

Protection against condensation or electrically conductive contamination

Protect the device, e.g. by installing it in a control cabinet with degree of protection IP54 according to IEC 60529 or NEMA 12. Further measures may be necessary for particularly critical operating conditions.

If condensation or conductive pollution can be excluded at the installation site, a lower degree of control cabinet protection may be permitted.

Installing

NOTICE
Overheating due to inadmissible mounting
If mounted in an inadmissible fashion, the Power Module can overheat and therefore be damaged.
<ul style="list-style-type: none">• Follow the mounting instructions.

Rules for admissible mounting:

- Only mount the Power Module in a vertical position with the motor connectors at the bottom.

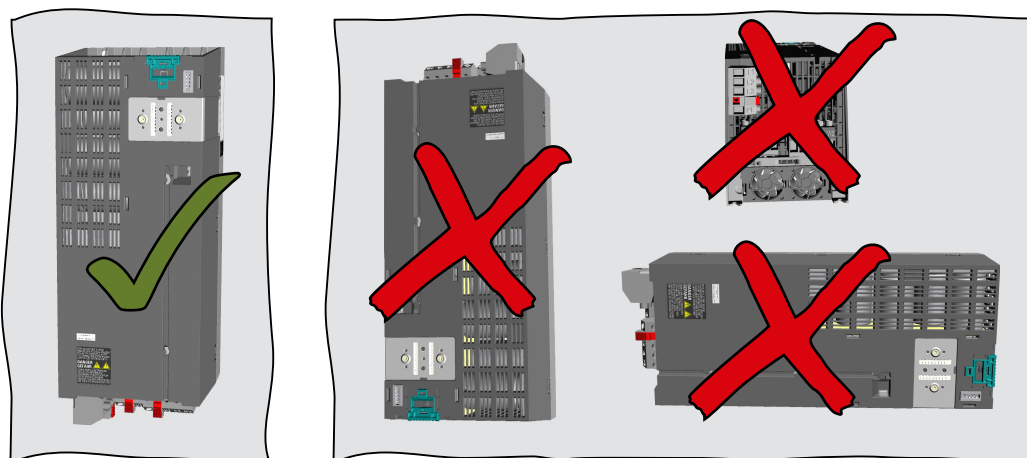

- Maintain the minimum clearances to other components.
- Use the specified installation parts and components.
- Comply with the specified torques.

4.3.2 Dimensioned drawings, drilling dimensions for the PM240-2 Power Module, IP20

The following dimension drawings and drilling patterns are not to scale.

Frame sizes FSA ... FSC

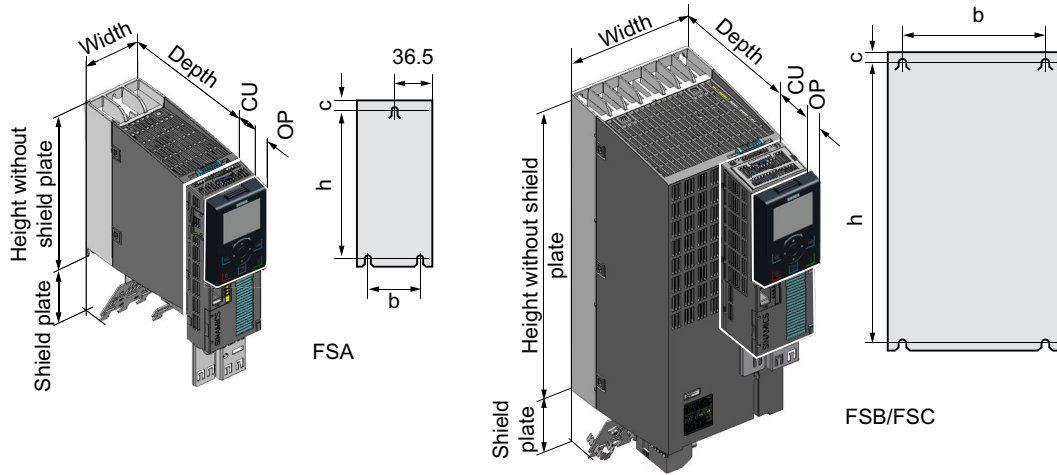

Table 4-1 Dimensions depend on the operator panel (OP) that is inserted

Frame size	Width [mm]	Height [mm]		Mounting depth in the cabinet with Control Unit (CU) [mm] ²⁾	
		without shield plate	with shield plate	without OP	with OP ¹⁾
FSA	73	196	276	227	238
FSB	100	292	370	227	238
FSC	140	355	432	227	238

1) BOP-2, IOP-2 or blanking cover

2) Power Module depth without Control Unit: 165 mm

Table 4-2 Drilling dimensions, cooling clearances and fixing

Frame size	Drilling dimensions [mm]			Cooling air clearances [mm] ¹⁾			Fixing/torque [Nm]
	h	b	c	Top	Bottom	Front	
FSA	186	62.3	6	80	100	100	3 x M4 / 2.5
FSB	281	80	6	80	100	100	4 x M4 / 2.5
FSC	343	120	6	80	100	100	4 x M5 / 3.5

1) The Power Module is designed for mounting without any lateral cooling air clearance. For tolerance reasons, we recommend a lateral clearance of approx. 1 mm.

Frame sizes FSD ... FSF

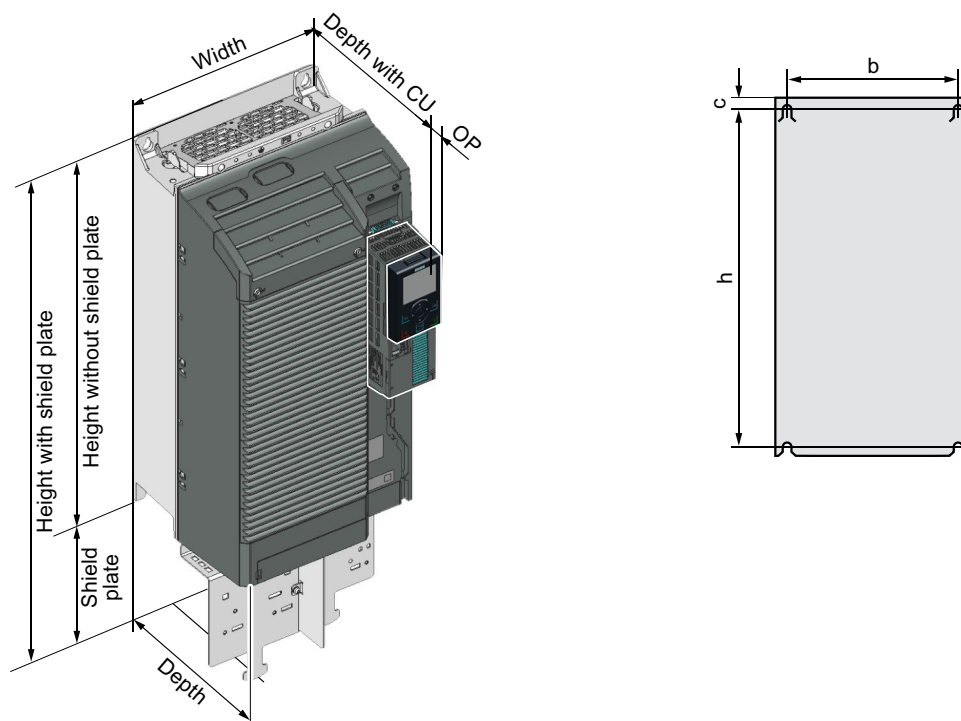
Table 4-3 Dimensions depend on the operator panel (OP) that is inserted ¹⁾

Frame size	Width [mm]	Height [mm]		Mounting depth in the cabinet with Control Unit (CU) [mm] ²⁾	
		without shield plate	with shield plate	without OP	with OP ¹⁾
FSD	200	472	624	256	267
FSE	275	551	728	256	267
FSF	305	709	965	376	387
FSG	305	1000	1286	376	387

¹⁾ BOP-2, IOP-2 or blanking cover

²⁾ Power Module depth without Control Unit: FSD, FSE 237 mm, FSF 357 mm, FSG 358 mm

Table 4-4 Drilling dimensions, cooling clearances and fixing

Frame size	Drilling dimensions [mm]			Cooling air clearances [mm] ¹⁾			Fixing/torque [Nm]
	h	b	c	Top ²⁾	Bottom ²⁾	Front	
FSD	430	170	7	300	350	100	4 x M5 / 6.0
FSE	509	230	8.5	300	350	100	4 x M6 / 10

4.3 Installing Power Modules

Frame size	Drilling dimensions [mm]			Cooling air clearances [mm] ¹⁾			Fixing/torque [Nm]
	h	b	c	Top ²⁾	Bottom ²⁾	Front	
FSF	680	270	13	300	350	100	4 x M8 / 25
FSG	970.5	265	15	300	350	100	4 x M8 / 25

1) The Power Module is designed for mounting without any lateral cooling air clearance. For tolerance reasons, we recommend a lateral clearance of approx. 1 mm.

2) The top and bottom cooling air clearances refer to the Power Module without shield plate

4.3.3 Dimension drawings, drilling dimensions for PM240-2 Power Modules in push-through technology

The following dimension drawings and drilling patterns are not to scale.

Frame sizes FSA ... FSC

Panel thickness of the control cabinet ≤ 3.5 mm

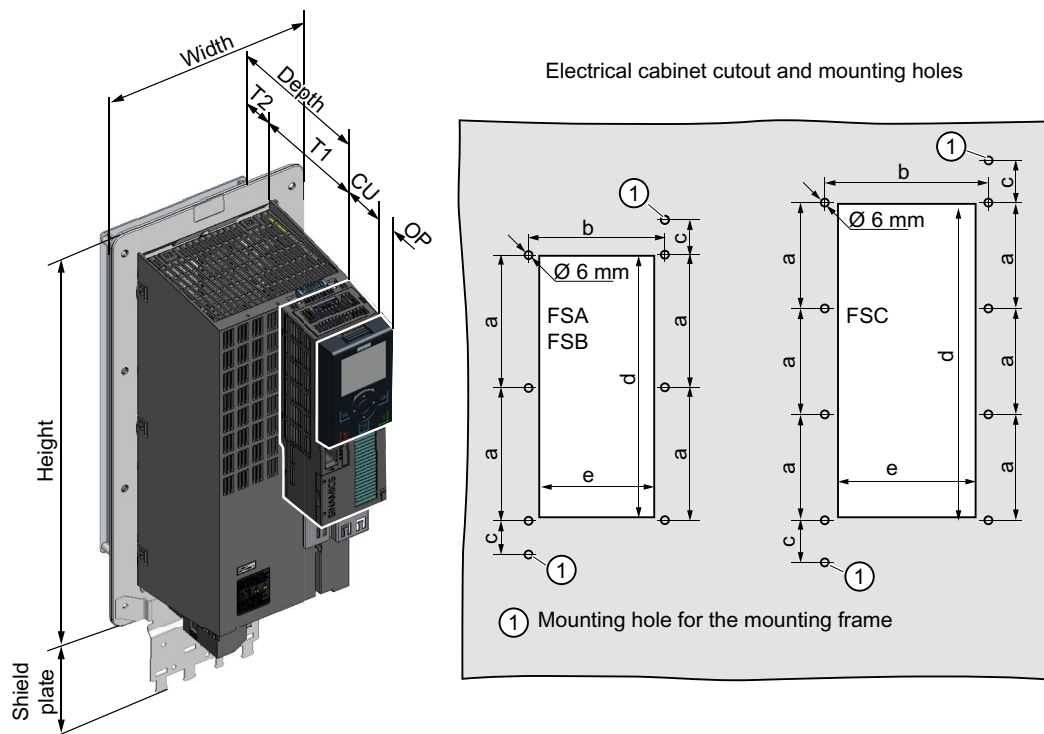

Figure 4-5 Dimension drawing and drilling dimensions for frame sizes FSA ... FSC

Table 4-5 Dimensions depend on the operator panel (OP) that is inserted

Frame size	Width [mm]	Height [mm]		Mounting depth in the cabinet with Control Unit (CU) [mm]	
		without shield plate	with shield plate	without OP	with OP ¹⁾
FSA	126	238	322	180	191
FSB	154	345	430	180	191
FSC	200	411	500	180	191

¹⁾ BOP-2, IOP-2 or blanking cover

4.3 Installing Power Modules

Table 4-6 Cooling air clearances and additional dimensions

Frame size	Power Module depth [mm]	T1	T2	Cooling air clearances [mm] ¹⁾		
				Top	Bottom	Front
FSA ... FSC	171	118	53	80	100	100

¹⁾ The Power Module is designed for mounting without any lateral cooling air clearance. For tolerance reasons, we recommend a lateral clearance of 1 mm.

Table 4-7 Electrical cabinet cutout and mounting holes

Frame size	Control cabinet cutout [mm]					Fixing/torque [Nm]
	a	b	c	d	e	
FSA	103	106	27	198	88	8 × M5 / 3.5
FSB	148	134	34.5	304	116	8 × M5 / 3.5
FSC	123	174	30.5	365	156	10 × M5 / 3.5

Frame sizes FSD ... FSF

Panel thickness of the control cabinet ≤ 3.5 mm

Cutouts of the control cabinet and mounting holes

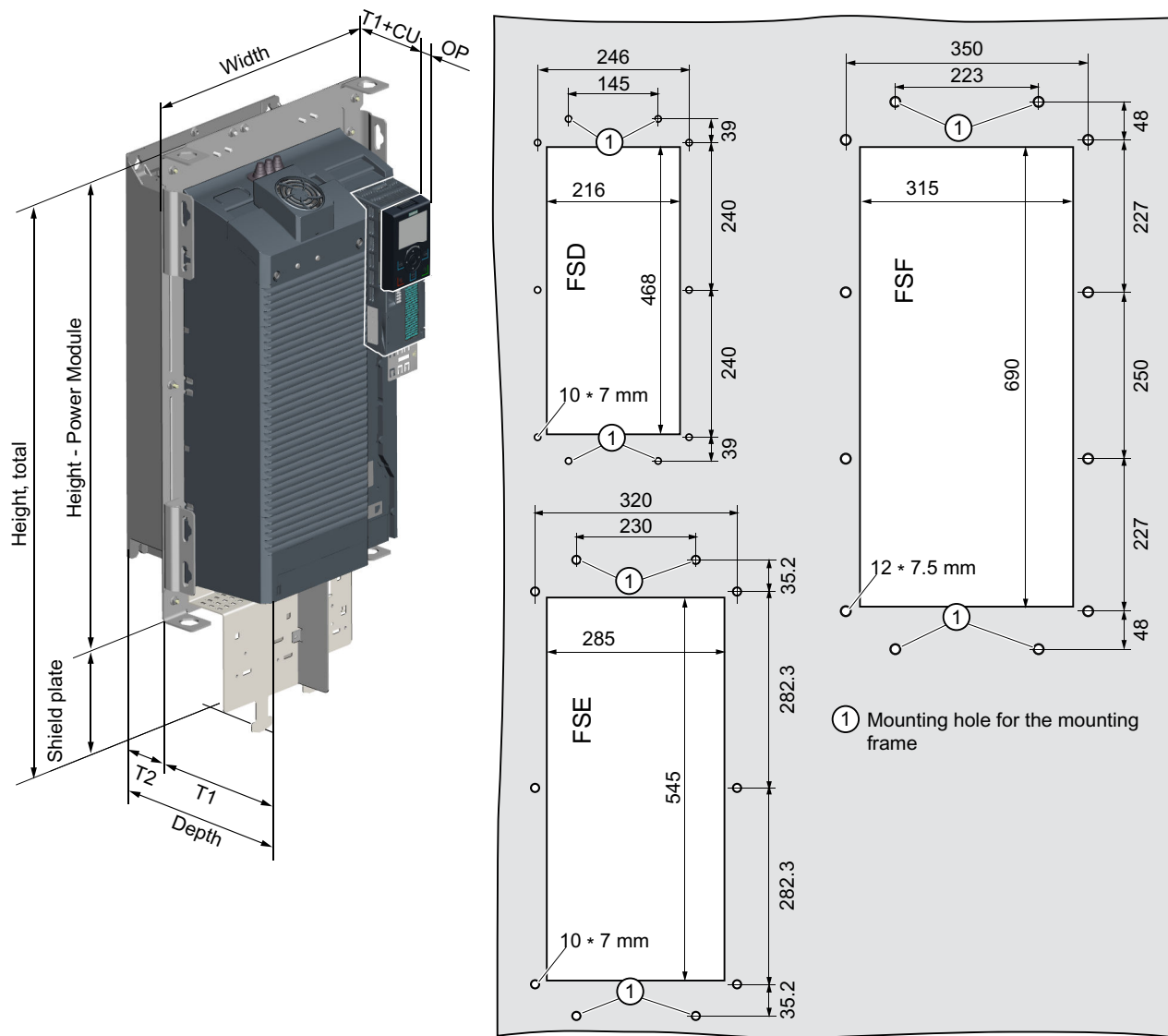

Figure 4-6 Dimension drawing and drilling dimensions for frame sizes FSD ... FSF

4.3 Installing Power Modules

Table 4-8 Dimensions depend on the operator panel (OP) that is inserted ¹⁾

Frame size	Width [mm]	Height [mm]		Mounting depth in the cabinet with Control Unit (CU) [mm]	
		without shield plate	with shield plate	without OP	with OP ¹⁾
FSD	275	517	650	158	169
FSE	354	615	722	158	169
FSF	384	754	1021	196	207

¹⁾ BOP-2, IOP-2 or blanking cover

Table 4-9 Cooling air clearances and additional dimensions

Frame size	Power Module depth [mm]	T1	T2	Cooling air clearances [mm]		
				Top	Bottom	Front
FSD, FSE	237	141	97.5	350	350	29
FSF	358	177.5	180.5	80	100	100

Table 4-10 Mounting

Frame size	Fixing/torque [Nm]
FSD, FSE	10 × M5 / 3.5
FSF	12 × M6 / 5.9

4.3.4 Dimensioned drawings, drilling dimensions for the PM250 Power Module

The following dimension drawings and drilling patterns are not to scale.

Frame size FSC

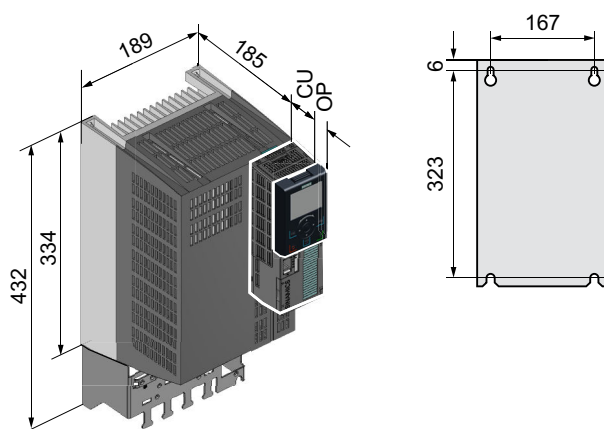

Table 4-11 Dimensions depend on the operator panel (OP) that is inserted

Frame size	Mounting depth in the cabinet with Control Unit (CU) [mm]	
	without OP	with OP ¹⁾
FSC	227	238

¹⁾ BOP-2, IOP-2 or blanking cover

Table 4-12 Cooling air clearances and fastening

Frame size	Cooling air clearances [mm] ¹⁾			Fixing/torque [Nm]
	Top	Bottom	Front	
FSC	125	125	65	4 x M5 / 3

¹⁾ You can mount the Power Modules without any lateral cooling air clearance. For tolerance reasons, we recommend a lateral clearance of approx. 1 mm.

Frame sizes FSD ... FSF

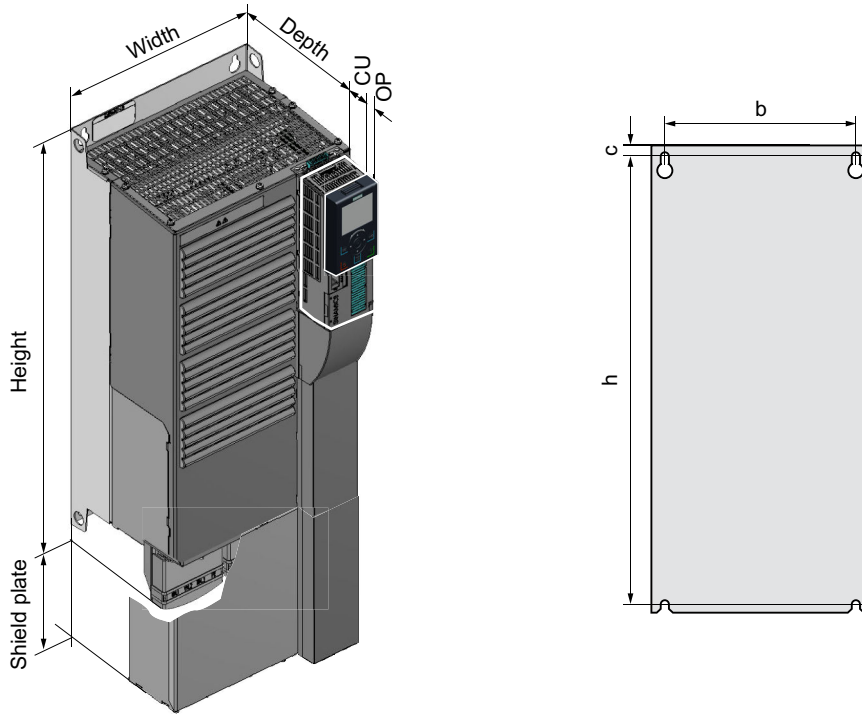

Table 4-13 Dimensions depend on the operator panel (OP) that is inserted ¹⁾

Frame size	Width [mm]	Height [mm]		Mounting depth in the cabinet with Control Unit (CU) [mm] ²⁾	
		without shield plate	with shield plate	without OP	with OP ¹⁾
FSD without filter	275	419	542	266	277
FSD with filter	275	512	635	266	277
FSE without filter	275	499	622	266	277
FSE with filter	275	635	758	266	277
FSF without filter	350	634	792	378	389
FSF with filter	350	934	1092	378	389

¹⁾ BOP-2, IOP-2 or blanking cover

²⁾ Power Module depth without Control Unit: FSD, FSE 204 mm, FSF 316 mm

Table 4-14 Drilling dimensions, cooling clearances and fixing

Frame size	Drilling dimensions [mm]			Cooling air clearances [mm] ¹⁾			Fixing/torque [Nm]
	b	h	c	Top	Bottom	Front	
FSD without filter	235	325	11	300	300	65	4 x M6 / 6
FSD with filter	235	419	11	300	300	65	4 x M6 / 6
FSE without filter	235	405	11	300	300	65	4 x M6 / 6
FSE with filter	235	541	11	300	300	65	4 x M6 / 6
FSF without filter	300	598	11	350	350	65	4 x M8 / 13
FSF with filter	300	898	11	350	350	65	4 x M8 / 13

¹⁾ You can mount the Power Modules without any lateral cooling air clearance. For tolerance reasons, we recommend a lateral clearance of approx. 1 mm.

4.4 Connecting the line supply and motor



⚠ WARNING

Electric shock when the motor terminal box is open

As soon as the inverter is connected to the line supply, the motor connections of the inverter may carry dangerous voltages. When the motor is connected to the inverter, there is danger to life through contact with the motor terminals if the motor terminal box is open.

- Close the motor terminal box before connecting the inverter to the line supply.

Note

Fault protection for the motor circuit

The electronic overcurrent trip complies with the requirements laid down in IEC 60364-3-2:2005/AMD1:- Section 411 for protection against electric shock.

- Observe the installation specifications provided in this manual.
- Observe the applicable installation standards.
- Ensure the continuity of the protective conductor.

4.4.1 Permissible line supplies

Restrictions for installation altitudes above 2000 m

Above an installation altitude of 2000 m, the permissible line supplies are restricted.



Restrictions for special ambient conditions (Page 478)

Screw for functional grounding on the converter, frame size FSG

If you wish to use the inverters with integrated C3 line filter, please note the information in the sections "TN line system", "TT line system" and "IT system" below.

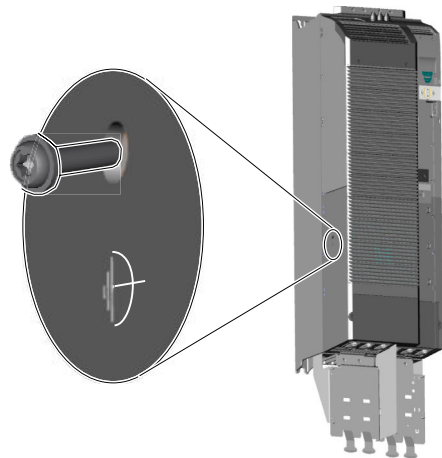

Figure 4-7 Remove screw for functional grounding

4.4.1.1 TN line system

A TN line system transfers the PE protective conductor to the installed plant or system using a cable.

Generally, in a TN line system the neutral point is grounded. There are versions of a TN system with a grounded line conductor, e.g. with grounded L1.

A TN line system can transfer the neutral conductor N and the PE protective conductor either separately or combined.

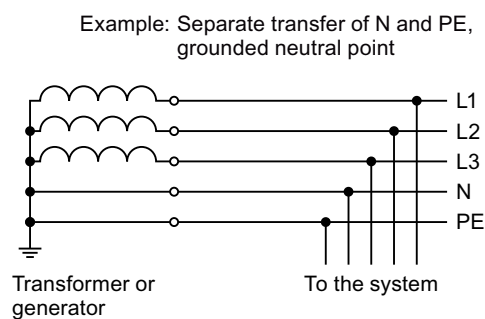

Inverter connected to a TN system

- Inverters with integrated line filter:
 - Operation on TN line systems with grounded neutral point permissible.
 - Operation on TN line systems with grounded line conductor not permissible.
-

Note

Special feature of FSG inverters

FSG inverters with integrated C3 line filter can be operated in TN line systems ≤ 600 V with a grounded line conductor if you remove the screw for functional grounding.

 Figure 4-7 Remove screw for functional grounding (Page 73)

If you remove the screw for functional grounding, the EMC properties deteriorate and the requirements of Class C3 are no longer met.

- Inverters with external line filter:
 - Operation on TN line systems with grounded neutral point permissible.
 - Operation on TN line systems with grounded line conductor not permissible.
- Inverter without line filter:
 - Operation on all TN line systems ≤ 600 V permissible
 - Operation on TN line systems > 600 V and grounded neutral point permissible.
 - Operation on TN line systems > 600 V and grounded line conductor not permissible.

4.4.1.2 TT line system

In a TT line system, the transformer grounding and the installation grounding are independent of one another.

There are TT line supplies where the neutral conductor N is either transferred – or not.

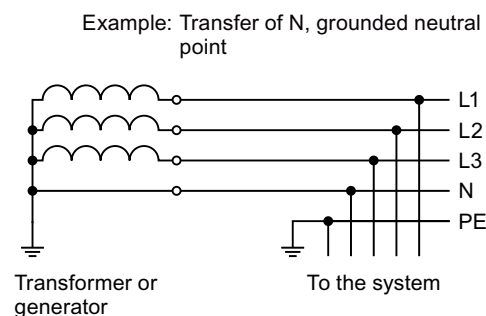

Note

Operation in IEC or UL systems

For installations in compliance with IEC, operation on TT line systems is permissible. For installations in compliance with UL, operation on TT line systems is not permissible.

Inverter connected to a TT system

- Inverters with integrated line filter:
 - Operation on TT line systems with grounded neutral point permissible.
 - Operation on TT line systems without grounded neutral point not permissible.

Note

Special feature of FSG inverters

FSG inverters with integrated C3 line filter can be operated in TT line systems without a grounded neutral point if you remove the screw for functional grounding.

 Figure 4-7 Remove screw for functional grounding (Page 73)

If you remove the screw for functional grounding, the EMC properties deteriorate and the requirements of Class C3 are no longer met.

- Inverters with external line filter:
 - Operation on TT line systems with grounded neutral point permissible.
 - Operation on TT line systems without grounded neutral point not permissible.
- Inverter without line filter:
 - Operation on all TT line systems permissible.

4.4.1.3 IT system

In an IT line system, all of the conductors are insulated with respect to the PE protective conductor – or connected to the PE protective conductor through an impedance. There are IT systems with and without transfer of the neutral conductor N.

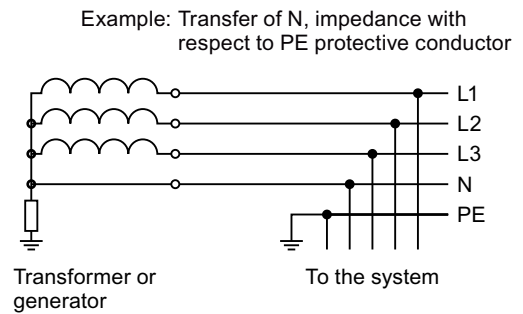

Note

Behavior of the inverter when a ground fault occurs

If the inverter is to remain operable even when a ground fault occurs at the inverter output, you must install an output reactor. This prevents an overcurrent trip or damage to the drive.

Inverter connected to an IT system

- Inverters with integrated line filter:
 - Operation on IT line systems not permissible.

Note

Special feature of FSG inverters

FSG inverters with integrated C3 line filter can be operated in IT line systems if you remove the screw for functional grounding.

 Figure 4-7 Remove screw for functional grounding (Page 73)

If you remove the screw for functional grounding, the EMC properties deteriorate and the requirements of Class C3 are no longer met.

- Inverter without line filter:
 - Operation on all IT line systems permissible.

Note

690 V inverters: Output reactors for frame sizes FSD and FSE

An output reactor is required for 690 V reactors in frame sizes FSD and FSE.

4.4.2 Protective conductor



⚠ WARNING

Electric shock due to interrupted protective conductor

The drive components conduct a high leakage current via the protective conductor. Touching conductive parts when the protective conductor is interrupted can result in death or serious injury.

- Dimension the protective conductor as stipulated in the appropriate regulations.

Dimensioning the protective conductor

Observe the local regulations for protective conductors subject to an increased leakage current at the site of operation.

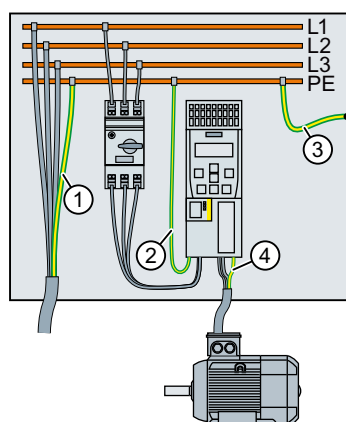

- ① Protective conductor for line feeder cables
- ② Protective conductor for inverter line feeder cables
- ③ Protective conductor between PE and the control cabinet
- ④ Protective conductor for motor feeder cables

The minimum cross-section of the protective conductor ① ... ④ depends on the cross-section of the line or motor feeder cable:

- Line or motor feeder cable $\leq 16 \text{ mm}^2$
 \Rightarrow Minimum cross-section of the protective conductor = cross-section of the line or motor feeder cable
- $16 \text{ mm}^2 < \text{line or motor feeder cable} \leq 35 \text{ mm}^2$
 \Rightarrow Minimum cross-section of the protective conductor = 16 mm^2
- Line or motor feeder cable $> 35 \text{ mm}^2$
 \Rightarrow Minimum cross-section of the protective conductor = $\frac{1}{2}$ cross-section of the line or motor feeder cable

Additional requirements placed on the protective conductor ①:

- For permanent connection, the protective conductor must fulfill at least one of the following conditions:
 - The protective conductor is routed so that it is protected against damage along its complete length.
Cables routed inside switch cabinets or enclosed machine housings are considered to be adequately protected against mechanical damage.
 - As a conductor of a multi-conductor cable, the protective conductor has a cross-section $\geq 2.5 \text{ mm}^2 \text{ Cu}$.
 - For an individual conductor, the protective conductor has a cross-section $\geq 10 \text{ mm}^2 \text{ Cu}$.
 - The protective conductor consists of two individual conductors with the same cross-section.
- When connecting a multi-core cable using an industrial plug connector according to EN 60309, the protective conductor must have a cross-section of $\geq 2.5 \text{ mm}^2 \text{ Cu}$.

4.4.3 Connecting an inverter with the PM240-2 Power Module

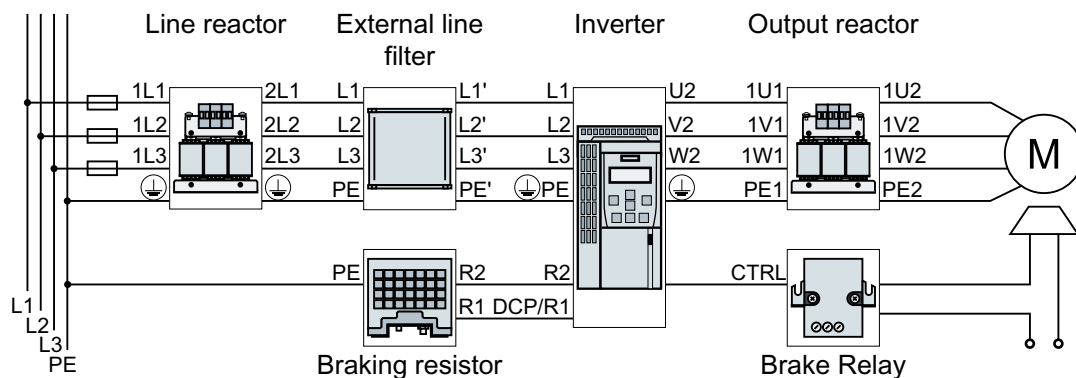

Figure 4-8 Connection of the PM240-2 Power Module, 3 AC, FSA ... FSC

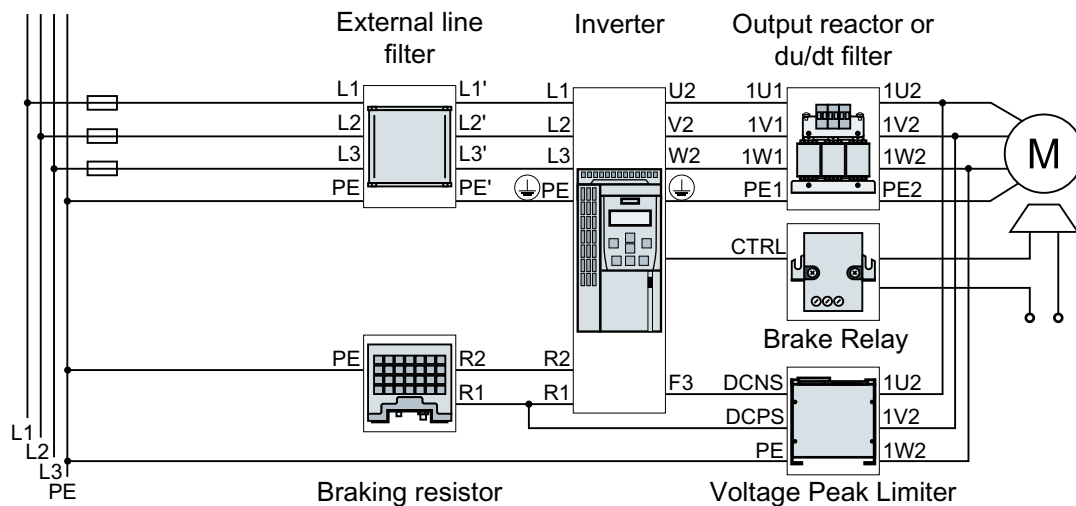

Figure 4-9 Connection of the PM240-2 Power Module, 3 AC, FSD ... FSF

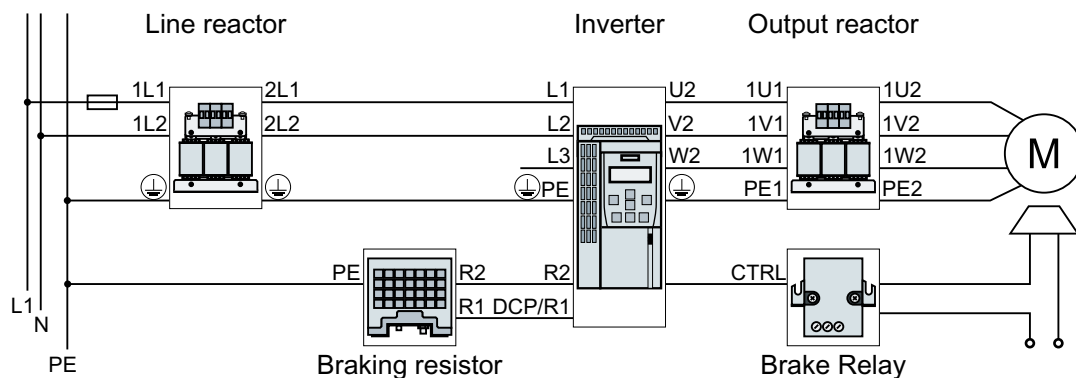

Figure 4-10 Connection of the PM240-2 Power Module, 1 AC 200 V, FSA ... FSC

4.4 Connecting the line supply and motor

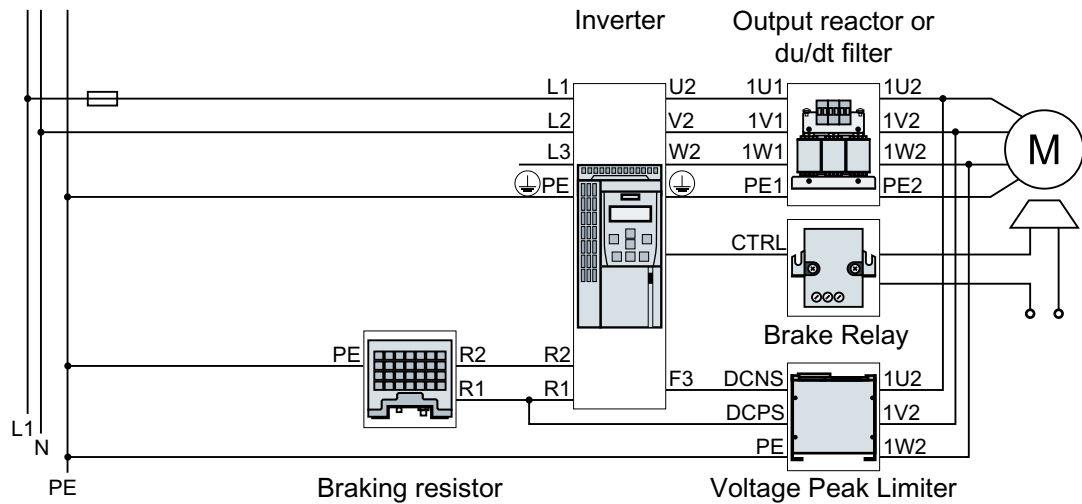



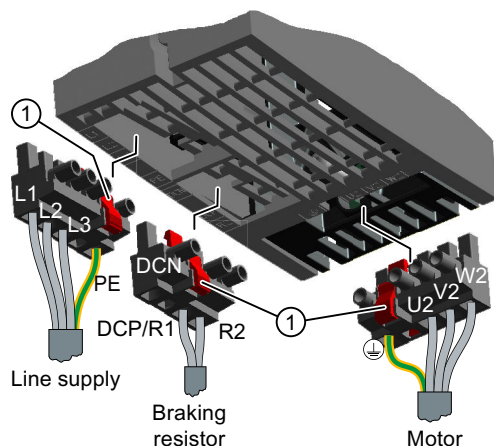

Figure 4-11 Connection of the PM240-2 Power Module, 1 AC 200 V, FSD ... FSF

Table 4-15 Connection, cross-section and tightening torque for PM240-2 Power Modules

Inverter	Connection		Cross-section, tightening torque		Stripped insulation length
			Metric	Imperial	
FSA	Line system, motor and braking resistor		1.5 ... 2.5 mm ² , 0.5 Nm	16 ... 14 AWG, 4.5 lbf in	8 mm
FSB			1.5 ... 6 mm ² , 0.6 Nm	16 ... 10 AWG, 5.5 lbf in	8 mm
FSC			6 ... 16 mm ² , 1.3 Nm	10 ... 6 AWG, 12 lbf in	10 mm
FSD	Line and motor	Screw-type terminal	10 ... 35 mm ² , 2.5 ... 4.5 Nm	8 ... 2 AWG, 22 ... 40 lbf in	18 mm
	Braking resistor		2.5 ... 16 mm ² , 1.2 ... 1.5 Nm	20 ... 6 AWG, 10.5 ... 13 lbf in	10 mm
FSE	Line and motor	Screw-type terminal	25 ... 70 mm ² , 8 ... 10 Nm	6 ... 3/0 AWG, 71 ... 88.5 lbf in	25 mm
	Braking resistor		10 ... 35 mm ² , 2.5 ... 4.5 Nm	8 ... 2 AWG, 22 ... 40 lbf in	18 mm
FSF	Line and motor	 Cable lug according to SN71322 for M10 bolts	35 ... 2 × 120 mm ² , 22 ... 25 Nm	1 AWG ... 2 × 4/0 AWG, 195 ... 221 lbf.in	--
	Braking resistor	Screw-type terminal	25 ... 70 mm ² , 8 ... 10 Nm	6 ... 3/0 AWG, 71 ... 88.5 lbf in	25 mm
FSG	Line and motor	 Cable lug according to SN71322 for M10 bolts	35 ... 2 × 185 mm ² , 22 ... 25 Nm	1 AWG ... 2 × 350 MCM, 195 ... 221 lbf.in	--
	Braking resistor	Screw-type terminal	25 ... 70 mm ² , ... 10 Nm	6 ... 3/0 AWG, 71 ... 88.5 lbf in	25 mm

Connections for frame sizes FSA ... FSC



The Power Modules are equipped with withdrawable plug connectors that cannot be inadvertently interchanged.

To remove a plug connector, you must release it by pressing on the red lever.

- ① Release lever

Connections for frame sizes FSD ... FSG

You must remove the covers from the connections in order to connect the line supply, braking resistor and motor to the inverter.

In addition, for frame sizes FSD and FSE, release the two terminal screws on the connections for the motor and braking resistor, and remove the dummy plug.

For frame sizes FSF and FSG, you must breakout the openings from the connection cover for the power connections. Use side cutters or a fine saw blade.

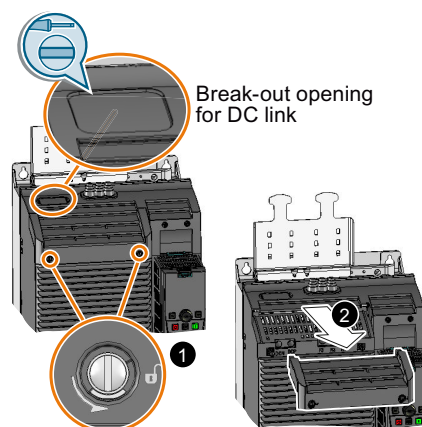

FSD ... FSG: Remove the top covers

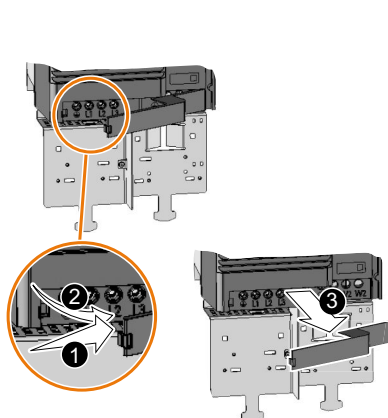

FSD, FSE: Remove the lower cover

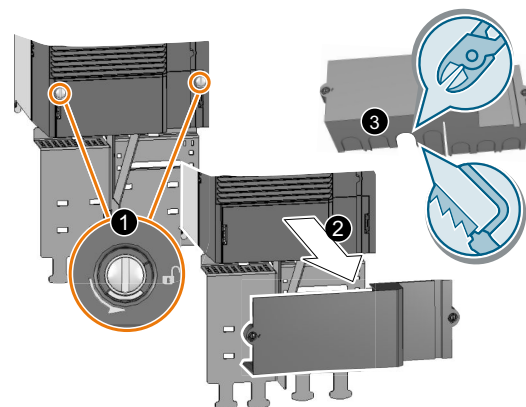

FSF, FSG: Remove the lower cover

4.4 Connecting the line supply and motor

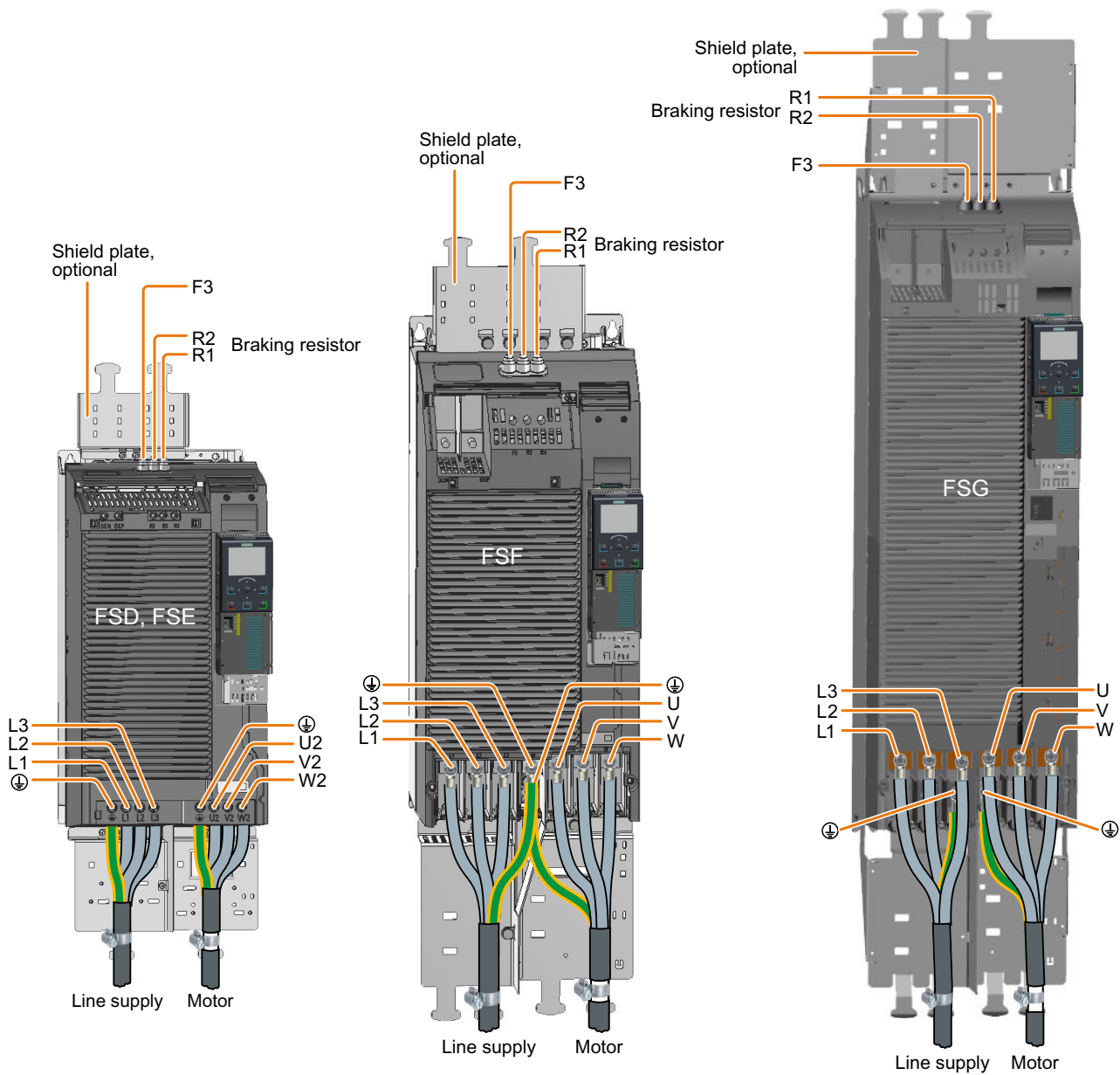

Figure 4-12 Connections for the line supply, motor and braking resistor

You must re-attach the connection covers in order to re-establish the touch protection of the inverter after it has been connected up.

Additional information when connecting FSG inverters

Note

Conductor cross-section 240 mm²

Cable lugs for M10 bolts according to SN71322 are suitable for cables with cross-sections of 35 mm² ... 185 mm² (1 AWG ... 2 × 350 MCM).

If you wish to establish connections with cables of 240 mm² (500 MCM), you must use narrow cable lugs, e.g. Klauke 12SG10. Other cable lugs are not suitable due to the narrow design of the inverter.

The maximum permissible width of the cable lugs is 37 mm (1.45 inches).

Remove the plastic insulating plate as shown below to gain better access to the terminals for the power connections.

WARNING

Damage to inverter as a result of operation without insulating plates

Without the insulating plates, voltage flashovers may occur between the phases.

- Replace the insulating plates after connecting the cables.

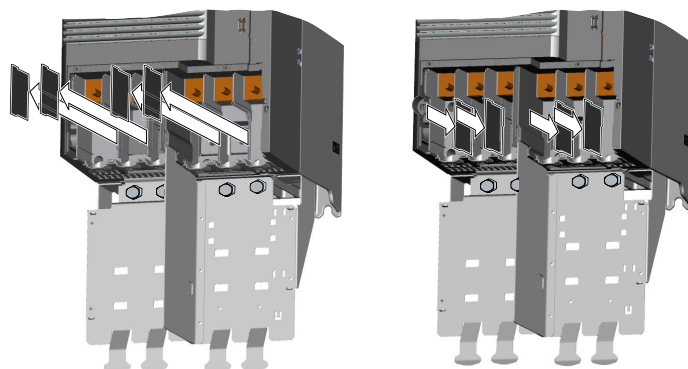

4.4.4 Connecting the inverter with the PM250 Power Module

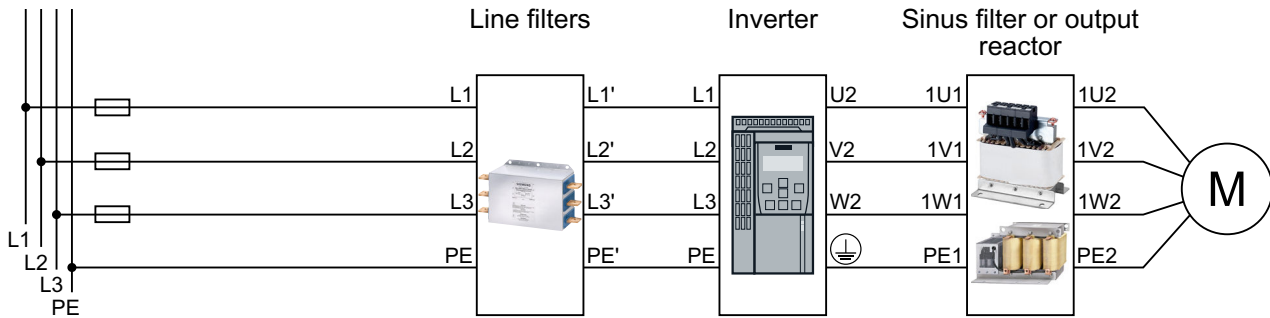

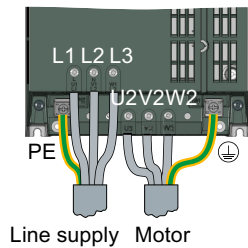

Figure 4-13 Connecting the PM250 Power Module

Table 4-16 Connection, cross-section and tightening torque for PM250 Power Modules

Inverter	Line supply and motor connection	Cross-section and tightening torque		Stripped insulation length
		Metric	Imperial	
FSC	Screw-type terminal	4 ... 10 mm ² , 2.3 Nm	12 ... 8 AWG, 20 lbf in	10 mm
FSD	 Cable lug	10 ... 35 mm ² , 6 Nm	7 ... 2 AWG, 53 lbf in	--
FSE		25 ... 50 mm ² , 6 Nm	3 ... 1 AWG, 53 lbf in	--
FSF		35 ... 120 mm ² , 13 Nm	2 ... 4/0 AWG, 115 lbf in	--

Connections for frame size FSC



Connections for frame sizes FSD ... FSF

The line and motor connections have covers to prevent them from being touched.

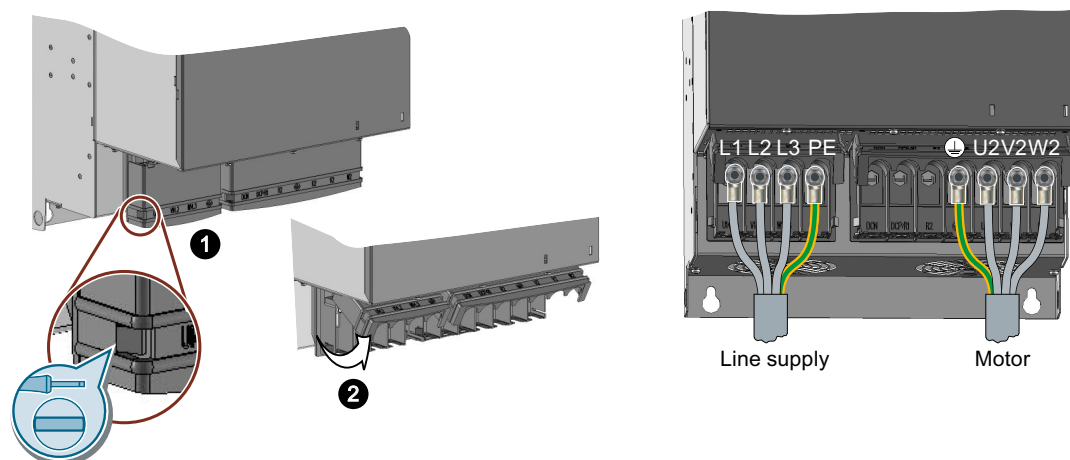

You must open the cover to connect the line and motor:

1. Release the catches on both sides of the covers using a screwdriver.
2. Swivel the covers upwards.

Close the covers once you have connected the line and motor.

4.4.5 Connecting the motor to the inverter in a star or delta connection

Standard induction motors with a rated power of approximately ≤ 3 kW are normally connected in a star/delta connection (Y/ Δ) at 400 V/230 V. For a 400-V line supply, you can connect the motor to the inverter either in a star or in a delta connection.

Operating the motor in a star connection

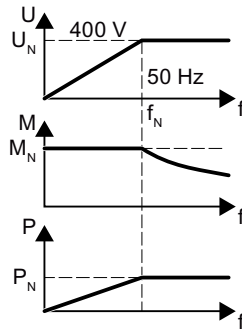
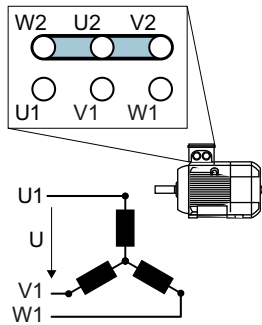

In a star connection, the motor can provide its rated torque M_N in the range 0 ... rated frequency f_N .

Rated voltage $U_N = 400$ V is available at a rated frequency $f_N = 50$ Hz.

The motor goes into field weakening above the rated frequency. In field weakening, the available motor torque decreases linearly with $1/f$. In field weakening, the available power remains constant.

Operating the motor in a delta connection with 87 Hz characteristic

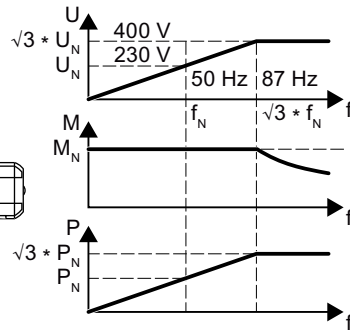
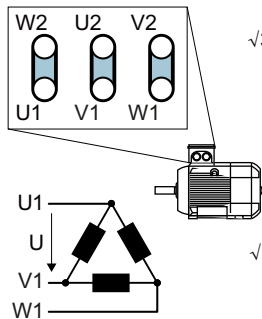

In a delta connection, the motor is operated with a voltage and frequency above its rated values. As a consequence, the motor power is increased by a factor $\sqrt{3} \approx 1.73$.

In the range $f = 0 \dots 87$ Hz, the motor can output its rated torque M_N .

The maximum voltage $U = 400$ V is available at a frequency of $f = \sqrt{3} \times 50$ Hz ≈ 87 Hz.

The motor only goes into field weakening above 87 Hz.

The higher motor power when operated with an 87 Hz characteristic has the following disadvantages:

- The inverter must supply approximately 1.73x current. Select an inverter based on its rated current - and not its rated power.
- The motor temperature increases more significantly than when operated with $f \leq 50$ Hz.
- The motor must have windings that are approved for a voltage $>$ rated voltage U_N .
- As the fan impeller rotates faster, the motor has a higher noise level than operation with $f \leq 50$ Hz.

4.4.6 Connecting a motor holding brake

The inverter uses the Brake Relay to control the motor holding brake. Two types of Brake Relay exist:

- The Brake Relay controls the motor holding brake
- The Safe Brake Relay controls a 24 V motor holding brake and monitors the brake control for short-circuit or cable breakage.

Note

Brake Relay and Safe Brake Relay

The Brake Relay and the Safe Brake Relay do not differ from each other in the installation and the connection to the inverter.

Connection to the inverter

To ensure that you have the correct cable for connecting the Brake Relay irrespective of the inverter size, you are supplied with two preassembled cables with different lengths. Connect the appropriate cable to the Brake Module and to the inverter as shown below.

If you are using your own cable, ensure that the cable is insulated and rated for 600 V.

Connecting the motor holding brake via a PELV circuit

The Brake Relay must be connected to the protective conductor if the motor brake is supplied from a PELV circuit.

Brake Relay

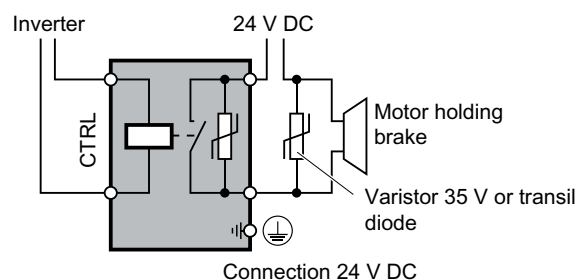
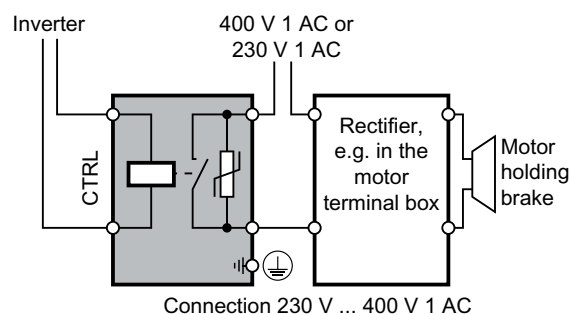
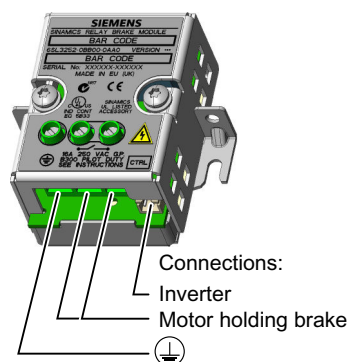

Safe Brake Relay

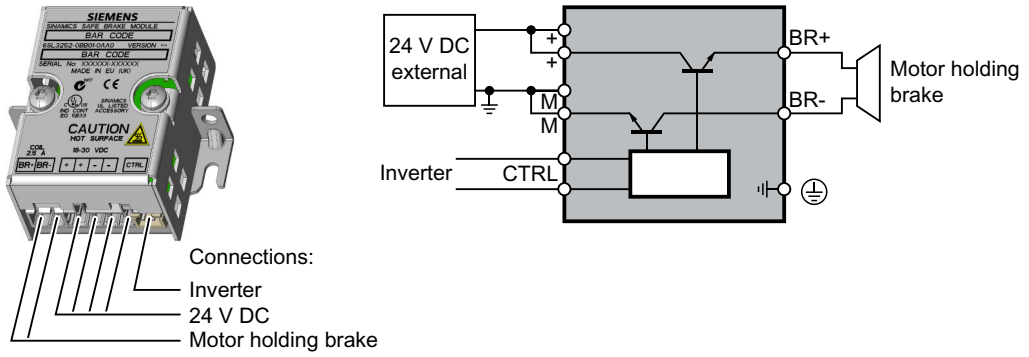

4.4.6.1 Installing a Brake Relay - PM250 Power Module

Installing the Brake Relay

If you use the optional shield plate, install the Brake Relay on the shield plate of the Power Module.

If you do not use the shield plate, install the Brake Relay as close as possible to the Power Module.

Connecting the Brake Relay to the inverter

The connector for the Brake relay is located at the front of the Power Module for the FSA ... FSC frame sizes. These Power Modules have a cable entry for the connecting cable to the Brake Relay.

The connector for the Brake Relay is located at the bottom of the Power Module for the FSD ... FSF frame sizes.

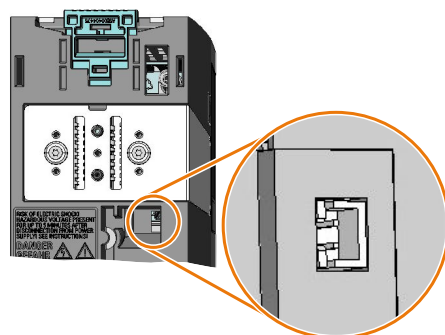

Brake relay connector for FSA ... FSC
Power Modules

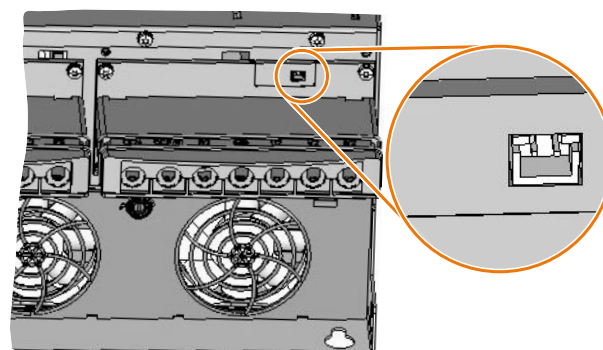

Brake relay connector for FSD ... FSF
Power Modules

4.4.6.2 Installing a Brake Relay - PM240-2 Power Module

Installing the Brake Relay

- **FSA ... FSC:** Install the Brake Relay next to the Power Module.
- **FSD ... FSG:** Install the Brake Relay at the rear of the lower shield plate. Attach the Brake Relay before you install the shield plate.

Connecting the Brake Relay to the inverter

The connector for the Brake Relay is located at the front of the Power Module. Lay the cable harness for the Brake Relay in the cable routing.

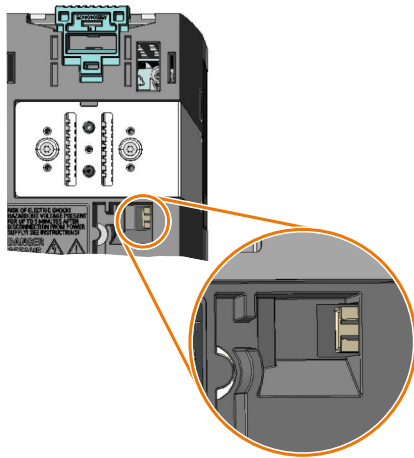

Brake relay connector for FSA ... FSC Power Modules without STO terminals

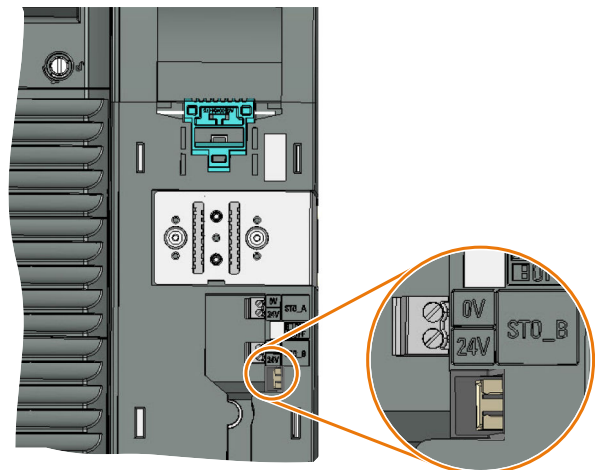

Brake relay connector for FSD ... FSG Power Modules with STO terminals

4.5 Connecting the interfaces for the inverter control

The Power Module has a holder for the Control Unit and a release mechanism.

There are different release mechanisms depending on the particular Power Module.

Inserting the Control Unit

Procedure

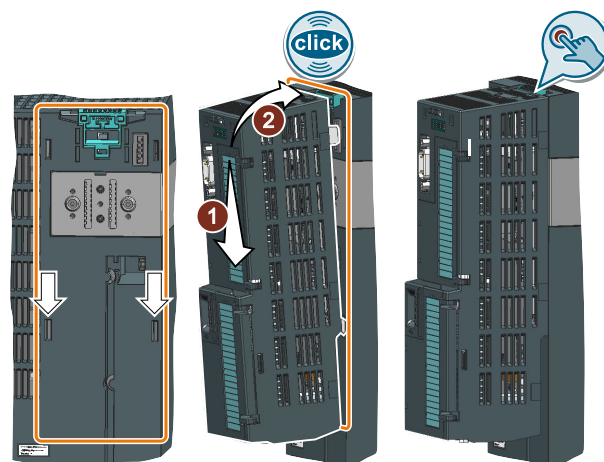

1. Place the two catches of the Control Unit in the matching grooves of the Power Module.
2. Press the Control Unit onto the Power Module until you hear that it latches.

The Control Unit is plugged onto the Power Module.

□

Removing the Control Unit

Procedure

Remove the Control Unit from the Power Module by pressing the release mechanism.

4.5.1 Overview of the interfaces on the front and upper side.

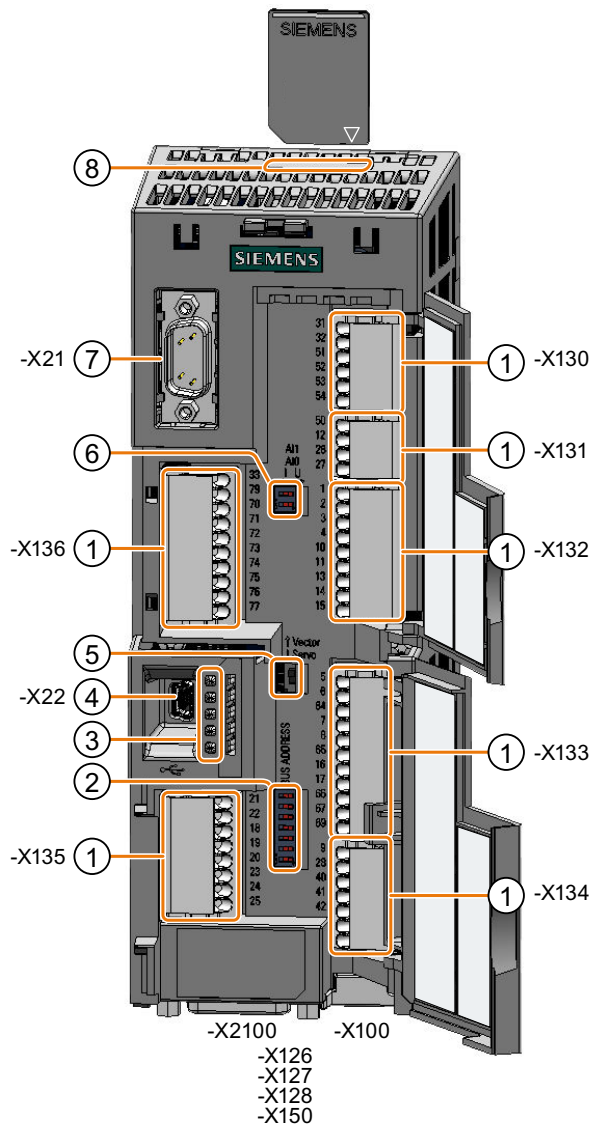

To access the interfaces at the front of the Control Unit, you must unplug the Operator Panel (if one is being used) and open the front doors.

- ① Terminal strips
- ② Selecting the fieldbus address:
 - PROFIBUS
 - USS
 - Modbus RTU
 - CanOpen

Bit 6 (64)	■
Bit 5 (32)	■
Bit 4 (16)	■
Bit 3 (8)	■
Bit 2 (4)	■
Bit 1 (2)	■
Bit 0 (1)	■
On	Off

- ③ Status LED

■	RDY	} only for PROFINET
■	BF	
■	SAFE	
■	LNK1	
■	LNK2	

- ④ USB interface for connection to a PC
- ⑤ Keep the switch in the "Vector" position. The inverter is not functional in the "Servo" setting.

- ⑥ Switch for analog inputs

AI 1	■
AI 0	■
I	U

- ⑦ Connection to the operator panel
- ⑧ Memory card slot

4.5.2 Terminal strips behind the upper front door

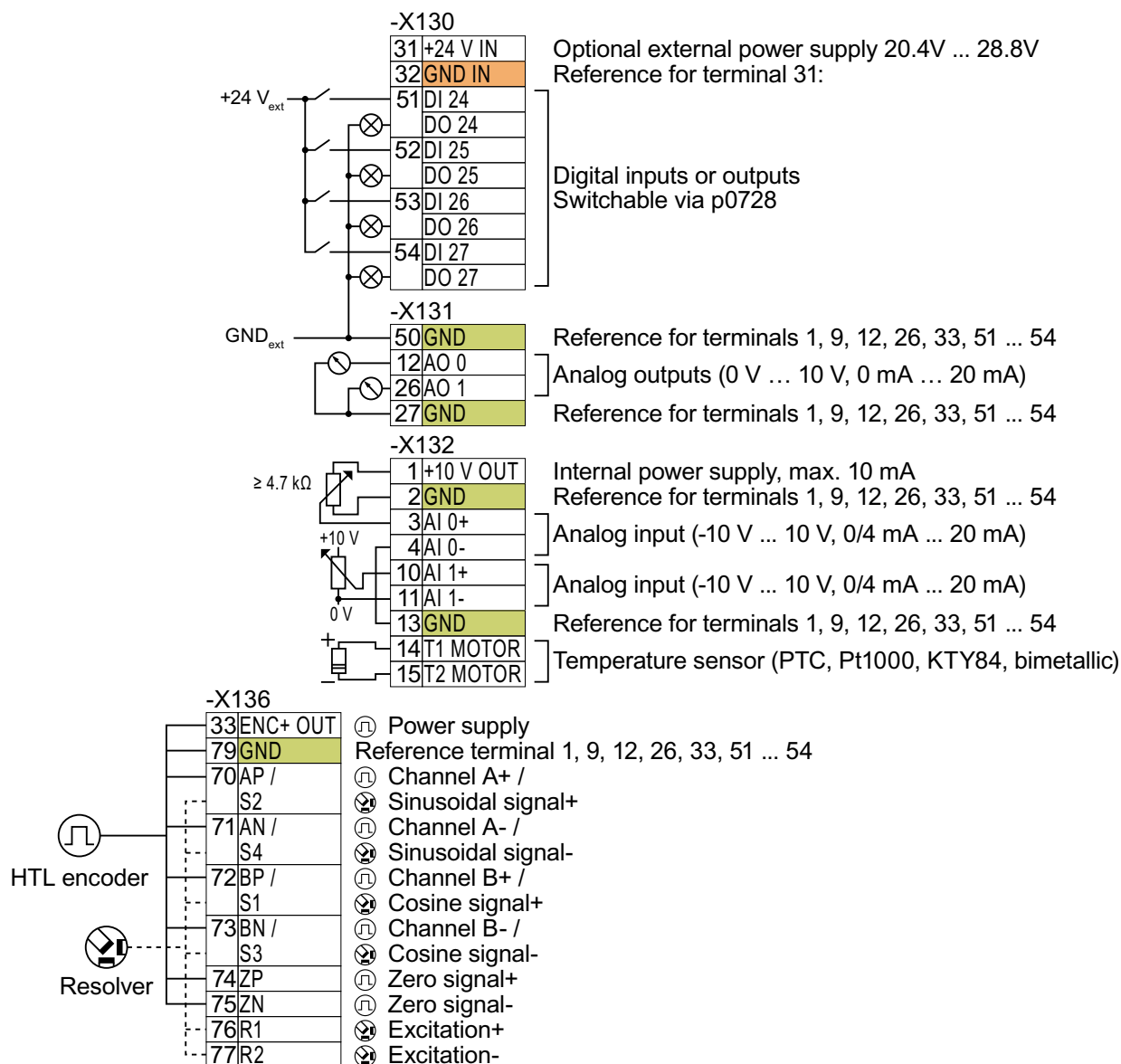

Figure 4-14 Interconnection example of the digital inputs with external 24 V power supply

- GND** All terminals with reference potential "GND" are connected with one another in the inverter.
- 31 +24 V IN**
32 GND IN Connecting the optional 24 V supply to terminals 31, 32 has the following advantages:
- The Control Unit remains in operation after disconnection of the Power Module from the line supply. The Control Unit thus maintains the fieldbus communication, for example.
 - You can use terminals 51 ... 54 as digital outputs.
- for terminals 31, 32 only use a 24 VDC power supply with PELV (Protective Extra Low Voltage).
- for applications in the USA and Canada: Use a 24 VDC power supply, NEC Class 2.

4.5 Connecting the interfaces for the inverter control

→ connect the 0 V of the power supply with the protective conductor.

If you use a common external power supply for terminals 31, 32 and the digital inputs, you must connect "GND" and the reference potential of the digital input ("DI COM1/2/3") with each other at the terminals.

3	AI 0+
4	AI 0-
10	AI 1+
11	AI 1-

You may use the internal 10V power supply or an external power supply for the analog inputs at terminals 3, 4 and 10, 11. For an internal 10V power supply, you must connect AI 0 or AI 1 to GND.

4.5.3 Terminal strips behind the lower front door

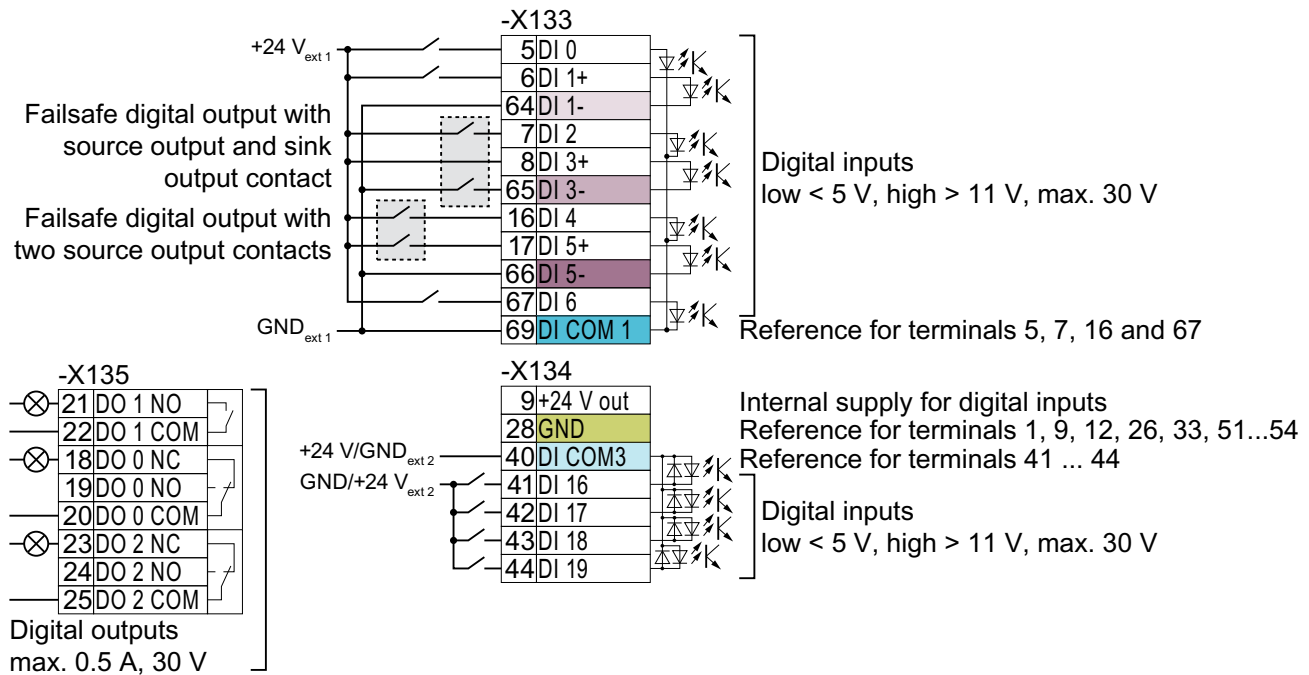

Figure 4-15 Interconnection example of the digital inputs with external 24 V power supplies

- GND** All terminals with reference potential "GND" are connected with one another in the inverter.
- DI X-** Reference potentials for DI 1, DI 3 and DI 5, electrically isolated from "GND"
- DI COM1** Reference potential for DI 0, DI 2, DI 4 and DI 6, electrically isolated from "GND"
- DI COM3** Reference potential for DI 16 ... DI 19, electrically isolated from "GND"

Table 4-17 Supply options for the digital inputs

Supply	Reference potential interconnection
You are using an external 24 V supply	As shown above, connect the reference potential of the external 24-V supply to the reference potential of the corresponding digital input.
You are using the internal 24 V supply at terminal 9	Connect the appropriate reference potential of the digital input to GND.

4.5.4 Fieldbus and encoder interfaces on the lower side

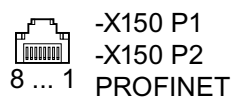
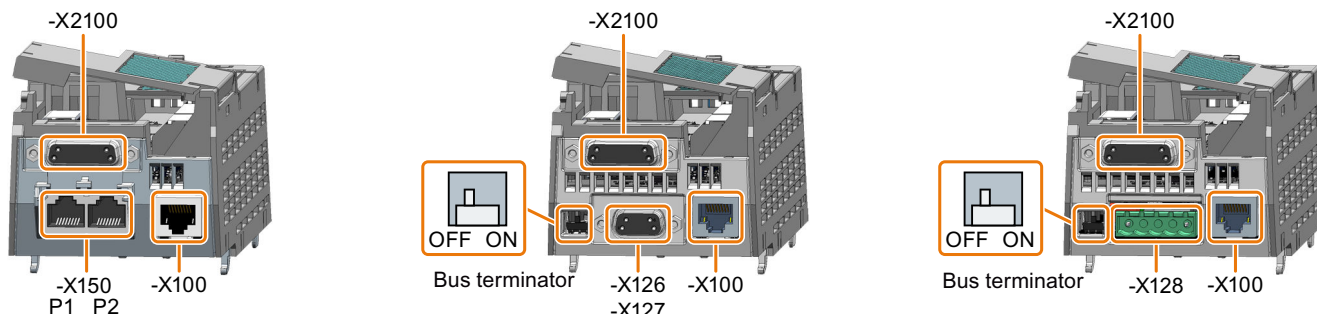

- 1 RX+ Receive data +
- 2 RX- Receive data -
- 3 TX+ Send data +
- 4 ---
- 5 ---
- 6 TX- Send data -
- 7 ---
- 8 ---

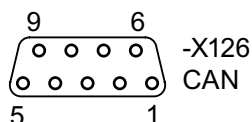

- 1 ---
- 2 CAN_L CAN signal (dominant low)
- 3 CAN_GND, CAN ground
- 4 ---
- 5 (CAN_SHLD), Optional shield
- 6 (GND), optional ground
- 7 CAN_H, CAN signal (dominant high)
- 8 ---
- 9 ---

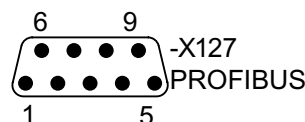

- 1 ---
- 2 M, reference potential for P24_Serv
- 3 RxD/TxD-P, receive and send (B/B')
- 4 CNTR-P control signal
- 5 GND reference potential for data (C/C')
- 6 + 5 V power supply
- 7 P24_Serv
- 8 RxD/TxD-N, receive and send (A/A')
- 9 ---

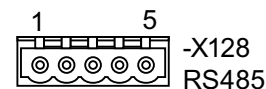

- 1 0 V, reference potential
- 2 RS485P, receive and send (+)
- 3 RS485N, receive and send (-)
- 4 Cable shield
- 5 ---

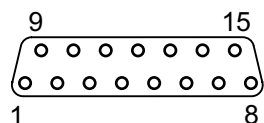

	KTY84, Pt1000, PTC or temperature switch	HTL	TTL	SSI (RS422 standard)
1 Motor temperature sensing +	Temp +	---	---	---
2 SSI clock	---	---	---	Clock +
3 Inverse SSI clock	---	---	---	Clock -
4 Encoder power supply ¹⁾	---	24 V	5 V	24 V
5 Encoder power supply ¹⁾	---	24 V	5 V	24 V
6 Sense signal from the encoder	---	---	Sense+	---
7 Reference for encoder power supply	---	0 V	0 V	0 V
8 Motor temperature sensing -	Temp -	---	---	---
9 Reference for sense signal	---	---	Sense-	---
10 Zero signal+	---	R +	R +	---
11 Zero signal-	---	R -	R -	---
12 Channel B-	---	B -	B -	---
13 Channel B+	---	B +	B +	---
14 Channel- / SSI data	---	A -	A -	Data -
15 Channel A+ / SSI data	---	A +	A +	Data +

¹⁾ Optional connection of the power supply at pin 4 or pin 5

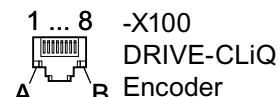

Encoder with DRIVE-CLiQ interface or encoder via Sensor Module

- 1 Send data +
- 2 Send data -
- 3 Receive data +
- 4 ---
- 5 ---
- 6 Receive data -
- 7 ---
- 8 ---
- A + 24 V power supply
- B 0 V, reference for power supply

4.5 Connecting the interfaces for the inverter control

4.5.5 Factory interface settings

The factory setting of the interfaces depends on which fieldbus the Control Unit supports.

Control Units with USS or CANopen interface

The fieldbus interface is not active.

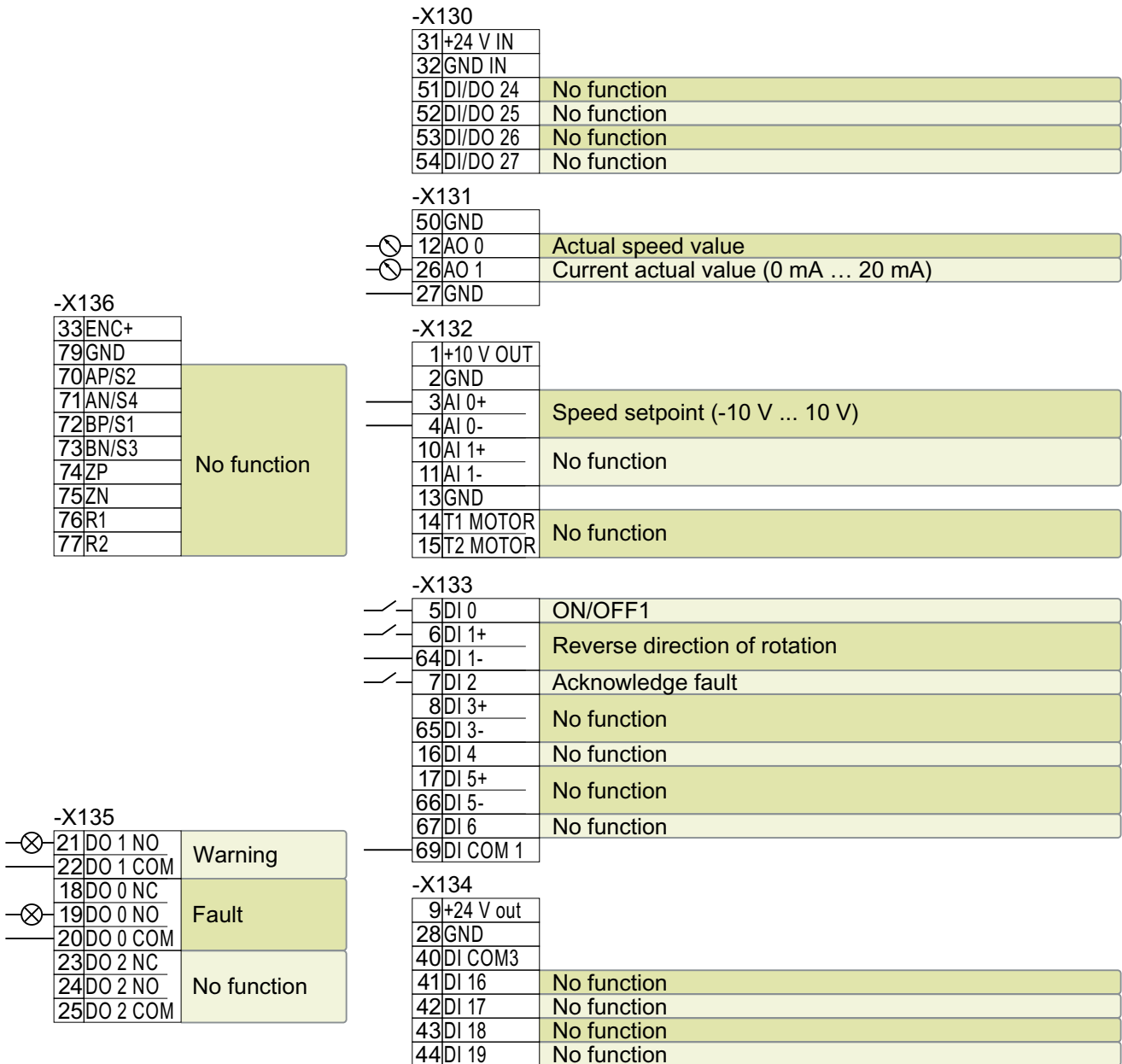

Figure 4-16 Factory setting of the CU250S-2 and CU250S-2 CAN Control Units

Control Units with PROFIBUS or PROFINET interface

The function of the fieldbus interface depends on DI 3.

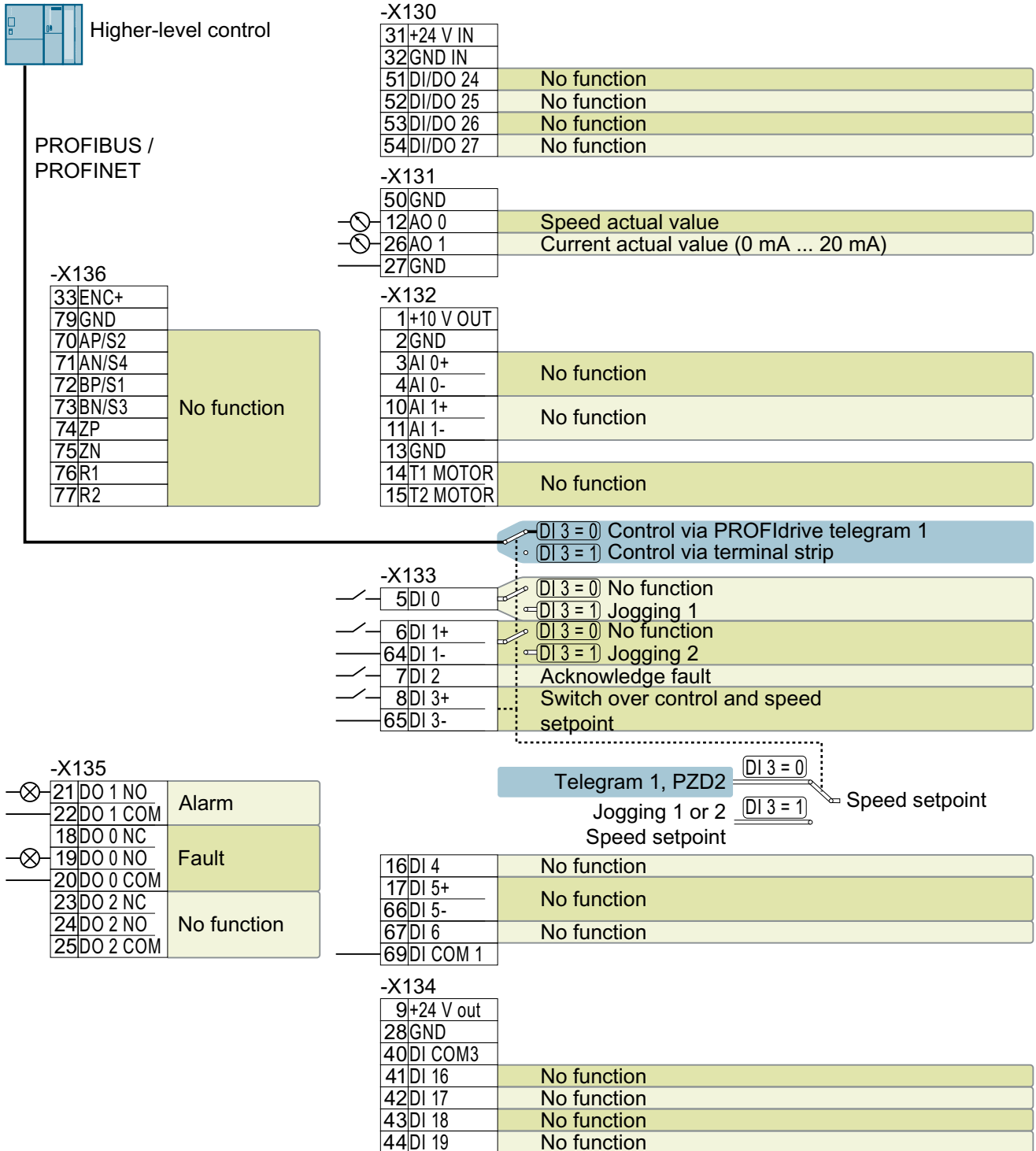

Figure 4-17 Factory setting of the CU250S-2 DP and CU250S-2 PN Control Units

4.5.6 Default setting of the interfaces

Changing the function of the terminals

The function of the terminals and fieldbus interface can be adjusted.

In order that you do not have to successively change terminal for terminal, several terminals can be jointly set using default settings ("p0015 Macro drive unit").

The terminal settings made in the factory described above correspond to the following default settings:

- Default setting 12 (p0015 = 12): "Standard I/O with analog setpoint"
- Default setting 7 (p0015 = 7): "Fieldbus with data set switchover"

Default setting 1: "Conveyor technology with 2 fixed frequencies"

—	5	DI 0	ON/OFF1 clockwise
—	6	DI 1	ON/OFF1 counterclockwise
—	7	DI 2	Acknowledge fault
—	16	DI 4	Fixed speed setpoint 3:
—	17	DI 5	Fixed speed setpoint 4
⊗	18	DO 0	Fault
	19		
	20		
⊗	21	DO 1	Warning
	22		
⊖	12	AO 0	Actual speed value
⊖	26	AO 1	Actual current value

DO 0: p0730, DO 1: p0731 AO 0: p0771[0], AO 1: p0771[1] DI 0: r0722.0, ..., DI 5: r0722.5
 Fixed speed setpoint 3: p1003, fixed speed setpoint 4: p1004, fixed speed setpoint active: r1024
 Speed setpoint (main setpoint): p1070[0] = 1024
 DI 4 and DI 5 = high: The inverter adds both fixed speed setpoints
 Designation in the BOP-2: coN 2 SP

Default setting 2: "Conveyor systems with Basic Safety"

—	5	DI 0	ON/OFF1 with fixed speed setpoint 1
—	6	DI 1	Fixed speed setpoint 2:
—	7	DI 2	Acknowledge fault
—	16	DI 4	} Reserved für a safety function
—	17	DI 5	
⊗	18	DO 0	Fault
	19		
	20		
⊗	21	DO 1	Warning
	22		
⊖	12	AO 0	Actual speed value
⊖	26	AO 1	Actual current value

DO 0: p0730, DO 1: p0731 AO 0: p0771[0], AO 1: p0771[1] DI 0: r0722.0, ..., DI 5: r0722.5

Fixed speed setpoint 1: p1001, fixed speed setpoint 2: p1002, fixed speed setpoint active: r1024

Speed setpoint (main setpoint): p1070[0] = 1024

DI 0 and DI 1 = high: The inverter adds both fixed speed setpoints.

Designation in the BOP-2: coN SAFE

Default setting 3: "Conveyor systems with 4 fixed frequencies"

—	5	DI 0	ON/OFF1 with fixed speed setpoint 1
—	6	DI 1	Fixed speed setpoint 2
—	7	DI 2	Acknowledge fault
—	16	DI 4	Fixed speed setpoint 3
—	17	DI 5	Fixed speed setpoint 4
⊗	18	DO 0	Fault
	19		
	20		
⊗	21	DO 1	Warning
	22		
⊖	12	AO 0	Actual speed value
⊖	26	AO 1	Actual current value

DO 0: p0730, DO 1: p0731 AO 0: p0771[0], AO 1: p0771[1] DI 0: r0722.0, ..., DI 5: r0722.5

Fixed speed setpoint 1: p1001, ... fixed speed setpoint 4: p1004, fixed speed setpoint active: r1024

Speed setpoint (main setpoint): p1070[0] = 1024

Several of the DI 0, DI 1, DI 4, and DI 5 = high: the inverter adds the corresponding fixed speed setpoints.

Designation in the BOP-2: coN 4 SP

Default setting 7: "Fieldbus with data set switchover"

Factory setting for inverters with PROFIBUS interface

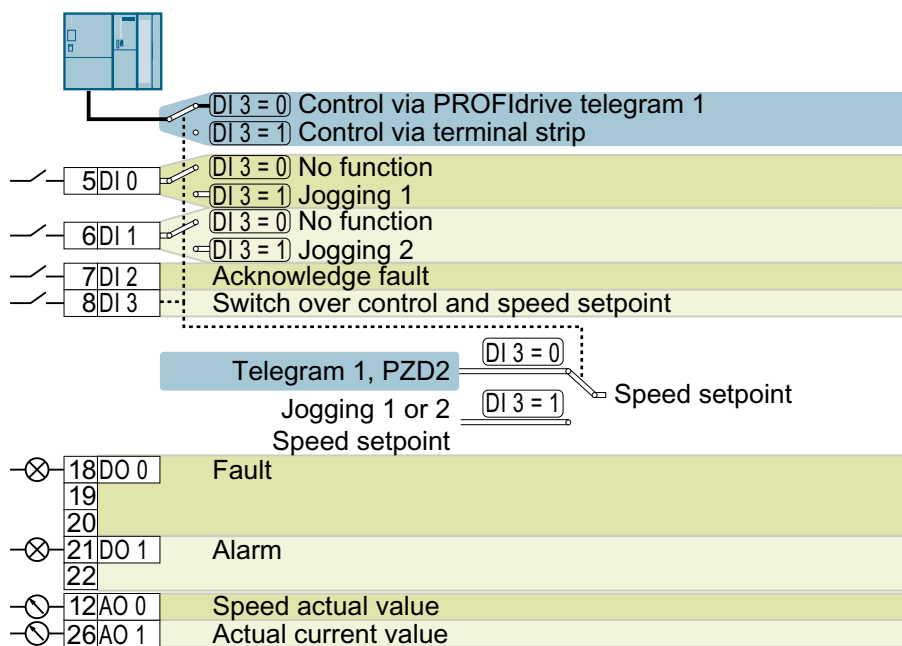

DO 0: p0730, DO 1: p0731 AO 0: p0771[0], AO 1: p0771[1] DI 0: r0722.0, ..., DI 3: r0722.3

Speed setpoint (main setpoint): p1070[0] = 2050[1]

Jog 1 speed setpoint: p1058, factory setting: 150 rpm

Jog 2 speed setpoint: p1059, factory setting: -150 rpm

Designation in the BOP-2: FB cdS

Default setting 8: "MOP with Basic Safety"

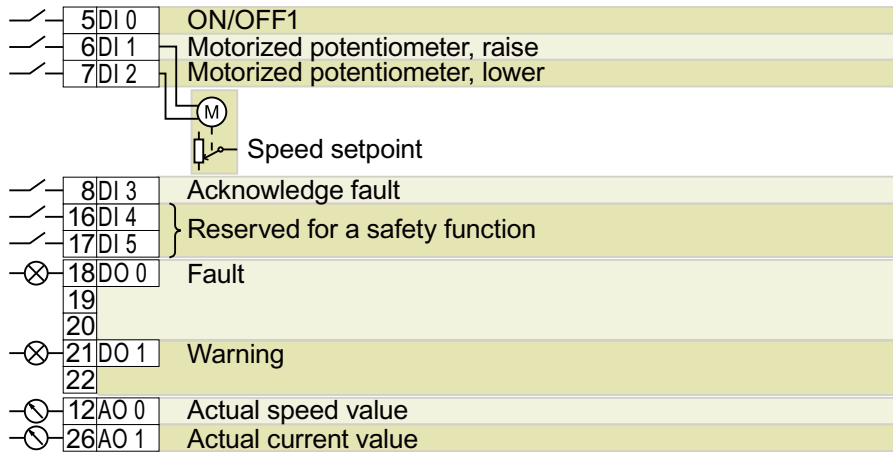

MOP = motorized potentiometer

DO 0: p0730, DO 1: p0731 AO 0: p0771[0], AO 1: p0771[1] DI 0: r0722.0, ..., DI 5: r0722.5

Motorized potentiometer setpoint after ramp-function generator: r1050

Speed setpoint (main setpoint): p1070[0] = 1050

Designation in the BOP-2: MoP SAFE

Default setting 9: "Standard I/O with MOP"

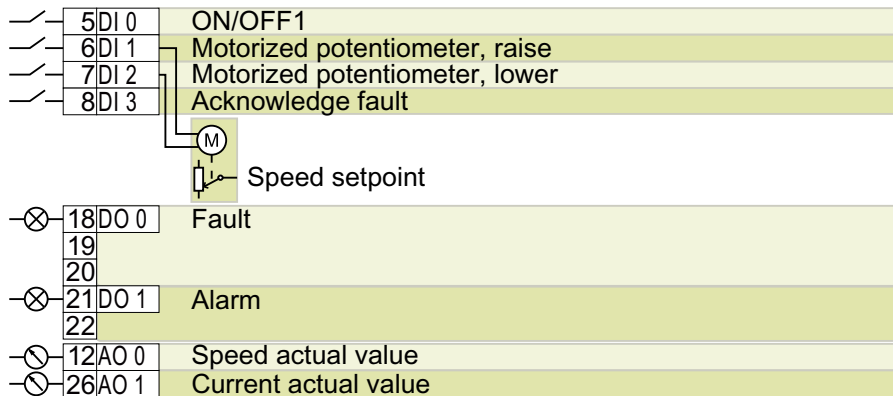

MOP = motorized potentiometer

DO 0: p0730, DO 1: p0731 AO 0: p0771[0], AO 1: p0771[1] DI 0: r0722.0, ..., DI 3: r0722.3

Motorized potentiometer setpoint after ramp-function generator: r1050

Speed setpoint (main setpoint): p1070[0] = 1050

Designation in the BOP-2: Std MoP

Default setting 12: "Standard I/O with analog setpoint"

5	DI 0	ON/OFF1
6	DI 1	Reversing
7	DI 2	Acknowledge fault
3	AI 0+	Speed setpoint
18	DO 0	Fault
19		
20		
21	DO 1	Alarm
22		
12	AO 0	Speed actual value
26	AO 1	Current actual value

DO 0: p0730, DO 1: AO 0: p0771[0], DI 0: r0722.0, ..., DI 2: r0722.2 AI 0: r0755[0]
 p0731 AO 1: p0771[1]

Speed setpoint (main setpoint): p1070[0] = 755[0]

Designation in the BOP-2: Std ASP

Default setting 13: "Standard I/O with analog setpoint and safety"

5	DI 0	ON/OFF1
6	DI 1	Reversing
7	DI 2	Acknowledge fault
16	DI 4	} Reserved für a safety function
17	DI 5	
3	AI 0+	Speed setpoint
18	DO 0	Fault
19		
20		
21	DO 1	Warning
22		
12	AO 0	Actual speed value
26	AO 1	Actual current value

DO 0: p0730, DO 1: AO 0: p0771[0], DI 0: r0722.0, ..., DI 5: r0722.5 AI 0: r0755[0]
 p0731 AO 1: p0771[1]

Speed setpoint (main setpoint): p1070[0] = 755[0]

Designation in the BOP-2: ASPS

Default setting 14: "Process industry with fieldbus"

PROFIdrive telegram 20

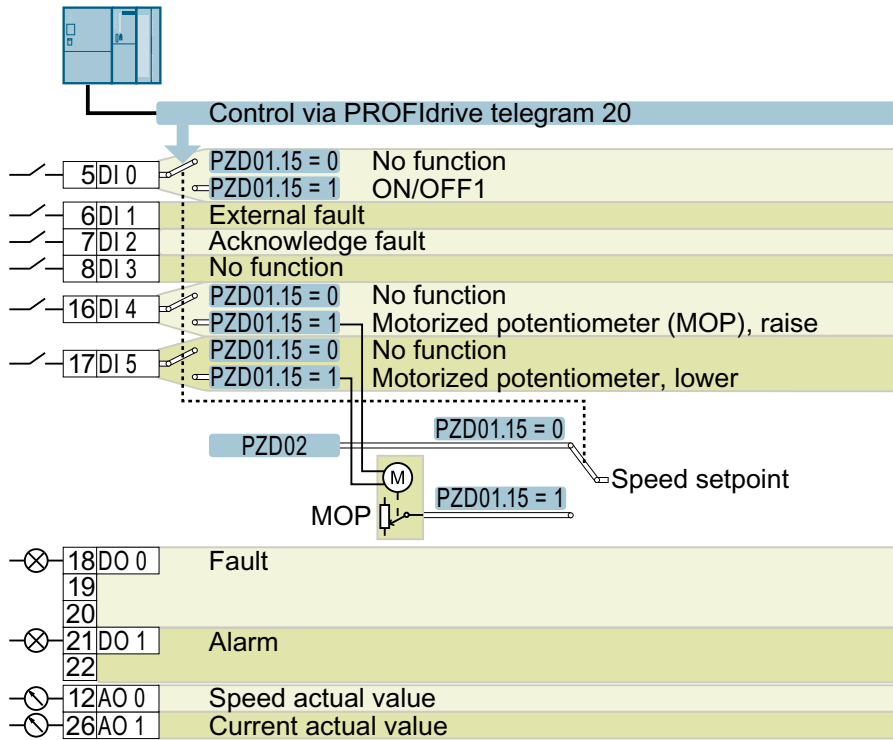

MOP = motorized potentiometer

DO 0: p0730, DO 1: p0731 AO 0: p0771[0], AO 1: p0771[1] DI 0: r0722.0, ..., DI 5: r0722.5

Motorized potentiometer setpoint after ramp-function generator: r1050

Speed setpoint (main setpoint): p1070[0] = 2050[1], p1070[1] = 1050

Switch controller via PZD01, bit 15: p0810 = r2090.15

Designation in the BOP-2: Proc Fb

Default setting 15: "Process industry"

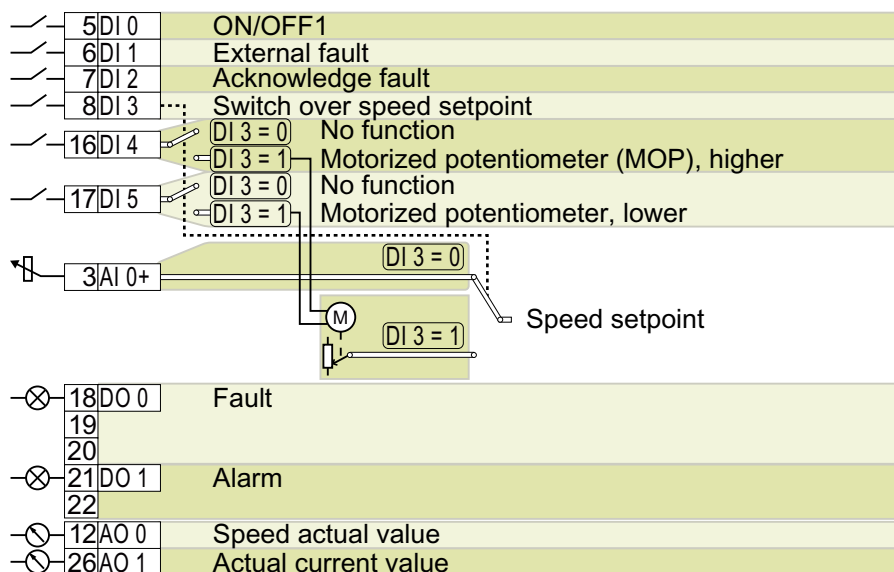

MOP = motorized potentiometer

DO 0: p0730, DO 1: p0731 AO 0: p0771[0], AO 1: p0771[1] DI 0: r0722.5, ..., DI 4: r0722.5 AI 0: r0755[0]

Motorized potentiometer setpoint after ramp-function generator: r1050

Speed setpoint (main setpoint): p1070[0] = 755[0], p1070[1] = 1050

Designation in the BOP-2: Proc

Default setting 17: "2-wire (forw/backw1)"

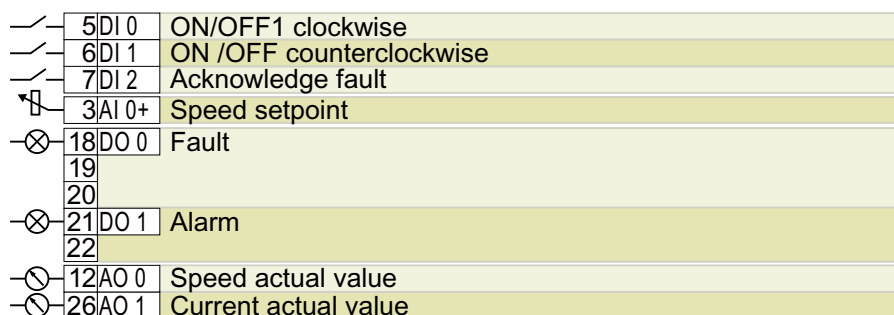

DO 0: p0730, DO 1: p0731 AO 0: p0771[0], AO 1: p0771[1] DI 0: r0722.2, ..., DI 2: r0722.2 AI 0: r0755[0]

Speed setpoint (main setpoint): p1070[0] = 755[0]

Designation in the BOP-2: 2-wlrE 1

4.5 Connecting the interfaces for the inverter control

Default setting 18: "2-wire (forw/backw2)"

5	DI 0	ON/OFF1 clockwise
6	DI 1	ON /OFF counterclockwise
7	DI 2	Acknowledge fault
3	AI 0+	Speed setpoint
18	DO 0	Fault
19		
20		
21	DO 1	Alarm
22		
12	AO 0	Speed actual value
26	AO 1	Current actual value

DO 0: p0730, DO 1: AO 0: p0771[0], DI 0: r0722.0, ..., DI 2: r0722.2 AI 0: r0755[0]
 p0731 AO 1: p0771[1]
 Speed setpoint (main setpoint): p1070[0] = 755[0]
 Designation in the BOP-2: 2-wlrE 2

Default setting 19: "3-wire (enable/forw/backw)"

5	DI 0	Enable / OFF1
6	DI 1	ON clockwise
7	DI 2	ON counterclockwise
16	DI 4	Acknowledge fault
3	AI 0+	Speed setpoint
18	DO 0	Fault
19		
20		
21	DO 1	Alarm
22		
12	AO 0	Speed actual value
26	AO 1	Current actual value

DO 0: p0730, DO 1: AO 0: p0771[0], DI 0: r0722.0, ..., DI 4: r0722.4 AI 0: r0755[0]
 p0731 AO 1: p0771[1]
 Speed setpoint (main setpoint): p1070[0] = 755[0]
 Designation in the BOP-2: 3-wlrE 1

Default setting 20: "3-wire (enable/on/reverse)"

5	DI 0	Enable / OFF1
6	DI 1	ON
7	DI 2	Reversing
16	DI 4	Acknowledge fault
3	AI 0+	Speed setpoint
18	DO 0	Fault
19		
20		
21	DO 1	Alarm
22		
12	AO 0	Speed actual value
26	AO 1	Current actual value

DO 0: p0730, DO 1: AO 0: p0771[0], DI 0: r0722.0, ..., DI 4: r0722.4 AI 0: r0755[0]
 p0731 AO 1: p0771[1]

Speed setpoint (main setpoint): p1070[0] = 755[0]

Designation in the BOP-2: 3-wlrE 2

Default setting 21: "USS fieldbus"

USS (38400 baud, 2 PZD, PKW variable)

7	DI 2	Acknowledge fault
18	DO 0	Fault
19		
20		
21	DO 1	Alarm
22		
12	AO 0	Speed actual value
26	AO 1	Current actual value

DO 0: p0730, DO 1: p0731 AO 0: p0771[0], AO 1: p0771[1] DI 2: r0722.2

Speed setpoint (main setpoint): p1070[0] = 2050[1]

Designation in the BOP-2: FB USS

Default setting 22: "CAN fieldbus"

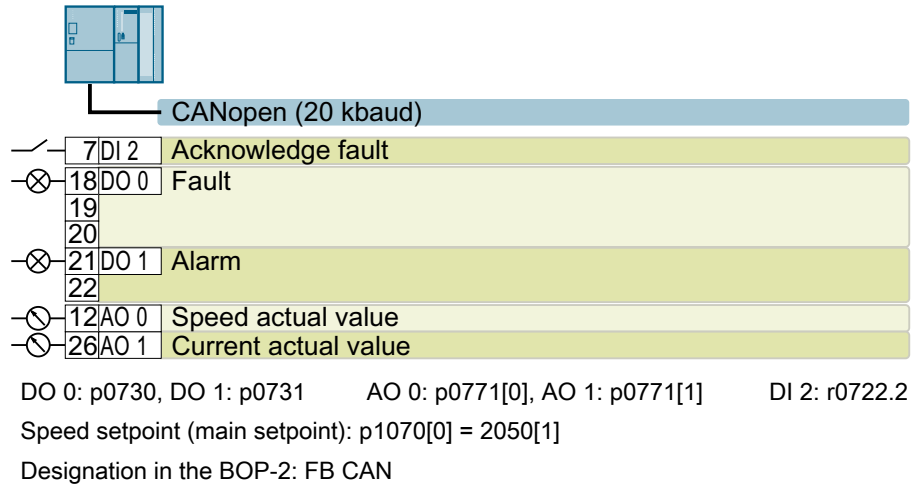

4.5.7 Fail-safe digital input

To enable a safety function via the terminal strip of the inverter, you need a fail-safe digital input.

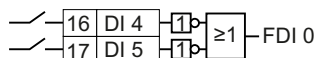

For specific default settings of the terminal strip, e.g. default setting 2, the inverter combines two digital inputs to form one fail-safe digital input FDI 0.

Which devices are you allowed to connect?

The fail-safe digital input is designed for the following devices:

- Connection of safety sensors, e.g. emergency stop command devices or light curtains.
- Connection of pre-processing devices, e.g. fail-safe control systems and safety relays.

Signal state

The inverter expects signals with the same state at its fail-safe digital input:

- High signal: The safety function is deselected.
- Low signal: The safety function is selected.

Connecting P/P and P/M-switching fail-safe digital outputs

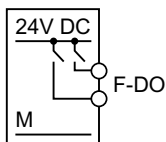

PP-switching digital output

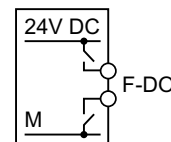

PM-switching digital output

It is permissible to connect PP and PM-switching safe outputs to a fail-safe digital input.



Connecting a fail-safe digital input (Page 511)

Fault detection

The inverter compares the two signals of the fail-safe digital input. The inverter thus detects, for example the following faults:

- Cable break
- Defective sensor

The inverter cannot detect the following faults:

- Cross-circuit of the two cables
- Short-circuit between signal cable and 24 V power supply

Special measures to prevent cross-circuits and short-circuits

The routing of cables over longer distances, e.g. between remote control cabinets, increases the risk of damaging cables. Damaged cables raise the risk of an undetected cross-circuit with power-conducting cables laid in parallel. A cross-circuit can cause interruption to the transfer of safety-related signals.

To reduce the risk of cable damage, you need to lay signal lines in steel pipes.

Special requirements placed on EMC-compliant installation

Use shielded signal cables. Connect the shield at both conductor ends.

In order to connect two or more inverter terminals, use the shortest possible jumpers directly at the terminals themselves.

Bright and dark test

The inverter filters signal changes using bright and dark tests at the fail-safe digital input using an adjustable software filter.

4.5.8 Wire up the terminal strip and connect the shield



! WARNING

Electric shock when connecting an unsuitable power supply

Death or serious injury can result when live parts are touched in the event of a fault.

- For all connections and terminals of the electronic modules, only use power supplies with protective extra low voltage (PELV), Class 2.



! WARNING

Electric shock due to unsuitable motor temperature evaluation system

Voltage flashovers to the electronics of the inverter can occur in motors without safe electrical separation of the temperature sensors in accordance with IEC 61800-5-1 when the motor develops a fault.

- Install a temperature monitoring relay 3RS1... or 3RS2...
- Evaluate the temperature monitoring relay output using a digital input of the inverter, e.g. using the "External fault" function.

You can find additional information about the temperature monitoring relay on the Internet:

 Manual 3RS1 / 3RS2 temperature monitoring relays (<https://support.industry.siemens.com/cs/ww/en/view/54999309>)

NOTICE**Overvoltages for long signal cables**

Using long cables at the inverter's digital inputs and 24 V power supply can lead to overvoltage during switching operations. Overvoltages can damage the inverter.

- If you use cables of more than 30 m at the digital inputs and 24 V power supply, connect an overvoltage protection element between the terminal and the associated reference potential.
We recommend using the Weidmüller overvoltage protection terminal with designation MCZ OVP TAZ DIODE 24VDC.

Note**Malfunction caused by incorrect switching states as the result of diagnostic flows in the off state (logical state "0")**

In contrast to mechanical switching contacts, e.g. emergency stop switches, diagnostic flows can also flow with semiconductor switches in the off state. If interconnection with digital inputs is faulty, the diagnostic flows can lead to incorrect switching states and thus to a malfunction of the drive.

- Observe the conditions for digital inputs and digital outputs specified in the relevant manufacturers documentation.
- Check the conditions of the digital inputs and digital outputs in regard to the flows in off state. If applicable, connect the digital inputs with suitably dimensioned, external resistors to protect against the reference potential of the digital inputs.

Table 4-18 Permissible cables and wiring options

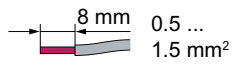
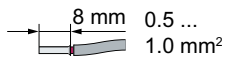
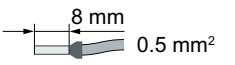
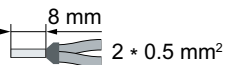
Solid or finely stranded conductor	Finely stranded conductor with non-insulated conductor end sleeve	Finely stranded conductor with partially insulated conductor end sleeve	Two finely stranded conductors with the same cross-section with partially insulated twin end sleeves
 8 mm 0.5 ... 1.5 mm ²	 8 mm 0.5 ... 1.0 mm ²	 8 mm 0.5 mm ²	 8 mm 2 * 0.5 mm ²

Wiring the terminal strip in compliance with EMC

- If you use shielded cables, then you must connect the shield to the mounting plate of the control cabinet or with the shield support of the inverter through a good electrical connection and a large surface area.

Further information is provided on the Internet:

 EMC installation guideline (<http://support.automation.siemens.com/WW/view/en/60612658>)

- Use the shield connection kit (Article No. 6SL3264-1EA00-0LA0) of the Control Unit as strain relief.

Connecting encoder and signal cables to the terminal strip in compliance with EMC

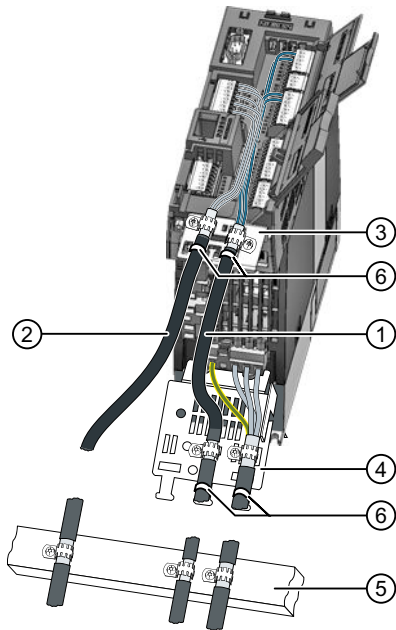

- Use shielded cables.
- Mount the shield plate of the ③ Control Unit.

Signal cables ①

- Connect the shield of the signal cables to the shield plate of the Control Unit ③ and to the shield plate of the Power Module ④.
- Attach the strain relief elements to the shield plate ⑥.
- Before the signal cable leaves the control cabinet, also connect the shield ⑤.

Encoder cables ②

- Connect the shield of the encoder cable to the shield plate of the Control Unit ③.
- Attach a strain relief element to the shield plate ⑥.
- Before the encoder cable leaves the control cabinet, also connect the shield ⑤.

Connecting encoders to SUB-D connectors or via DRIVE-CLiQ in compliance with EMC

- Use shielded cables.
- Connect the cable shield in the connector housing.
- Mount a strain relief, e.g. at the shield plate of the Control Unit.
- Where the cable leaves the control cabinet, also connect the shield to the shield rail of the control cabinet.

4.5.9 Connecting the temperature contact of the braking resistor



⚠ WARNING

Fire caused by an unsuitable or incorrectly installed braking resistor

Using an unsuitable or improperly installed braking resistor can cause fires and smoke to develop. Fire and smoke development can cause severe personal injury or material damage.

- Only use braking resistors that are approved for the inverter.
- Install the braking resistor in accordance with regulations.
- Monitor the temperature of the braking resistor.

Procedure

1. Connect the temperature monitoring system of the braking resistor (terminals T1 and T2 on the braking resistor) to a free digital input on the inverter.

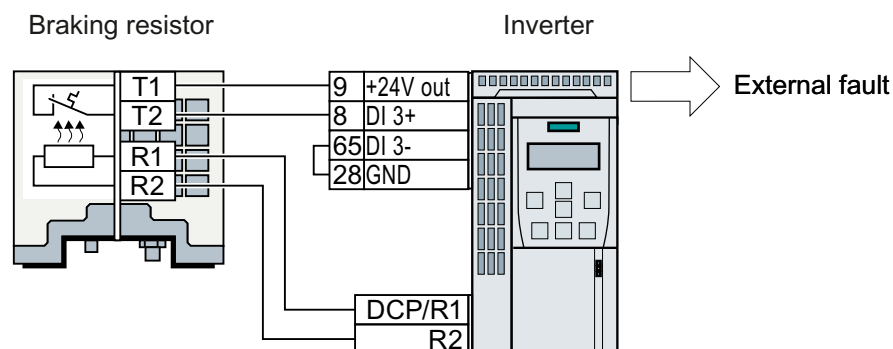

Figure 4-18 Example: Temperature monitoring of the braking resistor via digital input DI 3 on the Control Unit

2. Define the function of the digital input used as an external fault with p2106.
As an example with temperature monitoring via digital input DI 3: p2106 = 722.3.

You have ensured that the braking resistor temperature is monitored.



4.5.10 Fieldbus interfaces

Fieldbus interfaces of the Control Units

There are different versions of the Control Units for communication with a higher-level control system:

Fieldbus	Profiles			S7 communication ²⁾	Control Unit
	PROFIdrive	PROFIsafe ¹⁾	PROFInergy ²⁾		
PROFINET	✓	✓	✓	✓	CU250S-2 PN
EtherNet/IP ²⁾		---		---	
PROFIBUS	✓	✓	---	✓	CU250S-2 DP

Fieldbus	Profiles			S7 communication ²⁾	Control Unit
	PROFIdrive	PROFIsafe ¹⁾	PROFIenergy ²⁾		
USS ²⁾		---		---	CU250S-2
Modbus RTU ²⁾		---		---	
CANopen ²⁾		---		---	CU250S-2 CAN

¹⁾ Information on PROFIsafe can be found in the "Safety Integrated" function manual.

²⁾ Information about fieldbuses, profiles and communication types can be found in the "Fieldbus" function manual.

 Overview of the manuals (Page 519)

4.5.11 Connecting the inverter to PROFINET

4.5.11.1 Communication via PROFINET IO and Ethernet

You can either integrate the inverter in a PROFINET network or communicate with the inverter via Ethernet.

The inverter in PROFINET IO operation

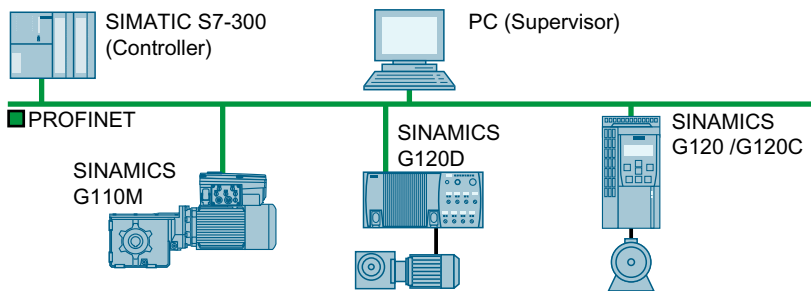

Figure 4-19 The inverter in PROFINET IO operation

The inverter supports the following functions:

- RT
- IRT: The inverter forwards the clock synchronism, but does not support clock synchronism.
- MRP: Media redundancy, impulsed with 200 ms. Requirement: Ring topology
- MRPD: Media redundancy, bumpless. Requirement: IRT and the ring topology created in the control
- Diagnostic alarms in accordance with the error classes specified in the PROFIdrive profile.
- Device replacement without removable data storage medium
- Shared Device for Control Units with fail-safe functions

The inverter as Ethernet node

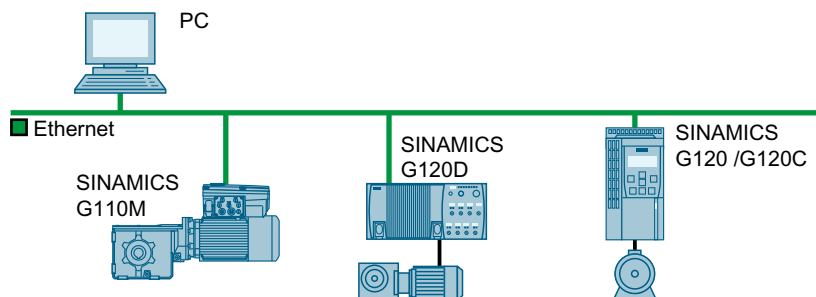





Figure 4-20 The inverter as Ethernet node

Further information on the operation as Ethernet nodes can be found in the Function Manual "Fieldbuses".

 Overview of the manuals (Page 519)

Further information on PROFINET

Further information on PROFINET can be found on the Internet:

-  PROFINET – the Ethernet standard for automation (<http://w3.siemens.com/mcms/automation/en/industrial-communications/profinet/Pages/Default.aspx>)
-  PROFINET system description (<https://support.industry.siemens.com/cs/ww/en/view/19292127>)

4.5.11.2 Connecting the PROFINET cable to the inverter

Procedure

1. Integrate the inverter in the bus system (e.g. ring topology) of the control using PROFINET cables and the two PROFINET sockets X150-P1 and X150-P2.
 Overview of the interfaces on the front and upper side. (Page 92)
 The maximum permitted cable length from the previous station and to the next one is 100 m.
2. Externally supply the inverter with 24 VDC through terminals 31 and 32.
 The external 24 V supply is only required if communications with the control should also run when the line voltage is switched off.

You have now connected the inverter to the control system via PROFINET DP.

□

Communication with the controller even when the supply voltage on the Power Module is switched off

You must supply the Control Unit with 24 V DC at terminals 31 and 32 if you wish to maintain communication with the control system when the line voltage is switched off.

In the case of brief interruptions of the 24 V power supply, the inverter may signal a fault without communications with the control system being interrupted.

4.5.11.3 What do you have to set for communication via PROFINET?

Configuring PROFINET communication in the I/O controller

You require the appropriate engineering system to configure PROFINET communication in the IO controller.

If required, load the GSDML file of the inverter into the engineering system.

 Installing GSDML (Page 117)

Device name

In addition to the MAC address and IP address, PROFINET also uses the device name to identify PROFINET devices (Device name). The device name must be unique across the PROFINET network.

To assign the device name, you need an engineering software, e.g. HW-Config or STARTER.

The inverter saves the device name on the inserted memory card.

IP address

In addition to the device name, PROFINET also uses an IP address.

You have the following options to specify the IP address of the inverter:

- You specify the IP address via an engineering software, e.g. via HW-Config or STARTER.
- The IO Controller assigns an IP address to the inverter.

Telegram

Set the same telegram in the inverter as in the IO Controller. Interconnect the telegrams in the control program of the IO Controller with the signals of your choosing.

 Drive control via PROFIBUS or PROFINET (Page 183)

Application examples

You can find application examples for PROFINET communication on the Internet:

 Controlling the speed of a SINAMICS G110M/G120/G120C/G120D with S7-300/400F via PROFINET or PROFIBUS, with Safety Integrated (via terminal) and HMI (<https://support.industry.siemens.com/cs/ww/en/view/60441457>)

 Controlling the speed of a SINAMICS G110M / G120 (Startdrive) with S7-1500 (TO) via PROFINET or PROFIBUS, with Safety Integrated (via terminal) and HMI (<https://support.industry.siemens.com/cs/ww/en/view/78788716>)

4.5.11.4 Installing GSDML

Procedure

1. Save the GSDML to your PC.

– With Internet access:

🌐 GSDML (<http://support.automation.siemens.com/WW/view/en/22339653/133100>)

– Without Internet access:

Insert a memory card into the inverter.

Set p0804 = 12.

The inverter writes the GSDML as zipped file (*.zip) into directory /SIEMENS/SINAMICS/DATA/CFG on the memory card.

2. Unzip the GSDML file on your computer.

3. Import the GSDML into the engineering system of the controller.

You have now installed the GSDML in the engineering system of the controller.

□

4.5.12 Connecting the inverter to PROFIBUS

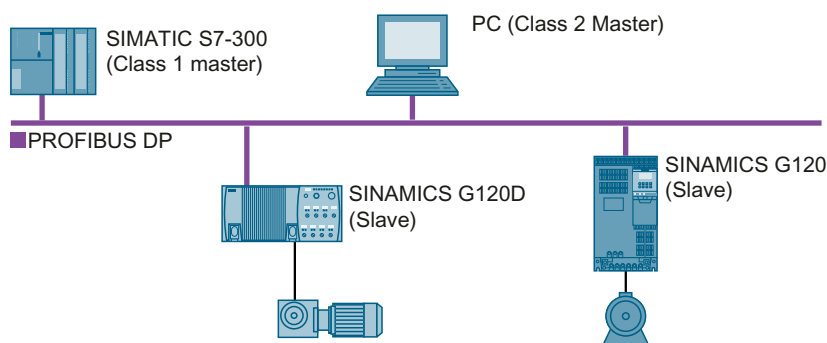

The PROFIBUS DP interface has the following functions:

- Cyclic communication
- Acyclic communication
- Diagnostic alarms

General information on PROFIBUS DP can be found in the Internet:

- 🌐 PROFIBUS user organization (<http://www.profibus.com/downloads/installation-guide/>)
- 🌐 Information about PROFIBUS DP (http://www.automation.siemens.com/net/html_76/support/printkatalog.htm)

4.5.12.1 Connecting the PROFIBUS cable to the inverter

Procedure

1. Integrate the inverter into the bus system (e.g. line topology) of the control using PROFIBUS cables via socket X126.
 Overview of the interfaces on the front and upper side. (Page 92)
The maximum permitted cable length to the previous station and the subsequent one is 100 m at a baud rate of 12 Mbit/s.
2. Externally supply the inverter with 24 VDC through terminals 31 and 32.
The external 24 V supply is only required if communications with the control should also run when the line voltage is switched off.

You have now connected the inverter to the control system using PROFIBUS DP.



4.5.12.2 What do you have to set for communication via PROFIBUS?

Configuring PROFIBUS communication

You require the appropriate engineering system to configure PROFIBUS communication in the PROFIBUS master.

If required, load the GSD file of the inverter into the engineering system.

 Installing the GSD (Page 119)

Setting the address

Set the address of the PROFIBUS slave.

 Setting the address (Page 119)

Setting the telegram

Set the telegram in the inverter as in the PROFIBUS master. Interconnect the telegrams in the control program of the PROFIBUS master with the signals of your choosing.

 Drive control via PROFIBUS or PROFINET (Page 183)

Application examples

You can find application examples for PROFIBUS communication on the Internet:

 Controlling the speed of a SINAMICS G110M/G120/G120C/G120D with S7-300/400F via PROFINET or PROFIBUS, with Safety Integrated (via terminal) and HMI (<https://support.industry.siemens.com/cs/ww/en/view/60441457>)

 Controlling the speed of a SINAMICS G110M / G120 (Startdrive) with S7-1500 (TO) via PROFINET or PROFIBUS, with Safety Integrated (via terminal) and HMI (<https://support.industry.siemens.com/cs/ww/en/view/78788716>)

Communication with the controller even when the supply voltage on the Power Module is switched off

You must supply the Control Unit with 24 V DC at terminals 31 and 32 if you wish to maintain communication with the control system when the line voltage is switched off.

In the case of brief interruptions of the 24 V power supply, the inverter may signal a fault without communications with the control system being interrupted.

4.5.12.3 Installing the GSD

Procedure

1. Save the GSD on your PC via one of the following methods.
 - With Internet access:
 -  GSD (<http://support.automation.siemens.com/WW/view/en/22339653/133100>)
 - Without Internet access:
 - Insert a memory card into the inverter.
 - Set p0804 to 12.
 - The inverter writes the GSD as zipped file (*.zip) into directory /SIEMENS/SINAMICS/DATA/CFG on the memory card.
2. Unzip the GSD file on your computer.
3. Import the GSD in the engineering system of the controller.

You have now installed the GSD file in the engineering system of the controller.

□

4.5.12.4 Setting the address

Valid address area: 1 ... 125

You have the following options for setting the address:

- Using the address switch on the Control Unit:

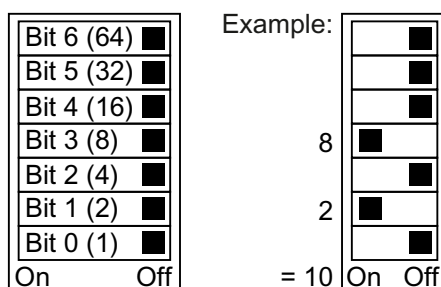

Figure 4-21 Address switch with example for bus address 10

The address switch has priority over the other settings.

- Using Startdrive or an operator panel via parameter p0918 (default setting: p0918 = 126)
It is only possible to change p0918 if an invalid address is set in the address switch.
If you are working with Startdrive, back up the settings so they are not lost if the power fails.



Overview of the interfaces on the front and upper side. (Page 92)

Setting the bus address

Procedure

1. Set the address using one of the subsequently listed options:
 - Via the address switch
 - On an operator panel via p0918
 - With Startdrive
Confirm the prompt for saving your settings (copy RAM to ROM).
2. Switch off the inverter power supply.
3. Wait until all LEDs on the inverter are dark.
4. Switch on the inverter power supply again.
Your settings become effective after switching on.

The PROFIBUS address is set.



4.6 Installing encoders

Encoders for position control





Permissible encoders for position control and the permissible combination of encoders for speed and position control are listed in the "Basic positioner" function manual.

 Overview of the manuals (Page 519)

Encoders for speed control

The encoder must be mounted on the motor shaft.

Table 4-19 Suitable encoders for the closed-loop speed control

Encoder type	Terminal strip - X136 	SUB-D -X2100 	DRIVE-CLiQ -X100 	
			Connection via SMC or SME	Connection via DRIVE-CLiQ
Resolver	✓		✓	
HTL encoder	✓	✓	✓	
TTL encoder		✓	✓	
SSI encoder		✓	✓	
Endat 2.1			✓	
sin/cos encoder			✓	
DRIVE-CLiQ encoder				✓
	 Terminal strips behind the upper front door (Page 93)	 Overview of the interfaces on the front and upper side. (Page 92)		

You can find information about prefabricated encoder cables for the terminal strip and the SUB-D interface-X2100 in the Internet:

 Encoder cables (<https://support.industry.siemens.com/cs/de/en/view/108441438>)

Example: Connecting an SSI encoder to SUB-D connector -X2100

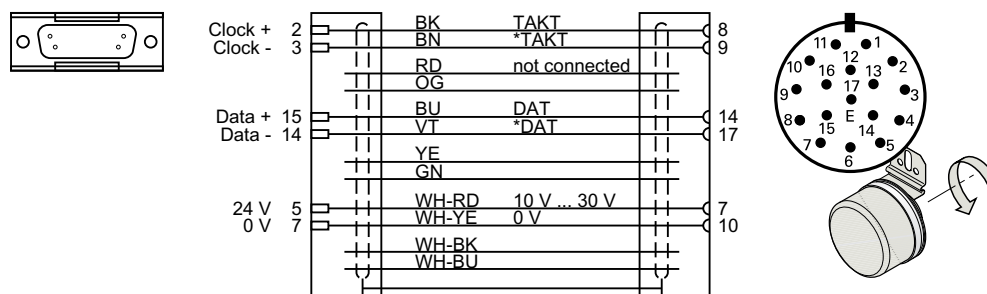

Figure 4-22 Connecting SSI encoders 1XP8014-20, 1XP8024-20 or 1XP8024-21

4.6 Installing encoders

Suitable prefabricated encoder cables:

- 6FX5002-2CC06-...
- 6FX8002-2CC06-...

Example: Connecting an HTL encoder at terminal strip -X136

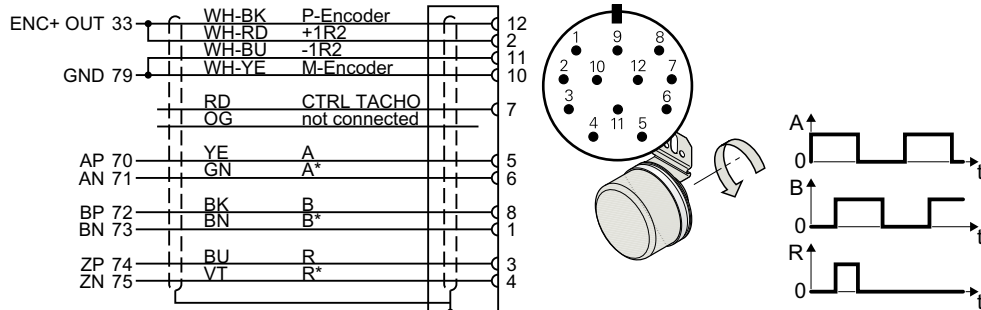

Figure 4-23 Connecting a bipolar HTL encoder 1XP8012 or 1XP8032

Suitable prefabricated encoder cables:

- 6FX5002-2CA12-...
- 6FX8002-2CA12-...

Example: Connecting a unipolar HTL encoder at terminal strip -X136

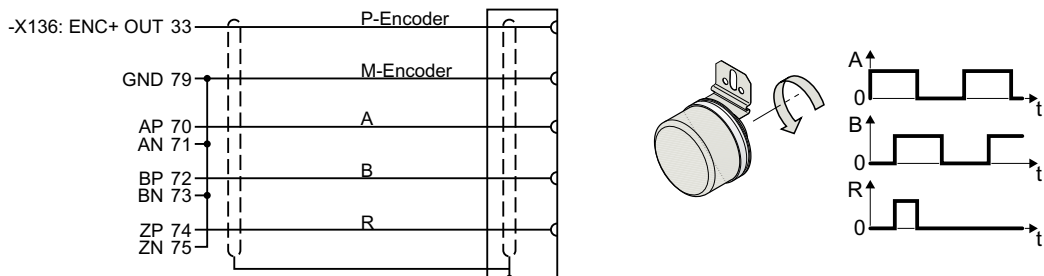

Figure 4-24 Connecting a unipolar HTL encoder

Connecting a combi encoder

Combi encoders are a combination of SSI encoder with HTL encoder in one enclosure. You require a Y encoder cable to connect a combi encoder to the inverter.

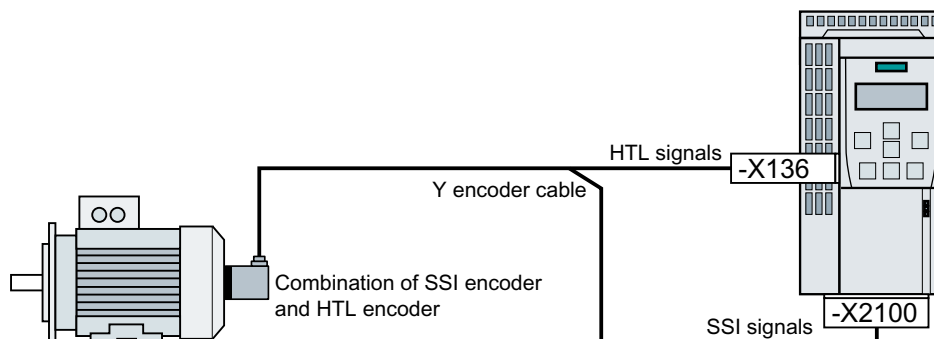



Figure 4-25 Connecting a combi encoder to a CU250S-2 Control Unit

The matching Y encoder cable can be ordered from the KnorrTec company.

Article No. 10051910

Additional information on installing and configuration a combi encoder is available in the Internet:

 Connecting and commissioning a combi encoder (<https://support.industry.siemens.com/cs/en/en/view/109748046>)

SMC and SME Sensor Modules

Table 4-20 Permissible SMC/SME Sensor Modules and encoders that can be connected

	SMC10	SMC20	SMC30	SME20	SME25
Two-pole resolver	✓				
Multi-pole resolver	✓				
sin/cos encoder 1 V _{pp}		✓			
sin/cos encoder 1 V _{pp} without rotor position track (C and D tracks)				✓	
SSI encoders with incremental signals sin/cos 1 V _{pp}		✓			✓
SSI encoders with TTL/HTL incremental signals			✓		
SSI encoder without incremental signals			✓		
HTL or TTL encoder			✓		
Absolute encoders Endat 2.1		✓			✓

You can find information about prefabricated encoder cables for the Sensor Module in the Internet:

 Encoder cables (<https://support.industry.siemens.com/cs/de/en/view/108441438>)

You can find additional information on installing and connecting the Sensor Modules in the "SINAMICS S120 Control Units and supplementary system components" manual.

 S120 system components (<http://support.automation.siemens.com/WW/view/en/68040800>)

Commissioning

5.1 Commissioning guidelines

Overview

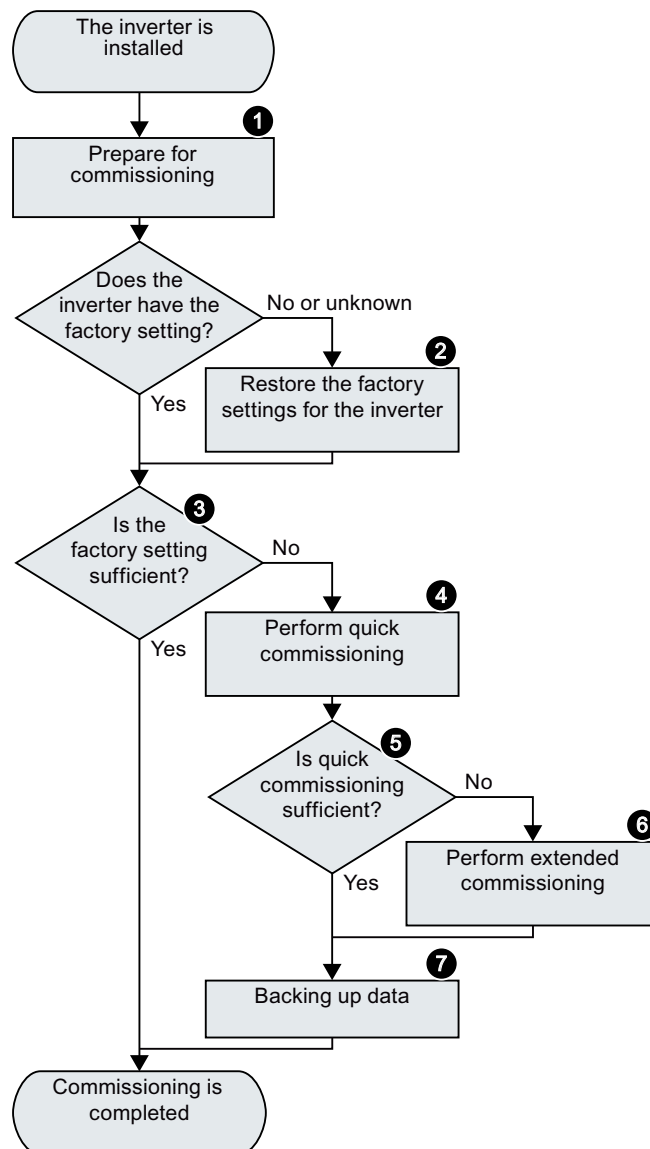

1. Define the requirements to be met by the drive for your application. (Page 127)
2. Restore the factory settings of the inverter if necessary. (Page 152)
3. Check if the factory setting of the inverter is sufficient for your application. (Page 130)
4. Set the following for quick commissioning of the drive:
 - The closed-loop motor control
 - The inputs and outputs
 - The fieldbus interface (Page 134)
5. Check if additional inverter functions are required for the application. (Page 157)
6. If necessary, adapt the drive. (Page 157)
7. Save your settings. (Page 361)

5.2 Tools to commission the inverter

Operator panel

An operator panel is used to commission, troubleshoot and control the inverter, as well as to back up and transfer the inverter settings.



The **Intelligent Operator Panel (IOP-2)** can either be snapped onto an inverter, or is available as handheld device with a connecting cable to the inverter. The graphics-capable plain text display of the IOP-2 enables intuitive inverter operation.

Additional information on the IOP-2 is available in the Internet:

 SINAMICS IOP-2 release for sale (<https://support.industry.siemens.com/cs/ww/en/view/109747625>)



The **Operator Panel BOP-2** for snapping onto the inverter has a two-line display for diagnostics and operating the inverter.

Operating Instructions of the BOP-2 and IOP-2 operator panels:

 Overview of the manuals (Page 519)

PC tools

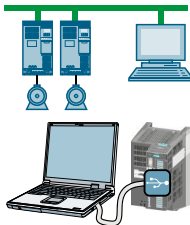

STARTER and **Startdrive** are PC tools that are used to commission, troubleshoot and control the inverter, as well as to back up and transfer the inverter settings. You can connect the PC with the inverter via USB or via the PROFIBUS / PROFINET fieldbus.

Connecting cable (3 m) between PC and inverter: Article number 6SL3255-0AA00-2CA0

 STARTER DVD: Article number 6SL3072-0AA00-0AG0

 Startdrive DVD: Article number 6SL3072-4CA02-1XG0

 Startdrive, system requirements and download (<https://support.industry.siemens.com/cs/ww/en/view/109752254>)

 STARTER, system requirements and download (<http://support.automation.siemens.com/WW/view/en/26233208>)

 Startdrive tutorial (<http://support.automation.siemens.com/WW/view/en/73598459>)

 STARTER videos (<http://www.automation.siemens.com/mcms/mc-drives/en/low-voltage-inverter/sinamics-g120/videos/Pages/videos.aspx>)

5.3 Preparing for commissioning

5.3.1 Collecting motor data

Data for a standard induction motor

Before starting commissioning, you must know the following data:

- **Which motor is connected to the inverter?**
Note down the Article No. of the motor and the motor's nameplate data.
If available, note down the motor code on the motor's nameplate.

Article No.

SIEMENS		IE3 H CE						
Made in Czech Rep.								
3-Mot. 1AV3094A		1LE10430EA422AA0-Z UD 1410/1410842-001-001						
IEC/EN 60034 90L		IMB3 IP55						
20kg		Th.Cl.155(F) -20°C<=TAMB<=40°C						
Bearing								
DE 6205-2ZC3		NE 6004-2ZC3						
IEC		Code						
IEC								
NEMA								
NEMA								
V	Hz	A	kW	cos φ	NOM.EFF	1/min	IE-CL	
230 Δ	50	7.3	2.20	0.88	85.9	2910	IE3	
400 Y	50	4.20	2.20	0.88	85.9	2910	IE3	
460 Y	60	4.20	2.55	0.88	86.5	3510	IE3	
460 Y	60	3.65	2.20	0.87	86.5	3530	IE3	

Voltage Current Power Speed

Figure 5-1 Example of the rating plate for a standard induction motor

- **In which region of the world is the motor to be used?**
 - Europe IEC: 50 Hz [kW]
 - North America NEMA: 60 Hz [hp] or 60 Hz [kW]
- **How is the motor connected?**
Pay attention to the connection of the motor (star connection [Y] or delta connection [Δ]).
Note the appropriate motor data for connecting.

5.3.2 Forming DC link capacitors

Description

You may have to reform the DC link capacitors if the power module has been stored for more than one year. When the converter is operational, DC link capacitors that have not been formed can be damaged.

Table 5-1 The forming duration depends on how long the inverter was stored for

Storage time from the date of manufacture	Recommended forming duration
1 – 2 years	1 hour
2 – 3 years	2 hours
>3 years	8 hours

The production date of the power module is coded in the 3rd and 4th digit of the serial number on the rating plate: "S X -- ③ ④ X X X..."

Table 5-2 Production year and month

Digit ③	Year of manufacture	Digit ④	Month of manufacture
D	2013	1 ... 9	January ... September
E	2014	O	October
F	2015	N	November
H	2016	D	December
J	2017		
K	2018		
L	2019		
M	2020		

Forming the DC link of PM240-2 and PM240P-2 Power Modules

You form the DC link capacitors by supplying the inverter with a line voltage of $\leq 100\%$ of the rated voltage for a defined time.

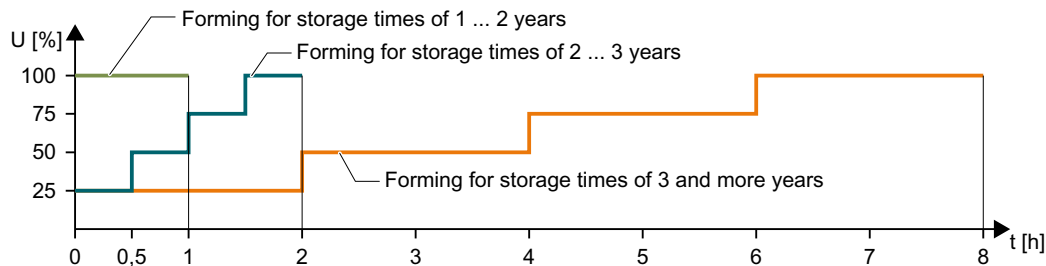

Figure 5-2 Forming the DC-link capacitors

Form DC Link of other power modules

Formation of the DC link capacitors is not required for the following power modules even after a lengthy period of storage.

- PM230
- PM250

5.3.3 Inverter factory setting

Motor

With its factory settings, the inverter is set up for an induction motor suitable for the power rating of the Power Module.

Inverter interfaces

The inputs and outputs and the fieldbus interface of the inverter have specific functions when set to the factory settings.

 Factory interface settings (Page 96)

Switching the motor on and off

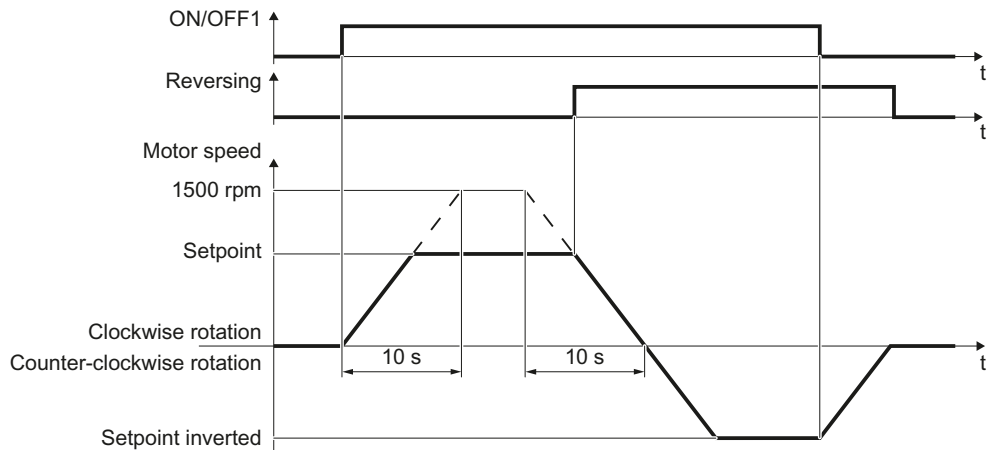

Figure 5-3 Switching on and switching off the motor and reversing in the factory setting

The inverter is set in the factory as follows:

- After the ON command, the motor accelerates with a ramp-up time of 10 s (referred to 1500 rpm) to its speed setpoint.
- After the OFF1 command, the motor brakes down to standstill with 10 s ramp-down time.
- The motor direction of rotation reverses with the reversing command.

The ramp-up and ramp-down times define the maximum motor acceleration when the speed setpoint changes. The ramp-up and ramp-down time is derived from the time between motor standstill and the maximum speed, or between the maximum speed and motor standstill.

Switching the motor on and off in the jog mode

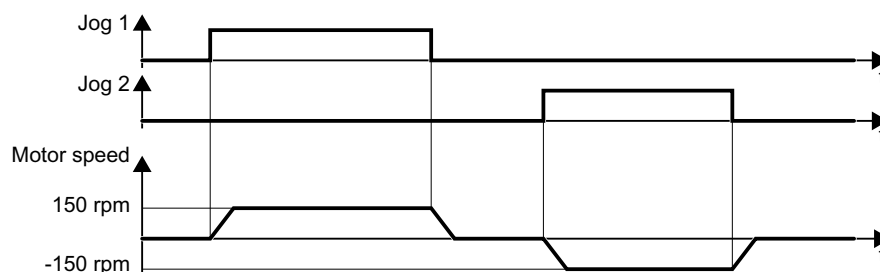

Figure 5-4 Jogging the motor with the factory settings

In the case of inverters with a PROFIBUS or PROFINET interface, operation can be switched via digital input DI 3. The motor is either switched on and off via PROFIBUS – or operated in jog mode via its digital inputs.

When a control command is received at the respective digital input, the motor rotates at ± 150 rpm. The same ramp-up and ramp-down times as described above apply.

Minimum and maximum speed

- Minimum speed - factory setting 0 [rpm]
The minimum speed is the lowest speed of the motor independent of the speed setpoint. A minimum speed > 0 is, for example, useful for fans or pumps.
- Maximum speed - factory setting 1500 [rpm]
The inverter limits the motor speed to the maximum speed.

Operate the inverter with the factory setting

We recommend that you execute quick commissioning. For quick commissioning, you must adapt the inverter to the connected motor by setting the motor data in the inverter.

In basic applications with a standard induction motor, you can attempt to operate the drive with a rated power of < 18.5 kW without carry out an additional commissioning steps. Check whether the control quality of the drive without commissioning is adequate for the requirements of the application.

5.3.4 Inverter function modules

Function modules

Not all of the inverter functions are enabled in the factory setting. For instance, you must enable the "Encoder" function, so that the inverter can evaluate an encoder signal.

A function module is a set of inverter functions that can be released or inhibited all together.

You configure the following function modules in the quick commissioning:

- Fieldbus interface
- DRIVE-CLiQ interface
- Technology controller
- Basic positioner
- Evaluating encoders
- Extended messages
 Extended messages (Page 242)
- Extended setpoint channel, e.g. motorized potentiometer and fixed setpoints
- Free function blocks

You configure the following function modules when commissioning your drive:

- You monitor the motor speed using the Extended safety functions.
- The extended ramp-function generator allows the motor to be accelerated and braked smoothly without any jerk.

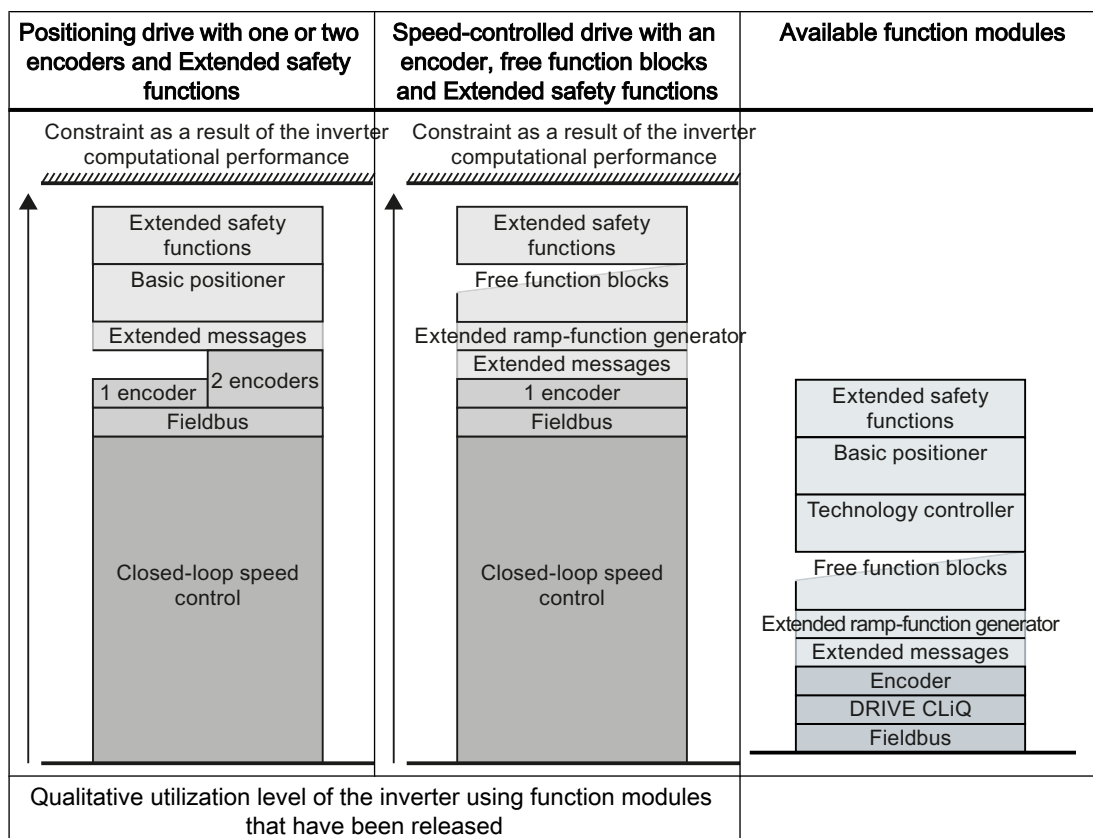

The computational performance of the inverter is designed for typical inverter applications.

Every configured function module uses part of the computational performance of the inverter. If you enable all of the inverter function modules, then the inverter responds with a fault, because its available computational performance is exceeded.

Only configure function modules that you actually require for your particular application.

Further information is provided on the Internet:

 FAQ combination of functions (<http://support.automation.siemens.com/WW/view/en/90157463>)

5.4 Quick commissioning with a PC

The screen forms that are shown in this manual show generally valid examples. The number of setting options available in screen forms depends on the particular inverter type.

5.4.1 Creating a project

Creating a new project

Procedure

1. Start the Startdrive commissioning software.
2. In the menu, select "Project" → "New...".
3. Specify a name of your choice for the project.

You have created a new project.



5.4.2 Transfer inverters connected via USB into the project

Integrating the inverter into the project

Procedure

1. Switch on the inverter power supply.
2. First insert a USB cable into your PC and then into the inverter.
3. The PC operating system installs the USB driver when you are connecting the inverter and PC together for the first time.
4. Press the "Accessible nodes" button.

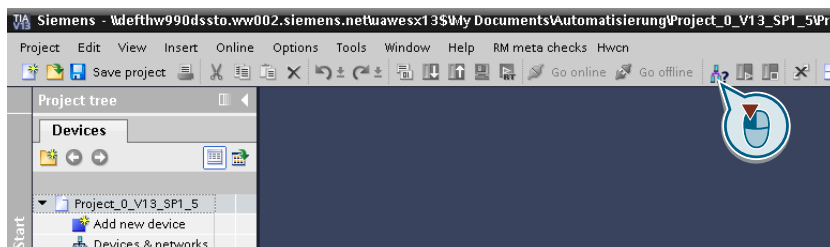

5. When the USB interface is appropriately set, then the "Accessible nodes" screen form shows the inverters that can be accessed.

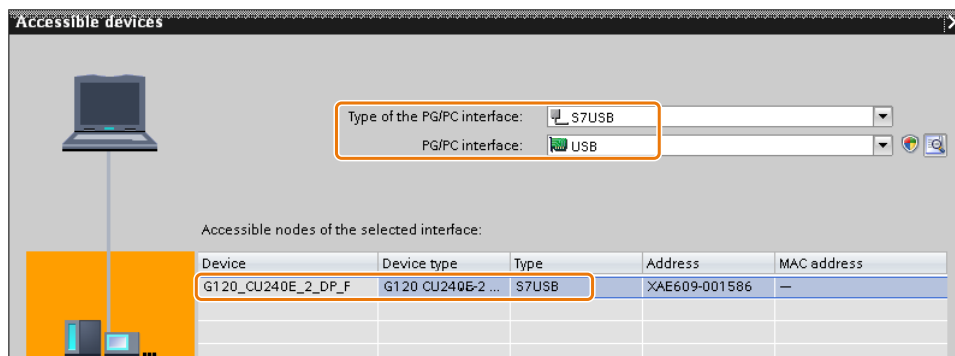

If you have not correctly set the USB interface, then the following "No additional nodes found" message is displayed. In this case, follow the description below.

6. Transfer the inverter into the project using the menu: "Online - Upload device as new station (hardware and software)".

You have transferred an inverter accessible via the USB interface into your project.

□

5.4.3 Starting wizards for the quick commissioning

Starting commissioning wizards

Procedure

1. In the project, select the drive you wish to commission.
2. Press the following buttons:

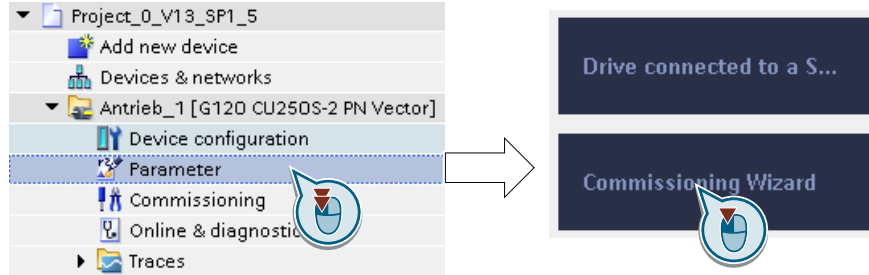

You have started the commissioning wizard.



Select the application class

Procedure

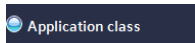

When selecting an application class, the inverter assigns the motor control with the appropriate default settings:

- [1] Standard Drive Control (Page 139)
- [2] Dynamic Drive Control (Page 141)
- [0] Expert - or if no application class is listed:
 Expert (Page 143)

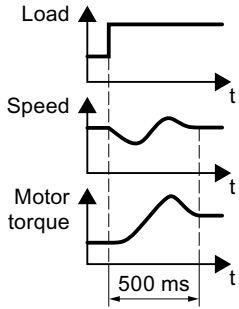
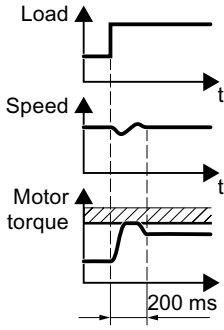
Application class	Standard Drive Control	Dynamic Drive Control without encoder	Dynamic Drive Control with encoder
Properties of the closed-loop speed control	<ul style="list-style-type: none"> • Typical correction time after a speed change: 100 ms ... 200 ms • Typical settling time after a load surge: 500 ms  <ul style="list-style-type: none"> • "Standard Drive Control" is suitable to address the following requirements: <ul style="list-style-type: none"> – Motor power ratings < 45 kW – Ramp-up time 0 → rated speed (depending on the motor power rating): 1 s (0.1 kW) ... 10 s (45 kW) – Applications with increasing load torque without load surges • "Standard Drive Control" is insensitive with respect to imprecise setting of the motor data 	<ul style="list-style-type: none"> • Typical settling time after a speed change: < 100 ms • Typical settling time after a load surge: 200 ms  <ul style="list-style-type: none"> • "Dynamic Drive Control" controls and limits the motor torque • We recommend "Dynamic Drive Control" for the following applications: <ul style="list-style-type: none"> – Motor power ratings > 11 kW – For load surges 10 % ... >100 % of the rated motor torque • "Dynamic Drive Control" is necessary for a ramp-up time 0 → rated speed (dependent on the rated motor power): < 1 s (0.1 kW) ... < 10 s (250 kW). 	<ul style="list-style-type: none"> • Torque accuracy that can be achieved: ± 5% for 15% ... 100% of the rated speed • The control extends the torque accuracy of ± 5 % to speeds < 15 % of the rated speed.
Application examples	<ul style="list-style-type: none"> • Pumps, fans and compressors with flow characteristic • Wet or dry blasting technology • Mills, mixers, kneaders, crushers, agitators • Horizontal conveyor technology (conveyor belts, roller conveyors, chain conveyors) • Basic spindles 	<ul style="list-style-type: none"> • Pumps and compressors with displacement machines • Rotary furnaces • Extruder • Centrifuges 	
Motors that can be operated	Induction motors	Induction and synchronous motors	
Power Modules that can be operated	PM240-2		
Max. output frequency	550 Hz	240 Hz	

5.4 Quick commissioning with a PC

Application class	Standard Drive Control	Dynamic Drive Control without encoder	Dynamic Drive Control with encoder
Torque control	Without torque control	Speed control with lower-level torque control	
Position control	Without position control	<ul style="list-style-type: none"> Positioning cycles using the "Basic positioner" function > approx. 500ms Memory card with "Basic positioner" license required 	
		<ul style="list-style-type: none"> The "Travel to fixed stop" function is not possible. 	<ul style="list-style-type: none"> No restrictions regarding the functions of the basic positioner
Commissioning the closed-loop speed control	<ul style="list-style-type: none"> Unlike "Dynamic Drive Control," no speed controller needs to be set When compared to "Expert": <ul style="list-style-type: none"> Simplified commissioning using predefined motor data Reduced number of parameters "Standard Drive Control" is preset for Power Modules, frame size A ... frame size C 	<ul style="list-style-type: none"> Reduced amount of parameters when compared to "Expert" "Dynamic Drive Control" is preset for Power Modules, frame size D ... frame size F 	

5.4.4 Standard Drive Control

Procedure for application class [1]: Standard Drive Control

Setpoint specification

The wizard only displays the "setpoint input" if you configured an inverter with PROFINET or PROFIBUS interface.

Select whether the inverter is connected to a higher-level control via the fieldbus.

Select whether the ramp-function generator for the speed setpoint is implemented in the higher-level control or in the inverter.

Further functions

Select the required function modules for your application.

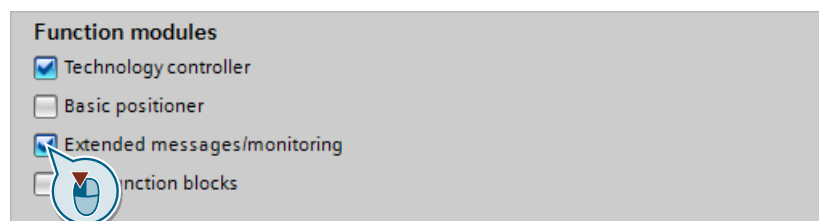

 Inverter function modules (Page 132)

Defaults of the setpoi...

Select the I/O configuration to preassign the inverter interfaces.

 Factory interface settings (Page 96)

 Default setting of the interfaces (Page 98)

Drive setting

Set the applicable motor standard and the inverter supply voltage.

Drive options

If an optional component is installed between inverter and motor, the corresponding setting must be performed.

If a braking resistor is installed, you set the maximum braking power to which the braking resistor will be subjected.

Motor

Select your motor.

If you use Startdrive, then this commissioning step is included in Step 5.

Enter the motor data according to the rating plate of your motor.

If you have selected a motor based on its article number, the data has already been entered.

Motor holding brake

Define whether the inverter actuates a motor holding brake.

Important parameters

Set the most important parameters to suit your application.

Drive functions

Select the technological application:

- [0] Constant load: Typical applications include conveyor drives
- [1] Speed-dependent load: Typical applications include pumps and fans

Motor identification (not all the following settings may be visible in Startdrive):

- [0]: No motor data identification
- [2]: Recommended setting. Measure the motor data at standstill. The inverter switches off the motor after the motor data identification has been completed.
Select this setting if the motor cannot freely rotate, e.g. for a mechanically limited traversing range.
- [12]: The same setting as [2]. The motor accelerates to the currently set setpoint after the motor data identification.

Encoders

If you selected the "Basic positioner" function module, you must configure the encoder:

 [Configuring encoders \(Page 147\)](#)

If you did not selected the "Basic positioner" function module, close the commissioning wizard:

Summary

Set the check mark for "RAM data to EEPROM (save data in the drive)" to save your data in the inverter so that it is not lost if the power fails.

Press the "Finish" button.

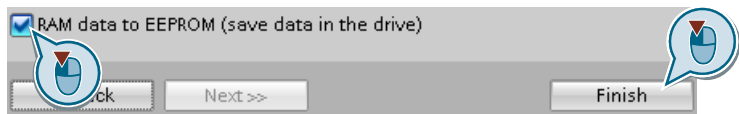

You have entered all of the data that is necessary for the quick commissioning of the inverter.

□

5.4.5 Dynamic Drive Control

Procedure for application class [2]: Dynamic Drive Control

Setpoint specification

The wizard only displays the "setpoint input" if you configured an inverter with PROFINET or PROFIBUS interface.

Select whether the inverter is connected to a higher-level control via the fieldbus.

Select whether the ramp-function generator for the speed setpoint is implemented in the higher-level control or in the inverter.

Further functions

Select the required function modules for your application.

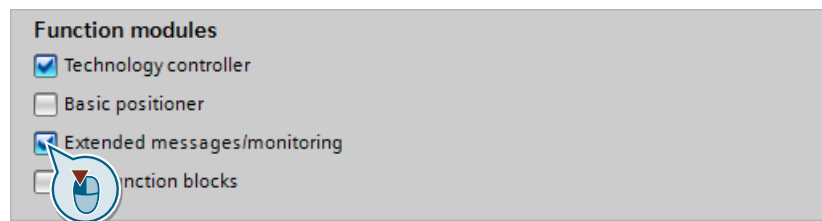

 Inverter function modules (Page 132)

Defaults of the setpoi...

Select the I/O configuration to preassign the inverter interfaces.

 Default setting of the interfaces (Page 98)

 Factory interface settings (Page 96)

Drive setting

Set the applicable motor standard and the inverter supply voltage.

Drive options

If an optional component is installed between inverter and motor, the corresponding setting must be performed.

If a braking resistor is installed, you set the maximum braking power to which the braking resistor will be subjected.

Motor

Select your motor.

If you use Startdrive, then this commissioning step is included in Step 5.

Enter the motor data according to the rating plate of your motor.

If you have selected a motor based on its article number, the data has already been entered.

Motor holding brake

Define whether the inverter actuates a motor holding brake.

Important parameters

Set the most important parameters to suit your application.

Drive functions

Technological use:

- [0]: Recommended setting in all applications with speed encoder. For standard applications.
- [1]: Applications with short ramp-up and ramp-down times.
- [5] Recommended setting for applications without encoder with high break loose torque.

Motor identification:

- [1]: Recommended setting. Measure the motor data at standstill and with the motor rotating. The inverter switches off the motor after the motor data identification has been completed.
- [2]: Measure the motor data at standstill. The inverter switches off the motor after the motor data identification has been completed.
Select this setting if the motor cannot freely rotate, e.g. for a mechanically limited traversing range.
- [3]: Measure the motor data while the motor is rotating. The inverter switches off the motor after the motor data identification has been completed.
- [11]: The same setting as [1]. The motor accelerates to the currently set setpoint after the motor data identification.
- [12]: The same setting as [2]. The motor accelerates to the currently set setpoint after the motor data identification.



 [Configuring encoders \(Page 147\)](#)

5.4.6 Expert

Procedure without application class or for the application class [0]: Expert

Setpoint specification

The wizard only displays the "setpoint input" if you configured an inverter with PROFINET or PROFIBUS interface.

Select whether the inverter is connected to a higher-level control via the fieldbus.

Select whether the ramp-function generator for the speed setpoint is implemented in the higher-level control or in the inverter.

Open-loop/closed-loop ...

Select the required function modules for your application.

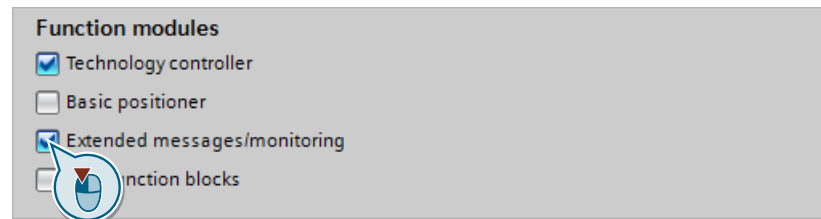

 Inverter function modules (Page 132)

Select the control mode.

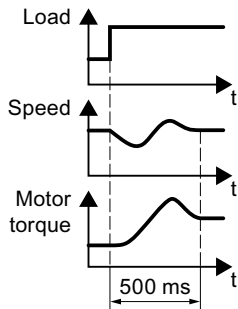
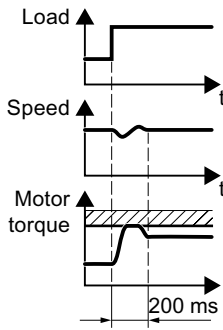
Control mode	U/f control or flux current control (FCC)	Vector control without an encoder	Vector control with an encoder
Properties	<ul style="list-style-type: none"> • Responds to speed changes with a typical settling time of 100 ms ... 200 ms • Responds to load surges with a typical settling time of 500 ms  <ul style="list-style-type: none"> • U/f and FCC are suitable for the following cases: <ul style="list-style-type: none"> – For ramp-up times 0 → rated speed > 2 s – For applications with increasing load torque without load surges • The closed-loop control is insensitive to inaccurate motor data settings, e.g. the motor temperature 	<ul style="list-style-type: none"> • The vector control responds to speed changes with a typical settling time of < 100 ms. • The vector control responds to load surges with a typical settling time of 200 ms  <ul style="list-style-type: none"> • Vector control is required in the following cases: <ul style="list-style-type: none"> – For ramp-up times 0 → rated speed < 2 s – For applications with fast and high load impulses 	
		<ul style="list-style-type: none"> • Torque accuracy that can be achieved: ± 5% for 15 % ... 100 % of the rated speed 	<ul style="list-style-type: none"> • The control extends the torque accuracy of ± 5 %, also for speeds < 15 % of the rated speed.
Application examples	<ul style="list-style-type: none"> • Pumps, fans, and compressors with flow characteristic • Wet or dry blasting technology • Mills, mixers, kneaders, crushers, agitators • Horizontal conveyor technology (conveyor belts, roller conveyors, chain conveyors) • Basic spindles 	<ul style="list-style-type: none"> • Pumps and compressors with displacement machines • Rotary furnaces • Extruder • Centrifuges 	<ul style="list-style-type: none"> • Vertical conveyor technology (conveyor belts, roller conveyors, chain conveyors) • Escalators/moving stairways • Lifter/lowerer • Elevators • Gantry cranes • Cable railways • Stacker cranes
Motors that can be operated	Induction motors	Induction and synchronous motors	
Power Modules that can be operated	No restrictions		
Max. output frequency	550 Hz	240 Hz	
Torque control	Without torque control	Speed control with lower-level torque control	

Control mode	U/f control or flux current control (FCC)	Vector control without an encoder	Vector control with an encoder
Position control	Without position control	<ul style="list-style-type: none"> Positioning cycles using the "Basic positioner" function > approx. 500ms Memory card with "Basic positioner" license required 	
		<ul style="list-style-type: none"> The "Travel to fixed stop" function is not possible. 	<ul style="list-style-type: none"> No restrictions regarding the functions of the basic positioner
Commissioning	<ul style="list-style-type: none"> Unlike "Dynamic Drive Control," no speed controller needs to be set When compared to "Expert": <ul style="list-style-type: none"> Simplified commissioning using predefined motor data Reduced number of parameters 	<ul style="list-style-type: none"> Fewer parameters when compared to "Configuration for experts" 	

Defaults of the setpol...

Select the I/O configuration to preassign the inverter interfaces.



Factory interface settings (Page 96)



Default setting of the interfaces (Page 98)

Drive setting

Set the applicable motor standard and the inverter supply voltage.

Select the application for the inverter:

- "[0] Load cycle with high overload for applications requiring a high dynamic performance, e.g. conveyor systems.
- "[1] Load cycle with low overload ..." for applications that do not require a high dynamic performance, e.g. pumps or fans.
- [6], [7]: Load cycles for applications with encoderless 1FK7 synchronous motors.

Drive options

If an optional component is installed between inverter and motor, the corresponding setting must be performed.

If a braking resistor is installed, you set the maximum braking power to which the braking resistor will be subjected.

Motor

Select your motor.

Enter the motor data according to the rating plate of your motor.

If you have selected a motor based on its article number, the data has already been entered.

Motor holding brake

Define whether the inverter actuates a motor holding brake.

Important parameters

Set the most important parameters to suit your application.

Drive functions

Technological use:

- [0]: In all applications that do not fall under [1] ... [3]
- [1]: Applications involving pumps and fans
- [2]: Applications with short ramp-up and ramp-down times. However, this setting is not suitable for hoisting gear and cranes/lifting gear.

- [3]: Setting only for steady-state operation with slow speed changes. We recommend setting [1] if load surges in operation cannot be ruled out.
- [5]: Applications with high breakaway torque

Motor identification:

- [1]: Recommended setting. Measure the motor data at standstill and with the motor rotating. The inverter switches off the motor after the motor data identification has been completed.
- [2]: Measure the motor data at standstill. The inverter switches off the motor after the motor data identification has been completed.

Recommended setting for the following cases:

- You have selected "Speed control" as control mode, however the motor cannot freely rotate, e.g. for mechanically limited traversing sections.
- You have set "V/f control" as control mode.
- [3]: Measure the motor data while the motor is rotating. The inverter switches off the motor after the motor data identification has been completed.
- [11]: The same setting as [1]. The motor accelerates to the currently set setpoint after the motor data identification.
- [12]: The same setting as [2]. The motor accelerates to the currently set setpoint after the motor data identification.

Calculating the motor parameters: Select "Complete calculation".



Configuring encoders (Page 147)

5.4.7 Configuring encoders

Encoders

Set the following:

- Select whether the inverter evaluates one or two encoders.
- Select the interface via which the inverter evaluates the encoder.
- Select a standard encoder from the list of encoder types.
 - Code number < 1000: Encoders with integrated DRIVE-CLiQ
 - 100x: Resolvers with different pole pair numbers
 - 2xxx: sin/cos encoder
 - 3xxx: HTL/TTL encoders and SSI encoders

If you cannot find your encoder in the list, then initially select the closest possible encoder type. Continue the configuration, and then adapt the encoder data.



Adapting the encoder data (Page 148)

Measuring system

The commissioning step is only visible if you selected the "Basic positioner" function module.

Select the encoder that you use for position sensing.

Mechanical system

The commissioning step is only visible if you selected the "Basic positioner" function module.

Initially, you can skip the commissioning step. The settings are explained in the context of commissioning the basic positioner in the "Basic positioner" function manual.



Overview of the manuals (Page 519)

Summary

Set the check mark for "RAM data to EEPROM (save data in the drive)" to save your data in the inverter so that it is not lost if the power fails.

Press the "Finish" button.

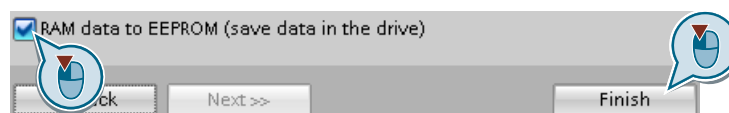

You have entered all of the data that is necessary for the quick commissioning of your inverter.



5.4.8 Adapting the encoder data

Preconditions

- You have selected an encoder type that does not precisely match your encoder, because it is not included in the list of default encoder types.
- You have completely configured the drive.

Procedure

1. Select the "Motor encoder" screen form.
2. Select the "Encoder data" button.

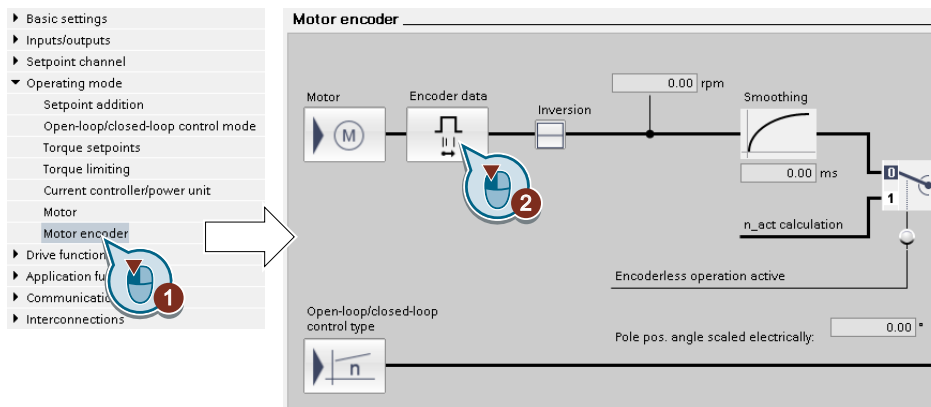

3. You have access to the following settings in the "Encoder data" screen form:
 - You can change all of the encoder data.
 - You can select another encoder type. Startdrive only lists the encoder types that are permitted for the configured interface.

If you wish to set another encoder interface, you must restart the commissioning Wizard.

You have adapted the encoder data.



 Setting an absolute encoder (Page 507)

5.4.9 Loading the settings into the inverter

Procedure

1. Select your drive.
2. Press the "Load to device" button. 
3. In the following screen form, select "Back up parameter assignment in the EEPROM".
4. Load your settings into the inverter.
5. Wait until loading has been completed.

You have loaded your settings to the inverter.

5.4.10 Identify motor data

Overview

Using the motor data identification, the inverter measures the data of the stationary motor. In addition, based on the response of the rotating motor, the inverter can determine a suitable setting for the vector control.

To start the motor data identification routine, you must switch on the motor.

Identifying the motor data and optimizing the closed-loop control

Preconditions

- You have selected a method of motor data identification during quick commissioning, e.g. measurement of the motor data while the motor is stationary.
When quick commissioning is complete, the inverter issues alarm A07991.
- The motor has cooled down to the ambient temperature.
An excessively high motor temperature falsifies the motor data identification results.
- The PC and inverter are connected to each other online.

⚠ WARNING

Unexpected machine motion while the motor data identification is in progress

For the stationary measurement, the motor can make several rotations. The rotating measurement accelerates the motor up to the rated speed. Secure dangerous machine parts before starting motor data identification:

- Before switching on, ensure that nobody is working on the machine or located within its working area.
- Secure the machine's work area against unintended access.
- Lower suspended loads to the floor.

Procedure

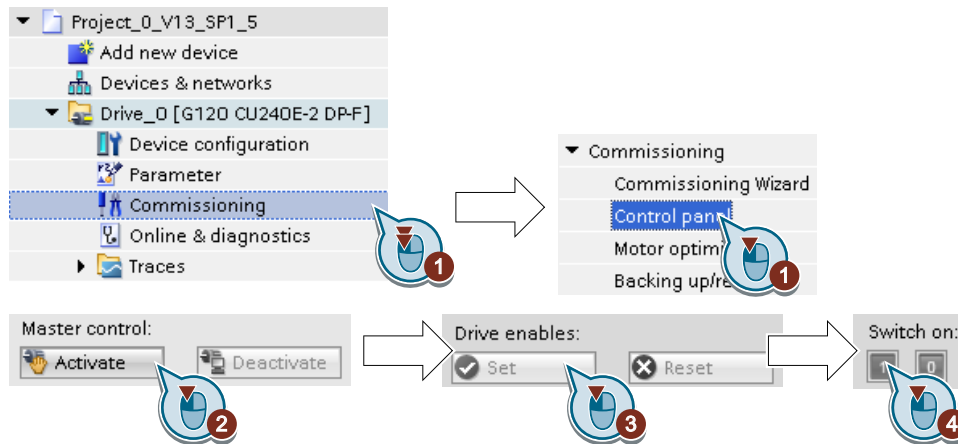

1. Open the control panel.
2. Assume master control for the inverter.
3. Set the "Drive enables"
4. Switch on the motor.
The inverter starts the motor data identification. This measurement can take several minutes.
Depending on the setting, after motor data identification has been completed, the inverter switches off the motor - or it accelerates it to the currently set setpoint.
5. If required, switch off the motor.
6. Relinquish the master control after the motor data identification.
7. Save the settings in the inverter (RAM → EEPROM):



You have completed the motor data identification.

□

Self-optimization of the speed control

If you have not only selected motor data identification with the motor stationary, but also rotating measurement with self-optimization of the speed control, you must switch on the motor again as described above and wait for the optimization run to finish.

Quick commissioning has been completed once the motor data identification has been successfully completed.

5.5 Restoring the factory setting

When must you reset the inverter to the factory settings?

Reset the inverter to the factory settings in the following cases:

- The line voltage was interrupted during commissioning and you were not able to complete commissioning.
- You can no longer trace the settings that you made during commissioning.
- You do not know whether the inverter was already operational.

Restoring the factory settings when the safety functions are enabled

If you are using the integrated safety functions of the inverter, e.g. "Safe Torque Off", you must reset the safety functions separately from the remaining inverter settings.

The settings of the safety functions are protected by a password.

Settings that are not changed when restoring the factory setting

The communication settings and the settings of the motor standard (IEC/NEMA) are kept when restoring the factory setting.

5.5.1 Resetting the safety functions to the factory setting

Procedure

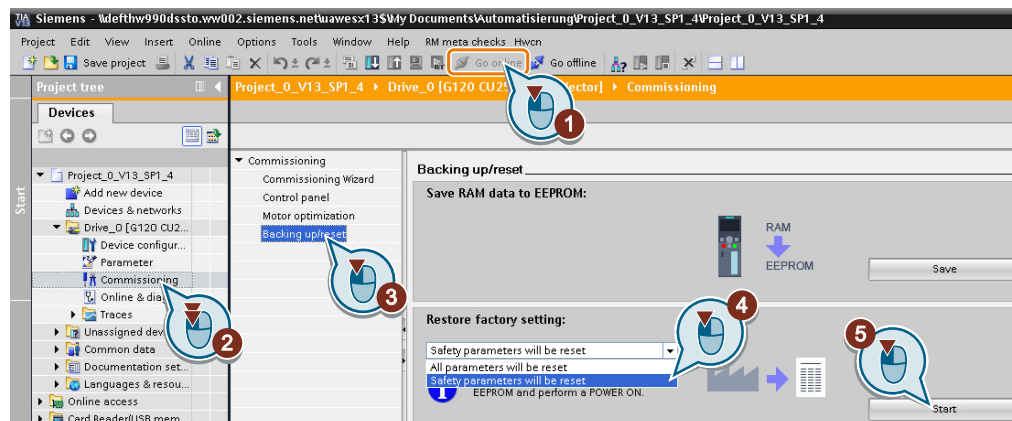

1. Go online.
2. Select "Commissioning".
3. Select "Backing up/reset".
4. Select "Safety parameters are reset".
5. Press the "Start" button.
6. Enter the password for the safety functions.
7. Confirm that the parameters have been saved (RAM to ROM).
8. Go offline.
9. Switch off the inverter power supply.
10. Wait until all LEDs on the inverter are dark.
11. Switch on the inverter power supply again.

You have restored the safety functions in the inverter to the factory settings.



Exception: The password for the safety functions is not reset.



Safety functions password (Page 246)

Procedure with an operator panel

1. Set p0010 = 30
Activate reset settings.
2. p9761 = ...
Enter the password for the safety functions
3. Start the reset with p0970 = 5.
4. Wait until the inverter sets p0970 = 0.
5. Set p0971 = 1.
6. Wait until the inverter sets p0971 = 0.

5.5 Restoring the factory setting

7. Switch off the inverter power supply.
8. Wait until all LEDs on the inverter are dark.
9. Switch on the inverter power supply again.

You have restored the safety function settings of your inverter to the factory settings.



5.5.2 Restore the factory settings (without safety functions)

Restore the factory inverter settings

Procedure with Startdrive

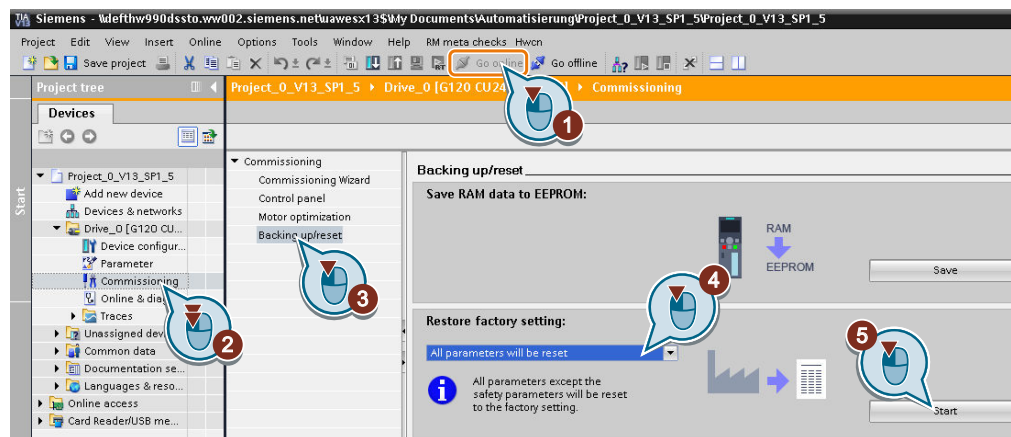

1. Go online.
2. Select "Commissioning".
3. Select "Backing up/reset".
4. Select "All parameters are reset".
5. Press the "Start" button.
6. Wait until the inverter has been reset to the factory setting.

You have reset the inverter to the factory settings.



Procedure with the BOP-2 operator panel

1. In the "Options" menu, select the "DRVRESET" entry
2. Confirm the reset using the OK key.
3. Wait until the inverter has been reset to the factory setting.

You have reset the inverter to the factory settings.



Advanced commissioning

6.1 Overview of the converter functions

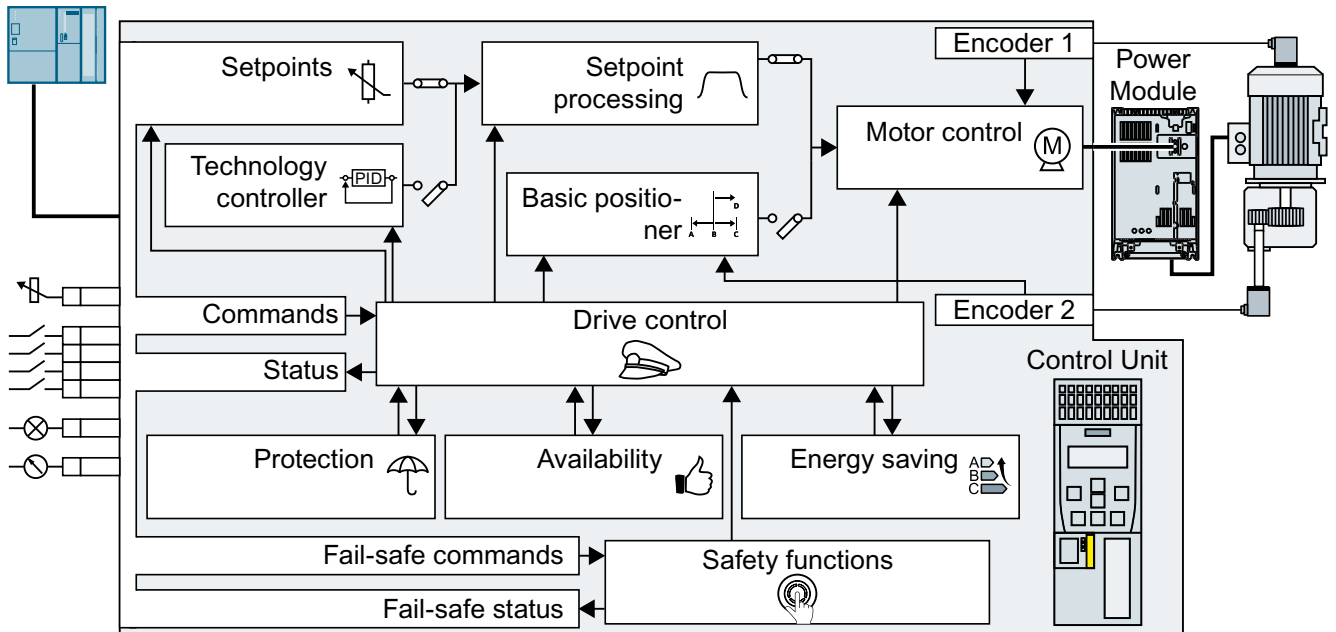

Drive control



The inverter receives its commands from the higher-level control via the terminal strip or the fieldbus interface of the Control Unit. The drive control defines how the inverter responds to the commands.

- Sequence control when switching the motor on and off (Page 161)
- Adapt the default setting of the terminal strip (Page 164)
- Controlling clockwise and counter-clockwise rotation via digital inputs (Page 177)
- Drive control via PROFIBUS or PROFINET (Page 183)
- Drive control via Modbus RTU (Page 206)
- Drive control via USS (Page 209)
- Drive control via Ethernet/IP (Page 212)
- Drive control via CANopen (Page 213)
- Jogging (Page 214)
- Limit position control (Page 216)

The inverter can switch between different settings of the drive control.

- Switching over the drive control (command data set) (Page 218)

The inverter provides a motor holding brake control. The motor holding brake holds the motor in position when it is switched off.

 Motor holding brake (Page 220)

The free function blocks permit configurable signal processing within the inverter.

 Free function blocks (Page 224)

You can select in which physical units the inverter represents its associated values.

 Selecting physical units (Page 238)

You can activate additional monitoring functions in the inverter.

 Extended messages (Page 242)

Safety functions



The safety functions fulfill increased requirements regarding the functional safety of the drive.

 Safe Torque Off (STO) safety function (Page 244)

The extended safety functions monitor the drive speed. You require a license to operate the inverter with the extended safety functions.

 Activating licensed functions (Page 492)

The extended safety functions are described in the "Safety Integrated" function manual.

 Overview of the manuals (Page 519)

Setpoints and setpoint conditioning



The setpoint generally determines the motor speed.

 Setpoints (Page 258)



The setpoint processing uses a ramp-function generator to prevent speed steps occurring and to limit the speed to a permissible maximum value.

 Setpoint calculation (Page 273)

Technology controller



The technology controller controls process variables, e.g. pressure, temperature, level or flow. The motor closed-loop control either receives its setpoint from the higher-level control - or from the technology controller.

 PID technology controller (Page 283)

Basic positioner



The basic positioner traverses an axis with position control to a target position.

You require a license to use the basic positioner.

 Activating licensed functions (Page 492)

The basic positioner is described in the "Basic positioner" function manual.

 Overview of the manuals (Page 519)

Motor control



The motor closed-loop control ensures that the motor follows the speed setpoint. You can choose between various control modes.

 Motor control (Page 288)

The inverter has various methods to electrically brake the motor. When electrically braking, the motor develops a torque, which reduces the speed down to standstill.

 Electrically braking the motor (Page 316)

Protection of the drive and the driven load



The protection functions prevent damage to the motor, inverter and driven load.

 Overcurrent protection (Page 326)

 Inverter protection using temperature monitoring (Page 327)

 Motor protection with temperature sensor (Page 330)

 Motor protection by calculating the temperature (Page 333)

 Motor and inverter protection by limiting the voltage (Page 335)

The monitoring of the driven load prevents impermissible operating modes, e.g. dry-running of a pump.

 Monitoring the driven load (Page 337)

Increasing the drive availability



The kinetic buffering converts the kinetic energy of the load into electrical energy to buffer short-term power failures.

 Kinetic buffering (V_{dc} min control) (Page 350)

The "Flying restart" function permits the fault-free switching on of the motor while it is still turning.

 Flying restart – switching on while the motor is running (Page 344)

For active automatic restart, after a power failure, the inverter attempts to automatically restart the motor and to acknowledge any faults that occur.

 Automatic restart (Page 346)

Energy saving



For standard induction motors, the efficiency optimization reduces the motor losses in the partial load range.

 Efficiency optimization (Page 352)

If necessary, the main contactor control disconnects the inverter from the power system and so reduces the inverter losses.

6.1 Overview of the converter functions

 Line contactor control (Page 355)

The inverter calculates how much energy controlled inverter operation saves when compared to mechanical flow control (e.g. throttle).

 Calculating the energy saving for fluid flow machines (Page 357)

6.2 Sequence control when switching the motor on and off

Overview



The sequence control defines the rules for switching the motor on and off.

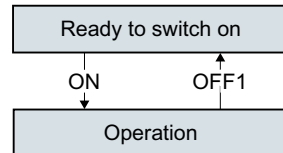

Figure 6-1 Simplified representation of the sequence control

After switching the supply voltage on, the inverter normally goes into the "ready to start" state. In this state, the inverter waits for the command to switch on the motor.

The inverter switches on the motor with the ON command. The inverter changes to the "Operation" state.

After the OFF1 command, the inverter brakes the motor down to standstill. The inverter switches off the motor once standstill has been reached. The inverter is again "ready to start".

Requirement

Functions

In order to be able to respond to external commands, you must set the command interface so that it fits your specific application.

Tools

To change the function settings, you can use an operator panel or a PC tool, for example.

Function description

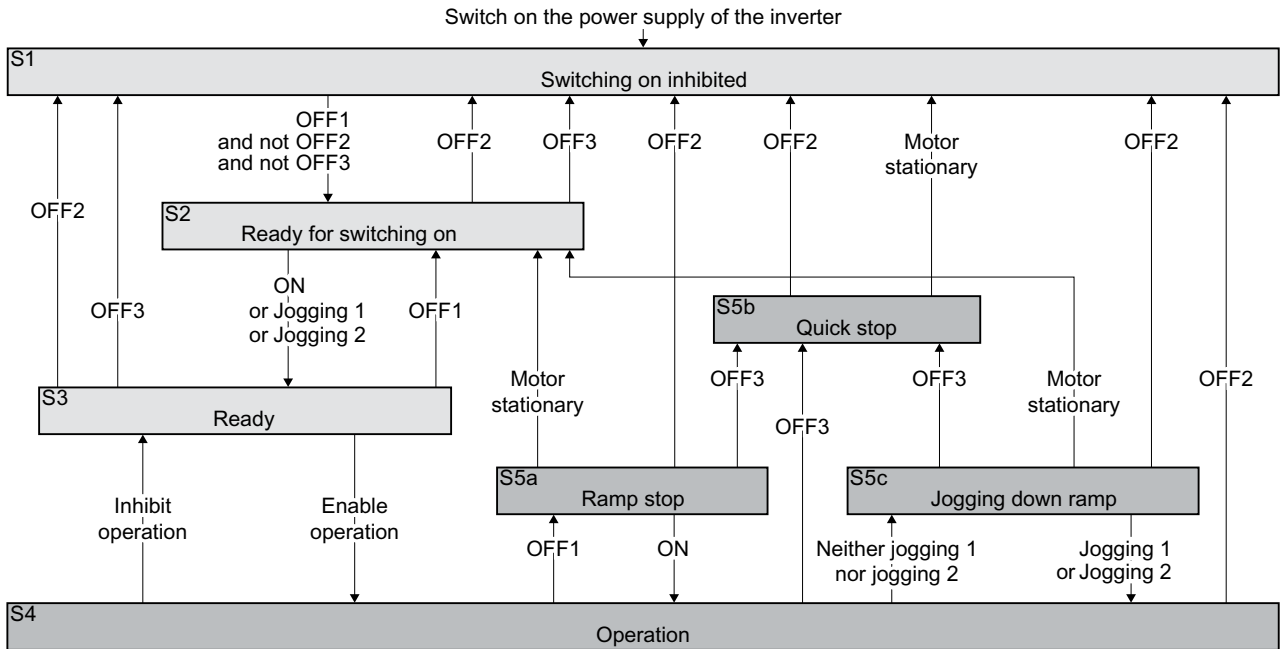

Figure 6-2 Sequence control of the inverter when the motor is switched on and off

Inverter states S1 ... S5c are defined in the PROFIdrive profile. The sequence control defines the transition from one state to another.

Table 6-1 Inverter states

The motor is switched off		The motor is switched on	
Current does not flow in the motor and the motor does not generate any torque		Current flows in the motor and the motor generates a torque	
S1	The inverter waits for a new ON command. The ON command is currently active. You must activate the ON command again in order that the inverter exits the state.	S4	The motor is switched on.
S2	The inverter waits for a new command to switch on the motor.	S5a, S5c	The motor is still switched on. The inverter brakes the motor with the ramp-down time of the ramp-function generator.
S3	The inverter waits for "Enable operation". The "Enable operation" command is always active in the inverter factory setting.	S5b	The motor is still switched on. The inverter brakes the motor with the OFF3 ramp-down time.

Table 6-2 Commands for switching the motor on and off

ON Jogging 1 Jogging 2 Enable operation	The inverter switches the motor on.
OFF1, OFF3	The inverter brakes the motor. The inverter switches off the motor once it comes to a standstill. The motor is considered to be stationary if the speed is less than a defined minimum speed.
OFF2 Inhibit operation	The inverter switches off the motor immediately without first braking it.

Parameter

Parameter	Description	Setting	
p1226	Standstill detection, speed threshold [rpm]	Factory setting: 20.00 rpm	The inverter identifies that the motor is at a standstill after OFF1 or OFF3 when at least one of the following conditions has been satisfied: <ul style="list-style-type: none"> • The speed actual value falls below the threshold in p1226 and the time started in p1228 has expired. • The speed setpoint falls below the threshold in p1226, and the time subsequently started in p1227 has expired.
p1227	Standstill detection monitoring time [s]	Factory setting: 300.00 s	
p1228	Pulse cancellation delay time [s]	Factory setting: 0.01 s	

Further information

You will find additional information in function diagram 2610 of the List Manual.

6.3 Adapt the default setting of the terminal strip



In the inverter, the input and output signals are interconnected with specific inverter functions using special parameters. The following parameters are available to interconnect signals:

- Binectors BI and BO are parameters to interconnect binary signals.
- Connectors CI and CO are parameters to interconnect analog signals.

This chapter describes how you adapt the function of individual inverter inputs and outputs using binectors and connectors.

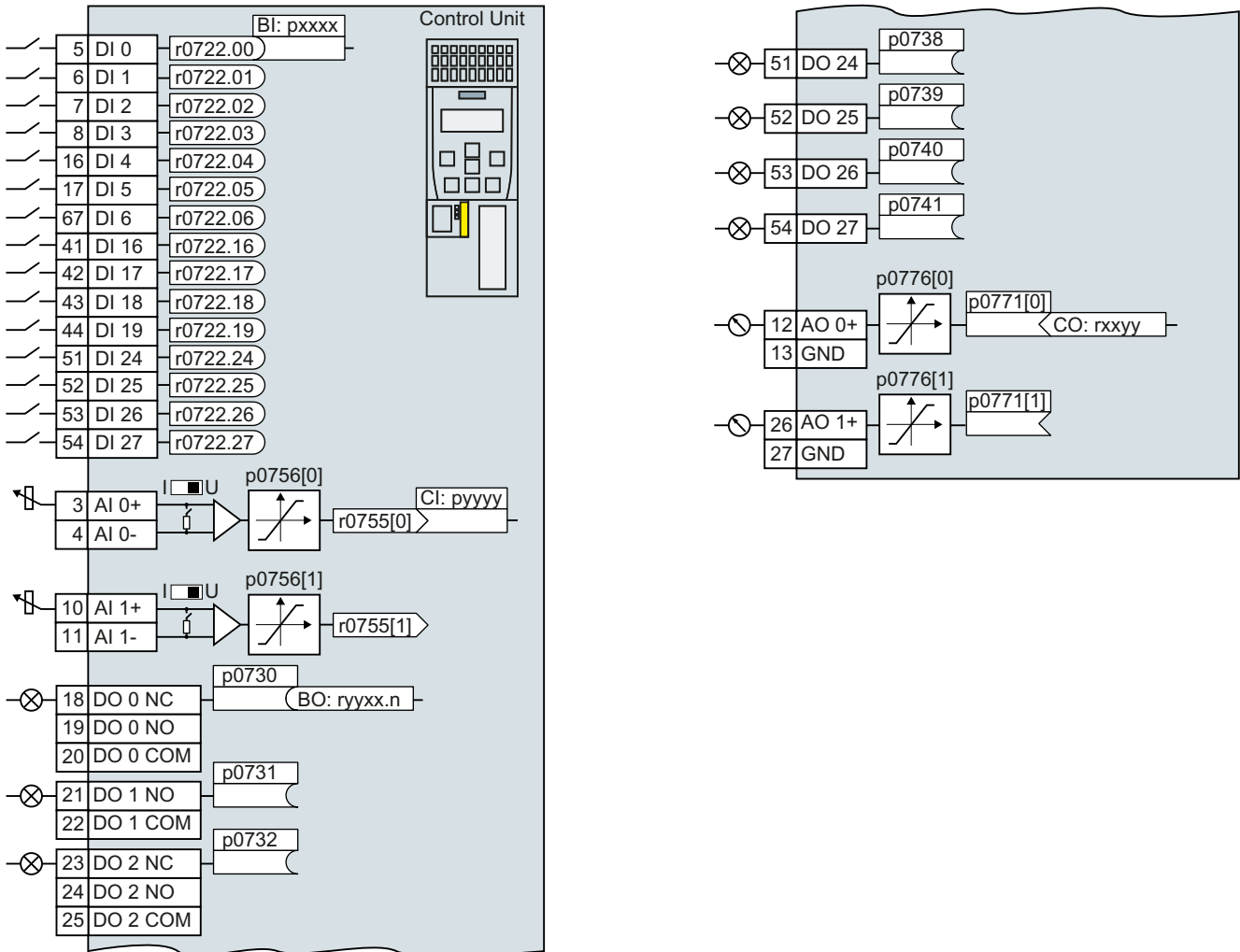
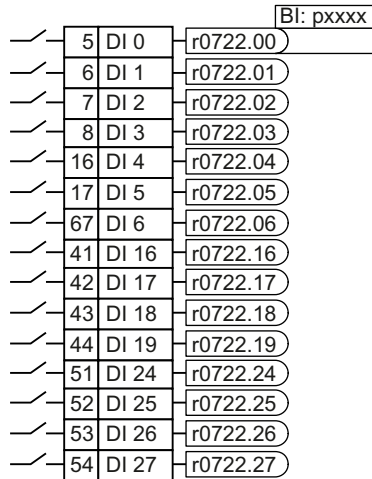

Figure 6-3 Internal interconnection of the inputs and outputs

6.3.1 Digital inputs

Changing the function of a digital input



To change the function of a digital input, you must interconnect the status parameter of the digital input with a binector input of your choice.

Binector inputs are marked with "BI" in the parameter list of the List Manual.

Interconnecting signals in the inverter (Page 503)

Table 6-3 Binector inputs (BI) of the inverter (selection)

BI	Meaning	BI	Meaning
p0810	Command data set selection CDS bit 0	p1055	Jog bit 0
p0840	ON/OFF1	p1056	Jog bit 1
p0844	OFF2	p1113	Setpoint inversion
p0848	OFF3	p1201	Flying restart enable signal source
p0852	Enable operation	p2103	1. Acknowledge faults
p1020	Fixed speed setpoint selection bit 0	p2106	External fault 1
p1021	Fixed speed setpoint selection bit 1	p2112	External alarm 1
p1022	Fixed speed setpoint selection bit 2	p2200	Technology controller enable
p1023	Fixed speed setpoint selection bit 3	p3330	Two/three-wire control, control command 1
p1035	Motorized potentiometer setpoint higher	p3331	Two/three-wire control, control command 2
p1036	Motorized potentiometer setpoint lower	p3332	Two/three-wire control, control command 3

A complete list of the binector outputs is provided in the List Manual.

Overview of the manuals (Page 519)

Application example: Changing the function of a digital input

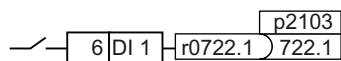

To acknowledge inverter fault messages, using digital input DI 1 you must interconnect DI 1 with the command to acknowledge faults (p2103).

Set p2103 = 722.1.

Advanced settings

You can debounce the digital input signal using parameter p0724.

For more information, please see the parameter list and the function block diagrams 2220 f of the List Manual.

 Overview of the manuals (Page 519)

Using switchable terminals as digital inputs

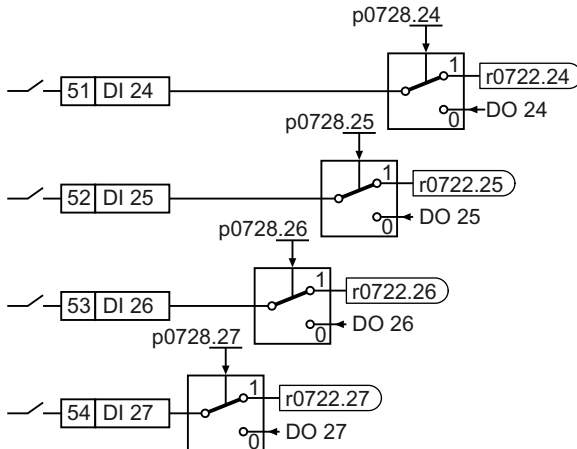

In the inverter factory setting, the switchable terminals are active as digital inputs.

To use a terminal that can be switched over as a digital input, set the corresponding bit of parameter p0728.x = 1.

Analog inputs as digital inputs

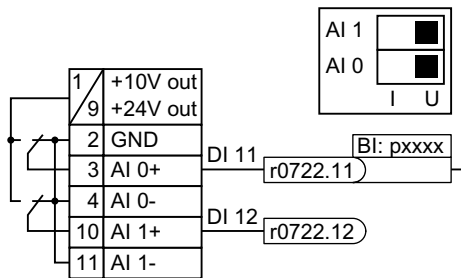

To use an analog input as additional digital input, you must interconnect the corresponding status parameter r0722.11 or r0722.12 with a binector input of your choice.

You may operate the analog input as digital input with 10 V or with 24 V.

NOTICE

Overcurrent at an analog input

If the analog input switch is set to "Current input" (I), a 10V or 24V voltage source results in an overcurrent at the analog input. An overcurrent condition destroys the analog input.

- If you use an analog input as a digital input, then you must set the analog input switch to "Voltage" (U).

Defining a fail-safe digital input

To enable a safety function via the terminal strip of the inverter, you need a fail-safe digital input.

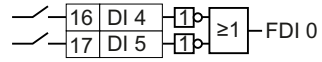

The inverter combines two digital inputs into one fail-safe digital input.

Additional information on fail-safe digital inputs can be obtained in the description of the STO safety function.

 Safe Torque Off (STO) safety function (Page 244)

6.3.2 Digital outputs

Changing the function of a digital output

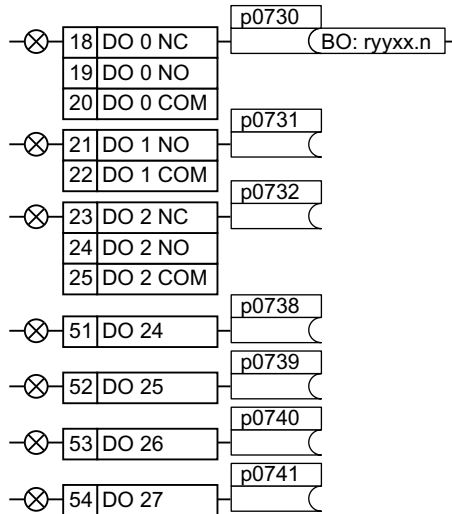

To change the function of a digital output, you must interconnect the digital output with a binector output of your choice.

Interconnecting signals in the inverter (Page 503)

Binector outputs are marked with "BO" in the parameter list of the List Manual.

Table 6-4 Frequently used binector outputs (BO) of the inverter

0	Deactivating digital output	r0052.08	0 signal: Deviation, setpoint/actual speed
r0052.00	1 signal: Ready for switching on	r0052.09	1 signal: Control requested
r0052.01	1 signal: Ready	r0052.10	1 signal: Maximum speed (p1082) reached
r0052.02	1 signal: Operation enabled	r0052.11	0 signal: I, M, P limit reached
r0052.03	1 signal: Fault active The inverter inverts signal r0052.03 if it is interconnected to a digital output.	r0052.13	0 signal: Alarm overtemperature motor
		r0052.14	1 signal: Motor CW rotation
r0052.04	0 signal: OFF2 active	r0052.15	0 signal: Alarm inverter overload
r0052.05	0 signal: OFF3 active	r0053.00	1 signal: DC braking active
r0052.06	1 signal: Switching on inhibited active	r0053.02	1 signal: Speed > minimum speed (p1080)
r0052.07	1 signal: Alarm active	r0053.06	1 signal: Speed ≥ setpoint speed (r1119)

The complete list of binector outputs is provided in the List Manual.

Overview of the manuals (Page 519)

Application example: Changing the function of a digital output

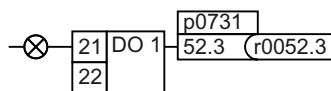

To output inverter fault messages via digital output DO 1, you must interconnect DO1 with these fault messages.

Set p0731 = 52.3

Advanced settings

You can invert the signal of the digital output using parameter p0748.

For more information, please see the parameter list and the function diagrams 2230 f of the List Manual.

 Overview of the manuals (Page 519)

Using switchable terminals as digital outputs

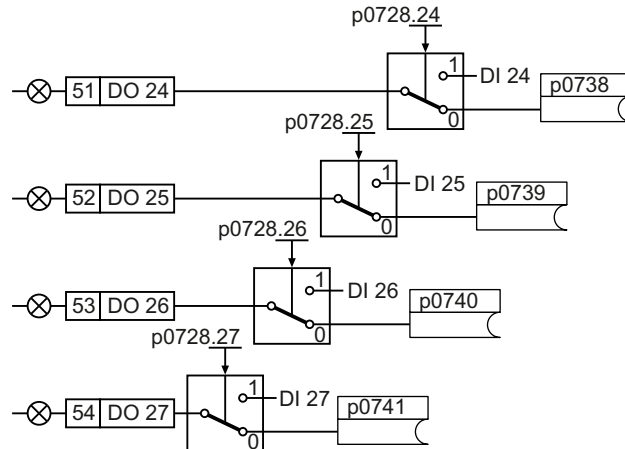

In the inverter factory setting, the switchable terminals are active as digital inputs.

To use a terminal that can be switched over as a digital output, set the corresponding bit of parameter p0728.x = 0.

6.3.3 Analog inputs

Overview

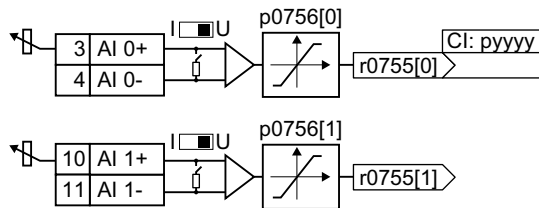

The parameter p0756[x] and the switch on the inverter specify the analog input type. Define the function of the analog input by interconnecting parameter p0755[x] with a connector input CI of your choice.

Interconnecting signals in the inverter (Page 503)

Connector inputs are marked with "CI" in the parameter list of the List Manual.

Defining the analog input type

The inverter offers a series of default settings, which you can select using parameter p0756:

AI 0	Unipolar voltage input	0 V ... +10 V	p0756[0] =	0
	Unipolar voltage input monitored	+2 V ... +10 V		1
	Unipolar current input	0 mA ... +20 mA		2
	Unipolar current input monitored	+4 mA ... +20 mA		3
	Bipolar voltage input	-10 V ... +10 V		4
	No sensor connected	---		8
AI 1	Unipolar voltage input	0 V ... +10 V	p0756[1] =	0
	Unipolar voltage input monitored	+2 V ... +10 V		1
	Unipolar current input	0 mA ... +20 mA		2
	Unipolar current input monitored	+4 mA ... +20 mA		3
	Bipolar voltage input	-10 V ... +10 V		4
	No sensor connected	---		8

In addition, you must also set the switch associated with the analog input. You can find the switch on the Control Unit behind the lower front door.

- Voltage input: Switch position U (factory setting)
- Current input: Switch position I



Characteristics

If you change the analog input type using p0756, then the inverter automatically selects the appropriate scaling of the analog input. The linear scaling characteristic is defined using two points (p0757, p0758) and (p0759, p0760). Parameters p0757 ... p0760 are assigned to an analog input via their index, e.g. parameters p0757[0] ... p0760[0] belong to analog input 0.

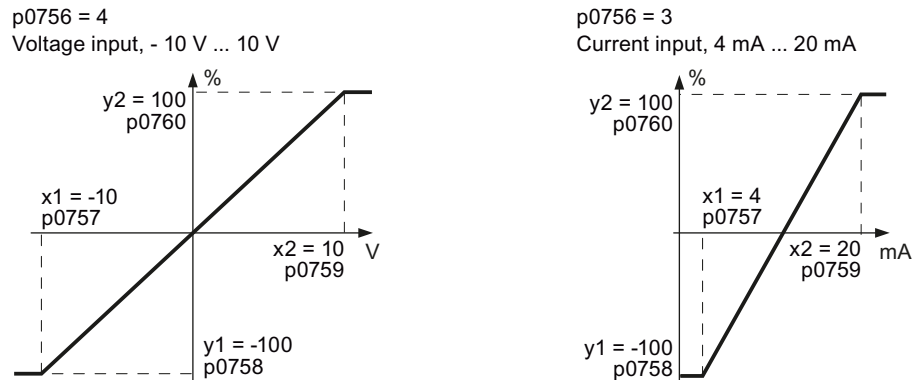

Figure 6-4 Examples for scaling characteristics

Parameter	Description
p0757	x coordinate of the 1st characteristic point [p0756 defines the unit]
p0758	y coordinate of the 1st characteristic point [% of p200x] p200x are the parameters of the reference variables, e.g. p2000 is the reference speed
p0759	x coordinate of the 2nd point characteristic point [p0756 defines the unit]
p0760	y coordinate of the 2nd characteristic point [% of p200x]
p0761	Wire breakage monitoring response threshold

Adapting the characteristic

You must define your own characteristic if none of the default types match your particular application.

Application example

The inverter should convert a 6 mA ... 12 mA signal into the value range -100 % ... 100 % via analog input 0. The wire break monitoring of the inverter should respond when 6 mA is fallen below.

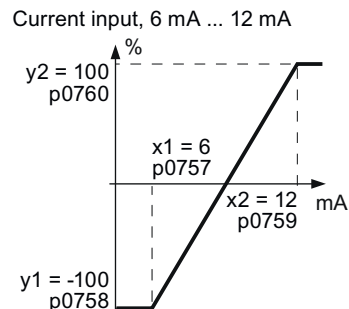

Figure 6-5 Characteristic for the application example

6.3 Adapt the default setting of the terminal strip

Procedure

1. Set the DIP switch for analog input 0 on the Control Unit to current input ("I"):



2. set p0756[0] = 3
You have defined analog input 0 as current input with wire break monitoring.
3. Set p0757[0] = 6.0 (x1)
4. Set p0758[0] = -100.0 (y1)
5. Set p0759[0] = 12.0 (x2)
6. Set p0760[0] = 100.0 (y2)
7. Set p0761[0] = 6
An input current < 6 mA results in fault F03505.

The characteristic for the application example is set.



Defining the function of an analog input

You define the analog input function by interconnecting a connector input of your choice with parameter p0755. Parameter p0755 is assigned to the particular analog input based on its index, e.g. parameter p0755[0] is assigned to analog input 0.

Table 6-5 Frequently used connector inputs (CI) of the inverter

CI	Significance	CI	Significance
p1070	Main setpoint	p2253	Technology controller setpoint 1
p1075	Supplementary setpoint	p2264	Technology controller actual value

A complete list of the connector inputs is provided in the List Manual.

 Overview of the manuals (Page 519)

Defining the function of an analog input - example

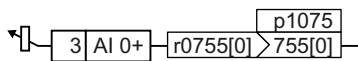

In order to enter the supplementary setpoint via analog input AI 0, you must interconnect AI 0 with the signal source for the supplementary setpoint.

Set p1075 = 755[0].

Advanced settings

Signal smoothing

When required, you can smooth the signal, which you read-in via an analog input, using parameter p0753.

You can find more information in the parameter list and in function diagram 2251 of the List Manual.

 Overview of the manuals (Page 519)

Dead band

With the control enabled, electromagnetic interference on the signal cable can cause the motor to slowly rotate in one direction in spite of a speed setpoint = 0.

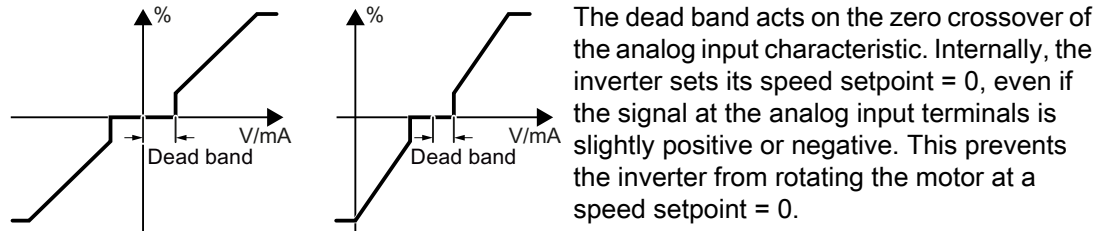

p0764[0]	Analog inputs dead zone, AI 0 (factory setting: 0)
p0764[1]	Analog inputs dead zone, AI 1 (factory setting: 0)

Using an analog input as digital input

An analog input can also be used as digital input.

 Digital inputs (Page 165)

6.3.4 Analog outputs

Overview

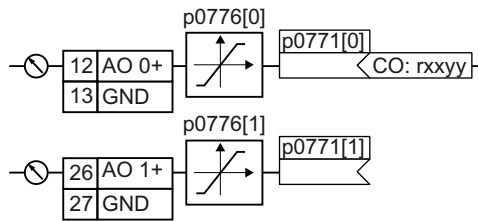

Define the analog output type using parameter p0776.

You define the analog output function by interconnecting parameter p0771 with a connector output CO of your choice.

Connector outputs are marked with "CO" in the parameter list of the List Manual.

 Interconnecting signals in the inverter (Page 503).

Defining the analog output type

The inverter offers a series of default settings, which you can select using parameter p0776:

AO 0	Current output (factory setting)	0 mA ... +20 mA	p0776[0] =	0
	Voltage output	0 V ... +10 V		1
	Current output	+4 mA ... +20 mA		2
AO 1	Current output (factory setting)	0 mA ... +20 mA	p0776[1] =	0
	Voltage output	0 V ... +10 V		1
	Current output	+4 mA ... +20 mA		2

Characteristics

If you change the analog output type, then the inverter automatically selects the appropriate scaling of the analog output. The linear scaling characteristic is defined using two points (p0777, p0778) and (p0779, p0780).

p0776 = 1
Voltage output, 0 V ... 10 V

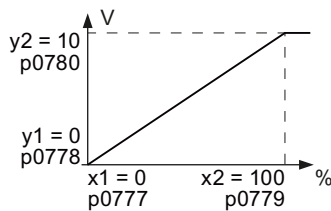

p0776 = 2
Current output, 4 mA ... 20 mA

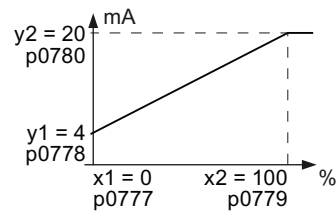

Figure 6-6 Examples for scaling characteristics

Parameters p0777 ... p0780 are assigned to an analog output via their index, e.g. parameters p0777[0] ... p0770[0] belong to analog output 0.

Table 6-6 Parameters for the scaling characteristic

Parameter	Description
p0777	x coordinate of the 1st characteristic point [% of p200x] p200x are the parameters of the reference variables, e.g. p2000 is the reference speed.
p0778	y coordinate of the 1st characteristic point [V or mA]
p0779	x coordinate of the 2nd characteristic point [% of p200x]
p0780	y coordinate of the 2nd characteristic point [V or mA]

Setting the characteristic

You must define your own characteristic if none of the default types match your particular application.

Application example

Via analog output 0, the inverter should convert a signal in the value range 0 % ... 100 % into an output signal 6 mA ... 12 mA.

Current output, 6 mA ... 12 mA

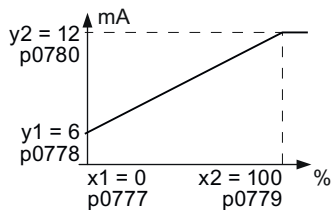

Figure 6-7 Characteristics for the application example

Procedure

1. Set p0776[0] = 2
This defines analog output 0 as a current output.
2. Set p0777[0] = 0.0 (x1)
3. Set p0778[0] = 6.0 (y1)
4. Set p0779[0] = 100.0 (x2)
5. Set p0780[0] = 12.0 (y2)

The characteristic for the application example is set.

□

Defining the function of an analog output

You define the analog output function by interconnecting parameter p0771 with a connector output of your choice. Parameter p0771 is assigned to the particular analog output via its index, e.g. parameter p0771[0] is assigned to analog output 0.

Table 6-7 Connector outputs (CO) of the inverter (selection)

CO	Significance	CO	Significance
r0021	Actual speed smoothed	r0026	DC link voltage smoothed
r0024	Output frequency, smoothed	r0027	Absolute actual current smoothed
r0025	Output voltage smoothed		

A complete list of the connector outputs is provided in the List Manual.

Additional information is provided in the parameter list and in function diagram 2261 of the List Manual.

 Overview of the manuals (Page 519)

Application example: Defining the function of an analog output



To output the inverter output current via analog output 0, you must interconnect AO 0 with the signal for the output current. Set p0771 = 27.

Advanced settings

You can manipulate the signal that you output via an analog output, as follows:

- Absolute-value generation of the signal (p0775)
- Signal inversion (p0782)

Additional information is provided in the parameter list of the List Manual.

6.4 Controlling clockwise and counter-clockwise rotation via digital inputs



The inverter has a different methods for controlling the motor using two or three commands.

Overview

Two wire control, method 1

ON/OFF1:

Switches the motor on or off

Reversing:

Reverses the motor direction of rotation

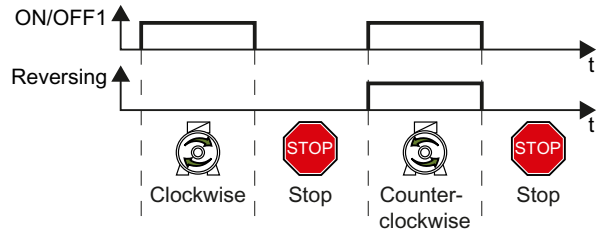

Two wire control, method 2 - and two-wire control, method 3

ON/OFF1 clockwise rotation:

Switches the motor on or off, clockwise rotation

ON/OFF1 counter-clockwise rotation:

Switches the motor on or off, counter-clockwise rotation

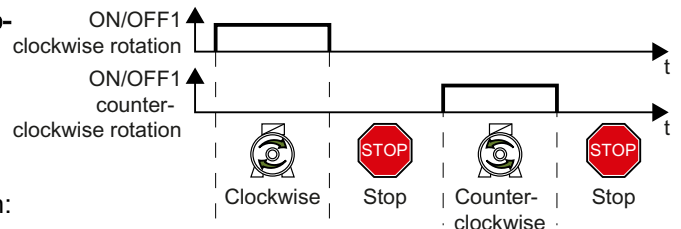

Three wire control, method 1

Enable/OFF1:

Enables the motor to be switched on or switched off

ON clockwise rotation:

Switches on the motor, clockwise rotation

ON counter-clockwise rotation:

Switches on the motor, counter-clockwise rotation

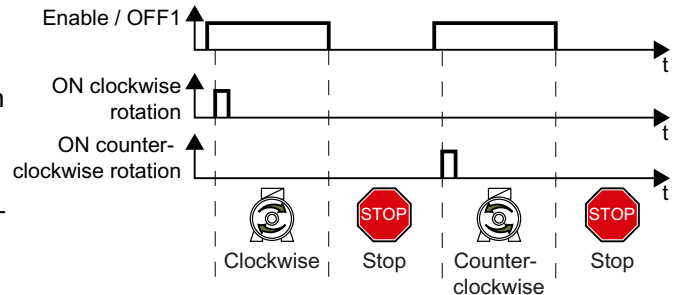

Three wire control, method 2

Enable/OFF1:

Enables the motor to be switched on or switched off

ON:

Switches on the motor

Reversing:

Reverses the motor direction of rotation

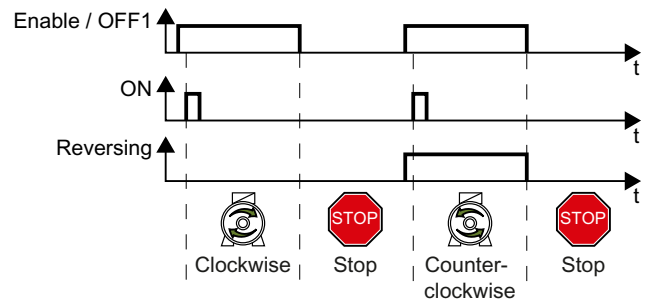

6.4.1 Two-wire control, method 1

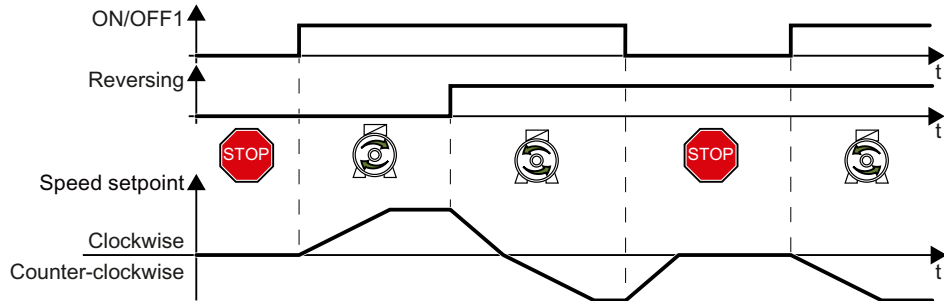

Figure 6-8 Two-wire control, method 1

Command "ON/OFF1" switches the motor on and off. The "Reversing" command inverts the motor direction of rotation.

Table 6-8 Function table

ON/OFF1	Reversing	Function
0	0	OFF1: The motor stops
0	1	
1	0	ON: Clockwise motor rotation
1	1	ON: Counter-clockwise motor rotation

Table 6-9 Select two-wire control, method 1

Parameter	Description
p0015 = 12	Macro drive unit You must carry out quick commissioning in order to set parameter p0015. Assigning digital inputs DI to the commands: DI 0: ON/OFF1 DI 1: Reversing

Table 6-10 Changing the assignment of the digital inputs

Parameter	Description
p0840[0 ... n] = 722.x	BI: ON/OFF1 (ON/OFF1) Example: p0840 = 722.3 ⇒ DI 3: ON/OFF1
p1113[0 ... n] = 722.x	BI: Setpoint inversion (reversing)

6.4.2 Two-wire control, method 2

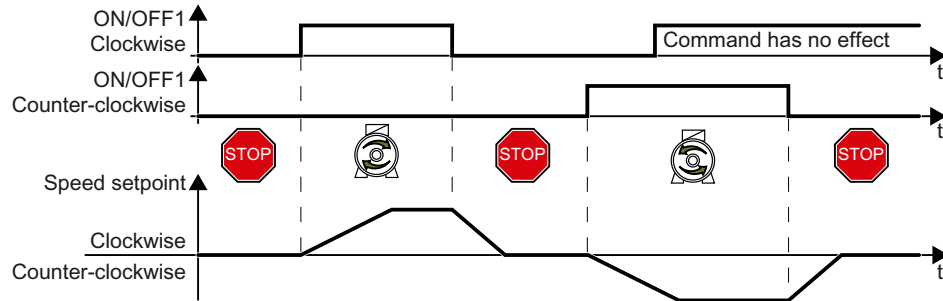

Figure 6-9 Two-wire control, method 2

Commands "ON/OFF1 clockwise rotation" and "ON/OFF1 counter-clockwise rotation" switch on the motor - and simultaneously select a direction of rotation. The inverter only accepts a new command when the motor is at a standstill.

Table 6-11 Function table

ON/OFF1 clockwise rotation	ON/OFF1 counter-clockwise rotation	Function
0	0	OFF1: The motor stops.
1	0	ON: Clockwise motor rotation.
0	1	ON: Counter-clockwise motor rotation.
1	1	ON: The motor direction of rotation is defined by the command that first reaches state "1".

Table 6-12 Select two-wire control, method 2

Parameter	Description
p0015 = 17	Macro drive unit You must carry out quick commissioning in order to set parameter p0015. Assigning digital inputs DI to the commands: DI 0: ON/OFF1 clockwise rotation DI 1: ON/OFF1 counter-clockwise rotation

Table 6-13 Changing the assignment of the digital inputs

Parameter	Description
p3330[0 ... n] = 722.x	BI: 2/3 wire control command 1 (ON/OFF1 clockwise rotation)
p3331[0 ... n] = 722.x	BI: 2/3 wire control command 2 (ON/OFF1 counter-clockwise rotation) Example: p3331 = 722.0 → DI 0: ON/OFF1 counter-clockwise rotation

6.4.3 Two-wire control, method 3

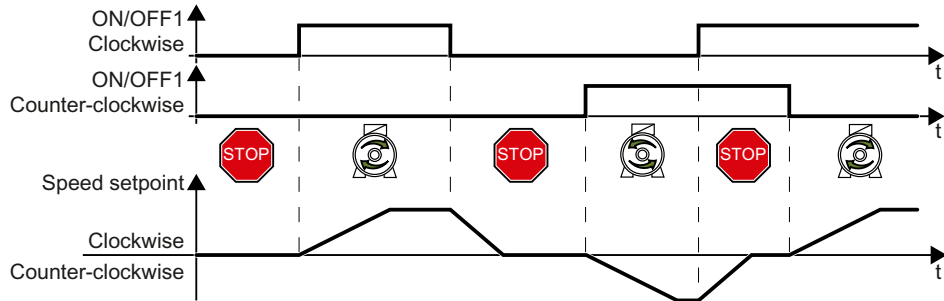

Figure 6-10 Two-wire control, method 3

Commands "ON/OFF1 clockwise rotation" and "ON/OFF1 counter-clockwise rotation" switch on the motor - and simultaneously select a direction of rotation. The inverter accepts a new command at any time, independent of the motor speed.

Table 6-14 Function table

ON/OFF1 clockwise rotation	ON/OFF1 counter-clockwise rotation	Function
0	0	OFF1: The motor stops.
1	0	ON: Clockwise motor rotation.
0	1	ON: Counter-clockwise motor rotation.
1	1	OFF1: The motor stops.

Table 6-15 Select two-wire control, method 3

Parameter	Description
p0015 = 18	<p>Macro drive unit</p> <p>You must carry out quick commissioning in order to set parameter p0015.</p> <p>Assigning digital inputs DI to the commands:</p> <p>DI 0: ON/OFF1 clockwise rotation</p> <p>DI 1: ON/OFF1 counter-clockwise rotation</p>

Table 6-16 Changing the assignment of the digital inputs

Parameter	Description
p3330[0 ... n] = 722.x	BI: 2/3 wire control command 1 (ON/OFF1 clockwise rotation)
p3331[0 ... n] = 722.x	BI: 2/3 wire control command 2 (ON/OFF1 counter-clockwise rotation) Example: p3331 = 722.0 ⇒ DI 0: ON/OFF1 counter-clockwise rotation

6.4.4 Three-wire control, method 1

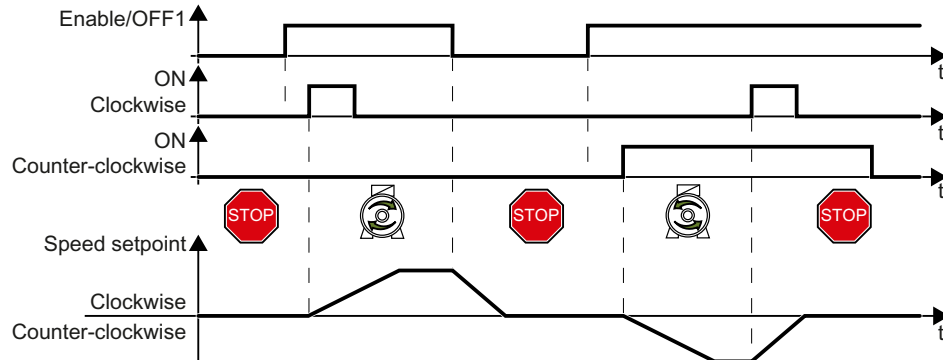

Figure 6-11 Three-wire control, method 1

The "Enable" command is a precondition for switching on the motor. Commands "ON clockwise rotation" and "ON counter-clockwise rotation" switch on the motor - and simultaneously select a direction of rotation. Removing the enable switches the motor off (OFF1).

Table 6-17 Function table

Enable / OFF1	ON clockwise rotation	ON counter-clockwise rotation	Function
0	0 or 1	0 or 1	OFF1: The motor stops.
1	0→1	0	ON: Clockwise motor rotation.
1	0	0→1	ON: Counter-clockwise motor rotation.
1	1	1	OFF1: The motor stops.

Table 6-18 Select three-wire control, method 1

Parameter	Description
p0015 = 19	Macro drive unit You must carry out quick commissioning in order to set parameter p0015. Assigning digital inputs DI to the commands: DI 0: Enable / OFF1 DI 1: ON clockwise rotation DI 2: ON counter-clockwise rotation

Table 6-19 Changing the assignment of the digital inputs

Parameter	Description
p3330[0 ... n] = 722.x	BI: 2/3 wire control command 1 (enable/OFF1)
p3331[0 ... n] = 722.x	BI: 2/3 wire control command 2 (ON clockwise rotation)
p3332[0 ... n] = 722.x	BI: 2/3 wire control command 3 (ON counter-clockwise rotation) Example: p3332 = 722.0 ⇒ DI 0: ON counter-clockwise rotation

6.4.5 Three-wire control, method 2

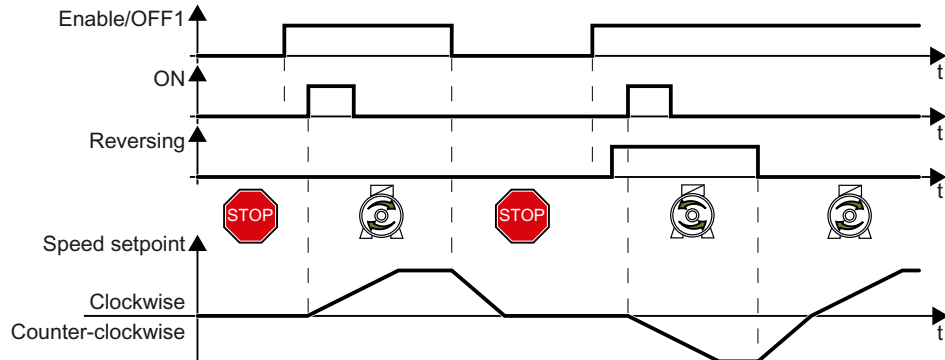

Figure 6-12 Three-wire control, method 2

The "Enable" command is a precondition for switching on the motor. The "ON" command switches the motor on. The "Reversing" command inverts the motor direction of rotation. Removing the enable switches the motor off (OFF1).

Table 6-20 Function table

Enable / OFF1	ON	Reversing	Function
0	0 or 1	0 or 1	OFF1: The motor stops.
1	0→1	0	ON: Clockwise motor rotation.
1	0→1	1	ON: Counter-clockwise motor rotation.

Table 6-21 Select three-wire control, method 2

Parameter	Description
p0015 = 20	Macro drive unit You must carry out quick commissioning in order to set parameter p0015. Assigning digital inputs DI to the commands: DI 0: Enable / OFF1 DI 1: ON DI 2: Reversing

Table 6-22 Changing the assignment of the digital inputs

Parameter	Description
p3330[0 ... n] = 722.x	BI: 2/3 wire control command 1 (enable/OFF1)
p3331[0 ... n] = 722.x	BI: 2/3 wire control command 2 (ON) Example: p3331 = 722.0 ⇒ DI 0: ON command
p3332[0 ... n] = 722.x	BI: 2/3 wire control command 3 (reversing)

6.5 Drive control via PROFIBUS or PROFINET

6.5.1 Receive data and send data

Cyclic data exchange



The inverter receives cyclic data from the higher-level control - and returns cyclic data to the control.

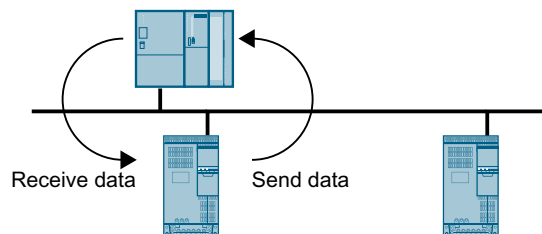

Figure 6-13 Cyclic data exchange

Inverter and control system pack their data in telegrams.

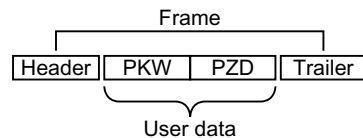

Figure 6-14 Telegram structure

Every telegram for cyclic data exchange has the following basic structure:

- Header and trailer form the protocol frame.
- User data is located within the frame:
 - PKW: The control can read or change every parameter in the inverter via "PKW data". Not every telegram has a "PKW range".
 - PZD: The inverter receives control commands and setpoints from the higher-level control - and sends status messages and actual values via "PZD data".

PROFIdrive and telegram numbers

For typical applications, certain telegrams are defined in the PROFIdrive profile and are assigned a fixed PROFIdrive telegram number. As a consequence, behind a PROFIdrive telegram number, there is a defined signal composition. As a consequence, a telegram number uniquely describes cyclic data exchange.

The telegrams are identical for PROFIBUS and PROFINET.

6.5.2 Telegrams

Available telegrams without "basic positioner"

The user data of available telegrams are described in the following.

The inverter has the following telegrams if you have not configured the "Basic positioner" function:

Telegram 1

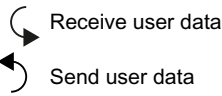
PZD01	PZD02	
STW1	NSOLL_A	
ZSW1	NIST_A	

16-bit speed setpoint

Telegram 2

PZD01	PZD02	PZD03	PZD04
STW1	NSOLL_B		STW2
ZSW1	NIST_B		ZSW2

32-bit speed setpoint

Telegram 3

PZD01	PZD02	PZD03	PZD04	PZD05	PZD06	PZD07	PZD08	PZD09
STW1	NSOLL_B		STW2	G1_STW				
ZSW1	NIST_B		ZSW2	G1_ZSW	G1_XIST1	G1_XIST2		

32-bit speed setpoint with 1 position encoder

Telegram 4

PZD01	PZD02	PZD03	PZD04	PZD05	PZD06	PZD07	PZD08	PZD09	PZD10	PZD11	PZD12	PZD13	PZD14
STW1	NSOLL_B		STW2	G1_STW	G2_STW								
ZSW1	NIST_B		ZSW2	G1_ZSW	G1_XIST1	G1_XIST2	G2_ZSW	G2_XIST1	G2_XIST2				

32-bit speed setpoint with 2 position encoders

Telegram 20

PZD01	PZD02	PZD03	PZD04	PZD05	PZD06
STW1	NSOLL_A				
ZSW1	NIST_A	IAIST_GLATT	MIST_GLATT	PIST_GLATT	MELD_NAMUR

16-bit speed setpoint for VIK-Namur

Telegram 350

PZD01	PZD02	PZD03	PZD04
STW1	NSOLL_A	M_LIM	STW3
ZSW1	NIST_A GLATT	IAIST_ GLATT	ZSW3

16-bit speed setpoint with torque limiting

Telegram 352

PZD01	PZD02	PZD03	PZD04	PZD05	PZD06
STW1	NSOLL_A	Process data for PCS7			
ZSW1	NIST_A GLATT	IAIST_ GLATT	MIST_ GLATT	WARN_ CODE	FAULT_ CODE

16-bit speed setpoint for PCS7

Telegram 353

PKW	PZD01	PZD02
	STW1	NSOLL_A
	ZSW1	NIST_A GLATT

16-bit speed setpoint to read and write parameters

Telegram 354

PKW	PZD01	PZD02	PZD03	PZD04	PZD05	PZD06
	STW1	NSOLL_A	Process data for PCS7			
	ZSW1	NIST_A GLATT	IAIST_ GLATT	MIST_ GLATT	WARN_ CODE	FAULT_ CODE

16-bit speed setpoint for PCS7 to read and write parameters

Telegram 999

PZD01	PZD02	PZD03	PZD04	PZD05	PZD06	PZD07	PZD08	PZD09	PZD10	PZD11	PZD12	PZD13 ... PZD17
STW1	Telegram length for the receive data											
ZSW1	Telegram length for the transmit data											

Free interconnection and length

Abbreviation	Explanation	Abbreviation	Explanation
PZD	Process data	PKW	Parameter channel
STW1 ... STW3	Control word 1 ... control word 3	PIST	Actual active power
ZSW1 ... STW3	Status word 1 ... status word 3	M_LIM	Torque limit
NSOLL_A	Speed setpoint 16-bit	FAULT_CODE	Fault code
NSOLL_B	Speed setpoint 32-bit	WARN_CODE	Alarm code
NIST_A	Actual speed value 16-bit	MELD_NAMUR	Control word according to the VIK-NA-MUR definition
NIST_B	Actual speed value 32-bit	G1_STW / G2_STW	Control word for encoder 1 or encoder 2
IAIST	Actual current value	G1_ZSW / G2_ZSW	Status word for encoder 1 / encoder 2

Abbreviation	Explanation	Abbreviation	Explanation
IAIST_GLATT	Smoothed actual current value	G1_XIST1 / G2_XIST1	Position actual value 1 from encoder 1 / encoder 2
MIST_GLATT	Smoothed actual torque value	G1_XIST2 / G2_XIST2	Position actual value 2 from encoder 1 / encoder 2

Available telegrams if "Basic positioner" has been configured

If you have configured the "Basic positioner" function, then the inverter has the following telegrams for cyclic data exchange with the higher-level control system:

- Standard telegram 7, PZD-2/2
- Standard telegram 9, PZD-10/5
- SIEMENS telegram 110, PZD-12/7
- SIEMENS telegram 111, PZD-12/12
- Telegram 999, free interconnection

Telegrams 7, 9, 110 and 111 are described in the "Basic positioner" Function Manual

 Overview of the manuals (Page 519)

Interconnection of the process data

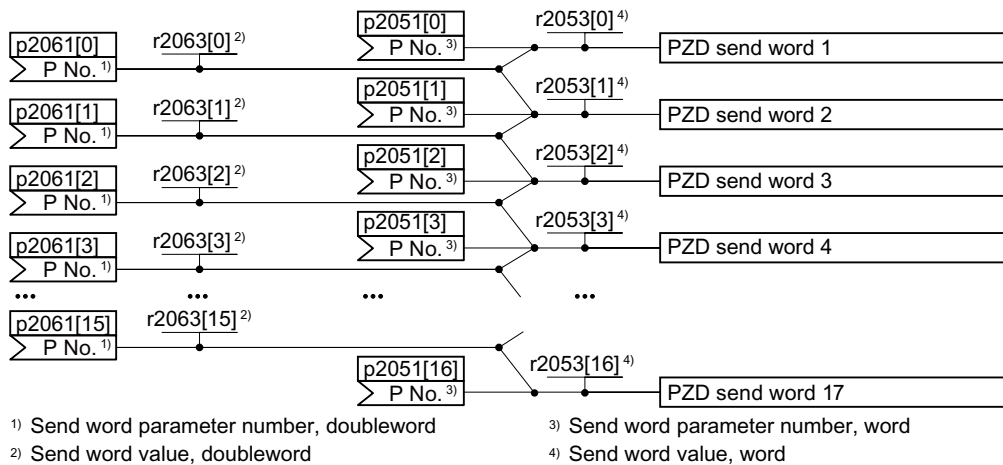

Figure 6-15 Interconnection of the send words

In the inverter, send data are available in the "Word" format (p2051) and in the "Double word" format (p2061). If you set a specific telegram, or change the telegram, then the inverter automatically interconnects parameters p2051 and p2061 with the appropriate signals.

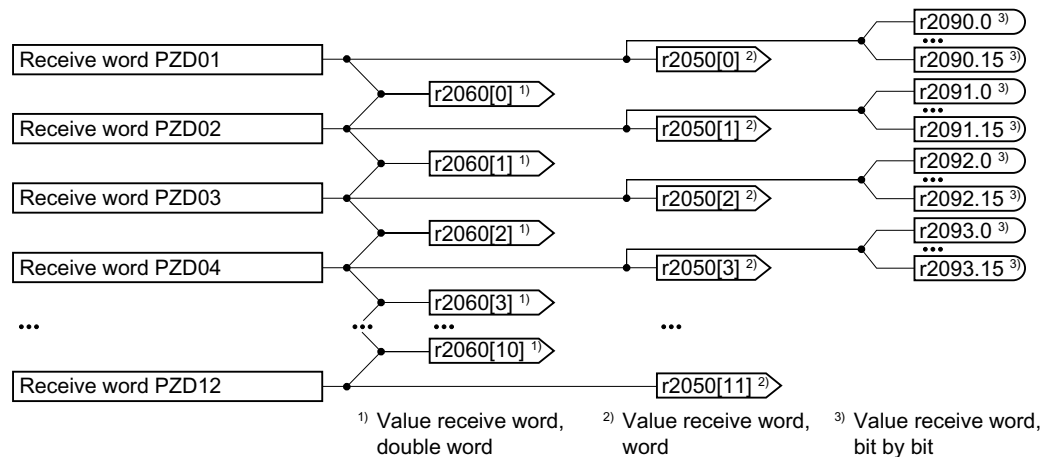

Figure 6-16 Interconnection of the receive words

The inverter saves the receive data in the "Word" format (r2050), in the "Double word" format (r2060) and bit-by-bit (r2090 ...r2093). If you set a specific telegram, or change the telegram, then the inverter automatically interconnects parameters r2050, r2060 and r2090 ...r2093 with the appropriate signals.

If you wish to adapt a predefined telegram, then you must interconnect to the send and receive data with the appropriate signals. You must first adapt parameters p0922 and p2079 to allow manual interconnection of the send and receive data. Details regarding the free interconnection of process data are provided in the List Manual in function diagrams 2420 and 2472.

6.5.3 Control and status word 1

Control word 1 (STW1)

Bit	Significance		Explanation	Signal inter-connection in the inverter
	Telegram 20	All other telegrams		
0	0 = OFF1		The motor brakes with the ramp-down time p1121 of the ramp-function generator. The inverter switches off the motor at standstill.	p0840[0] = r2090.0
	0 → 1 = ON		The inverter goes into the "ready" state. If, in addition bit 3 = 1, then the inverter switches on the motor.	
1	0 = OFF2		Switch off the motor immediately, the motor then coasts down to a standstill.	p0844[0] = r2090.1
	1 = No OFF2		The motor can be switched on (ON command).	
2	0 = Quick stop (OFF3)		Quick stop: The motor brakes with the OFF3 ramp-down time p1135 down to standstill.	p0848[0] = r2090.2
	1 = No quick stop (OFF3)		The motor can be switched on (ON command).	
3	0 = Inhibit operation		Immediately switch-off motor (cancel pulses).	p0852[0] = r2090.3
	1 = Enable operation		Switch-on motor (pulses can be enabled).	

Bit	Significance		Explanation	Signal inter-connection in the inverter
	Telegram 20	All other telegrams		
4	0 = Disable RFG		The inverter immediately sets its ramp-function generator output to 0.	p1140[0] = r2090.4
	1 = Do not disable RFG		The ramp-function generator can be enabled.	
5	0 = Stop RFG		The output of the ramp-function generator stops at the actual value.	p1141[0] = r2090.5
	1 = Enable RFG		The output of the ramp-function generator follows the setpoint.	
6	0 = Inhibit setpoint		The inverter brakes the motor with the ramp-down time p1121 of the ramp-function generator.	p1142[0] = r2090.6
	1 = Enable setpoint		Motor accelerates with the ramp-up time p1120 to the setpoint.	
7	0 → 1 = Acknowledge faults		Acknowledge fault. If the ON command is still active, the inverter switches to the "switching on inhibited" state.	p2103[0] = r2090.7
8, 9	Reserved			
10	0 = No control via PLC		Inverter ignores the process data from the fieldbus.	p0854[0] = r2090.10
	1 = Control via PLC		Control via fieldbus, inverter accepts the process data from the fieldbus.	
11	1 = Direction reversal		Invert setpoint in the inverter.	p1113[0] = r2090.11
12	Not used			
13	--- ¹⁾	1 = MOP up	Increase the setpoint saved in the motorized potentiometer.	p1035[0] = r2090.13
14	--- ¹⁾	1 = MOP down	Reduce the setpoint saved in the motorized potentiometer.	p1036[0] = r2090.14
15	CDS bit 0	Reserved	Changes over between settings for different operation interfaces (command data sets).	p0810 = r2090.15

¹⁾ If you change over from another telegram to telegram 20, then the assignment of the previous telegram is kept.

Status word 1 (ZSW1)

Bit	Significance		Remarks	Signal inter-connection in the inverter
	Telegram 20	All other telegrams		
0	1 = Ready for switching on		Power supply switched on; electronics initialized; pulses locked.	p2080[0] = r0899.0
1	1 = Ready		Motor is switched on (ON/OFF1 = 1), no fault is active. With the command "Enable operation" (STW1.3), the inverter switches on the motor.	p2080[1] = r0899.1

Bit	Significance		Remarks	Signal inter-connection in the inverter
	Telegram 20	All other telegrams		
2	1 = Operation enabled		Motor follows setpoint. See control word 1, bit 3.	p2080[2] = r0899.2
3	1 = Fault active		The inverter has a fault. Acknowledge fault using STW1.7.	p2080[3] = r2139.3
4	1 = OFF2 inactive		Coast down to standstill is not active.	p2080[4] = r0899.4
5	1 = OFF3 inactive		Quick stop is not active.	p2080[5] = r0899.5
6	1 = Switching on inhibited active		It is only possible to switch on the motor after an OFF1 followed by ON.	p2080[6] = r0899.6
7	1 = Alarm active		Motor remains switched on; no acknowledgement is necessary.	p2080[7] = r2139.7
8	1 = Speed deviation within the tolerance range		Setpoint / actual value deviation within the tolerance range.	p2080[8] = r2197.7
9	1 = Master control requested		The automation system is requested to accept the inverter control.	p2080[9] = r0899.9
10	1 = Comparison speed reached or exceeded		Speed is greater than or equal to the corresponding maximum speed.	p2080[10] = r2199.1
11	1 = current or torque limit reached	1 = torque limit reached	Comparison value for current or torque has been reached or exceeded.	p2080[11] = r0056.13 / r1407.7
12	--- ¹⁾	1 = Holding brake open	Signal to open and close a motor holding brake.	p2080[12] = r0899.12
13	0 = Alarm, motor overtemperature		--	p2080[13] = r2135.14
14	1 = Motor rotates clockwise		Internal inverter actual value > 0	p2080[14] = r2197.3
	0 = Motor rotates counter-clockwise		Internal inverter actual value < 0	
15	1 = CDS display	0 = Alarm, inverter thermal overload		p2080[15] = r0836.0 / r2135.15

¹⁾ If you change over from another telegram to telegram 20, then the assignment of the previous telegram is kept.

6.5.4 Control and status word 2

Control word 2 (STW2)

Bit	Meaning		Signal interconnection in the inverter
	Telegrams 2, 3 and 4	Telegrams 9, 110 and 111	
0	1 = drive data set selection DDS bit 0		p0820[0] = r2093.0
1	1 = drive data set selection DDS bit 1		p0821[0] = r2093.1
2...6	Reserved		
7	1 = parking axis is selected		p0897 = r2093.7
8	1 = travel to fixed stop active	Reserved	p1545[0] = r2093.8
9...11	Reserved		
12	1 = master sign-of-life bit 0		p2045 = r2050[3]
13	1 = master sign-of-life bit 1		
14	1 = master sign-of-life bit 3		
15	1 = master sign-of-life bit 4		

Status word 2 (ZSW2)

Bit	Meaning	Signal interconnection in the inverter
0	1 = Drive data set DDS effective, bit 0	p2081[0] = r0051.0
1	1 = Drive data set DDS effective, bit 1	p2081[1] = r0051.1
2...4	Reserved	
5	1 = Alarm class bit 0	p2081[5] = r2139.11
6	1 = alarm class bit 1	p2081[6] = r2139.12
7	Reserved	
8	1 = travel to fixed stop active	p2081[8] = r1406.8
9	Reserved	
10	1 = pulses enabled	p2081[10] = r0899.11
11	Reserved	
12	Slave sign-of-life bit 0	Internally interconnected
13	Slave sign of life bit 1	
14	Slave sign of life bit 2	
15	Slave sign of life bit 3	

6.5.5 Control and status word 3

Control word 3 (STW3)

Bit	Meaning	Explanation	Signal interconnection in the inverter ¹⁾
	Telegram 350		
0	1 = fixed setpoint bit 0	Selects up to 16 different fixed setpoints.	p1020[0] = r2093.0
1	1 = fixed setpoint bit 1		p1021[0] = r2093.1
2	1 = fixed setpoint bit 2		p1022[0] = r2093.2
3	1 = fixed setpoint bit 3		p1023[0] = r2093.3
4	1 = DDS selection bit 0	Changes over between settings for different motors (drive data sets).	p0820 = r2093.4
5	1 = DDS selection bit 1		p0821 = r2093.5
6	Not used		
7	Not used		
8	1 = technology controller enable	--	p2200[0] = r2093.8
9	1 = enable DC braking	--	p1230[0] = r2093.9
10	Not used		
11	1 = Enable droop	Enable or inhibit speed controller droop.	p1492[0] = r2093.11
12	1 = torque control active 0 = speed control active	Changes over the control mode for vector control.	p1501[0] = r2093.12
13	1 = no external fault 0 = external fault is active (F07860)	--	p2106[0] = r2093.13
14	Not used		
15	1 = CDS bit 1	Changes over between settings for different operation interfaces (command data sets).	p0811[0] = r2093.15

¹⁾ If you switch from telegram 350 to a different one, then the inverter sets all interconnections p1020, ... to "0". Exception: p2106 = 1.

Status word 3 (ZSW3)

Bit	Meaning	Description	Signal interconnection in the inverter
0	1 = DC braking active	--	p2051[3] = r0053
1	1 = $ n_{act} > p1226$	Absolute current speed > stationary state detection	
2	1 = $ n_{act} > p1080$	Absolute actual speed > minimum speed	
3	1 = $i_{act} \geq p2170$	Actual current \geq current threshold value	
4	1 = $ n_{act} > p2155$	Absolute actual speed > speed threshold value 2	
5	1 = $ n_{act} \leq p2155$	Absolute actual speed < speed threshold value 2	
6	1 = $ n_{act} \geq r1119$	Speed setpoint reached	
7	1 = DC link voltage $\leq p2172$	Actual DC link voltage \leq threshold value	
8	1 = DC link voltage > p2172	Actual DC link voltage > threshold value	
9	1 = ramp-up or ramp-down completed	Ramp-function generator is not active.	
10	1 = technology controller output at the lower limit	Technology controller output $\leq p2292$	
11	1 = technology controller output at the upper limit	Technology controller output > p2291	
12	Not used		
13	Not used		
14	Not used		
15	Not used		

6.5.6 NAMUR message word

Fault word according to the VIK-NAMUR definition (MELD_NAMUR)

Table 6-23 Fault word according to the VIK-NAMUR definition and interconnection with parameters in the inverter

Bit	Significance	P no.
0	1 = Control Unit signals a fault	p2051[5] = r3113
1	1 = line fault: Phase failure or inadmissible voltage	
2	1 = DC link overvoltage	
3	1 = Power Module fault, e.g. overcurrent or overtemperature	
4	1 = inverter overtemperature	
5	1 = ground fault/phase fault in the motor cable or in the motor	
6	1 = motor overload	
7	1 = communication error to the higher-level control system	
8	1 = fault in a safety-relevant monitoring channel	
10	1 = fault in the internal inverter communication	
11	1 = line fault	
15	1 = other fault	

6.5.7 Control and status word, encoder

Telegrams 3 and 4 allow the higher-level control system to directly access the encoder.

Direct access is necessary, if the higher-level control is responsible for the closed-loop position control for the drive.

If you enable the "Basic positioner" position control in the inverter, then telegrams 3 and 4 cannot be selected, and the inverter handles the encoder control.

Control word encoder (G1_STW and G2_STW)

Bit	Meaning	Explanation		Signal interconnection in the inverter
		Bit 7 = 0	Bit 7 = 1	
0	Function 1	1 = search for reference cam 1 with a positive start direction	1 = request flying referencing to the rising edge of reference cam 1	Telegram 3: Encoder 1: p0480[0] = r2050[4]
1	Function 2	1 = search for reference cam 1 with a negative start direction	1 = request flying referencing to the falling edge of reference cam 1	Telegram 4: Encoder 1: p0480[0] = r2050[4]
2	Function 3	1 = search for reference cam 2 with a positive start direction	1 = request flying referencing to the rising edge of reference cam 2	encoder 2: p0480[1] = p2050[9]
3	Function 4	1 = search for reference cam 2 with a negative start direction	1 = request flying referencing to the falling edge of reference cam 2	Telegram 102:
4	Command bit 0	1 = activate the function requested using bit 0 ... 3		Encoder 1: p0480[0] = r2050[5]
5	Command bit 1	1 = read the value requested using bit 0 ... 3		
6	Command bit 2	Reserved		Telegram 103:
7	Mode	1 = flying referencing 0 = search for reference cams		Encoder 1: p0480[0] = r2050[5]
8	Reserved	---		encoder 2: p0480[1] = p2050[10]
...				
12				
13	Cyclic absolute value	1 = request for the cyclic transfer of the position actual value in G1_XIST2 or G2_XIST2		
14	Parking	1 = request to park the encoder		
15	Acknowledge	0 → 1 = acknowledge encoder fault		

Status word encoder (G1_ZSW and G2_ZSW)

Bit	Meaning	Explanation		Signal interconnection in the inverter
		Bit 7 = 0	Bit 7 = 1	
0	Function 1	1 = search for reference cam 1 is active	1 = flying referencing to the rising edge of reference cam 1 is active	Telegram 3: Encoder 1: p2051[4] = r0481[0]
1	Function 2	1 = search for reference cam 1 is active	1 = flying referencing to the falling edge of reference cam 1 is active	
2	Function 3	1 = search for reference cam 2 is active	1 = flying referencing to the rising edge of reference cam 2 is active	Telegram 4: Encoder 1: p2051[4] = r0481[0] encoder 2: p2051[9] = r0481[1]
3	Function 4	1 = search for reference cam 2 is active	1 = flying referencing to the falling edge of reference cam 2 is active	
4	Status value 1	1 = position actual value is at reference cam 1	1 = flying referencing to the rising edge of reference cam 1 has been completed	Telegram 102: Encoder 1: p2051[5] = r0481[0]
5	Status value 2	1 = position actual value is at reference cam 1	1 = flying referencing to the falling edge of reference cam 1 has been completed	
6	Status value 3	1 = position actual value is at reference cam 2	1 = flying referencing to the rising edge of reference cam 2 has been completed	Telegram 103: Encoder 1: p2051[5] = r0481[0] encoder 2: p2051[10] = r0481[0]
7	Status value 4	1 = position actual value is at reference cam 2	1 = flying referencing to the falling edge of reference cam 2 has been completed	
8	Reference cam 1	1 = reference cam 1 supplies a high signal 0 = reference cam 1 supplies a low signal		
9	Reference cam 2	1 = reference cam 2 supplies a high signal 0 = reference cam 2 supplies a low signal		
10	Reserved	---		
11	Acknowledge	1 = acknowledge encoder fault is active		
12	Reserved	---		
13	Cyclic absolute value	1 = the position actual value is in G1_XIST2 or G2_XIST2.		
14	Parking	1 = the encoder is parked		
15	Fault	1 = the encoder indicates its actual fault in r0483		

6.5.8 Position actual value of the encoder

G1_XIST1 and G2_XIST1

In the factory setting, the inverter transfers the encoder position actual value with a fine resolution of 11 bits to the higher-level control system.

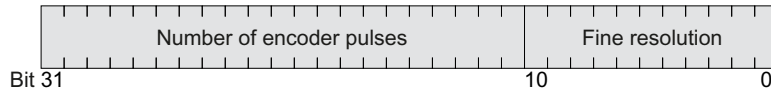

Figure 6-17 G1_XIST1 and G2_XIST1

The transferred encoder signal has the following properties:

- After the inverter power supply has been switched on, the encoder signal = 0.
- The higher-level control must be able to handle a counter overflow of the encoder signal.

G1_XIST2 and G2_XIST2

In G1_XIST2 or G2_XIST2, the inverter transfers different values to the higher-level control system:

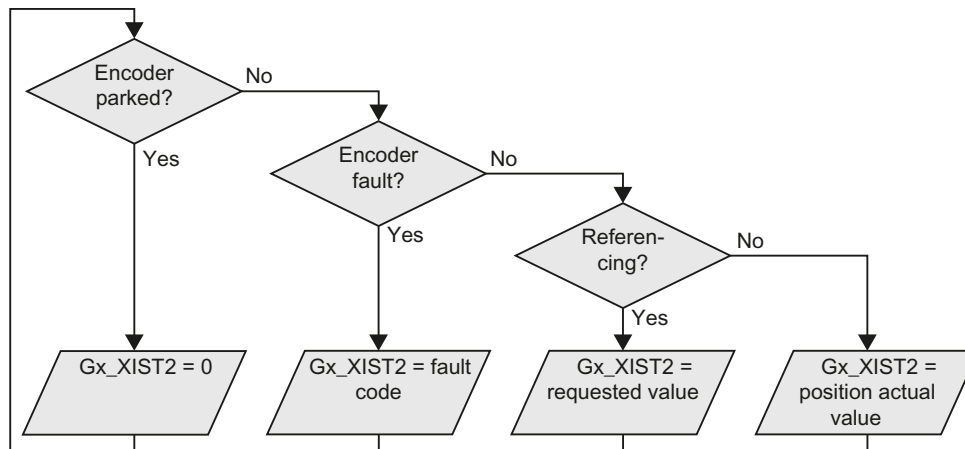

Encoder x parked

Gx_ZSW.14 = 1

Encoder fault x

Gx_ZSW.15 = 1

Referencing encoder x

Gx_ZSW.4 = 1 or Gx_ZSW.5 = 1 or Gx_ZSW.6 = 1 or Gx_ZSW.7 = 1

Figure 6-18 G1_XIST2 and G2_XIST2

The inverter transfers the position values in the same format (encoder pulse number and fine resolution) the same as G1_XIST1 and G2_XIST1.

Table 6-24 Fault code

No.	Explanation	Possible cause
1	Encoder fault	One or more encoder faults. Observe the inverter message.
2	Zero-mark monitoring	---

No.	Explanation	Possible cause
3	Encoder parking canceled	Parking was already requested.
4	Search for reference canceled	<ul style="list-style-type: none"> • Encoder has no zero mark (reference mark). • Reference mark 2, 3 or 4 was requested. • Switchover to "Flying measurement" was requested during search for reference. • Command "Read value x" requested during search for reference mark. • Inconsistent position measured value with distance-coded reference marks.
5	Retrieve reference value canceled	<ul style="list-style-type: none"> • More than four values were requested. • No value requested. • Requested value is not available.
6	Flying referencing canceled	<ul style="list-style-type: none"> • Reference cam has not been configured • During "Flying referencing" a changeover was made to search for reference. • During "Flying referencing" a request was issued "Read value x".
7	Retrieve measured value canceled	<ul style="list-style-type: none"> • More than one value was requested. • No value requested. • Requested value is not available. • Encoder is parked.
8	Position actual value transfer canceled	<ul style="list-style-type: none"> • No absolute encoder available. • Alarm bit in the absolute value protocol set.
3841	Encoder does not support the function	---

6.5.9 Parameter channel

Structure of the parameter channel

The parameter channel consists of four words. The 1st and 2nd words transfer the parameter number, index and the type of task (read or write). The 3rd and 4th words contain the parameter content. The parameter contents can be 16-bit values (such as baud rate) or 32-bit values (e.g. CO parameters).

Bit 11 in the 1st word is reserved and is always assigned 0.

Parameter channel					
PKE (1st word)		IND (2nd word)		PWE (3rd and 4th words)	
15...12;11;	10...0	15...8	7...0	15...0	15...0
AK	S; PNU	Subindex	Page index	PWE 1	PWE 2
	P				
	M				

You can find application examples relating to the parameter channel at the end of this section.

AK: Request and response IDs

Bits 12 ... 15 of the 1st The parameter channel words contain the request and response identifier AK.

Table 6-25 Request identifiers, control → inverter

AK	Description	Response identifier	
		positive	negative
0	No request	0	7 / 8
1	Request parameter value	1 / 2	7 / 8
2	Change parameter value (word)	1	7 / 8
3	Change parameter value (double word)	2	7 / 8
4	Request descriptive element ¹⁾	3	7 / 8
6 ²⁾	Request parameter value (field) ¹⁾	4 / 5	7 / 8
7 ²⁾	Change parameter value (field, word) ¹⁾	4	7 / 8
8 ²⁾	Change parameter value (field, double word) ¹⁾	5	7 / 8
9	Request number of field elements	6	7 / 8

¹⁾ The required element of the parameter is specified in IND (2nd word).

²⁾ The following request IDs are identical: 1 ≡ 6, 2 ≡ 7 3 ≡ 8.

We recommend that you use identifiers 6, 7, and 8.

Table 6-26 Response identifiers, inverter → control

AK	Description
0	No response
1	Transfer parameter value (word)
2	Transfer parameter value (double word)

AK	Description
3	Transfer descriptive element ¹⁾
4	Transfer parameter value (field, word) ²⁾
5	Transfer parameter value (field, double word) ²⁾
6	Transfer number of field elements
7	Inverter cannot process the request. In the most significant word of the parameter channel, the inverter sends an error number to the control, refer to the following table.
8	No master controller status / no authorization to change parameters of the parameter channel interface

¹⁾ The required element of the parameter is specified in IND (2nd word).

²⁾ The required element of the indexed parameter is specified in IND (2nd word).

Table 6-27 Error numbers for response identifier 7

No.	Description
00 hex	Illegal parameter number (access to a parameter that does not exist)
01 hex	Parameter value cannot be changed (change request for a parameter value that cannot be changed)
02 hex	Lower or upper value limit exceeded (change request with a value outside the value limits)
03 hex	Incorrect subindex (access to a subindex that does not exist)
04 hex	No array (access with a subindex to non-indexed parameters)
05 hex	Incorrect data type (change request with a value that does not match the data type of the parameter)
06 hex	Setting not permitted, only resetting (change request with a value not equal to 0 without permission)
07 hex	Descriptive element cannot be changed (change request to a descriptive element error value that cannot be changed)
0B hex	No master control (change request but with no master control, see also p0927.)
0C hex	Keyword missing
11 hex	Request cannot be executed due to the operating state (access is not possible for temporary reasons that are not specified)
14 hex	Inadmissible value (change request with a value that is within the limits but which is illegal for other permanent reasons, i.e. a parameter with defined individual values)
65 hex	Parameter number is currently deactivated (depending on the mode of the inverter)
66 hex	Channel width is insufficient (communication channel is too small for response)
68 hex	Illegal parameter value (parameter can only assume certain values)
6A hex	Request not included / task is not supported (the valid request identifications can be found in table "Request identifications controller → inverter")
6B hex	No change access for a controller that is enabled. (The operating state of the inverter prevents a parameter change)
86 hex	Write access only for commissioning (p0010 = 15) (operating state of the inverter prevents a parameter change)
87 hex	Know-how protection active, access locked
C8 hex	Change request below the currently valid limit (change request to a value that lies within the "absolute" limits, but is however below the currently valid lower limit)

No.	Description
C9 hex	Change request above the currently valid limit (example: a parameter value is too large for the inverter power)
CC hex	Change request not permitted (change is not permitted as the access code is not available)

PNU (parameter number) and page index

The parameter number is located in value PNU in the 1st word of the parameter channel (PKE).

The page index is located in the 2nd word of the parameter channel (IND bit 7 ... 0).

Parameter number	PNU	Page index
0000 ... 1999	0000 ... 1999	0 hex
2000 ... 3999	0000 ... 1999	80 hex
6000 ... 7999	0000 ... 1999	90 hex
8000 ... 9999	0000 ... 1999	20 hex
10000 ... 11999	0000 ... 1999	A0 hex
20000 ... 21999	0000 ... 1999	50 hex
30000 ... 31999	0000 ... 1999	F0 hex
60000 ... 61999	0000 ... 1999	74 hex

Subindex

For indexed parameters, the parameter index is located in subindex (IND Bit 15 ... 8) as hexadecimal value.

PWE: Parameter value or connector

Parameter values or connectors can be located in the PWE.

Table 6-28 Parameter value or connector

	PWE 1	PWE 2	
Parameter value	Bit 15 ... 0	Bit 15 ... 8	Bit 7 ... 0
	0	0	8-bit value
	0	16-bit value	
	32-bit value		
Connector	Bit 15 ... 0	Bit 15 ... 10	Bit 9 ... 0
	Number of the connector	3F hex	The index or bit field number of the connector

Write request: Assign digital input 2 with the function ON/OFF1 (p0840[1] = 722.2)

In order to link digital input 2 with ON/OFF1, you must assign parameter p0840[1] (source, ON/OFF1) the value 722.2 (DI 2). To do this, you must populate the telegram of the parameter channel as follows:

- **PKE, bit 12 ... 15 (AK): = 7 hex** (change parameter value (field, word))
- **PKE, bit 0 ... 10 (PNU): = 348 hex** (840 = 348 hex, no offset, as 840 < 1999)
- **IND, bit 8 ... 15 (subindex): = 1 hex** (CDS1 = Index 1)
- **IND, bit 0 ... 7 (page index): = 0 hex** (offset 0 corresponds to 0 hex)
- **PWE1, Bit 0 ... 15: = 2D2 hex** (722 = 2D2 hex)
- **PWE2, Bit 10 ... 15: = 3F hex** (drive object - for SINAMICS G120, always 63 = 3f hex)
- **PWE2, Bit 0 ... 9: = 2 hex** (Index of Parameter (DI 2 = 2))

Parameter channel																																																																				
PKE, 1st word				IND, 2nd word				PWE1 - high, 3rd word				PWE2 - low, 4th word																																																								
15...12	11	10 ... 0		15 ... 8	7 ... 0			15 ... 0				15 ... 10	9 ... 0																																																							
AK		Parameter number		Subindex	Page index			Parameter value				Drive Object	Index																																																							
0	1	1	1	0	0	1	1	0	1	0	1	0	0	1	0	0	0	0	0	0	0	0	0	0	1	0	0	0	0	0	0	0	0	0	0	0	0	0	0	0	1	0	1	0	1	0	1	0	0	1	0	1	1	1	1	1	1	1	1	0	0	0	0	0	0	0	1	0

Figure 6-21 Telegram, to assign DI 2 with ON/OFF1

6.5.11 Extending the telegram

Overview

When you have selected a telegram, the inverter interconnects the corresponding signals with the fieldbus interface. Generally, these interconnections are locked so that they cannot be changed. However, with the appropriate setting in the inverter, the telegram can be extended or even freely interconnected.

Extending the telegram

Procedure

1. Set p0922 = 999.
2. Set parameter p2079 to the value of the corresponding telegram.
The interconnections contained in the telegram are locked.
3. Extend the telegram by "attaching" additional signals.
Interconnect additional PZD send words and PZD receive words with signals of your choice via parameters r2050 and p2051.

You have extended the telegram.



Freely interconnecting signals in the telegram

Procedure

1. Set p0922 = 999.
2. Set p2079 = 999.
The interconnections contained in the telegram are enabled.
3. Interconnect additional PZD send words and PZD receive words with signals of your choice via parameters r2050 and p2051.

You have freely interconnected the signals transferred in the telegram.



Parameter

Parameter	Description
p0922	PROFIdrive telegram selection
	999: Free telegram (message frame) configuration

Parameter	Description																				
p2079	PROFIdrive PZD telegram selection extended																				
	The following values apply if you have still not enabled the "Basic positioner" function in the inverter:																				
	<table border="0"> <tr><td>1:</td><td>Standard telegram 1, PZD-2/2</td></tr> <tr><td>2:</td><td>Standard telegram 2, PZD-4/4</td></tr> <tr><td>3:</td><td>Standard telegram 3, PZD-5/9</td></tr> <tr><td>4:</td><td>Standard telegram 4, PZD-6/14</td></tr> <tr><td>20:</td><td>Standard telegram 20, PZD-2/6</td></tr> <tr><td>350:</td><td>SIEMENS telegram 350, PZD-4/4</td></tr> <tr><td>352:</td><td>SIEMENS telegram 352, PZD-6/6</td></tr> <tr><td>353:</td><td>SIEMENS telegram 353, PZD-2/2, PKW-4/4</td></tr> <tr><td>354:</td><td>SIEMENS telegram 354, PZD-6/6, PKW-4/4</td></tr> <tr><td>999:</td><td>Free telegram configuration</td></tr> </table>	1:	Standard telegram 1, PZD-2/2	2:	Standard telegram 2, PZD-4/4	3:	Standard telegram 3, PZD-5/9	4:	Standard telegram 4, PZD-6/14	20:	Standard telegram 20, PZD-2/6	350:	SIEMENS telegram 350, PZD-4/4	352:	SIEMENS telegram 352, PZD-6/6	353:	SIEMENS telegram 353, PZD-2/2, PKW-4/4	354:	SIEMENS telegram 354, PZD-6/6, PKW-4/4	999:	Free telegram configuration
	1:	Standard telegram 1, PZD-2/2																			
2:	Standard telegram 2, PZD-4/4																				
3:	Standard telegram 3, PZD-5/9																				
4:	Standard telegram 4, PZD-6/14																				
20:	Standard telegram 20, PZD-2/6																				
350:	SIEMENS telegram 350, PZD-4/4																				
352:	SIEMENS telegram 352, PZD-6/6																				
353:	SIEMENS telegram 353, PZD-2/2, PKW-4/4																				
354:	SIEMENS telegram 354, PZD-6/6, PKW-4/4																				
999:	Free telegram configuration																				
The following values apply if you have enabled the "Basic positioner" function in the inverter:																					
<table border="0"> <tr><td>7:</td><td>Standard telegram 7, PZD-2/2</td></tr> <tr><td>9:</td><td>Standard telegram 9, PZD-10/5</td></tr> <tr><td>110:</td><td>SIEMENS telegram 110, PZD-12/7</td></tr> <tr><td>111:</td><td>SIEMENS telegram 111, PZD-12/12</td></tr> <tr><td>999:</td><td>Free telegram configuration</td></tr> </table>	7:	Standard telegram 7, PZD-2/2	9:	Standard telegram 9, PZD-10/5	110:	SIEMENS telegram 110, PZD-12/7	111:	SIEMENS telegram 111, PZD-12/12	999:	Free telegram configuration											
7:	Standard telegram 7, PZD-2/2																				
9:	Standard telegram 9, PZD-10/5																				
110:	SIEMENS telegram 110, PZD-12/7																				
111:	SIEMENS telegram 111, PZD-12/12																				
999:	Free telegram configuration																				
r2050[0...11]	PROFIdrive PZD receive word Received PZD (setpoints) in the word format																				
p2051[0...16]	PROFIdrive PZD send word Sent PZD (actual values) in the word format																				

6.5.12 Slave-to-slave communication

Overview

"Direct data exchange" is sometimes called "slave-to-slave communication" or "data exchange broadcast". With direct data exchange, slaves exchange data without any direct involvement of the master.

Further information about the "Direct data exchange" function is provided in the Fieldbus function manual.

 Overview of the manuals (Page 519)

6.5.13 Acyclically reading and writing inverter parameters

Overview

The inverter supports the writing and reading of parameters via acyclic communication:

- For PROFIBUS: Up to 240 bytes per write or read request via data set 47
- For PROFINET: Write or read requests via B02E hex and B02F hex

Further information about acyclic communication is provided in the Fieldbus function manual.

 Overview of the manuals (Page 519)

Application example, "Read and write to parameters"

Further information is provided on the Internet:

 Application examples (<https://support.industry.siemens.com/cs/ww/en/view/29157692>)

6.6 Drive control via Modbus RTU



Modbus RTU is used to transfer cyclic process data and acyclic parameter data between precisely one master and up to 247 slaves. The inverter is always the slave, and sends data when requested to do so by the master. Slave-to-slave communication is not possible.

Settings for Modbus RTU

Parameter	Explanation		
p2020	Fieldbus interface baudrate (Factory setting: 7)	5: 4800 baud 6: 9600 baud 7: 19200 baud 8: 38400 baud 9: 57600 baud	10: 76800 baud 11: 93750 baud 12: 115200 baud 13: 187500 baud
p2021	Fieldbus interface address (Factory setting: 1) Valid addresses: 1 ... 247. The parameter is only active if address 0 is set at the Control Unit address switch. A change only becomes effective after the inverter power supply has been switched off and switched on again.		
p2024	Fieldbus interface times (Factory setting: [0] 1000 ms, [2] 0 ms)	[0] Maximum permissible telegram processing time of the Modbus slave [2] dead time between two telegrams	
r2029	Fieldbus interface error statistics	[0] number of error-free telegrams [1] number of rejected telegrams [2] number of framing errors [3] number of overrun errors	[4] number of parity errors [5] number of starting character errors [6] number of checksum errors [7] number of length errors
p2030 = 2	Fieldbus interface protocol selection: Modbus RTU		
p2031	Fieldbus interface Modbus parity (Factory setting: 2)	0: No parity 1: Odd parity 2: Even parity	
p2040	Fieldbus interface monitoring time (Factory setting: 10 s) p2040 = 0: The monitoring is deactivated		

Control word 1 (STW1)

Bit	Significance	Explanation	Signal inter-connection in the inverter
0	0 = OFF1	The motor brakes with the ramp-down time p1121 of the ramp-function generator. The inverter switches off the motor at standstill.	p0840[0] = r2090.0
	0 → 1 = ON	The inverter goes into the "ready" state. If, in addition bit 3 = 1, then the inverter switches on the motor.	

Bit	Significance	Explanation	Signal inter-connection in the inverter
1	0 = OFF2	Switch off the motor immediately, the motor then coasts down to a standstill.	p0844[0] = r2090.1
	1 = No OFF2	The motor can be switched on (ON command).	
2	0 = Quick stop (OFF3)	Quick stop: The motor brakes with the OFF3 ramp-down time p1135 down to standstill.	p0848[0] = r2090.2
	1 = No quick stop (OFF3)	The motor can be switched on (ON command).	
3	0 = Inhibit operation	Immediately switch-off motor (cancel pulses).	p0852[0] = r2090.3
	1 = Enable operation	Switch-on motor (pulses can be enabled).	
4	0 = Disable RFG	The inverter immediately sets its ramp-function generator output to 0.	p1140[0] = r2090.4
	1 = Do not disable RFG	The ramp-function generator can be enabled.	
5	0 = Stop RFG	The output of the ramp-function generator stops at the actual value.	p1141[0] = r2090.5
	1 = Enable RFG	The output of the ramp-function generator follows the setpoint.	
6	0 = Inhibit setpoint	The inverter brakes the motor with the ramp-down time p1121 of the ramp-function generator.	p1142[0] = r2090.6
	1 = Enable setpoint	Motor accelerates with the ramp-up time p1120 to the setpoint.	
7	0 → 1 = Acknowledge faults	Acknowledge fault. If the ON command is still active, the inverter switches to the "switching on inhibited" state.	p2103[0] = r2090.7
8, 9	Reserved		
10	0 = No control via PLC	Inverter ignores the process data from the fieldbus.	p0854[0] = r2090.10
	1 = Control via PLC	Control via fieldbus, inverter accepts the process data from the fieldbus.	
11	1 = Direction reversal	Invert setpoint in the inverter.	p1113[0] = r2090.11
12	Reserved		
13	1 = MOP up	Increase the setpoint saved in the motorized potentiometer.	p1035[0] = r2090.13
14	1 = MOP down	Reduce the setpoint saved in the motorized potentiometer.	p1036[0] = r2090.14
15	Reserved		

Status word 1 (ZSW1)

Bit	Significance	Remarks	Signal inter-connection in the inverter
0	1 = Ready for switching on	Power supply switched on; electronics initialized; pulses locked.	p2080[0] = r0899.0
1	1 = Ready	Motor is switched on (ON/OFF1 = 1), no fault is active. With the command "Enable operation" (STW1.3), the inverter switches on the motor.	p2080[1] = r0899.1

Bit	Significance	Remarks	Signal inter-connection in the inverter
2	1 = Operation enabled	Motor follows setpoint. See control word 1, bit 3.	p2080[2] = r0899.2
3	1 = Fault active	The inverter has a fault. Acknowledge fault using STW1.7.	p2080[3] = r2139.3
4	1 = OFF2 inactive	Coast down to standstill is not active.	p2080[4] = r0899.4
5	1 = OFF3 inactive	Quick stop is not active.	p2080[5] = r0899.5
6	1 = Switching on inhibited active	It is only possible to switch on the motor after an OFF1 followed by ON.	p2080[6] = r0899.6
7	1 = Alarm active	Motor remains switched on; no acknowledgment is necessary.	p2080[7] = r2139.7
8	1 = Speed deviation within the tolerance range	Setpoint / actual value deviation within the tolerance range.	p2080[8] = r2197.7
9	1 = Master control requested	The automation system is requested to accept the inverter control.	p2080[9] = r0899.9
10	1 = Comparison speed reached or exceeded	Speed is greater than or equal to the corresponding maximum speed.	p2080[10] = r2199.1
11	1 = Torque limit not reached	Comparison value for current or torque has been fallen below.	p2080[11] = r0056.13 / r1407.7
12	Reserved		p2080[12] = r0899.12
13	0 = Alarm, motor overtemperature	--	p2080[13] = r2135.14
14	1 = Motor rotates clockwise	Internal inverter actual value > 0	p2080[14] = r2197.3
	0 = Motor rotates counter-clockwise	Internal inverter actual value < 0	
15	0 = Alarm, inverter thermal overload		p2080[15] = r2135.15

1) If you change over from another telegram to telegram 20, then the assignment of the previous telegram is kept.

Further information

Further information about Modbus RTU is provided in the "Fieldbus" function manual.

 Overview of the manuals (Page 519)

6.7 Drive control via USS



USS is used to transfer cyclic process data and acyclic parameter data between precisely one master and up to 31 slaves. The inverter is always the slave, and sends data when requested to do so by the master. Slave-to-slave communication is not possible.

Settings for USS

Parameter	Explanation		
p2020	Fieldbus interface baudrate (Factory setting: 8)	4: 2400 baud 5: 4800 baud 6: 9600 baud 7: 19200 baud 8: 38400 baud	9: 57600 baud 10: 76800 baud 11: 93750 baud 12: 115200 baud 13: 187500 baud
p2021	Fieldbus interface address (Factory setting: 0) Valid addresses: 0 ... 30. The parameter is only active if address 0 is set at the Control Unit address switch. A change only becomes effective after the inverter power supply has been switched off and switched on again.		
p2022	Fieldbus interface USS PZD number (Factory setting: 2)		
p2023	Fieldbus interface USS PKW number (Factory setting: 127)	0: PKW 0 words 3: PKW 3 words 4: PKW 4 words 127: PKW variable	
p2024	Fieldbus interface times (Factory setting: [0] 1000 ms, [1] 0 ms, [2] 0 ms)	[0] Maximum permissible telegram processing time of the Modbus slave [1] Character delay time [2] dead time between two telegrams	
r2029	Fieldbus interface error statistics	[0] number of error-free telegrams [1] number of rejected telegrams [2] number of framing errors [3] number of overrun errors	[4] number of parity errors [5] number of starting character errors [6] number of checksum errors [7] number of length errors
p2030 = 1	Fieldbus interface protocol selection: USS		
p2031	Fieldbus interface Modbus parity (Factory setting: 2)	0: No parity 1: Odd parity 2: Even parity	
p2040	Fieldbus interface monitoring time (Factory setting: 100 ms) p2040 = 0: The monitoring is deactivated		

Control word 1 (STW1)

Bit	Significance	Explanation	Signal inter-connection in the inverter
0	0 = OFF1	The motor brakes with the ramp-down time p1121 of the ramp-function generator. The inverter switches off the motor at standstill.	p0840[0] = r2090.0
	0 → 1 = ON	The inverter goes into the "ready" state. If, in addition bit 3 = 1, then the inverter switches on the motor.	
1	0 = OFF2	Switch off the motor immediately, the motor then coasts down to a standstill.	p0844[0] = r2090.1
	1 = No OFF2	The motor can be switched on (ON command).	
2	0 = Quick stop (OFF3)	Quick stop: The motor brakes with the OFF3 ramp-down time p1135 down to standstill.	p0848[0] = r2090.2
	1 = No quick stop (OFF3)	The motor can be switched on (ON command).	
3	0 = Inhibit operation	Immediately switch-off motor (cancel pulses).	p0852[0] = r2090.3
	1 = Enable operation	Switch-on motor (pulses can be enabled).	
4	0 = Disable RFG	The inverter immediately sets its ramp-function generator output to 0.	p1140[0] = r2090.4
	1 = Do not disable RFG	The ramp-function generator can be enabled.	
5	0 = Stop RFG	The output of the ramp-function generator stops at the actual value.	p1141[0] = r2090.5
	1 = Enable RFG	The output of the ramp-function generator follows the setpoint.	
6	0 = Inhibit setpoint	The inverter brakes the motor with the ramp-down time p1121 of the ramp-function generator.	p1142[0] = r2090.6
	1 = Enable setpoint	Motor accelerates with the ramp-up time p1120 to the setpoint.	
7	0 → 1 = Acknowledge faults	Acknowledge fault. If the ON command is still active, the inverter switches to the "switching on inhibited" state.	p2103[0] = r2090.7
8, 9	Reserved		
10	0 = No control via PLC	Inverter ignores the process data from the fieldbus.	p0854[0] = r2090.10
	1 = Control via PLC	Control via fieldbus, inverter accepts the process data from the fieldbus.	
11	1 = Direction reversal	Invert setpoint in the inverter.	p1113[0] = r2090.11
12	Reserved		
13	1 = MOP up	Increase the setpoint saved in the motorized potentiometer.	p1035[0] = r2090.13
14	1 = MOP down	Reduce the setpoint saved in the motorized potentiometer.	p1036[0] = r2090.14
15	Reserved		

Status word 1 (ZSW1)

Bit	Significance	Remarks	Signal inter-connection in the inverter
0	1 = Ready for switching on	Power supply switched on; electronics initialized; pulses locked.	p2080[0] = r0899.0
1	1 = Ready	Motor is switched on (ON/OFF1 = 1), no fault is active. With the command "Enable operation" (STW1.3), the inverter switches on the motor.	p2080[1] = r0899.1
2	1 = Operation enabled	Motor follows setpoint. See control word 1, bit 3.	p2080[2] = r0899.2
3	1 = Fault active	The inverter has a fault. Acknowledge fault using STW1.7.	p2080[3] = r2139.3
4	1 = OFF2 inactive	Coast down to standstill is not active.	p2080[4] = r0899.4
5	1 = OFF3 inactive	Quick stop is not active.	p2080[5] = r0899.5
6	1 = Switching on inhibited active	It is only possible to switch on the motor after an OFF1 followed by ON.	p2080[6] = r0899.6
7	1 = Alarm active	Motor remains switched on; no acknowledgment is necessary.	p2080[7] = r2139.7
8	1 = Speed deviation within the tolerance range	Setpoint / actual value deviation within the tolerance range.	p2080[8] = r2197.7
9	1 = Master control requested	The automation system is requested to accept the inverter control.	p2080[9] = r0899.9
10	1 = Comparison speed reached or exceeded	Speed is greater than or equal to the corresponding maximum speed.	p2080[10] = r2199.1
11	1 = Torque limit not reached	Comparison value for current or torque has been fallen below.	p2080[11] = r0056.13 / r1407.7
12	Reserved		p2080[12] = r0899.12
13	0 = Alarm, motor overtemperature	--	p2080[13] = r2135.14
14	1 = Motor rotates clockwise	Internal inverter actual value > 0	p2080[14] = r2197.3
	0 = Motor rotates counter-clockwise	Internal inverter actual value < 0	
15	0 = Alarm, inverter thermal overload		p2080[15] = r2135.15

¹⁾ If you change over from another telegram to telegram 20, then the assignment of the previous telegram is kept.

Further information

Further information about USS is provided in the "Fieldbus" function manual.

 Overview of the manuals (Page 519)

6.8 Drive control via Ethernet/IP



EtherNet/IP is an Ethernet-based fieldbus. EtherNet/IP is used to transfer cyclic process data as well as acyclic parameter data.

Settings for Ethernet/IP

Parameter	Explanation		
p2030 = 10	Fieldbus interface protocol selection: Ethernet/IP		
p8920	PN Name of Station		
p8921	PN IP address (Factory setting: 0)		
p8922	PN default gateway (factory setting: 0)		
p8923	PN Subnet Mask (Factory setting: 0)		
p8924	PN DHCP mode (Factory setting: 0)	0: DHCP off 2: DHCP on, identification based on MAC address 3: DHCP on, identification based on Name of Station	
p8925	PN interface configuration (Factory setting: 0)	0: No function 1: Reserved 2: Save the configuration and activate 3: Delete configuration	
p8980	Ethernet/IP profile (Factory setting: 0) A change only becomes effective after the inverter power supply has been switched off and switched on again.	0: SINAMICS 1: ODVA AC/DC	
p8982	Ethernet/IP ODVA speed scaling (Factory setting: 128) A change only becomes effective after the inverter power supply has been switched off and switched on again.		
	123: 32	127: 2	131: 0.125
	124: 16	128: 1	132: 0.0625
	125: 8	129: 0.5	133: 0.03125
	126: 4	130: 0.25	

Further information

Further information about USS is provided in the "Fieldbus" function manual.



Overview of the manuals (Page 519)

6.9 Drive control via CANopen

The most important settings for CANopen

Parameter	Explanation			
p8620	CAN Node ID (Factory setting: 126) Valid addresses: 1 ... 247. The parameter is only active if address 0 is set at the Control Unit address switch. A change only becomes effective after the inverter power supply has been switched off and switched on again.			
p8622	CAN Bit rate (Factory setting: 6)	0: 1 Mbit/s 1: 800 kbit/s 2: 500 kbit/s	3: 250 kbit/s 4: 125 kbit/s 5: 50 kbit/s	6: 20 kbit/s 7: 10 kbit/s
p8700 ... p8707	CAN Receive PDO n (n = 1 ... 8)	[0] = COB-ID of the PDO [1] = Transmission Type of the PDO		
p8710 ... p8717	CAN Receive Mapping for RPDO n (n = 1 ... 8)	[0] = Mapped object 1 ... [3] = Mapped object 4		
p8720 ... p8727	CAN Transmit PDO n (n = 1 ... 8)	[0] = COB-ID of the PDO [1] = Transmission Type of the PDO [2] = Inhibit Time (in 100 µs) [3] = reserved [4] = Event Timer (in ms)		
p8730 ... p8737	CAN Transmit Mapping for TPDO n (n = 1 ... 8)	[0] = Mapped object 1 ... [3] = Mapped object 4		
p8744	CAN PDO Mapping Configuration (Factory setting: 2)	1: Predefined connection set 2: Free PDO mapping		
r8784	CAN status word	.00 Ready to switch on .01 Ready .02 Operation enabled .03 Fault active .04 No coast down active .05 No fast stop active .06 Switching on inhibited active .07 Alarm active	.08 Can be freely interconnected (p8785) .09 Control requested .10 Target reached .11 Torque limit reached .12 Velocity equal to zero .14 Can be freely interconnected (p8786) .15 Can be freely interconnected (p8787)	
r8795	CAN control word	.00 ON/OFF1 .01 Do not activate coast down .02 Do not activate quick stop .03 Enable operation .04 Enable ramp-function generator .05 Freeze ramp-function generator continuation	.06 Enable speed setpoint .07 Acknowledge fault .08 Stop .11 Can be freely interconnected15 Can be freely interconnected	

Further information

Further information about CANopen is provided in the "Fieldbus" function manual.

 Overview of the manuals (Page 519)

6.10 Jogging



The "Jog" function is typically used to temporarily move a machine part using local control commands, e.g. a transport conveyor belt.

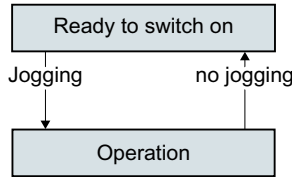

Commands "Jog 1" or "Jog: 2" switch the motor on and off.

The commands are only active when the inverter is in the "Ready for switching on" state.

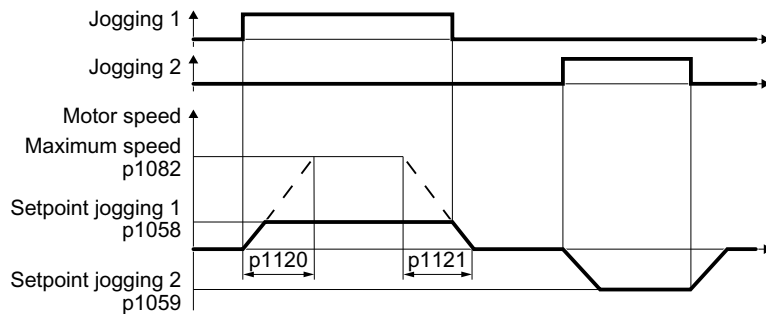

Figure 6-22 Behavior of the motor when "jogging"

After switching on, the motor accelerates to the setpoint, jog 1 or setpoint, jog 2. The two different setpoints can, for example, be assigned to motor clockwise and counter-clockwise rotation.

When jogging, the same ramp-function generator is active as for the ON/OFF1 command.

Jog settings

Parameter	Description	
p1058	Jogging 1 speed setpoint (factory setting 150 rpm)	
p1059	Jogging 2 speed setpoint (factory setting -150 rpm)	
p1082	Maximum speed (factory setting 1500 rpm)	
p1110	Inhibit negative direction	
	=0: Negative direction of rotation is enabled	=1: Negative direction of rotation is inhibited
p1111	Inhibit positive direction	
	=0: Positive direction of rotation is enabled	=1: Positive direction of rotation is inhibited
p1113	Setpoint inversion	
	=0: Setpoint is not inverted	=1: Setpoint is inverted
p1120	Ramp-function generator ramp-up time (factory setting 10 s)	
p1121	Ramp-function generator ramp-down time (factory setting 10 s)	

Parameter	Description
p1055 = 722.0	Jog bit 0: Select jogging 1 via digital input 0
p1056 = 722.1	Jog bit 1: Select jogging 2 via digital input 1

6.11 Limit position control

Limit position and limit switch

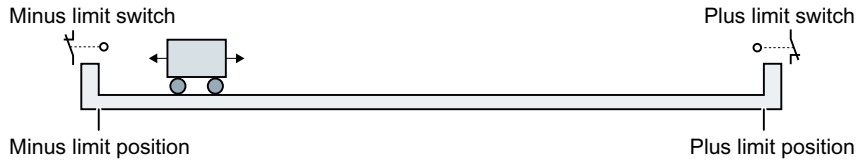

A limit position is a position in the direction of motion of a machine component at which the motion stops due to the construction. A limit switch is a sensor that signals that the limit position has been reached.

Function

The limit position control moves the motor depending on two limit switch signals:

- When a limit position is reached, the inverter stops the motor.
- At a limit position, the inverter starts the motor with a new motion command in the direction of the opposite limit position.
- If neither of the limit positions has been reached when the power is switched on, the polarity of the speed setpoint decides in which direction the motor is to start with the first motion command.

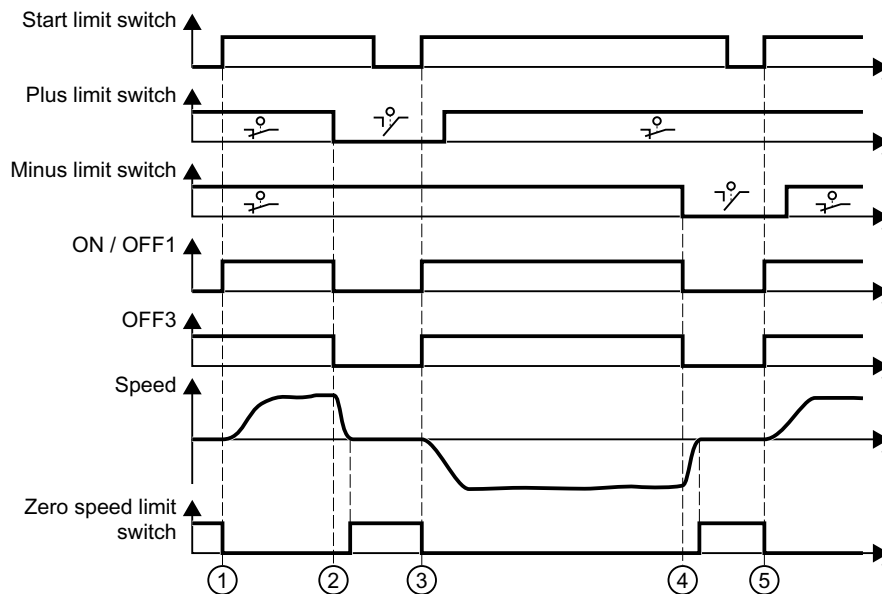

- ① The motor moves the machine component in the direction of the positive limit position.
- ② The positive limit position has been reached. The motor stops with the OFF3 ramp-down time.
- ③ The motor moves the machine component in the opposite direction at a 0 → 1 signal change.
- ④ The negative limit position has been reached. The motor stops with the OFF3 ramp-down time.
- ⑤ The motor moves the machine component in the opposite direction at a 0 → 1 signal change.

Figure 6-23 Limit position control of the inverter

Parameter	Explanation	
p3340[0 ... n]	Start limit switch	1 signal: Start is active 0 signal: Start is inactive
p3342[0 ... n]	Minus limit switch	1 signal: Limit switch is inactive
p3343[0 ... n]	Plus limit switch	0 signal: Limit switch is active
r3344	Limit switch ON/OFF	
	.00	1 signal: Limit switch ON 0 signal: Limit switch OFF1
	.01	1 signal: Limit switch no OFF3 0 signal: Limit switch OFF3
	.02	1 signal: Limit switch, axis stationary (standstill)
	.04	1 signal: Plus limit switch actuated
	.05	1 signal: Minus limit switch actuated

6.12 Switching over the drive control (command data set)



Several applications require the option of switching over the control authority to operate the inverter.

Example: The motor is to be operable either from a central control via the fieldbus or via the local digital inputs of the inverter.

Command data set (CDS)

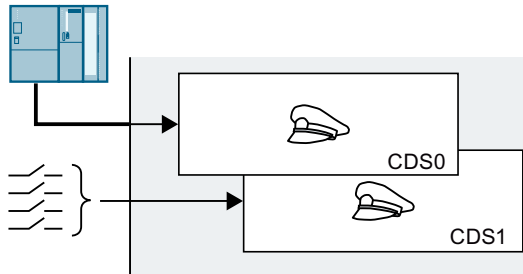

This means that you can set the inverter control in various ways and toggle between the settings. For instance, as described above, the inverter can either be operated via a fieldbus or via its digital inputs.

The settings in the inverter, which are assigned to a specific master control, are termed the command data set.

You select the command data set using parameter p0810. To do this, you must interconnect parameter p0810 with a control command of your choice, e.g. a digital input.

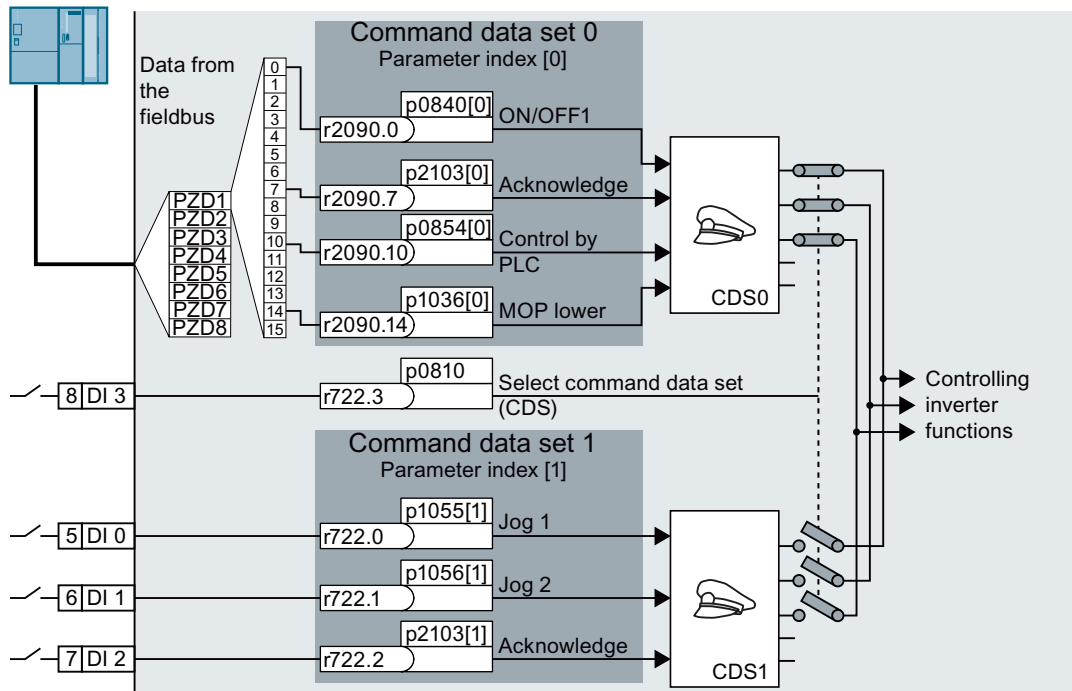

Figure 6-24 Example: Switching over the control via terminal strip to control via PROFIBUS or PROFINET

An overview of all the parameters that belong to the command data sets is provided in the List Manual.

Note

It takes approximately 4 ms to toggle between command data sets.

Changing the number of command data sets

Procedure

1. Set p0010 = 15.
2. The number of command data sets is configured with p0170.
3. Set p0010 = 0.

You have changed the number of command data sets.



Copying command data sets

Procedure

1. Set p0809[0] to the number of the command data set whose settings you wish to copy (source).
2. Set p0809[1] to the number of the command data set in which you wish to copy the settings.
3. Set p0809[2] = 1
4. The inverter sets p0809[2] = 0.

You have copied the settings of a command data set into another command data set.



Parameter

Parameter	Description
p0010	Drive commissioning parameter filter
r0050	Command data set CDS active Displays the number of the currently active command data set
p0170	Number of command data sets (CDS) (factory setting: 2) p0170 = 2, 3 or 4
p0809[0]	Copying the command data set CDS (factory setting: 0) [0] Source command data set [1] Target command data set [2] 0→1: Starts the copy operation
p0810	Command data set selection CDS bit 0
p0811	Command data set selection CDS bit 1

6.13 Motor holding brake



The motor holding brake holds the motor in position when it is switched off.

When the "Motor holding brake" function is correctly set, the motor remains switched on as long as the motor holding brake is open. The inverter only switches the motor off when the motor holding brake is closed.

Function

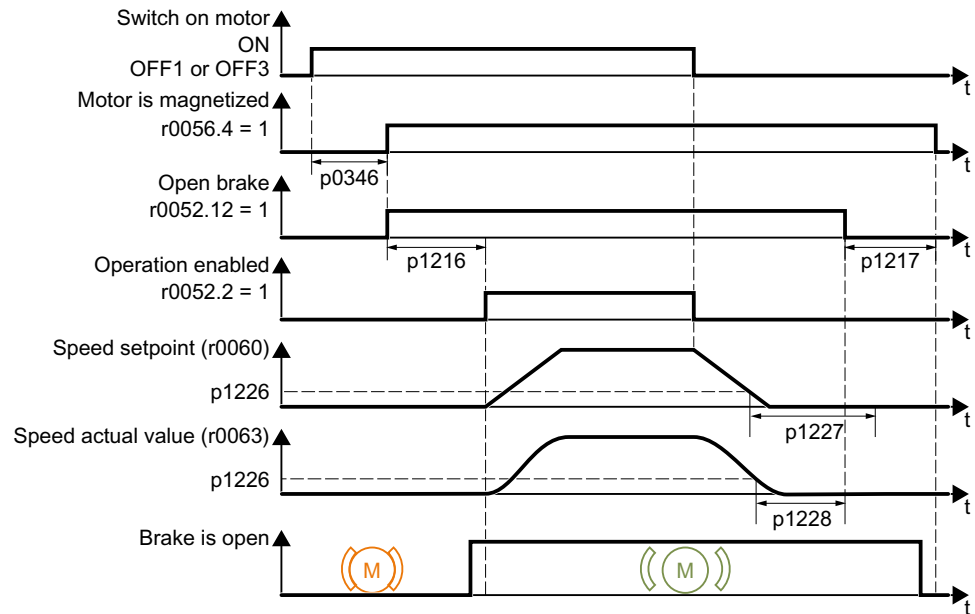

Figure 6-25 Motor holding brake function

After the ON command

1. With the ON command, the inverter switches the motor on.
2. At the end of the "motor excitation build-up time" (p0346), the inverter issues the command to open the brake.
3. The inverter keeps the motor at a standstill until the "motor holding brake opening time" p1216 has ended.
The motor holding brake must be opened within time p1216.
4. The inverter accelerates the motor to the speed setpoint.

After the OFF1 or OFF3 command

1. The inverter brakes the motor down to a standstill using the OFF1 or OFF3 command.
2. When braking, the inverter compares the speed setpoint and the actual speed with the "standstill detection speed threshold" p1226:
 - Speed setpoint < p1226: The "standstill detection monitoring time" p1227 starts
 - Current speed < p1226: The "pulse cancellation deceleration time" p1228 starts

3. When the first of the two times (p1227 or p1228) has elapsed, the inverter issues the command to close the brake.
4. After the "motor holding brake closing time" p1217, the inverter switches off the motor. The motor holding brake must close within the time p1217.

After the OFF2 command

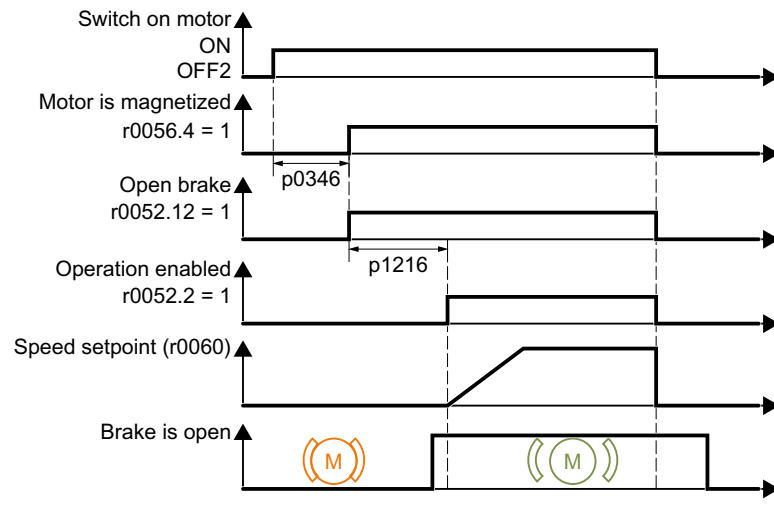

Figure 6-26 Controlling the motor holding brake after OFF2

After the OFF2 command, the inverter issues the signal to immediately close the motor holding brake, irrespective of the motor speed.

Commissioning a motor holding brake

Precondition

The motor holding brake is connected to the inverter.

WARNING

Load can fall if the "Motor holding brake" function is incorrectly set

For applications with a suspended load, such as cranes and elevators, there is a danger to life if the "Motor holding brake" function is not completely set or is incorrectly set.

- When commissioning the "Motor holding brake" function, secure any suspended loads, e.g. by applying the following measures:
 - Lower the load down to the floor.
 - Secure the dangerous area so that nobody can inadvertently enter it.
- Set the "Motor holding brake" function according to the following description.
- After commissioning, check that the motor holding brake and the motor control function reliably.
- For applications involving suspended loads, we recommend that you use vector control together with an encoder.

Procedure

1. Set p1215 = 1.
The "Motor holding brake" function is enabled.
2. Check the magnetizing time p0346.
The magnetizing time must be greater than zero. The inverter assigns the magnetizing time when it is being commissioned.
3. Find out the mechanical opening and closing times from the technical data of the motor holding brake.
 - Depending on the brake size, brake opening times lie between 25 ms and 500 ms.
 - Depending on the brake size, brake closing times lie between 15 ms and 300 ms.
4. Set the following parameters in the inverter suitably for the mechanical opening and closing times of the motor holding brake:
 - p1216 \geq mechanical opening time of the motor holding brake
 - p1217 > mechanical closing time of the motor holding brake
5. Switch on the motor.
6. Check the acceleration behavior of the drive immediately after the motor has been switched on:
 - If the motor holding brake opens too late, the inverter will accelerate the motor suddenly against the closed motor holding brake.
Set p1216 larger.
 - If the motor waits too long before accelerating after the motor holding brake has opened, reduce p1216.
For applications involving a pulling load, e.g. lifting gear/crane, if p1216 is too long, then the load can briefly sag/sink after the motor holding brake is opened. If you reduce p1216, then the amount that the load sags/sinks is reduced.
7. If the load sags after switching on the motor, then you must increase the motor torque when opening the motor holding brake. Depending on the control mode, you must set different parameters:
 - U/f control (p1300 = 0 to 3):
Increase p1310 in small steps.
Increase p1351 in small steps.
 - Vector control (p1300 \geq 20):
Increase p1475 in small steps.
8. Switch off the motor.
9. Check the behavior of the drive immediately after the motor has been switched off:
 - If the motor holding brake closes too late, the load briefly sags before the motor holding brake closes.
Set a larger value for p1217.
 - If the motor waits too long before switching off after the motor holding brake has closed, reduce p1217.

The "Motor holding brake" function has been commissioned.



Table 6-29 Setting the control logic of the motor holding brake

Parameter	Description
p1215 = 1	Enable motor holding brake 0 Motor holding brake locked (factory setting) 1 Motor holding brake just like the sequence control 2: Motor holding brake permanently open 3: Motor holding brake just like the sequential control, connected via BICO
p1216	Motor holding brake opening time (factory setting 0.1 s) p1216 > braking signal relay runtimes + brake release time
p1217	Motor holding brake closing time (factory setting 0.1 s) p1217 > braking signal relay runtimes + brake closing time
r0052.12	"Open motor holding brake" command

Table 6-30 Advanced settings

Parameter	Description
p0346	Magnetizing time (factory setting 0 s) During this time the induction motor is magnetized. The inverter calculates this parameter using p0340 = 1 or 3.
p0855	Open motor holding brake (imperative) (factory setting 0)
p0858	Close motor holding brake (imperative) (factory setting 0)
p1226	Stationary state detection speed threshold (factory setting 20 rpm) When braking with OFF1 or OFF3, when the speed falls below this threshold, standstill is detected and the monitoring time p1227 or p1228 is started
p1227	Stationary state detection monitoring time (factory setting 300 s)
p1228	Pulse deletion delay time (factory setting 0.01 s)
p1351	Starting frequency, motor holding brake (factory setting 0%) Setting the frequency set value at the slip compensation output when starting with motor holding brake. When the parameter p1351 is set to > 0, slip compensation is automatically switched on.
p1352	Starting frequency for motor holding brake (factory setting 1351) Setting the signal source for the frequency set value at the slip compensation output when starting with motor holding brake.
p1475	Speed controller torque set value for motor holding brake (factory setting 0) Setting the signal source for the torque set value when starting with motor holding brake.

6.14 Free function blocks

6.14.1 Overview



The free function blocks permit configurable signal processing in the inverter.

The following free function blocks are available:

- AND, OR, XOR, and NOT logic
- RSR (RS flip-flop), DSR (D flip-flop) flip-flops
- Timers MFP (pulse generator), PCL (pulse shortening), PDE (ON delay), PDF (OFF delay), and PST (pulse stretching)
- ADD (adder), SUB (subtractor), MUL (multiplier), DIV (divider), AVA (absolute value generated), NCM (comparator), and PLI (polyline) arithmetic functions
- LIM (limiter), PT1 (smoothing), INT (integrator), DIF (differentiator) controllers
- NSW (analog) BSW (binary) switches
- LVM limit value monitoring

The number of free function blocks in the inverter is limited. You can only use a function block once. The inverter has 3 adders, for instance. If you have already configured three adders, then no other adders are available.

6.14.2 Runtime groups and run sequence

In order to activate a free function block, you must assign it to a runtime group.

There are 6 runtime groups, which the inverter calculates with different time slices.

Table 6-31 Permissible runtime groups of the free function blocks

Runtime group	1	2	3	4	5	6
Time slice	8 ms	16 ms	32 ms	64 ms	128 ms	256 ms
AND, OR, XOR, NOT, RSR, DSR, BSW	✓	✓	✓	✓	✓	✓
ADD, SUB, MUL, DIV, AVA, NCM, PLI, MFP, PCL, PDE, PDF, PST, NSW, LIM, PT1, INT, DIF, LVM	-	-	-	-	✓	✓

✓: You can assign the free function blocks to this runtime group

-: A free function block is not possible in this runtime group

You can define a run sequence (0 ... 32000) within a runtime group. The inverter calculates the function blocks in an ascending run sequence.

6.14.3 List of the free function blocks

ADD (adder)

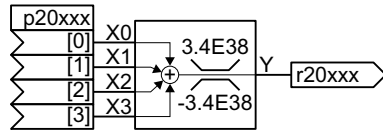

$$Y = X0 + X1 + X2 + X3$$

The function block adds inputs X0 ... X3, and limits the result in the range -3.4E38 ... 3.4E38.

	ADD 0	ADD 1	ADD 2
X0 ... X3	p20094[0 ... 3]	p20098[0 ... 3]	p20308[0 ... 3]
Y	r20095	r20099	r20309
Runtime group	p20096	p20100	p20310
Run sequence	p20097	p20101	p20311

AND (AND block)

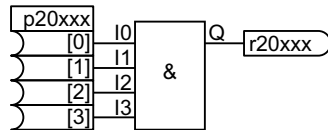

$$Q = I1 \& I2 \& I3 \& I4$$

If a value of 1 is available at all inputs I0 ... I3, then Q = 1. In all other cases, output Q = 0.

	AND 0	AND 1	AND 2	AND 3
I0 ... I3	p20030[0 ... 3]	p20034[0 ... 3]	p20038[0 ... 3]	p20042[0 ... 3]
Q	r20031	r20035	r20039	r20043
Runtime group	p20032	p20036	p20040	p20044
Run sequence	p20033	p20037	p20041	p20045

AVA (absolute value generator)

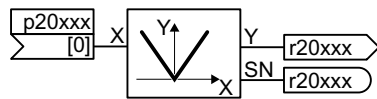

$$Y = \text{abs}(X)$$

This function block calculates the absolute value of the value present at input X.

When $X < 0$, then the inverter sets SN = 1.

	AVA 0	AVA 1
X	p20128[0]	p20133[0]
Y	r20129	r20134
SN	r20130	r20135
Runtime group	p20131	p20136
Run sequence	p20132	p20137

BSW (binary changeover switch)

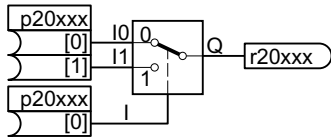

This function block switches one of two binary input variables to the output:

When I = 0, then Q = I0.

When I = 1, then Q = I1.

	BSW 0	BSW 1
I0, I1	p20208[0, 1]	p20213[0, 1]
I	p20209[0]	p20214[0]
Q	r20210	r20215
Runtime group	p20211	p20216
Run sequence	p20212	p20217

DFR (D flip-flop)

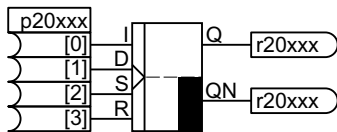

D flip-flop, reset dominant.

Table 6-32 Truth table

D	I	S	R	Q	QN
0	0	0	0	No change	
1	↑	0	0	1	0
0	↑	0	0	0	1
0	0	1	0	1	0
0	0	0	1	0	1
0	0	1	1	0	1

	DFR 0	DFR 1	DFR 2
I, D, S, R	p20198[0 ... 3]	p20203[0 ... 3]	p20329[0 ... 3]
Q	r20199	r20204	r20330
QN	r20200	r20205	r20331
Runtime group	p20201	p20206	p20332
Run sequence	p20202	p20207	p20333

DIF (differentiator)

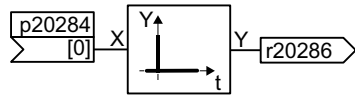

$$Y_n = (X_n - X_{n-1}) \times T_D / T_{zyk}$$

Output Y is proportional to the rate of change of input X.

DIF 0	
T_D	p20285
Runtime group	p20287
Run sequence	p20288

DIV (divider)

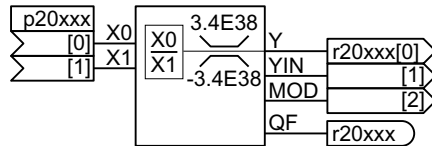

$$Y = X0 / X1$$

The function block divides the inputs and limits the result in the range -3.4E38 ... 3.4E38. With a division of 0/0, Y remains unchanged.

Significance of other outputs:

- YIN: Integer quotient
- MOD = (Y - YIN) × X0 (remainder of the division)
- QF: The inverter sets QF = 1 when output value Y exceeds the permissible value range or for division by zero.

	DIV 0	DIV 1
X0, X1	p20118[0, 1]	p20123[0, 1]
Y, YIN, MOD	p20119[0 ... 2]	p20124[0 ... 2]
QF	r20120	r20125
Runtime group	p20121	p20126
Run sequence	p20122	p20127

INT (integrator)

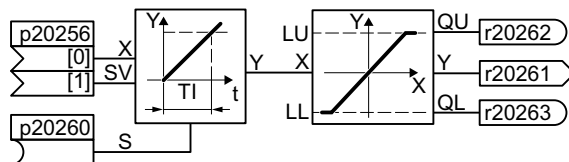

$$Y_n = Y_{n+1} + T_{cyc} / T_l \times X_n$$

The rate of change of output quantity Y is proportional to input quantity X.

The inverter limits output Y to values LU and LO. Also see limiter LIM.

As long as S = 1, then the inverter sets Y = SV.

INT 0			
LU	p20257	Runtime group	p20264
LO	p20258	Run sequence	p20265
T _i	p20259		

LIM (limiter)

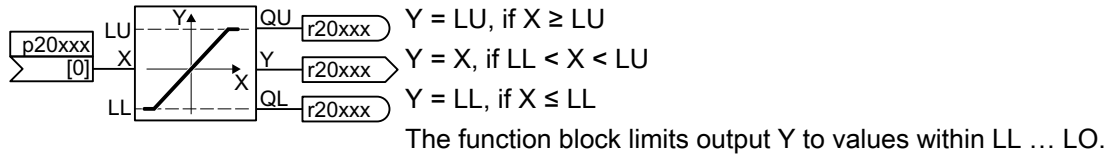

	LIM 0	LIM 1
X	p20228[0]	p20236[0]
LU	p20229	p20237
LL ¹⁾	p20230	p20238
Y	r20231	r20239
QU	r20232	r20240
QL	r20233	r20241
Runtime group	p20096	p20100
Run sequence	p20097	p20101

¹⁾ LU must be less than LO

LVM (limit monitor)

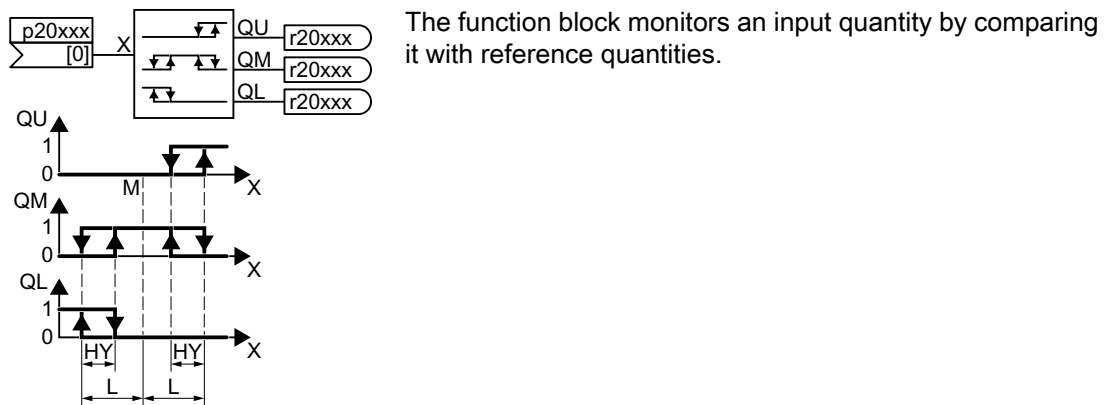

	LVM 0	LVM 1
X	p20266[0]	p20275[0]
M	p20267	p20276
L	p20268	p20277

	LVM 0	LVM 1
HY	p20269	p20278
QU	r20270	r20279
QM	r20271	r20280
QL	r20272	r20281
Runtime group	p20096	p20100
Run sequence	p20097	p20101

MFP - pulse generator

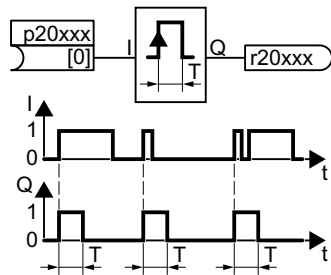

The pulse generator generates a pulse with a fixed duration.

The rising edge of a pulse at input I sets output

$Q = 1$ for pulse duration T.

The pulse generator cannot be subsequently triggered.

	MFP 0	MFP 1	MFP 2	MFP 3
I	p20138[0]	p20143[0]	p20354[0]	p20359[0]
T	p20139	p20144	p20355	p20360
Q	r20140	p20145	p20356	p20361
Runtime group	p20141	p20146	p20357	p20362
Run sequence	p20142	p20147	p20358	p20363

MUL (multiplier)

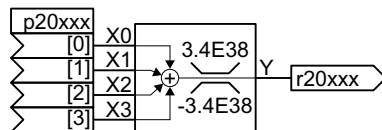

$$Y = X0 \times X1 \times X2 \times X3$$

The function block multiplies inputs $X0 \dots X3$, and limits the result in the range $-3.4E38 \dots 3.4E38$.

	MUL 0	MUL 1
$X0 \dots X3$	p20110[0 ... 3]	p20114[0 ... 3]
Y	r20111	r20115
Runtime group	p20112	p20116
Run sequence	p20113	p20117

NCM (numeric comparator)

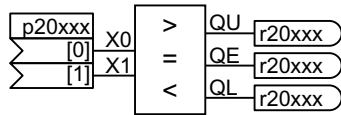

The function block compares two inputs with one another.

Table 6-33 Function table

Comparing inputs	QU	QE	QL
X0 > X1	1	0	0
X0 = X1	0	1	0
X0 < X1	0	0	1

	NCM 0	NCM 1
X0, X1	p20312[0, 1]	p203182[0, 1]
QU	r20313	r20319
QE	r20314	r20320
QL	r20315	r20321
Runtime group	p20316	p20322
Run sequence	p20317	p20323

NOT (inverter)

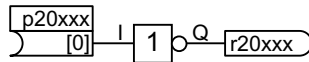

The function block inverts the input:

$I = 0 \Rightarrow Q = 1$

$I = 1 \Rightarrow Q = 0$

	NOT 0	NOT 1	NOT 2	NOT 3	NOT 4	NOT 5
I	p20078[0]	p20082[0]	p20086[0]	p20090[0]	p20300[0]	p20304[0]
Q	r20079	r20083	r20087	r20091	r20301	r20305
Runtime group	p20080	p20084	p20088	p20092	p20302	p20306
Run sequence	p20081	p20085	p20089	p20093	p20303	p20307

NSW (numeric changeover switch)

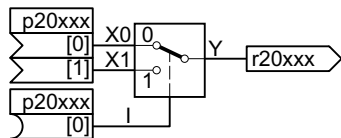

This function block switches one of two numeric input variables to the output:

When I = 0, then Y = X0.

When I = 1, then Y = X1.

	NSW 0	NSW 1
X0, X1	p20218[0, 1]	p20223[0, 1]
I	p20219[0]	p20224[0]
Y	r20220	r20225
Runtime group	p20221	p20226
Run sequence	p20222	p20227

OR (OR block)

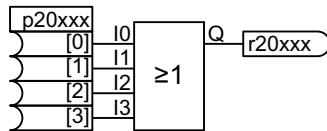

$$Q = I1 \vee I2 \vee I3 \vee I4$$

If a value of 0 is available at all inputs I0 ... I3, then Q = 0.

In all other cases, output Q = 1.

	OR 0	OR 1	OR 2	OR 3
I0 ... I3	p20046[0 ... 3]	p20050[0 ... 3]	p20054[0 ... 3]	p20058[0 ... 3]
Q	r20047	r20051	r20055	r20059
Runtime group	p20048	p20052	p20056	p20060
Run sequence	p20049	p20053	p20057	p20061

PCL (pulse shortener)

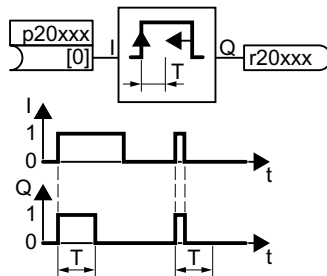

The pulses shortener limits the pulse duration.

The rising edge of a pulse at input I, sets Q = 1.

When I = 0 or if pulse duration T has expired, then function block sets Q = 0.

	PCL 0	PCL 1
I	p20148[0]	p20153[0]
T	p20149	p20154
Q	r20150	r20155
Runtime group	p20151	p20156
Run sequence	p20152	p20157

PDE (ON delay)

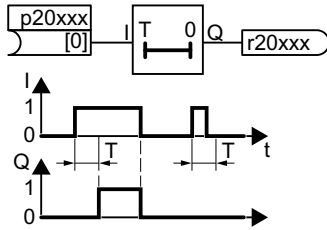

The rising edge of a pulse at input I sets output Q = 1 after pulse delay time T.

When I = 0, then the function block sets Q = 0.

	PDE 0	PDE 1	PDE 2	PDE 3
I	p20158[0]	p20163[0]	p20334[0]	p20339[0]
T	p20159	p20164	p20335	p20340
Q	r20160	r20165	r20336	r20341
Runtime group	p20161	p20166	p20337	p20342
Run sequence	p20162	p20167	p20338	p20343

PDF (OFF delay)

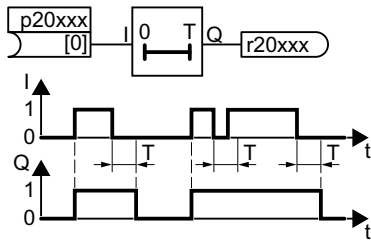

When I = 1, then the function block sets Q = 1.

The falling edge of a pulse at input I sets output Q = 0 after OFF delay time T.

When input I returns to 1 before time T has expired, output Q remains 1.

	PDF 0	PDF 1	PDF 2	PDF 3
I	p20168[0]	p20173[0]	p20344[0]	p20349[0]
T	p20169	p20174	p20345	p20350
Q	r20170	r20175	r20346	r20351
Runtime group	p20171	p20176	p20347	p20352
Run sequence	p20172	p20177	p20348	p20353

PLI (polyline)

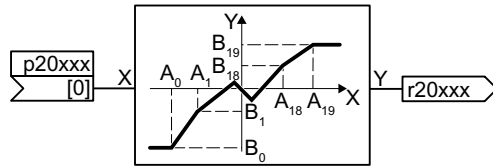

The function block adapts output Y to input X along 20 interpolation points (A_0, B_0) ... (A_{19}, B_{19}).

The function block linearly interpolates between the interpolation points. The characteristic is horizontal outside A_0 and A_{19} .

The values A_0 ... A_{19} must be in ascending order.

Interpolation points that are not required must be set to the values of the last interpolation point required.

	PLI 0	PLI 1
X	p20372[0]	p20378[0]
Y	r20373	r20379
A_0 ... A_{19}	p20374[0 ... 19]	p20380[0 ... 19]
B_0 ... B_{19}	p20375[0 ... 19]	p20381[0 ... 19]
Runtime group	p20376	p20382
Run sequence	p20377	p20383

PST (pulse stretcher)

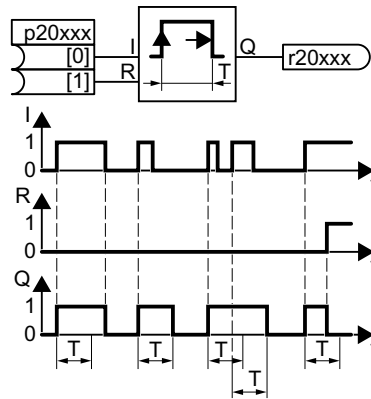

The function block generates a pulse with a defined length.

The rising edge of a pulse at input I sets output Q = 1.

When I = 0 and pulse duration T has expired, then function block sets Q = 0.

When reset input R = 1, then the function block sets Q = 0.

	PST 0	PT 1
I, R	p20178[0, 1]	p20183[0, 1]
T	p20179	p20184
Q	r20180	r20185
Runtime group	p20181	p20186
Run sequence	p20182	p20187

PT1 (smoothing element)

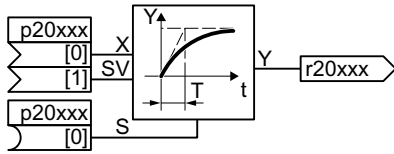

$$Y(t) = X \times (1 - \exp(-t / T))$$

The function block smooths input signal X with time constant T. T defines the gradient of the increase in output quantity Y.

If set input S = 1, then Y = SV.

	PT1 0	PT1 1
X, SV	p20244[0, 1]	p20250[0, 1]
S	p20245[0]	p20251[0]
T	p20246	p20252
Y	r20247	r20253
Runtime group	p20248	p20254
Run sequence	p20249	p20255

RSR (RS flip-flop)

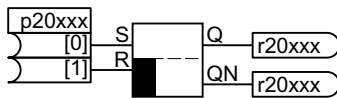

RS flip-flop, reset dominant.

Table 6-34 Truth table

S	R	Q	QN
0	0	No change	
1	0	1	0
0	1	0	1
1	1	0	1

	RSR 0	RSR 1	RSR 2
S, R	p20188[0, 1]	p20193[0, 1]	p20324[0, 1]
Q	r20189	r20194	r20325
QN	r20190	r20195	r20326
Runtime group	p20191	p20196	p20327
Run sequence	p20192	p20197	p20328

SUB (subtractor)

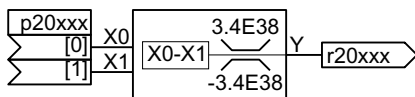

$$Y = X0 - X1$$

The function block subtracts input X1 from input X0 and limits the result in the range -3.4E38 ... 3.4E38.

	SUB 0	SUB 1
X0, X1	p20102[0, 1]	p20106[0, 1]
Y	r20103	r20107
Runtime group	p20104	p20108
Run sequence	p20105	p20109

XOR (EXCLUSIVE OR block)

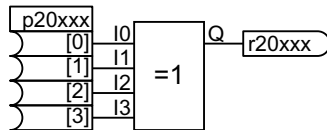

The function block logically combines the binary quantities at inputs I according to a logical exclusive or function.

Table 6-35 Truth table

I0	I1	I2	I3	Q
0	0	0	0	0
0	0	0	1	1
0	0	1	0	1
0	0	1	1	0
0	1	0	0	1
0	1	0	1	0
0	1	1	0	0
0	1	1	1	1
1	0	0	0	1
1	0	0	1	0
1	0	1	0	0
1	0	1	1	1
1	1	0	0	0
1	1	0	1	1
1	1	1	0	1
1	1	1	1	0

	XOR 0	XOR 1	XOR 2	XOR 3
I0 ... I3	p20062[0 ... 3]	p20066[0 ... 3]	p20070[0 ... 3]	p20074[0 ... 3]
Q	r20063	r20067	r20071	r20075
Runtime group	p20064	p20068	p20072	p20076
Run sequence	p20065	p20069	p20073	p20077

6.14.4 Scaling

If you interconnect a physical quantity, e.g. speed or voltage to the input of a free function block, then the inverter automatically scales the signal to a value of 1. The analog output signals of the free function blocks are also scaled: 0 $\hat{=}$ 0 %, 1 $\hat{=}$ 100 %.

If you interconnect the output signal of a free function block with a function that requires physical input quantities, then the inverter converts the scaled signal into the physical quantity.

Scaling parameters of physical quantities

Speed	100 % $\hat{=}$ p2000 (reference speed) Example: p2000 = 3000 rpm, actual speed 2100 rpm \Rightarrow the scaled input quantity = 2100 / 3000 = 0.7.
Voltage	100 % $\hat{=}$ p2001 reference voltage
Current	100 % $\hat{=}$ p2002 reference current
Torque	100 % $\hat{=}$ p2003 reference torque
Power	100 % $\hat{=}$ p2004 reference power
Angle	100 % $\hat{=}$ p2005 reference angle
Temperature	100 % $\hat{=}$ p2006 reference temperature Example: p2006 = 100 °C, actual temperature = 120 °C. \Rightarrow the scaled input quantity = 120 °C / 100 °C = 1.2.

The allocation of parameters and scaling parameters is provided in the parameter description of the List Manual.

Limits

The inverter expects limits within the free function blocks as scaled values:

Scaled limit = physical limit value / value of the reference parameter

6.14.5 Activating free function block

The free function blocks are not active in the factory setting.

Activating and interconnecting free function blocks

Precondition

You have configured the inverter with the "Free function blocks" function module.



Quick commissioning with a PC (Page 134)

Procedure

1. Activate the function block: Assign the function block to a runtime group of your choice.
Example: Assign ADD 0 to runtime group 1: p20096 = 1.
2. If you have assigned several function blocks to the same runtime group, define a sensible run sequence within the runtime group.
Example: Calculate ADD 0 before ADD 1: p20097 < p20101.
3. Interconnect the inputs and outputs of the function block with the required signals in the inverter.

You have activated a free function block and interconnected its inputs and outputs.



6.14.6 Further information

Application description for the free function blocks

Further information is provided on the Internet:



FAQ (<http://support.automation.siemens.com/WW/view/en/85168215>)

6.15 Selecting physical units

6.15.1 Motor standard

Selection options and parameters involved



The inverter represents the motor data corresponding to motor standard IEC or NEMA in different system units: SI units or US units.

Table 6-36 Parameters involved when selecting the motor standard

Parameter	Designation	Motor standard IEC/NEMA, p0100 =		
		0 ¹⁾ IEC motor 50 Hz, SI units	1 NEMA motor 60 Hz, US units	2 NEMA motor 60 Hz, SI units
r0206	Power Module rated power	kW	hp	kW
p0219	Braking resistor braking power	kW	hp	kW
p0307	Rated motor power	kW	hp	kW
p0316	Motor torque constant	Nm/A	lbf ft/A	Nm/A
r0333	Rated motor torque	Nm	lbf ft	Nm
p0341	Motor moment of inertia	kgm ²	lb ft ²	kgm ²
p0344	Motor weight	kg	Lb	kg
r0394	Rated motor power	kW	hp	kW
r1493	Total moment of inertia, scaled	kgm ²	lb ft ²	kgm ²

1) Factory setting

It is only possible to change the motor standard during quick commissioning.

6.15.2 System of units

Some physical units depend on the system of units selected (SI or US), for example the power [kW or hp] or the torque [Nm or lbf ft]. You can select in which system of units the converter represents its physical values.

Options when selecting the system of units

The following options apply when selecting the system of units:

- p0505 = 1: System of units SI (factory setting)
Torque [Nm], power [kW], temperature [°C or K]
- p0505 = 2: Referred system of units/SI
Represented as [%]

- p0505 = 3: US system of units
Torque [lbf ft], power [hp], temperature [°F]
- p0505 = 4: System of units, referred/US
Represented as [%]

Special features

The values for p0505 = 2 and for p0505 = 4 - represented in the converter - are identical. However, the reference to SI or US units is required for internal calculations and to output physical variables.

For variables, which cannot be represented as [%], then the following applies:
p0505 = 1 \triangleq p0505 = 2 and p0505 = 3 \triangleq p0505 = 4.

In the case of variables whose units are identical in the SI system and US system, and which can be displayed as a percentage, the following applies:
p0505 = 1 \triangleq p0505 = 3 and p0505 = 2 \triangleq p0505 = 4.

Reference variables

There is a reference variable in the converter for most parameters with physical units. When the referred representation [%] is set, then the converter scales the physical variables based on the particular reference variable.

When the reference variable changes, then the significance of the scaled value also changes.
Example:

- Reference speed = 1500 rpm \rightarrow fixed speed = 80 % \triangleq 1200 rpm
- Reference speed = 3000 rpm \rightarrow fixed speed = 80 % \triangleq 2400 rpm

For each parameter you can find the associated reference variable for scaling in the List Manual. Example: r0065 is scaled with reference variable p2000.

If scaling is not specified in the List Manual, then the converter always represents/displays the parameter unscaled (not normalized).

Groups of units

The parameters associated with the selection of a physical unit, belong to different groups of units.

You can find the associated group of units in the List Manual for each parameter. Example: r0333 belongs to unit group 7_4.

An overview of the unit groups and the possible physical units can also be found in the List Manual.

6.15.3 Technological unit of the technology controller

Options when selecting the technological unit

p0595 defines in which technological unit the input and output variables of the technology controller are calculated, e.g. [bar], [m³/min] or [kg/h].

Reference variable

p0596 defines the reference variable of the technological unit for the technology controller.

Unit group

Parameters involved with p0595 belong to unit group 9_1.

Further information on this topic is provided in the List Manual.

 Overview of the manuals (Page 519)

Special features

You must optimize the technology controller after changing p0595 or p0596.

6.15.4 Setting the system of units and technology unit

Setting using Startdrive

Precondition

You are offline with Startdrive.

Procedure

1. In the project, select "Parameter".
2. Select "Units".

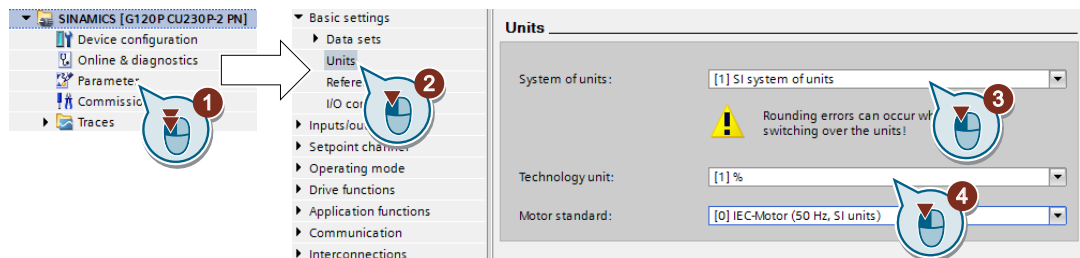

3. Select the system of units.
4. Select the technological unit of the technology controller.
5. Save your settings.

6. Go online.
The inverter signals that offline, other units and process variables are set than in the inverter itself.

7. Accept these settings in the inverter.

You have selected the motor standard and system of units.

6.16 Extended messages

Overview

You must configure the "Extended messages" function module in order to be able to use the extended messages.

 Inverter function modules (Page 132)

Parameter	Explanation
p2152	Delay for comparison $n > n_{max}$ (Factory setting: 200 ms)
p2157	Speed threshold value 5 (Factory setting: 900 rpm)
p2158	Delay for n_{act} comparison with speed threshold value 5 (Factory setting: 10 ms)
p2159	Speed threshold value 6 (Factory setting: 900 rpm)
p2160	Delay for n_{act} comparison with speed threshold value 6 (Factory setting: 10 ms)
p2170	Current threshold value (Factory setting: 0 A)
p2171	Current threshold value reached delay time (Factory setting: 10 ms)
p2172	DC-link voltage threshold value (Factory setting: 800 V)
p2173	DC-link voltage comparison delay time (Factory setting: 10 ms)
p2176	Torque threshold value comparison delay time (Factory setting: 200 ms)

Parameter	Explanation	
p2179	Output load detection current limit (Factory setting: 0 A)	 Rotation monitoring (Page 341)
p2180	Output load detection delay time (Factory setting: 2000 ms)	
p2181	Load monitoring response (Factory setting: 0) 0: Load monitoring deactivated 1: A07920 for torque/speed too low 2: A07921 for torque/speed too high 3: A07922 for torque/speed out of tolerance 4: F07923 for torque/speed too low 5: F07924 for torque/speed too high 6: F07925 for torque/speed outside the tolerance	
p2182	Load monitoring speed threshold 1 (Factory setting: 150 rpm)	
p2183	Load monitoring speed threshold 2 (Factory setting: 900 rpm)	
p2184	Load monitoring speed threshold 3 (Factory setting: 1500 rpm)	
p2185	Load monitoring torque threshold 1 upper (Factory setting: 1000000 Nm)	
p2186	Load monitoring torque threshold 1 lower (Factory setting: 0 Nm)	
p2187	Load monitoring torque threshold 2 upper (Factory setting: 1000000 Nm)	
p2188	Load monitoring torque threshold 2 lower (Factory setting: 0 Nm)	
p2189	Load monitoring torque threshold 3 upper (Factory setting: 1000000 Nm)	
p2190	Load monitoring torque threshold 3 lower (Factory setting: 0 Nm)	
p2192	Load monitoring delay time (Factory setting: 10 s)	
p2193	Load monitoring configuration (factory setting: 1) 0: Monitoring deactivated 1: Torque and load failure monitoring 2: Speed and load failure monitoring 3: Load failure monitoring	
p3231	Load monitoring speed deviation (Factory setting: 150 rpm)	
p3233	Torque actual value filter time constant (Factory setting: 100 ms)	

You will find more information in the List Manual.

 Overview of the manuals (Page 519)

6.17 Safe Torque Off (STO) safety function



The operating instructions describe how to commission the STO safety function as basic function for control via a fail-safe digital input.

A description of all the safety functions is provided in the "Safety Integrated" Function Manual:

- The basic functions and the extended functions
- Controlling safety functions via PROFIsafe

Overview of the manuals (Page 519)

6.17.1 Function description

What is the effect of the STO safety function?

The inverter with active STO function prevents energy supply to the motor. The motor can no longer generate torque on the motor shaft.

Consequently, the STO function prevents the starting of an electrically-driven machine component.

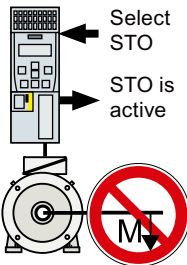

Table 6-37 The STO principle of operation as overview

	Safe Torque Off (STO)	Standard inverter functions linked with STO
1.	The inverter identifies when STO is selected via a failsafe input or via PROFIsafe.	---
2.	The inverter prevents the energy supply to the motor.	If you use a motor holding brake, the inverter closes the motor holding brake. If you use a line contactor, the inverter opens the line contactor.
3.	The inverter signals "STO is active" via a failsafe digital output or via PROFIsafe.	---

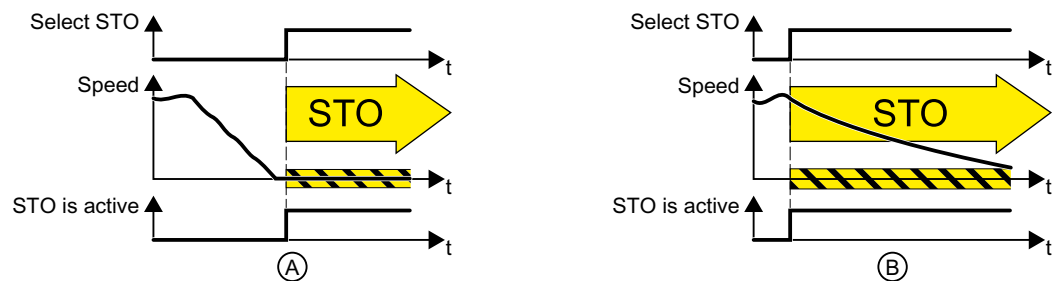

Figure 6-27 Functionality of STO when the motor is at standstill (A) and rotating (B)

(A): When selecting STO, if the motor is already stationary (zero speed), then STO prevents the motor from starting.

(B): If the motor is still rotating (B) when STO is selected, it coasts down to standstill.

The STO safety function is standardized

The STO function is defined in IEC/EN 61800-5-2:

"[...] [The inverter] does not supply any energy to the motor which can generate a torque (or for a linear motor, a force)".

⇒ The STO inverter function conforms to IEC/EN 61800-5-2.

Application examples for the STO function

The STO function is suitable for applications where the motor is already at a standstill or will come to a standstill in a short, safe period of time through friction. STO does not shorten the run-on time of machine components.

Examples	Possible solution
When the EMERGENCY STOP button is pressed, it is not permissible for a stationary motor to inadvertently accelerate.	<ul style="list-style-type: none"> • Connect the EMERGENCY STOP pushbutton with a failsafe inverter digital input. • Select STO via the failsafe digital input.
A central EMERGENCY STOP button must prevent the unintentional acceleration of several motors that are at a standstill.	<ul style="list-style-type: none"> • Evaluate the EMERGENCY STOP button in a central control. • Select STO via PROFIsafe.

The distinction between EMERGENCY SWITCHING OFF and EMERGENCY STOP

EN 60204-1 defines "EMERGENCY SWITCHING OFF" and "EMERGENCY STOP" as actions taken in an emergency. Further, it defines various stop categories for EMERGENCY STOP. "EMERGENCY SWITCHING OFF" and "EMERGENCY STOP" minimize different risks in the system or machine.

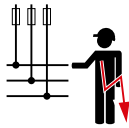
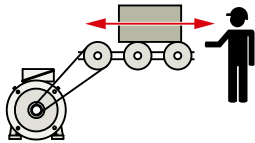
Action:	EMERGENCY SWITCHING OFF	EMERGENCY STOP Stop Category 0 according to EN 60204-1
Risk:	 Electric shock	 Unexpected movement
Measure to minimize risk:	Switch off Either completely or partially switch off hazardous voltages.	Prevent movement Prevent hazardous movement.

6.17 Safe Torque Off (STO) safety function

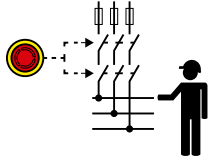
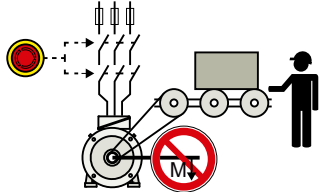
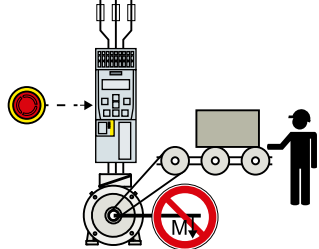
Action:	EMERGENCY SWITCHING OFF	EMERGENCY STOP Stop Category 0 according to EN 60204-1
Classic solution:		 <p data-bbox="1054 566 1406 591">Switch off the drive power supply</p>
Solution with the STO safety function integrated in the drive:	<p data-bbox="608 608 1007 693">Not possible. STO is not suitable for switching off a voltage.</p>	 <p data-bbox="1166 885 1294 910">Select STO</p> <p data-bbox="1031 927 1398 974">It is not necessary to switch off the voltage to minimize risk.</p>

Prerequisite for STO use

In order to use the STO safety function, the machine manufacturer should have already performed a risk assessment, e.g. in compliance with EN ISO 1050, "Safety of machinery - Principles of risk assessment". The risk assessment must confirm that the inverter is permitted for use in accordance with SIL 2 or PL d.

6.17.2 Commissioning STO

We recommend that you commission the safety functions using the STARTER or Startdrive PC tool.

 Tools to commission the inverter (Page 126)

6.17.2.1 Safety functions password

What is the purpose of the password?

The password protects the settings of the safety function from being changed by unauthorized persons.

Do you have to assign a password?

You do not have to assign a password.

The machine manufacturer decides whether or not a password is required.

The probabilities of failure (PFH) and certification of the safety functions also apply without password.

What do I do if I lose the password?**Requirement**

You have forgotten the password, however, you would nevertheless like to change the setting of the safety functions.

Procedure

1. Create a new project for the inverter using Startdrive.
Leave all the factory setting in the project.
2. Load the project in the inverter.
After loading, the inverter has the factory settings.
3. If a memory card inserted in the inverter, remove it.
4. Recommission the inverter.

You can obtain more information or learn about alternative procedures from Technical Support.

No.	Description	
p9761	Entering a password (factory setting 0000 hex)	
	0:	No password set
	1 ... FFFF FFFF:	Password is set
p9762	New password	
p9763	Password confirmation	

6.17.2.2 Configuring a safety function

Procedure

1. Select "Select safety functionality".

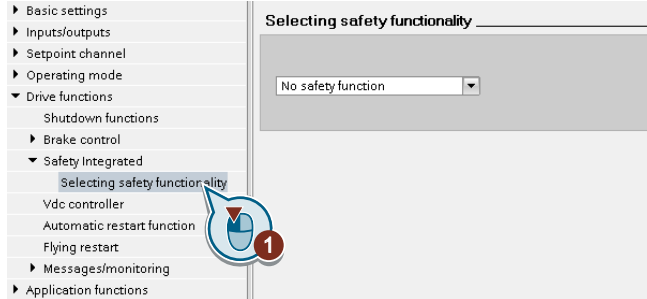

2. Select "Basic Functions".

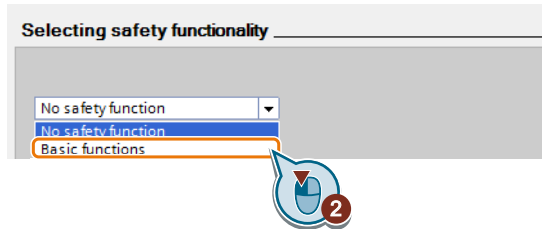

3. Select "Control type/safety functions".

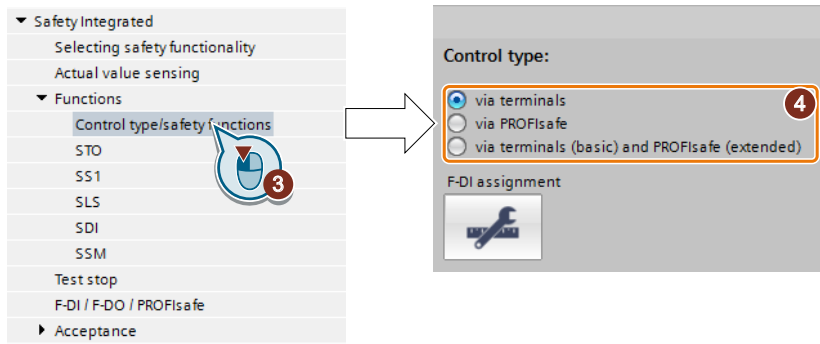

4. Select "Via terminals" as control type for the safety functions.

You have configured the safety functions.



Additional configurations of the safety functions are described in the "Safety Integrated" Function Manual.

 Overview of the manuals (Page 519)

Parameter	Description
p0010 = 95	Drive commissioning parameter filter Safety Integrated commissioning
p9601	Enable functions integrated in the drive (factory setting: 0000 bin)
	0 hex None of the safety functions has been released
	1 hex Basic functions via onboard terminals has been enabled

Parameter	Description
p9761	Enter a password (factory setting: 0000 hex) Permissible passwords lie in the range 1 ... FFFF FFFF.
p9762	New password
p9763	Password confirmation

6.17.2.3 Interconnecting the "STO active" signal

If you require the feedback signal "STO active" of the inverter in your higher-level control system, then you must appropriately interconnect the signal.

Requirement

You are online with Startdrive.

Procedure

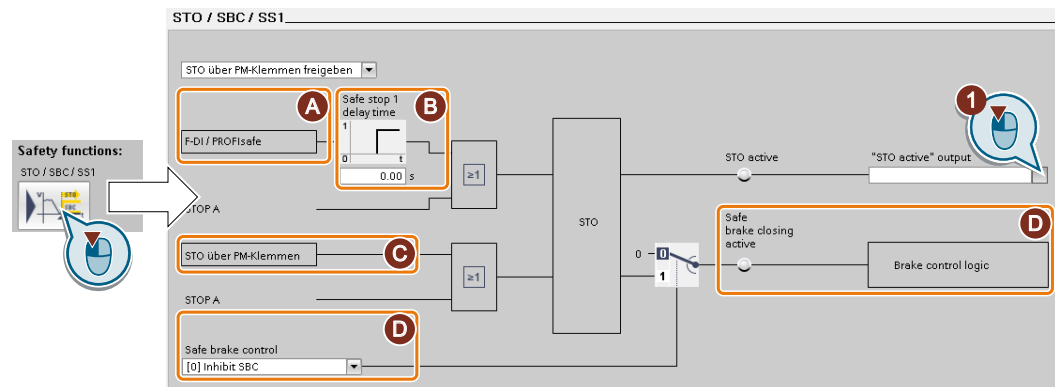

The screen form varies depending on the inverter and the interface that has been selected.

- (A) Control type
- (B) Delay time for SS1 and enable SBC for an inverter with CU250S-2 Control Unit
- (C) STO via the Power Module terminals for a PM240-2 or PM240P-2, FSD ... FSF Power Module
- (D) Enable SBC for an inverter with CU250S-2 Control Unit

1. Select the button for the feedback signal.
2. Select the signal that matches your particular application.

You have interconnected the "STO active" checkback signal.



After STO has been selected, the inverter signals "STO active" to the higher-level control.

Parameter	Description
r9773.01	1 signal: STO is active in the drive

6.17.2.4 Setting the filter for fail-safe digital inputs

Requirement

You are online with Startdrive.

Procedure

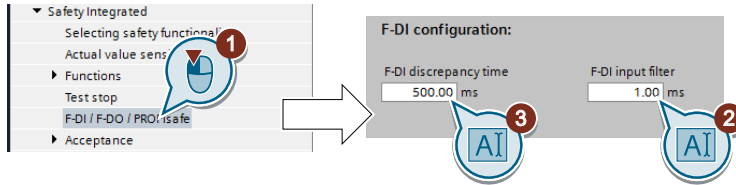

1. Navigate to the filter settings.
2. Set the debounce time for the F-DI input filter.
3. Set the discrepancy time for the simultaneity monitoring.

You have set the input filter and the simultaneity monitoring of the failsafe digital input.
□

Description of the signal filter

The following filters are available for the fail-safe digital inputs:

- One filter for the simultaneity monitoring
- A filter to suppress short signals, e.g. test pulses.

Set the discrepancy time for the simultaneity monitoring.

The inverter checks that the two input signals of the fail-safe digital input always have the same signal state (high or low).

With electromechanical sensors (e.g. emergency stop buttons or door switches), the two sensor contacts never switch at exactly the same time and are therefore temporarily inconsistent (discrepancy). A permanent discrepancy signifies a fault in the fail-safe digital input circuit, e.g. wire breakage.

When appropriately set, the inverter tolerates brief discrepancies.

The discrepancy time does not extend the inverter response time. The inverter selects its safety function as soon as one of the two F-DI signals changes its state from high to low.

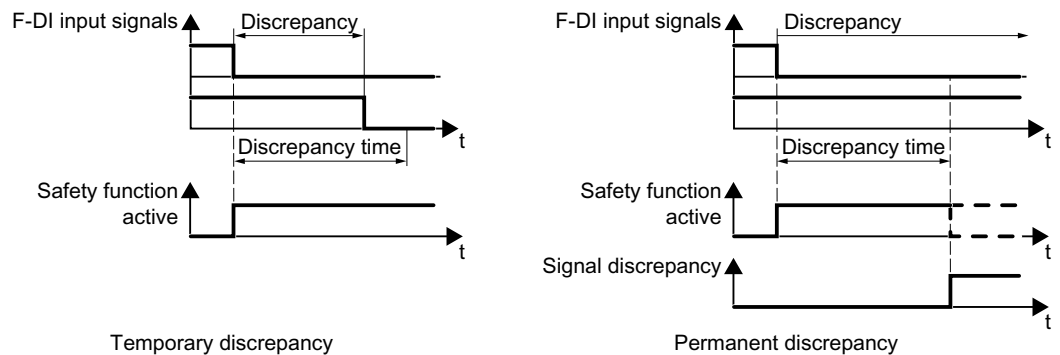

Figure 6-28 Simultaneity monitoring with discrepancy time

Filter to suppress short signals

In the following cases, an immediate inverter response to signal changes of the fail-safe digital inputs is not desirable:

- If a fail-safe digital input of the inverter is interconnected with an electromechanical sensor, signal changes can occur due to contact bounce.
- In order to identify faults due to short-circuit or cross faults, several control modules test their fail-safe digital outputs with "bit pattern tests" (bright/dark test). If a fail-safe digital input of the inverter is interconnected with a fail-safe digital output of an open-loop control module, then the inverter responds with a bit pattern test.

The typical duration of the signal change within a bit pattern test:

- On test: 1 ms
- Off test: 4 ms

If the fail-safe digital input responds to many signal changes within a certain time, then the inverter responds with a fault.

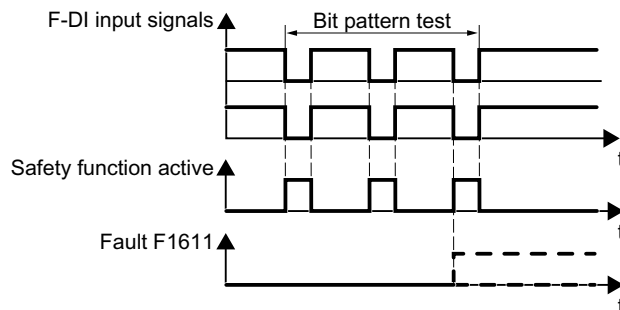

Figure 6-29 Inverter response to a bit pattern test

A filter in the inverter suppresses brief signals as a result of the bit pattern test or contact bounce.

6.17 Safe Torque Off (STO) safety function

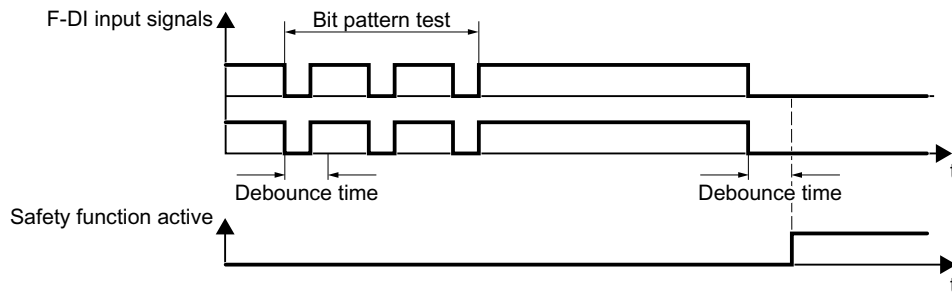

Figure 6-30 Filter to suppress brief signals

The filter extends the response time of the safety function by the debounce time.

Parameter	Description
p9650	F-DI changeover tolerance time (factory setting: 500 ms) Tolerance time to change over the fail-safe digital input for the basic functions.
p9651	STO debounce time (factory setting: 1 ms) Debounce time of the fail-safe digital input for the basic functions.

Debounce times for standard and safety functions

The debounce time p0724 for "standard" digital inputs has no influence on the fail-safe input signals. Conversely, the same applies: The F-DI debounce time does not affect the signals of the "standard" inputs.

If you use an input as a standard input, set the debounce time using parameter p0724 .

If you use an input as a fail-safe input, set the debounce time as described above.

6.17.2.5 Setting the forced checking procedure (test stop)

Requirement

You are online with Startdrive.

Procedure

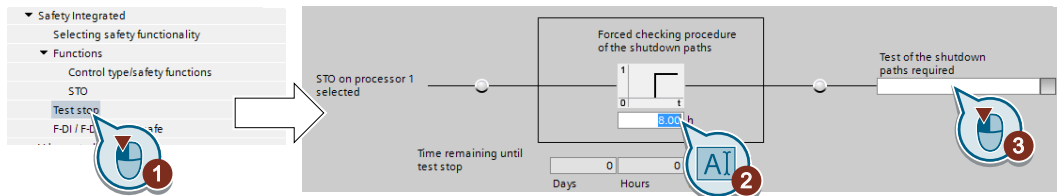

1. Select the screen form for setting the forced checking procedure.
2. Set the monitoring time to a value to match your application.
3. Using this signal, the inverter signals that a forced checking procedure (test stop) is required. Interconnect this signal with an inverter signal of your choice.

You have set the forced checking procedure (test stop) for the Basic Functions.

□

Description

The forced checking procedure (test stop) of the basic functions is an inverter self test. The inverter checks its circuits to switch off the torque. If you are using the Safe Brake Relay, for a forced checking procedure, the inverter also checks the circuits of this component.

You start the forced checking procedure each time that the STO function is selected.

Using a timer block, the inverter monitors as to whether the forced checking procedure is regularly performed.

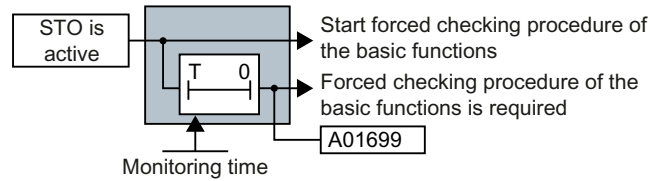

Figure 6-31 Starting and monitoring the forced checking procedure (test stop)

Parameter	Description
p9659	Forced dormant error detection timer (Factory setting: 8 h) Monitoring time for the forced dormant error detection.
r9660	Forced dormant error detection remaining time Displays the remaining time until the forced dormant error detection and testing the safety switch-off signal paths.
r9773.31	1 signal: Forced dormant error detection is required Signals for the higher-level control system.

6.17.2.6 Finalizing online commissioning

Activate settings

Requirement

You are online with Startdrive.

Procedure

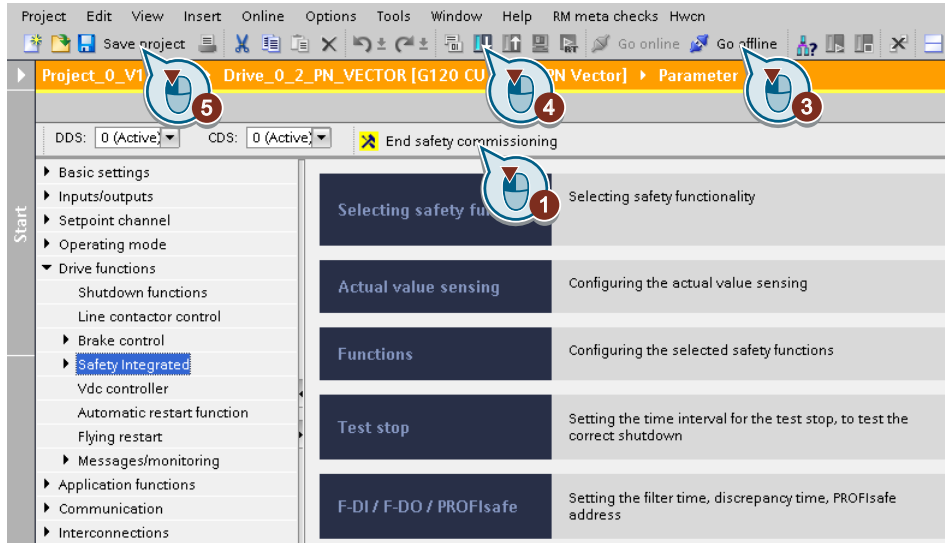

1. Press the "End safety commissioning" button.
2. Confirm the prompt for saving your settings (copy RAM to ROM).
3. Disconnect the online connection.
4. Select the "Load from device (software)" button.
5. Save the project.
6. Switch off the inverter power supply.
7. Wait until all LEDs on the inverter go dark (no voltage condition).
8. Switch the inverter power supply on again.

Your settings are now active.



Parameter	Description
p9700 = D0 hex	SI copy function (factory setting: 0) Start the SI parameter copy function.
p9701 = DC hex	Confirm data change (factory setting: 0) Confirm SI Basic parameter change

Parameter	Description
p0010 = 0	Drive commissioning parameter filter 0: Ready
p0971 = 1	Save parameter 1: Save the drive object (copy from RAM to ROM) After the inverter has saved the parameters in a non-volatile fashion, then p0971 = 0.

6.17.2.7 Checking the assignment of the digital inputs

Checking the interconnection of digital inputs

The simultaneous connection of digital inputs with a safety function and a "standard" function may lead to the drive behaving in unexpected ways.

If you control the safety functions in the inverter via failsafe digital inputs, then you must check as to whether the failsafe digital inputs are in some instances interconnected with a "standard" function.

Procedure

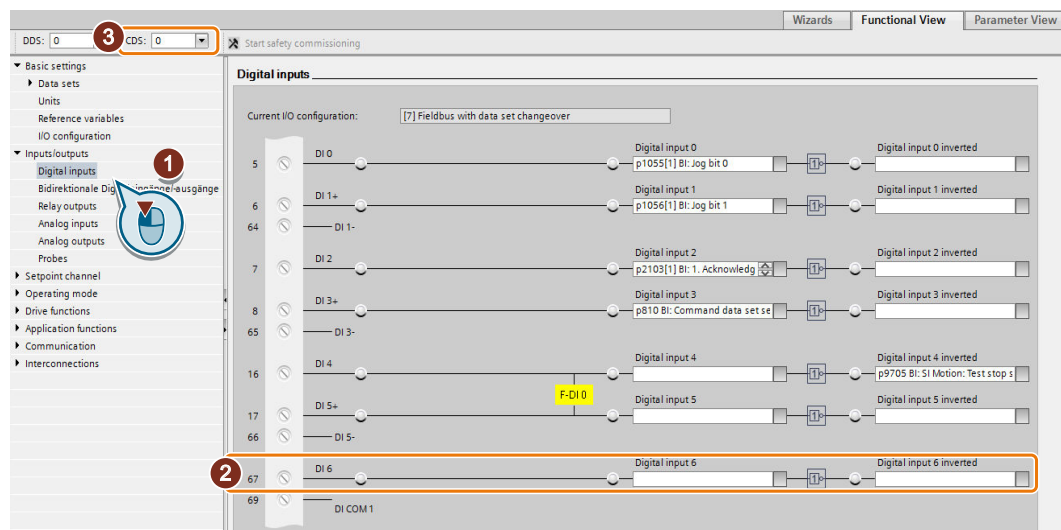

1. Select the screen for the digital inputs.
2. Remove all interconnections of the digital inputs that you use as failsafe digital input F-DI:
3. You must delete the digital input connections for all CDS if you use the switchover of the command data sets (CDS).
You can find a description of the CDS switchover in the operating instructions.

You have ensured that the failsafe digital inputs only control the safety functions in the inverter.



6.17.2.8 Acceptance - completion of commissioning

What is an acceptance?

The machine manufacturer is responsible in ensuring that his plant or machine functions perfectly. As a consequence, after commissioning, the machine manufacturer must check those functions or have them checked by specialist personnel, which represent an increased risk of injury or material damage. This acceptance or validation is, for example, also specified in the European machinery directive and essentially comprises two parts:

- Checking the safety-relevant functions and machine parts.
→ **Acceptance test.**
- Generate an "Acceptance report" that describes the test results.
→ **Documentation.**

Supply information for the validation, e.g. the harmonized European standards EN ISO 13849-1 and EN ISO 13849-2.

Acceptance test of the machine or plant

The acceptance test checks whether the safety-relevant functions in the plant or machine function correctly. The documentation of the components used in the safety functions can also provide information about the necessary tests.

Testing the safety-related functions includes, e.g. the following:

- Are all safety equipment such as protective door monitoring devices, light barriers or emergency-off switches connected and ready for operation?
- Does the higher-level control respond as expected to the safety-relevant feedback signals of the inverter?
- Do the inverter settings match the configured safety-relevant function in the machine?

Acceptance test of the inverter

The acceptance test of the inverter is a part of the acceptance test of the entire machine or plant.

The acceptance test of the inverter checks whether the integrated drive safety functions are set up correctly for the planned safety function of the machine.



Recommended acceptance test (Page 513)

Documentation of the inverter

The following must be documented for the inverter:

- The results of the acceptance test.
- The settings of the integrated drive safety functions.

The documentation must be signed.

Who may perform the acceptance test of the inverter?

Personnel from the machine manufacturer, who, on account of their technical qualifications and knowledge of the safety functions, are in a position to perform the acceptance test in the correct manner are authorized to perform the acceptance testing of the inverter.

Wizard for the acceptance test

The "Startdrive Advanced" commissioning tool (requires an appropriate license) includes a wizard for the acceptance test of the safety functions integrated in the drive.

"Startdrive Advanced" guides you through the acceptance test, generates the appropriate traces to analyze the machine response – and generates an acceptance report as Excel file.

Further information is provided on the Internet:

 Startdrive, system requirements and download (<https://support.industry.siemens.com/cs/ww/en/view/109752254>)

Reduced acceptance test after function expansions

A full acceptance test is necessary only after first commissioning. A reduced acceptance test is sufficient when safety functions are expanded.

Measure	Acceptance test	
	Acceptance test	Documentation
Functional expansion of the machine (additional drive).	Yes. Only check the safety functions of the new drive.	<ul style="list-style-type: none"> • Supplement machine overview • Supplement inverter data • Add function table • Log the new checksums • Countersignature
Transfer of inverter settings to other identical machines by means of series commissioning.	No. Only check the control of all of the safety functions.	<ul style="list-style-type: none"> • Add machine description • Check checksums • Check firmware versions

6.18 Setpoints

6.18.1 Overview



The inverter receives its main setpoint from the setpoint source. The main setpoint mainly specifies the motor speed.

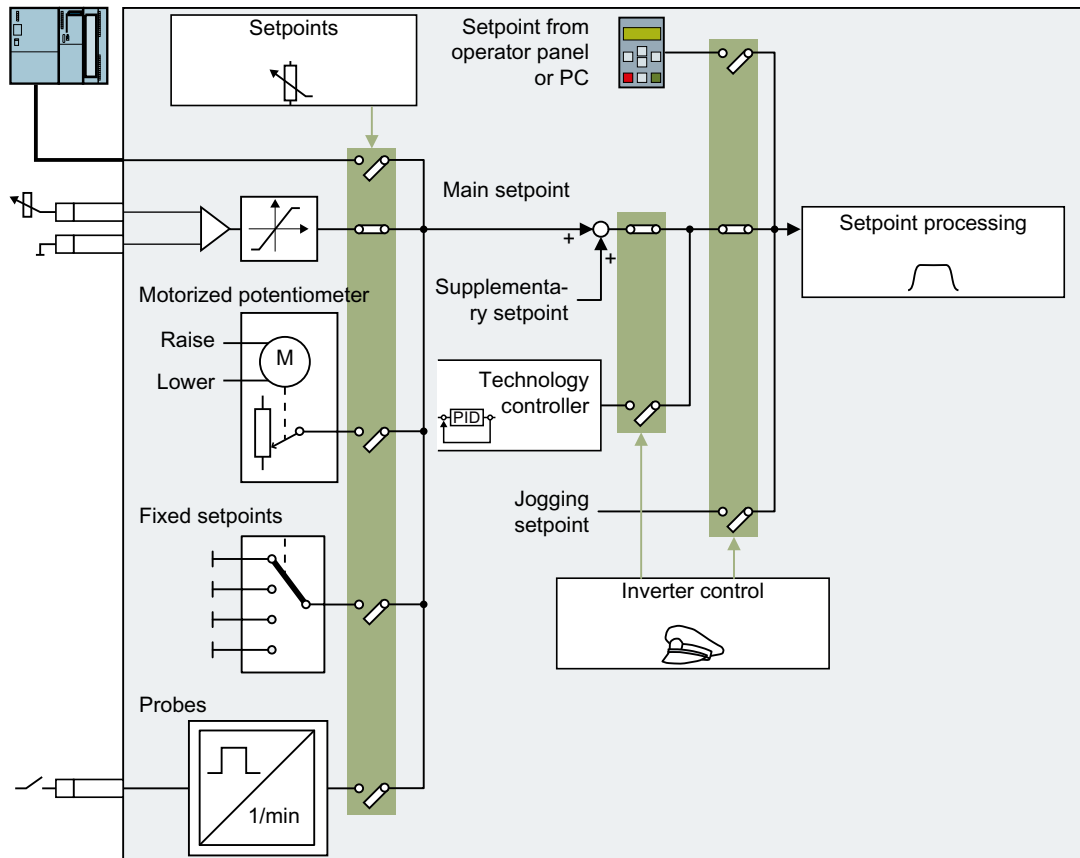

Figure 6-32 Setpoint sources for the inverter

You have the following options when selecting the source of the main setpoint:

- Inverter fieldbus interface
- Analog input of the inverter
- Motorized potentiometer emulated in the inverter
- Fixed setpoints stored in the inverter
- Probe: The inverter converts a sequence of pulse signals at the digital input into an analog value.

You have the same selection options when selecting the source of the supplementary setpoint.

Under the following conditions, the inverter switches from the main setpoint to other setpoints:

- When the technology controller is active and appropriately interconnected, its output specifies the motor speed.
- When jogging is active
- When controlling from an operator panel or the STARTER PC tool.

6.18.2 Analog input as setpoint source

Function description

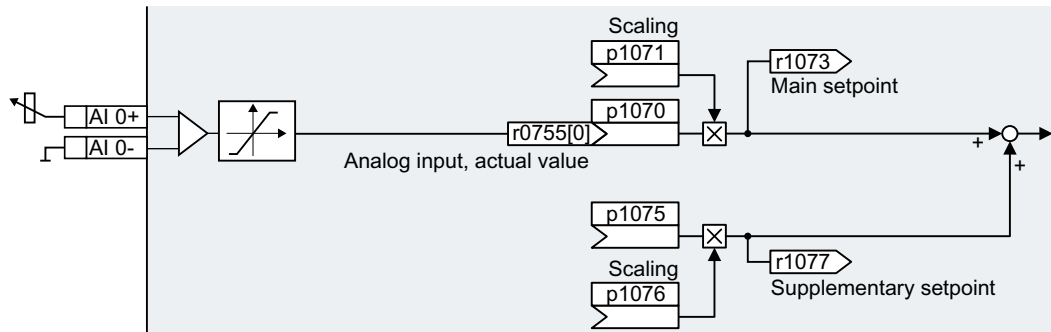

Figure 6-33 Example: Analog input 0 as setpoint source

In the quick commissioning, you define the preassignment for the inverter interfaces. Depending on what has been preassigned, after quick commissioning, the analog input can be interconnected with the main setpoint.

Example

Setting with analog input 0 as setpoint source:

Parameter	Description
p1070 = 755[0]	Interconnects main setpoint with analog input 0
p1075 = 755[0]	Interconnects supplementary setpoint with analog input 0

Parameter

Parameter	Description	Setting
r0755[0...1]	CO: CU analog inputs, actual value in percent	Displays the actual referenced input value of the analog inputs [0] = analog input 0 [1] = analog input 1
p1070[0...n]	CI: Main setpoint	Signal source for the main setpoint The factory setting depends on the inverter. Inverter with PROFIBUS or PROFINET interface: [0] 2050[1] Inverter without PROFIBUS or PROFINET interface: [0] 755[0]
p1071[0...n]	CI: Main setpoint scaling	Signal source for scaling the main setpoint Factory setting: 1
r1073	CO: Main setpoint active	Displays the active main setpoint
p1075[0...n]	CI: Supplementary setpoint	Signal source for the supplementary setpoint Factory setting: 0
p1076[0...n]	CI: Supplementary setpoint scaling	Signal source for scaling the supplementary setpoint Factory setting: 0

Further information

For further information refer to the function diagrams 2250 ff and 3030 of the List Manual.

6.18.3 Specifying the setpoint via the fieldbus

Function description

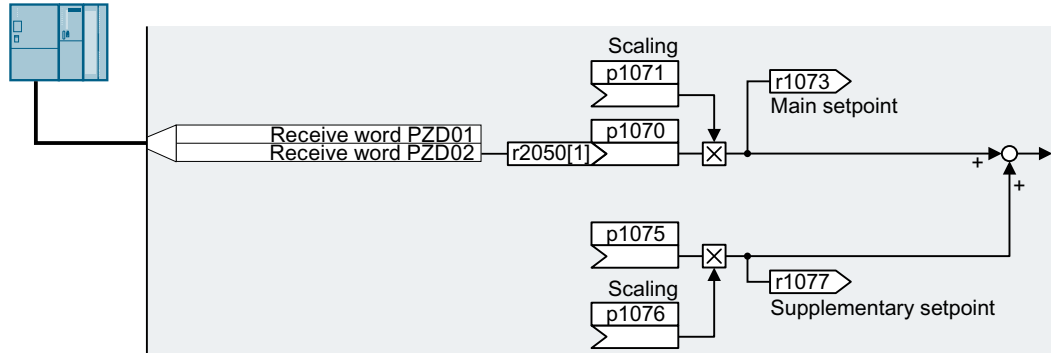

Figure 6-34 Fieldbus as setpoint source

In the quick commissioning, you define the preassignment for the inverter interfaces. Depending on what has been preassigned, after quick commissioning, the receive word PZD02 can be interconnected with the main setpoint.

Example

Setting with receive word PZD02 as setpoint source:

Parameter	Description
p1070 = 2050[1]	Interconnects the main setpoint with the receive word PZD02 from the fieldbus.
p1075 = 2050[1]	Interconnects the supplementary setpoint with receive word PZD02 from the fieldbus.

Parameter

Parameter	Description	Setting
p1070[0...n]	CI: Main setpoint	Signal source for the main setpoint The factory setting depends on the Control Unit. With PROFIBUS or PROFINET interface: [0] 2050[1] Without PROFIBUS or PROFINET interface: [0] 755[0]
p1071[0...n]	CI: Main setpoint scaling	Signal source for scaling the main setpoint Factory setting: 1
r1073	CO: Main setpoint active	Displays the active main setpoint
p1075[0...n]	CI: Supplementary setpoint	Signal source for the supplementary setpoint Factory setting: 0

Parameter	Description	Setting
p1076[0...n]	CI: Supplementary setpoint scaling	Signal source for scaling the supplementary setpoint Factory setting: 0
r2050[0...11]	CO: PROFIdrive PZD receive word	Connector output to interconnect the PZD received from the fieldbus controller in the word format. [1] Most standard telegrams receive the speed setpoint as receive word PZD02.

Further information

For further information refer to the function diagrams 2468, 9360 and 3030 of the List Manual.

6.18.4 Motorized potentiometer as setpoint source

Function description

The "Motorized potentiometer" function emulates an electromechanical potentiometer. The output value of the motorized potentiometer can be set with the "higher" and "lower" control signals.

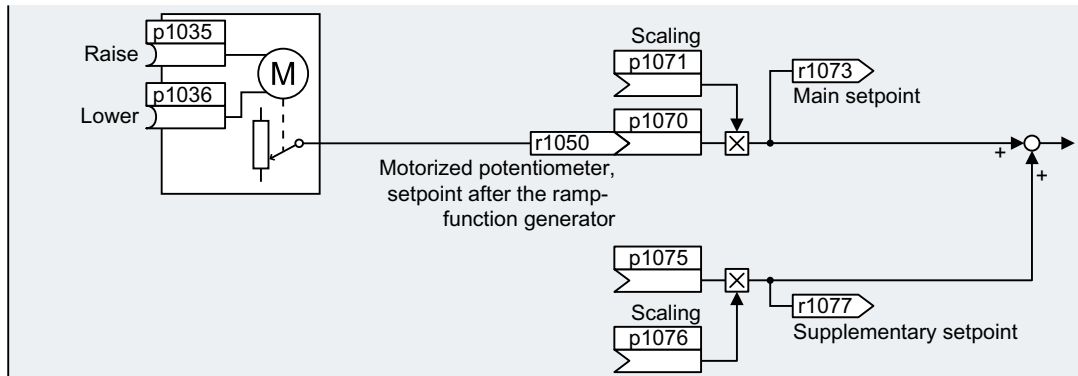

Figure 6-35 Motorized potentiometer as setpoint source

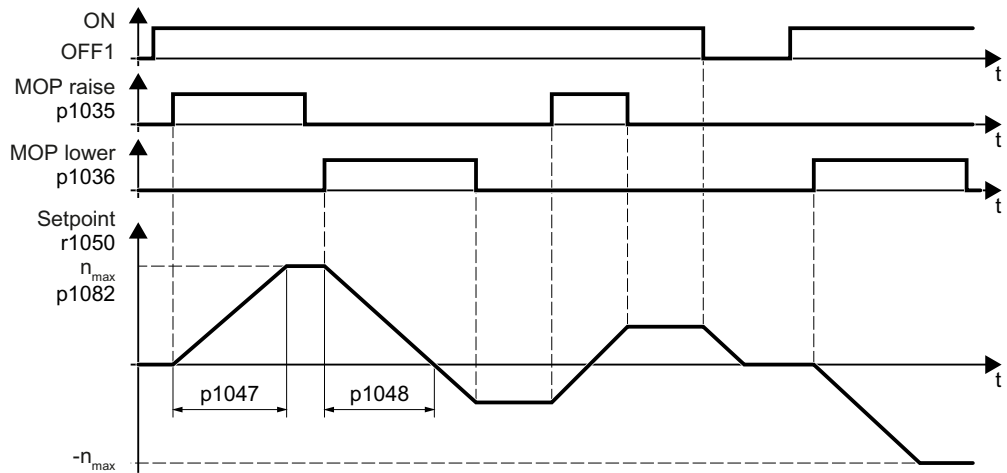

Figure 6-36 Function chart of the motorized potentiometer

Example

Setting with the motorized potentiometer as setpoint source:

Parameter	Description
p1070 = 1050	Interconnects the main setpoint with the motorized potentiometer output.

Parameter

Table 6-38 Basic setup of motorized potentiometer

Parameter	Description	Setting
p1035[0...n]	BI: Motorized potentiometer setpoint higher	Signal source to continuously increase the setpoint The factory setting depends on the inverter. Inverters with PROFIBUS or PROFINET interface: [0] 2090.13 [1] 0 Inverters without PROFIBUS or PROFINET interface: 0
p1036[0...n]	BI: Motorized potentiometer setpoint lower	Signal source to continuously decrease the setpoint The factory setting depends on the inverter. Inverters with PROFIBUS or PROFINET interface: [0] 2090.14 [1] 0 Inverters without PROFIBUS or PROFINET interface: 0
p1040[0...n]	Motorized potentiometer start value [rpm]	Start value that is effective when the motor is switched on. Factory setting: 0 rpm
p1047	MOP ramp-up time [s]	MOP ramp-up time Factory setting: 10 s
p1048	MOP ramp-down time [s]	MOP ramp-down time: Factory setting: 10 s
r1050	Motorized potentiometer, setpoint after the ramp-function generator	Motorized potentiometer, setpoint after the ramp-function generator
p1070[0...n]	CI: Main setpoint	Signal source for the main setpoint The factory setting depends on the Control Unit. With PROFIBUS or PROFINET interface: [0] 2050[1] Without PROFIBUS or PROFINET interface: [0] 755[0]
p1071[0...n]	CI: Main setpoint scaling	Signal source for scaling the main setpoint Factory setting: 1
r1073	CO: Main setpoint active	Displays the active main setpoint
p1075[0...n]	CI: Supplementary setpoint	Signal source for the supplementary setpoint Factory setting: 0
p1076[0...n]	CI: Supplementary setpoint scaling	Signal source for scaling the supplementary setpoint Factory setting: 0

Table 6-39 Extended setup of motorized potentiometer

Parameter	Description	Setting
p1030[0...n]	Motorized potentiometer configuration	<p>Configuration for the motorized potentiometer</p> <p>Factory setting: 00110 bin</p> <p>.00</p> <p>Storage active</p> <p>= 0: After the motor has been switched on, the setpoint = p1040</p> <p>= 1: After the motor has switched off, the inverter saves the setpoint. After the motor has switched on, the setpoint = the stored value</p> <p>.01</p> <p>Automatic mode, ramp-function generator active (1-signal via BI: p1041)</p> <p>= 0: Ramp-up/ramp-down time = 0</p> <p>= 1: With ramp-function generator</p> <p>In manual mode (p1041 = 0), the ramp-function generator is always active.</p> <p>.02</p> <p>Initial rounding active</p> <p>1: With initial rounding. Using the initial rounding function it is possible to enter very small setpoint changes</p> <p>.03</p> <p>Storage in NVRAM active</p> <p>1: If bit 00 = 1, the setpoint is retained during a power failure</p> <p>.04</p> <p>Ramp-function generator always active</p> <p>1: The inverter also calculates the ramp-function generator when the motor is switched off</p>
p1037[0...n]	Motorized potentiometer maximum speed [rpm]	<p>The inverter limits the motorized potentiometer output to p1037.</p> <p>Factory setting: 0 rpm</p> <p>After quick commissioning, the inverter sets the parameter to the appropriate value.</p>
p1038[0...n]	Motorized potentiometer minimum speed [rpm]	<p>The inverter limits the motorized potentiometer output to p1038.</p> <p>Factory setting: 0 rpm</p> <p>After quick commissioning, the inverter sets the parameter to the appropriate value.</p>
p1043[0...n]	BI: Motorized potentiometer, accept setting value	<p>Signal source for accepting the setting value. The motorized potentiometer accepts the setting value p1044 on signal change p1043 = 0 → 1.</p> <p>Factory setting: 0</p>
p1044[0...n]	CI: Motorized potentiometer, setting value	<p>Signal source for the setting value</p> <p>Factory setting: 0</p>

Further information

For more information about the motorized potentiometer, refer to function diagram 3020 in the List Manual.

6.18.5 Fixed speed setpoint as setpoint source

Function description

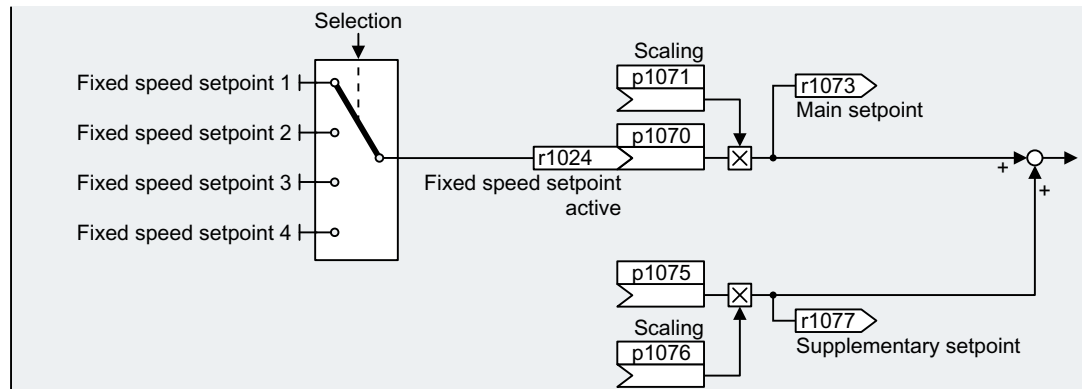

Figure 6-37 Fixed speed setpoint as setpoint source

The inverter makes a distinction between two methods when selecting the fixed speed setpoints:

Directly selecting a fixed speed setpoint

You set 4 different fixed speed setpoints. Up to 16 different setpoints are obtained by adding one or several of the four fixed speed setpoints.

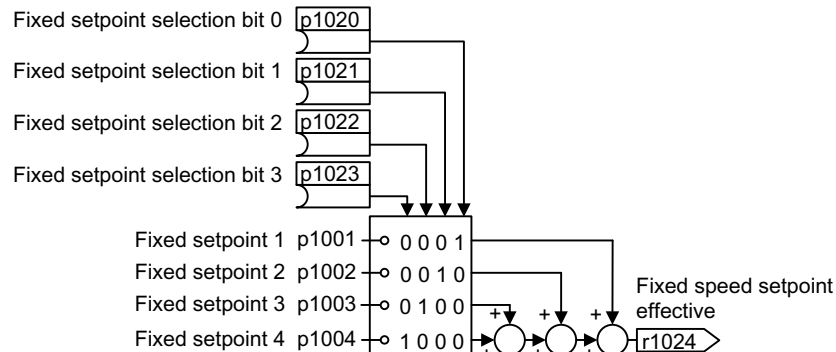

Figure 6-38 Direct selection of the fixed speed setpoint

Selecting the fixed speed setpoint, binary

You set 16 different fixed speed setpoints. You precisely select one of these 16 fixed speed setpoints by combining four selection bits.

6.18 Setpoints

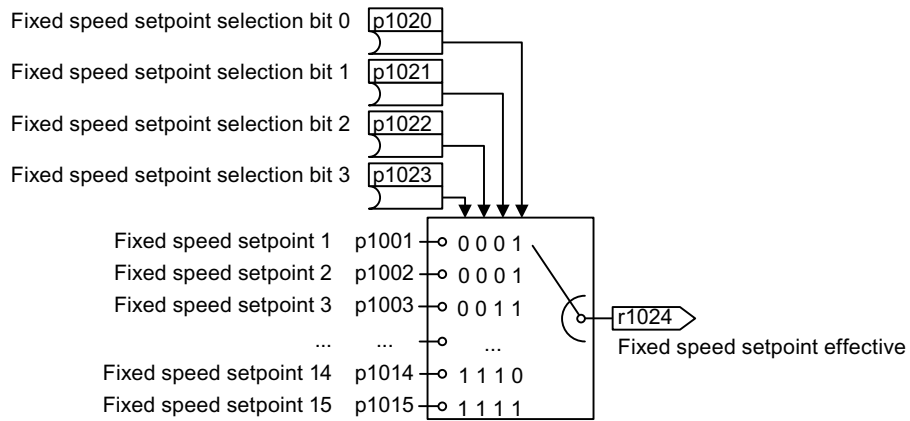

Figure 6-39 Binary selection of the fixed speed setpoint

Example

After it has been switched on, a conveyor belt only runs with two different velocities. The motor should now operate with the following corresponding speeds:

- The signal at digital input 0 switches the motor on and accelerates it up to 300 rpm.
- The signal at digital input 1 accelerates the motor up to 2000 rpm.
- With signals at both digital inputs, the motor accelerates up to 2300 rpm.

Table 6-40 Settings for the application example

Parameter	Description
p1001[0] = 300.000	Fixed speed setpoint 1 [rpm]
p1002[0] = 2000.000	Fixed speed setpoint 2 [rpm]
p0840[0] = 722.0	ON/OFF1: Switches on the motor with digital input 0
p1070[0] = 1024	Main setpoint: Interconnects the main setpoint with a fixed speed setpoint.
p1020[0] = 722.0	Fixed speed setpoint selection, bit 0: Interconnects fixed speed setpoint 1 with digital input 0 (DI 0).
p1021[0] = 722.1	Fixed speed setpoint selection, bit 1: Interconnects fixed speed setpoint 2 with digital input 1 (DI 1).
p1016 = 1	Fixed speed setpoint mode: Directly selects fixed speed setpoints.

Table 6-41 Resulting fixed speed setpoints for the application example

Fixed speed setpoint selected via	Resulting setpoint
DI 0 = 0	Motor stops
DI 0 = 1 and DI 1 = 0	300 rpm
DI 0 = 1 and DI 1 = 1	2300 rpm

Parameter

Parameter	Description	Setting
p1001[0...n]	Fixed speed setpoint 1 [rpm]	Fixed speed setpoint 1 Factory setting: 0 rpm
p1002[0...n]	Fixed speed setpoint 2 [rpm]	Fixed speed setpoint 2 Factory setting: 0 rpm
...
p1015[0...n]	Fixed speed setpoint 15 [rpm]	Fixed speed setpoint 15 Factory setting: 0 rpm
p1016	Fixed speed setpoint mode	Fixed speed setpoint mode Factory setting: 1 1: Direct 2: Binary
p1020[0...n]	Fixed speed setpoint selection, bit 0	Fixed speed setpoint selection, bit 0 Factory setting: 0
p1021[0...n]	Fixed speed setpoint selection, bit 1	Fixed speed setpoint selection, bit 1 Factory setting: 0
p1022[0...n]	Fixed speed setpoint selection, bit 2	Fixed speed setpoint selection, bit 2 Factory setting: 0
p1023[0...n]	Fixed speed setpoint selection, bit 3	Fixed speed setpoint selection, bit 3 Factory setting: 0
r1024	Fixed speed setpoint active	Fixed speed setpoint active
r1025.0	Fixed speed setpoint status	Fixed speed setpoint status 1 signal: Fixed speed setpoint is selected

Further information

Additional information about binary selection can be found in function diagram 3010 in the List Manual.

Additional information about direct selection can be found in function diagram 3011 in the List Manual.

Application example: Directly selecting two fixed speed setpoints

The motor should operate at different speeds as follows:

- The signal on digital input 0 switches the motor on and accelerates it to 300 rpm.
- The signal at digital input 1 accelerates the motor to 2000 rpm.
- The signals at the two digital inputs accelerate the motor to 2300 rpm.

Table 6-42 Settings for the application example

Parameter	Description
p1001 = 300.000	Fixed speed setpoint 1 [rpm]
p1002 = 2000.000	Fixed speed setpoint 2 [rpm]
p0840 = 722.0	ON/OFF1: Switches on the motor with digital input 0
p1070 = 1024	Main setpoint: Interconnects the main setpoint with fixed speed setpoint.
p1020 = 722.0	Fixed speed setpoint selection bit 0: Interconnects fixed speed setpoint 1 with digital input 0 (DI 0).
p1021 = 722.1	Fixed speed setpoint selection bit 1: Interconnects fixed speed setpoint 2 with digital input 1 (DI 1).
p1016 = 1	Fixed speed setpoint mode: Directly selects fixed speed setpoints.

Table 6-43 Resulting fixed speed setpoints for the application example

Fixed speed setpoint selected via	Resulting setpoint
DI 0 = 0	Motor stops
DI 0 = 1 and DI 1 = 0	300 rpm
DI 0 = 1 and DI 1 = 1	2300 rpm

6.18.6 Pulse input as source of setpoint value

Interconnecting the digital input as setpoint source

Using the "probe" function ("pulse train"), the inverter converts a pulse signal at one of the digital inputs DI 24 ... DI 27 to an analog signal. The inverter evaluates a signal with a max. frequency of 32 kHz.

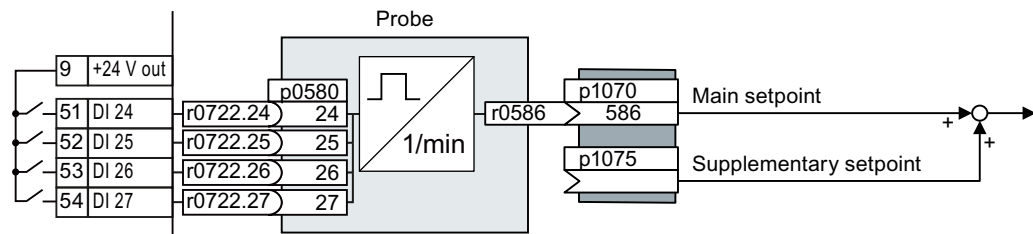

Figure 6-40 Pulse signal of the digital input as setpoint source

The "probe" function ("pulse train") creates an analog value from a pulse train at a digital input of the inverter.

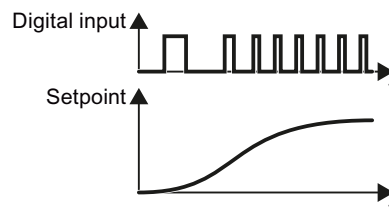



Figure 6-41 Converting the pulse signal at the digital input to an analog value

Parameter	Description
p1070 = 586	Main setpoint (factory setting depending on the Control Unit) Interconnect the result of the speed calculation with the main setpoint.
p1075 = 586	Supplementary setpoint (factory setting 0) Interconnect the result of the speed calculation with the supplementary setpoint.

When you use this function, you cannot use any of the digital inputs to monitor the speed.

 Speed deviation monitoring (Page 342)

Setting the probe

Parameter	Description
p0490	Probe¹⁾ invert (factory setting 0000bin) The 3rd bit of the parameter value inverts the input signal of digital input 3 for the probe.
p0580	Probe¹⁾ input terminal (factory setting 0) Interconnect the probe input with a digital input.
p0581	Probe¹⁾ edge (factory setting 0) Edge to evaluate the probe signal for the actual measuring speed value 0: 0/1 edge 1: 1/0 edge

Parameter	Description
p0582	Probe ¹⁾ Pulses per revolution (factory setting 1) Number of pulses per revolution.
p0583	Probe ¹⁾ Maximum measurement time (factory setting 10 s) Maximum measurement time for the probe. If there is no new pulse before the maximum measuring time elapses, the inverter sets the actual speed value in r0586 to zero. The time is restarted with the next pulse.
p0585	Probe ¹⁾ Gear ratio (factory setting 1) The inverter multiplies the measured speed by the gear ratio before displaying it in r0586.
r0586	Probe ¹⁾ Actual speed value Result of the speed calculation.

6.19 Setpoint calculation

6.19.1 Overview

Overview



Setpoint processing influences the setpoint using the following functions:

- "Invert" inverts the motor direction of rotation.
- The "Inhibit direction of rotation" function prevents the motor from rotating in the incorrect direction; this function can make sense for conveyor belts, extruders, pumps and fans, for example.
- The "Skip frequency bands" prevent the motor from being continuously operated within these skip bands. This function avoids mechanical resonance effects by only permitting the motor to operate briefly at specific speeds.
- The "Speed limitation" function protects the motor and the driven load against excessively high speeds.
- The "Ramp-function generator" function prevents the setpoint from suddenly changing. As a consequence, the motor accelerates and brakes with a reduced torque.

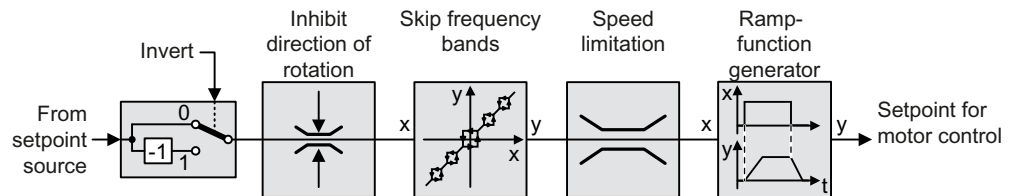
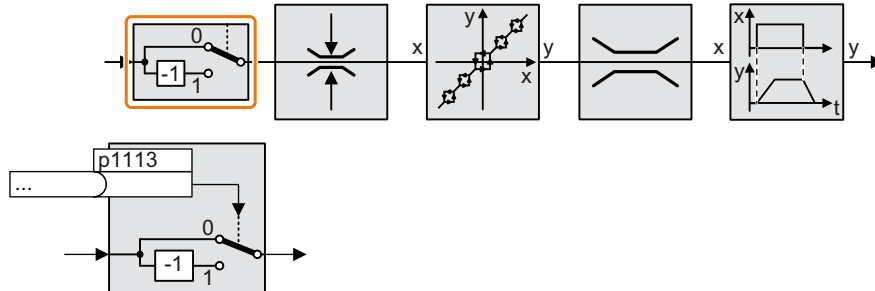

Figure 6-42 Setpoint processing in the inverter

6.19.2 Invert setpoint

Function description



The function inverts the sign of the setpoint using a binary signal.

Example

To invert the setpoint via an external signal, interconnect parameter p1113 with a binary signal of your choice.

Table 6-44 Application examples showing how a setpoint is inverted

Parameter	Description
p1113 = 722.1	Digital input 1 = 0: Setpoint remains unchanged. Digital input 1 = 1: Inverter inverts the setpoint.
p1113 = 2090.11	Inverts the setpoint via the fieldbus (control word 1, bit 11).

Parameter

Parameter	Description	Setting
p1113[0...n]	BI: Setpoint inversion	Signal source for inverting the setpoint 1 signal: Invert setpoint The factory setting depends on the fieldbus interface.

6.19.3 Inhibit direction of rotation

Function description

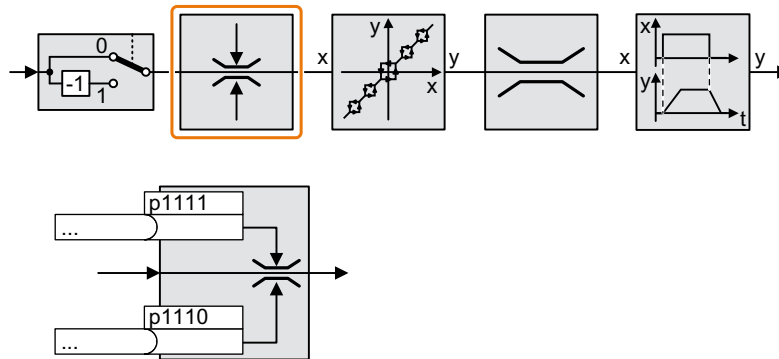

In the factory setting of the inverter, both motor directions of rotation are enabled.

Set the corresponding parameter to a value = 1 to permanently block directions of rotation.

Example

Table 6-45 Application examples showing how a setpoint is inverted

Parameter	Description
p1110[0] = 1	Negative direction of rotation is permanently inhibited.
p1110[0] = 722.3	Digital input 3 = 0: Negative direction of rotation is enabled. Digital input 3 = 1: Negative direction of rotation is inhibited.

Parameter

Parameter	Description	Setting
p1110[0...n]	BI: Inhibit negative direction	Signal source to inhibit the negative direction 0 signal: Direction of rotation is enabled 1 signal: Direction of rotation is inhibited Factory setting: 0
p1111[0...n]	BI: Inhibit positive direction	Signal source to inhibit the positive direction 0 signal: Direction of rotation is enabled 1 signal: Direction of rotation is inhibited Factory setting: 0

6.19.4 Skip frequency bands and minimum speed

Skip frequency bands

The inverter has four skip frequency bands that prevent continuous motor operation within a specific speed range. Further information is provided in function diagram 3050 of the List Manual.

 Overview of the manuals (Page 519)

Minimum speed

The inverter prevents continuous motor operation at speeds < minimum speed.

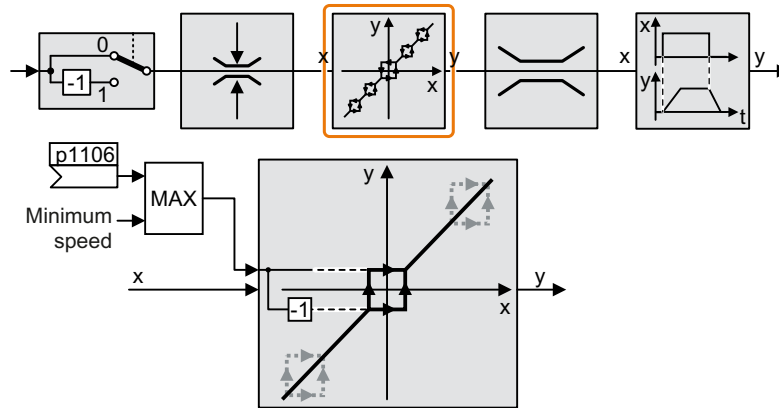

Speeds where the absolute value is less than the minimum speed are only possible during motor operation when accelerating or braking.

Table 6-46 Setting the minimum speed

Parameter	Description
p1080	Minimum speed (factory setting: 0 rpm)
p1106	CI: Minimum speed signal source (factory setting: 0) Dynamic specification of the minimum speed

NOTICE

Incorrect direction of motor rotation if the parameterization is not suitable

If you are using an analog input as speed setpoint source, then for a setpoint = 0 V, noise voltages can be superimposed on the analog input signal. After the on command, the motor accelerates up to the minimum frequency in the direction of the random polarity of the noise voltage. A motor rotating in the wrong direction can cause significant material damage to the machine or system.

- Inhibit the motor direction of rotation that is not permissible.

6.19.5 Speed limitation

The maximum speed limits the speed setpoint range for both directions of rotation.

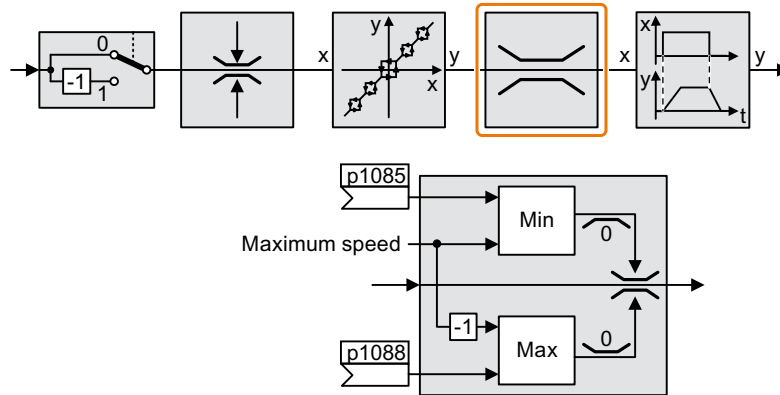

The converter generates a message (fault or alarm) when the maximum speed is exceeded.

If you must limit the speed depending on the direction of rotation, then you can define speed limits for each direction.

Table 6-47 Parameters for the speed limitation

Parameter	Description
p1082	Maximum speed (factory setting: 1500 rpm)
p1083	Speed limit, positive direction of rotation (factory setting: 210,000 rpm)
p1085	CI: Speed limit, positive direction of rotation (factory setting: 1083)
p1086	Speed limit, negative direction of rotation (factory setting: -210,000 rpm)
p1088	CI: Speed limit, negative direction of rotation (factory setting: 1086)

6.19.6 Ramp-function generator

The ramp-function generator in the setpoint channel limits the rate change of the speed setpoint (acceleration). A reduced acceleration reduces the accelerating torque of the motor. In this case, the motor reduces the load on the mechanical system of the driven machine.

You can select between two different ramp-function generator types:

- **Extended ramp-function generator**
The expanded ramp-function generator limits not only the acceleration but also the change in acceleration (jerk) by rounding the setpoint. In this case, the torque does not rise suddenly in the motor.
- **Basic ramp-function generator**
The basic ramp-function generator limits the acceleration, however not the rate the acceleration changes (jerk).

Extended ramp-function generator

The ramp-up and ramp-down times of the extended ramp-function generator can be set independently of each other. The optimum times that you select depend on your particular application in question and can range from just a few 100 ms (e.g. for belt conveyor drives) to several minutes (e.g. for centrifuges).

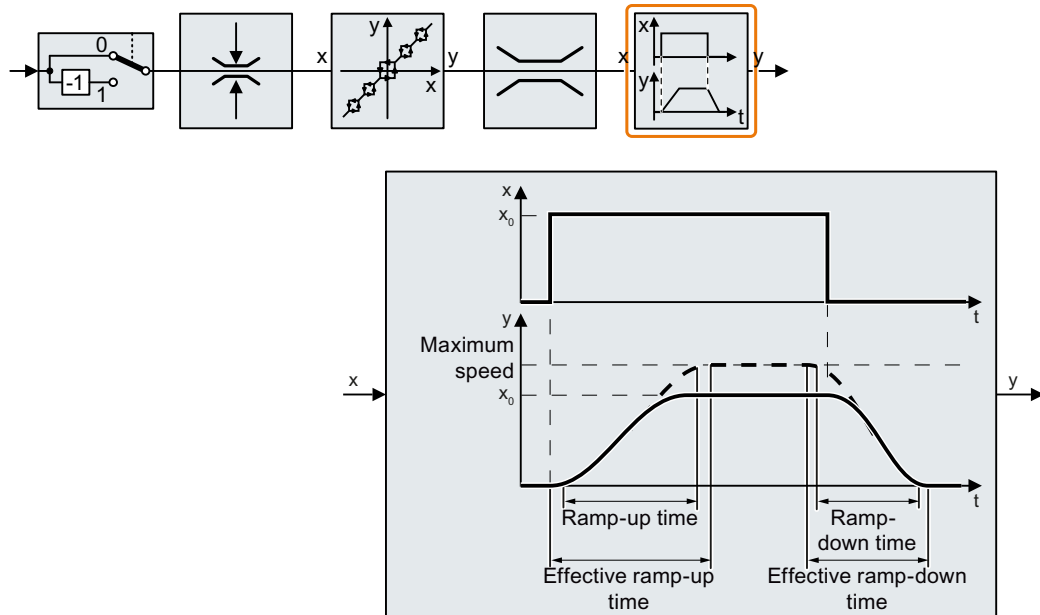

Initial and final rounding permit smooth, jerk-free acceleration and braking.

The ramp-up and ramp-down times of the motor are increased by the rounding times:

- Effective ramp-up time = $p1120 + 0.5 \times (p1130 + p1131)$.
- Effective ramp-down time = $p1121 + 0.5 \times (p1130 + p1131)$.

Table 6-48 Additional parameters to set the extended ramp-function generator

Parameter	Description	
p1115	Ramp-function generator selection (factory setting: 1) Select ramp-function generator: 0: Basic ramp-function generator 1: Extended ramp-function generator	
p1120	Ramp-function generator, ramp-up time (factory setting: 10 s) Accelerating time in seconds from zero speed up to the maximum speed p1082	
p1121	Ramp-function generator, ramp-down time (factory setting: 10 s) Braking time in seconds from the maximum speed down to standstill	
p1130	Ramp-function generator initial rounding time (factory setting: 0 s) Initial rounding for the extended ramp-function generator. The value applies for ramp up and ramp down.	
p1131	Ramp-function generator final rounding time (factory setting: 0 s) Final rounding for the extended ramp-function generator. The value applies for ramp up and ramp down.	
p1134	Ramp-function rounding type (factory setting: 0) 0: Continuous smoothing 1: Discontinuous smoothing	
p1135	OFF3 ramp-down time (factory setting 0 s) The quick stop (OFF3) has its own ramp-down time.	
p1136	OFF3 initial rounding time (factory setting: 0 s) Initial rounding for OFF3 for the extended ramp-function generator.	
p1137	OFF3 final rounding time (factory setting: 0 s) Final rounding for OFF3 for the extended ramp-function generator.	

You can find more information in function diagram 3070 and in the parameter list of the List Manual.

Setting the extended ramp-function generator

Procedure

1. Enter the highest possible speed setpoint.
2. Switch on the motor.

3. Evaluate your drive response.
 - If the motor accelerates too slowly, then reduce the ramp-up time.
An excessively short ramp-up time means that the motor will reach its current limiting when accelerating, and will temporarily not be able to follow the speed setpoint. In this case, the drive exceeds the set time.
 - If the motor accelerates too fast, then extend the ramp-up time.
 - Increase the initial rounding if the acceleration is jerky.
 - In most applications, it is sufficient when the final rounding is set to the same value as the initial rounding.
4. Switch off the motor.
5. Evaluate your drive response.
 - If the motor decelerates too slowly, then reduce the ramp-down time.
The minimum ramp-down time that makes sense depends on your particular application. Depending on the Power Module used, for an excessively short ramp-down time, the inverter either reaches the motor current, or the DC link voltage in the inverter becomes too high.
 - Extend the ramp-down time if the motor is braked too quickly or the inverter goes into a fault condition when braking.
6. Repeat steps 1 ... 5 until the drive behavior meets the requirements of the machine or plant.

You have set the extended ramp-function generator.



Basic ramp-function generator

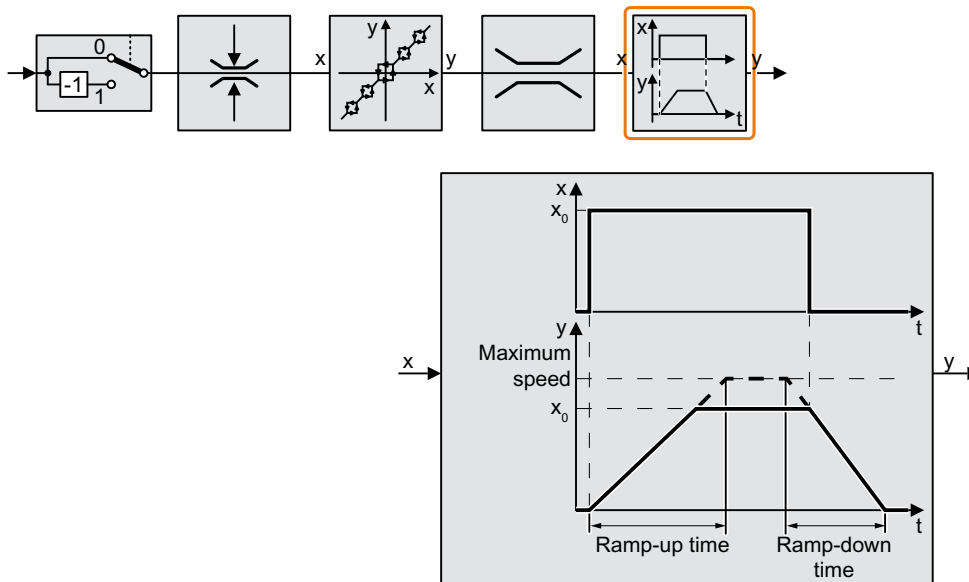

When compared to the extended ramp-function generator, the basic ramp-function generator has no rounding times.

Table 6-49 Parameters for setting the ramp-function generator

Parameter	Description
p1115 = 0	Ramp-function generator selection (factory setting: 1) Select ramp-function generator: 0: Basic ramp-function generator 1: Extended ramp-function generator
p1120	Ramp-function generator, ramp-up time (factory setting: 10 s) Accelerating time in seconds from zero speed up to the maximum speed p1082
p1121	Ramp-function generator, ramp-down time (factory setting: 10 s) Braking time in seconds from the maximum speed down to standstill
p1135	OFF3 ramp-down time (factory setting: 0 s) The quick stop (OFF3) has its own ramp-down time.

Changing the ramp-up and ramp-down times in operation

The ramping up and down time of the ramp-function generator can be changed during operation. The scaling value can come, e.g. from the fieldbus.

Table 6-50 Parameters for setting the scaling

Parameter	Description
p1138	Up ramp scaling (factory setting: 1) Signal source for scaling the acceleration ramp.
p1139	Deceleration ramp scaling (factory setting: 1) Signal source for scaling the deceleration ramp.

Application example

In the following application example, the higher-level control sets the ramp-up and ramp-down times of the inverter via PROFIBUS.

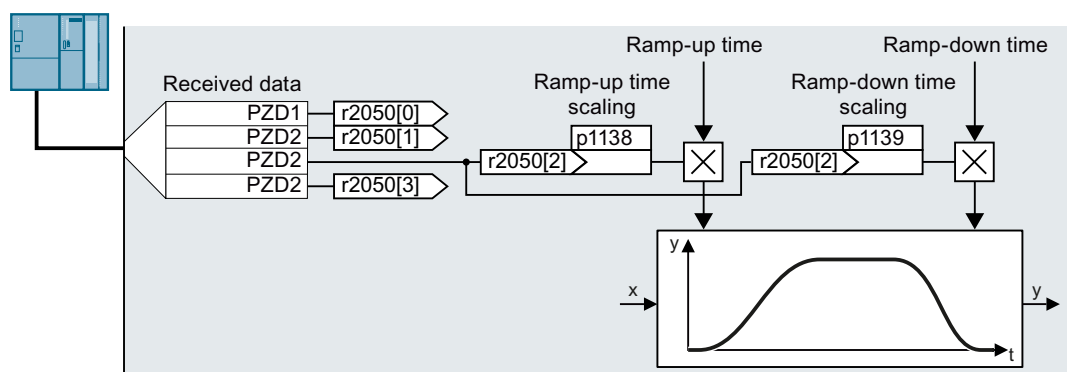



Figure 6-43 Application example for changing the ramp-function generator times in operation

Preconditions

- You have commissioned the communication between the inverter and the control system.
- Free telegram 999 has been set in the inverter and in your higher-level control system.
 Extending the telegram (Page 203)
- The control sends the scaling value to the inverter in PZD 3.

Procedure

1. Set p1138 = 2050[2].
This means that you have interconnected the scaling factor for the ramp-up time with PZD receive word 3.
2. Set p1139 = 2050[2].
This means that you have interconnected the scaling factor for the ramp-down time with PZD receive word 3.

The inverter receives the value for scaling the ramp-up and ramp-down times via PZD receive word 3.



Further information is provided on the Internet:

 FAQ (<https://support.industry.siemens.com/cs/ww/en/view/82604741>)

6.20 PID technology controller

Overview



The technology controller controls process variables, e.g. pressure, temperature, level or flow.

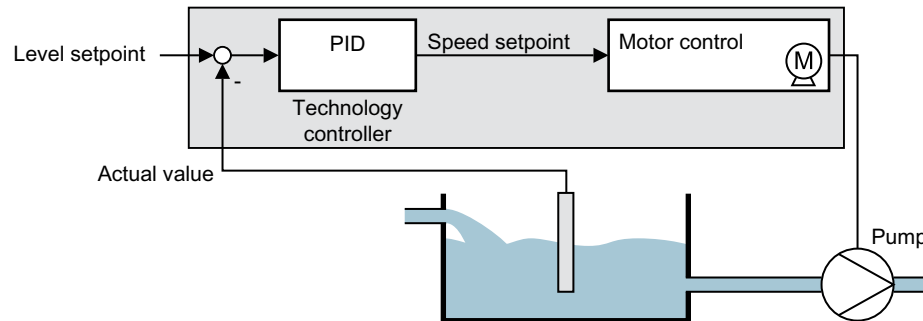

Figure 6-44 Example: Technology controller as a level controller

Precondition

Additional functions

The motor closed-loop control is set

Tools

To change the function settings, you can use an operator panel or a PC tool, for example.

Function description

Function diagram

The technology controller is implemented as a PID controller (controller with proportional, integral, and derivative action).

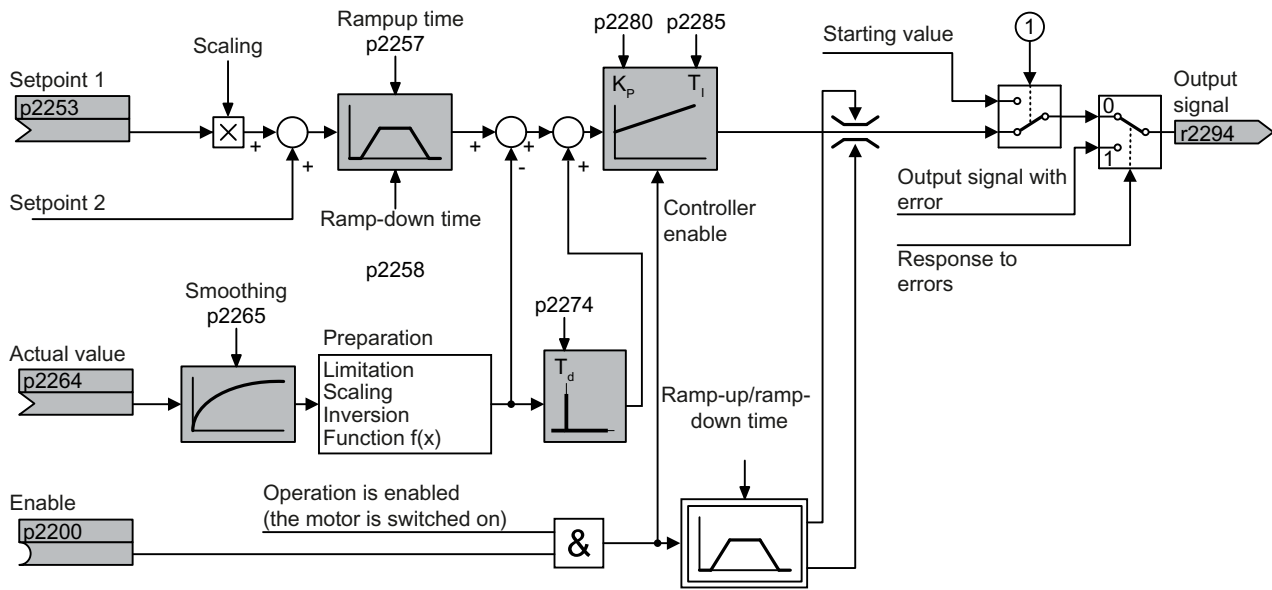

① The inverter uses the start value when all the following conditions are simultaneously satisfied:

- The technology controller supplies the main setpoint (p2251 = 0).
- The ramp-function generator output of the technology controller has not yet reached the start value.

Figure 6-45 Simplified representation of the technology controller

Basic settings

The settings required as a minimum are marked in gray in the function diagram:

- Interconnect setpoint and actual values with signals of your choice
- Set ramp-function generator and controller parameters K_p , T_i and T_d .

Set controller parameters K_p , T_i and T_d .

Procedure

- Temporarily set the ramp-up and ramp-down times of the ramp-function generator (p2257 and p2258) to zero.
- Enter a setpoint step and monitor the associated actual value, e.g. with the trace function of STARTER.
The slower the response of the process to be controlled, the longer you must monitor the controller response. Under certain circumstances (e.g. for a temperature control), you need to wait several minutes until you can evaluate the controller response.

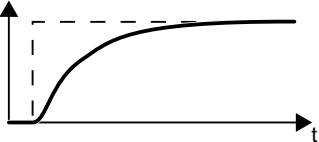
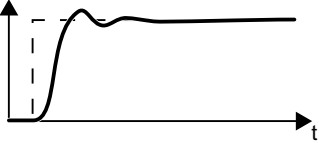
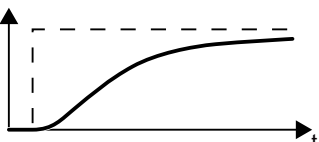
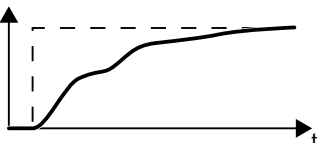
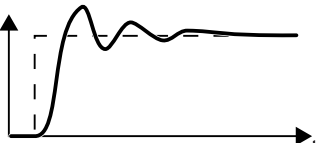
	<p>Optimum controller response for applications that do not permit any overshoot.</p> <p>The actual value approaches the setpoint without any significant overshoot.</p>
	<p>Optimum controller behavior for fast correction and quick compensation of disturbance components.</p> <p>The actual value approaches the setpoint and slightly overshoots, maximum 10% of the setpoint step.</p>
	<p>The actual value only slowly approaches the setpoint.</p> <ul style="list-style-type: none"> Increase the proportional component K_p (p2280) and reduce the integration time T_i (p2285).
	<p>The actual value only slowly approaches the setpoint with slight oscillation.</p> <ul style="list-style-type: none"> Increase the proportional component K_p (p2280) and reduce the rate time T_d (p2274)
	<p>The actual value quickly approaches the setpoint, but overshoots too much.</p> <ul style="list-style-type: none"> Decrease the proportional component K_p (p2280) and increase the integration time T_i (p2285).

- Set the ramp-up and ramp-down times of the ramp-function generator back to their original value.

You have manually set the technology controller.



Limiting the output of the technology controller

In the factory setting, the output of the technology controller is limited to \pm maximum speed. You must change this limit, depending on your particular application.

Example: The output of the technology controller supplies the speed setpoint for a pump. The pump should only run in the positive direction.

Parameter

Table 6-51 Basic settings

Parameter	Description	Setting
p2200	BI: Technology controller enable	1 signal: Technology controller is enabled. Factory setting: 0
r2294	CO: Technology controller output signal	To interconnect the main speed setpoint with the technology controller output, set p1070 = 2294.
p2253	CI: Technology controller setpoint 1	Setpoint for the technology controller. Example: p2253 = 2224: Fixed setpoint p2201 is interconnected with the setpoint of the technology controller. p2220 = 1: The fixed setpoint p2201 is selected. Factory setting: 0
p2264	CI: Technology controller actual value	Technology controller actual value. Factory setting: 0
p2257, p2258	Technology controller ramp-up time and ramp-down time [s]	Factory setting: 0.0 s
p2274	Technology controller differentiation time constant T_d [s]	The differentiation improves the rise time for very slow controlled variables, e.g. a temperature control. Factory setting: 0.0 s
p2280	Technology controller proportional gain K_p	Factory setting: 1.0
p2285	Technology controller integration time (integral time) T_i	Factory setting: 30 s

Table 6-52 Limiting the output of the technology controller

Parameter	Description	Setting
p2297	CI: Technology controller maximum limiting signal source	Factory setting: 1084
p2298	CI: Technology controller minimum limiting signal source	Factory setting: 2292
p2291	CO: Technology controller maximum limiting [%]	Factory setting: 100 %
p2292	CO: Technology controller minimum limiting [%]	Factory setting: 0 %

Table 6-53 Adapting the actual value of the technology controller

Parameter	Description	Setting
p2267	Technology controller upper limit actual value [%]	Factory setting: 100 %
p2268	Technology controller lower limit actual value [%]	Factory setting: -100 %
p2269	Technology controller gain actual value [%]	Factory setting: 100 %
p2271	Technology controller actual value inversion	Technology controller actual value inversion If the actual value decreases with increasing motor speed, then p2271 must be set = 1. 0: no inversion 1: actual value signal is inverted Factory setting: 0
p2270	Technology controller actual value function	Technology controller actual value function 0: no function 1: $\sqrt{\quad}$ 2: x^2 3: x^3 Factory setting: 0

Further information

For additional information refer to the function diagrams 7950 ff of the List Manual.

You will find additional information on the following PID controller components in the Internet at:

- Setpoint input: Analog value or fixed setpoint
- Setpoint channel: Scaling, ramp-function generator and filter
- Actual value channel: Filter, limiting and signal processing
- PID controller Principle of operation of the D component, inhibiting the I component and the control sense
- Enable, limiting the controller output and fault response



FAQ (<http://support.automation.siemens.com/WW/view/en/92556266>)

6.21 Motor control



The inverter has two alternative methods to control (closed loop) the motor speed:

- U/f control
- Vector control

6.21.1 Reactor, filter and cable resistance at the inverter output

Correctly setting the components between the inverter and motor

Components between the inverter and the motor influence the closed-loop control quality of the inverter:

- Output reactor or sine-wave filter
In the factory setting, for the motor data identification, the inverter assumes that neither output reactor nor sine wave filter are connected at to the inverter output.
- Motor cable with unusually high cable resistance.
For the motor data identification, the inverter assumes a cable resistance = 20 % of the stator resistance of the cold motor.

You must correctly set the components between the inverter and motor to achieve an optimum closed-loop control quality

Setting the reactor, filter and cable resistance between the inverter and motor

Procedure

1. Set p0010 = 2.
2. Set the cable resistance in p0352.
3. Set p0230 to the appropriate value.
4. Set p0235 to the appropriate value.
5. Set p0010 = 0.
6. Carry out the quick commissioning and the motor identification again.
 Commissioning (Page 125)

You have set the reactor, filter and cable resistance between the inverter and motor.

□

Parameter

Parameter	Description
p0010	Drive commissioning parameter filter (factory setting: 1) 0: Ready 2: Power unit commissioning
p0230	Drive filter type, motor side (factory setting: 0) 0: No filter 1: Output reactor 2: dv/dt filter 3: Siemens sine-wave filter 4: Sine wave filter, third-party manufacturer
p0235	Number of motor reactors in series (factory setting: 1) Number of reactors connected in series at the inverter output
p0350	Motor stator resistance, cold (factory setting: 0 Ω) When selecting a list motor (p0301), p0350 is preset (default setting) and is write protected.
p0352	Cable resistance (Factory setting: 0 Ω) If you set p0352 after the motor data identification, then you must subtract the difference that was changed with p0352, from the stator resistance p0350 or repeat the motor data identification.

Additional information on the parameters is provided in the List Manual.

6.21.2 V/f control

Overview of the U/f control

The U/f control is a closed-loop speed control with the following characteristics:

- The inverter controls the output voltage using the V/f characteristic
- The output frequency is essentially calculated from the speed setpoint and the number of pole pairs of the motor
- The slip compensation corrects the output frequency depending on the load and thus increases the speed accuracy
- Not using a PI controller prevents the speed control from becoming unstable
- In applications in which greater speed accuracy is required, a closed-loop control with load-dependent voltage boost can be selected (flux current control, FCC)

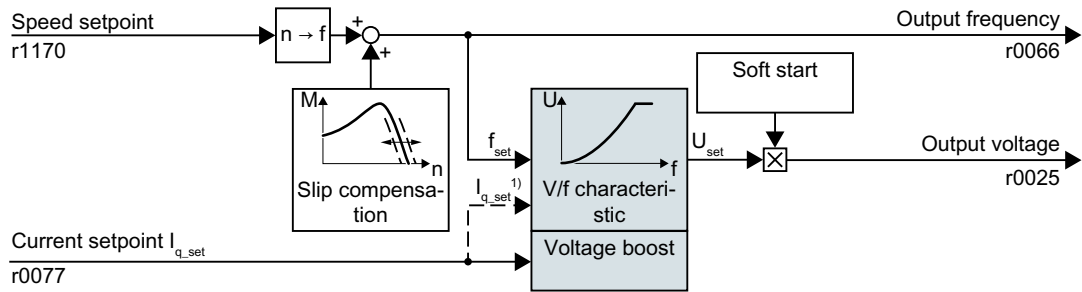

1) In the U/f control variant, "flux current control (FCC)," the inverter controls the motor current (starting current) at low speeds

Figure 6-46 Simplified function diagram of the U/f control

One function not shown in the simplified function diagram is the resonance damping for damping mechanical oscillations. You will find the complete function diagrams 6300 et seq. in the List Manual.

For operation of the motor with U/f control, you must set at least the subfunctions shown with a gray background in the figure to adapt them to your application:

- V/f characteristic
- Voltage boost

Default setting after selecting the application class Standard Drive Control

Selecting application class Standard Drive Control in the quick commissioning adapts the structure and the setting options of the U/f control as follows:

- Starting current closed-loop control: At low speeds, a controlled motor current reduces the tendency of the motor to oscillate.
- With increasing speed, transition from closed-loop starting current control into U/f control with voltage boost depending on the load.
- The slip compensation is activated.
- Soft starting is not possible.
- Fewer parameters

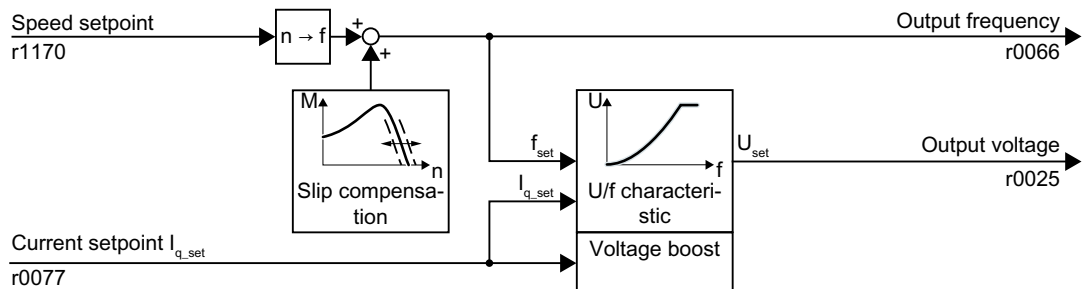
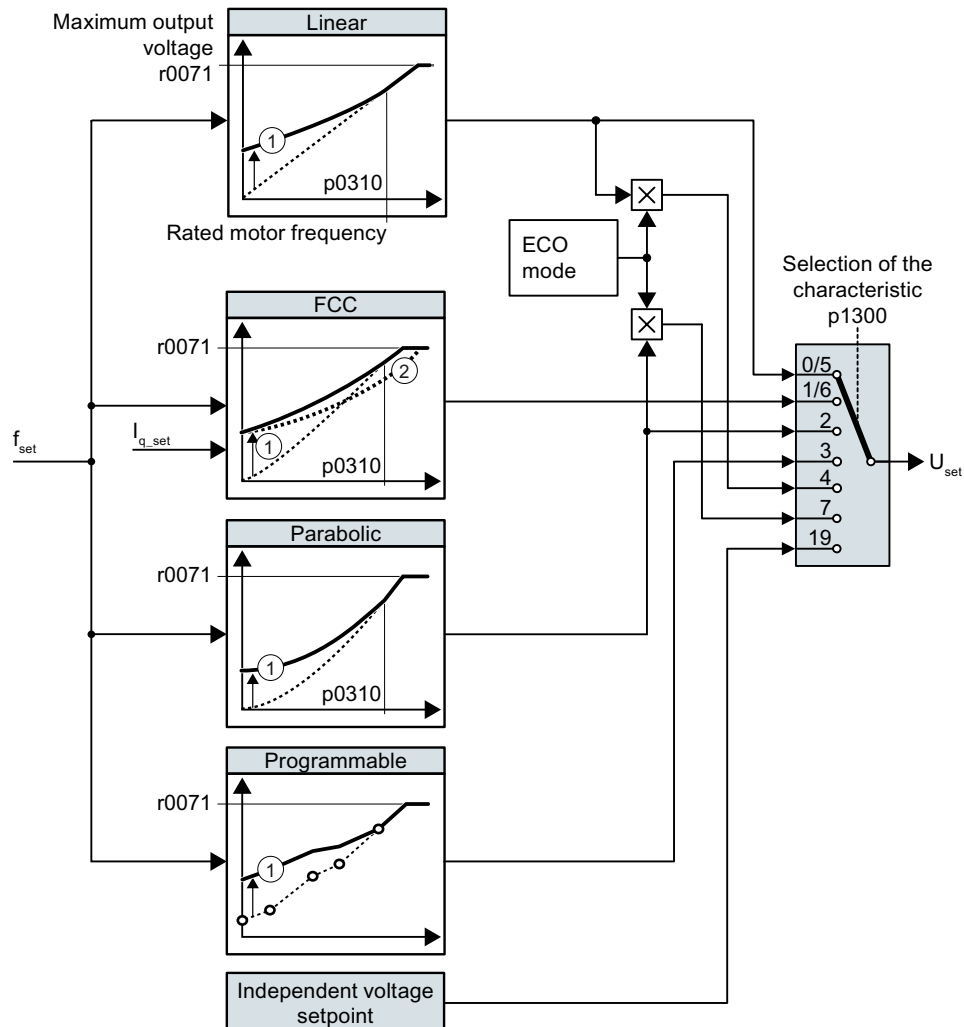

Figure 6-47 Default setting of the U/f control after selecting Standard Drive Control

The complete function diagrams 6850 ff. for application class Standard Drive Control are provided in the List Manual.

6.21.2.1 Characteristics of U/f control

The inverter has different V/f characteristics.



- ① The voltage boost of the characteristic optimizes the speed control at low speeds
- ② With the flux current control (FCC), the inverter compensates for the voltage drop in the stator resistor of the motor

Figure 6-48 Characteristics of V/f control

The inverter increases its output voltage to the maximum possible output voltage. The maximum possible output voltage of the inverter depends on the line voltage.

When the maximum output voltage is reached, the inverter only increases the output frequency. At this point, the motor enters the field weakening range: At constant torque, the slip decreases quadratically as the speed increases.

The value of the output voltage at the rated motor frequency also depends on the following variables:

- Ratio between the inverter size and the motor size
- Line voltage

6.21 Motor control

- Line impedance
- Actual motor torque

The maximum possible output voltage as a function of the input voltage is provided in the technical data.

 Technical data (Page 439)

Table 6-54 Linear and parabolic characteristics

Requirement	Application examples	Remark	Characteristic	Parameter
The required torque is independent of the speed	Conveyor belts, roller conveyors, chain conveyors, eccentric worm pumps, compressors, extruders, centrifuges, agitators, mixers	-	Linear	p1300 = 0
		The inverter equalizes the voltage drops across the stator resistance. Recommended for motors less than 7.5 kW. Precondition: You have set the motor data according to the rating plate and have performed the motor identification after quick commissioning.	Linear with Flux Current Control (FCC)	p1300 = 1
The required torque increases with the speed	Centrifugal pumps, radial fans, axial fans	Lower losses in the motor and inverter than for a linear characteristic.	Parabolic	p1300 = 2

Table 6-55 Characteristics for special applications

Requirement	Application examples	Remark	Characteristic	Parameter
Applications with a low dynamic response and constant speed	Centrifugal pumps, radial fans, axial fans	If the speed setpoint is reached, and remains unchanged for 5 seconds, then the inverter reduces its output voltage. As a consequence, the ECO mode saves energy with respect to the parabolic characteristic.	ECO mode	p1300 = 4 or p1300 = 7
The inverter must maintain the motor speed constant for the longest possible time.	Drives in the textile sector	When reaching the maximum current limit, the inverter only reduces the output voltage, but not the frequency.	Precise frequency characteristic	p1300 = 5 or p1300 = 6
Freely adjustable U/f characteristic	-	-	Adjustable characteristic	p1300 = 3
U/f characteristic with independent voltage setpoint	-	The interrelationship between the frequency and voltage is not calculated in the inverter, but is specified by the user.	Independent voltage setpoint	p1300 = 19

Additional information on U/f characteristics can be found in the parameter list and in the function diagrams 6300 ff of the List Manual.

Characteristics after selecting the application class Standard Drive Control

Selecting application class Standard Drive Control reduces the number of characteristics and the setting options:

- A linear and a parabolic characteristic are available.
- Selecting a technological application defines the characteristic.
- The following cannot be set - ECO mode, FCC, the programmable characteristic and a specific voltage setpoint.

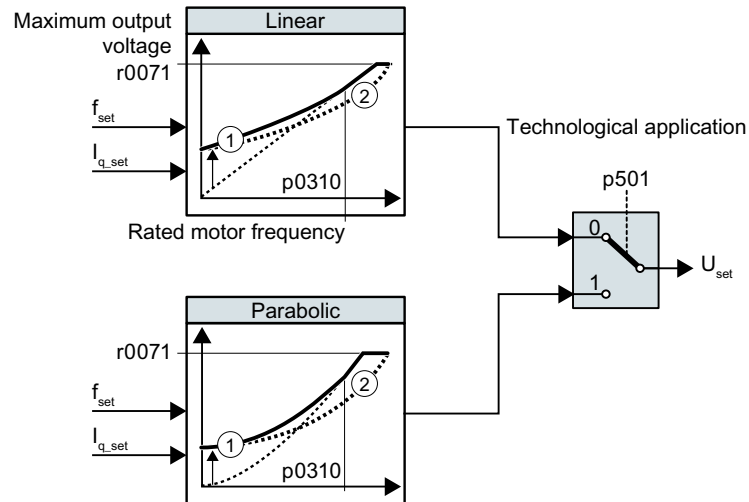

- ① The closed-loop starting current control optimizes the speed control at low speeds
 ② The inverter compensates the voltage drop across the motor stator resistance

Figure 6-49 Characteristics after selecting Standard Drive Control

Table 6-56 Linear and parabolic characteristics

Requirement	Application examples	Remark	Characteristic	Parameter
The required torque is independent of the speed	Conveyor belts, roller conveyors, chain conveyors, eccentric worm pumps, compressors, extruders, centrifuges, agitators, mixers	-	Linear	p0501 = 0
The required torque increases with the speed	Centrifugal pumps, radial fans, axial fans	Lower losses in the motor and inverter than for a linear characteristic.	Parabolic	p0501 = 1

Additional information on the characteristics can be found in the parameter list and in the function diagrams 6851 ff of the List Manual.

6.21.2.2 Optimizing motor starting

After selection of the U/f characteristic, no further settings are required in most applications. In the following circumstances, the motor cannot accelerate to its speed setpoint after it has been switched on:

- Load moment of inertia too high
- Load torque too large
- Ramp-up time p1120 too short

To improve the starting behavior of the motor, a voltage boost can be set for the U/f characteristic at low speeds.

Setting the voltage boost for U/f control

The inverter boosts the voltage corresponding to the starting currents p1310 ... p1312.

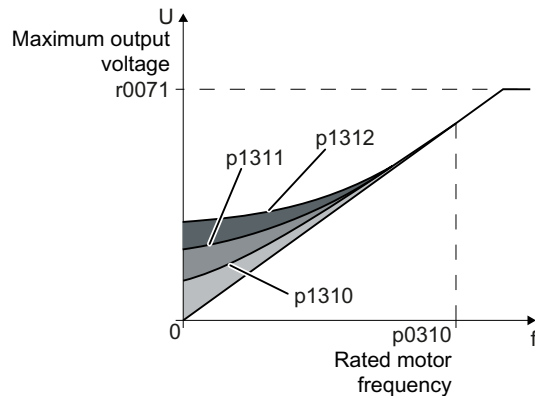

Figure 6-50 The resulting voltage boost using a linear characteristic as example

Preconditions

- Set the ramp-up time of the ramp-function generator to a value 1 s (< 1 kW) ... 10 s (> 10 kW), depending on the power rating of the motor.
- Increase the starting current in steps of $\leq 5\%$. Excessively high values in p1310 ... p1312 can cause the motor to overheat and switch off (trip) the inverter due to overcurrent. If message A07409 appears, it is not permissible that you further increase the value of any of the parameters.

Procedure

1. Switch on the motor with a setpoint of a few revolutions per minute.
2. Check whether the motor rotates smoothly.
3. If the motor does not rotate smoothly, or even remains stationary, increase the voltage boost p1310 until the motor runs smoothly.
4. Accelerate the motor to the maximum speed with maximum load.
5. Check that the motor follows the setpoint.
6. If necessary, increase the voltage boost p1311 until the motor accelerates without problem.

In applications with a high break loose torque, you must also increase parameter p1312 in order to achieve a satisfactory motor response.

You have set the voltage boost.



Parameter	Description
p1310	Starting current (voltage boost) permanent (factory setting 50%) Compensates for voltage drops caused by long motor cables and the ohmic losses in the motor.
p1311	Starting current (voltage boost) when accelerating (factory setting 0%) Provides additional torque when the motor accelerates.
p1312	Starting current (voltage boost) when starting (factory setting 0%) Provides additional torque, however, only when the motor accelerates for the first time after it has been switched on ("break loose torque").

You will find more information on this function in the parameter list and in function diagram 6301 in the List Manual.

6.21.2.3 Optimizing the motor startup for application class Standard Drive Control

After selecting application class Standard Drive Control, in most applications no additional settings need to be made.

At standstill, the inverter ensures that at least the rated motor magnetizing current flows. Magnetizing current p0320 approximately corresponds to the no-load current at 50% ... 80% of the rated motor speed.

In the following circumstances, the motor cannot accelerate to its speed setpoint after it has been switched on:

- Load moment of inertia too high
- Load torque too large
- Ramp-up time p1120 too short

The current can be increased at low speeds to improve the starting behavior of the motor.

Starting current (boost) after selecting the application class Standard Drive Control

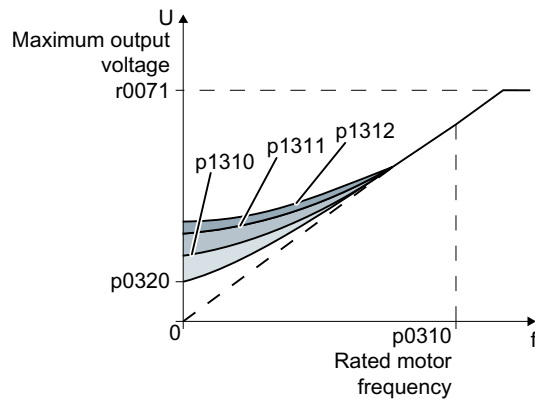

Figure 6-51 The resulting voltage boost using a linear characteristic as example

The inverter boosts the voltage corresponding to the starting currents p1310 ... p1312.

Preconditions

- Set the ramp-up time of the ramp-function generator to a value 1 s (< 1 kW) ... 10 s (> 10 kW), depending on the power rating of the motor.
- Increase the starting current in steps of $\leq 5\%$. Excessively high values in p1310 ... p1312 can cause the motor to overheat and switch off (trip) the inverter due to overcurrent. If message A07409 appears, it is not permissible that you further increase the value of any of the parameters.

Procedure

1. Switch on the motor with a setpoint of a few revolutions per minute.
2. Check whether the motor rotates smoothly.
3. If the motor does not rotate smoothly, or even remains stationary, increase the voltage boost p1310 until the motor runs smoothly.
4. Accelerate the motor to the maximum speed with maximum load.

5. Check that the motor follows the setpoint.
6. If necessary, increase the voltage boost p1311 until the motor accelerates without problem.

In applications with a high break loose torque, you must also increase parameter p1312 in order to achieve a satisfactory motor response.

You have set the voltage boost.



Parameter	Description
p1310	Starting current (voltage boost) permanent (factory setting 50%) Compensates for voltage drops caused by long motor cables and the ohmic losses in the motor. After commissioning, depending on the motor power rating and the technological application p0501, the inverter sets p1310.
p1311	Starting current (voltage boost) when accelerating (factory setting 0%) Provides additional torque when the motor accelerates. After commissioning, depending on the motor power rating and the technological application p0501, the inverter sets p1311.
p1312	Starting current (voltage boost) when starting (factory setting 0%) Provides additional torque, however, only when the motor accelerates for the first time after it has been switched on ("break loose torque").

You can find more information about this function in the parameter list and in function diagram 6851 of the List Manual.

6.21.3 Vector control

6.21.3.1 Structure of the vector control

Overview

The vector control comprises closed-loop current control and a higher-level closed-loop speed control.

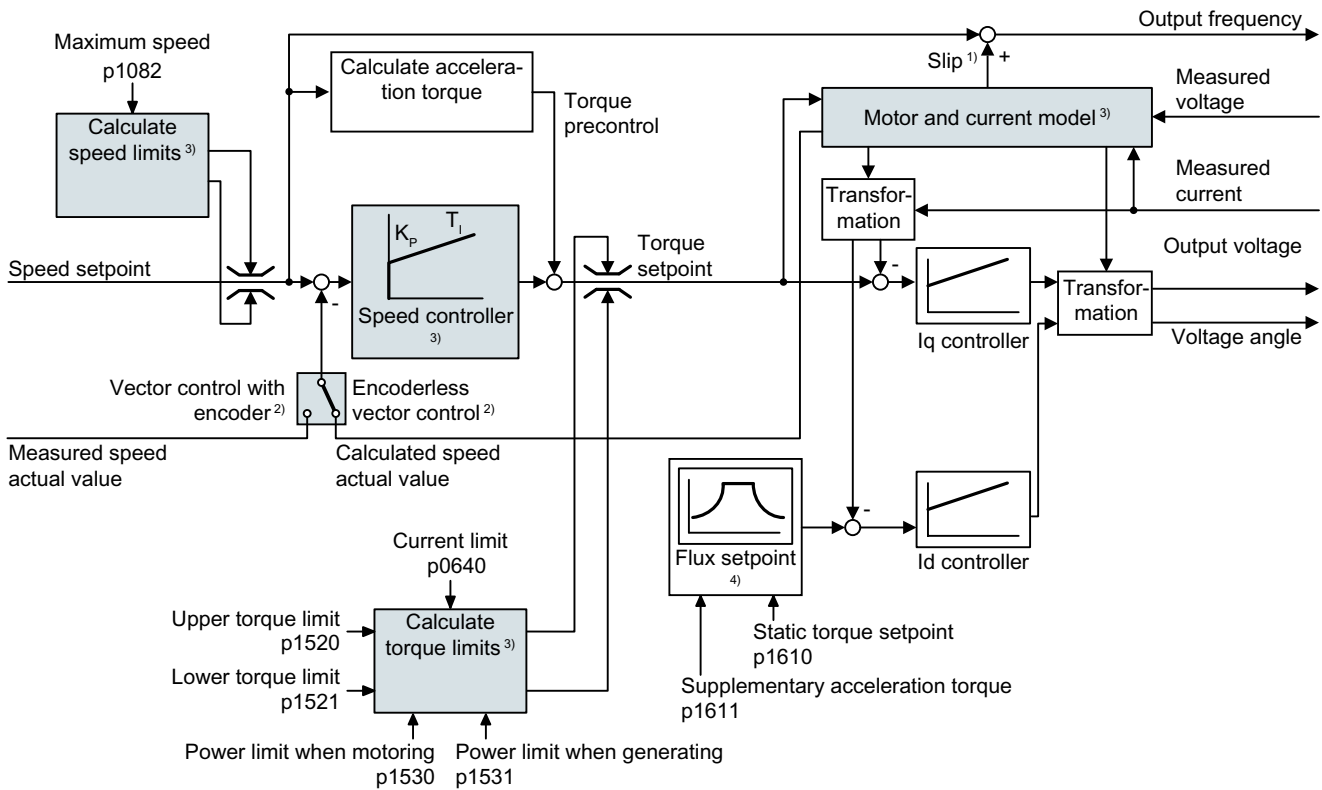

1) for induction motors

2) Selecting the control mode

3) Settings that are required

Figure 6-52 Simplified function diagram for vector control with speed controller

Using the motor model, the inverter calculates the following closed-loop control signals from the measured phase currents and the output voltage:

- Current component I_q
- Current component I_d
- Speed actual value for encoderless vector control

The setpoint of the current component I_d (flux setpoint) is obtained from the motor data. For speeds above the rated speed, the inverter reduces the flux setpoint along the field weakening characteristic.

When the speed setpoint is increased, the speed controller responds with a higher setpoint for current component I_q (torque setpoint). The closed-loop control responds to a higher torque setpoint by adding a higher slip frequency to the output frequency. The higher output frequency also results in a higher motor slip, which is proportional to the accelerating torque. I_q and I_d controllers keep the motor flux constant using the output voltage, and adjust the matching current component I_q in the motor.

The complete function diagrams 6020 ff. for vector control are provided in the List Manual.

Settings that are required

Select the vector control during to quick commissioning.



Quick commissioning with a PC (Page 134)

In order to achieve a satisfactory control response, as a minimum you must set the partial functions – shown with gray background in the diagram above – to match your particular application:



- **Motor and current model:** In the quick commissioning, correctly set the motor data on the rating plate corresponding to the connection type (Y/ Δ), and carry out the motor data identification routine at standstill.
- **Speed limits and torque limits:** In the quick commissioning, set the maximum speed (p1082) and current limit (p0640) to match your particular application. When exiting quick commissioning, the inverter calculates the torque and power limits corresponding to the current limit. The actual torque limits are obtained from the converted current and power limits and the set torque limits.
- **Speed controller:** Start the rotating measurement of the motor data identification. You must manually optimize the controller if the rotating measurement is not possible.



WARNING

The load falls due to incorrect closed-loop control settings

For encoderless vector control, the inverter calculates the actual speed based on an electric motor model. In applications with pulling loads - e.g. hoisting gear, lifting tables or vertical conveyors - an incorrectly set motor model or other incorrect settings can mean that the load falls. A falling load can result in death or serious injury.

- Correctly set the motor data during the quick commissioning.
- Carry out the motor data identification.
- Correctly set the "Motor holding brake" function.
 -  Motor holding brake (Page 220)
- For pulling loads, carefully comply with the recommended settings for vector control.
 -  Advanced settings (Page 303)

6.21.3.2 Default setting as a result of the application class Dynamic Drive Control

Selecting application class Dynamic Drive Control in the quick commissioning adapts the structure of the vector control, and reduces the setting options:

	Vector control after selecting the application class Dynamic Drive Control	Vector control without selecting an application class
Closed-loop torque control without higher-level speed controller	Not possible	Possible
Droop	Not possible	Possible
K _p - and T _i adaptation	Simplified	Advanced
Hold or set the integral component of the speed controller	Not possible	Possible
Acceleration model for pre-control	Default setting	Can be activated
Motor data identification at standstill or with rotating measurement	Shortened, with optional transition into operation	Complete

6.21.3.3 Checking the encoder signal

If you use an encoder to measure the speed, you should check the encoder signal before the encoder feedback is active.

Procedure

1. Set the control mode "encoderless vector control": p1300 = 20.
2. Switch-on the motor with an average speed.
3. Compare parameters r0061 (speed encoder signal in rpm) and r0021 (calculated speed in rpm) regarding the sign and absolute value.
4. If the signs do not match, invert the speed encoder signal: Set p0410 = 1.
5. If the absolute values of the two values do not match, check the setting of p0408 and the encoder wiring.

You have ensured that the scaling and polarity of the encoder signal are correct.

6.21.3.4 Optimizing the speed controller

Optimum control response - post optimization not required

Preconditions for assessing the controller response:

- The moment of inertia of the load is constant and does not depend on the speed
- The inverter does not reach the set torque limits during acceleration
- You operate the motor in the range 40 % ... 60 % of its rated speed

If the motor exhibits the following response, the speed control is well set and you do not have to adapt the speed controller manually:

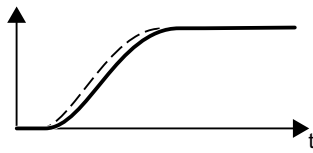

The speed setpoint (broken line) increases with the set ramp-up time and rounding.

The speed actual value follows the setpoint without any overshoot.

Control optimization required

In some cases, the self optimization result is not satisfactory, or self optimization is not possible as the motor cannot freely rotate.

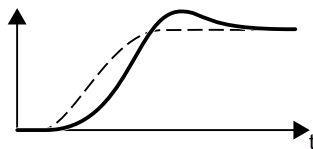

Initially, the speed actual value follows the speed setpoint with some delay, and then overshoots the speed setpoint.

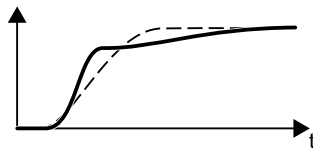

First, the actual speed value increases faster than the speed setpoint. Before the setpoint reaches its final value, it passes the actual value. Finally, the actual value approaches the setpoint without any significant overshoot.

In the two cases describe above, we recommend that you manually optimize the speed control.

Optimizing the speed controller

Preconditions

- Torque precontrol is active: p1496 = 100 %.
- The load moment of inertia is constant and independent of the speed.
- The inverter requires 10 % ... 50 % of the rated torque to accelerate.
When necessary, adapt the ramp-up and ramp-down times of the ramp-function generator (p1120 and p1121).
- STARTER and Startdrive have trace functions that allow the speed setpoint and actual value to be recorded.

Procedure

1. Switch on the motor.
2. Enter a speed setpoint of approximately 40 % of the rated speed.
3. Wait until the actual speed has stabilized.
4. Increase the setpoint up to a maximum of 60 % of the rated speed.
5. Monitor the associated characteristic of the setpoint and actual speed.

6. Optimize the controller by adapting the ratio of the moments of inertia of the load and motor (p0342):

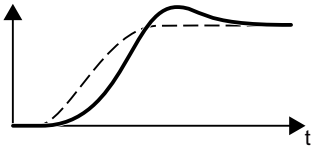
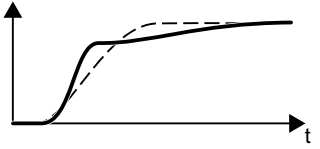
	<p>Initially, the speed actual value follows the speed setpoint with some delay, and then overshoots the speed setpoint.</p> <ul style="list-style-type: none"> • Increase p0342
	<p>Initially, the speed actual value increases faster than the speed setpoint. The setpoint passes the actual value before reaching its final value. Finally, the actual value approaches the setpoint without any overshoot.</p> <ul style="list-style-type: none"> • Reduce p0342

7. Switch off the motor.
8. Set p0340 = 4. The inverter again calculates the speed controller parameters.
9. Switch on the motor.
10. Over the complete speed range check as to whether the speed control operates satisfactorily with the optimized settings.

You have optimized the speed controller.



When necessary, set the ramp-up and ramp-down times of the ramp-function generator (p1120 and p1121) back to the value before optimization.

Mastering critical applications

The drive control can become unstable for drives with a high load moment of inertia and gearbox backlash or a coupling between the motor and load that can possibly oscillate. In this case, we recommend the following settings:

- Encoderless vector control - and vector control with encoder
 - Increase p1452 (smoothing the speed actual value).
 - Increase p1472 (integral time T_I): $T_I \geq 4 \cdot p1452$
 - If, after these measures, the speed controller does not operate with an adequate dynamic performance, then increase p1470 (gain K_p) step-by-step.
- Additional settings for vector control with encoder
 - Increase p1441 (smoothing the speed actual value): $p1441 = 2 \dots 4 \text{ ms}$.

The most important parameters

Table 6-57 Encoderless speed control

Parameter	Description
p0342	Moment of inertia ratio, total to motor (factory setting: 1.0)
p1496	Acceleration precontrol scaling (factory setting: 0 %) For the rotating measurement of the motor data identification the inverter sets the parameters to 100 %.
p1452	Speed controller speed actual value smoothing time (without encoder) (factory setting: 10 ms)
p1470	Speed controller operation without encoder P gain (factory setting: 0.3)
p1472	Speed controller operation without encoder integral action time (factory setting: 20 ms)

Table 6-58 Speed control with encoder

Parameter	Description
p0342	Moment of inertia ratio, total to motor (factory setting: 1.0)
p1496	Acceleration precontrol scaling (factory setting: 0 %) For the rotating measurement of the motor data identification the inverter sets the parameters to 100 %.
p1441	Speed controller smoothing time (factory setting: 0 ms)
p1442	Speed controller speed actual value smoothing time (factory setting: 4 ms)
p1460	Speed controller operation without encoder P gain (factory setting: 0.3)
p1462	Speed controller operation without encoder integral action time (factory setting: 20 ms)

6.21.3.5 Advanced settings

K_p - and T_i adaptation

K_p and T_i adaptation suppress speed control oscillations that may occur. The "rotating measurement" of the motor data identification optimizes the speed controller. If you have performed the rotating measurement, then the K_p - and T_i adaptation has been set.

You can find additional information in the List Manual:

- Vector control with speed controller: Function diagram 6050
- Vector control after presetting the application class Dynamic Drive Control Function diagram 6824

Droop

For mechanically coupled drives, there is the risk that the drives oppose one another: Small deviations in the speed setpoint or actual value of the coupled drives can mean that the drives are operated with significantly different torques.

The droop function ensures even torque distribution between several mechanically coupled drives.

The droop function reduces the speed setpoint as a function of the torque setpoint.

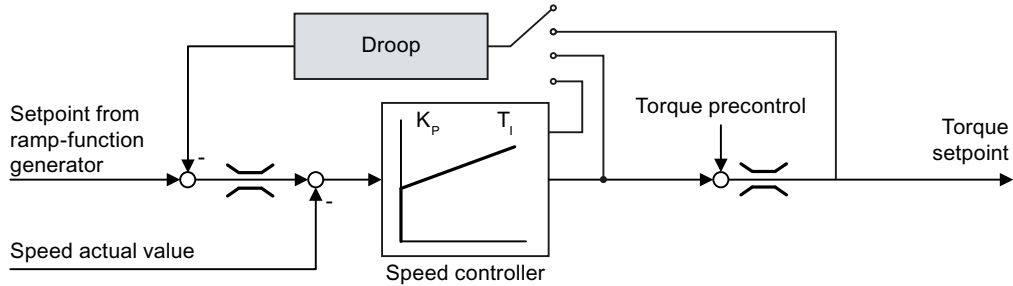

Figure 6-53 Effect of droop in the speed controller

When droop is active, the ramp-function generators of all of the coupled drives must be set to have identical ramp-up and ramp-down times as well as rounding-off.

Par.	Explanation
r1482	Speed controller I torque output
p1488	Droop input source (factory setting: 0) 0: Droop feedback not connected 1: Droop from the torque setpoint 2: Droop from the speed control output 3: Droop from the integral output, speed controller
p1489	Droop feedback scaling (factory setting: 0.05) A value of 0.05 means: At the rated motor torque, the inverter reduces the speed by 5% of the rated motor speed.
r1490	Droop feedback speed reduction
p1492	Droop feedback enable (factory setting: 0)

After selecting application class "Dynamic Drive Control", droop is no longer possible.

You can find additional information in the List Manual, function block diagram 6030.

Special settings for a pulling load

For a pulling load, e.g. a hoisting gear, a permanent force is exerted on the motor, even when the motor is stationary.

For a pulling load, we recommend that you use vector control with an encoder.

If you use encoderless vector control with a pulling load, then the following settings are required:

- Set the following parameters:

Par.	Explanation	
p1750	Motor model configuration	
	Bit 07 = 1	Use speed switchover limits that are less sensitive to external effects
p1610	Static torque setpoint (encoderless) (Factory setting: 50 %) Set a value which is higher than the maximum load torque that occurs.	

- When opening the motor holding brake, enter a speed setpoint > 0 .
For speed setpoint = 0, and with the motor holding brake open, the load drops because the induction motor rotates with the slip frequency as a result of the pulling load.
- Set the ramp-up and ramp-down times ≤ 10 s in the ramp-function generator.
- If, in quick commissioning, you have selected application class Dynamic Drive Control then set p0502 = 1 (technological application: dynamic starting or reversing).

6.21.3.6 Friction characteristic

Function

In many applications, e.g. applications with geared motors or belt conveyors, the frictional torque of the load is not negligible.

The inverter provides the possibility of precontrolling the torque setpoint, bypassing the speed controller. The precontrol reduces overshooting of the speed after speed changes.

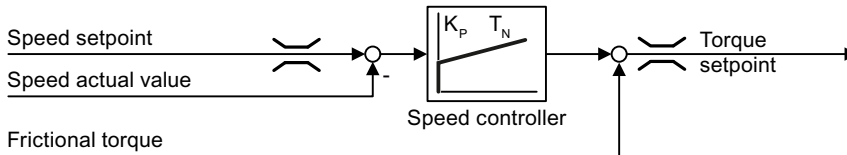

Figure 6-54 Precontrol of the speed controller with frictional torque

The inverter calculates the current frictional torque from a friction characteristic with 10 intermediate points.

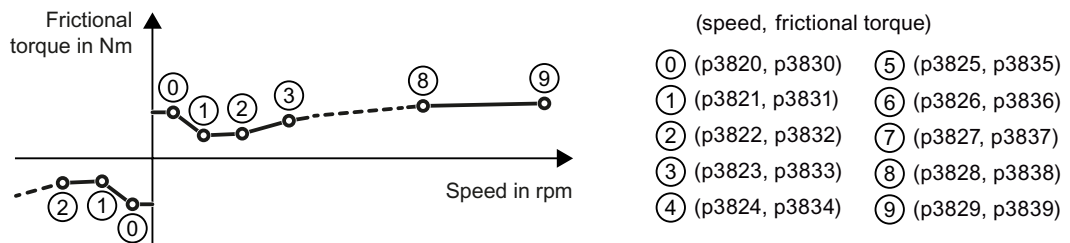

Figure 6-55 Friction characteristic

The intermediate points of the friction characteristic are defined for positive speeds. In the negative direction of rotation, the inverter uses the intermediate points with a negative sign.

Recording a friction characteristic

After quick commissioning, the inverter sets the speeds of the intermediate points to values suitable for the rated speed of the motor. The frictional torque of all intermediate points is still equal to zero. On request, the inverter records the friction characteristic: The inverter accelerates the motor step by step up to the rated speed, measures the frictional torque and writes the frictional torque into the intermediate points of the friction characteristic.

Precondition

The motor is permitted to accelerate up to the rated speed without endangering persons or property.

Procedure

1. Set P3845 = 1: The inverter accelerates the motor successively in both directions of rotation and averages the measurement results of the positive and negative directions.
2. Switch on the motor (ON/OFF1 = 1).
3. The inverter accelerates the motor.
During measurement, the inverter signals the alarm A07961.
When the inverter has determined all the intermediate points of the friction characteristic without fault code F07963, the inverter stops the motor.

You have recorded the friction characteristic.

**Adding friction characteristic for the torque setpoint**

If you enable the friction characteristic (p3842 = 1), the inverter adds the output of the friction characteristic r3841 to the torque setpoint.

Parameter

Parameter	Explanation
p3820 ... p2839	Intermediate points of the friction characteristic [rpm; Nm]
r3840	Friction characteristic status word
	.00 1 signal: Friction characteristic OK
	.01 1 signal: Determination of the friction characteristic is active
	.02 1 signal: Determination of the friction characteristic is complete
	.03 1 signal: Determination of the friction characteristic has been aborted
	.08 1 signal: Friction characteristic positive direction
r3841	Friction characteristic, output [Nm]
p3842	Activate friction characteristic 0: Friction characteristic deactivated 1: Friction characteristic activated
p3845	Activate friction characteristic plot (factory setting: 0) 0: Friction characteristic plot deactivated 1: Friction characteristic plot activated, both directions 2: Friction characteristic plot activated, positive direction 3: Friction characteristic plot activated, negative direction
p3846	Friction characteristic plot ramp-up/ramp-down time (factory setting: 10 s) Ramp-up/ramp-down time for automatic plotting of the friction characteristic.
p3847	Friction characteristic plot warm-up period (factory setting: 0 s) At the start of automatic plotting, the inverter accelerates the motor up to the speed = p3829 und keeps the speed constant for this time.

Further information on this topic is provided in the List Manual.

6.21.3.7 Moment of inertia estimator

Background

From the load moment of inertia and the speed setpoint change, the inverter calculates the accelerating torque required for the motor. Via the speed controller precontrol, the accelerating torque specifies the main percentage of the torque setpoint. The speed controller corrects inaccuracies in the precontrol (feed-forward control).

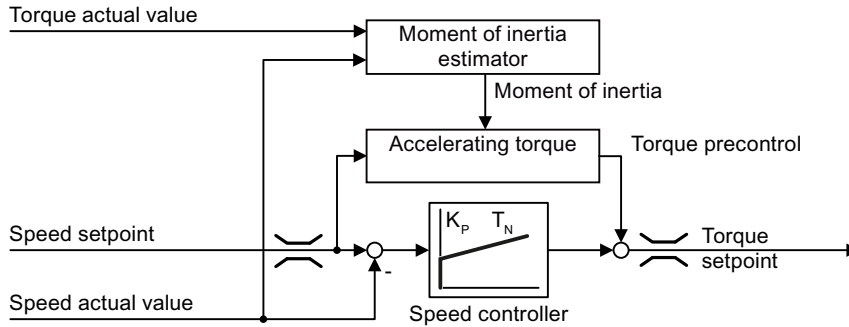

Figure 6-56 Influence of the moment of inertia estimator on the speed control

The more precise the value of the moment of inertia in the inverter, the lower the overshoot after speed changes.

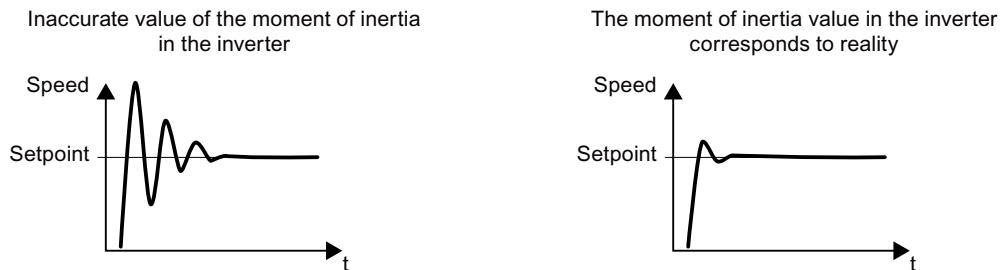

Figure 6-57 Influence of the moment of inertia on the speed

Function

From the actual speed, the actual motor torque and the frictional torque of the load, the inverter calculates the total moment of inertia of the load and motor.

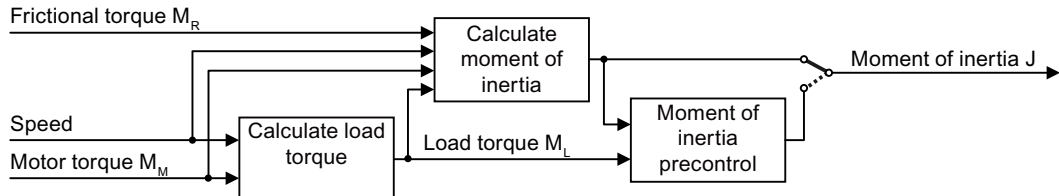



Figure 6-58 Overview of the function of the moment of inertia estimator

When using the moment of inertia estimator, we recommend that you also activate the friction characteristic.

 Friction characteristic (Page 306)

How does the inverter calculate the load torque?

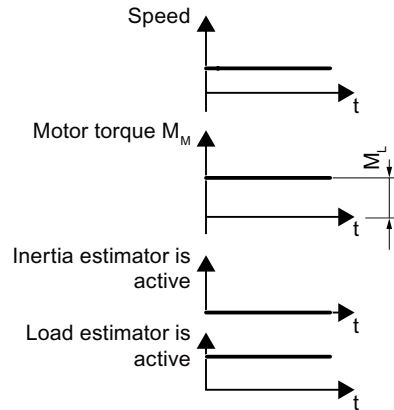

Figure 6-59 Calculating the load torque

At low speeds, the inverter calculates the load torque M_L from the actual motor torque.

The calculation takes place under the following conditions:

- Speed $\geq p1226$
- Acceleration setpoint $< 8 \text{ 1/s}^2$ (Δ speed change 480 rpm per s)
- Acceleration \times moment of inertia (r1493) $< 0.9 \times p1560$

How does the inverter calculate the moment of inertia?

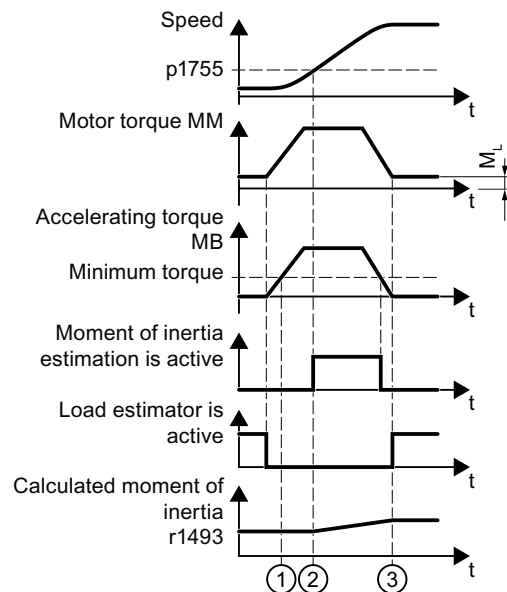

Figure 6-60 Calculating the moment of inertia

For higher speed changes, the inverter initially calculates the accelerating torque M_B as difference between the motor torque M_M , load torque M_L and frictional torque M_R :

$$M_B = M_M - M_L - M_R$$

Moment of inertia J of the motor and load is obtained from the accelerating torque M_B and angular acceleration α (α = rate at which the speed changes):

$$J = M_B / \alpha$$

If all of the following conditions are met, the inverter calculates the moment of inertia:

- ① The rated accelerating torque M_B must satisfy the following two conditions:
 - The sign of M_B is the same as the direction of the actual acceleration
 - $M_B > p1560 \times \text{rated motor torque (r0333)}$
- ② speed > p1755
- The inverter has calculated the load torque in at least one direction of rotation.
- Acceleration setpoint > 8 1/s² (Δ speed change 480 rpm per s)
- ③ The inverter calculates the load torque again after acceleration.

Moment of inertia precontrol

In applications where the motor predominantly operates with a constant speed, the inverter can only infrequently calculate the moment of inertia using the function described above. Moment of inertia precontrol is available for situations such as these. The moment of inertia precontrol assumes that there is an approximately linear relationship between the moment of inertia and the load torque.

Example: For a horizontal conveyor, in a first approximation, the moment of inertia depends on the load.

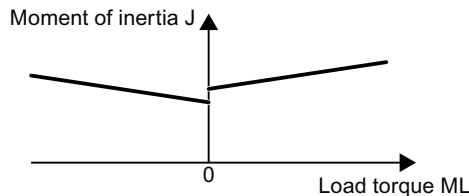

Figure 6-61 Moment of inertia precontrol

The relationship between load torque and torque is saved in the inverter as linear characteristic.

- In a positive direction of rotation:
Moment of inertia $J = p5312 \times \text{load torque } M_L + p5313$
- In a negative direction of rotation:
Moment of inertia $J = p5314 \times \text{load torque } M_L + p5315$

You have the following options to determine the characteristic:

- You already know the characteristic from other measurements. In this case, you must set the parameters to known values when commissioning the system.
- The inverter iteratively determines the characteristic by performing measurements while the motor is operational.

Activating the moment of inertia estimator

The moment of inertia estimator is deactivated in the factory setting. p1400.18 = 0, p1400.20 = 0, p1400.22 = 0.

If you performed the rotating measurement for the motor identification during quick commissioning, we recommend leaving the moment of inertia estimator deactivated.

Preconditions

- You have selected encoderless vector control.
- The load torque must be constant whilst the motor accelerates or brakes.
Typical of a constant load torque are conveyor applications and centrifuges, for example. Fan applications, for example, are not permitted.
- The speed setpoint is free from superimposed unwanted signals.
- The motor and load are connected to each other with an interference fit.
Drives with slip between the motor shaft and load are not permitted, e.g. as a result of loose or worn belts.

If the conditions are not met, you must not activate the moment of inertia estimator.

Procedure

1. Set p1400.18 = 1
2. Check: p1496 ≠ 0
3. Activate the acceleration model of the speed controller pre-control: p1400.20 = 1.

You have activated the moment of inertia estimator.

□

The most important settings

Parameter	Explanation		
r0333	Rated motor torque [Nm]		
p0341	Motor moment of inertia (factory setting: 0 kgm ²) The inverter sets the parameter when selecting a listed motor. The parameter is then write-protected.		
p0342	Moment of inertia ratio, total to motor (factory setting: 1) Ratio of moment of inertia load + motor to moment of inertia of motor without load		
p1400	Speed control configuration		
	.18	1 signal: Moment of inertia estimator active	
	.20	1 signal: Acceleration model on	
	.22	1 signal	Moment of inertia estimator retain value when motor switched off
		0 signal	Moment of inertia estimator reset value to initial value J_0 when motor switched off: $J_0 = p0341 \times p0342 + p1498$ If the load torque can change when the motor is switched off, set p1400.22 = 0.
.24	1 signal	Shortened moment of inertia estimation is active. p1400.24 = 1 reduces the duration of the moment of inertia estimation. Disadvantage: If the accelerating torque is not constant while calculating the moment of inertia, the calculation of the moment of inertia using p1400.24 = 1 is less precise.	

Parameter	Explanation
r1407	Status word, speed controller
	.24 1 signal: Moment of inertia estimator is active
	.25 1 signal: Load estimator is active
	.26 1 signal: Moment of inertia estimator is engaged
.27 1 signal: Shortened moment of inertia estimation is active.	
r1493	Total moment of inertia, scaled r1493 = p0341 × p0342 × p1496
p1496	Acceleration precontrol scaling (factory setting: 0 %) According to rotating measurement of the motor data identification is p1496 = 100%.
p1498	Load moment of inertia (factory setting: 0 kgm ²)
p1502	Freeze moment of inertia estimator (factory setting: 0) If the load torque changes when accelerating the motor, set this signal to 0.
	0 signal Moment of inertia estimator is active
	1 signal Determined moment of inertia is frozen
p1755	Motor model changeover speed encoderless operation Defines the switchover between open-loop and closed-loop controlled operation of the encoderless vector control. When selecting the closed-loop speed control, the inverter sets p1755 = 13.3% × rated speed.

Advanced settings

Parameter	Explanation
p1226	Standstill detection, speed threshold (factory setting: 20 rpm) The moment of inertia estimator only measures the load torque for speeds ≥ p1226. p1226 also defines from which speed the inverter switches-off the motor for OFF1 and OFF3.
p1560	Moment of inertia estimator accelerating torque threshold value (factory setting: 10%)
p1561	Moment of inertia estimator change time inertia (factory setting: 500 ms)
p1562	Moment of inertia estimator change time load (factory setting: 10 ms)
	The lower that p1561 or p1562 is, the shorter the moment of inertia estimator measurements. The larger p1561 or p1562 is, the more accurate the results provided by the moment of inertia estimator.
p1563	Moment of inertia estimator load torque positive direction of rotation (factory setting: 0 Nm)
p1564	Moment of inertia estimator load torque negative direction of rotation (factory setting: 0 Nm)

Parameter	Explanation		
p5310	Moment of inertia precontrol configuration (factory setting: 0000 bin)		
	.00	1 signal: Activates calculation of the characteristic (p5312 ... p5315)	
	.01	1 signal: Activates moment of inertia precontrol	
		p5310.00 = 0, p5310.01 = 0	Deactivating moment of inertia precontrol
		p5310.00 = 1, p5310.01 = 0	Adapting the moment of inertia precontrol
		p5310.00 = 0, p5310.01 = 1	Activating the moment of inertia precontrol. The characteristic of the moment of inertia precontrol remains unchanged.
r5311	Moment of inertia precontrol status word		
	.00	1 signal: New measuring points for the characteristic of the moment of inertia precontrol are available	
	.01	1 signal: New parameters are been calculated	
	.02	1 signal: Moment of inertia precontrol active	
	.03	1 signal: The characteristic in the positive direction of rotation has been calculated and is ready	
	.04	1 signal: The characteristic in the negative direction of rotation has been calculated and is ready	
	.05	1 signal: The inverter writes actual results to the parameter	
p5312	Moment of inertia precontrol linear positive (factory setting: 0 1/s ²)	In a positive direction of rotation: Moment of inertia = p5312 × load torque + p5313	
p5313	Moment of inertia precontrol constant positive (factory setting: 0 kgm ²)		
p5314	Moment of inertia precontrol linear negative (factory setting: 0 1/s ²)	In a negative direction of rotation: Moment of inertia = p5314 × load torque + p5315	
p5315	Moment of inertia precontrol constant negative (factory setting: 0 kgm ²)		

6.21.4 Torque control

Torque control is part of the vector control and normally receives its setpoint from the speed controller output. By deactivating the speed controller and directly entering the torque setpoint, the closed-loop speed control becomes closed-loop torque control. The inverter then no longer controls the motor speed, but the torque that the motor generates.

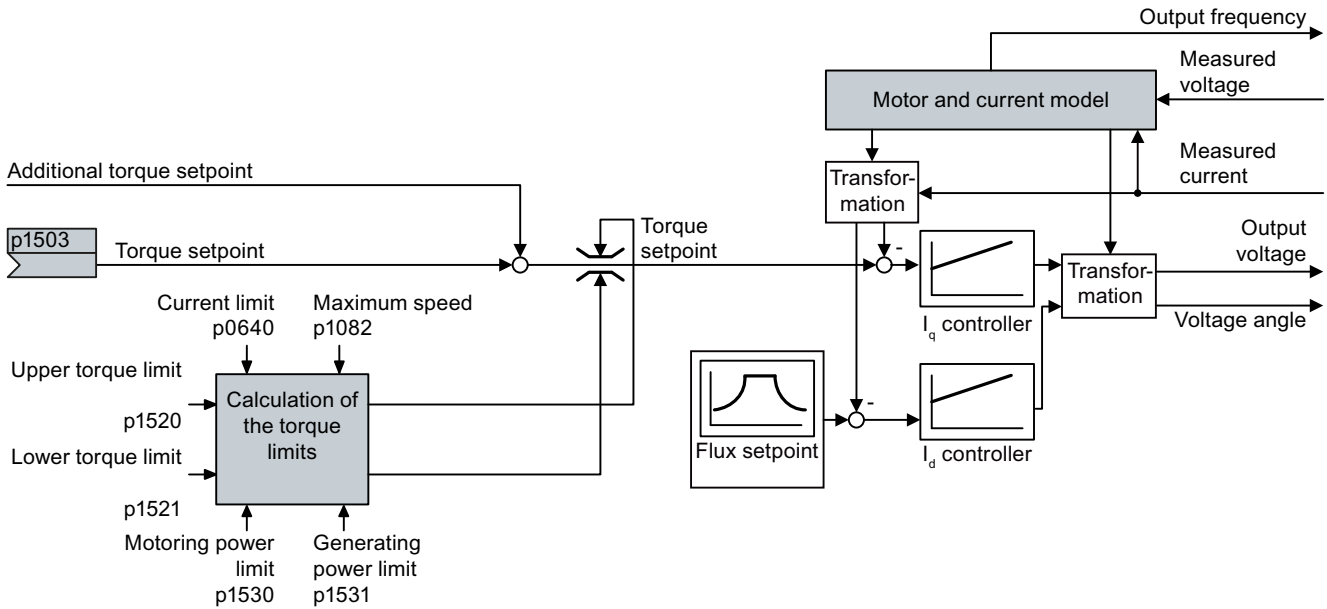

Figure 6-62 Simplified function diagram of the closed-loop torque control

Typical applications for torque control

The torque control is used in applications where the motor speed is specified by the connected driven load. Examples of such applications include:

- Load distribution between master and slave drives:
The master drive is speed controlled, the slave drive is torque controlled.
- Winding machines

The most important settings

Prerequisites for the correct functioning of the torque control:

- You have set the motor data correctly during the quick commissioning
 Quick commissioning with a PC (Page 134)
- You have performed a motor data identification on the cold motor

Parameter	Description
p1300	Control mode: 22: Torque control without speed encoder
p0300 ... p0360	Motor data is transferred from the motor type plate during quick commissioning and calculated with the motor data identification

Parameter	Description
p1511	Additional torque
p1520	Upper torque limit
p1521	Lower torque limit
p1530	Motoring power limit
p1531	Regenerative power limit

Additional information about this function is provided in the parameter list and in function diagrams 6030 onwards in the List Manual.

6.21.5 Application examples for closed-loop motor control

Additional information for setting the closed-loop motor control in certain applications is provided in the Internet:

 Engineering and commissioning series lifting equipment/cranes (<https://support.industry.siemens.com/cs/de/en/view/103156155>)

6.22 Electrically braking the motor

Braking with the motor in generating mode



If the motor brakes the connected load electrically, it will convert the kinetic energy of the motor to electrical energy. The electrical energy E released on braking the load is proportional to the moment of inertia J of the motor and load and to the square of the speed n . The motor attempts to pass the energy on to the inverter.

Main features of the braking functions

DC braking

DC braking prevents the motor from transferring braking energy to the inverter. The inverter impresses a DC current into the motor, therefore braking the motor. The motor converts braking energy E of the load into heat.

- *Advantage:* The motor brakes the load without the inverter having to process regenerative power.
- *Disadvantages:* significant increase in the motor temperature; no defined braking characteristics; no constant braking torque; no braking torque at standstill; braking energy is lost as heat; does not function when the power fails

Compound braking

One version of DC braking. The inverter brakes the motor with a defined ramp-down time and superimposes a DC current on the output current.

Dynamic braking

Using a braking resistor, the inverter converts the electrical energy into heat.

- *Advantages:* defined braking response; motor temperature does not increase any further; constant braking torque
- *Disadvantages:* Braking resistor required; braking energy E is lost in the form of heat

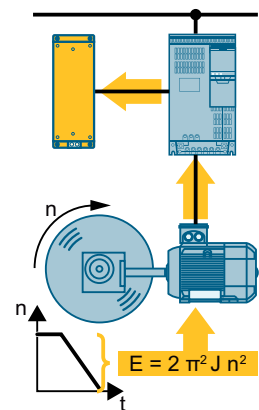
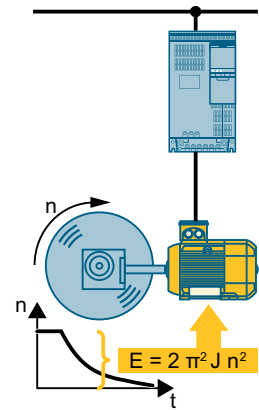

Braking with energy recovery into the line supply

The inverter feeds electrical energy back into the line supply (energy recovery).

- *Advantages:* Constant braking torque; the braking energy is not completely converted into heat, but regenerated into the line supply; is suitable for all applications; continuous regenerative operation is possible - e.g. when lowering a suspended load
- *Disadvantage:* Does not function for a power failure

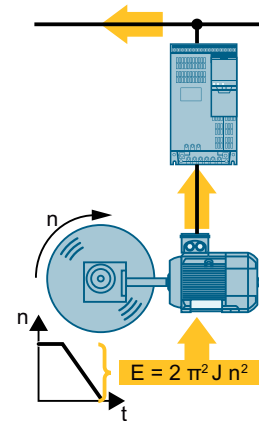

Which Power Module permits which braking method?

Electrical braking methods	Power Modules that can be used
DC braking, compound braking	PM240-2, PM240P-2
Dynamic braking	PM240-2
Braking with energy recovery into the line supply	PM250

6.22.1 DC braking

DC braking is used for applications where the motor must be actively stopped; however, neither an inverter capable of energy recovery nor a braking resistor is available.

Typical applications for DC braking include:

- Centrifuges
- Saws
- Grinding machines
- Conveyor belts

DC braking is not permissible in applications involving suspended loads, e.g. lifting equipment/ cranes and vertical conveyors.

Function

NOTICE
Motor overheating as a result of DC braking
The motor will overheat if you use DC braking too frequently or use it for too long. This may damage the motor.
<ul style="list-style-type: none">• Monitor the motor temperature.• Allow the motor to adequately cool down between braking operations.• If necessary, select another motor braking method.

With DC braking, the inverter outputs an internal OFF2 command for the time that it takes to de-energize the motor p0347 - and then impresses the braking current for the duration of the DC braking.

The DC-braking function is possible only for induction motors.

4 different events initiate DC braking

DC braking when falling below a starting speed

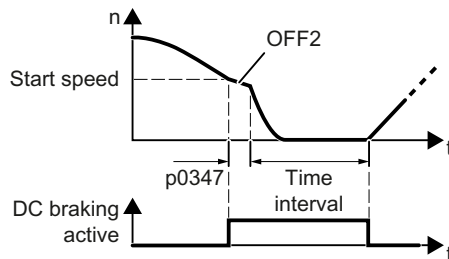

Requirement:

p1230 = 1 and p1231 = 14

Function:

1. The motor speed has exceeded the starting speed.
2. The inverter activates the DC braking as soon as the motor speed falls below the starting speed.

DC braking when a fault occurs

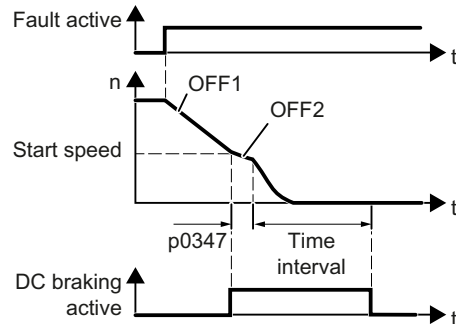

Requirement:

Fault number and fault response are assigned via p2100 and p2101.

Function:

1. A fault occurs, which initiates DC braking as response.
2. The motor brakes along the down ramp to the speed for the start of DC braking.
3. DC braking starts.

DC braking initiated by a control command

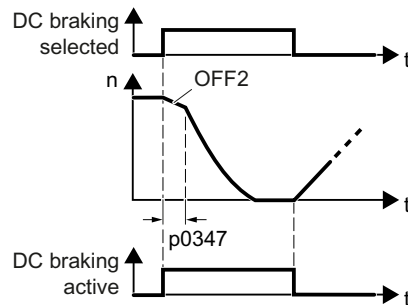

Requirement:

p1231 = 4 and p1230 = control command, e.g. p1230 = 722.3 (control command via DI 3)

Function:

1. The higher-level control issues the command for DC braking, e.g. using DI3: p1230 = 722.3.
2. DC braking starts.

If the higher-level control withdraws the command during DC braking, the inverter interrupts DC braking and the motor accelerates to its setpoint.

DC braking when the motor is switched off

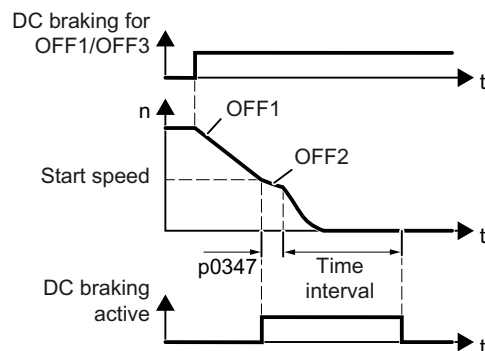

Requirement:

p1231 = 5 or p1230 = 1 and p1231 = 14

Function:

1. The higher-level control switches off the motor (OFF1 or OFF3).
2. The motor brakes along the down ramp to the speed for the start of DC braking.
3. DC braking starts.

Settings for DC braking

Parameter	Description
p0347	Motor de-excitation time (calculated after quick commissioning) The inverter can trip due to an overcurrent during DC braking if the de-excitation time is too short.
p1230	DC braking activation (factory setting: 0) Signal source to activate DC braking <ul style="list-style-type: none"> • 0 signal: Deactivated • 1 signal: Active
p1231	Configuring DC braking (factory setting: 0)
	0 No DC braking
	4 General release for DC braking
	5 DC braking for OFF1/OFF3
14 DC braking below the starting speed	
p1232	DC braking current (factory setting 0 A)
p1233	DC braking duration (factory setting 1 s)
p1234	DC braking start speed (factory setting 210000 rpm)
r1239	DC braking status word
	.08 DC braking active
	.10 DC braking ready
	.11 DC braking selected
	.12 DC braking selection internally locked
	.13 DC braking for OFF1/OFF3

Table 6-59 Configuring DC braking as a response to faults

Parameter	Description
p2100	Set fault number for fault response (factory setting 0) Enter the fault number for which DC braking should be activated, e.g. p2100[3] = 7860 (external fault 1).
p2101 = 6	Fault response setting (factory setting 0) Assigning the fault response: p2101[3] = 6.
The fault is assigned an index of p2100. Assign the same index of p2100 or p2101 to the fault and fault response.	
The inverter's List Manual lists in the "Faults and alarms" list the possible fault responses for every fault. Entry "DCBRK" means that you may set DC braking as response for this fault.	

6.22.2 Compound braking

Compound braking is suitable for applications in which the motor is normally operated at a constant speed and is only braked down to standstill in longer time intervals.

Typically, the following applications are suitable for compound braking:

- Centrifuges
- Saws
- Grinding machines
- Horizontal conveyors

Compound braking is not permissible for applications with suspended loads, e.g. lifting equipment/cranes all vertical conveyors.

Principle of operation

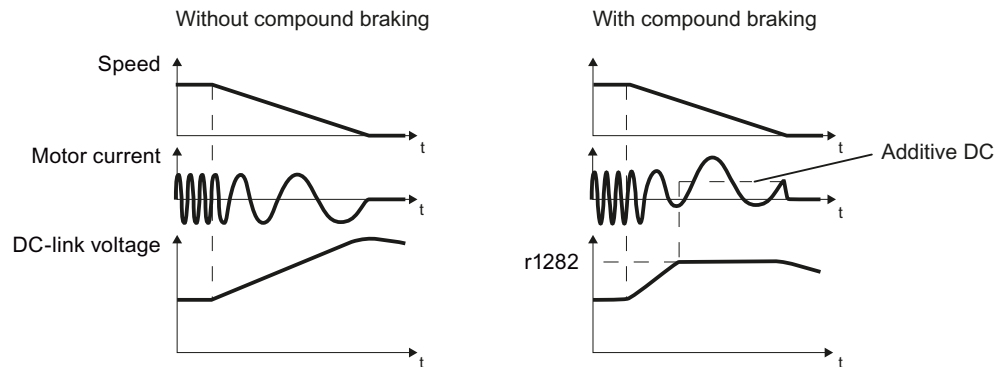

Figure 6-63 Motor brakes with and without active compound braking

Compound braking prevents the DC-link voltage increasing above a critical value. The inverter activates compound braking depending on the DC-link voltage. Above a DC-link voltage threshold (r1282), the inverter adds a DC current to the motor current. The DC current brakes the motor and prevents an excessive increase in the DC-link voltage.

Note

Compound braking is possible only with the U/f control.

Compound braking does not operate in the following cases:

- The "flying restart" function is active
- DC braking is active
- Vector control is selected

Setting and enabling compound braking

Parameter	Description
p3856	<p>Compound braking current (%)</p> <p>With the compound braking current, the magnitude of the DC current is defined, which is additionally generated when stopping the motor for operation with U/f control to increase the braking effect.</p> <p>p3856 = 0 Compound braking locked</p> <p>p3856 = 1 ... 250 Current level of the DC braking current as a % of the rated motor current (p0305)</p> <p>Recommendation: $p3856 < 100\% \times (r0209 - r0331) / p0305 / 2$</p>
r3859.0	<p>Compound-braking status word</p> <p>r3859.0 = 1: Compound braking is active</p>

NOTICE

Overheating of the motor due to compound braking

The motor will overheat if you use compound braking too frequently or for too long. This may damage the motor.

- Monitor the motor temperature.
- Allow the motor to adequately cool down between braking operations.
- If necessary, select another motor braking method.

6.22.3 Dynamic braking

Typical applications for dynamic braking require continuous braking and acceleration operations or frequent changes of the motor direction of rotation:

- Horizontal conveyors
- Vertical and inclined conveyors
- Hoisting gear

Principle of operation

The DC link voltage increases as soon as the motor supplies regenerative power to the inverter when braking. The regenerative power means that the DC link voltage in the inverter increases. Depending on the DC link voltage, the inverter outputs the regenerative power to the braking resistor through the braking chopper. The braking resistor converts the regenerative power into heat, therefore preventing DC link voltages $> V_{dc_max}$.

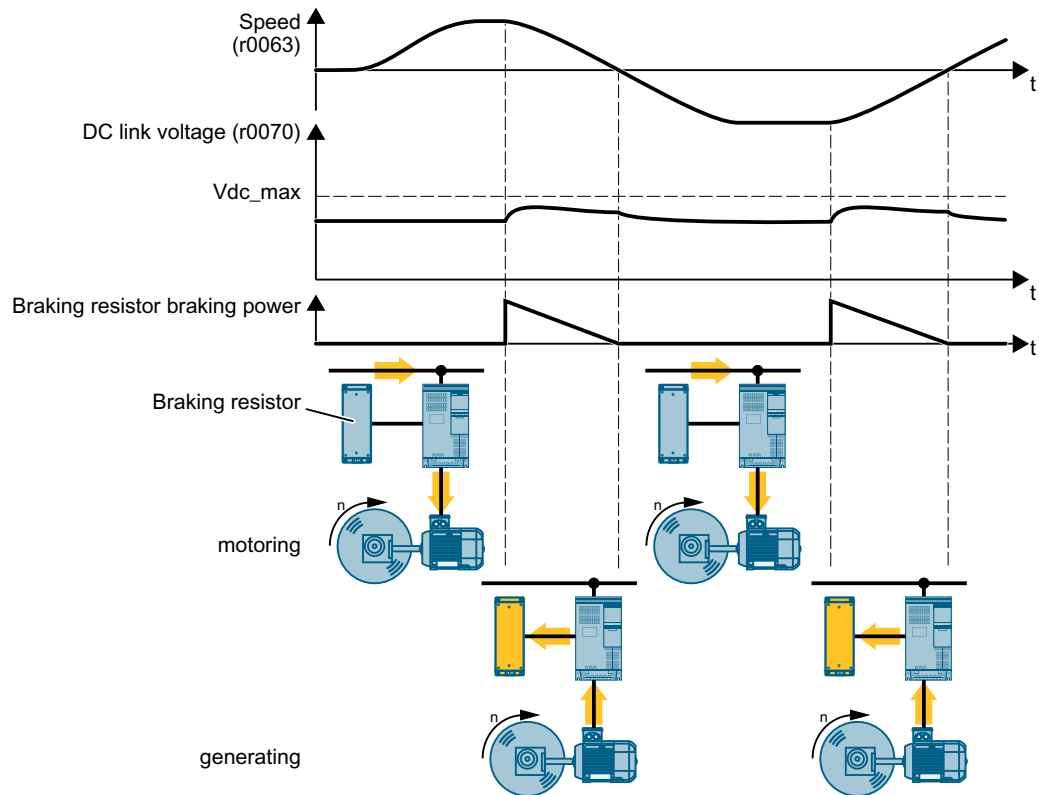





Figure 6-64 Simplified representation of dynamic braking with respect to time

Set dynamic braking

Parameter	Description
p0219	<p>Braking power of the braking resistor (factory setting: 0 kW)</p> <p>For p0219 > 0, the inverter deactivates the VDC_max controller.</p> <p>For vector control, p0219 specifies the regenerative power limit p1531.</p>  <p>Set with p0219 the maximum braking power that the braking resistor must handle. The inverter extends the ramp-down time of the motor when the braking power is too low. You can find the technical data of the braking resistor in the Power Module hardware installation manual.</p> <p> Overview of the manuals (Page 519)</p> <p>The SIZER PC tool provides support for calculating the braking power.</p> <p> Configuring support (Page 521)</p>
p2106	<p>BI: External fault 1</p> <p>p2106 = 722.x</p> <p>Monitor the signal for overtemperature of the braking resistor with digital input x of the inverter.</p> <p> Connecting the temperature contact of the braking resistor (Page 113)</p>

An example for configuring a drive with braking resistor is provided in the Internet:

 Engineering and commissioning series lifting equipment/cranes (<https://support.industry.siemens.com/cs/de/en/view/103156155>)

6.22.4 Braking with regenerative feedback to the line

The typical applications for braking with energy recovery (regenerative feedback into the line supply) are as follows:

- Hoist drives
- Centrifuges
- Unwinders

For these applications, the motor must brake for longer periods of time.

The inverter can feed back up to 100% of its rated power into the line supply (referred to "High Overload" base load).

 Technical data, PM250 Power Module (Page 471)

Setting the braking with regenerative feedback to the line

Parameter	Description
Limiting the regenerative feedback for V/f control (p1300 < 20)	
p0640	Motor series overload factor (factory setting: 0.00 A, default for quick commissioning) It is only possible to limit the regenerative power with V/f control by limiting the motor current. If the current exceeds this value for longer than 10 s, the inverter shuts down the motor with fault F07806.
Limiting feedback with vector control (p1300 ≥ 20)	
p1531	Power limit generative (factory setting: -0.01 kW) The inverter calculates the parameter based on the quick commissioning or with p0340 = 5.

6.23 Overcurrent protection



The vector control ensures that the motor current remains within the set torque limits.

If you use U/f control, you cannot set any torque limits. The U/f control prevents too high a motor current by influencing the output frequency and the motor voltage (I-max controller).

I_max controller

Requirements

The torque of the motor must decrease at lower speeds, which is the case, for example, with fans.

The load must not drive the motor continuously, e.g. when lowering hoisting gear.

Function

The I-max controller influences the output frequency and the motor voltage.

If the motor current reaches the current limit during acceleration, the I-max controller extends the acceleration operation.

If the load of the motor is so large during stationary operation that the motor current reaches the current limit, the I-max controller reduces the speed and the motor voltage until the motor current is in the permissible range again.

If the motor current reaches the current limit during deceleration, the I-max controller extends the deceleration operation.

Settings

You only have to change the factory settings of the I-max controller if the drive tends to oscillate when it reaches the current limit or if it is shut down due to overcurrent.

Table 6-60 I-max controller parameters

Parameter	Description
p0305	Rated motor current
p0640	Motor current limit
p1340	Proportional gain of the I-max controller for speed reduction
p1341	Integral time of the I-max controller for speed reduction
r0056.13	Status: I-max controller active
r1343	Speed output of the I-max controller Shows the amount to which the I-max controller reduces the speed.

For more information about this function, see function diagram 6300 in the List Manual.

6.24 Inverter protection using temperature monitoring



The inverter temperature is essentially defined by the following effects:

- The ambient temperature
- The ohmic losses increasing with the output current
- Switching losses increasing with the pulse frequency

Monitoring types

The inverter monitors its temperature using the following monitoring types:

- I²t monitoring (alarm A07805, fault F30005)
- Measuring the chip temperature of the Power Module (alarm A05006, fault F30024)
- Measuring the heat sink temperature of the Power Module (alarm A05000, fault F30004)

Inverter response to thermal overload

Parameter	Description
r0036	Power unit overload I²t [%] The I ² t monitoring calculates the inverter utilization based on a current reference value defined in the factory. <ul style="list-style-type: none"> • Actual current > reference value: r0036 becomes higher. • Actual current < reference value: r0036 becomes lower or remains = 0.
r0037	Power unit temperatures [°C]
p0290	Power unit overload response Factory setting and the ability to be changed depends on the hardware. The dependency is described in the List Manual. A thermal overload is present if the inverter temperature is greater than that specified in p0292. You define how the inverter responds if there is a risk of thermal overload using this parameter. The details are described below.
p0292	Power unit temperature warning threshold (factory setting: Heat sink [0] 5 °C, power semiconductor [1] 15 °C) The value is set as a difference to the shutdown temperature.
p0294	Power unit warning at I²t overload (factory setting: 95 %)

Overload response for p0290 = 0

The inverter responds depending on the control mode that has been set:

- In vector control, the inverter reduces the output current.
- In U/f control, the inverter reduces the speed.

Once the overload condition has been removed, the inverter re-enables the output current or speed.

If the measure cannot prevent an inverter thermal overload, then the inverter switches off the motor with fault F30024.

Overload response for p0290 = 1

The inverter immediately switches off the motor with fault F30024.

Overload response for p0290 = 2

We recommend this setting for drives with square-law torque characteristic, e.g. fans.

The inverter responds in two stages:

1. If you operate the inverter with increased pulse frequency setpoint p1800, then the inverter reduces its pulse frequency starting at p1800. In spite of the temporarily reduced pulse frequency, the base load output current remains unchanged at the value that is assigned to p1800.

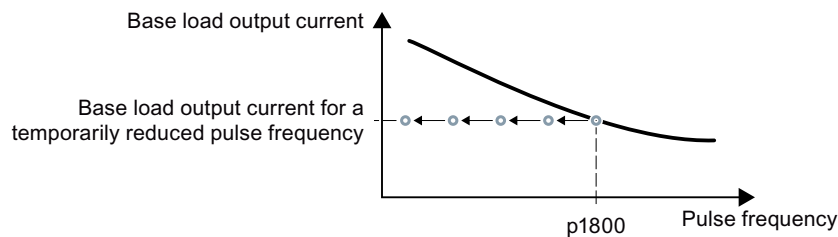

Figure 6-65 Derating characteristic and base load output current for overload

Once the overload condition has been removed, the inverter increases the pulse frequency back to the pulse frequency setpoint p1800.

2. If it is not possible to temporarily reduce the pulse frequency, or the risk of thermal overload cannot be prevented, then stage 2 follows:
 - In vector control, the inverter reduces its output current.
 - In U/f control, the inverter reduces the speed.

Once the overload condition has been removed, the inverter re-enables the output current or speed.

If both measures cannot prevent a power unit thermal overload, then the inverter switches off the motor with fault F30024.

Overload response for p0290 = 3

If you operate the inverter with increased pulse frequency, then the inverter reduces its pulse frequency starting at the pulse frequency setpoint p1800.

In spite of the temporarily reduced pulse frequency, the maximum output current remains unchanged at the value that is assigned to the pulse frequency setpoint. Also see p0290 = 2.

Once the overload condition has been removed, the inverter increases the pulse frequency back to the pulse frequency setpoint p1800.

If it is not possible to temporarily reduce the pulse frequency, or the measure cannot prevent a power unit thermal overload, then the inverter switches off the motor with fault F30024.

Overload response for p0290 = 12

The inverter responds in two stages:

1. If you operate the inverter with increased pulse frequency setpoint p1800, then the inverter reduces its pulse frequency starting at p1800.
There is no current derating as a result of the higher pulse frequency setpoint.
Once the overload condition has been removed, the inverter increases the pulse frequency back to the pulse frequency setpoint p1800.
2. If it is not possible to temporarily reduce the pulse frequency, or the risk of inverter thermal overload cannot be prevented, then stage 2 follows:
 - In vector control, the inverter reduces the output current.
 - In U/f control, the inverter reduces the speed.

Once the overload condition has been removed, the inverter re-enables the output current or speed.

If both measures cannot prevent a power unit thermal overload, then the inverter switches off the motor with fault F30024.

Overload response for p0290 = 13

We recommend this setting for drives with high starting torque, e.g. horizontal conveyors or extruders.

If you operate the inverter with increased pulse frequency, then the inverter reduces its pulse frequency starting at the pulse frequency setpoint p1800.

There is no current derating as a result of the higher pulse frequency setpoint.

Once the overload condition has been removed, the inverter increases the pulse frequency back to the pulse frequency setpoint p1800.

If it is not possible to temporarily reduce the pulse frequency, or the measure cannot prevent a power unit thermal overload, then the inverter switches off the motor with fault F30024.

6.25 Motor protection with temperature sensor



The inverter can evaluate one of the following sensors to protect the motor against overtemperature:

- | | |
|--|---|
| | • KTY84 sensor |
| | • Temperature switch (e.g. bimetallic switch) |
| | • PTC sensor |
| | • Pt1000 sensor |

KTY84 sensor

NOTICE

Overheating of the motor due to KTY sensor connected with the incorrect polarity

If a KTY sensor is connected with incorrect polarity, the motor can become damaged due to overheating, as the inverter cannot detect a motor overtemperature condition.

- Connect the KTY sensor with the correct polarity.



Using a KTY sensor, the inverter monitors the motor temperature and the sensor itself for wire-break or short-circuit:

- Temperature monitoring:
 - The inverter uses a KTY sensor to evaluate the motor temperature in the range from -48°C ... $+248^{\circ}\text{C}$.
 - Use the p0604 or p0605 parameter to set the temperature for the alarm and fault threshold.
 - Overtemperature alarm (A07910):
 - motor temperature $>$ p0604 and p0610 = 0
 - Overtemperature fault (F07011):
 - The inverter responds with a fault in the following cases:
 - motor temperature $>$ p0605
 - motor temperature $>$ p0604 and p0610 \neq 0
- Sensor monitoring (A07015 or F07016):
 - Wire-break:
 - The inverter interprets a resistance $>$ 2120 Ω as a wire-break and outputs the alarm A07015. After 100 milliseconds, the inverter changes to the fault state with F07016.
 - Short-circuit:
 - The inverter interprets a resistance $<$ 50 Ω as a short-circuit and outputs the alarm A07015. After 100 milliseconds, the inverter changes to the fault state with F07016.

Temperature switch



The inverter interprets a resistance \geq 100 Ω as being an opened temperature switch and responds according to the setting for p0610.

PTC sensor

The inverter interprets a resistance $> 1650 \Omega$ as being an overtemperature and responds according to the setting for p0610.

The inverter interprets a resistance $< 20 \Omega$ as being a short-circuit and responds with alarm A07015. If the alarm is present for longer than 100 milliseconds, the inverter shuts down with fault F07016.

Pt1000 sensor

Using a Pt1000 sensor, the inverter monitors the motor temperature and the sensor itself for wire breakage and/or short-circuit:

- Temperature monitoring:
 - Using a Pt1000 sensor, the inverter evaluates the motor temperature in the range from $-48 \text{ }^\circ\text{C}$... $+248 \text{ }^\circ\text{C}$.
 - You set the temperature for the alarm and fault thresholds using parameters p0604 and p0605.
 - Overtemperature alarm (A07910):
 - motor temperature $> p0604$ and $p0610 = 0$
 - Overtemperature fault (F07011):
 - The inverter responds with a fault in the following cases:
 - motor temperature $> p0605$
 - motor temperature $> p0604$ and $p0610 \neq 0$
- Sensor monitoring (A07015 or F07016):
 - Wire-break:
 - The inverter interprets a resistance $> 2120 \Omega$ as a wire-break and outputs the alarm A07015. After 100 milliseconds, the inverter changes to the fault state with F07016.
 - Short-circuit:
 - The inverter interprets a resistance $< 603 \Omega$ as a short-circuit and outputs the alarm A07015. After 100 milliseconds, the inverter changes to the fault state with F07016.

Setting parameters for the temperature monitoring

Parameter	Description
p0335	Motor-cooling method (factory setting: 0) 0: Natural cooling - with fan on the motor shaft 1: Forced ventilation - with a separately driven fan 2: Liquid cooling 128: No fan
p0601	Motor temperature sensor type 0: No sensor (factory setting) 1: PTC 2: KTY84 4: Temperature switch 6: Pt1000
p0604	Mot_temp_mod 2 / sensor alarm threshold (factory setting $130 \text{ }^\circ\text{C}$) For monitoring the motor temperature using KTY84/Pt1000.

Parameter	Description
p0605	Mot_temp_mod 1/2 / sensor threshold and temperature value (factory setting: 145° C) For monitoring the motor temperature using KTY84/Pt1000.
p0610	Motor overtemperature response (factory setting: 12) Determines the inverter behavior when the motor temperature reaches the alarm threshold p0604.
	0: Alarm (A07910), no fault
	1: Alarm A07910 and fault F07011 The inverter reduces the current limit.
	2, 12: Alarm A07910 and fault F07011 The inverter does not reduce the current limit.
p0640	Current limit [A]

Additional information on the motor temperature monitoring can be found in function diagram 8016 of the List Manual.

6.26 Motor protection by calculating the temperature



The inverter calculates the motor temperature based on a thermal motor model.

The thermal motor model responds far faster to temperature increases than a temperature sensor.

If you are using the thermal motor model together with a temperature sensor, e.g. a Pt1000, then the inverter corrects the model based on the measured temperature.

Thermal motor model 2 for induction motors

The thermal motor model 2 for induction motors is a thermal 3-mass model, consisting of stator core, stator winding and rotor. Thermal motor model 2 calculates the temperatures - both in the rotor as well as in the stator winding.

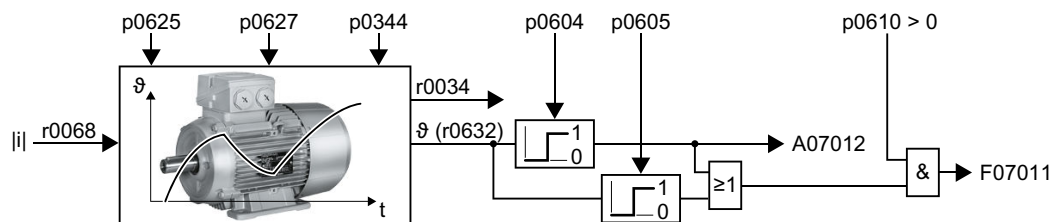

Figure 6-66 Thermal motor model 2 for induction motors

Table 6-61 Thermal motor model 2 for induction motors

Parameter	Description
r0068	CO: Absolute actual current value
p0610	Motor overtemperature response (factory setting: 12)
	0: Alarm A07012 The inverter does not reduce the current limit.
	1: Alarm A07012 and fault F07011 The inverter reduces the current limit.
	2: Alarm A07012 and fault F07011 The inverter does not reduce the current limit.
12: Alarm A07012 and fault F07011 The inverter does not reduce the current limit. After switching off the supply voltage, the inverter saves the most-recently calculated difference to the ambient air temperature. After switching the supply voltage on again, the thermal motor model starts with 90 % of the previously saved difference temperature.	

6.26 Motor protection by calculating the temperature

Parameter	Description	
p0344	Motor weight (for thermal motor type) (factory setting: 0.0 kg)	
p0604	Mot_temp_mod 2/KTY alarm threshold (factory setting: 130.0° C) Motor temperature > p0604 ⇒ fault F07011.	
p0605	Mot_temp_mod 1/2 threshold (factory setting: 145.0° C) Motor temperature > p0605 ⇒ alarm A07012.	
p0612	Mot_temp_mod activation	
	.01	1 signal: Activate motor temperature model 2 for induction motors
	.09	1 signal: Activate motor temperature model 2 expansions The inverter sets bit 09 = 1 after commissioning. If you load the parameter settings for firmware version ≤ V4.6 into the inverter, bit 09 = 0 remains.
p0627	Motor overtemperature, stator winding (factory setting: 80 K)	
p0625	Motor ambient temperature during commissioning (factory setting: 20° C) Specification of the motor ambient temperature in °C at the instant of the motor data identification.	
r0632	Mot_temp_mod stator winding temperature [°C]	
p0640	Current limit [A]	

Further information is provided in the function charts 8016 and 8017 of the List Manual.

Thermal motor model 1 for synchronous motors

Further information about thermal motor model 1 for synchronous motors is provided in the function charts 8016 and 8017 of the List Manual.

6.27 Motor and inverter protection by limiting the voltage

What causes an excessively high voltage?



To drive the load, an electric motor converts electrical energy into mechanical energy. If the motor is driven by its load, e.g. due to the load moment of inertia when braking, then the energy flow reverses: The motor temporarily operates as generator, and converts mechanical energy into electrical energy. The electrical energy flows from the motor to the inverter. If the inverter cannot output the electrical energy supplied by the motor, e.g. to a braking resistor, then the inverter stores the energy in its DC link capacitance. As a consequence, the DC link voltage V_{dc} in the inverter is higher.

An excessively high DC link voltage damages the inverter and also the motor. As a consequence, the inverter monitors its DC link voltage - and when necessary switches off the motor and outputs fault "DC link overvoltage".

Protecting the motor and inverter against overvoltage

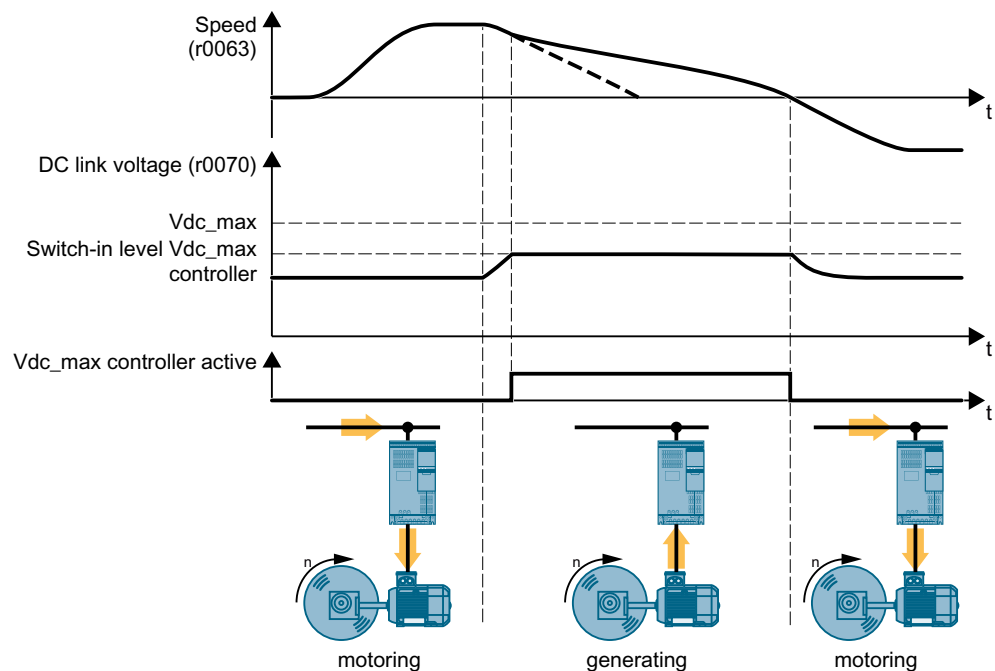

Figure 6-67 Simplified representation of the V_{dc_max} control

The V_{dc_max} control extends the motor ramp-down time when braking. The motor then only feeds so much energy into the inverter to cover the losses in the inverter. The DC link voltage remains in the permissible range.

The V_{dc_max} control is not suitable for applications where the motor is in continuous regenerative operation, e.g. as is the case for cranes and centrifuges.



Electrically braking the motor (Page 316)

The V_{dc_max} control can only be used with PM240-2 Power Modules. The V_{dc_max} control is not required if you use a braking resistor.

PM250 Power Modules feed back regenerative energy into the line supply. Therefore, the Vdc_max control is not required for a PM250 Power Module.

Parameters of the Vdc_max control

The parameters differ depending on the motor control mode.

Parameter for V/f control	Parameter for vector control	Description
p1280 = 1	p1240 = 1	Vdc controller configuration (Factory setting: 1) 1: VDC controller is enabled
r1282	r1242	Vdc_max control activation level DC link voltage value above which the Vdc_max control is activated
p1283	p1243	Vdc_max control dynamic factor (factory setting: 100 %) Scaling control parameters p1290, p1291 and p1292
p1284	---	Vdc_max controller time threshold Setting the monitoring time of the Vdc_max controller.
p1290	p1250	Vdc_max control proportional gain (factory setting: 1)
p1291	p1251	Vdc_max control integral time (factory setting p1291: 40 ms, p1251: 0 ms)
p1292	p1252	Vdc_max control rate time (factory setting p1292: 10 ms, p1252: 0 ms)
p1294	p1254	Vdc_max control automatic ON level sensing (factory setting, dependent on the Power Module) Automatically sense switch-on levels of the Vdc_max control. 0: Automatic detection disabled 1: Automatic detection enabled
p0210	p0210	Unit supply voltage If p1254 or p1294 = 0, the inverter uses this parameter to calculate the switch-in thresholds of the Vdc_max control. Set this parameter to the actual value of the input voltage.

For more information about this function, see the List Manual (function diagrams 6320 and 6220).

6.28 Monitoring the driven load



In many applications, the speed and the torque of the motor can be used to determine whether the driven load is in an impermissible operating state. The use of an appropriate monitoring function in the inverter prevents failures and damage to the machine or plant.

Examples:

- For fans or conveyor belts, an excessively low torque can mean a broken drive belt.
- For pumps, insufficient torque can indicate a leakage or dry-running.
- For extruders and mixers, an excessive torque together with low speed can indicate machine blockage.

Functions for monitoring the driven load

The inverter provides the following means to monitor the driven load via the torque of the motor:

	<p>The stall protection prevents an induction motor from stalling.</p>
	<p>The no-load monitoring evaluates the motor current. Insufficient current indicates that the motor and the load are no longer mechanically connected with each other.</p>
	<p>The blocking protection triggers for a motor current that corresponds to the set current limit coupled with motor standstill.</p>
	<p>The torque monitoring assumes that a specific torque is associated with each speed for pumps and fans. Insufficient torque indicates that the motor and the load are no longer mechanically connected. An excessive torque can indicate problems in the mechanical system of the driven load, e.g. a mechanically blocked load.</p>

Monitoring the driven load with a binary signal:

	<p>The speed monitoring evaluates a periodic binary signal. A signal failure indicates that the motor and the load are no longer mechanically connected with each other.</p>
--	--

6.28.1 Breakdown protection

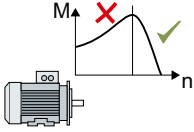

If the load of a standard induction motor exceeds the stall torque of the motor, the motor can also stall during operation on the inverter. A stalled motor is stationary and does not develop sufficient torque to accelerate the load.

If the "Motor model fault signal stall detection" r1746 for the time p2178 is present via the "Motor model error threshold stall detection" p1745, the inverter signals "Motor stalled" and fault F07902.

Parameter	Description
r1408	Current controller status word r1408.12 = 1: Motor stalled
p1745	Motor model fault threshold value stall detection (factory setting: 5%) If the motor stalls too early with this setting, then using the trace function you have the option of determining a better value. To do this, set p1745 = 100.
r1746	Motor model fault signal stall detection [%]
p2178	Motor stalled delay time (factory setting: 0.01 s)
r2198	Status word monitoring 2 r2198.07 = 1: Motor stalled

6.28.2 No-load monitoring



In applications with fans, compressors or conveyor belts, an insufficient motor current indicates that the power transmission from the motor to the load is interrupted.

If the motor current for the time p2180 lies below the current level p2179, the inverter signals "output load not available" and alarm A07929.

Parameters	Description
r0068	Actual current value [A] [0] = Unsmoothed [1] = Smoothed with p0045
p2179	Output load detection current limit (Factory setting: 0 A) p2179 = 0: No load detection deactivated
p2180	Output load detection delay time (factory setting: 2000 ms)
r2197	Status word, monitoring functions 1 r2197.11 = 1: Output load not available

6.28.3 Blocking protection



In applications with extruders or mixers, the motor can block for an excessive mechanical load. For a blocked motor, the motor current corresponds to the set current limit without the speed reaching the specified setpoint.

If the speed lies below the speed threshold p2175 for the time p2177 while the motor current reaches the current limit, the inverter signals "Motor blocked" and fault F07900.

Parameter	Description
r0063	Actual speed value [rpm] [0] = Unsmoothed [1] = Smoothed with p0045
p2175	Motor blocked speed threshold (factory setting: 120 rpm) p2175 = 0: Blocking protection deactivated
p2177	Motor blocked delay time (factory setting: 3 s)
r2198	Status word monitoring 2 r2198.06 = 1: Motor blocked

6.28.4 Torque monitoring

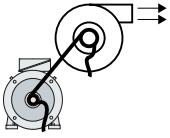

In applications with fans, pumps or compressors with the flow characteristic, the torque follows the speed according to a specific characteristic. An insufficient torque for fans indicates that the power transmission from the motor to the load is interrupted. For pumps, insufficient torque can indicate a leakage or dry-running.

The inverter monitors the torque based on the envelope curve depending on the speed against a lower and upper torque.

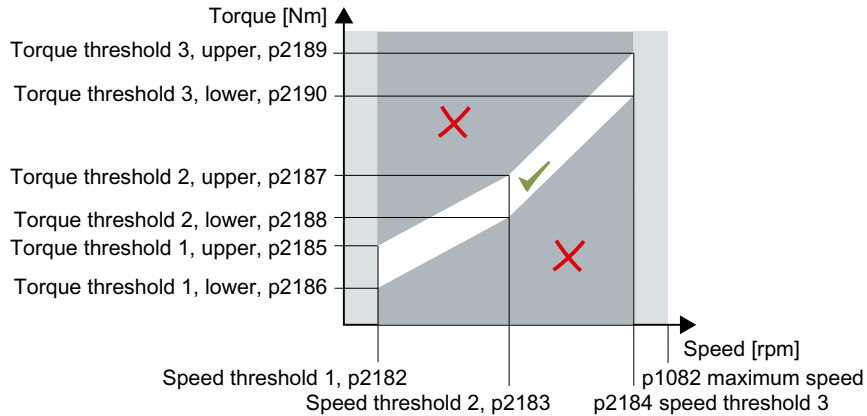

If the torque lies in the impermissible range longer than time p2192, the inverter reacts as specified in p2181.

The monitoring is not active below speed threshold 1 and above speed threshold 3.

Parameters	Description
p2181	Load monitoring response 1: A07920 for torque too low 2: A07921 for torque too high 3: A07922 for torque outside tolerance 4: F07923 for torque too low 5: F07924 for torque too high 6: F07925 for torque outside tolerance
p2182	Load monitoring speed threshold 1
p2183	Load monitoring speed threshold 2
p2184	Load monitoring speed threshold 3
p2185	Load monitoring torque threshold 1, upper
p2186	Load monitoring torque threshold 1, lower
p2187	Load monitoring torque threshold 2, upper
p2188	Load monitoring torque threshold 2, lower
p2189	Load monitoring torque threshold 3, upper
p2190	Load monitoring torque threshold 3, lower
p2192	Load monitoring delay time Delay time for the message "Leave torque monitoring tolerance band"
p2193 = 1	Load monitoring configuration (factory setting: 1) 1: Monitoring torque and load drop

6.28.5 Rotation monitoring

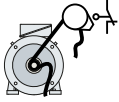

The inverter monitors the speed or velocity of a machine component via an electromechanic or electronic encoder, e.g. a proximity switch. Examples of how the function can be used:

- Gearbox monitoring for traction drives and hoisting gear
- Drive belt monitoring for fans and conveyor belts
- Blocking protection for pumps and conveyor belts

The inverter checks whether the encoder consistently supplies a 24 V signal during motor operation. If the encoder signal fails for time p2192, the inverter signals fault F07936.

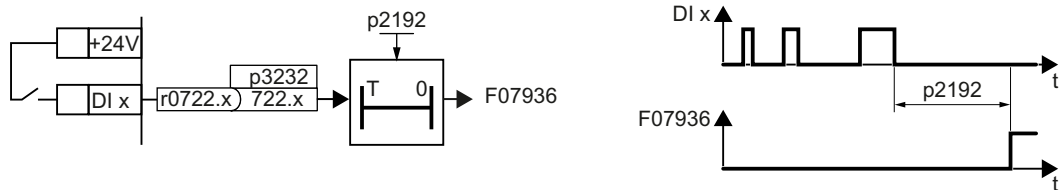
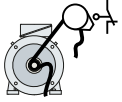

Figure 6-68 Function plan and time response of the speed monitoring

Parameter	Description
p2192	Load monitoring delay time (factory setting 10 s) After the motor is switched on, if the "LOW" signal is present at the associated digital input for longer than this time, the inverter signals a load failure (F07936).
p2193 = 3	Load monitoring configuration (factory setting: 1) 0: Monitoring switched off 1: Monitoring torque and load drop 2: Monitoring speed and load drop 3: Load failure monitoring
p3232	Load monitoring failure detection (factory setting: 1) Connect the load monitoring to a DI x digital input of your choice. p3232 = 722.x

For more information, see the List Manual (the parameter list and function diagram 8013).

6.28.6 Speed deviation monitoring



The inverter calculates and monitors the speed or velocity of a machine component.

Examples of how the function can be used:

- Gearbox monitoring for traction drives and hoisting gear
- Drive belt monitoring for fans and conveyor belts
- Blocking protection for conveyor belts

You require an electronic encoder for the "Speed monitoring" function, e.g. a proximity switch. The inverter analyzes an encoder signal at max. 32 kHz.

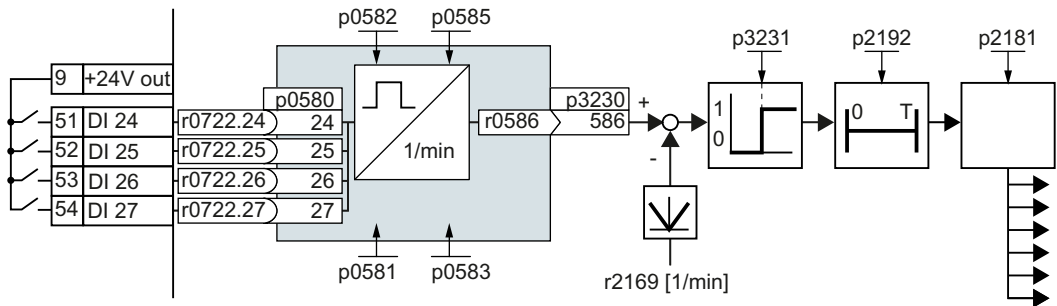

Figure 6-69 Speed deviation monitoring

Connect the encoder to one of the digital inputs DI 24 ... 27. In the inverter, you must interconnect the corresponding digital input to function block via p0580; this function block converts the input signal frequency into speed r0586.

When you use this monitoring function, you cannot use any of the digital inputs as setpoint source at the same time.

Pulse input as source of setpoint value (Page 271)

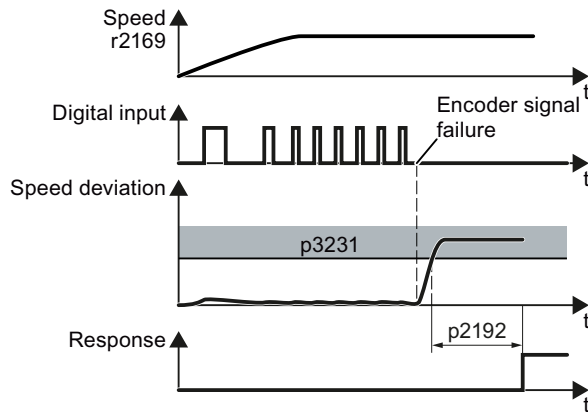

Figure 6-70 Time response of the speed monitoring

The inverter compares speed r0586 with the actual speed value r2169 and signals an excessive deviation between the encoder signal and the motor speed. p2181 specifies the inverter response for an excessive deviation.

Parameter	Description
p0490	Probe ¹⁾ invert (factory setting 0000bin) The 3rd bit of the parameter value inverts the input signal of digital input 3 for the probe.
p0580	Probe ¹⁾ Input terminal (factory setting 0) Connect input of probe with a digital input.
p0581	Probe ¹⁾ Edge (factory setting 0) Edge for analyzing the probe signal for measuring the actual speed value 0: 0/1 edge 1: 1/0 edge
p0582	Probe ¹⁾ Pulse per revolution (factory setting 1) Number of pulses per revolution
p0583	Probe ¹⁾ Maximum measurement time (factory setting 10 s) Maximum measurement time for the probe. If there is no new pulse before the maximum measuring time elapses, the inverter sets the actual speed value in r0586 to zero. The time is restarted with the next pulse.
p0585	Probe ¹⁾ Gear ratio (factory setting 1) The inverter multiplies the measured speed by the gear ratio before displaying it in r0586.
r0586	Probe ¹⁾ Actual speed value Result of the speed calculation
p2181	Load monitoring response 1: A07920 for torque too low 2: A07921 for torque too high 3: A07922 for torque outside tolerance 4: F07923 for torque too low 5: F07924 for torque too high 6: F07925 for torque outside tolerance
p2192	Load monitoring delay time (factory setting 10 s) Delay time for evaluating load monitoring.
p2193 = 2	Load monitoring configuration (factory setting: 1) 0: Monitoring switched off 1: Monitoring torque and load drop 2: Monitoring speed and load drop 3: Load failure monitoring
p3230 = 586	Load monitoring actual speed value (factory setting 0) Result of the speed calculation with the evaluation of the speed monitoring.
p3231	Load monitoring speed deviation (factory setting 150 rpm) Permissible speed deviation of load monitoring.

¹⁾ The "Probe" subfunction calculates the speed from the pulse signal of the digital input. For more information, see the List Manual (the parameter list and function diagram 8013).

6.29 Flying restart – switching on while the motor is running



If you switch on the motor while it is still rotating, without the "Flying restart" function, there is a high probability that a fault will occur as a result of overcurrent (F30001 or F07801). Examples of applications involving an unintentionally rotating motor directly before switching on:

- The motor rotates after a brief line interruption.
- A flow of air turns the fan impeller.
- A load with a high moment of inertia drives the motor.

Principle of operation

The "Flying restart" function comprises the following steps:

1. After the on command, the inverter impresses the search current in the motor and increases the output frequency.
2. When the output frequency reaches the actual motor speed, the inverter waits for the motor excitation build up time.
3. The inverter accelerates the motor to the actual speed setpoint.

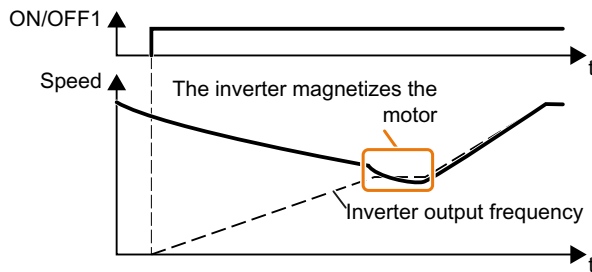

Figure 6-71 Principle of operation of the "flying restart" function

Setting "flying restart" function

Parameter	Description
p1200	Flying restart operating mode (factory setting: 0)
	0 Flying restart is disabled
	1 Flying restart is enabled, search for the motor in both directions, start in the direction of the setpoint
	4 Flying restart is enabled, search for the motor only in the direction of the setpoint

No "Flying restart" function for group drives

It is not permissible that you enable the "Flying restart" function if the inverter is simultaneously driving several motors.

Exception: a mechanical coupling ensures that all of the motors always operate with the same speed.

Table 6-62 Advanced settings

Parameter	Description
p0346	Motor excitation build up time Wait time between switching on the motor and enabling the ramp-function generator.
p0347	Motor de-excitation time Within the motor de-excitation time, after an OFF command, the inverter prevents the induction motor from being switched on again.
p1201	Flying restart enable signal source (factory setting: 1) Defines a control command, e.g. a digital input, which enables the flying restart function.
p1202	Flying restart search current (Factory setting depends on the Power Module) Defines the search current with respect to the magnetizing current (r0331), which flows in the motor during the flying restart.
p1203	Flying restart search current factor (Factory setting depends on the Power Module) The value influences the speed with which the output frequency is changed during the flying restart. A higher value results in a longer search time. If the inverter does not find the motor, reduce the search speed (increase p1203).

6.30 Automatic restart



The automatic restart includes two different functions:

- The inverter automatically acknowledges faults.
- After a fault occurs or after a power failure, the inverter automatically switches-on the motor again.

The inverter interprets the following events as power failure:

- The inverter signals fault F30003 (undervoltage in the DC link), after the inverter line voltage has been briefly interrupted.
- All of the inverter power supplies have been interrupted - and all of the energy storage devices in the inverter have discharged to such a level that the inverter electronics fail.

Setting the automatic restart function

⚠ WARNING

Unexpected machine motion caused by the active automatic restart function

When the "automatic restart" function is active ($p1210 > 1$), the motor automatically starts after a line supply phase. Unexpected movement of machine parts can result in serious injury and material damage.

- Block off hazardous areas within the machine to prevent inadvertent access.

If it is possible that the motor is still rotating for a longer period of time after a power failure or after a fault, then you must also activate the "flying restart" function.



Flying restart – switching on while the motor is running (Page 344)

Using p1210, select the automatic restart mode that best suits your application.

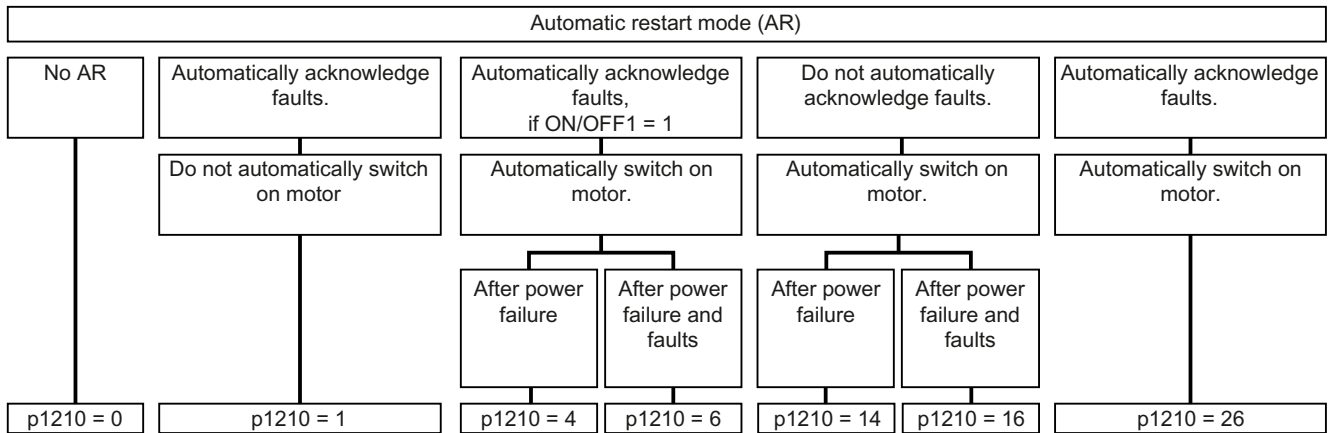
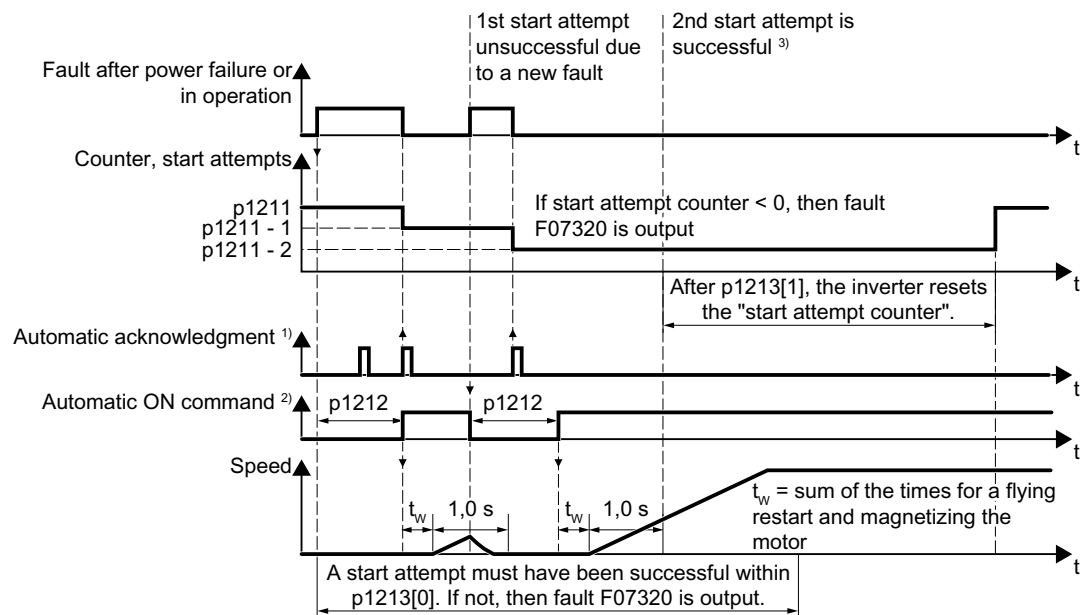

Figure 6-72 Automatic restart modes

The principle of operation of the other parameters is explained in the following diagram and in the table below.



¹⁾ The inverter automatically acknowledges faults under the following conditions:

- p1210 = 1 or 26: Always.
- p1210 = 4 or 6: If the command to switch-on the motor is available at a digital input or via the fieldbus (ON/OFF1 = 1).
- p1210 = 14 or 16: Never.

²⁾ The inverter attempts to automatically switch the motor on under the following conditions:

- p1210 = 1: Never.
- p1210 = 4, 6, 14, 16, or 26: If the command to switch-on the motor is available at a digital input or via the fieldbus (ON/OFF1 = 1).

³⁾ If, after a flying restart and magnetization (r0056.4 = 1) no fault occurs within one second, then the start attempt was successful.

Figure 6-73 Time response of the automatic restart

Parameter for setting the automatic restart

Parameter	Explanation
p1210	Automatic restart mode (factory setting: 0)
	0: Disable automatic restart.
	1: Acknowledge all faults without restarting.
	4: Restart after power failure without further restart attempts.
	6: Restart after fault with further restart attempts.
	14: Restart after power failure after manual acknowledgement.
	16: Restart after fault after manual acknowledgement.
	26: Acknowledgement of all faults and restart with ON/OFF1 = 1 command.

Parameter	Explanation
p1211	<p>Automatic restart start attempts (factory setting: 3)</p> <p>This parameter is only effective for the settings p1210 = 4, 6, 14, 16, 26.</p> <p>You define the maximum number of start attempts using p1211. After each successful acknowledgement, the inverter decrements its internal counter of start attempts by 1.</p> <p>p1211 = 0 or 1: The inverter only tries to start once. After an unsuccessful start attempt, the inverter issues fault F07320.</p> <p>p1211 = n, n > 1: The inverter tries to start n-times. The inverter outputs fault F07320 if the nth starting attempt was unsuccessful.</p> <p>The inverter sets the start attempt counter back again to the value of p1211, if one of the following conditions is fulfilled:</p> <ul style="list-style-type: none"> • After a successful start attempt, the time in p1213[1] has expired. • After fault F07320, switch off the motor (OFF1) and acknowledge the fault. • You change the start value p1211 or the mode p1210.
p1212	<p>Automatic restart wait time start attempt (factory setting: 1.0 s)</p> <p>This parameter is only effective for the settings p1210 = 4, 6, 26.</p> <p>Examples for setting this parameter:</p> <ol style="list-style-type: none"> 1. After a power failure, a certain time must elapse before the motor can be switched-on, e.g. because other machine components are not immediately ready. In this case, set p1212 longer than the time, after which all of the fault causes have been removed. 2. In operation, the inverter develops a fault condition. The lower you select p1212, then the sooner the inverter attempts to switch-on the motor again.
p1213[0]	<p>Automatic restart monitoring time for restart (factory setting: 60 s)</p> <p>This parameter is only effective for the settings p1210 = 4, 6, 14, 16, 26.</p> <p>With this monitoring function, you limit the time in which the inverter may attempt to automatically switch-on the motor again.</p> <p>The monitoring function starts when a fault is identified and ends with a successful start attempt. If the motor has not successfully started after the monitoring time has expired, fault F07320 is signaled.</p> <p>Set the monitoring time longer than the sum of the following times:</p> <ul style="list-style-type: none"> + p1212 + Time that the inverter requires to start the motor on the fly. + Motor magnetizing time (p0346) + 1 second <p>You deactivate the monitoring function with p1213 = 0.</p>
p1213[1]	<p>Automatic restart monitoring time to reset the fault counter (factory setting: 0 s)</p> <p>This parameter is only effective for the settings p1210 = 4, 6, 14, 16, 26.</p> <p>Using this monitoring time, you prevent that faults, which continually occur within a certain time period, are automatically acknowledged each time.</p> <p>The monitoring function starts with a successful start attempt and ends after the monitoring time has expired.</p> <p>If, during the monitoring time p1213[1], the inverter made more successful starting attempts than defined in p1211, the inverter interrupts the automatic restart function and signals fault F07320. To switch on the motor again you must acknowledge the fault and switch on the inverter (ON/OFFS1 = 1).</p>

Additional information is provided in the parameter list of the List Manual.

Advanced settings

If you wish to suppress the automatic restart function for certain faults, then you must enter the appropriate fault numbers in p1206[0 ... 9].

Example: p1206[0] = 07331 ⇒ No restart for fault F07331.

Suppressing the automatic restart only functions for the setting p1210 = 6, 16 or 26.

Note

Motor starts in spite of an OFF command via the fieldbus

The inverter responds with a fault if fieldbus communication is interrupted. For one of the settings p1210 = 6, 16 or 26, the inverter automatically acknowledges the fault and the motor restarts, even if the higher-level control attempts to send an OFF command to the inverter.

- In order to prevent the motor automatically starting when the fieldbus communication fails, you must enter the fault number of the communication error in parameter p1206.

Example for PROFINET:

Fault number F08501 means: Communication failure.

Set p1206[n] = 8501 (n = 0 ... 9).

6.31 Kinetic buffering (V_{DC min} control)



Kinetic buffering increases the drive availability. The kinetic buffering utilizes the kinetic energy of the load to buffer line dips and failures. During a line dip, the inverter keeps the motor in the switched-on state for as long as possible. One second is a typical, maximum buffer time.

Preconditions

The following prerequisites must be fulfilled to practically use the "kinetic buffering" function:

- The driven load has a sufficiently high inertia.
- The application allows a motor to be braked during a power failure.

The V_{DC min} control is only possible with PM240-2 Power Modules.

Function

When the line supply dips or is interrupted, the DC link voltage in the inverter decreases. At an adjustable threshold, kinetic buffering intervenes (V_{DC min} control). The V_{DC min} control forces the load to go into slightly regenerative operation. As a consequence, the inverter covers its power loss and the losses in the motor with the kinetic energy of the load. The load speed decreases; however, during kinetic buffering, the DC voltage remains constant. After the line supply returns, the inverter immediately resumes normal operation.

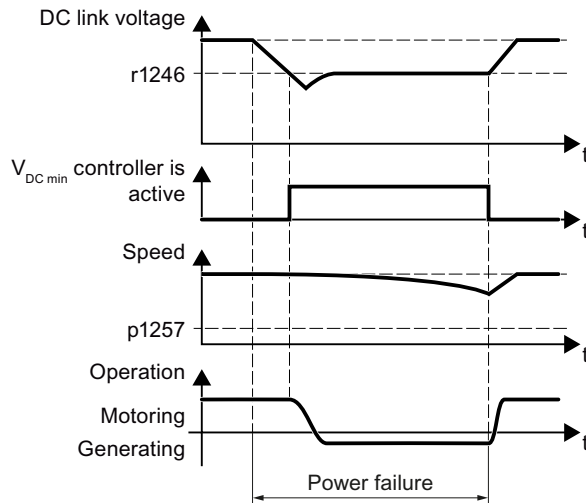

Figure 6-74 Principle mode of operation of kinetic buffering

Parameter	Description	
r0056.15	Status word closed-loop control	
	0 signal	V _{DC min} controller is not active
	1 signal	V _{DC min} controller is active (kinetic buffering)
p0210	Device supply voltage (factory setting: 400 V)	

Parameter	Description
p1240	V_{DC} controller configuration (factory setting: 1)
	0 Inhibit V _{DC} controller
	1 Enable V _{DC,max} controller
	2 Enable V _{DC,min} controller (kinetic buffering)
	3 Enable V _{DC,min} controller and V _{DC,max} controller
p1245	V_{DC,min} controller activation level (kinetic buffering) (factory setting depends on the Power Module, 73 % or 76 %)
r1246	V_{DC,min} controller activation level [V] r1246 = p1245 × √2 × p0210
p1247	V_{DC,min} controller dynamic factor (factory setting: 300 %)
p1255	V_{DC,min} controller time threshold (factory setting: 0 s) Maximum duration of the kinetic buffering. If kinetic buffering lasts longer than that specified in the parameter value, the inverter outputs fault F7406. A value of 0 deactivates the monitoring.
p1257	V_{DC,min} controller speed threshold (factory setting: 50 rpm) When fallen below, the inverter outputs fault F7405.

6.32 Efficiency optimization

Overview



The efficiency optimization reduces the motor losses as far as possible.

Active efficiency optimization has the following advantages:

- Lower energy costs
- Lower motor temperature rise
- Lower motor noise levels

Active efficiency optimization has the following disadvantage:

- Longer acceleration times and more significant speed dips during torque surges.

The disadvantage is only relevant when the motor must satisfy high requirements relating to the dynamic performance. Even when efficiency optimization is active, the inverter closed-loop motor control prevents the motor from stalling.

Precondition

Efficiency optimization functions under the following preconditions:

- Operation with an induction motor
- Vector control is set in the inverter.

Function description

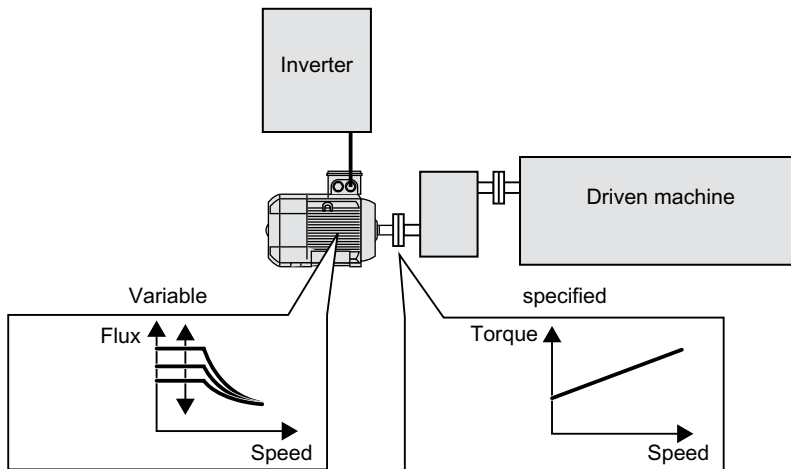

Figure 6-75 Efficiency optimization by changing the motor flux

The three variables that the inverter can directly set, which define efficiency of an induction motor, are speed, torque and flux.

However, in all applications, speed and torque are specified by the driven machine. As a consequence, the remaining variable for the efficiency optimization is the flux.

The inverter has two different methods of optimizing the efficiency.

Efficiency optimization, method 2

Generally, energy efficiency optimization method 2 achieves a better efficiency than method 1. We recommend that you set method 2.

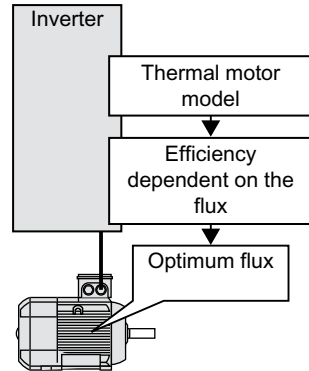
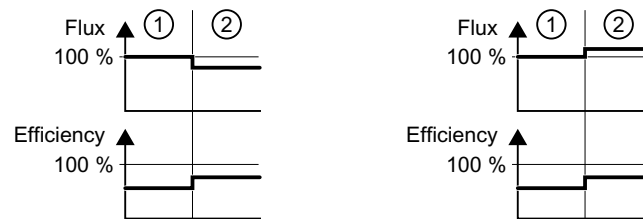

Figure 6-76 Determining the optimum flux from the motor thermal model

Based on its thermal motor model, the inverter continually determines - for the actual operating point of the motor - the interdependency between efficiency and flux. The inverter then sets the flux to achieve the optimum efficiency.



- ① Efficiency optimization is not active
- ② Efficiency optimization is active

Figure 6-77 Qualitative result of efficiency optimization, method 2

Depending on the motor operating point, the inverter either decreases or increases the flux in partial load operation of the motor.

Efficiency optimization, method 1

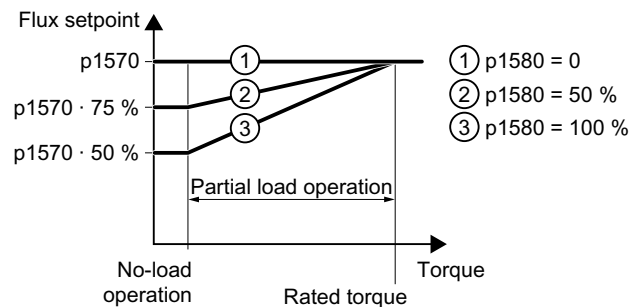

Figure 6-78 Reduce the flux setpoint in the partial load range of the motor

6.32 Efficiency optimization

The motor operates in partial load mode between no-load operation and the rated motor torque. Depending on p1580, in the partial load range, the inverter reduces the flux setpoint linearly with the torque.

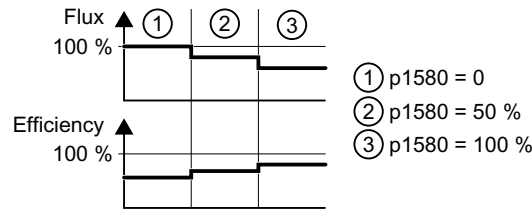

Figure 6-79 Qualitative result of efficiency optimization, method 1

The reduced flux in the motor partial load range results in higher efficiency.

Parameter

The inverter calculates the parameters for the thermal motor model based on the motor data that has been set – and the motor data identification.

Table 6-63 Efficiency optimization, method 2

Parameter	Description	Setting
p1401.14	Flux control configuration	1 signal: Efficiency optimization 2 active Factory setting: 0
p1570	Flux setpoint [%]	Factory setting: 100 %
p3315	Efficiency optimization 2 flux minimum limit value [%]	Minimum limit value for the calculated optimal flux Factory setting: 50 %
p3316	Efficiency optimization 2 maximum flux limit value [%]	Maximum limit value for the calculated optimal flux Factory setting: 110 %

Table 6-64 Efficiency optimization, method 1

Parameter	Description	Setting
p1570	Flux setpoint [%]	Factory setting: 100 %
p1580	Efficiency optimization [%]	0 %: Efficiency optimization is deactivated. 100 %: In no-load operation, the inverter reduces the flux setpoint to 50% of the rated motor flux. The factory setting depends on the inverter.

6.33 Line contactor control



A line contactor disconnects the inverter from the line supply, and therefore reduces the inverter losses when the motor is not operational.

The inverter can control its own line contactor using a digital output. You must supply the inverter with 24 V so that the line contactor control of the inverter also functions when disconnected from the line supply.

Activate line contactor control

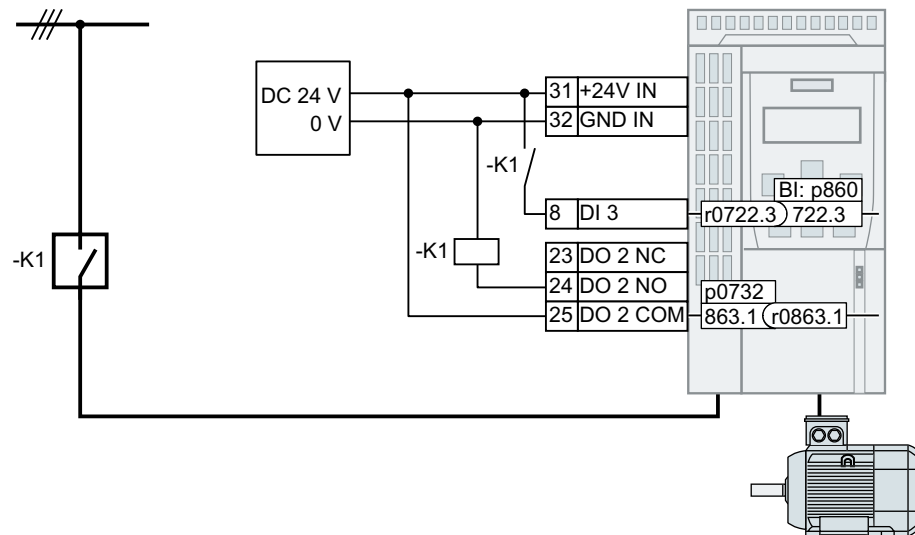

Figure 6-80 Line contactor control via DO 2 with feedback signal via DI 3

In order that the inverter controls line contactor K1 using one of its own digital outputs, you must interconnect the digital output with signal r0863.1 e.g. for DO 2: p0732 = 863.1.

Line contactor control with feedback signal

Interconnect p0860 with the signal of the corresponding digital input.

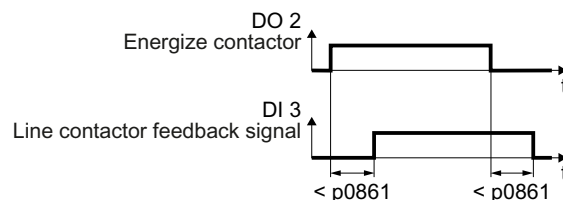

Figure 6-81 Line contactor control via DO 2 with feedback signal via DI 3

If the line contactor feedback signal is not available for longer than the time set in p0861, then the inverter signals fault F07300.

Setting the line contactor control

Parameter	Explanation
p0860	Line contactor feedback signal <ul style="list-style-type: none"> • p0860 = 863.1: no feedback signal (factory setting) • p0860 = 722.x Feedback signal of an NO contact via DIx • p0860 = 723.x: Feedback signal of an NC contact via DIx
p0861	Line contactor monitoring time (Factory setting: 100 ms) The inverter signals fault F07300 if, for an activated feedback signal, no feedback signal is received via the selected digital input after the time set here has expired.
r0863.1	Drive coupling status/control word Signal to activate the line contactor control
p0867	Line contactor holding time after OFF1 (factory setting: 50 ms) Time for which the line contactor must remain closed after an OFF1.
p0869	Sequence control configuration <ul style="list-style-type: none"> • p0689 = 0: line contactor immediately opens when the "Safe Torque Off" function becomes active (STO) • p0689 = 1: Line contactor opens when STO is active after the time in p0867 expires
p0870	Close main contactor (factory setting: 0) 1 signal: The line contactor also remains closed for an OFF command, or if the inverter has a fault condition.

6.34 Calculating the energy saving for fluid flow machines



Fluid flow machines, which mechanically control the flow rate using valves or throttle flaps, operate with a constant speed corresponding to the line frequency.



Figure 6-82 Flow control with pump and throttle connected to a 50 Hz line supply

The lower the flow rate, the poorer the efficiency of the fluid flow machine (pump). The fluid flow machine (pump) has the poorest efficiency when the throttle or valve is completely closed. Further, undesirable effects can occur, for example the formation of vapor bubbles in liquids (cavitation) or the temperature of the medium being pumped can increase.

The inverter controls the flow rate by appropriately varying the speed of the fluid flow machine. As a consequence, the fluid flow machine has the optimum efficiency for each flow rate, and draws less electric power in the partial load range than for closed-loop control concepts based on valves and throttle flaps.

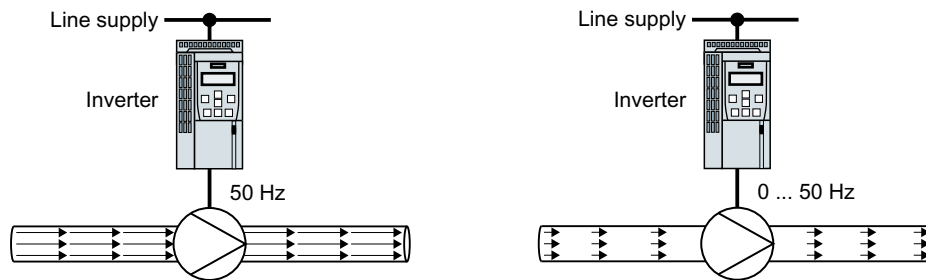
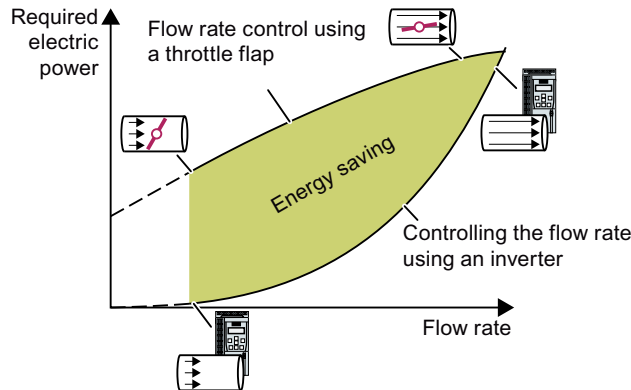

Figure 6-83 Flow control with pump and inverter

Function



The inverter calculates the energy saving from the flow characteristic associated with a mechanical flow control and the measured electric power that is drawn.

The calculation is suitable for centrifugal pumps, fans, radial and axial compressors, for instance.

Parameter	Description
r0039	Energy display [kWh]
	[0] Energy balance Energy usage since the last reset
	[1] Energy drawn since the last reset
	[2] Energy fed back since the last reset
p0040	Reset energy consumption display A signal change 0 → 1 sets r0039[0...2] = 0, r0041 = 0 and r0042 = 0.
r0041	Energy consumption saved (kWh) Energy saved referred to 100 operating hours. For less than 100 operating hours, the inverter interpolates the energy saving to 100 operating hours.
r0042	CO: Process energy display [1 ± 1 Wh] For display as process variable. Enable with p0043.
	[0] Energy balance Energy consumption since the last reset.
	[1] Energy drawn since the last reset
	[2] Energy fed back since the last reset.
p0043	BI: Enable energy usage display 1 signal: Process energy display is active in r0042.
p3320 ... p3329	<p>Flow characteristic</p> <p>(Speed, power)</p> <ul style="list-style-type: none"> ① (p3320, p3321) ② (p3322, p3323) ③ (p3324, p3325) ④ (p3326, p3327) ⑤ (p3328, p3329) <p>Factory setting of the flow characteristic</p> <p>To set the characteristic, you require the following data from the machine manufacturer for each speed interpolation point:</p> <ul style="list-style-type: none"> • The flow rate of the fluid-flow machine associated with the 5 selected inverter speeds • The power drawn at constant speed associated with the five flow rates corresponds to the line frequency and mechanical throttling of the flow rate.

6.35 Switchover between different settings

There are applications that require different inverter settings.

Example:

You connect different motors to one inverter. Depending on the particular motor, the inverter must operate with the associated motor data and the appropriate ramp-function generator.

Drive data sets (DDS)

You can set several inverter functions differently and then switch over between the different settings.

The associated parameters are indexed (index 0, 1, 2, or 3). Using control commands select one of the four indexes and therefore one of the four saved settings.

The settings in the inverter with the same index are called the drive data set.

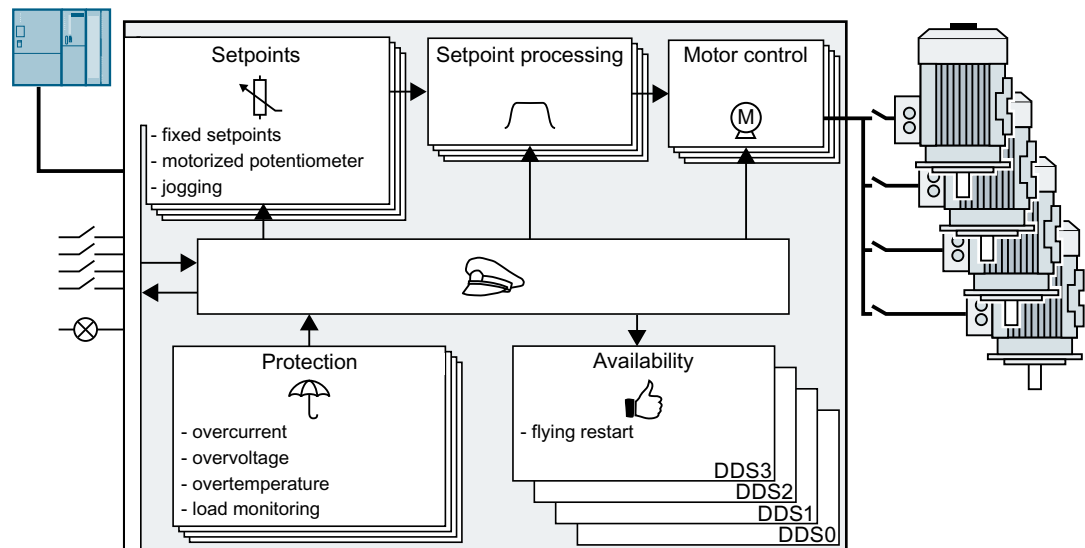

Figure 6-84 Switching over between different settings using drive data sets (DDS)

Using parameter p0180 you can define the number of drive data sets (1 ... 4).

Table 6-65 Selecting the number of **drive data sets**

Parameter	Description
p0010 = 15	Drive commissioning: Data sets
p0180	Drive data sets (DDS) number (factory setting: 1)
p0010 = 0	Drive commissioning: Ready

6.35 Switchover between different settings

Table 6-66 Parameters for switching the drive data sets:

Parameter	Description
p0820[0...n]	Drive data set selection DDS bit 0
p0821[0...n]	Drive data set selection DDS bit 1
	<p>If you use several command data sets CDS, then you must set this parameter for each CDS. The parameters are assigned to a CDS through their index:</p> <p>CDS0: p0820[0], p0821[0] CDS1: p0820[1], p0821[1] ...</p>
p0826	<p>Motor changeover, motor number</p> <p>Each drive data set is assigned a motor number: p0826[0] = motor number for drive data set 0. ... p0826[3] = motor number for drive data set 3.</p> <p>If you operate the same motor with different drive data sets, then you must enter the same motor number in every index of parameter p0826. In this particular case, you can also switch over between the different drive data sets in operation.</p> <p>If you operate different motors on one inverter, then you must number the motors in parameter p0826. In this case, you may only switch over the drive data sets in the "ready for operation" state with the motor switched-off. The switchover time is approx. 50 ms.</p>
r0051	Displaying the number of the DDS that is currently effective

For an overview of all the parameters that belong to the drive data sets and can be switched, see the List Manual.

Table 6-67 Parameters for copying the drive data sets

Parameter	Description
p0819[0]	Source drive data set
p0819[1]	Target drive data set
p0819[2] = 1	Start copy operation

For more information, see the List Manual (the parameter list and function diagram 8565).

Saving the settings and series commissioning

Saving settings outside the inverter

After commissioning, your settings are saved in the inverter so that they are protected against power failure.

We recommend that you additionally back up the settings on a storage medium outside the inverter. Without backup, your settings could be lost if the inverter develops a defect.

 Replacing the Control Unit without data backup (Page 421)

The following storage media are available for your settings:

- Memory card
- PG/PC
- Operator panel

Note

Data backup using Operator Panels with USB connection with the PG/PC is not possible

If the inverter is connected with a PG/PC via a USB cable, you cannot backup data to a memory card via an operator panel.

- Disconnect the USB connection between the PG/PC and inverter before you backup data to the memory card via an operator panel.
-

Carrying out series commissioning

Series commissioning is the commissioning of several identical drives.

Precondition

The Control Unit to which the settings are transferred has the same article number and the same or a higher firmware version as the source Control Unit.

Overview of the procedure

1. Commission the first inverter.
2. Back up the settings of the first inverter to an external storage medium.
3. Transfer the settings from the first inverter to an additional inverter via the data storage medium.

7.1 Saving settings on a memory card

7.1.1 Memory cards

Recommended memory cards



Table 7-1 Memory cards to back up inverter settings

Scope of delivery	Article number
Memory card without firmware	6SL3054-4AG00-2AA0
Memory card with firmware V4.7	6SL3054-7EH00-2BA0
Memory card with firmware V4.7 SP3	6SL3054-7TB00-2BA0
Memory card with firmware V4.7 SP6	6SL3054-7TD00-2BA0
Memory card with firmware V4.7 SP9	6SL3054-7TE00-2BA0
Memory card with firmware V4.7 SP10	6SL3054-7TF00-2BA0

Licenses

If you use the "Basic positioner" function or the expanded safety functions, then you must insert a memory card with a valid license in the Control Unit.

There are two ways of ordering a license:

- Without a memory card:
You order a license and you then transfer it to precisely one memory card.
- With memory card:
You order the license on a memory card with or without firmware. The license cannot be transferred

The inverter also uses the inserted license card as memory card to back up its settings.

Table 7-2 License for basic positioners

Scope of delivery	Article number
License without memory card	6SL3074-7AA04-0AA0
License with memory card without firmware	6SL3054-4AG00-2AA0-Z E01
License with memory card with firmware V4.7	6SL3054-7EH00-2BA0-Z E01
License with memory card with firmware V4.7 SP3	6SL3054-7TB00-2BA0-Z E01
License with memory card with firmware V4.7 SP6	6SL3054-7TD00-2BA0-Z E01
License with memory card with firmware V4.7 SP9	6SL3054-7TE00-2BA0-Z E01
License with memory card with firmware V4.7 SP10	6SL3054-7TF00-2BA0-Z E01

Table 7-3 License for the extended safety functions

Scope of delivery	Article number
License without memory card	6SL3074-0AA10-0AA0
License with memory card without firmware	6SL3054-4AG00-2AA0-Z F01
License with memory card with firmware V4.7	6SL3054-7EH00-2BA0-Z F01
License with memory card with firmware V4.7 SP3	6SL3054-7TB00-2BA0-Z F01
License with memory card with firmware V4.7 SP6	6SL3054-7TD00-2BA0-Z F01
License with memory card with firmware V4.7 SP9	6SL3054-7TE00-2BA0-Z F01
License with memory card with firmware V4.7 SP10	6SL3054-7TF00-2BA0-Z F01

Table 7-4 Basic positioner license + license for the extended safety functions

Scope of delivery	Article number
License without memory card	6SL3074-0AA10-0AA0
License with memory card without firmware	6SL3054-4AG00-2AA0-Z E01 + F01
License with memory card with firmware V4.7	6SL3054-7EH00-2BA0-Z E01 + F01
License with memory card with firmware V4.7 SP3	6SL3054-7TB00-2BA0-Z E01 + F01
License with memory card with firmware V4.7 SP6	6SL3054-7TD00-2BA0-Z E01 + F01
License with memory card with firmware V4.7 SP9	6SL3054-7TE00-2BA0-Z E01 + F01
License with memory card with firmware V4.7 SP10	6SL3054-7TF00-2BA0-Z E01 + F01

Using memory cards from other manufacturers

The inverter only supports memory cards up to 2 GB. SDHC cards (SD High Capacity) and SDXC cards (SD Extended Capacity) are not permitted.

If you use other SD or MMC memory cards, then you must format the memory card as follows:

- MMC: Format FAT 16
 - Insert the card into your PC's card reader.
 - Command to format the card:
format x: /fs:fat (x: Drive code of the memory card on your PC)
- SD: Format FAT 16 or FAT 32
 - Insert the card into your PC's card reader.
 - Command to format the card:
format x: /fs:fat or format x: /fs:fat32 (x: Drive code of the memory card on your PC.)

Functional restrictions with memory cards from other manufacturers

The following functions are either not possible – or only with some restrictions – when using memory cards from other manufacturers:

- Licensing functions is only possible using the recommended memory cards.
- Know-how protection is only possible with one of the recommended memory cards.
- Under certain circumstances, memory cards from other manufacturers do not support writing or reading data from/to the inverter.

7.1.2 Saving setting on memory card

We recommend that you insert the memory card before switching on the inverter. The inverter always also backs up its settings on an inserted card.

If you wish to back up the inverter settings on a memory card, you have two options:

Automatically backing up

Preconditions

- The inverter power supply has been switched off.
- No USB cable is inserted in the inverter.

Procedure



1. Insert an empty memory card into the inverter.
2. Switch on the power supply for the inverter.

After the power supply has been switched on, the inverter copies its changed settings to the memory card.

□

Note

Accidental damage to the inverter firmware

If the memory card contains inverter firmware, the inverter may perform an operating system update the next time the supply voltage is switched on. If you switch off the supply voltage during the operating system update, the inverter firmware may be incompletely loaded and damaged. The inverter cannot be operated with corrupt firmware.

- Before inserting the memory card, ascertain whether it also contains inverter firmware.
- Do not switch off inverter power supply during an operating system update.



Firmware upgrade and downgrade (Page 429)

Note

Accidental overwrite of the inverter settings

When the supply voltage is switched on, the inverter automatically accepts the settings already backed up on the memory card. If you use a memory card on which settings are already backed up, you will overwrite the settings of the inverter.

- To automatically backup your settings, use only a memory card that does not contain any other settings.

Manually backing up

Preconditions

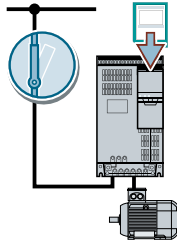

- The inverter power supply has been switched on.
- No memory card is inserted in the inverter.

Procedure with Startdrive

1. Go online.
2. Select "Online & diagnostics".
3. Select "Backing up/reset".
4. Back up the settings to the EEPROM of the inverter.
5. Select the settings as shown in the diagram.
6. Start data transfer
7. Wait until Startdrive reports that data backup has been completed.

You have backed up the inverter settings to a memory card.



Procedure with the BOP-2

1. Remove any USB cable that is inserted in the inverter.
2. In the "OPTIONS" menu, select "TO CARD".

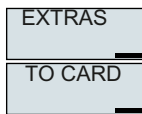

PARAM SET
1

3. Set the number of your data backup. You can back up 99 different settings on the memory card.

ESC / OK

4. Start data transfer with OK.

SAVING
PARAS

5. Wait until the inverter has backed up the settings to the memory card.

CLONING
XXX-YYY

TO CARD
-dOnE-

You have backed up the settings of the inverter to the memory card.



7.1.3 Transferring the setting from the memory card

Automatically transferring

Precondition

The inverter power supply has been switched off.

Procedure



1. Insert the memory card into the inverter.
2. Then switch on the inverter power supply.

If there is valid parameter data on the memory card, then the inverter accepts the data from the memory card.

□

Manually transferring

Preconditions

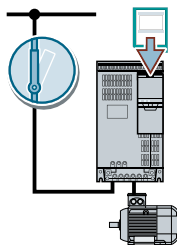

- The inverter power supply has been switched on.
- No memory card is inserted in the inverter.

Procedure with Startdrive

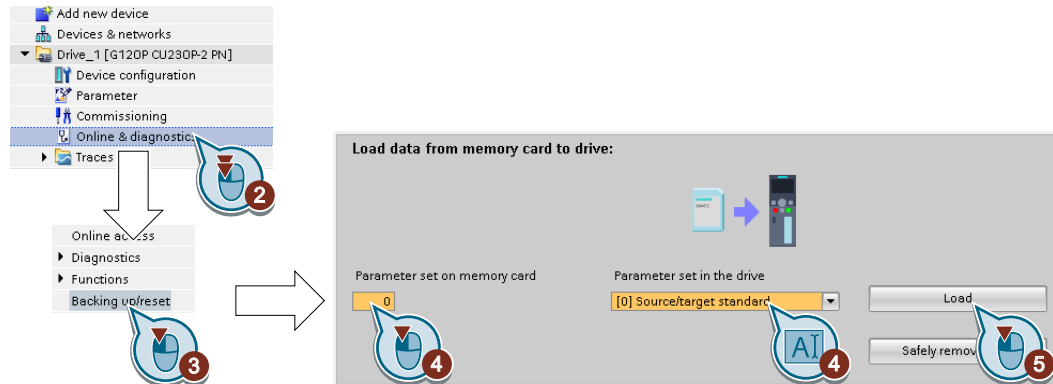

1. Go online.
2. Select "Online & diagnostics".
3. Select "Backing up/reset".
4. Select the settings as shown in the diagram.
5. Start data transfer
6. Wait until Startdrive has signaled that the data transfer has been completed.
7. Go offline.
8. Switch off the inverter power supply.
9. Wait until all LEDs on the inverter are dark.
10. Switch on the inverter power supply again.
Your settings become effective after switching on.

You have transferred your settings from a memory card to the inverter.

Procedure with the BOP-2

1. Remove any USB cable that is inserted in the inverter.

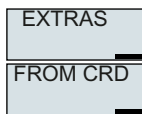

2. In the "OPTIONS" menu, select "FROM CRD".

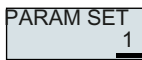

3. Set the number of your data backup. You can back up 99 different settings on the memory card.

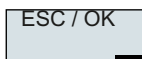

4. Start data transfer with OK.

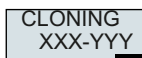

5. Wait until the inverter has transferred the settings from the memory card.

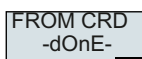

6. Switch off the inverter power supply.

7.1 Saving settings on a memory card

- 7. Wait until all inverter LEDs are dark.
- 8. Switch on the inverter power supply again.

You have transferred the settings from the memory card to the inverter.



7.1.4 Safely remove the memory card

NOTICE

Data loss from improper handling of the memory card

If you remove the memory card when the converter is switched on without implementing the "safe removal" function you may destroy the file system on the memory card. The data on the memory card are lost. The memory card will only function again after formatting.

- Only remove the memory card using the "safe removal" function.

Procedure with Startdrive

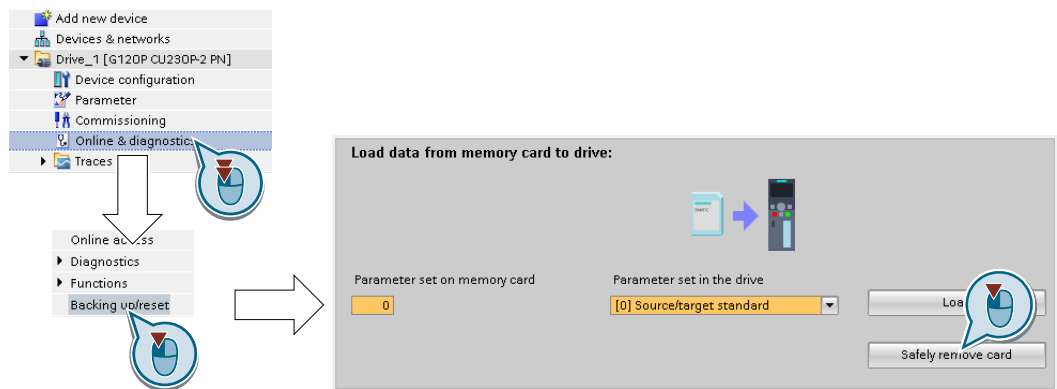

1. In the Drive Navigator select the following screen form:
2. Click on the button to safely remove the memory card.
Startdrive will tell you whether you can remove the memory card from the inverter.

You have now safely removed the memory card from the inverter.



Procedure with the BOP-2

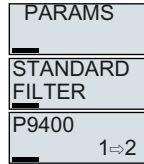

1. Set p9400 = 2.
If a memory card is inserted, p9400 = 1.

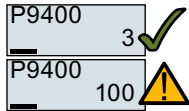

2. The inverter sets p9400 = 3 or p9400 = 100.
 - p9400 = 3: You may remove the memory card from the inverter.
 - p9400 = 100: It is not permissible that you remove the memory card. Wait for several seconds and then set p9400 = 2 again.

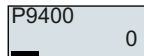

3. Remove the memory card. After removing the memory card, p9400 = 0.

You have now safely removed the memory card using BOP-2.



7.1.5 Activate message for a memory card that is not inserted

Function

The inverter identifies that a memory card is not inserted, and signals this state. The message is deactivated in the inverter factory setting.

Activate message

Procedure

1. Set p2118[x] = 1101, x = 0, 1, ... 19
2. Set p2119[x] = 2

Message A01101 for a memory card that is not inserted is activated.

To cyclically signal to a higher-level control that a memory card is not inserted, interconnect parameter r9401 to the send data of a PROFIdrive telegram of your choice.

Deactivate message

Procedure

1. Set p2118[x] = 1101, x = 0, 1, ... 19
2. Set p2119[x] = 3

Message A01101 for a memory card that is not inserted is deactivated.

Parameter

Parameter	Explanation	
p2118[0 ... 19]	Change message type message number (factory setting: 0)	
p2119[0 ... 19]	Change message type (factory setting: 0) 1: Fault 2: Alarm 3: No message	
r9401	Safely remove memory card status	
	.00	1 signal: Memory card inserted
	.01	1 signal: Memory card activated
	.02	1 signal: SIEMENS memory card
	.03	1 signal: Memory card used as USB data storage medium from the PC

7.2 Saving settings on a PC

You can transfer the inverter settings to a PG/PC, or vice versa, the data from a PG/PC to the inverter.

Requirements

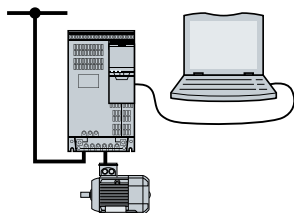

- The inverter power supply has been switched on.
- The Startdrive commissioning tool is installed on the PG/PC.
 Tools to commission the inverter (Page 126)
- PC and inverter are connected with one another via a USB cable or the fieldbus.

Inverter → PC/PG

Procedure with Startdrive

1. Go online.
2. Select "Online" > "Upload device to PG/PC."
3. Back up the project with "Project" > "Save."
4. Wait until Startdrive reports that data backup has been completed.
5. Go offline.

You have backed up the settings with Startdrive.



PC/PG → inverter

The procedure depends on whether you also transfer settings of safety functions or not.

Procedure with Startdrive without enabled safety functions

1. Go online.
2. Select "Load to device" > "Hardware and software" from the shortcut menu.
3. Wait until Startdrive reports that loading has been completed.
4. Go offline.
5. Confirm the dialog box that then opens by clicking "Yes" to save the data to the non-volatile memory of the inverter (Copy from RAM to ROM).

You have transferred the settings from the PG to the inverter with Startdrive.



Procedure with Startdrive when the safety functions are enabled

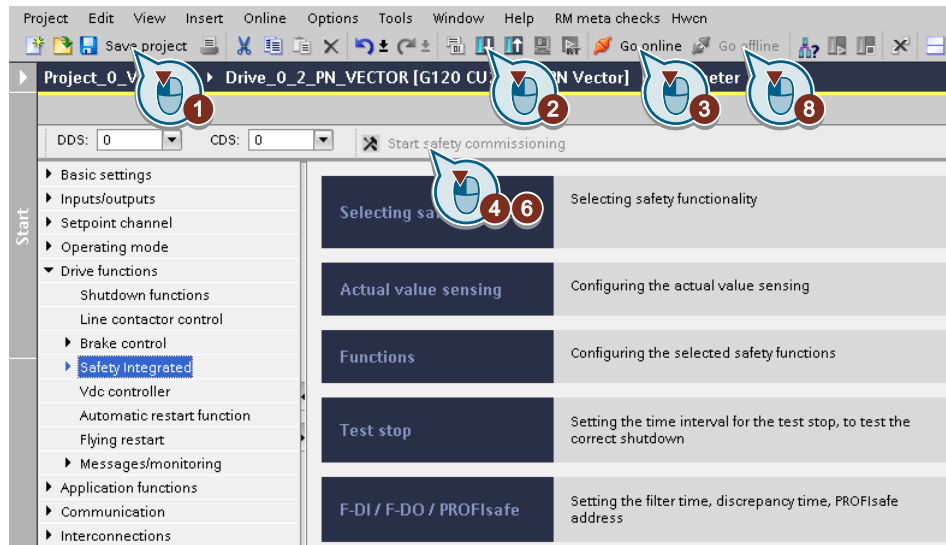

1. Save the project.
2. Select "Load to device".
3. Connect Startdrive online with the drive.
4. Press the "Start safety commissioning" button.
5. Enter the password for the safety functions.
If the password is the factory default, you are prompted to change the password.
If you try to set a password that is not permissible, the old password will not be changed.
6. Press the "End safety commissioning" button.
7. Confirm the prompt for saving your settings (copy RAM to ROM).
8. Disconnect the online connection.
9. Switch off the inverter power supply.
10. Wait until all LEDs on the inverter go dark (no voltage condition).
11. Switch on the inverter power supply again.

You have transferred the settings from the PG to the inverter with Startdrive and have activated the safety functions.

□

7.3 Saving settings to an operator panel

You can transfer the inverter settings to the Operator Panel BOP-2 or vice versa, the data from the BOP-2 to the inverter.

Precondition

The inverter power supply has been switched on.

Inverter → BOP-2

Procedure

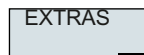

1. In the "OPTIONS" menu, select "TO BOP".

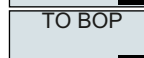
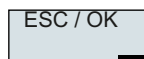

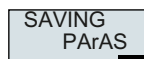

2. Start data transfer with OK.



3. Wait until the inverter has backed up the settings to the BOP-2.

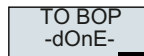



You have backed up the settings to the BOP-2.



BOP-2 → inverter

Procedure

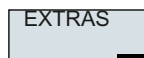

1. In the "OPTIONS" menu, select "FROM BOP".

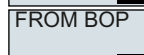
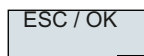
2. Start data transfer with OK.



3. Wait until the inverter has written the settings to the memory card.

4. Switch off the inverter power supply.

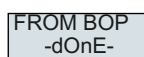
7.3 Saving settings to an operator panel

5. Wait until all inverter LEDs are dark.

6. Switch on the inverter power supply again. Your settings become effective after switching on.

You have transferred the settings to the inverter.



7.4 Other ways to back up settings

In addition to the default setting, the inverter has an internal memory for backing up three other settings.

On the memory card, you can back up 99 other settings in addition to the default setting.

 Additional information is available on the Internet: Memory options (<http://support.automation.siemens.com/WW/view/en/43512514>).

7.5 Write protection

The write protection prevents unauthorized changing of the inverter settings. If you are working with a PC tool, such as STARTER, then write protection is only effective online. The offline project is not write-protected.

Write protection is applicable for all user interfaces:

- Operator Panel BOP-2 and IOP-2
- STARTER or Startdrive PC tool
- Parameter changes via fieldbus

No password is required for write protection.

Activate and deactivate write protection

Procedure with STARTER

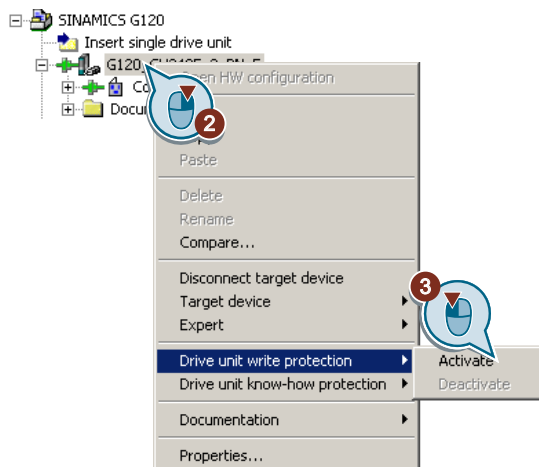

1. Go online.
2. Open the shortcut menu of the required inverter.
3. Activate or deactivate write protection.
4. Press the "Copy RAM to ROM" button to retentively save the settings .

You have activated or deactivated write protection.

□

Active write protection can be identified as in the expert list the input fields of adjustable parameters p ... are shaded gray.

Parameter		
r7760	Write protection/know-how protection status	
	.00	1 signal: Write protection active
p7761	Write protection (factory setting: 0)	
	0:	Deactivate write protection
	1:	Activate write protection

Exceptions to write protection

Some functions are excluded from write protection, e.g.:

- Activating/deactivating write protection
- Changing the access level (p0003)
- Saving parameters (p0971)
- Safely removing the memory card (p9400)
- Restoring the factory setting
- Transfer the settings from an external data backup, e.g. upload into the inverter from a memory card.

The parameters that are not write protected are in the List Manual in Section "Parameters for write protection and know-how protection".

Note

Write protection for multimaster fieldbus systems

Via multimaster fieldbus systems, e.g. BACnet or Modbus RTU, in spite of write protection being activated, parameters can still be changed. So that write protection is also active when accessing via these fieldbuses, you must additionally set p7762 to 1.

In STARTER and Startdrive, this setting is only possible using the expert list.

7.6 Know-how protection



Overview

Know-how protection prevents unauthorized reading of the inverter settings.

To protect your inverter settings against unauthorized copying, in addition to know-how protection, you can also activate copy protection.

Precondition

Know-how protection requires a password.

Combination of know-how protection and copy protection	Is a memory card necessary?
Know-how protection without copy protection	The inverter can be operated with or without memory card.
Know-how protection with basic copy protection	 <p>The inverter can only be operated with a SIEMENS memory card</p>  Memory cards (Page 362)
Know-how protection with extended copy protection	

Function description

The active know-how protection provides the following:

- With just a few exceptions, the values of all adjustable parameters p ... are invisible. In STARTER, instead of the parameter values, the text "Know-how protection" is displayed.
 - Several adjustable parameters can be read and changed when know-how protection is active. You can find a list of the adjustable parameters that can be read and changed in the List Manual under "KHP_WRITE_NO_LOCK".
In addition, you can define an exception list of adjustable parameters, which end users may change.
 - Several adjustable parameters can be read but not changed when know-how protection is active. You can find a list of the adjustable parameters that can be read in the List Manual under "KHP_ACTIVE_READ".

You can hide know-how protected parameters in the expert list of STARTER using the "Without know-how protection" display filter.

- The values of monitoring parameters r ... remain visible.
- STARTER does not display any screen forms.
- Adjustable parameters cannot be changed using commissioning tools, e.g. an operator panel or Startdrive.

- Locked functions:
 - Downloading inverter settings using STARTER or Startdrive
 - Automatic controller optimization
 - Stationary or rotating measurement of the motor data identification
 - Deleting the alarm history and the fault history
 - Generating acceptance documents for safety functions
- Executable functions:
 - Restoring factory settings
 - Acknowledging faults
 - Displaying faults, alarms, fault history, and alarm history
 - Reading out the diagnostic buffer
 - Controlling the inverter via the control panel in STARTER or Startdrive
 - Uploading adjustable parameters that can be changed or read when know-how protection is active.
 - Displaying acceptance documents for safety functions
 - Depending on the know-how protection settings, the trace function in STARTER can also be active when know-how protection is active.

When know-how protection is active, support can only be provided (from Technical Support) after prior agreement from the machine manufacturer (OEM).

Know-how protection without copy protection

You can transfer inverter settings to other inverters using a memory card, an operator panel, STARTER or Startdrive.



Know-how protection with basic copy protection

After replacing an inverter, to be able to operate the new inverter with the settings of the replaced inverter without knowing the password, the memory card must be inserted in the new inverter.

Know-how protection with extended copy protection

It is not possible to insert and use the memory card in another inverter without knowing the password.

Commissioning know-how protection

1. Check as to whether you must extend the exception list.
 -  List of exceptions (Page 382)
2. Activate the know-how protection.
 -  Know-how protection (Page 383)

7.6.1 Extending the exception list for know-how protection

In the factory setting, the exception list only includes the password for know-how protection.

Before activating know-how protection, you can additionally enter the adjustable parameters in the exception list, which must still be able to be read and changed by end users – even if know-how protection has been activated.

You do not need to change the exception list, if, with exception of the password, you do not require additional adjustable parameters in the exception list.



Absolute know-how protection

If you remove password p7766 from the exception list, it is no longer possible to enter or change the password for know-how protection.

You must reset the inverter to the factory settings in order to be able to gain access to the inverter adjustable parameters. When restoring the factory settings, you lose what you have configured in the inverter, and you must recommission the inverter.

Extending the exception list

Procedure with STARTER

1. Backup the inverter settings using the  button on the PC.
2. Go offline ()
3. Using p7763, in the expert list, define the required number of parameters n (n = 1 ... 500) of the exception list.
4. Save the project.
5. Go online.
6. Load the project using the  button in the inverter.
7. In p7764[0 ... n-1], assign the required parameter numbers to the indices of p7763.

You have extended the exception list for know-how protection.

Parameter

Parameter	Description
p7763	KHP OEM exception list number of indices for p7764 (factory setting 1)
p7764	KHP OEM exception list (factory setting [0] 7766, [1 ...499] 0) p7766 is the password for know-how protection

7.6.2 Activating and deactivating know-how protection

Activating know-how protection

Preconditions

- The inverter has now been commissioned.
- You have generated the exception list for know-how protection.
- To guarantee know-how protection, you must ensure that the project does not remain at the end user as a file.

Procedure with STARTER

1. Go online with STARTER.
If you have generated a project offline on your computer, you must load the project into the inverter and go online.
2. Select the required inverter in the project.
3. In the shortcut menu, select "Know-how protection drive unit/activating".

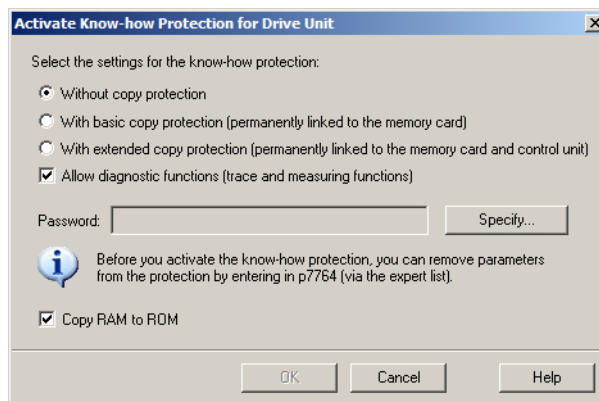

4. The "Without copy protection" option is active by default. If an appropriate memory card is inserted in the Control Unit, you can select one of two copy protection options:
 - With basic copy protection (permanently linked to the memory card)
 - With extended copy protection (permanently linked to the memory card and Control Unit)
 Select the required copy protection option.
5. If, in spite of active know-how protection, you wish to permit diagnostic functions, activate option "Allow diagnostic functions (trace and measuring functions)".
6. Click on "Define"

7.6 Know-how protection

7. Enter your password. Length of the password: 1 ... 30 characters.
Recommendation for assigning a password:
 - Only use characters from the ASCII set of characters.
If you use arbitrary characters for the password, changing the windows language settings after activating know-how protection can result in problems when subsequently checking a password.
 - For an adequately secure password, the password must have a minimum length of 8 characters, and must include uppercase and lowercase letters as well as a combination of letters, numbers and special characters.
8. The "Copy RAM to ROM" option is active as standard.
The option must be active in order that the inverter keeps the know-how protection settings after switching off and switching on the power supply.
9. Click on "OK".

You have activated know-how protection.



Preventing data reconstruction from the memory card

As soon as know-how protection has been activated, the inverter only backs up encrypted data to the memory card.

In order to guarantee know-how protection, after activating know-how protection, we recommend that you insert a new, empty memory card. For memory cards that have already been written to, previously backed up data that was not encrypted can be reconstructed.

Changing the password

Procedure with STARTER

Select the inverter in the project and open the dialog screen form using the shortcut menu "Know-how protection drive unit → Change password ...".

Deactivating know-how protection, deleting a password

Procedure with STARTER

1. Go online with STARTER.
2. Select the required inverter in the project.

- Using the right-hand mouse key, open the dialog window "Know-how protection drive unit → Deactivate...".

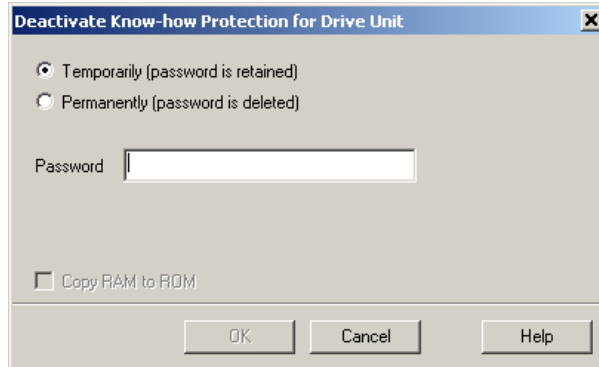

- Select the required option:
 - Temporary status: Know-how protection is again active after switching off the power supply and switching on again.
 - Final status: Also select "Copy RAM to ROM". The inverter deletes the password. However, after switching off and switching on the power supply, the password remains deleted.
- Enter the password for know-how protection.
- Exit the screen form with OK.

You have deactivated know-how protection.



Parameter

Parameter	Description	
r7758[0...19]	KHP Control Unit serial number	
p7759[0...19]	KHP Control Unit reference serial number	
r7760	Write protection/know-how protection status	
	.01	1 signal: Know-how protection active
	.02	1 signal: Know-how protection temporarily unlocked
	.03	1 signal: Know-how protection cannot be deactivated
	.04	1 signal: Extended copy protection active
	.05	1 signal: Basic copy protection active
.06	1 signal: Trace and measurement functions for diagnostic purposes active	
p7765	KHP configuration	
p7766[0...29]	KHP password input	
p7767[0...29]	KHP password new	
p7768[0...29]	KHP password confirmation	
p7769[0...20]	KHP memory card reference serial number	
r7843[0...20]	Memory card serial number	





Alarms, faults and system messages

The inverter has the following diagnostic types:

- LED
The LEDs at the front of the inverter immediately inform you about the most important inverter states.
- System runtime
The system run time is the total time that the inverter has been supplied with power since the initial commissioning.
- Alarms and faults
Every alarm and every fault has a unique number.
The inverter signals alarms and faults via the following interfaces:
 - Fieldbus
 - Terminal strip with the appropriate setting
 - Interface to the BOP-2 or IOP-2 operator panel
 - Interface to STARTER or Startdrive
- Identification & maintenance data (I&M)
If requested, the inverter sends data to the higher-level control via PROFIBUS or PROFINET:
 - Inverter-specific data
 - Plant-specific data

8.1 Operating states indicated on LEDs

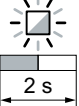
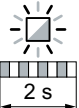
Table 8-1 Explanation of symbols for the following tables

	LED is ON
	LED is OFF
	LED flashes slowly
	LED flashes quickly
	LED flashes with variable frequency

Please contact Technical Support for LED states that are not described in the following.

Table 8-2 Basic states









RDY	Explanation
	Temporary state after the supply voltage is switched on.
	The inverter is operating fault-free
	Commissioning or reset to factory settings
	A fault is active
	Licensing is not sufficient.  Activating licensed functions (Page 492)
	Firmware update is active
	Inverter waits until the power supply is switched off and switched on again after a firmware update

Table 8-3 Integrated safety functions



SAFE	Explanation
	One or more safety functions are enabled, but not active.
	One or more safety functions are active and error-free.
	The inverter has detected a safety function fault and initiated a stop response.

Table 8-4 PROFINET and PROFIBUS fieldbuses















BF	Explanation
	Data exchange between the inverter and control system is active
<input type="checkbox"/>	Fieldbus interface is not being used
	The fieldbus is improperly configured.
	RDY In conjunction with a synchronously flashing LED RDY: Inverter waits until the power supply is switched off and switched on again after a firmware update
	No communication with higher-level controller
	RDY In conjunction with an asynchronously flashing LED RDY: Incorrect memory card
	Firmware update failed
	Firmware update is active

Table 8-5 PROFINET fieldbus

LNK	Explanation
	Communication via PROFINET is error-free
	Device naming is active
<input type="checkbox"/>	No communication via PROFINET

8.1 Operating states indicated on LEDs

Table 8-6 Fieldbuses via RS 485 interface

BF	Explanation
	Data exchange between the inverter and control system is active
	The fieldbus is active, however, the inverter is not receiving any process data RDY When LED RDY flashes simultaneously: Inverter waits until the power supply is switched off and switched on again after a firmware update
	No fieldbus connection is available RDY When LED RDY flashes simultaneously: Incorrect memory card
	Firmware update failed
	Firmware update is active

Communication via Modbus or USS:

If the fieldbus monitoring is deactivated with p2040 = 0, the BF-LED remains dark, independent of the communication state.

Description of the LED symbols for CANopen











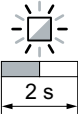
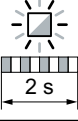
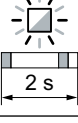
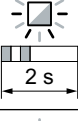

	LED is bright
	LED flashes slowly
	LED flashes quickly
	LED flashes in the "single flash" mode
	LED flashes in the "double flash" mode
	LED flashes with variable frequency

Table 8-7 CANopen fieldbus

BF	Explanation
	Data exchange between the inverter and control system is active ("Operational" state)
	Fieldbus is in the "Pre-operational" state
	Fieldbus is in the "Stopped" state
	No fieldbus available
	RDY When LED RDY flashes simultaneously: Firmware update failed
	Alarm - limit reached
	Error event in the higher-level control system (Error Control Event)
	Inverter waits until the power supply is switched off and switched on again after a firmware update
	Incorrect memory card or unsuccessful firmware update
	Firmware update is active

8.2 System runtime

By evaluating the system runtime of the inverter, you can decide whether you must replace components subject to wear such as fans, motors and gear units.

Principle of operation

The inverter starts the system runtime as soon as the inverter is supplied with power. The system runtime stops when the inverter is switched off.

The system runtime comprises r2114[0] (milliseconds) and r2114[1] (days):

System runtime = r2114[1] × days + r2114[0] × milliseconds

If r2114[0] has reached a value of 86,400,000 ms (24 hours), the inverter sets r2114[0] the value 0 and increases the value of r2114[1] by 1.

Using system runtime, you can track the chronological sequence of faults and alarms over time. When a corresponding message is triggered, the inverter transfers the parameter values r2114 to the corresponding parameters of the alarm or fault buffer.

Parameter	Description
r2114[0]	System runtime (ms)
r2114[1]	System runtime (days)

You cannot reset the system runtime.

8.3 Identification & maintenance data (I&M)

I&M data

The inverter supports the following identification and maintenance (I&M) data.

I&M data	Format	Explanation	Associated parameters	Example for the content
I&M0	u8[64] PROFIBUS u8[54] PROFINET	Inverter-specific data, read only	-	See below
I&M1	Visible String [32]	Plant/system identifier	p8806[0 ... 31]	"ak12- ne.bo2=fu1"
	Visible String [22]	Location code	p8806[32 ... 53]	"sc2+or45"
I&M2	Visible String [16]	Date	p8807[0 ... 15]	"2013-01-21 16:15"
I&M3	Visible String [54]	Any comment	p8808[0 ... 53]	-
I&M4	Octet String[54]	Check signature to track changes for Safety Integrated. This value can be changed by the user. The test signature is reset to the value generated by the machine is p8805 = 0 is used.	p8809[0 ... 53]	Values of r9781[0] and r9782[0]

When requested, the inverter transfers its I&M data to a higher-level control or to a PC/PG with installed STEP 7 or TIA Portal.

I&M0

Designation	Format	Example for the content	Valid for PRO-FINET	Valid for PRO-FIBUS
Manufacturer-specific	u8[10]	00 ... 00 hex	---	✓
MANUFACTURER_ID	u16	42d hex (=Siemens)	✓	✓
ORDER_ID	Visible String [20]	„6SL3246-0BA22-1FA0“	✓	✓
SERIAL_NUMBER	Visible String [16]	„T-R32015957“	✓	✓
HARDWARE_REVISION	u16	0001 hex	✓	✓
SOFTWARE_REVISION	char, u8[3]	„V“ 04.70.19	✓	✓
REVISION_COUNTER	u16	0000 hex	✓	✓
PROFILE_ID	u16	3A00 hex	✓	✓
PROFILE_SPECIFIC_TYPE	u16	0000 hex	✓	✓
IM_VERSION	u8[2]	01.02	✓	✓
IM_SUPPORTED	bit[16]	001E hex	✓	✓

8.4 Alarms, alarm buffer, and alarm history

Alarms

Alarms have the following properties:

- Incoming alarms have no direct influence on the inverter.
- Alarms disappear again when the cause is eliminated.
- Alarms do not have to be acknowledged.
- Alarms are displayed as follows:
 - Display via bit 7 in status word 1 (r0052)
 - Display on the operator panel with Axxxxx
 - Display in Startdrive or STARTER

Alarm code or alarm value describe the cause of the alarm.

Alarm buffer

Alarm code		Alarm value		Alarm time received		Alarm time removed		
		I32	float	Days	ms			
r2122[0]	r2124[0]	r2134[0]		r2145[0]	r2123[0]	old	r2146[0]	r2125[0]
[1]	[1]	[1]		[1]	[1]	↓ new	[1]	[1]
[2]	[2]	[2]		[2]	[2]		[2]	[2]
[3]	[3]	[3]		[3]	[3]		[3]	[3]
[4]	[4]	[4]		[4]	[4]		[4]	[4]
[5]	[5]	[5]		[5]	[5]		[5]	[5]
[6]	[6]	[6]		[6]	[6]		[6]	[6]
[7]	[7]	[7]		[7]	[7]		[7]	[7]

Figure 8-1 Alarm buffer

The inverter saves incoming alarms in the alarm buffer. An alarm includes an alarm code, an alarm value, and two alarm times:

- Alarm code: r2122
- Alarm value: r2124 in fixed-point format "I32", r2134 in floating-point format "Float"
- Alarm time received = r2145 + r2123
- Alarm time removed = r2146 + r2125

The inverter takes its internal time calculation to save the alarm times.

 System runtime (Page 392)

Up to 8 alarms can be saved in the alarm buffer.

In the alarm buffer, the warnings are sorted according to "Warning time received". If the alarm buffer is completely filled and an additional alarm occurs, then the inverter overwrites the values with Index [7].

Alarm history

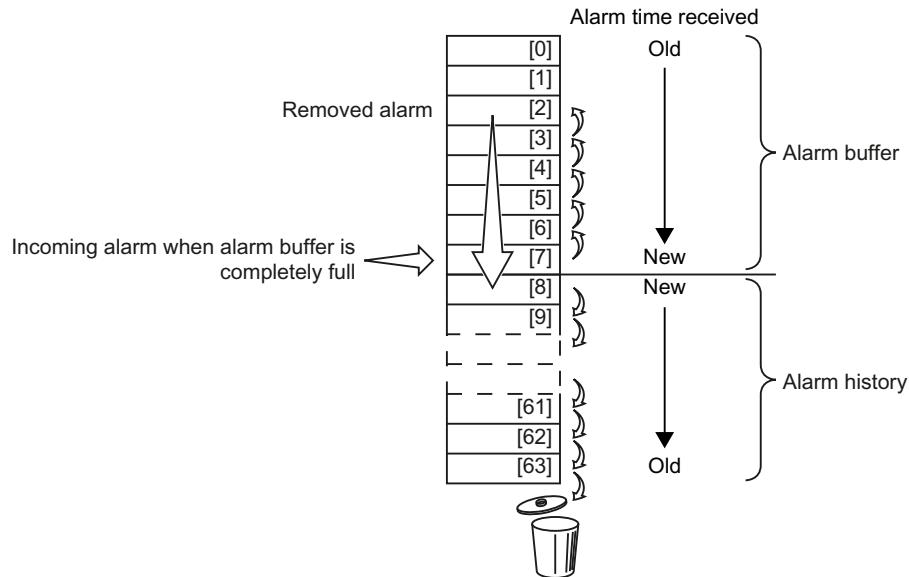

Figure 8-2 Shifting removed alarms into the alarm history

If the alarm buffer is completely filled and an additional alarm occurs, the inverter shifts all removed alarms into the alarm history. The following occurs in detail:

1. To create space after position [8] in the alarm history, the inverter shifts the alarms already stored in the alarm history "down" by one or more positions.
If the alarm history is completely full, the inverter will delete the oldest alarms.
2. The inverter moves the removed alarms from the alarm buffer to the now freed up positions of the alarm history.
Alarms that have not been removed remain in the alarm buffer.
3. The inverter closes gaps in the alarm buffer that occurred when the removed alarms were shifted in the alarm history by shifting the alarms that have not been removed "up".
4. The inverter saves the received alarm as the latest alarm in the alarm buffer.

The alarm history saves up to 56 alarms.

In the alarm history, alarms are sorted according to the "alarm time received". The latest alarm has Index [8].

Parameters of the alarm buffer and the alarm history

Parameter	Description
p2111	Alarm counter Number of alarms that have occurred after the last reset When setting p2111 = 0, all of the alarms that have been removed from the alarm buffer [0...7] are transferred into the alarm history [8...63]
r2122	Alarm code Displays the numbers of the alarms that have occurred

8.4 Alarms, alarm buffer, and alarm history

Parameter	Description
r2123	Alarm time received in milliseconds Displays the time in milliseconds when the alarm occurred
r2124	Alarm value Displays additional information about the alarm
r2125	Alarm time removed in milliseconds Displays the time in milliseconds when the alarm was removed
r2145	Alarm time received in days Displays the time in days when the alarm occurred
r2132	Actual alarm code Displays the code of the alarm that last occurred
r2134	Alarm value for float values Displays additional information about the alarm that occurred for float values
r2146	Alarm time removed in days Displays the time in days when the alarm was removed

Extended settings for alarms

Parameter	Description
You can change up to 20 different alarms into a fault or suppress alarms:	
p2118[0 ... 19]	Setting the message number for the message type Selection of the alarms for which the message type should be changed
p2119[0 ... 19]	Setting the message type Setting the message type for the selected alarm 1: Fault 2: Alarm 3: No message

You will find details in function diagram 8075 and in the parameter description of the List Manual.

8.5 Faults, alarm buffer and alarm history

Faults

Faults have the following properties:

- In general, a fault leads to the motor being switched off.
- A fault must be acknowledged.
- Faults are displayed as follows:
 - Display in bit 3 of status word 1 (r0052)
 - Display on the operator panel with Fxxxxx
 - Display on the inverter via the LED RDY
 - Display in Startdrive or STARTER

Fault buffer

Fault code	Fault value		Fault time received		Old ↓ New	Fault time removed	
	I32	float	Days	ms		Days	ms
r0945[0]	r0949[0]	r2133[0]	r2130[0]	r0948[0]	↓	r2136[0]	r2109[0]
[1]	[1]	[1]	[1]	[1]		[1]	[1]
[2]	[2]	[2]	[2]	[2]		[2]	[2]
[3]	[3]	[3]	[3]	[3]		[3]	[3]
[4]	[4]	[4]	[4]	[4]		[4]	[4]
[5]	[5]	[5]	[5]	[5]		[5]	[5]
[6]	[6]	[6]	[6]	[6]		[6]	[6]
[7]	[7]	[7]	[7]	[7]		[7]	[7]

Figure 8-3 Fault buffer

The inverter saves incoming faults in the fault buffer. A fault includes a fault code, a fault value, and two fault times:

- Fault code: r0945
The fault code and fault value describe the cause of the fault.
- Fault value: r0949 in fixed-point format "I32", r2133 in floating-point format "Float"
- Fault time received = r2130 + r0948
- Fault time removed = r2136 + r2109

The inverter takes its internal time calculation to save the fault times.

 System runtime (Page 392)

Up to 8 faults can be saved in the fault buffer.

In the fault buffer, the faults are sorted according to "Fault time received". If the fault buffer is completely filled and an additional fault occurs, then the inverter overwrites the values with Index [7].

Acknowledge fault

To acknowledge a fault, you have the following options:

- PROFIdrive control word 1, bit 7 (r2090.7)
- Acknowledging via a digital input
- Acknowledge via the Operator Panel
- Switch off the inverter power supply and switch on again

Faults detected during the inverter-internal monitoring of hardware and firmware can be acknowledged only by switching the supply voltage off and on again. In the list of faults in the List Manual, at the corresponding fault codes you may find the information on limitations when acknowledging.

Fault history

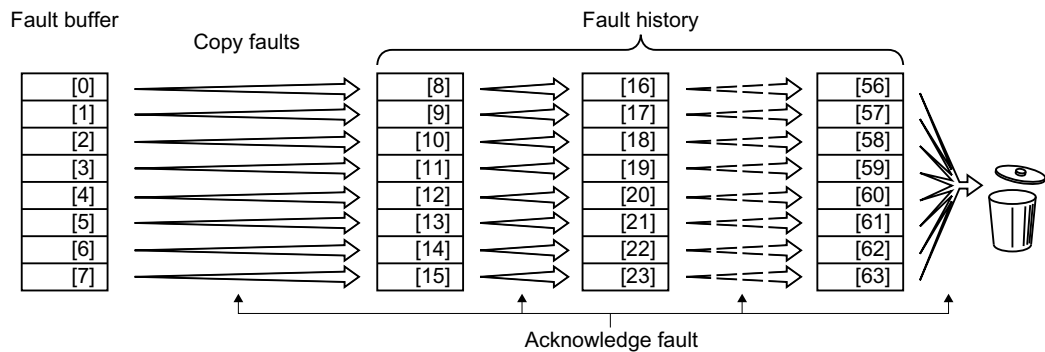

Figure 8-4 Fault history after acknowledging the faults

If at least one of the fault causes in the fault buffer has been removed and you acknowledge the faults, the following takes place:

1. The inverter shifts the values previously saved in the fault history by eight indexes. The inverter deletes the faults that were saved in the indexes [56 ... 63] before the acknowledgement.
2. The inverter copies the contents of the fault buffer to the memory locations [8 ... 15] in the fault history.
3. The inverter deletes the faults that have been removed from the fault buffer. The faults that have not been removed are now saved both in the fault buffer and in the fault history.
4. The inverter writes the time of acknowledgement of the removed faults to "Fault time removed". The "Fault time removed" of the faults that have not been removed retains the value = 0.

The fault history can contain up to 56 faults.

Deleting the fault history

To delete all faults from the fault history, set parameter p0952 to zero.

Parameters of the fault buffer and the fault history

Parameter	Description
r0945	Fault code Displays the numbers of the faults that have occurred
r0948	Fault time received in milliseconds Displays the time in milliseconds when the fault occurred
r0949	Fault value Displays additional information about the fault
p0952	Fault cases, counter A fault case can contain one or several faults. Number of fault cases that have occurred since the last acknowledgement. With p0952 = 0 you delete the fault buffer and the fault history.
r2109	Fault time removed in milliseconds Displays the time in milliseconds when the fault occurred
r2130	Fault time received in days Displays the time in days when the fault occurred
r2131	Actual fault code Displays the code of the oldest fault that is still active
r2133	Fault value for float values Displays additional information about the fault that occurred for float values
r2136	Fault time removed in days Displays the time in days when the fault was removed

Extended settings for faults

Parameter	Description
p2100[0 ... 19]	Setting the fault number for fault response Selecting the faults for which the fault response should be changed. You can modify the motor fault response for up to 20 different fault codes.
p2101[0 ... 19]	Setting, fault response Setting the fault response for the selected fault
p2118[0 ... 19]	Setting the message number for the message type Selection of the message for which the message type should be changed. You can change up to 20 different faults into an alarm, or suppress faults:
p2119[0 ... 19]	Setting the message type Setting the message type for the selected fault 1: Fault 2: Alarm 3: No message

Parameter	Description
p2126[0 ... 19]	Setting the fault number for the acknowledgement mode Selection of the faults for which the acknowledgement type should be changed. You can modify the acknowledgement type for up to 20 different fault codes.
p2127[0 ... 19]	Setting, acknowledgement mode Setting the acknowledgement type for the selected fault 1: Acknowledgement only using POWER ON 2: IMMEDIATE acknowledgement after removing the fault cause

You will find details in function diagram 8075 and in the parameter description of the List Manual.

8.6 List of alarms and faults

Axxxxx Alarm

Fyyyyy: Fault

Table 8-8 The most important alarms and faults

Number	Cause	Remedy
F01000	Software error in the CU	Replace CU.
F01001	Floating point exception	Switch off CU and switch on again.
F01015	Software error in the CU	Upgrade firmware or contact technical support.
F01018	Power-up aborted more than once	<ol style="list-style-type: none"> 1. Switch the module off and on again. 2. After this fault has been output, the module is powered up with the factory settings. 3. Recommission the inverter.
A01028	Configuration error	<p>Explanation: Parameterization on the memory card has been created with a different type of module (Article number, MLFB).</p> <p>Check the module parameters and recommission if necessary.</p>
F01033	Switching over units: Reference parameter value invalid	Set the value of the reference parameter not equal to 0.0 (p0304, p0305, p0310, p0596, p2000, p2001, p2002, p2003, r2004).
F01034	Switching over units: Calculation of the parameter values after reference value change unsuccessful	Select the value of the reference parameter so that the parameters involved can be calculated in the per unit notation (p0304, p0305, p0310, p0596, p2000, p2001, p2002, p2003, r2004).
F01040	Parameters must be saved	Save parameters (p0971). Switch CU off and on again.
F01044	Error loading data from memory card	Replace memory card or CU.
A01053	System overload measured	<p>The maximum computing power of the Control Unit was exceeded. The following measures reduce the load on the Control Unit:</p> <ul style="list-style-type: none"> • Use only one data record (CDS and DDS) • Only use the safety features of the basic functions • Deactivate the technology controller • Use the simple ramp-function generator rather than the extended ramp-function generator • Do not use any free function components • Reduce the sampling time of the free function blocks
F01054	System limit exceeded	
A01101	Memory card not available	<p>Insert a memory card or deactivate alarm A01101.</p> <p> Activate message for a memory card that is not inserted (Page 372)</p>
F01105	CU: Insufficient memory	Reduce number of data sets.
F01122	Frequency at the probe input too high	Reduce the frequency of the pulses at the probe input.
F01205	CU: Time slice overflow	Contact technical support.
F01250	CU hardware fault	Replace CU.
F01303	The DRIVE-CLiQ does not support the requested function	A function requested by the Control Unit is not supported by a DRIVE-CLiQ component.

8.6 List of alarms and faults

Number	Cause	Remedy
F01512	An attempt has been made to establish a conversion factor for scaling which does not exist	Create scaling or check transfer value.
A01590	Motor maintenance interval elapsed	Carry out maintenance and reset the maintenance interval (p0651).
F01600	STOP A initiated	Select STO and then deselect again.
F01625	Sign-of-life error in the Safety data	<ul style="list-style-type: none"> • Check the electrical cabinet design and cable routing for EMC compliance. • Check whether an impermissible voltage is connected at one of the digital outputs. • Check whether a digital output is loaded with an impermissible current. • Check whether additional faults exist and perform diagnostics if applicable. • Select STO safety function and then deselect again. • Switch off the inverter power supply and switch it on again.
F01650	Acceptance test required	Carry out an acceptance test and create test certificate. Switch off the Control Unit and switch on again.
F01659	Write task for parameter rejected	Cause: The inverter should be reset to the factory setting. However, it is not permissible to reset the safety functions as the safety functions are currently enabled.
		Remedy with operator panel:
		p0010 = 30 Parameter reset
		p9761 = ... Enter password for the safety functions.
		p0970 = 5 Reset start safety parameter. The inverter sets p0970 = 5 once it has reset the parameters.
		Then reset the inverter to the factory setting again.
F01662	Error, internal communications	<ul style="list-style-type: none"> • Check the electrical cabinet design and cable routing for EMC compliance. • Check whether an impermissible voltage is connected at one of the digital outputs. • Check whether a digital output is loaded with an impermissible current. If the checks are unsuccessful: <ul style="list-style-type: none"> • Switch off the inverter power supply and switch it on again • Upgrade the firmware • Contact technical support
A01666	Static 1 signal at the F-DI for safe acknowledgement	Set fail-safe digital input F-DI to a logical 0 signal.
A01698	Commissioning mode active for safety functions	This message is withdrawn after the Safety commissioning has ended.
A01699	Switch-off signal path test required	After the next time that the "STO" function is deselected, the message is withdrawn and the monitoring time is reset.
F01800	DRIVE-CLiQ: Incorrect hardware/ configuration	A DRIVE-CLiQ connection error has occurred. Check the DRIVE-CLiQ cables at the Control Unit.

Number	Cause	Remedy
A01900	PROFIBUS: Configuration telegram faulty	Explanation: A PROFIBUS master is attempting to establish a connection with a faulty configuration telegram. Check the bus configuration on the master and slave side.
A01910 F01910	Setpoint timeout	The alarm is generated when $p2040 \neq 0$ ms and one of the following causes is present: <ul style="list-style-type: none"> • The bus connection is interrupted • The Modbus master is switched off • Communications error (CRC, parity bit, logical error) • An excessively low value for the fieldbus monitoring time ($p2040$)
A01920	PROFIBUS: Cyclic connection interrupt	Explanation: The cyclic connection to PROFIBUS master is interrupted. Establish the PROFIBUS connection and activate the PROFIBUS master with cyclic operation.
F03505	Analog input, wire break	Check the wiring for interruptions. Check the level of the injected signal. The input current measured by the analog input can be read out in $r0752$.
A03520	Temperature sensor fault	Check that the sensor is connected correctly.
A05000 A05001 A05002 A05004 A05006	Power Module overtemperature	Check the following: <ul style="list-style-type: none"> - Is the ambient temperature within the defined limit values? - Are the load conditions and duty cycle configured accordingly? - Has the cooling failed?  Inverter protection using temperature monitoring (Page 327)
F06310	Supply voltage ($p0210$) incorrectly set	Check the set supply voltage and if required change ($p0210$). Check the line voltage.
F07011	Motor overtemperature	Reduce the motor load. Check ambient temperature. Check the wiring and connection of the sensor.
A07012	I2t motor model overtemperature	Check and if necessary reduce the motor load. Check the motor's ambient temperature. Check the thermal time constant $p0611$. Check overtemperature fault threshold $p0605$.
A07015	Motor temperature sensor alarm	Check that the sensor is connected correctly. Check the parameter assignment ($p0601$).
F07016	Motor temperature sensor fault	Make sure that the sensor is connected correctly. Check the parameterization ($p0601$). Deactivate the motor temperature sensor fault evaluation ($p0607 = 0$).
F07086 F07088	Switching over units: Parameter limit violation	Check the adapted parameter values and if required correct.
F07320	Automatic restart aborted	Increase the number of restart attempts ($p1211$). The current number of start attempts is shown in $r1214$. Increase the wait time in $p1212$ and/or monitoring time in $p1213$. Connect an ON command ($p0840$). Increase the monitoring time of the power unit or switch off ($p0857$). Reduce the wait time for resetting the fault counter $p1213[1]$ so that fewer faults are registered in the time interval.

8.6 List of alarms and faults

Number	Cause	Remedy
A07321	Automatic restart active	Explanation: The automatic restart (AR) is active. During voltage recovery and/or when remedying the causes of pending faults, the drive is automatically switched back on.
F07330	Search current measured too low	Increase the search current (p1202), check the motor connection.
A07400	DC-link voltage maximum controller active	If the controller is not to intervene: <ul style="list-style-type: none"> • Increase the ramp-down time of the ramp-function generator (p1121, p1135). • Deactivate the Vdc_max controller.  Motor and inverter protection by limiting the voltage (Page 335)
F07403	Lower DC-link voltage threshold reached	The DC-link voltage monitoring is active (p1240 = 5, 6) and the lower DC-link voltage threshold (p1248) was reached in the "Operation" state. Check the following: <ul style="list-style-type: none"> • Line voltage • Infeed Reduce the lower DC-link voltage threshold (p1248).
F07404	DC-link voltage monitoring V_{DCmax}	The DC-link voltage monitoring p1284 has responded. Check the following: <ul style="list-style-type: none"> • Line voltage • Braking resistor • Device supply voltage (p210) Increase the DC-link voltage threshold (p1284).
A07409	V/f control, current limiting controller active	The alarm automatically disappears after one of the following measures: <ul style="list-style-type: none"> • Increase the current limit (p0640). • Reduce the load. • Increase the ramp-up time to the speed setpoint.
F07412	Commutation angle incorrect (motor model)	An incorrect commutation angle can result in positive feedback in the speed controller. Check the motor phase sequence (wiring, p1820). Adjust the encoder. Replace the encoder. Carry out motor data identification. Carry out pole position identification.
F07413	Commutation angle incorrect (pole position identification)	An incorrect commutation angle can result in positive feedback in the speed controller. Check the motor phase sequence (wiring, p1820). Adjust the encoder. Replace the encoder. Carry out pole position identification.
F07426	Technology controller actual value limited	<ul style="list-style-type: none"> • Adapt the limits to the signal level (p2267, p2268). • Check the actual value scaling (p2264).



Number	Cause	Remedy
F07801	Motor overcurrent	<p>Check current limits (p0640).</p> <p>Vector control: Check current controller (p1715, p1717).</p> <p>V/f control: Check the current limiting controller (p1340 ... p1346).</p> <p>Increase the acceleration ramp (p1120) or reduce the load.</p> <p>Check the motor and motor cables for short-circuit and ground fault.</p> <p>Check the motor regarding the star/delta connection and rating plate parameterization.</p> <p>Check power unit / motor combination.</p> <p>Select the flying restart function (p1200) if switched to rotating motor.</p>
A07805	Drive: Power unit overload I2t	<ul style="list-style-type: none"> • Reduce the continuous load. • Adapt the load cycle. • Check the assignment of rated currents of the motor and power unit.  Inverter protection using temperature monitoring (Page 327)
F07806	Regenerative power limit exceeded	<p>Increase the deceleration ramp.</p> <p>Reduce the driving load.</p> <p>Use a power unit with higher energy recovery capability.</p> <p>For vector control, the regenerative power limit in p1531 can be reduced until the fault is no longer activated.</p>
F07807	Short-circuit detected	<ul style="list-style-type: none"> • Check the inverter connection on the motor side for any phase-phase short-circuit. • Rule out that line and motor cables have been interchanged.
A07850 A07851 A07852	External alarm 1 ... 3	<p>The signal for "external alarm 1" has been triggered.</p> <p>Parameters p2112, p2116 and p2117 determine the signal sources for the external alarm 1... 3.</p> <p>Remedy: Remove the causes of these alarms.</p>
F07860 F07861 F07862	External fault 1 ... 3	Remove the external causes for this fault.
F07900	Motor blocked	<p>Check that the motor can run freely.</p> <p>Check the torque limits (r1538 and r1539).</p> <p>Check the parameters of the "Motor blocked" message (p2175, p2177).</p>
F07901	Motor overspeed	<p>Activate the precontrol for the speed limiting controller (p1401 bit 7 = 1).</p> <p>Increase the hysteresis for overspeed signal p2162.</p>
F07902	Motor stalled	<p>Check whether the motor data has been set correctly and perform a motor identification.</p> <p>Check the current limits (p0640, r0067, r0289). If the current limits are too low, the drive cannot be magnetized.</p> <p>Check whether motor cables are disconnected during operation.</p>
A07903	Motor speed deviation	<p>Increase p2163 and/or p2166.</p> <p>Increase the torque, current and power limits.</p>

8.6 List of alarms and faults

Number	Cause	Remedy
A07904	External armature short-circuit: "Closed" contactor feedback signal missing	When closing, the contactor feedback signal (p1235) did not signal "closed" (r1239.1 = 1) within the monitoring time (p1236). Check the following: <ul style="list-style-type: none"> • Has the contactor feedback signal been incorrectly connected (p1235)? • Contactor feedback signal logic (r1239.1 = 1: "Closed", r1239.1 = 0: "Open"). Increase the monitoring time (p1236).
F07905	External armature short-circuit: "Open" contactor feedback signal missing	When opening, the contactor feedback signal (p1235) did not signal "open" (r1239.1 = 0) within the monitoring time (p1236). Check the following: <ul style="list-style-type: none"> • Has the contactor feedback signal been incorrectly connected (p1235)? • Contactor feedback signal logic (r1239.1 = 1: "Closed", r1239.1 = 0: "Open"). Increase the monitoring time (p1236).
A07908	Internal armature short-circuit active	The motor is short-circuited via the power semiconductor (r1239.5 = 1).
F07909	Internal voltage protection: Deactivation only active after POWER ON	The inverter has activated the "Internal voltage protection" function" (p1231 = 3). Deactivation of the internal voltage protection (p1231 not equal to 3) only becomes active after POWER ON.
A07910	Motor overtemperature	Check the motor load. Check the motor's ambient temperature. Check the KTY84 or PT1000 sensor. Check the overtemperatures of the thermal model (p0626 ... p0628).
A07920	Torque/speed too low	The torque deviates from the torque/speed envelope curve.
A07921	Torque/speed too high	<ul style="list-style-type: none"> • Check the connection between the motor and the load.
A07922	Torque/speed out of tolerance	<ul style="list-style-type: none"> • Adapt the parameterization corresponding to the load.
F07923	Torque/speed too low	<ul style="list-style-type: none"> • Check the connection between the motor and the load.
F07924	Torque/speed too high	<ul style="list-style-type: none"> • Adapt the parameterization corresponding to the load.
A07927	DC braking active	Not required
F7966	Check commutation angle	Carry out pole position identification.
F7969	Pole position identification incorrect	An error has occurred during the pole position identification. Check the following: <ul style="list-style-type: none"> • Motor connection • Motor data
A07980	Rotary measurement activated	Not required
A07981	No enabling for rotary measurement	Acknowledge pending faults. Establish missing enables (see r00002, r0046).
A07991	Motor identification activated	Switch on the motor and identify the motor data.
F07995	Pole position identification unsuccessful	An error has occurred during the pole position identification. Check the following: <ul style="list-style-type: none"> • Motor connection • Motor data

Number	Cause	Remedy
F08501	Setpoint timeout	<ul style="list-style-type: none"> • Check the PROFINET connection. • Set the controller to RUN mode. • If the fault occurs repeatedly, check the monitoring time set p2044.
F08502	Monitoring time, sign-of-life expired	<ul style="list-style-type: none"> • Check the PROFINET connection.
F08510	Send configuration data not valid	<ul style="list-style-type: none"> • Check the PROFINET configuration
A08511	Receive configuration data not valid	
A08526	No cyclic connection	<ul style="list-style-type: none"> • Activate the control with cyclic operation. • Check the parameters "Name of Station" and "IP of Station" (r61000, r61001).
A08565	Consistency error affecting adjustable parameters	<p>Check the following:</p> <ul style="list-style-type: none"> • IP address, subnet mask or default gateway is not correct. • IP address or station name used twice in the network. • Station name contains invalid characters.
A08800	PROFInergy energy-saving mode active	<p>The PROFInergy energy-saving mode is active.</p> <p>The alarm automatically disappears when the energy-saving mode is exited.</p>
A13000	Licensing is not sufficient	<p>You are using functions that require a license, but you don't have the appropriate licenses.</p> <p> Activating licensed functions (Page 492)</p>
F13010	Licensing is not sufficient	Options requiring a license are used in the inverter, and the licensing is not sufficient.
F13010	Licensing, function module not licensed.	<p>At least one function module requiring a license is not licensed.</p> <p>Deactivate the function module that is not licensed.</p>
F13101	Know-how protection: Copy protection cannot be activated	Insert a valid memory card.
F30001	Overcurrent	<p>Check the following:</p> <ul style="list-style-type: none"> • Motor data, if required, carry out commissioning • Motor connection method (Y / Δ) • V/f operation: Assignment of rated currents of motor and Power Module • Line quality • Make sure that the line commutating reactor is connected properly • Power cable connections • Power cables for short-circuit or ground fault • Power cable length • Line phases • Short-circuit at the Control Unit output terminals <p>If this doesn't help:</p> <ul style="list-style-type: none"> • V/f operation: Increase the acceleration ramp • Reduce the load • Replace the power unit

8.6 List of alarms and faults

Number	Cause	Remedy
F30002	DC-link voltage overvoltage	Increase the ramp-down time (p1121). Set the rounding times (p1130, p1136). Activate the DC-link voltage controller (p1240, p1280). Check the line voltage (p0210). Check the line phases.
F30003	DC-link voltage undervoltage	Check the line voltage (p0210).
F30004	Inverter overtemperature	Check whether the inverter fan is running. Check whether the ambient temperature is in the permissible range. Check whether the motor is overloaded. Reduce the pulse frequency.  Inverter protection using temperature monitoring (Page 327)
F30005	I2t inverter overload	Check the rated currents of the motor and Power Module. Reduce the current limit p0640. When operating with V/f characteristic: Reduce p1341.  Inverter protection using temperature monitoring (Page 327)
F30011	Line phase failure	Check the input fuses of the inverter. Check the motor feeder cables.
F30015	Motor cable phase failure	Check the motor cables. Increase the ramp-up or ramp-down time (p1120).
F30021	Ground fault	<ul style="list-style-type: none"> • Check the power cable connections. • Check the motor. • Check the current transformer. • Check the cables and contacts of the brake connection (a wire might be broken).
F30022	Power Module: Monitoring U_{CE}	Check or replace Power Module.
F30027	Time monitoring for DC link pre-charging	Check the line voltage at the input terminals. Check the line voltage setting (p0210).
F30024	Overtemperature, thermal model	<ul style="list-style-type: none"> • Adapt the duty cycle. • Check whether the fan is running. • Check whether the ambient temperature is in the permissible range. • Check the motor load. • Reduce the pulse frequency. • Reduce the current of the DC current braking.  Inverter protection using temperature monitoring (Page 327)
F30035	Overtemperature, intake air	<ul style="list-style-type: none"> • Check whether the fan is running.
F30036	Overtemperature, inside area	<ul style="list-style-type: none"> • Check the fan filter elements. • Check whether the ambient temperature is in the permissible range.
F30037	Rectifier overtemperature	See F30035 and, in addition: <ul style="list-style-type: none"> • Check the motor load. • Check the line phases
A30049	Internal fan defective	Check the internal fan and if required replace.
F30052	Incorrect Power Module data	Replace Power Module or upgrade CU firmware.

Number	Cause	Remedy
F30053	Error in FPGA data	Replace the Power Module.
F30059	Internal fan defective	Check the internal fan and if required replace.
F30074	Communications error between Control Unit and Power Module	There is a communications fault between the Control Unit and the Power Module. Possible causes: <ul style="list-style-type: none"> • The Control Unit may have been removed or inserted incorrectly. • The external 24 V Control Unit power supply has dipped to $\leq 95\%$ of the rated voltage for ≤ 3 ms
A30502	DC-link overvoltage	<ul style="list-style-type: none"> • Check the device supply voltage (p0210). • Check the line reactor dimensioning
A30920	Temperature sensor fault	Check that the sensor is connected correctly.
F30600	STOP A initiated	Select STO and then deselect again.
F30662	CU hardware fault	Switch CU off and on again, upgrade firmware, or contact technical support.
F30664	CU power up aborted	Switch CU off and on again, upgrade firmware, or contact technical support.
F30850	Software fault in the Power Module	Replace Power Module or contact technical support.
A50001	PROFINET configuration error	A PROFINET control is attempting to establish a connection with an incorrect configuration telegram. Check whether "Shared Device" is activated (p8929 = 2).
A50010	PROFINET name of station invalid	Correct the name of station (p8920) and activate (p8925 = 2).
A50020	PROFINET: Second control missing	"Shared Device" is activated (p8929 = 2). However, only the connection to a PROFINET control is available.
You will find more information in the List Manual.		

For further information, please refer to the List Manual.



Overview of the manuals (Page 519)

Corrective maintenance

9.1 Spare parts compatibility

Continuous development within the scope of product maintenance

Inverter components are being continuously developed within the scope of product maintenance. Product maintenance includes, for example, measures to increase the ruggedness or hardware changes which become necessary as components are discontinued.

These further developments are "spare parts-compatible" and do not change the article number.

In the scope of such spare parts-compatible ongoing development, plug connector or connection positions are sometimes slightly modified. This does not cause any problems when the components are properly used. Please take this fact into consideration in special installation situations (e.g. allow sufficient reserve regarding the cable length).

9.2 Replacing inverter components

⚠ WARNING

Fire or electric shock due to defective components

If an overcurrent protection device is triggered, the inverter may be defective. A defective inverter can cause a fire or electric shock.

- Have the inverter and the overcurrent protection device checked by a specialist.

Repair

⚠ WARNING

Fire or electric shock due to improper repair

Improper repair of the inverter may cause malfunctions or result in consequential damage such as fire or electric shock.

- Only commission the following persons to repair the inverter:
 - Siemens customer service
 - A repair center that has been authorized by Siemens
 - Specialist personnel who are thoroughly acquainted with all the warnings and operating procedures contained in this manual.
- Only use original spare parts when carrying out repairs.

Recycling and disposal







For environmentally-friendly recycling and disposal of your old device, please contact a company certified for the disposal of waste electrical and electronic equipment, and dispose of the old device as prescribed in the respective country of use.

9.2.1 Overview of replacing converter components

Permissible replacement of components

In the event of a long-term function fault, you must replace the Power Module or Control Unit. The inverter's Power Module and Control Unit can be replaced independently of each other.

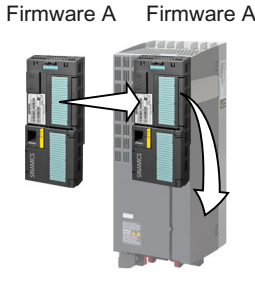
In the following cases you will need to replace the inverter:

Replacing the Power Module		Replacing the Control Unit	
Replacement: <ul style="list-style-type: none"> • Same type • Same power rating 	Replacement: <ul style="list-style-type: none"> • Same type • Same frame size • <i>Higher</i> power rating 	Replacement: <ul style="list-style-type: none"> • Same type • Same firmware version 	Replacement: <ul style="list-style-type: none"> • Same type • <i>Higher</i> firmware version (e.g. replace FW V4.2 by FW V4.3)
			
	Power Module and motor must be adapted to one another (ratio of motor and Power Module rated power > 1/4)	After replacing the Control Unit, you must restore the inverter's settings.	

⚠ WARNING

Unexpected machine motion caused by incorrect/inappropriate inverter settings

Replacing inverters of different types can result in incomplete or incorrect/inappropriate inverter settings. As a consequence, unexpected machine motion, e.g. speed oscillation, overspeed or incorrect direction of rotation. Unexpected machine motion can result in death, injury or material damage.

- In all cases that are not permitted according to the table above, recommission the drive after replacing an inverter.

Special issue relating to communication via PROFINET: Device replacement without removable data storage medium

The inverter supports the PROFINET functionality, replacing the device without data storage medium. After replacing the Control Unit, the inverter is automatically assigned its device name from the IO controller.

Independent of this, after replacing the inverter, you must transfer the settings of the old inverter to the new inverter.

9.2 Replacing inverter components

Details of the device replacement without removable storage medium can be found in the Internet:

 PROFINET system description (<http://support.automation.siemens.com/WW/view/en/19292127>).

9.2.2 Replacing a Control Unit with enabled safety function

Replacing a Control Unit with data backup on a memory card

If you use a memory card with firmware, after the replacement, you obtain a precise copy (firmware and settings) of the replaced Control Unit.

Requirement

You have a memory card with the actual settings of the Control unit to be replaced.

Procedure

1. Disconnect the line voltage to the Power Module and (if installed) the external 24 V supply or the voltage for the digital outputs of the Control Unit.
2. Remove the signal cables from the Control Unit.
3. Remove the defective Control Unit.
4. Remove the memory card from the old Control Unit and insert it in the new Control Unit.
5. Mount the new Control Unit on the Power Module. The new Control Unit must have the same article number and the same or higher firmware version as the Control Unit that was replaced.
6. Reconnect the signal cables of the Control Unit.
7. Switch on the line voltage again.
8. The inverter loads the settings from the memory card.
9. Check what the inverter reports after loading.
 - Alarm A01028:
The loaded settings are not compatible with the inverter.
Set p0971 = 1 to delete the alarm. Check the inverter settings. We recommend that you recommission the drive.
 - Fault F01641:
Acknowledge the message.
Perform a **reduced** acceptance test.
 Reduced acceptance after a component has been replaced and a firmware change (Page 436)

You have replaced the Control Unit and transferred the safety function settings from the memory card to the new Control Unit.

□

Replacing a Control Unit with data backup in Startdrive

Requirement

You have backed up the actual settings of the Control Unit to be replaced to a PC using Startdrive.

Procedure

1. Switch off the line voltage to the Power Module and (if installed) the external 24 V supply or the voltage for the digital outputs of the Control Unit.
2. Remove the signal cables of the Control Unit.
3. Remove the defective Control Unit.
4. Mount the new Control Unit on the Power Module.
5. Reconnect the signal cables of the Control Unit.
6. Switch on the line voltage again.
7. Open the right project for the drive in the PC.
8. Select "Load to device".
9. Connect Startdrive online with the drive.
The inverter signals faults after the download. Ignore these faults, as they will be automatically acknowledged by the following steps.
10. Press the "Start safety commissioning" button.
11. Enter the password for the safety functions.
12. Confirm the prompt for saving your settings (copy RAM to ROM).
13. Disconnect the online connection.
14. Switch off the inverter power supply.
15. Wait until all LEDs on the inverter are dark.
16. Switch the inverter power supply on again.
17. Perform a **reduced** acceptance test.
 Reduced acceptance after a component has been replaced and a firmware change (Page 436)

You have replaced the Control Unit and transferred the safety function settings from the PC to the new Control Unit.

□

Replacing the Control Unit with data backup in the operator panel

Requirement

You have backed up the actual settings of the Control Unit to be replaced to an operator panel.

Procedure

1. Switch off the line voltage to the Power Module and (if installed) the external 24 V supply or the voltage for the digital outputs of the Control Unit.
2. Remove the signal cables of the Control Unit.
3. Remove the defective Control Unit.
4. Mount the new Control Unit on the Power Module.
5. Reconnect the signal cables of the Control Unit.

6. Switch on the line voltage again.
7. Plug the Operator Panel into the Control Unit or connect the Operator Panel handheld device with the inverter.
8. Transfer the settings from the operator panel to the inverter.
9. Wait until the transfer is complete.
10. After loading, check whether the inverter outputs Alarm A01028.
 - Alarm A01028:
The loaded settings are not compatible with the inverter.
Set p0971 = 1 to delete the alarm. Check the inverter settings. We recommend that you recommission the drive.
 - No alarm A01028: Proceed with the next step.
11. Switch off the inverter power supply.
12. Wait until all LEDs on the inverter are dark.
13. Switch the inverter power supply on again.
The inverter reports the faults F01641, F01650, F01680 and F30680. Ignore these faults, as they will be automatically acknowledged by the following steps.
14. Set p0010 to 95.
15. Set p9761 to the safety password.
16. Set p9701 to AC hex.
17. Set p0010 = 0.
18. Back up the settings so they are not lost when the power fails:
 - For BOP-2 in the menu "EXTRAS" - "RAM-ROM".
 - IOP in the menu "SAVE RAM TO ROM".
19. Switch off the inverter power supply.
20. Wait until all LEDs on the inverter are dark.
21. Switch the inverter power supply on again.
22. Perform a **reduced** acceptance test
 Reduced acceptance after a component has been replaced and a firmware change
(Page 436)

You have replaced the Control Unit and transferred the safety function settings from the operator panel to the new Control Unit.



9.2.3 Replacing the Control Unit without the safety functions enabled

Replacing a Control Unit with data backup on a memory card

If you use a memory card with firmware, after the replacement, you obtain a precise copy (firmware and settings) of the replaced Control Unit.

Precondition

You have a memory card with the actual settings of the Control unit to be replaced.

Procedure

1. Disconnect the line voltage to the Power Module and (if installed) the external 24 V supply or the voltage for the digital outputs of the Control Unit.
2. Remove the signal cables from the Control Unit.
3. Remove the defective Control Unit.
4. Mount the new Control Unit on the Power Module. The new Control Unit must have the same article number and the same or higher firmware version as the Control Unit that was replaced.
5. Remove the memory card from the old Control Unit and insert it in the new Control Unit.
6. Reconnect the signal cables of the Control Unit.
7. Switch on the line voltage again.
8. The inverter loads the settings from the memory card.
9. After loading, check whether the inverter outputs Alarm A01028.
 - Alarm A01028:
The loaded settings are not compatible with the inverter.
Clear the alarm with p0971 = 1 and recommission the drive.
 - No alarm A01028:
The inverter accepts the settings that have been loaded.

You have successfully replaced the Control Unit.

□

Replacing a Control Unit with data backup in Startdrive

Precondition

You have backed up the actual settings of the Control Unit to be replaced to a PC using Startdrive.

Procedure

1. Switch off the line voltage to the Power Module and (if installed) the external 24 V supply or the voltage for the digital outputs of the Control Unit.
2. Remove the signal cables of the Control Unit.
3. Remove the defective Control Unit.

4. Mount the new Control Unit on the Power Module.
5. Reconnect the signal cables of the Control Unit.
6. Switch on the line voltage again.
7. Open the right project for the drive in the PC.
8. Select "Load to device".
9. Connect Startdrive online with the drive.
10. Confirm the prompt for saving your settings (copy RAM to ROM).
11. Disconnect the online connection.

You have replaced the Control Unit and transferred the settings from the PC to the new Control Unit.

□

Replacing the Control Unit with data backup in the operator panel

Precondition

You have backed up the actual settings of the Control Unit to be replaced to an operator panel.

Procedure

1. Disconnect the line voltage to the Power Module and (if installed) the external 24 V supply or the voltage for the digital outputs of the Control Unit.
2. Remove the signal cables of the Control Unit.
3. Remove the defective Control Unit.
4. Mount the new Control Unit on the Power Module.
5. Reconnect the signal cables of the Control Unit.
6. Switch on the line voltage again.
7. Plug the Operator Panel into the Control Unit or connect the Operator Panel handheld device with the inverter.
8. Transfer the settings from the operator panel to the inverter.
9. Wait until the transfer is complete.
10. After loading, check whether the inverter outputs Alarm A01028.
 - Alarm A01028:
The loaded settings are not compatible with the inverter.
Clear the alarm with p0971 = 1 and recommission the drive.
 - No alarm A01028: Proceed with the next step.
11. Back up the settings so they are not lost when the power fails:
 - For BOP-2 in the menu "EXTRAS" - "RAM-ROM".
 - For IOP-2 in the menu "SAVE RAM TO ROM".

9.2 Replacing inverter components

You have replaced the Control Unit and transferred the safety function settings from the operator panel to the new Control Unit.



9.2.4 Replacing the Control Unit without data backup

If you do not backup the settings, then you must recommission the drive after replacing the Control Unit.

Procedure

1. Switch off the line voltage to the Power Module and (if installed) the external 24 V supply or the voltage for the digital outputs of the Control Unit.
2. Remove the signal cables of the Control Unit.
3. Remove the defective Control Unit.
4. Mount the new Control Unit on the Power Module.
5. Reconnect the signal cables of the Control Unit.
6. Switch on the line voltage again.
7. Recommission the drive.

The Control Unit replacement has been completed once the drive has been successfully commissioned.



9.2.5 Replacing a Control Unit with active know-how protection

Replacing devices with know-how protection without copy protection

In the case of know-how protection without copy protection, the inverter settings can be transferred to another inverter using a memory card.



Saving setting on memory card (Page 365)



Transferring the setting from the memory card (Page 368)

Replacing devices with know-how protection with copy protection



The know-how protection with copy protection hides the inverter settings and also prevents the duplication of the inverter settings.

If the inverter settings can neither be copied nor forwarded, a recommissioning is required after inverter replacement.

To avoid the recommissioning, you must use a Siemens memory card, and the machine manufacturer must have an identical prototype machine that it uses as sample.

There are two options for replacing the device:



Option 1: The machine manufacturer only knows the serial number of the new inverter

1. The end customer provides the machine manufacturer with the following information:
 - For which machine must the inverter be replaced?
 - What is the serial number (r7758) of the new inverter?
2. The machine manufacturer performs the following steps online on the prototype machine:
 - Deactivating know-how protection
 Activating and deactivating know-how protection (Page 383)
 - Enter the serial number of the new inverter in p7759.
 - Enter the serial number of the inserted memory card as reference serial number in p7769.
 - Activate know-how protection with copy protection. "Copy RAM to ROM" must be activated.
 Activating and deactivating know-how protection (Page 383)
 - Write the configuration with p0971 = 1 to the memory card.
 - Send the memory card to the end customer.
3. The end customer inserts the memory card and switches on the power supply for the inverter.

When powering up, the inverter checks the serial numbers of the card and when there is a match, the inverter goes into the "ready to start" state.

If the numbers do not match, then the inverter signals fault F13100 (no valid memory card).

Option 2: The machine manufacturer knows the serial number of the new inverter and the serial number of the memory card

1. The end customer provides the machine manufacturer with the following information:
 - For which machine must the inverter be replaced?
 - What is the serial number (r7758) of the new inverter?
 - What is the serial number of the memory card?
2. The machine manufacturer performs the following steps online on the prototype machine:
 - Deactivating know-how protection
 Activating and deactivating know-how protection (Page 383)
 - Enter the serial number of the new inverter in p7759.
 - Enter the serial number of the customer's memory card as reference serial number in p7769.
 - Activate know-how protection with copy protection. "Copy RAM to ROM" must be activated.
 Activating and deactivating know-how protection (Page 383)
 - Write the configuration with p0971 = 1 to the memory card.
 - Copy the encrypted project from the card to the associated PC.
 - Send the encrypted project to the end customer, e.g. via e-mail.
3. The end customer copies the project to the Siemens memory card that belongs to the machine, inserts it in the inverter and switches on the power supply for the inverter.

When powering up, the inverter checks the serial numbers of the card and when there is a match, the inverter goes into the "ready to start" state.

If the numbers do not match, then the inverter signals fault F13100 (no valid memory card).

9.2.6 Replacing a Power Module with enabled safety function



⚠ WARNING
Electric shock due to residual charge in the Power Module
After switching off the line voltage, it will take up to 5 minutes until the capacitors in the Power Module are sufficiently discharged for the residual voltage to be safe. Death or serious injury will result if energized parts are touched.
<ul style="list-style-type: none">• Check the safe isolation of the Power Module connections before carrying out installation work.

NOTICE
Motor damage due to interchanged motor connecting cables
The direction in which the motor rotates switches if you exchange the two phases of the motor line. A motor with an incorrect direction of rotation can damage the machine or installation. Driven loads with only one permissible direction of rotation include certain saws.
<ul style="list-style-type: none">• Connect the three phases of the motor lines in the right order.• After replacing the Power Module, check the direction of motor rotation.

Procedure

1. Switch off the line voltage of the Power Module.
You can leave any external 24 V supply to the Control Unit switched on.
2. Remove the connecting cables of the Power module.
3. Remove the Control Unit from the Power Module.
4. Replace the Power Module.
5. Mount the Control Unit onto the new Power Module.
6. Connect up the new Power Module using the connecting cables.
7. Switch on the line supply and, if necessary, the 24 V supply of the Control Unit.
8. The inverter reports F01641.
9. Perform a reduced acceptance test
 Reduced acceptance after a component has been replaced and a firmware change (Page 436)

You have successfully replaced the Power Module.

9.2.7 Replacing a Power Module without the safety function being enabled

Procedure

1. Switch off the supply voltage to the Power Module.
You do not have to switch off an external 24 V power supply for the Control Unit if one is being used.
2. Remove the connecting cables of the Power Module.
3. Remove the Control Unit from the Power Module.
4. Replace the old Power Module with the new Power Module.
5. Mount the Control Unit onto the new Power Module.
6. Connect up the new Power Module using the connecting cables.

NOTICE

Motor damage due to interchanged motor connecting cables

The direction in which the motor rotates switches if you exchange the two phases of the motor line. A motor with an incorrect direction of rotation can damage the machine or installation. Work machines with only one permissible direction of rotation include certain compressors, saws and pumps.

- Connect the three phases of the motor lines in the right order.
- After replacing the Power Module, check the direction of motor rotation.

7. Switch on the line supply and, if necessary, the 24 V supply of the Control Unit.

You have successfully replaced the Power Module.



9.3 Replacing an encoder

Same interface, same encoder type

If you have to replace a defective encoder, then it is best if you use the same encoder type.

 Replacing the encoder - same encoder type (Page 426)

Same interface, different encoder type

If you use an different encoder type:

 Replacing the encoder - different encoder type (Page 427)



Different interface

If you connect the encoder at a different interface, you must perform a recommissioning.

 Starting wizards for the quick commissioning (Page 136)

9.3.1 Replacing the encoder - same encoder type

Procedure

1. Switch off the inverter power supply, including the external 24 V supply for the Control Unit and digital outputs.
2. Replace the encoder. Connect the encoder cable shield as specified.
 EMC-compliant installation of a machine or system (Page 53)
3. Switch on the power supplies.
4. If you have replaced an absolute encoder, and you use this encoder to sense positions, then you must adjust the encoder. Further information about this topic is provided in the "Basic positioner" function manual.
 Overview of the manuals (Page 519)



You have replaced the encoder.

9.3.2 Replacing the encoder - different encoder type

Precondition

You have backed up the actual inverter settings to your PC using Startdrive.

Procedure

1. Switch off the inverter power supply, including the external 24 V supply for the Control Unit and the digital outputs.
2. Remove the encoder to be replaced.
3. Switch on the power supplies.
4. Change the encoder data in Startdrive (see below).
5. Acknowledge the changes by pressing OK and save the data to your computer.
6. Go online.
7. In the project, select the inverter
8. Press the "Load to device" button. .
9. In the following screen form, select "Back up parameter assignment in the EEPROM".
10. Go offline.
11. Connect the new encoder.
Connect the encoder cable shield as specified.
 EMC-compliant installation of a machine or system (Page 53)
12. Switch on the power supplies.
13. Check that the drive functions correctly.

You have replaced the encoder with another encoder type.

□

Changing the encoder data

Procedure

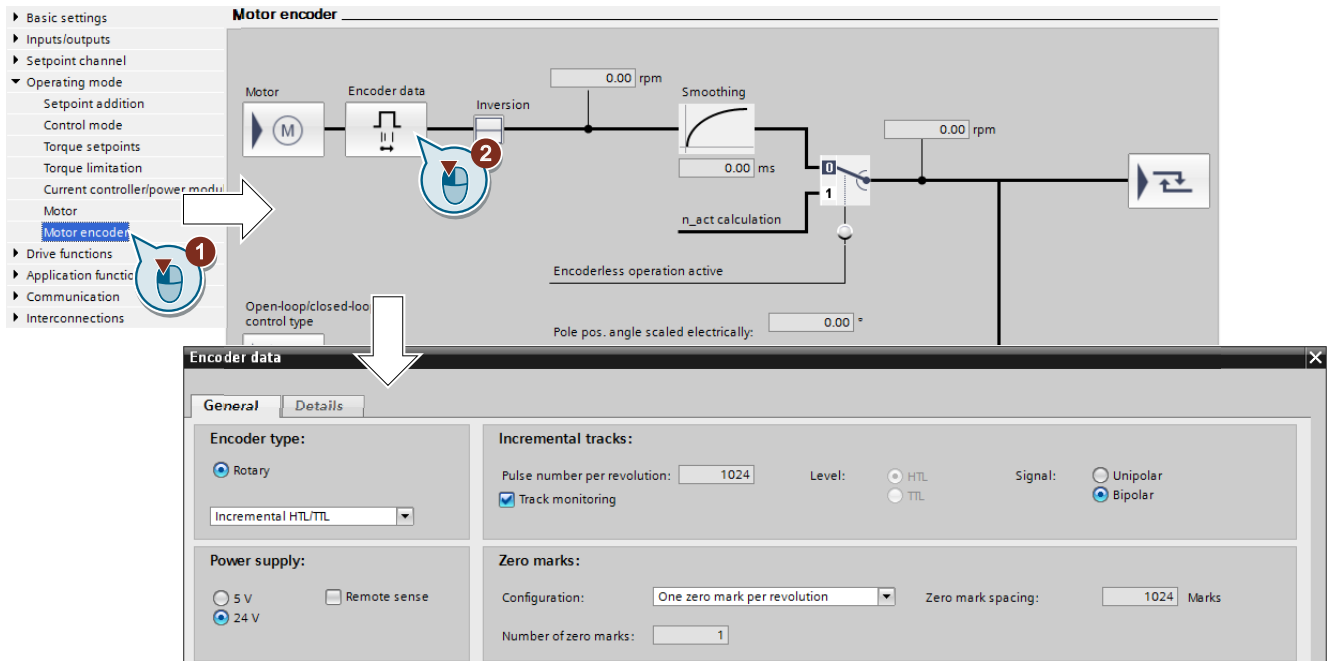

1. Open the "Motor encoder" function view.
2. Select the "Encoder data" button.
3. Change the encoder data.
4. Save your settings.

You have changed the encoder data.



9.4 Firmware upgrade and downgrade

Preparing a memory card for a firmware upgrade or downgrade

Procedure

1. Download the required firmware to your PC from the Internet.
 Download (<https://support.industry.siemens.com/cs/ww/en/view/67364620>)
2. Extract the files to a directory of your choice on your PC.
3. Transfer the unzipped files into the root directory of the memory card.

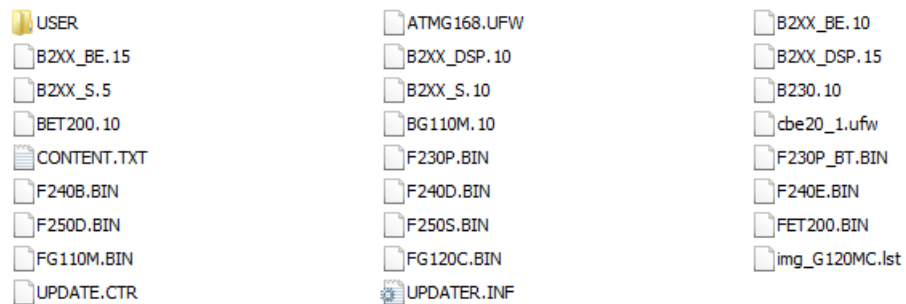

Figure 9-1 Example of memory card contents after the file transfer

Depending on the firmware, the filenames and the number of files may differ from the display above.

The "USER" directory does not exist on unused memory cards. After the memory card is plugged in for the first time, the inverter creates a new "USER" directory.

You have prepared the memory card for the firmware upgrade or downgrade.



Memory cards that can be ordered:



Memory cards (Page 362)

Overview of firmware upgrades and downgrades

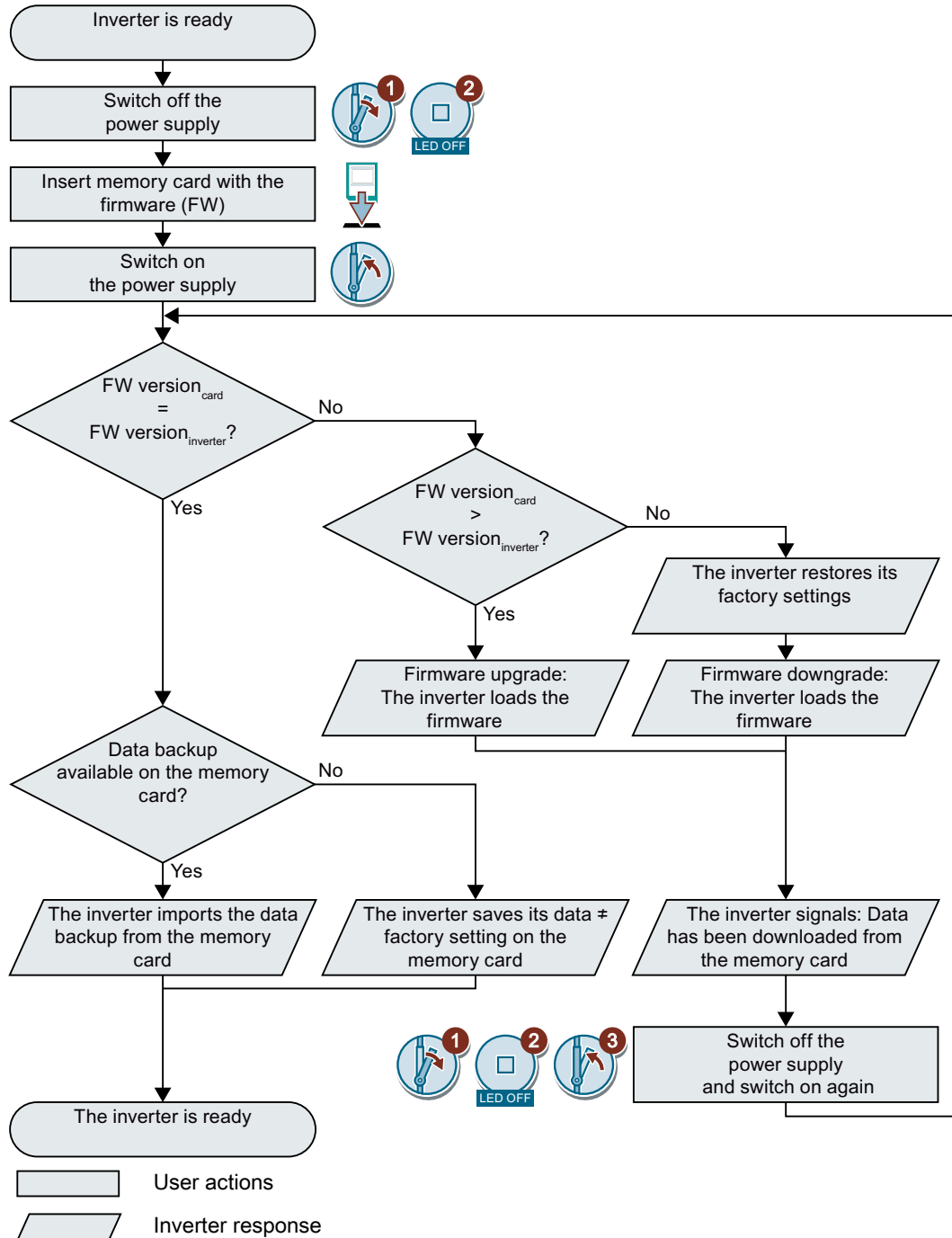

Figure 9-2 Overview of the firmware upgrade and firmware downgrade

9.4.1 Upgrading the firmware

When upgrading the firmware, you replace the inverter firmware by a later version. Only update the firmware to a later version if you require the expanded functional scope of the newer version.

Precondition

- The firmware version of your inverter is at least V4.5.
- Inverter and memory card have different firmware versions.

Procedure

1. Switch off the inverter power supply.
2. Wait until all LEDs on the inverter are dark.

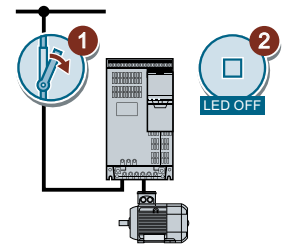

3. Insert the card with the matching firmware into the inverter slot until it latches into place.

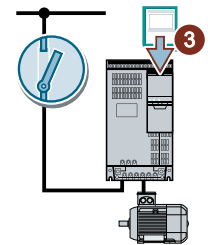

4. Switch on the inverter power supply again.
5. The inverter transfers the firmware from the memory card into its memory.

The transfer takes approximately 5 ... 10 minutes.

While data is being transferred, the LED RDY on the inverter stays red. The LED BF flashes orange with a variable frequency.

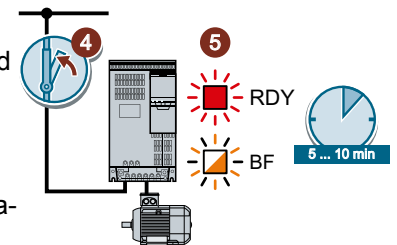

6. At the end of the transfer, the LED RDY and BF slowly flash red (0.5 Hz).

Power supply failure during transfer

The inverter firmware will be incomplete if the power supply fails during the transfer.

- Start again with step 1 of the instructions.

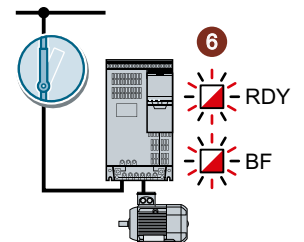

7. Switch off the inverter power supply.
8. Wait until all LEDs on the inverter are dark.

Decide whether you want to withdraw the memory card from the inverter:

- You remove the memory card:
⇒ The inverter keeps its settings.

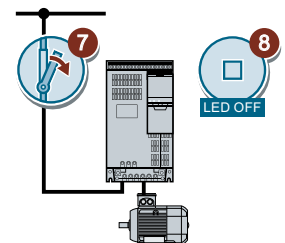

9.4 Firmware upgrade and downgrade

- You leave the memory card in the inverter:
 - ⇒ If the memory card still does not have a data backup of the inverter settings, in step 9 the inverter writes its settings to the memory card.
 - ⇒ If the memory card already includes a data backup, the inverter imports the settings from the memory card in step 9.

9. Switch on the inverter power supply again.

10. If the firmware upgrade was successful, after several seconds the inverter LED RDY turns green.

If the memory card is still inserted, depending on the previous content of the memory card, one of the two following cases has occurred:

- The memory card contains a data backup:
 - ⇒ The inverter has taken the settings from the memory card.
- There was no data backup on the memory card:
 - ⇒ The inverter has written its settings to the memory card.

You have upgraded the inverter firmware.

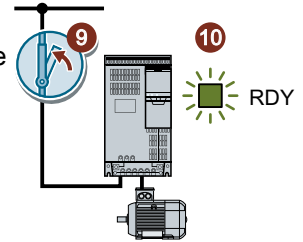

Memory cards with license

If the memory card includes a license, e.g. for the basic positioner, then the memory card must remain inserted after the firmware has been updated.

9.4.2 Firmware downgrade

When downgrading the firmware, you replace the inverter firmware by an older version. Only downgrade the firmware to an older version if, after replacing an inverter, you require the same firmware in all of your inverters.

Precondition

- The firmware version of your inverter is at least V4.6.
- Inverter and memory card have different firmware versions.
- You have backed up your settings on the memory card, in an Operator Panel or in a PC.

Procedure

1. Switch off the inverter power supply.
2. Wait until all LEDs on the inverter are dark.

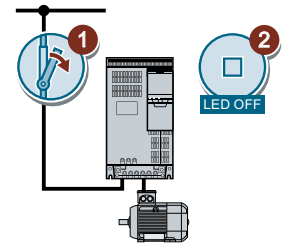

3. Insert the card with the matching firmware into the inverter slot until it latches into place.

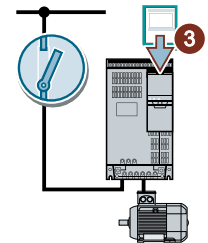

4. Switch on the inverter power supply again.
5. The inverter transfers the firmware from the memory card into its memory.

The transfer takes approximately 5 ... 10 minutes.

While data is being transferred, the LED RDY on the inverter stays red. The LED BF flashes orange with a variable frequency.

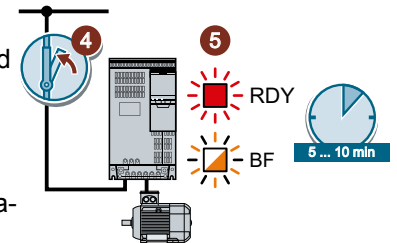

6. At the end of the transfer, the LED RDY and BF slowly flash red (0.5 Hz).

Power supply failure during transfer

The inverter firmware will be incomplete if the power supply fails during the transfer.

- Start again with Step 1 of these instructions.

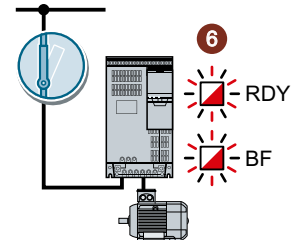

9.4 Firmware upgrade and downgrade

7. Switch off the inverter power supply.

8. Wait until all LEDs on the inverter are dark.

Decide whether you want to withdraw the memory card from the inverter:

- The memory card contains a data backup:
⇒ The inverter has taken the settings from the memory card.
- There was no data backup on the memory card:
⇒ The inverter has the factory setting.

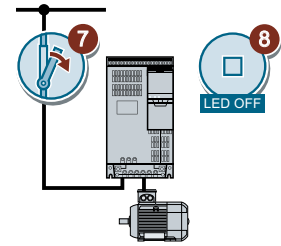

9. Switch on the inverter power supply again.

10. If the firmware downgrade was successful, after several seconds the inverter LED RDY turns green.

If the memory card is still inserted, depending on the previous content of the memory card, one of the two following cases has occurred:

- The memory card contains a data backup:
⇒ The inverter has taken the settings from the memory card.
- There was no data backup on the memory card:
⇒ The inverter has the factory setting.

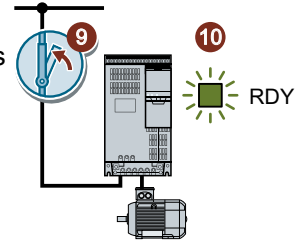

11. If the memory card did not contain a data backup of the inverter settings, then you must transfer your settings to the inverter from another data backup.

 Saving the settings and series commissioning (Page 361)

You have replaced the inverter firmware by an older version.

□

Memory cards with license

If the memory card includes a license, e.g. for the basic positioner, then the memory card must remain inserted after the firmware has been updated.

9.4.3 Correcting an unsuccessful firmware upgrade or downgrade

How does the inverter signal an unsuccessful upgrade or downgrade?

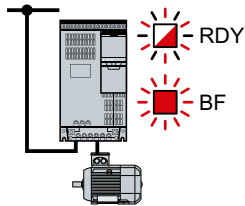

The inverter signals an unsuccessful firmware upgrade or downgrade by a quickly flashing LED RDY and the lit LED BF.

Correcting an unsuccessful upgrade or downgrade

You can check the following to correct an unsuccessful firmware upgrade or downgrade:

- Does the firmware version of your inverter fulfill the preconditions?
 - For an upgrade, as a minimum V4.5.
 - For a downgrade, as a minimum V4.6.
- Have you correctly inserted the card?
- Does the card contain the correct firmware?
- Repeat the appropriate procedure.

9.5 Reduced acceptance after a component has been replaced and a firmware change

After a component has been replaced or the firmware updated, a reduced acceptance test of the safety functions must be performed.

Table 9-1 Reduced acceptance test after component replacement

Measure	Acceptance test	Documentation
Replacing the Control Unit or the inverter with an identical type	An acceptance test for the safety functions is not required. Only check the direction of rotation of the motor.	<ul style="list-style-type: none"> • Supplement the inverter data • Document the modified checksum and time stamp ¹⁾ • Countersignature
Replacing a Power Module with an identical type		Supplement the hardware version in the inverter data.
Replacing the motor with an identical pole pair number		No change
Replace the gearbox with an identical ratio		
Replacing the Safe Brake Relay	Check the SBC function.	Supplement the hardware version in the inverter data.
Replacing safety-related I/O devices (e.g. Emergency Stop switch).	Check the control of the safety functions affected by the components that have been replaced.	No change
Inverter firmware update	An acceptance test for the safety functions is not required. Check as to whether the firmware update was successful and the inverter functions as expected.	<ul style="list-style-type: none"> • Supplement firmware version in the inverter data • Document the modified checksum and time stamp ¹⁾ • Countersignature

¹⁾ The inverter changes the following parameters after replacing inverter components and after a firmware update:

- checksum r9781
- time stamp r9782



Acceptance - completion of commissioning (Page 256)

9.6 If the converter no longer responds

If the inverter no longer responds

For example, when loading an incorrect file from the memory card, the inverter can go into a state where it can no longer respond to commands from the operator panel or from a higher-level control system. In this case, you must reset the inverter to its factory setting and recommission it. This inverter state is manifested in two different ways:

Case 1

- The motor is switched off.
- You cannot communicate with the inverter, either via the operator panel or other interfaces.
- The LEDs flicker and after 3 minutes the inverter has still not powered up.

Procedure

1. Remove the memory card if one is inserted in the inverter.
2. Switch off the inverter power supply.
3. Wait until all LEDs on the inverter are dark. Then switch on the inverter power supply again.
4. Repeat steps 2 and 3 as often as required until the inverter outputs fault F01018.
5. Set p0971 = 1.
6. Switch off the inverter power supply.
7. Wait until all LEDs on the inverter are dark. Then switch on the inverter power supply again. The inverter now powers up with the factory settings.
8. Recommission the inverter.

You have restored the inverter factory settings.

□

Case 2

- The motor is switched off.
- You cannot communicate with the inverter, either via the operator panel or other interfaces.
- The LEDs flash and are dark - this process is continually repeated.

Procedure

1. Remove the memory card if one is inserted in the inverter.
2. Switch off the inverter power supply.
3. Wait until all LEDs on the inverter are dark. Then switch on the inverter power supply again.
4. Wait until the LEDs flash orange.
5. Repeat steps 2 and 3 as often as required until the inverter outputs fault F01018.
6. Now set p0971 = 1.
7. Switch off the inverter power supply.

9.6 If the converter no longer responds

8. Wait until all LEDs on the inverter are dark. Then switch on the inverter power supply again. The inverter now powers up with the factory settings.

9. Recommission the inverter.

You have restored the inverter factory settings.

The motor cannot be switched-on

If the motor cannot be switched-on, then check the following:

- Is a fault present?
If there is, then remove the fault cause and acknowledge the fault.
- Has the inverter been completely commissioned $p0010 = 0$?
If not, the inverter is e.g. still in a commissioning state.
- Is the inverter reporting the "ready to start" status ($r0052.0 = 1$)?
- Is the inverter missing some enable signals ($r0046$)?
- How does the inverter receive its setpoint and commands?
Digital inputs, analog inputs or fieldbus?



Technical data

10.1 Technical data, CU250S-2 Control Unit

Feature	Data	
Fieldbus interfaces	CU250S-2	With RS485 interface for the following protocols: <ul style="list-style-type: none"> • USS • Modbus RTU
	CU250S-2 DP	With PROFIBUS interface
	CU250S-2 PN	With RJ45 connector for the following fieldbuses: <ul style="list-style-type: none"> • PROFINET • EtherNet/IP
	CU250S-2 CAN	With CANopen interface
Operating voltage	<p>You have two options for the Control Unit power supply:</p> <ul style="list-style-type: none"> • External supply via terminals 31 and 32 with 20.4 V ... 28.8 V DC. • Internal supply from the power module. <p>The summation of all currents of the following interfaces is limited to 0.8 A:</p> <ul style="list-style-type: none"> – Encoder power supply – DRIVE-CLiQ – Power supply for the Operator Panel – Analog outputs – 24 V output voltage (terminal 9) – 24 V PROFIBUS teleservice – Resolver excitation 	
Current drain when supplied via 31 and 32	≤1.5 A	
Power loss	12.0 W plus the power loss of all output voltages	
Output voltages	+24 V out (terminal 9)	18 V ... 26.8 V, ≤ 200 mA
	+10 V out (terminal 1)	9.5 V ... 10.5 V, ≤ 10 mA
	HTL encoder (terminal 33)	24 V, ≤ 200 mA
	HTL encoder (pins 4 and 5 of the Sub-D connector on the lower side of the Control Unit)	24 V, ≤ 350 mA
	TTL encoder (pins 4 and 5 of the Sub-D connector on the lower side of the Control Unit)	4.75 V ... 5.25 V, ≤ 350 mA
Setpoint resolution	0.01 Hz	
Maximum frequency of the HTL encoder	500 kHz	

Article numbers:
 Overview of Control Units (Page 33)

Feature	Data	
Digital inputs	11 fixed	<ul style="list-style-type: none"> • DI 0 ... DI 6 and DI 16 ... DI 19 • Electrically isolated
	4 can be switched over	<ul style="list-style-type: none"> • DI 24 ... DI 27 • Not isolated
	Common data	<ul style="list-style-type: none"> • Voltage: ≤ 30 V • Voltage for "low" state: < 5 V • Voltage for "high" state: > 11 V • Current for 24 V input voltage: 2.7 mA ... 4.7 mA • Minimum current for the "high" state: 1.8 mA ... 3.9 mA • Compatible to SIMATIC outputs • Response time for debounce time p0724 = 0. 10 ms
Pulse inputs	4 (DI 24 ... DI27)	Input frequency ≤ 32 kHz
Analog inputs	2 (AI 0, AI 1)	<ul style="list-style-type: none"> • Differential inputs • Resolution: 13 bit (12 bits plus sign) • Response time: 13 ms \pm 1 ms • AI 0 and AI 1 can be switched over: <ul style="list-style-type: none"> – 0 V ... 10 V or -10 V ... +10 V (typical power consumption: 0.1 mA, voltage < 35 V) – 0 mA ... 20 mA (120 Ω input resistance, voltage < 10 V, current < 80 mA) • If AI 0 and AI 1 are configured as supplementary digital inputs: Voltage < 35 V, low < 1.6 V, high > 4.0 V, 13 ms \pm 1 ms response time for debounce time p0724 = 0.
Digital outputs	3 fixed	<ul style="list-style-type: none"> • DO 0 ... DO 2: Relay outputs, 30 VDC / ≤ 0.5 A with resistive load <p>For applications that require UL certification, the voltage at DO 0 ... DO 2 must not exceed 30 VDC referred to ground potential and must be supplied via a grounded Class-2-power supply.</p>
	4 can be switched over	<ul style="list-style-type: none"> • DO 24 ... DO27: Transistor outputs • Output current: ≤ 0.1 A per output • Output current for "low" state: ≤ 0.5 mA • An external power supply is required via terminals 31 and 32 • Update time: 2 ms
Analog outputs	2 (AO 0, AO 1)	<ul style="list-style-type: none"> • 0 V ... 10 V or 0 mA ... 20 mA • Reference potential: "GND" • Resolution: 16 bit • Update time: 4 ms

Feature	Data	
Encoder input	HTL, TTL	Input frequency: ≤ 500 kHz
	SSI	Baud rate: ≤ 1 MHz The dependency on baud rate and cable length is shown in the diagram below.
	Resolver	<ul style="list-style-type: none"> Ratio $\ddot{u} = 0.3 \dots 0.7$ Resolvers with ratios $\ddot{u} < 0.3$ or $\ddot{u} > 0.7$ reduce the accuracy of the speed sensing and the resolution of the position actual value. Excitation voltage for $\ddot{u} = 0.5$: $1.8 V_{rms}$ Excitation frequency, synchronized to the current controller clock cycle: 8 kHz The impedances that can be connected and the maximum speed that can be evaluated are listed below.
Temperature sensor	PTC	<ul style="list-style-type: none"> Short-circuit monitoring $< 20 \Omega$ Overtemperature 1650Ω
	KTY84	<ul style="list-style-type: none"> Short-circuit monitoring $< 50 \Omega$ Wire-break: $> 2120 \Omega$
	Pt1000	<ul style="list-style-type: none"> Short-circuit monitoring $< 603 \Omega$ Wire-break $> 2120 \Omega$
	Temperature switch with NC contact	
Failsafe digital input for enabled Basic Functions	1 (DI 4 and DI 5)	<ul style="list-style-type: none"> Maximum input voltage: 30 V, 5.5 mA Response time: <ul style="list-style-type: none"> Typical: 5 ms + debounce time p9651 Typical, if debounce time = 0: 6 ms Worst-case scenario: 15 ms + debounce time Worst case, if debounce time = 0: 16 ms You can find the failsafe inputs of the Extended safety functions in the "Safety Integrated" function manual.  Overview of the manuals (Page 519)
	PFH	$5 \times 10E-8$ Probability of failure of the safety functions (probability of failure per hour – PFH)
USB interface	Mini-B	
Dimensions (WxHxD)	73 mm \times 199 mm \times 63 mm	The depth specification is valid when mounting on the Power Module.
Weight	0.49 kg	
Memory cards	Slot for SD or MMC memory cards  Memory cards (Page 362)	
Operating temperature	-10° C ... 50° C	Without inserted Operator Panel
	0 °C ... 50 °C	With inserted BOP-2 or IOP-2 operator panel
Observe any possible restrictions regarding the operating temperature as a result of the Power Module.		
Storage temperature	- 40° C ... 70° C	
Relative humidity	< 95%	Condensation is not permissible.

Permissible encoder cable lengths

Permissible cable lengths depend on the encoder type and the encoder cable.

Table 10-1 Maximum cable length:

TTL encoder	100 m
HTL encoder with bipolar signals (differential signals)	300 m
HTL encoder with unipolar signals	100 m
SSI encoder	100 m
DRIVE-CLiQ with MC800	50 m
DRIVE-CLiQ with MC500	100 m

We recommend that SIEMENS cables are connected using DRIVE-CLiQ components.

For SSI encoders, the permissible cable length also depends on the baud rate.

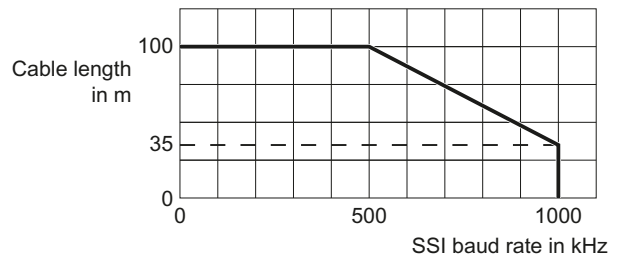

Maximum speeds that can be evaluated by a resolver

Resolver		Maximum speed that can be evaluated by the resolver	
No. of poles	Number of pole pairs	Pulse frequency = 4 kHz	Pulse frequency = 2 kHz
2-pole	1	60000 rpm	30000 rpm
4-pole	2	30000 rpm	15000 rpm
6-pole	3	20000 rpm	10000 rpm
8-pole	4	15000 rpm	7500 rpm

Impedances that can be connected at the resolver input

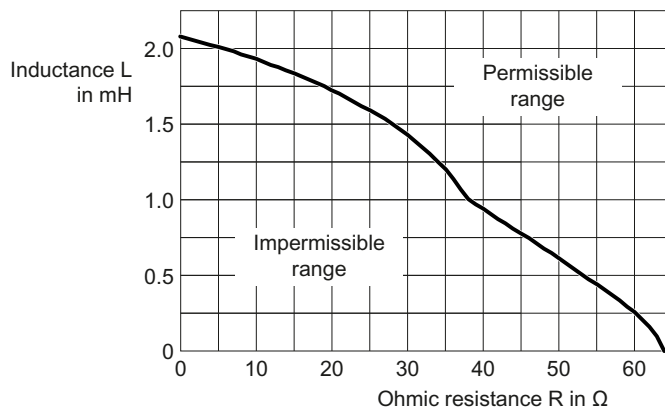

Figure 10-1 Connectable impedances with an excitation frequency of $f = 8\text{kHz}$

10.2 Overload capability of the inverter

Overload capability is the property of the inverter to temporarily supply a current that is higher than the rated current to accelerate a load. Two typical load cycles are defined to clearly demonstrate the overload capability: "Low Overload" and "High Overload"

Definitions

Base load

Constant load between the accelerating phases of the drive

Low Overload

- **LO base load input current**
Permissible input current for a "Low Overload" load cycle
- **LO base load output current**
Permissible output current for a "Low Overload" load cycle
- **LO base load power**
Rated power based on the LO base load output current

High Overload

- **HO base load input current**
Permissible input current for a "High Overload" load cycle
- **HO base load output current**
Permissible output current for a "High Overload" load cycle
- **HO base load power**
Rated power based on the HO base load output current

If not specified otherwise, the power and current data in the technical data always refer to a load cycle according to Low Overload.

We recommend the "SIZER" engineering software to select the inverter.

You can find additional information about SIZER on the Internet:

 Download SIZER (<http://support.automation.siemens.com/WW/view/en/10804987/130000>)

Load cycles and typical applications:

"Low Overload" load cycle

The "Low Overload" load cycle assumes a uniform base load with low requirements placed on brief accelerating phases. Typical applications when designing according to "Low Overload" include:

- Pumps, fans and compressors
- Wet or dry blasting technology
- Mills, mixers, kneaders, crushers, agitators
- Basic spindles
- Rotary kilns
- Extruders

"High Overload" load cycle

The "High Overload" load cycle permits, for reduced base load, dynamic accelerating phases. Typical applications when designing according to "High Overload" include:

- Horizontal and vertical conveyor technology (conveyor belts, roller conveyors, chain conveyors)
- Centrifuges
- Escalators/moving stairways
- Lifters/Lowerers
- Elevators
- Gantry cranes
- Cable railways
- Storage and retrieval machines

10.3 Technical data, PM240-2 Power Modules

Protective devices for the Power Module

The fuses listed in the following tables are examples of suitable fuses.

Additional components for branch protection are available in the Internet:

 Branch protection and short-circuit strength according to UL and IEC (<https://support.industry.siemens.com/cs/ww/en/view/109479152>)

10.3.1 High overload - low overload PM240-2

Typical inverter load cycles

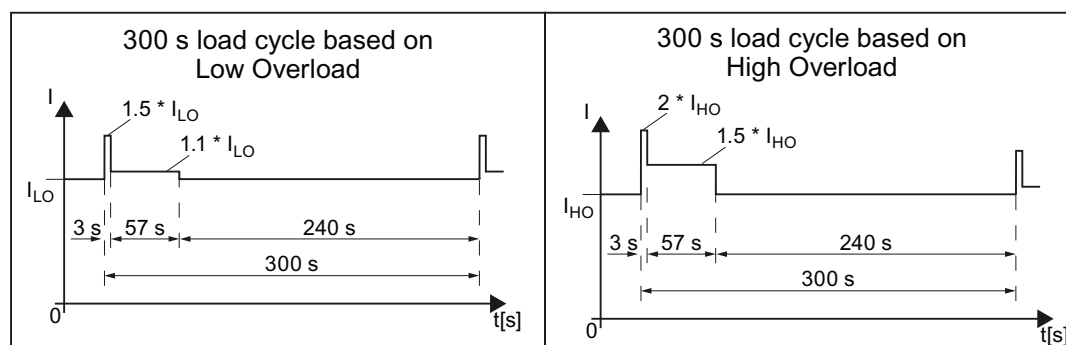





Figure 10-2 "Low Overload" and "High Overload" load cycles

10.3.2 Ambient conditions



Property	Version
Ambient conditions for transport in the transport packaging	
Climatic ambient conditions	- 40 °C ... + 70 °C, according to Class 2K4 to EN 60721-3-2 maximum humidity 95% at 40 °C
Mechanical ambient conditions	Shock and vibration permissible according to 1M2 to EN 60721-3-2
Protection against chemical substances	Protected according to Class 2C2 to EN 60721-3-2
Biological ambient conditions	Suitable according to Class 2B1 to EN 60721-3-2
Ambient conditions for long-term storage in the product packaging	
Climatic ambient conditions	- 25 °C ... + 55 °C, according to Class 1K3 to EN 60721-3-1
Protection against chemical substances	Protected according to Class 1C2 to EN 60721-3-1

Property	Version
Biological ambient conditions	Suitable according to class 1B1 to EN 60721-3-1
Ambient conditions in operation	
Installation altitude	Up to 1000 m above sea level without limitations  Restrictions for special ambient conditions (Page 478)
Climatic ambient conditions ¹⁾	<ul style="list-style-type: none"> • FSA ... FSC ambient operating temperature²⁾ <ul style="list-style-type: none"> – For operation according to Low Overload: -10 °C ... +40 °C – For operation according to High Overload: -10 °C ... +50 °C –  Restrictions for special ambient conditions (Page 478) • FSD ... FSG ambient operating temperature²⁾ <ul style="list-style-type: none"> – For operation according to Low Overload: -20 °C ... +40 °C – For operation according to High Overload: -20 °C ... +50 °C –  Restrictions for special ambient conditions (Page 478) • Relative humidity: 5 ... 95%, condensation not permitted • Oil mist, salt mist, ice formation, condensation, dripping water, spraying water, splashing water and water jets are not permitted
Mechanical ambient conditions	Vibration test during operation according to IEC 60068-2-6 Test Fc (sinusoidal) <ul style="list-style-type: none"> • 0 ... 57 Hz: 0.075 mm deflection amplitude • 57 ... 150 Hz: 1 g acceleration amplitude • 10 frequency cycles per axis Shock test according to IEC 60068-2-27 Test Ea (half-sine) <ul style="list-style-type: none"> • 5 g peak acceleration • 30 ms duration • 3 shocks in all three axes in both directions
Protection against chemical substances	<ul style="list-style-type: none"> • FSA ... FSC: Protected according to 3C2 to EN 60721-3-3 • FSD ... FSG: 3C3 protection according to EN 60721-3-3
Biological ambient conditions	Suitable according to 3B1 to EN 60721-3-3
Pollution	Suitable for environments with degree of pollution 2 according to EN 61800-5-1
Cooling	Forced air cooling AF, according to EN 60146
Cooling air	Clean and dry air
Noise emission	Maximum 75 db(A)

¹⁾ Increased ruggedness regarding temperature range and relative humidity; therefore better than 3K3 according to EN 60721-3-3

²⁾ Observe the permissible ambient operating temperatures for the Control Unit and the Operator Panel (IOP-2 or BOP-2).

10.3.3 General technical data, 200 V inverters

Property	Version
Line voltage	FSA ... FSC 200 V ... 240 V 1 AC ± 10% 0.55 kW ... 4 kW - LO 0.37 kW ... 3 kW - HO
	200 V ... 240 V 3 AC ± 10% 0.55 kW ... 7.5 kW - LO 0.37 kW ... 5.5 kW - HO
	FSD ... FSF 200 V ... 240 V 3 AC ± 10% (in operation -20% < 1 min)
Line supply configurations	Grounded TN/TT line supplies or non-grounded IT line supplies  Permissible line supplies (Page 72)
Line impedance	FSA ... FSC 2% ≤ Uk < 4%. For Uk < 2%, we recommend a line reactor, or a Power Module with the next higher power rating.
	FSD ... FSF No restrictions
Power factor λ	FSA ... FSC 0.7 without line reactor for Uk ≥ 2% 0.85 with line reactor for Uk < 2%
	FSD ... FSF > 0.9
Output voltage	0 V 3 AC ... 0.95 × input voltage
Input frequency	50 Hz ... 60 Hz, ± 3 Hz
Output frequency	0 ... 550 Hz, depending on the control mode
Inrush current	< LO base load input current
Overvoltage category according to EN 61800-5-1	III for line supplies
Pulse frequency	4 kHz (factory setting), Adjustable in steps of 2 kHz.
	 Current reduction as a function of the pulse frequency (Page 455) If you increase the pulse frequency, the inverter reduces the maximum output current.
Short-circuit current (SCCR) and branch protection	Maximum permissible line short-circuit current ≤ 100 kA rms Minimum required short-circuit current ≥ 5 kA rms The length of the connecting cable from the line to the inverter may not reduce the minimum short-circuit current
	 Branch protection and short-circuit strength according to UL and IEC (https://support.industry.siemens.com/cs/ww/en/view/109479152)
Braking methods	DC braking, compound braking, dynamic braking with integrated braking chopper
Degree of protection according to EN 60529	IP20
	IP55 PT devices outside the control cabinet
Protection class according to EN 61800-5-1	The inverters are devices with protection class I
Touch protection according to EN 50274	DGUV regulation 3 when used for the intended purpose
Cooling in compliance with EN 60146	Forced air cooling AF

10.3.4 Specific technical data, 200 V inverters

Table 10-2 PM240-2, IP20, frame size A, 200 V ... 240 V 1 AC / 3 AC

Article No. without filter	6SL3210-1PB13-0UL0	6SL3210-1PB13-8UL0
Article No. with filter	6SL3210-1PB13-0AL0	6SL3210-1PB13-8AL0
LO base load power	0.55 kW	0.75 kW
1 AC LO base load input current	7.5 A	9.6 A
3 AC LO base load input current	4.2 A	5.5 A
LO base load output current	3.2 A	4.2 A
HO base load power	0.37 kW	0.55 kW
1 AC HO base load input current	6.6 A	8.4 A
3 AC HO base load input current	3.0 A	4.2 A
HO base load output current	2.3 A	3.2 A
Fuse according to IEC	3NA3805 (16 A)	3NA3805 (16 A)
Fuse according to UL, class J	15 A	15 A
Power loss	0.04 kW	0.04 kW
Required cooling air flow	5 l/s	5 l/s
Weight without filter	1.4 kg	1.4 kg
Weight with filter	1.6 kg	1.6 kg

Table 10-3 PM240-2, PT, frame size A, 200 V ... 240 V 1 AC / 3 AC

Article No. without filter	6SL3211-1PB13-8UL0
Article No. with filter	6SL3211-1PB13-8AL0
LO base load power	0.75 kW
1 AC LO base load input current	9.6 A
3 AC LO base load input current	5.5 A
LO base load output current	4.2 A
HO base load power	0.55 kW
1 AC HO base load input current	8.4 A
3 AC HO base load input current	4.2 A
HO base load output current	3.2 A
Fuse according to IEC	3NA3 805 (16 A)
Fuse according to UL, class J	15 A
Power loss	0.04 kW
Required cooling air flow	5 l/s
Weight without filter	1.8 kg
Weight with filter	2.0 kg

Table 10-4 PM240-2, IP20, frame size B, 200 V ... 240 V 1 AC / 3 AC

Article No. without filter	6SL3210-1PB15-5UL0	6SL3210-1PB17-4UL0	6SL3210-1PB21-0UL0
Article No. with filter	6SL3210-1PB15-5AL0	6SL3210-1PB17-4AL0	6SL3210-1PB21-0AL0
LO base load power	1.1 kW	1.5 kW	2.2 kW
1 AC LO base load input current	13.5 A	18.1 A	24.0 A
3 AC LO base load input current	7.8 A	9.7 A	13.6 A
LO base load output current	6 A	7.4 A	10.4 A
HO base load power	0.75 kW	1.1 kW	1.5 kW
1 AC HO base load input current	11.8 A	15.8 A	20.9 A
3 AC HO base load input current	5.5 A	7.8 A	9.7 A
HO base load output current	4.2 A	6 A	7.4 A
Fuse according to IEC	3NA3812 (32 A)	3NA3812 (32 A)	3NA3812 (32 A)
Fuse according to UL, class J	35 A	35 A	35 A
Power loss	0.05 kW	0.07 kW	0.12 kW
Required cooling air flow	9.2 l/s	9.2 l/s	9.2 l/s
Weight without filter	2.8 kg	2.8 kg	2.8 kg
Weight with filter	3.1 kg	3.1 kg	3.1 kg

Table 10-5 PM240-2, PT, frame size B, 200 V ... 240 V 1 AC / 3 AC

Article No. without filter	6SL3211-1PB21-0UL0
Article No. with filter	6SL3211-1PB21-0AL0
LO base load power	2.2 kW
1 AC LO base load input current	24.0 A
3 AC LO base load input current	13.6 A
LO base load output current	10.4 A
HO base load power	1.5 kW
1 AC HO base load input current	20.9 A
3 AC HO base load input current	9.7 A
HO base load output current	7.4 A
Fuse according to IEC	3NA3812 (32 A)
Fuse according to UL, class J	35 A
Power loss	0.12 kW ¹⁾
Required cooling air flow	9.2 l/s
Weight without filter	3.4 kg
Weight with filter	3.7 kg

¹⁾ approx. 0.08 kW through the heat sink

Technical data

10.3 Technical data, PM240-2 Power Modules

Table 10-6 PM240-2, IP 20, frame size C, 200 V ... 240 V 1 AC / 3 AC

Article No. without filter	6SL3210-1PB21-4UL0	6SL3210-1PB21-8UL0
Article No. with filter	6SL3210-1PB21-4AL0	6SL3210-1PB21-8AL0
LO base load power	3 kW	4 kW
1 AC LO base load input current	35.9 A	43.0 A
3 AC LO base load input current	17.7 A	22.8 A
LO base load output current	13.6 A	17.5 A
HO base load power	2.2 kW	3 kW
1 AC HO base load input current	31.3 A	37.5 A
3 AC HO base load input current	13.6 A	17.7 A
HO base load output current	10.4 A	13.6 A
Fuse according to IEC	3NA3820 (50 A)	3NA3820 (50 A)
Fuse according to UL, class J	50 A	50 A
Power loss	0.14 kW	0.18 kW
Required cooling air flow	18.5 l/s	18.5 l/s
Weight without filter	5.0 kg	5.0 kg
Weight with filter	5.2 kg	5.2 kg

Table 10-7 PM240-2, PT, frame size C, 200 V ... 240 V 1 AC / 3 AC

Article No. without filter	6SL3211-1PB21-8UL0
Article No. with filter	6SL3211-1PB21-8AL0
LO base load power	4 kW
1 AC LO base load input current	43.0 A
3 AC LO base load input current	22.8 A
LO base load output current	17.5 A
HO base load power	3 kW
1 AC HO base load input current	37.5 A
3 AC HO base load input current	17.7 A
HO base load output current	13.6 A
Fuse according to IEC	3NA3820 (50 A)
Fuse according to UL, class J	50 A
Power loss	0.18 kW ¹⁾
Required cooling air flow	18.5 l/s
Weight without filter	5.9 kg
Weight with filter	6.2 kg

¹⁾ approx. 0.09 kW through the heat sink

Table 10-8 PM240-2, IP 20, frame size C, 200 V ... 240 V 3 AC

Article No. without filter Article No. with filter	6SL3210-1PC22-2UL0 6SL3210-1PC22-2AL0	6SL3210-1PC22-8UL0 6SL3210-1PC22-8AL0
LO base load power	5.5 kW	7.5 kW
LO base load input current	28.6 A	36.4 A
LO base load output current	22.0 A	28.0 A
HO base load power	4 kW	5.5 kW
HO base load input current	22.8 A	28.6 A
HO base load output current	17.5 A	22.0 A
Fuse according to IEC	3NA3820 (50 A)	3NA3820 (50 A)
Fuse according to UL, class J	50 A	50 A
Power loss	0.2 kW	0.26 kW
Required cooling air flow	18.5 l/s	18.5 l/s
Weight without filter	5.0 kg	5.0 kg
Weight with filter	5.2 kg	5.2 kg

Table 10-9 PM240-2, PT, frame size C, 200 V ... 240 V 3 AC

Article No. without filter Article No. with filter	6SL3211-1PC22-2UL0 6SL3211-1PC22-2AL0	6SL3211-1PC22-8UL0 6SL3211-1PC22-8AL0
LO base load power	5.5 kW	7.5 kW
LO base load input current	28.6 A	36.4 A
LO base load output current	22.0 A	28.0 A
HO base load power	4 kW	5.5 kW
HO base load input current	22.8 A	28.6 A
HO base load output current	17.5 A	22.0 A
Fuse according to IEC	3NA3820 (50 A)	3NA3820 (50 A)
Fuse according to UL, class J	50 A	50 A
Power loss	0.2 kW ¹⁾	0.26 kW ²⁾
Required cooling air flow	18.5 l/s	18.5 l/s
Weight without filter	5.9 kg	5.9 kg
Weight with filter	6.2 kg	6.2 kg

¹⁾ approx. 0.2 kW through the heatsink

²⁾ approx. 0.25 kW through the heatsink

Technical data

10.3 Technical data, PM240-2 Power Modules

Table 10-10 PM240-2, IP20, frame size D, 200 V ... 240 V 3 AC

Article No. without filter	6SL3210-1PC24-2UL0	6SL3210-1PC25-4UL0	6SL3210-1PC26-8UL0
LO base load power	11 kW	15 kW	18.5 kW
LO base load input current	40 A	51 A	64 A
LO base load output current	42 A	54 A	68 A
HO base load power	7.5 kW	11 kW	15 kW
HO base load input current	36 A	43 A	56 A
HO base load output current	35 A	42 A	54 A
Fuse according to IEC	3NA3822 (63 A)	3NA3824 (80 A)	3NA3830 (100 A)
Fuse according to UL, class J	60 A	70 A	90 A
Power loss	0.45 kW	0.61 kW	0.82 kW
Required cooling air flow	55 l/s	55 l/s	55 l/s
Weight	17 kg	17 kg	17 kg

Table 10-11 PM240-2, PT, frame size D, 200 V ... 240 V 3 AC

Article No. without filter	6SL3211-1PC26-8UL0
LO base load power	18.5 kW
LO base load input current	64 A
LO base load output current	68 A
HO base load power	15 kW
HO base load input current	56 A
HO base load output current	54 A
Fuse according to IEC	3NA3830 (100 A)
Fuse according to UL, class J	90 A
Power loss	0.82 kW ¹⁾
Required cooling air flow	55 l/s
Weight	19.5 kg

¹⁾ approx. 0.72 kW through the heatsink

Table 10-12 PM240-2, IP20, frame size E, 200 V ... 240 V 3 AC

Article No. without filter	6SL3210-1PC28-0UL0	6SL3210-1PC31-1UL0
LO base load power	22 kW	30 kW
LO base load input current	76 A	98 A
LO base load output current	80 A	104 A
HO base load power	18.5 kW	22 kW
HO base load input current	71 A	83 A
HO base load output current	68 A	80 A
Fuse according to IEC	3NA3830 (100 A)	3NA3836 (160 A)
Fuse according to UL, class J	100 A	150 A
Power loss	0.92 kW	1.28 kW
Required cooling air flow	83 l/s	83 l/s
Weight	26 kg	26 kg

Table 10-13 PM240-2, PT, frame size E, 200 V to 240 V 3 AC

Article No. without filter	6SL3211-1PC31-1UL0
LO base load power	30 kW
LO base load input current	98 A
LO base load output current	104 A
HO base load power	22 kW
HO base load input current	83 A
HO base load output current	80 A
Fuse according to IEC	3NA3836 (160 A)
Fuse according to UL, class J	150 A
Power loss	1.28 kW ¹⁾
Required cooling air flow	83 l/s
Weight	29 kg

¹⁾ approx. 1.1 kW through the heatsink

Technical data

10.3 Technical data, PM240-2 Power Modules

Table 10-14 PM240-2, IP20, frame size F, 200 V ... 240 V 3 AC

Article No. without filter	6SL3210-1PC31-3UL0	6SL3210-1PC31-6UL0	6SL3210-1PC31-8UL0
LO base load power	37 kW	45 kW	55 kW
LO base load input current	126 A	149 A	172 A
LO base load output current	130 A	154 A	178 A
HO base load power	30 kW	37 kW	45 kW
HO base load input current	110 A	138 A	164 A
HO base load output current	104 A	130 A	154 A
Fuse according to IEC	3NA3140 (200 A)	3NA3140 (200 A)	3NA3142 (224 A)
Fuse according to UL, class J	175 A	200 A	250 A
Power loss	1.38 kW	1.72 kW	2.09 kW
Required cooling air flow	153 l/s	153 l/s	153 l/s
Weight	57 kg	57 kg	57 kg

Table 10-15 PM240-2, PT, frame size F, 200 V to 240 V 3 AC

Article No. without filter	6SL3211-1PC31-8UL0
LO base load power	55 kW
LO base load input current	172 A
LO base load output current	178 A
HO base load power	45 kW
HO base load input current	164 A
HO base load output current	154 A
Fuse according to IEC	3NA3142 (224 A)
Fuse according to UL, class J	250 A
Power loss	2.09 kW ¹⁾
Required cooling air flow	153 l/s
Weight	60 kg

¹⁾ approx. 1.9 kW through the heatsink





10.3.5 Current derating depending on the pulse frequency, 200 V inverters

Article number	LO power [kW]	Pulse frequency [kHz]							
		2	4 *)	6	8	10	12	14	16
		LO base load output current [A]							
6SL3210-1PB13-0 . L0	0.55	3.2	3.2	2.7	2.2	1.9	1.6	1.4	1.3
6SL321 . -1PB13-8 . L0	0.75	4.2	4.2	3.6	2.9	2.5	2.1	1.9	1.7
6SL3210-1PB15-5 . L0	1.1	6	6	5.1	4.2	3.6	3	2.7	2.4
6SL3210-1PB17-4 . L0	1.5	7.4	7.4	6.3	5.2	4.4	3.7	3.3	3
6SL321 . -1PB21-0 . L0	2.2	10.4	10.4	8.8	7.3	6.2	5.2	4.7	4.2
6SL3210-1PB21-4 . L0	3	13.6	13.6	11.6	9.5	8.2	6.8	6.1	5.4
6SL321 . -1PB21-8 . L0	4	17.5	17.5	14.9	12.3	10.5	8.8	7.9	7
6SL3210-1PC22-2 . L0	5.5	22	22	18.7	15.4	13.2	11	9.9	8.8
6SL3210-1PC22-8 . L0	7.5	28	28	23.8	19.6	16.8	14	12.6	11.2
6SL3210-1PC24-2UL0	11	42	42	35.7	29.4	25.2	21	18.9	16.8
6SL3210-1PC25-4UL0	15	54	54	45.9	37.8	32.4	27	24.3	21.6
6SL321 . -1PC26-8UL0	18.5	68	68	57.8	47.6	40.8	34	30.6	27.2
6SL3210-1PC28-0UL0	22	80	80	68	56	48	40	36	32
6SL321 . -1PC31-1UL0	30	104	104	88.4	72.8	62.4	52	46.8	41.6
6SL3210-1PC31-3UL0	37	130	130	110.5	91	---	---	---	---
6SL3210-1PC31-6UL0	45	154	154	130.9	107.8	---	---	---	---
6SL321 . -1PC31-8UL0	55	178	178	151.3	124.6	---	---	---	---

*) Factory setting

The permissible motor cable length depends on the particular cable type and the pulse frequency that has been selected

10.3.6 General technical data, 400 V inverters

Property	Version
Line voltage	FSA ... FSC 380 V ... 480 V 3 AC \pm 10%
	FSD ... FSG 380 V ... 480 V 3 AC \pm 10% (in operation -20% < 1 min)
Line supply configurations	 Grounded TN/TT line supplies or non-grounded IT line supplies  Permissible line supplies (Page 72)
Line impedance	FSA ... FSC 1% \leq Uk < 4%, for values smaller than 1%, we recommend a line reactor, or a Power Module with the next higher power rating.
	FSD ... FSG No restrictions
Power factor λ	FSA ... FSC 0.7 without line reactor for Uk \geq 1% 0.85 with line reactor for Uk < 1%
	FSD ... FSG > 0.9
Output voltage	0 V 3 AC ... 0.95 x input voltage (max.)
Input frequency	50 Hz ... 60 Hz, \pm 3 Hz
Output frequency	0 ... 550 Hz, depending on the control mode
Inrush current	< LO base load input current
Overvoltage category according to EN 61800-5-1	III for line supplies
Pulse frequency	Factory setting
	<ul style="list-style-type: none"> • 4 kHz for devices with an LO base load power < 110 kW • 2 kHz for devices with an LO base load power \geq 110 kW Can be adjusted in 2 kHz steps as follows: <ul style="list-style-type: none"> • 2 kHz ... 16 kHz for devices with an LO base load power < 55 kW • 2 kHz ... 8 kHz for devices with an LO base load output of 55 kW ... 90 kW and \geq 160 kW • 2 kHz ... 4 kHz for devices with an LO base load power of 110 kW ... 132 kW  Current reduction as a function of the pulse frequency (Page 465)
Short-circuit current (SCCR) and branch protection	Maximum permissible line short-circuit current \leq 100 kA rms
	Minimum required short-circuit current \geq 18 kA rms The length of the connecting cable from the line to the inverter may not reduce the minimum short-circuit current  Branch protection and short-circuit strength according to UL and IEC (https://support.industry.siemens.com/cs/ww/en/view/109479152)
Braking methods	DC braking, compound braking, dynamic braking with integrated braking chopper
Degree of protection according to EN 60529	IP20
	IP55 PT devices outside the control cabinet
Protection class according to EN 61800-5-1	The inverters are devices with protection class I
Touch protection according to EN 50274	DGUV regulation 3 when used for the intended purpose
Cooling in compliance with EN 60146	Forced air cooling AF

10.3.7 Specific technical data, 400 V inverters

Table 10-16 PM240-2, IP20, frame size A, 380 V ... 480 V 3 AC

Article No. without filter	6SL3210-1PE11-8UL1	6SL3210-1PE12-3UL1	6SL3210-1PE13-2UL1
Article No. with filter	6SL3210-1PE11-8AL1	6SL3210-1PE12-3AL1	6SL3210-1PE13-2AL1
LO base load power	0.55 kW	0.75 kW	1.1 kW
LO base load input current	2.3 A	2.9 A	4.1 A
LO base load output current	1.7 A	2.2 A	3.1 A
HO base load power	0.37 kW	0.55 kW	0.75 kW
HO base load input current	2.0 A	2.6 A	3.3 A
HO base load output current	1.3 A	1.7 A	2.2 A
Fuse according to IEC	3NA3805 (16 A)	3NA3805 (16 A)	3NA3805 (16 A)
Fuse according to UL, class J	10 A	10 A	15 A
Power loss	0.04 kW	0.04 kW	0.04 kW
Required cooling air flow	5 l/s	5 l/s	5 l/s
Weight without filter	1.3 kg	1.3 kg	1.3 kg
Weight with filter	1.5 kg	1.5 kg	1.5 kg

Table 10-17 PM240-2, IP20, frame size A, 380 V ... 480 V 3 AC

Article No. without filter	6SL3210-1PE14-3UL1	6SL3210-1PE16-1UL1	6SL3210-1PE18-0UL1
Article No. with filter	6SL3210-1PE14-3AL1	6SL3210-1PE16-1AL1	6SL3210-1PE18-0AL1
LO base load power	1.5 kW	2.2 kW	3.0 kW
LO base load input current	5.5 A	7.7 A	10.1 A
LO base load output current	4.1 A	5.9 A	7.7 A
HO base load power	1.1 kW	1.5 kW	2.2 kW
HO base load input current	4.7 A	6.1 A	8.8 A
HO base load output current	3.1 A	4.1 A	5.9 A
Fuse according to IEC	3NA3805 (16 A)	3NA3805 (16 A)	3NA3805 (16 A)
Fuse according to UL, class J	20 A	30 A	30 A
Power loss	0.07 kW	0.1 kW	0.12 kW
Required cooling air flow	5 l/s	5 l/s	5 l/s
Weight without filter	1.4 kg	1.4 kg	1.4 kg
Weight with filter	1.6 kg	1.6 kg	1.6 kg

Technical data

10.3 Technical data, PM240-2 Power Modules

Table 10-18 PM240-2, PT, frame size A, 380 V ... 480 V 3 AC

Article No. without filter	6SL3211-1PE18-0UL1
Article No. with filter	6SL3211-1PE18-0AL1
LO base load power	3.0 kW
LO base load input current	10.1 A
LO base load output current	7.7 A
HO base load power	2.2 kW
HO base load input current	8.8 A
HO base load output current	5.9 A
Fuse according to IEC	3NA3805 (16 A)
Fuse according to UL, class J	30 A
Power loss without filter	0.12 kW ¹⁾
Required cooling air flow	7 l/s
Weight without filter	1.8 kg
Weight with filter	2.0 kg

1) approx. 0.1 kW through the heatsink

Table 10-19 PM240-2, IP20, frame size B, 380 V ... 480 V 3 AC

Article No. without filter	6SL3210-1PE21-1UL0	6SL3210-1PE21-4UL0	6SL3210-1PE21-8UL0
Article No. with filter	6SL3210-1PE21-1AL0	6SL3210-1PE21-4AL0	6SL3210-1PE21-8AL0
LO base load power	4.0 kW	5.5 kW	7.5 kW
LO base load input current	13.3 A	17.2 A	22.2 A
LO base load output current	10.2 A	13.2 A	18.0 A
HO base load power	3.0 kW	4.0 kW	5.5 kW
HO base load input current	11.6 A	15.3 A	19.8 A
HO base load output current	7.7 A	10.2 A	13.2 A
Fuse according to IEC	3NA3812 (32 A)	3NA3812 (32 A)	3NA3812 (32 A)
Fuse according to UL, class J	35 A	35 A	35 A
Power loss	0.11 kW	0.15 kW	0.2 kW
Required cooling air flow	9.2 l/s	9.2 l/s	9.2 l/s
Weight without filter	2.9 kg	2.9 kg	3.0 kg
Weight with filter	3.1 kg	3.1 kg	3.2 kg

Table 10-20 PM240-2, PT, frame size B, 380 V ... 480 V 3 AC

Article No. without filter	6SL3211-1PE21-8UL0
Article No. with filter	6SL3211-1PE21-8AL0
LO base load power	7.5 kW
LO base load input current	22.2 A
LO base load output current	18.0 A
HO base load power	5.5 kW
HO base load input current	19.8 A
HO base load output current	13.7 A
Fuse according to IEC	3NA3812 (32 A)
Fuse according to UL, class J	35 A
Power loss	0.2 kW ¹⁾
Required cooling air flow	9.2 l/s
Weight without filter	3.6 kg
Weight with filter	3.9 kg

1) approx. 0.16 kW through the heatsink

Table 10-21 PM240-2, IP20, frame size C, 380 V ... 480 V 3 AC

Article No. without filter	6SL3210-1PE22-7UL0	6SL3210-1PE23-3UL0
Article No. with filter	6SL3210-1PE22-7AL0	6SL3210-1PE23-3AL0
LO base load power	11.0 kW	15.0 kW
LO base load input current	32.6 A	39.9 A
LO base load output current	26.0 A	32.0 A
HO base load power	7.5 kW	11.0 kW
HO base load input current	27.0 A	36.0 A
HO base load output current	18.0 A	26.0 A
Fuse according to IEC	3NA3820 (50 A)	3NA3820 (50 A)
Fuse according to UL, class J	50 A	50 A
Power loss	0.3 kW	0.37 kW
Required cooling air flow	18.5 l/s	18.5 l/s
Weight without filter	4.7 kg	4.8 kg
Weight with filter	5.3 kg	5.4 kg

Technical data

10.3 Technical data, PM240-2 Power Modules

Table 10-22 PM240-2, PT, frame size C, 380 V ... 480 V 3 AC

Article No. without filter	6SL3211-1PE23-3UL0
Article No. with filter	6SL3211-1PE23-3AL0
LO base load power	15.0 kW
LO base load input current	39.9 A
LO base load output current	32.0 A
HO base load power	11.0 kW
HO base load input current	36.0 A
HO base load output current	26.0 A
Fuse according to IEC	3NA3820 (50 A)
Fuse according to UL, class J	50 A
Power loss	0.37 kW ¹⁾
Required cooling air flow	18.5 l/s
Weight without filter	5.8 kg
Weight with filter	6.3 kg

1) approx. 0.3 kW through the heatsink

Table 10-23 PM240-2, IP20, frame size D, 380 V ... 480 V 3 AC

Article No. without filter	6SL3210-1PE23-8UL0	6SL3210-1PE24-5UL0	6SL3210-1PE26-0UL0
Article No. with filter	6SL3210-1PE23-8AL0	6SL3210-1PE24-5AL0	6SL3210-1PE26-0AL0
LO base load power	18.5 kW	22 kW	30 kW
LO base load input current	36 A	42 A	57 A
LO base load output current	38 A	45 A	60 A
HO base load power	15 kW	18.5 kW	22 kW
HO base load input current	33 A	38 A	47 A
HO base load output current	32 A	38 A	45 A
Fuse according to IEC	3NA3822 (63 A)	3NA3824 (80 A)	3NA3830 (100 A)
Fuse according to UL, class J	60 A	70 A	90 A
Power loss without filter	0.57 kW	0.70 kW	0.82 kW
Power loss with filter	0.58 kW	0.71 kW	0.83 kW
Required cooling air flow	55 l/s	55 l/s	55 l/s
Weight without filter	16 kg	16 kg	17 kg
Weight with filter	17.5 kg	17.5 kg	18.5 kg

Table 10-24 PM240-2, IP20, frame size D, 380 V ... 480 V 3 AC

Article No. without filter	6SL3210-1PE27-5UL0
Article No. with filter	6SL3210-1PE27-5AL0
LO base load power	37 kW
LO base load input current	70 A
LO base load output current	75 A
HO base load power	30 kW
HO base load input current	62 A
HO base load output current	60 A
Fuse according to IEC	3NA3830 (100 A)
Fuse according to UL, class J	100 A
Power loss without filter	1.09 kW
Power loss with filter	1.10 kW
Required cooling air flow	55 l/s
Weight without filter	17 kg
Weight with filter	18.5 kg

Table 10-25 PM240-2, PT, frame size D, 380 V ... 480 V 3 AC

Article No. without filter	6SL3211-1PE27-5UL0
Article No. with filter	6SL3211-1PE27-5AL0
LO base load power	37 kW
LO base load input current	70 A
LO base load output current	75 A
HO base load power	30 kW
HO base load input current	62 A
HO base load output current	60 A
Fuse according to IEC	3NA3830 (100 A)
Fuse according to UL, class J	100 A
Power loss without filter	1.09 kW ¹⁾
Power loss with filter	1.10 kW ¹⁾
Required cooling air flow	55 l/s
Weight without filter	20 kg
Weight with filter	21.5 kg

¹⁾ Approx. 1 kW through the heatsink

Technical data

10.3 Technical data, PM240-2 Power Modules

Table 10-26 PM240-2, IP20, frame size E, 380 V ... 480 V 3 AC

Article No. without filter	6SL3210-1PE28-8UL0	6SL3210-1PE31-1UL0
Article No. with filter	6SL3210-1PE28-8AL0	6SL3210-1PE31-1AL0
LO base load power	45 kW	55 kW
LO base load input current	86 A	104 A
LO base load output current	90 A	110 A
HO base load power	37 kW	45 kW
HO base load input current	78 A	94 A
HO base load output current	75 A	90 A
Fuse according to IEC	3NA3832 (125 A)	3NA3836 (160 A)
Fuse according to UL, class J	125 A	150 A
Power loss without filter	1.29 kW	1.65 kW
Power loss with filter	1.30 kW	1.67 kW
Required cooling air flow	83 l/s	83 l/s
Weight without filter	26 kg	26 kg
Weight with filter	28 kg	28 kg

Table 10-27 PM240-2, PT, frame size E, 380 V ... 480 V 3 AC

Article No. without filter	6SL3211-1PE31-1UL0
Article No. with filter	6SL3211-1PE31-1AL0
LO base load power	55 kW
LO base load input current	104 A
LO base load output current	110 A
HO base load power	45 kW
HO base load input current	94 A
HO base load output current	90 A
Fuse according to IEC	3NA3836 (160 A)
Fuse according to UL, class J	150 A
Power loss without filter	1.65 kW ¹⁾
Power loss with filter	1.67 kW ¹⁾
Required cooling air flow	83 l/s
Weight without filter	30.5 kg
Weight with filter	32 kg

¹⁾ Approx. 1.4 kW through the heatsink

Table 10-28 PM240-2, IP20, frame size F, 380 V ... 480 V 3 AC

Article No. without filter	6SL3210-1PE31-5UL0	6SL3210-1PE31-8UL0	6SL3210-1PE32-1UL0
Article No. with filter	6SL3210-1PE31-5AL0	6SL3210-1PE31-8AL0	6SL3210-1PE32-1AL0
LO base load power	75 kW	90 kW	110 kW
LO base load input current	140 A	172 A	198 A
LO base load output current	145 A	178 A	205 A
HO base load power	55 kW	75 kW	90 kW
HO base load input current	117 A	154 A	189 A
HO base load output current	110 A	145 A	178 A
Fuse according to IEC	3NA3140 (200 A)	3NA3142 (224 A)	3NA3250 (300 A)
Fuse according to UL, class J	200 A	250 A	300 A
Power loss without filter	1.91 kW	2.46 kW	2.28 kW
Power loss with filter	1.93 kW	2.48 kW	2.30 kW
Required cooling air flow	153 l/s	153 l/s	153 l/s
Weight without filter	57 kg	57 kg	61 kg
Weight with filter	63 kg	63 kg	65 kg

Table 10-29 PM240-2, IP20, frame size F, 380 V ... 480 V 3 AC

Article No. without filter	6SL3210-1PE32-5UL0
Article No. with filter	6SL3210-1PE32-5AL0
LO base load power	132 kW
LO base load input current	242 A
LO base load output current	250 A
HO base load power	110 kW
HO base load input current	218 A
HO base load output current	205 A
Fuse according to IEC	3NA3252 (315 A)
Fuse according to UL, class J	350 A
Power loss without filter	2.98 kW
Power loss with filter	3.02 kW
Required cooling air flow	153 l/s
Weight without filter	61 kg
Weight with filter	65 kg

Technical data

10.3 Technical data, PM240-2 Power Modules

Table 10-30 PM240-2, PT, frame size F, 380 V ... 480 V 3 AC

Article No. without filter	6SL3211-1PE32-5UL0
Article No. with filter	6SL3211-1PE32-5AL0
LO base load power	132 kW
LO base load input current	242 A
LO base load output current	250 A
HO base load power	110 kW
HO base load input current	218 A
HO base load output current	205 A
Fuse according to IEC	3NA3252 (315 A)
Fuse according to UL, class J	350 A
Power loss without filter	2.98 kW ¹⁾
Power loss with filter	3.02 kW ¹⁾
Required cooling air flow	153 l/s
Weight without filter	63.5 kg
Weight with filter	68 kg

¹⁾ Approx. 2.6 kW through the heatsink

Table 10-31 PM240-2, frame size G, 380 V ... 480 V 3 AC

Article No. with filter class C3	6SL3210-1PE33-0CLO	6SL3210-1PE33-7CLO	6SL3210-1PE34-8CLO
Article No. with filter class C2	6SL3210-1PE33-0ALO	6SL3210-1PE33-7ALO	6SL3210-1PE34-8ALO
LO base load power	160 kW	200 kW	250 kW
LO base load input current	300 A	365 A	470 A
LO base load output current	302 A	370 A	477 A
HO base load power	132 kW	160 kW	200 kW
HO base load input current	275 A	330 A	400 A
HO base load output current	250 A	302 A	370 A
Fuse according to IEC	3NA3254 (355 A)	3NA3260 (400 A)	3NA3372 (630 A)
Fuse according to UL, class J	400 A	500 A	600 A
Fuse according to IEC/UL	3NE1334-2 (500A)	3NE1334-2 (500A)	3NE1436-2 (630A)
Power loss with filter class C3	3.67 kW	4.62 kW	6.18 kW
Power loss with filter class C2	3.67 kW	4.62 kW	6.18 kW
Required cooling air flow	210 l/s	210 l/s	210 l/s
Weight with filter class C3	105 kg	113 kg	120 kg
Weight with filter class C2	107 kg	114 kg	120 kg



10.3.8 Current derating depending on the pulse frequency, 400 V inverters

Article number	LO power [kW]	Pulse frequency [kHz]							
		2	4 *)	6	8	10	12	14	16
		LO base load output current [A]							
6SL3210-1PE11-8 . L1	0.55	1.7	1.7	1.4	1.2	1	0.9	0.8	0.7
6SL3210-1PE12-3 . L1	0.75	2.2	2.2	1.9	1.5	1.3	1.1	1	0.9
6SL3210-1PE13-2 . L1	1.1	3.1	3.1	2.6	2.2	1.9	1.6	1.4	1.2
6SL3210-1PE14-3 . L1	1.5	4.1	4.1	3.5	2.9	2.5	2.1	1.8	1.6
6SL3210-1PE16-1 . L1	2.2	5.9	5.9	5	4.1	3.5	3	2.7	2.4
6SL321 . -1PE18-0 . L1	3	7.7	7.7	6.5	5.4	4.6	3.9	3.5	3.1
6SL3210-1PE21-1 . L0	4	10.2	10.2	8.7	7.1	6.1	5.1	4.6	4.1
6SL3210-1PE21-4 . L0	5.5	13.2	13.2	11.2	9.2	7.9	6.6	5.9	5.3
6SL321 . -1PE21-8 . L0	7.5	18	18	15.3	12.6	10.8	9	8.1	7.2
6SL3210-1PE22-7 . L0	11	26	26	22.1	18.2	15.6	13	11.7	10.4
6SL321 . -1PE23-3 . L0	15	32	32	27.2	22.4	19.2	16	14.4	12.8
6SL3210-1PE23-8 . L0	18.5	38	38	32.3	26.6	22.8	19	17.1	15.2
6SL3210-1PE24-5 . L0	22	45	45	38.3	31.5	27	22.5	20.3	18
6SL3210-1PE26-0 . L0	30	60	60	51	42	36	30	27	24
6SL321 . -1PE27-5 . L0	37	75	75	63.8	52.5	45	37.5	33.8	30
6SL3210-1PE28-8 . L0	45	90	90	76.5	63	54	45	40.5	36
6SL321 . -1PE31-1 . L0	55	110	110	93.5	77	---	---	---	---
6SL3210-1PE31-5 . L0	75	145	145	123.3	101.5	---	---	---	---
6SL3210-1PE31-8 . L0	90	178	178	151.3	124.6	---	---	---	---
Article number		Pulse frequency [kHz]							
		2 *)	4	6	8	10	12	14	16
		LO base load output current [A]							
6SL3210-1PE32-1 . L0	110	205	143.5	---	---	---	---	---	---
6SL321 . -1PE32-5 . L0	132	250	175	---	---	---	---	---	---
6SL3210-1PE33-0AL0	160	302	211.4	151	120.8	---	---	---	---
6SL3210-1PE33-7AL0	200	370	259	185	148	---	---	---	---
6SL3210-1PE34-8AL0	250	477	333.9	238.5	190.8	---	---	---	---

*) Factory setting

The permissible motor cable length depends on the particular cable type and the pulse frequency that has been selected

10.3.9 General technical data, 690 V inverters

Property	Version
Line voltage	<ul style="list-style-type: none"> for systems according to IEC: 500 V ... 690 V 3 AC \pm 10% (in operation -20% < 1 min) for systems according to UL 500 V ... 600 V 3 AC \pm 10% (in operation -20% < 1 min) filtered devices only with Slash Rating (600Y/347V AC)
Line supply configurations	Grounded TN/TT line supplies or non-grounded IT line supplies  Permissible line supplies (Page 72)
Line impedance	No restrictions
Power factor λ	> 0.9
Output voltage	0 V 3 AC ... 0.95 x input voltage (max.)
Input frequency	50 Hz ... 60 Hz, \pm 3 Hz
Output frequency	0 ... 550 Hz, depending on the control mode
Inrush current	< LO base load input current
Overvoltage category according to EN 61800-5-1	III for line supplies
Pulse frequency	2 kHz (factory setting), can be adjusted to 4 kHz Adjustable in steps of 2 kHz.  Current reduction as a function of the pulse frequency (Page 470) If you increase the pulse frequency, the inverter reduces the maximum output current.
Short-circuit current (SCCR) and branch protection	Maximum permissible line short-circuit current \leq 100 kA rms Minimum required short-circuit current \geq 10 kA rms The length of the connecting cable from the line to the inverter may not reduce the minimum short-circuit current  Branch protection and short-circuit strength according to UL and IEC (https://support.industry.siemens.com/cs/ww/en/view/109479152)
Braking methods	DC braking, compound braking, dynamic braking with integrated braking chopper
Degree of protection according to EN 60529	IP20; must be installed in a control cabinet
Protection class according to EN 61800-5-1	The inverters are devices with protection class I
Touch protection according to EN 50274	DGUV regulation 3 when used for the intended purpose
Cooling in compliance with EN 60146	Forced air cooling AF

10.3.10 Specific technical data, 690 V inverters

Table 10-32 PM240-2, IP20, frame size D, 500 V ... 690 V 3 AC

Article No. - without filter	6SL3210-1PH21-4UL0	6SL3210-1PH22-0UL0	6SL3210-1PH22-3UL0
Article No. - with filter	6SL3210-1PH21-4AL0	6SL3210-1PH22-0AL0	6SL3210-1PH22-3AL0
LO base load power	11 kW	15 kW	18.5 kW
LO base load input current	14 A	18 A	22 A
LO base load output current	14 A	19 A	23 A
HO base load power	7.5 kW	11 kW	15 kW
HO base load input current	11 A	14 A	20 A
HO base load output current	11 A	14 A	19 A
Fuse according to IEC	3NA3807-6 (20 A)	3NA3810-6 (25 A)	3NA3812-6 (32 A)
Fuse according to UL, class J	20 A	25 A	30 A
Power loss without filter	0.35 kW	0.44 kW	0.52 kW
Power loss with filter	0.35 kW	0.45 kW	0.52 kW
Required cooling air flow	55 l/s	55 l/s	55 l/s
Weight without filter	17 kg	17 kg	17 kg
Weight with filter	18.5 kg	18.5 kg	18.5 kg

Table 10-33 PM240-2, IP20, frame size D, 500 V ... 690 V 3 AC

Article No. - without filter	6SL3210-1PH22-7UL0	6SL3210-1PH23-5UL0	6SL3210-1PH24-2UL0
Article No. - with filter	6SL3210-1PH22-7AL0	6SL3210-1PH23-5AL0	6SL3210-1PH24-2AL0
LO base load power	22 kW	30 kW	37 kW
LO base load input current	25 A	33 A	40 A
LO base load output current	27 A	35 A	42 A
HO base load power	18.5 kW	22 kW	30 kW
HO base load input current	24 A	28 A	36 A
HO base load output current	23 A	27 A	35 A
Siemens fuse according to IEC	3NA3817-6KJ (40 A)	3NA3820-6KJ (50 A)	3NA3822-6 (63 A)
Fuse according to UL, class J	35 A	45 A	60 A
Power loss without filter	0.60 kW	0.77 kW	0.93 kW
Power loss with filter	0.60 kW	0.78 kW	0.94 kW
Required cooling air flow	55 l/s	55 l/s	55 l/s
Weight without filter	17 kg	17 kg	17 kg
Weight with filter	18.5 kg	18.5 kg	18.5 kg

Technical data

10.3 Technical data, PM240-2 Power Modules

Table 10-34 PM240-2, IP20, frame size E, 500 V ... 690 V 3 AC

Article No. - without filter	6SL3210-1PH25-2UL0	6SL3210-1PH26-2UL0
Article No. - with filter	6SL3210-1PH25-2AL0	6SL3210-1PH26-2AL0
LO base load power	45 kW	55 kW
LO base load input current	50 A	59 A
LO base load output current	52 A	62 A
HO base load power	37 kW	45 kW
HO base load input current	44 A	54 A
HO base load output current	42 A	52 A
Siemens fuse according to IEC	3NA3824-6 (80A)	3NA3824-6 (80A)
Fuse according to UL, class J	80 A	80 A
Power loss without filter	1.07 kW	1.30 kW
Power loss with filter	1.08 kW	1.31 kW
Required cooling air flow	83 l/s	83 l/s
Weight without filter	26 kg	26 kg
Weight with filter	28 kg	28 kg

Table 10-35 PM240-2, IP20, frame size F, 500 V ... 690 V 3 AC

Article No. - without filter	6SL3210-1PH28-0UL0	6SL3210-1PH31-0UL0	6SL3210-1PH31-2UL0
Article No. - with filter	6SL3210-1PH28-0AL0	6SL3210-1PH31-0AL0	6SL3210-1PH31-2AL0
LO base load power	75 kW	90 kW	110 kW
LO base load input current	78 A	97 A	111 A
LO base load output current	80 A	100 A	115 A
HO base load power	55 kW	75 kW	90 kW
HO base load input current	66 A	85 A	106 A
HO base load output current	62 A	80 A	100 A
Siemens fuse according to IEC	3NA3830-6 (100 A)	3NA3132-6 (125 A)	3NA3136-6 (160 A)
Fuse according to UL, class J	100 A	125 A	150 A
Power loss without filter	1.37 kW	1.74 kW	1.95 kW
Power loss with filter	1.38 kW	1.76 kW	1.97 kW
Required cooling air flow	153 l/s	153 l/s	153 l/s
Weight without filter	60 kg	60 kg	60 kg
Weight with filter	64 kg	64 kg	64 kg

Table 10-36 PM240-2, IP20, frame size F, 500 V ... 690 V 3 AC

Article No. - without filter	6SL3210-1PH31-4UL0
Article No. - with filter	6SL3210-1PH31-4AL0
LO base load power	132 kW
LO base load input current	137 A
LO base load output current	142 A
HO base load power	110 kW
HO base load input current	122 A
HO base load output current	115 A
Siemens fuse according to IEC	3NA3140-6 (200 A)
Fuse according to UL, class J	200 A
Power loss without filter	2.48 kW
Power loss with filter	2.51 kW
Required cooling air flow	153 l/s
Weight without filter	60 kg
Weight with filter	64 kg

Table 10-37 PM240-2, frame size G, 500 V ... 690 V 3 AC

Article No. with filter	6SL3210-1PH31-7CLO	6SL3210-1PH32-1CLO	6SL3210-1PH32-5CLO
LO base load power	160 kW	200 kW	250 kW
LO base load input current	170 A	205 A	250 A
LO base load output current	171 A	208 A	250 A
HO base load power	132 kW	160 kW	200 kW
HO base load input current	160 A	185 A	225 A
HO base load output current	144 A	171 A	208 A
Fuse according to the IEC/UL	3NE1227-0 (250A)	3NE1230-0 (315A)	3NE1331-0 (350A)
Power loss	2.94 kW	3.70 kW	4.64 kW
Required cooling air flow	210 l/s	210 l/s	210 l/s
Weight	114 kg	114 kg	114 kg

10.3.11 Current derating depending on the pulse frequency, 690 V inverters

Article number	LO power [kW]	Pulse frequency [kHz]	
		2 *)	4
		LO base load output current [A]	
6SL3210-1PH21-4 . LO	11	14	8.4
6SL3210-1PH22-0 . LO	15	19	11.4
6SL3210-1PH22-3 . LO	18.5	23	13.8
6SL3210-1PH22-7 . LO	22	27	16.2
6SL3210-1PH23-5 . LO	30	35	21
6SL321 . -1PH24-2 . LO	37	42	25.2
6SL3210-1PH25-2 . LO	45	52	31.2
6SL321 . -1PH26-2 . LO	55	62	37.2
6SL3210-1PH28-0 . LO	75	80	48
6SL3210-1PH31-0 . LO	90	100	60
6SL3210-1PH31-2 . LO	110	115	69
6SL3210-1PH31-4 . LO	132	142	85.2
6SL3210-1PH31-7CLO	160	171	102.6
6SL3210-1PH32-1CLO	200	208	124.8
6SL3210-1PH32-5CLO	250	250	150

*) Factory setting

The permissible motor cable length depends on the particular cable type and the pulse frequency that has been selected

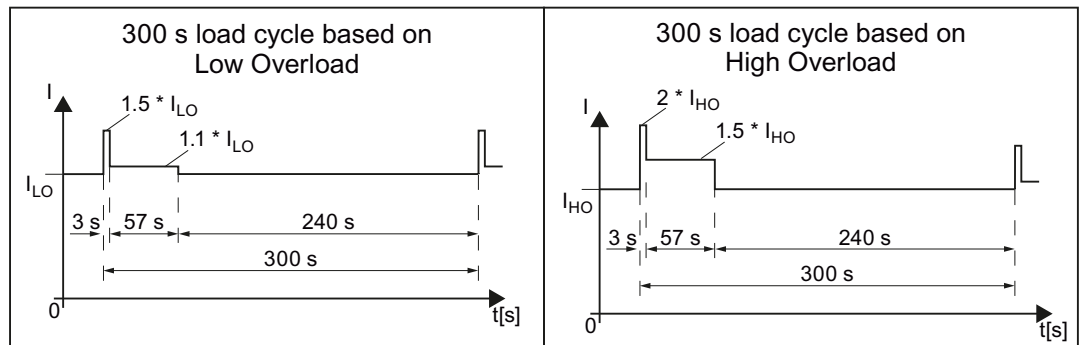

10.4 Technical data, PM250 Power Module

Typical inverter load cycles



10.4.1 Ambient conditions

Ambient conditions during operation

Property	Version
Ambient conditions for transport in the transport packaging	
Climatic ambient conditions	- 40° C ... + 70° C, according to Class 2K4 to EN 60721-3-2 maximum humidity 95% at 40° C
Mechanical ambient conditions	FSC: Shock and vibration permissible according to 1M2 to EN 60721-3-2 FSD ... FSF: Shock and vibration permissible according to 2M3 to EN 60721-3-2
Protection against chemical substances	Protected according to Class 2C2 to EN 60721-3-2
Biological ambient conditions	Suitable according to Class 2B1 to EN 60721-3-2
Ambient conditions for long-term storage in the product packaging	
Climatic ambient conditions	- 25° C ... + 55° C, according to Class 1K3 to EN 60721-3-1
Protection against chemical substances	Protected according to Class 1C2 to EN 60721-3-1
Biological ambient conditions	Suitable according to class 1B1 to EN 60721-3-1
Ambient conditions in operation	
Installation altitude	Up to 1000 m above sea level without limitations  Restrictions for special ambient conditions (Page 478)
Climatic ambient conditions ¹⁾	<ul style="list-style-type: none"> • Ambient operating temperature ²⁾ <ul style="list-style-type: none"> – For operation according to Low Overload: 0° C ... +40° C – For operation according to High Overload: 0° C ... +50° C –  Restrictions for special ambient conditions (Page 478) • Relative humidity: 5 ... 95%, condensation not permitted • Oil mist, salt mist, ice formation, condensation, dripping water, spraying water, splashing water and water jets are not permitted
Mechanical ambient conditions	<ul style="list-style-type: none"> • FSC ... FSF: Vibration levels permissible according to Class 3M1 to EN 60721-3-3 • FSC: Shock, permissible according to Class 3M2 to EN 60721-3-3 • FSD ... FSF: Shock permissible according to Class 3M1 to EN 60721-3-3
Protection against chemical substances	Protected according to 3C2 to EN 60721-3-3
Biological ambient conditions	Suitable according to 3C2 to EN 60721-3-3
Pollution	Suitable for environments with degree of pollution 2 according to EN 61800-5-1, condensation not permitted
Cooling	Forced air cooling AF, according to EN 60146
Cooling air	Clean and dry air

¹⁾ Increased ruggedness regarding temperature range and relative humidity; therefore better than 3K3 according to EN 60721-3-3

²⁾ Observe the permissible ambient temperatures for the Control Unit and possibly the operator panel (IOP-2 or BOP-2).

10.4.2 General technical data, PM250

Property	Version
Line voltage	3-phase 380 ... 480 VAC \pm 10%
Output voltage	3-phase 0 VAC ... input voltage x 0.87 (max.)
Input frequency	50 Hz ... 60 Hz, \pm 3 Hz
Output frequency	0 ... 550 Hz, depending on the control mode
Power factor λ	0.9
Inrush current	< LO base load input current
Pulse frequency (factory setting)	4 kHz The pulse frequency can be adjusted up to 16 kHz in 2 kHz steps. The higher the pulse frequency, the lower the available output current.  Current reduction depending upon pulse frequency (Page 476)
Electromagnetic compatibility	The devices comply with EN 61800-3: 2004 suitable for Category C2 and C3 environments.
Braking methods	DC braking, energy recovery (up to 100% of the output power)
Degree of protection	IP20 built-in devices (they must be installed in a switch cabinet)

10.4.3 Specific technical data, PM250

Note

The values for Low Overload (LO) are identical with those of the rated values.

Table 10-38 PM250, IP20, Frame Size C, 3-ph. AC 380 V ... 480 V

Article no.	6SL3225-0BE25-5AA1	6SL3225-0BE27-5AA1	6SL3225-0BE31-1AA1
LO base load output	7.5 kW	11 kW	15 kW
LO base load input current	18 A	25 A	32 A
LO base load output current	18 A	25 A	32 A
HO base load output	5.5 kW	7.5 kW	11 kW
HO base load input current	13.2 A	19 A	26 A
HO base load output current	13.2 A	19 A	26 A
Fuse	20 A, Class J	32 A, Class J	35 A, Class J
Power loss	0.24 kW	0.30 kW	0.31 kW
Required cooling air flow	38 l/s	38 l/s	38 l/s
Weight	7.5 kg	7.5 kg	7.5 kg

Table 10-39 PM250, IP20, Frame Size D, 3-ph. AC 380 V ... 480 V

Article no.	6SL3225-0BE31-5AA0	6SL3225-0BE31-8AA0	6SL3225-0BE32-2AA0
LO base load output	18.5 kW	22 kW	30 kW
LO base load input current	36 A	42 A	56 A
LO base load output current	38 A	45 A	60 A
HO base load output	15 kW	18.5 kW	22 kW
HO base load input current	30 A	36 A	42 A
HO base load output current	32 A	38 A	45 A
Fuse according to IEC	3NA3820	3NA3822	3NA3824
Fuse according to UL	50 A, Class J 3NE1817-0	63 A, Class J 3NE1818-0	80 A, Class J 3NE1820-0
Power loss	0.44 kW	0.55 kW	0.72 kW
Required cooling air flow	22 l/s	22 l/s	39 l/s
Weight	15 kg	15 kg	16 kg

Table 10-40 PM250, IP20, Frame Size E, 3-ph. AC 380 V ... 480 V

Article no.	6SL3225-0BE33-0AA0	6SL3225-0BE33-7AA0
LO base load output	37 kW	45 kW
LO base load input current	70 A	84 A
LO base load output current	75 A	90 A

Article no.	6SL3225-0BE33-0AA0	6SL3225-0BE33-7AA0
HO base load output	30 kW	37 kW
HO base load input current	56 A	70 A
HO base load output current	60 A	75 A
Fuse according to IEC	3NA3830	3NA3832
Fuse according to UL	100 A, Class J 3NE1821-0	125 A, Class J 3NE1822-0
Power loss	1.04 kW	1.2 kW
Required cooling air flow	22 l/s	39 l/s
Weight	21 kg	21 kg

Table 10-41 PM250, IP20, Frame size F, 3-ph. AC 380 V ... 480 V

Article no.	6SL3225-0BE34-5AA0	6SL3225-0BE35-5AA0	6SL3225-0BE37-5AA0
LO base load output	55 kW	75 kW	90 kW
LO base load input current	102 A	135 A	166 A
LO base load output current	110 A	145 A	178 A
HO base load output	45 kW	55 kW	75 kW
HO base load input current	84 A	102 A	135 A
HO base load output current	90 A	110 A	145 A
Fuse according to IEC	3NA3836	3NA3140	3NA3144
Fuse according to UL	160 A, Class J 3NE1824-0	200 A, Class J 3NE1825-0	250 A, Class J 3NE1827-0
Power loss	1.5 kW	2.0 kW	2.4 kW
Required cooling air flow	94 l/s	94 l/s	117 l/s
Weight	51 kg	51 kg	51 kg

10.4.4 Current reduction depending upon pulse frequency

Relationship between pulse frequency and current reduction

Table 10-42 Current reduction depending on pulse frequency

Rated Power (LO)	Base load current (LO)	Base load current (LO) at pulse frequency of					
		4 kHz	6 kHz	8 kHz	10 kHz	12 kHz	14 kHz
kW	A	A	A	A	A	A	A
0,55	1,7						
0,75	2,2						
1,1	3,1						
1,5	4,1						
2,2	5,9						
3	7,7						
4	10.2						
5,5	13.2						
7.5	18.0	12.5	11.9	10.6	9.20	7.90	6.60
11	25.0	18.1	17.1	15.2	13.3	11.4	9.50
15	32.0	24.7	23.4	20.8	18.2	15.6	12.8
18.5	38.0	32.3	26.6	22.8	19.0	17.1	15.2
22	45.0	38.3	31.5	27.0	22.5	20.3	18.0
30	60.0	51.0	42.0	36.0	30.0	27.0	24.0
37	75.0	63.8	52.5	45.0	37.5	33.8	30.0
45	90.0	76.5	63.0	54.0	45.0	40.5	36.0
55	110	93.5	77.0	--	--	--	--
75	145	123	102	--	--	--	--
90	178	151	125	--	--	--	--

10.5 Data regarding the power loss in partial load operation

You can find data regarding power loss in partial load operation in the Internet:

 Partial load operation (<http://support.automation.siemens.com/WW/view/en/94059311>)

10.6 Restrictions for special ambient conditions

Permissible line supplies dependent on the installation altitude

- For installation altitudes ≤ 2000 m above sea level, it is permissible to connect the inverter to any of the line supplies that are specified for it.
- For installation altitudes 2000 m ... 4000 m above sea level, the following applies:
 - Connection to a TN line system with grounded neutral point is permissible.
 - TN systems with grounded line conductor are not permitted.
 - The TN line system with grounded neutral point can also be supplied using an isolation transformer.
 - The phase-to-phase voltage does not have to be reduced.

Note

Using Power Modules connected to TN line supplies with voltages ≥ 600 V for installation altitudes 2000 m ... 4000 m

For voltages ≥ 600 V, the TN line supply must have a grounded neutral point established using an isolating transformer.

Current derating as a function of the installation altitude

The permissible inverter output current is reduced above an installation altitude of 1000 m.

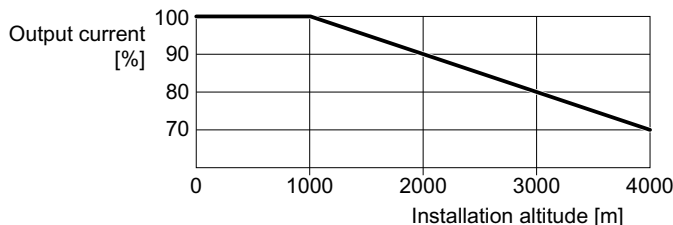

Figure 10-3 Characteristic for the PM240-2 Power Module

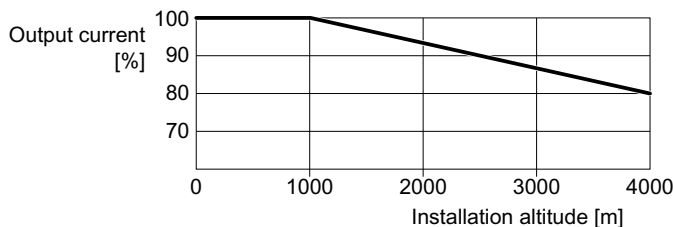
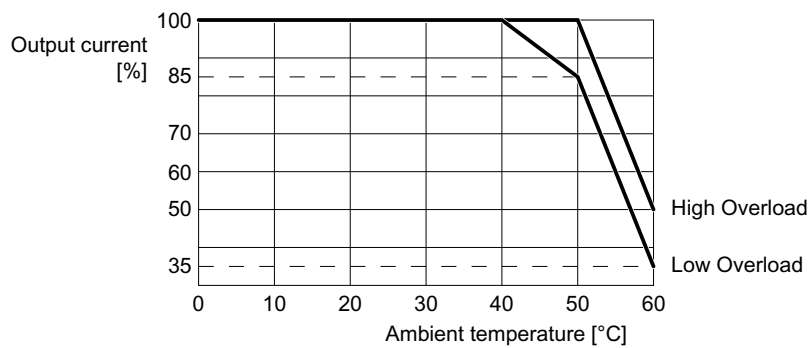

Figure 10-4 Characteristic for the PM250 Power Module

Current de-rating depending on the ambient operating temperature



The Control Unit and operator panel can restrict the maximum permissible operating ambient temperature of the Power Module.

Appendix

A.1 New and extended functions

A.1.1 Firmware version 4.7 SP10

Table A-1 New functions and function changes in firmware 4.7 SP10

	Function	SINAMICS							ET 200pro FC-2
		G120				G120D			
		G110M	G120C	CU230P-2	CU240B-2	CU240E-2	CU250S-2	CU240D-2	CU250D-2
1	New parameter r7844 [1] for displaying the firmware version in plain text. "04070901" is equivalent to firmware version V4.7 SP9 HF1, for example	✓	✓	✓	✓	✓	✓	✓	✓
2	Modbus RTU <ul style="list-style-type: none"> The factory setting of parameter p2040 was increased to provide more robust inverter operation. Monitoring time for data failure at the Modbus interface: p2040 = 10 s r2057 indicates how the address switch on the inverter is set 	✓	✓	✓	✓	✓	-	-	-
3	BACnet MS/TP: <ul style="list-style-type: none"> New factory setting for more robust inverter operation: <ul style="list-style-type: none"> Baud rate p2020 = 38.4 kBd Monitoring time for data failure at the BACnet interface was increased: p2040 = 10 s Factory setting for the maximum number of info frames p2025 [1] = 5 Factory setting for the maximum number of master addresses p2025 [3] = 32 r2057 indicates how the address switch on the inverter is set 	-	-	✓	-	-	-	-	-
4	Further technological unit kg/cm ² for unit switchover	✓	✓	✓	✓	✓	✓	✓	✓

	Function	SINAMICS								
		G120				G120D				
5	Further technological unit kg/cm ² for additional technology controllers	-	-	✓	-	-	-	-	-	-
6	Commissioning with predefined motor data for SIMOTICS GP/SD synchronous-reluctance motors: <ul style="list-style-type: none"> • Second generation: 1FP1 . 04 → 1FP1 . 14 • Further frame sizes: <ul style="list-style-type: none"> – 1.1 kW ... 3 kW, 1500 1/min, 1800 1/min, 2810 1/min – 0.75 kW ... 4 kW, 3000 1/min, 3600 1/min • In planning: <ul style="list-style-type: none"> – 37 kW ... 45 kW, 1500 1/min, 1800 1/min, 2810 1/min – 5.5 kW ... 18.5 kW, 3000 1/min, 3600 1/min – 45 kW, 3000 1/min, 3600 1/min – The predefined motor data is already included in the firmware 	✓	-	✓	-	✓ ¹⁾	-	✓	-	-

¹⁾ Installation with PM240-2 or PM240P-2 Power Modules

A.1.2 Firmware version 4.7 SP9

Table A-2 New functions and function changes in firmware 4.7 SP9

	Function	SINAMICS								ET 200pro FC-2
		G120				G120D				
		G110M	G120C	CU230P-2	CU240B-2	CU240E-2	CU250S-2	CU240D-2	CU250D-2	
1	Support of PM240-2 FSG Power Modules	-	-	✓	✓	✓	✓	-	-	-
2	Support of PM240-2 Power Modules in push-through technology, frame sizes FSD ... FSF, for the following voltages: <ul style="list-style-type: none"> • 3 AC 200 V ... 240 V • 3 AC 380 V ... 480 V • 3 AC 500 V ... 690 V 	-	-	✓	✓	✓	✓	-	-	-
3	Shortened switch-on time for PM330 Power Modules	-	-	✓	-	-	-	-	-	-
4	Expansion of the support for 1FP1 synchronous-reluctance motor with the following inverters: <ul style="list-style-type: none"> • SINAMICS G110M • SINAMICS G120D • SINAMICS G120 with CU240B-2 or CU240E-2 Control Unit A PM240-2 Power Module is required to operate a 1FP1 synchronous-reluctance motor with SINAMICS G120	✓	-	✓	✓	✓	-	✓	-	-
5	Support of 1FP3 synchronous-reluctance motors A PM240-2 Power Module is required to operate a 1FP3 synchronous-reluctance motor along with a selective release from SIEMENS	-	-	✓	-	-	-	-	-	-
6	Support of 1LE5 induction motors	-	✓	✓	✓	✓	✓	-	-	-
7	The inverter supports forming of the PM330 Power Module DC link capacitors	-	-	✓	-	-	-	-	-	-
8	Setting option for two output reactors using parameter p0235 at the SINAMICS G120C and SINAMICS G120 with PM240-2 FSD ... FSF Power Module	-	✓	✓	✓	✓	✓	-	-	-
9	Efficiency-optimized operation of induction motors Improved method "Efficiency optimization 2"	✓	✓	✓	✓	✓	✓	✓	✓	✓
10	New setting option for the "Technology application" p0500 = 5 during quick commissioning	✓	✓	✓	✓	✓	✓	✓	✓	✓
11	Expansion of the available PROFIdrive telegrams in the SINAMICS G120C to include telegram 350	-	✓	✓	✓	✓	✓	-	-	-
12	An SSI encoder can be parameterized as motor encoder	-	-	-	-	-	✓	-	✓	-
13	Expansion of the "Basic positioner" function to include the feedback signal from traversing blocks to the higher-level control system	-	-	-	-	-	✓	-	✓	-

	Function	SINAMICS								
		G110M	G120C	G120			G120D		ET 200pro FC-2	
CU230P-2	CU240B-2			CU240E-2	CU250S-2	CU240D-2	CU250D-2			
14	Expansion to include a feedback signal if a memory card is not inserted in the inverter: <ul style="list-style-type: none"> Parameter r9401 as BiCo parameter for the optional feedback signal to the higher-level control system. New alarm A01101 	✓	✓	✓	✓	✓	✓	✓	✓	✓
15	Expansion of the "End stop control" function on the following inverters: <ul style="list-style-type: none"> SINAMICS G120 SINAMICS G120C SINAMICS G120D 	✓	✓	✓	✓	✓	✓	✓	✓	-
16	Expansion of the technology controller to include the following functions: <ul style="list-style-type: none"> Gain K_p and integral time T_N can be adapted. The system deviation can be used as adaptation signal 	-	-	✓	-	✓	-	-	-	-
17	Expansion to the torque limiting for SINAMICS G120 inverters with CU230P-2 Control Unit	✓	✓	✓	✓	✓	✓	✓	✓	✓
18	The inverter displays the state "PROFenergy pause" as follows: <ul style="list-style-type: none"> LED RDY "green on": 0.5 s LED RDY off: 3 s 	✓	✓	✓	✓	✓	✓	✓	✓	✓

 Changes in the current edition (Page 3)

A.1.3 Firmware version 4.7 SP6

Table A-3 New functions and function changes in firmware 4.7 SP6

	Function	SINAMICS								
		G120						G120D		
		G110M	G120C	CU230P-2	CU240B-2	CU240E-2	CU250S-2	CU240D-2	CU250D-2	ET 200pro FC-2
1	Support for the Power Module PM240-2, FSF frame sizes	-	-	✓	✓	✓	✓	-	-	-
	Support of PM240P-2 Power Modules frame sizes FSD ... FSF	-	-	✓	✓	✓	-	-	-	-
	Support of safety function Safe Torque Off (STO) via the terminals of the PM240-2 Power Module, frame size FSF and PM240P-2 Power Module FSD ... FSF You can find additional information in the "Safety Integrated" function manual.  Overview of the manuals (Page 519)	-	-	-	-	✓	✓	-	-	-
2	Support for Power Module PM330 JX frame size	-	-	✓	-	-	-	-	-	-
3	Support for 1PC1 induction motors	✓	✓	✓	✓	✓	✓	✓	✓	✓
4	The control of synchronous reluctance takes into account the inductance of the output reactor.	-	-	✓	-	-	-	-	-	-
5	Support of motor temperature sensor Pt1000	✓	✓	✓	✓	✓	✓	✓	✓	✓
6	New p4621 parameter for disabling PTC short-circuit monitoring	-	-	-	-	-	-	✓	✓	✓
7	Revision of the thermal motor model for protecting the motor against damage due to overheating in the stator or rotor	✓	✓	✓	✓	✓	✓	✓	✓	✓
8	Changing the quick commissioning in the "Standard Drive Control" application class: The motor data identification is no longer permanently set to p1900 = 12; instead, users select the appropriate motor data identification. Factory setting: p1900 = 2.	-	✓	✓	✓	✓	✓	-	-	-
9	The free function blocks are also available in the SINAMICS G120C.	✓	✓	✓	✓	✓	✓	✓	-	-

 Changes in the current edition (Page 3)

A.1.4 Firmware version 4.7 SP3

Table A-4 New functions and function changes in firmware 4.7 SP3

	Function	SINAMICS								
		G120						G120D		
		G110M	G120C	CU230P-2	CU240B-2	CU240E-2	CU250S-2	CU240D-2	CU250D-2	ET 200pro FC-2
1	PM240-2 Power Modules, frame sizes FSD and FSE are supported	-	-	✓	✓	✓	✓	-	-	-
	The Safety Integrated Basic Function Safe Torque Off (STO) is supported via the terminals of the PM240-2 Power Module, frame sizes FSD and FSE	-	-	-	-	✓	✓	-	-	-
2	Revised PM230 Power Module with new article numbers supported: <ul style="list-style-type: none"> IP55 degree of protection: 6SL3223-0DE G . IP20 degree of protection and Push Through: 6SL321 . -1NE G . You can find additional information in the "Safety Integrated" function manual.  Overview of the manuals (Page 519)	-	-	✓	✓	✓	-	-	-	-
	The Safety Integrated Basic Function Safe Torque Off (STO) is supported with the revised PM230 Power Module	-	-	-	-	✓	-	-	-	-
3	PM330 Power Module, frame size HX is supported	-	-	✓	-	-	-	-	-	-
4	Support of 1FP1 synchronous-reluctance motors	-	-	✓	-	-	-	-	-	-
5	Encoderless 1FG1 geared synchronous motors are supported	-	-	-	-	-	-	✓	-	-
6	Selection list for 1PH8 induction motors in the STARTER and Startdrive commissioning wizard	-	✓	✓	✓	✓	✓	-	-	-
7	Updated selection list for 1LE1 induction motors in the STARTER and Startdrive commissioning wizard	✓	✓	✓	✓	✓	✓	✓	✓	✓
8	Motor support expanded with 1LE1, 1LG6, 1LA7 and 1LA9 induction motors	✓	-	-	-	-	-	-	-	-
9	Speed and position control obtain their respective actual value from an SSI encoder with incremental tracks. The output signals of the encoder are available as encoder 2 for position control and timer 1 for speed control.	-	-	-	-	-	✓	-	✓	-
10	Power Module with temperature-controlled fan	✓	-	-	-	-	-	-	-	-

	Function	SINAMICS								
		G120				G120D				
		G110M	G120C	CU230P-2	CU240B-2	CU240E-2	CU250S-2	CU240D-2	CU250D-2	ET 200pro FC-2
11	SINAMICS "Standard Drive Control" and "Dynamic Drive Control" application classes to simplify commissioning and increase the degree of ruggedness of the closed-loop motor control. The SINAMICS application classes are available with the following inverters: <ul style="list-style-type: none"> • SINAMICS G120C • SINAMICS G120 with PM240, PM240-2 and PM330 Power Modules 	-	✓	✓	✓	✓	✓	-	-	-
12	Moment of inertia estimator with moment of inertia precontrol to optimize the speed controller in operation	✓	✓	-	✓	✓	✓	✓	✓	✓
13	Friction torque characteristic with automatic plotting to optimize the speed controller	✓	✓	-	✓	✓	✓	✓	✓	✓
14	Automatic optimization of the technology controller	-	-	✓	✓	✓	-	-	-	-
15	The sign of the system deviation for the additional, free technology controller can be switched over. A new parameter defines the sign of the system deviation matching the particular application, e.g. for cooling or heating applications.	-	-	✓	-	-	-	-	-	-
16	The technology controller output can be enabled and disabled during operation	-	✓	✓	✓	✓	✓	-	-	-
17	Ramp-function generator remains active with enabled technology controller	-	-	✓	-	-	-	-	-	-
18	Line contactor control using a digital output of the inverter to save energy when the motor is switched off	✓	✓	✓	✓	✓	✓	✓	✓	-
19	Fast flying restart for PM330 Power Modules: The "Flying restart" function does not have to wait for the motor demagnetization time, and identifies the motor speed without requiring a search operation.	-	-	✓	-	-	-	-	-	-
20	Load torque monitoring extended to include the following functions: <ul style="list-style-type: none"> • Protection against blocking, leakage and dry running operation in pump applications • Protection against blocking and broken belts in fan applications 	✓	-	✓	✓	✓	-	-	-	-
21	Automatic switchover of the real time clock from daylight saving time (summer time) to standard time (winter time).	-	-	✓	-	-	-	-	-	-
22	New or revised default settings of the interfaces: p0015 macros 110, 112 and 120	-	-	✓	-	-	-	-	-	-

	Function	SINAMICS								
		G110M	G120C	G120			G120D			ET 200pro FC-2
CU230P-2	CU240B-2			CU240E-2	CU250S-2	CU240D-2	CU250D-2			
23	Expansion of the temperature sensors to include DIN-Ni1000 for analog inputs AI 2 and AI 3	-	-	✓	-	-	-	-	-	-
24	Communication via AS-Interface. Default setting of the communication via AS-i: p0015 macros 30, 31, 32 and 34	✓	-	-	-	-	-	-	-	-
25	Communication expansion via Modbus: Adjustable parity bit, access to parameters and analog inputs	✓	✓	✓	✓	✓	✓	-	-	-
26	Extending communication via BACnet: Access to parameters and analog inputs	-	-	✓	-	-	-	-	-	-
27	The bus error LED for communication via USS and Modbus can be switched off	✓	✓	✓	✓	✓	✓	-	-	-
28	Default of the minimum speed to 20% of the rated motor speed	-	-	✓	-	-	-	-	-	-
29	For commissioning with an operator panel, the inverter automatically backs up the measured data retentively in the ROM after identification of the motor data.	✓	✓	✓	✓	✓	✓	✓	✓	✓
30	The result of the energy savings calculation for flow machines is available as a connector	✓	✓	✓	✓	✓	✓	✓	✓	✓
31	New "ppm" unit (parts per million) for unit switching	✓	✓	✓	✓	✓	✓	✓	✓	✓
32	Displaying speeds during commissioning via operator panel in units of Hz instead of rpm. Conversion from Hz to rpm via p8552	-	-	✓	-	-	-	-	-	-
33	Voltage-dependent current limit for 600V devices of Power Module PM330 and PM240-2	-	-	✓	✓	✓	✓	-	-	-

A.1.5 Firmware version 4.7

Table A-5 New functions and function changes in Firmware 4.7

	Function	SINAMICS							
		G120					G120D		
		G110M	G120C	CU230P-2	CU240B-2	CU240E-2	CU250S-2	CU240D-2	CU250D-2
1	Supporting the identification & maintenance datasets (I&M1 ... 4)	✓	✓	✓	✓	✓	✓	✓	✓
2	Fall in pulse rate with increased drive power required by the motor <ul style="list-style-type: none"> The inverter temporarily lowers the pulse frequency if required when the motor is started up, and simultaneously increases the current limit. 	✓	✓	✓	✓	✓	✓	✓	✓
3	S7 communication <ul style="list-style-type: none"> Direct data exchange between the inverter and human-machine interface (HMI). Increase in communication performance with the engineering tools and support of the S7 routing 	✓	✓	✓	✓	✓	✓	✓	✓
4	The basic functions of Safety Integrated are unrestrictedly available in all control types with 1FK7 encoderless permanent-field synchronous motors	-	-	-	-	-	-	✓	-
5	Encoderless 1FK7 synchronous motors are supported <ul style="list-style-type: none"> Direct motor selection based on the article number with associated code number It is not necessary to input individual motor data 	-	-	-	-	-	-	✓	-
6	Pulse input as source of setpoint value <ul style="list-style-type: none"> The inverter calculates its speed setpoint from a sequence of pulses at the digital input. 	-	-	-	-	-	✓	-	-
7	Dynamic IP address assignment (DHCP) and temporary device names for PROFINET	✓	✓	✓	-	✓	✓	✓	✓
8	PROFInergy Slave profile 2 and 3	✓	✓	✓	-	✓	✓	✓	✓
9	Uniform behavior for component replacement <ul style="list-style-type: none"> After a component is replaced, an inverter with activated Safety Integrated will report what type of component has been replaced using a unique code. 	✓	✓	-	-	✓	✓	✓	✓
10	Improved direct-component control in PM230 <ul style="list-style-type: none"> Optimized efficiency for pump and fan applications 	-	-	✓	-	-	-	-	-
11	Rounding down of BACnet and macros	-	-	✓	-	-	-	-	-

A.1.6 Firmware version 4.6 SP6

Table A-6 New functions and function changes in firmware 4.6 SP6

	Function	SINAMICS						
			G120			G120D		
		G120C	CU230P-2	CU240B-2	CU240E-2	CU250S-2	CU240D-2	CU250D-2
1	Support for the new Power Modules <ul style="list-style-type: none"> PM330 IP20 GX 	-	✓	-	-	-	-	-

A.1.7 Firmware version 4.6

Table A-7 New functions and function changes in Firmware 4.6

	Function	SINAMICS						
		G120					G120D	
		G120C	CU230P-2	CU240B-2	CU240E-2	CU250S-2	CU240D-2	CU250D-2
1	Support for the new Power Modules <ul style="list-style-type: none"> PM240-2 IP20 FSB ... FSC PM240-2 in through-hole technology FSB ... FSC 	-	✓	✓	✓	✓	-	-
2	Support for the new Power Modules <ul style="list-style-type: none"> PM230 in through-hole technology FSD ... FSF 	-	✓	✓	✓	-	-	-
3	Motor data preassignment for the 1LA/1LE motors via code number <ul style="list-style-type: none"> During quick commissioning with the operator panel, set the motor data using a code number 	✓	✓	✓	✓	✓	✓	✓
4	Extension to communication via CANopen <ul style="list-style-type: none"> CAN velocity, ProfilTorque, SDO channel for each axis, system test with CodeSys, suppression of ErrorPassiv alarm 	✓	✓	-	-	✓	-	-
5	Extension to communication via BACnet <ul style="list-style-type: none"> Multistate value objects for alarms, commandable AO objects, objects for configuring the PID controller 	-	✓	-	-	-	-	-
6	Communication via EtherNet/IP	✓	✓	-	✓	✓	✓	✓
7	Skip frequency band for analog input <ul style="list-style-type: none"> A symmetrical skip frequency band can be set for each analog input around the 0 V range. 	✓	✓	✓	✓	✓	✓	-
8	Changing the control of the motor holding brake	✓	-	✓	✓	✓	✓	-
9	Safety function SBC (Safe Brake Control) <ul style="list-style-type: none"> Secure control of a motor holding brake when using the "Safe Brake Module" option 	-	-	-	-	✓	-	-
10	Safety function SS1 (Safe Stop 1) without speed monitoring	-	-	-	-	✓	-	-
11	Straightforward selection of standard motors <ul style="list-style-type: none"> Selection of 1LA... and 1LE... motors with an operator panel using a list containing code numbers 	✓	✓	✓	✓	✓	✓	✓
12	Firmware update via memory card	✓	✓	✓	✓	✓	✓	✓
13	Safety info channel <ul style="list-style-type: none"> BICO source r9734.0...14 for the status bits of the extended safety functions 	-	-	-	✓	✓	✓	✓
14	Diagnostic alarms for PROFIBUS	✓	✓	✓	✓	✓	✓	✓

A.2 Activating licensed functions

A.2.1 Licensing

Purchasing a memory card with license

Procedure

1. Order a memory card - with or without firmware – with the license that you require.
2. Switch off the inverter power supply.
3. Insert the card into the inverter.
4. Switch on the power supply for the inverter.

You have activated the licensed function.





Purchasing a license and loading to a memory card

Precondition

You have a memory card without a license.

 Memory cards (Page 362)

Procedure

1. Order the license for the function that you require.
2. You receive the "Certificate of License", it contains:
 - the software order number
 - the license number
 - the delivery note number
3. Create the license key using the "WEB License Manager".
 License key (Page 493)
4. Insert the card into the inverter.
5. Write the license key to the card using STARTER or BOP-2.
 Writing the license key to the card (Page 496)
6. Switch off the inverter power supply.
7. Switch on the inverter power supply again.

You have activated the licensed function.



A.2.2 Creating or displaying the license key

Overview

The WEB License Manager has the following functions:

- Generate the license key for a new license
- Display the licenses on a card

WEB License Manager on the Internet:

 <http://www.siemens.com/automation/license> (https://workplace.automation.siemens.com/pls/swl-pub/SWL_MAIN_MENU.NAVIGATION_HEAD?a_lang_id=E&a_action=)

Creating the license key using "WEB License Manager"

Preconditions

- You know the license number and the delivery note number from the Certificate of License.
- You know the serial number of your memory card.

Procedure

1. Open the WEB License Manager.
2. Click "Direct access" in the WEB License Manager in the navigation bar.

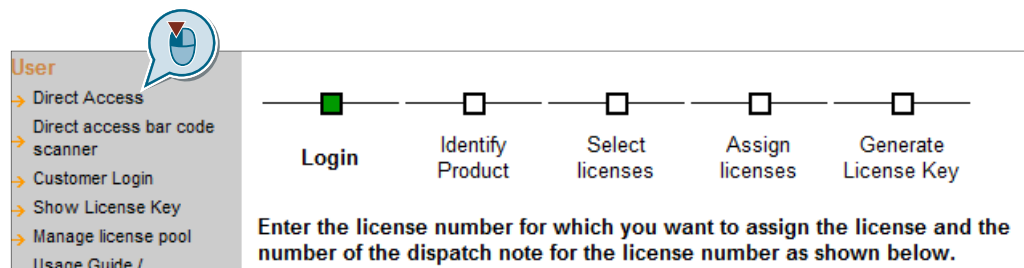

3. Enter the license number and delivery note number from your Certificate of License.
4. Click "Next".
5. Progress display: "Identify product".
Enter the serial number of the memory card.
6. Select for "Product": SINAMICS G120
7. Click "Next".
If licenses are already assigned to your software, they are displayed here.
8. Click "Next".
9. Progress display: "Select licenses".
The WEB License Manager displays the licenses that you can assign. Select the checkbox for assignment.
10. Click "Next".

11. Progress display: "Assign licenses".
The WEB License Manager displays a summary of the licenses selected for assignment.
12. Click "Assign".
13. Confirm the following confirmation prompt with OK.
14. Progress display: "Generate license key".
The licenses are permanently assigned to the specified memory card. The license key is displayed.

- [License Key in SIN++SINAMICS G120+N3093102760044+incl_key_Alm abspeichern.](#)
- [License Key in keys.txt abspeichern](#)
- [License Report als PDF abspeichern](#)

15. Save the license key on your PC.

You have created a license key.



Displaying and requesting the license key using the "WEB License Manager"

With this function, the WEB License Manager displays which inverter functions are assigned to which card with which license keys.

Precondition

One of the following requirements must be satisfied:

- You know the serial number of the memory card
- You know the license number of the inverter function

Procedure

1. Open the WEB License Manager.
2. Select "Show license key"
3. In the drop-down list, make the entry based on the license key you wish to display or request.
4. Complete the fields below appropriately.

5. Click the "Display license key" button.

Show License Key

Pressing the button will show you the current License Key. At least one license must have been assigned yet.

license number

Current License Key

Additionally you can get a License Report by email summarizing all assigned licenses.

Email address

6. Enter your e-mail address and click "Request license report".
7. You receive the license report as a PDF. In addition to the actual license key, it includes the serial number of the memory card and all of the licenses assigned to this memory card.

You have displayed and requested the license key.



A new license is not required if you upgrade/downgrade to older or newer software versions. For this reason, do not delete the license key from the memory card (..\KEYS\SINAMICS\KEYS.txt), if you want to switch over to another software version.

A.2.3 Writing the license key to the card

Overview

You write the license key to the memory card by writing the individual positions – in an ascending order – into the bits of parameter p9920, and then subsequently activate the key using p9921.

The procedure for Startdrive and BOP-2, based on the fictitious "E1MQ-4BEA" license key, is described below.

Note

If you subsequently purchase an additional license, then you will require a new license key. You must overwrite the old license key. The new license key can have more than 9 positions.

You must set p9920[0] = 0 in order to reset the license key.

Activating the license key with Startdrive

Procedure

1. Go online and switch over to the parameter view.
2. In the parameter view, go to parameter p9920
3. Enter the license key (example: "E1MQ-4BEA") - always use uppercase letters:
 - p9920[0] = E
 - p9920[1] = 1
 - ...
 - p9920[7] = E
 - p9920[8] = A
4. Set p9921 = 1.
After activation, the inverter sets p9921 = 0.

You have activated the license key using Startdrive.



Activating the license key with BOP-2

Procedure

1. Convert the license key (example:"E1MQ-4BEA") into decimal numbers based on the table below.
 - E = 69, 1 = 49, M = 77, Q = 81, - = 45, 4 = 52, B = 66, E = 69, A = 65
 2. Enter the value in ascending order into p9920
 - p9920[0] = 69
 - p9920[1] = 49
 - ...
 - p9920[7] = 69
 - p9920[8] = 65
 3. Set p9921 = 1.
After activation, the inverter sets p9921 = 0.
- You have activated the license key using BOP-2.
□

Converting the license key for input using the BOP-2

Convert the license code into decimal numbers based on the following ASCII table.

Excerpt of ASCII code

Character	Decimal	Character	Decimal	Character	Decimal
-	45	C	67	P	80
0	48	D	68	Q	81
1	49	E	69	R	82
2	50	F	70	S	83
3	51	G	71	T	84
4	52	H	72	U	85
5	53	I	73	V	86
6	54	J	74	W	87
7	55	K	75	X	88
8	56	L	76	Y	89
9	57	M	77	Z	90
A	65	N	78	Blank	32
B	66	O	79		

A.3 Handling the BOP 2 operator panel

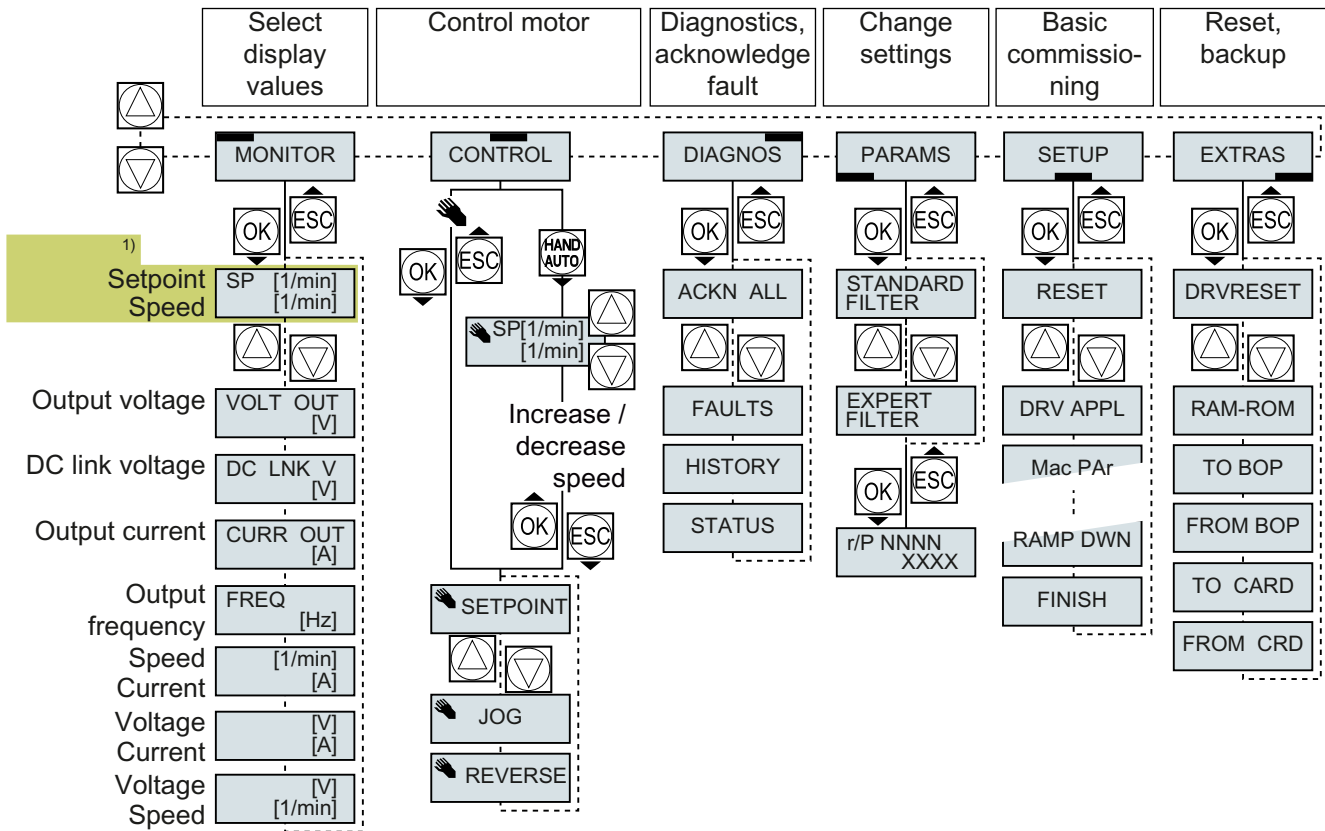

1) Status display once the power supply for the inverter has been switched on.

Figure A-1 Menu of the BOP-2

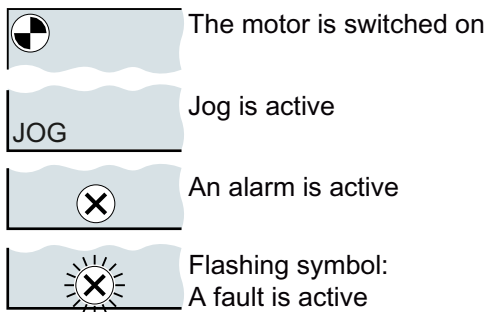

Figure A-2 Other keys and symbols of the BOP-2

Procedure for switching the motor on and off via the operator panel:

1. Press MANUAL AUTO
2. Master control of the inverter is released via the BOP-2
3. Switch on motor
4. Switch off the motor

A.3.1 Changing settings using BOP-2

Changing settings using BOP-2

You can modify the settings of your inverter by changing the values of the its parameters. The inverter only permits changes to "write" parameters. Write parameters begin with a "P", e.g. P45.

The value of a read-only parameter cannot be changed. Read-only parameters begin with an "r", for example: r2.

The inverter retentively saves all the changes made using the BOP-2 so that they are protected against power failure.

Procedure

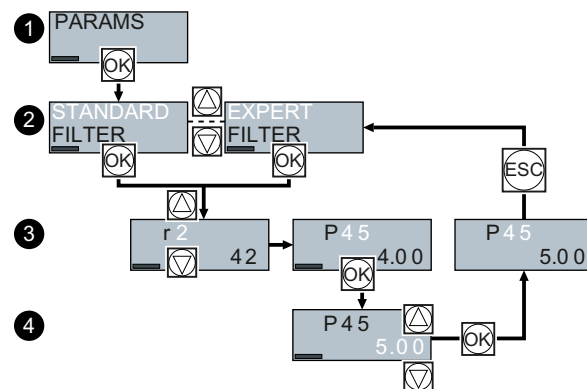

1. Select the menu to display and change parameters.
Press the OK key.
2. Select the parameter filter using the arrow keys.
Press the OK key.
 - STANDARD: The inverter only displays the most important parameters.
 - EXPERT: The inverter displays all of the parameters.
3. Select the required number of a write parameter using the arrow keys.
Press the OK key.
4. Select the value of the write parameter using the arrow keys.
Accept the value with the OK key.

You have now changed a write parameter using the BOP-2.

□

A.3.2 Changing indexed parameters

Changing indexed parameters

For indexed parameters, several parameter values are assigned to a parameter number. Each of the parameter values has its own index.

Procedure

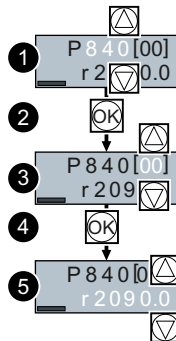

1. Select the parameter number.
2. Press the OK key.
3. Set the parameter index.
4. Press the OK key.
5. Set the parameter value for the selected index.

You have now changed an indexed parameter.

□

A.3.3 Directly entering the parameter number and value

Directly select the parameter number

The BOP-2 offers the possibility of setting the parameter number digit by digit.

Precondition

The parameter number is flashing in the BOP-2 display.

Procedure

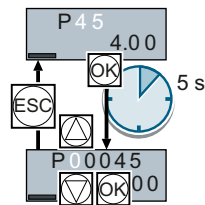

1. Press the OK button for longer than five seconds.
2. Change the parameter number digit-by-digit.
If you press the OK button then the BOP-2 jumps to the next digit.
3. If you have entered all of the digits of the parameter number, press the OK button.

You have now entered the parameter number directly.



Entering the parameter value directly

The BOP-2 offers the option of setting the parameter value digit by digit.

Precondition

The parameter value flashes in the BOP-2 display.

Procedure

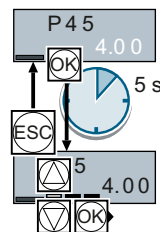

1. Press the OK button for longer than five seconds.
2. Change the parameter value digit-by-digit.
If you press the OK button then the BOP-2 jumps to the next digit.
3. If you have entered all of the digits of the parameter value, press the OK button.

You have now entered the parameter value directly.



A.3.4 A parameter cannot be changed

When cannot you change a parameter?

The inverter indicates why it currently does not permit a parameter to be changed:

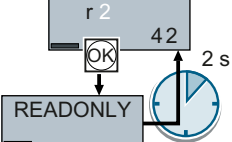
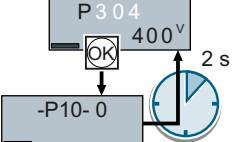
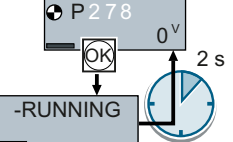
Read parameters cannot be adjusted	The parameter can only be adjusted during quick commissioning.	A parameter can only be adjusted when the motor is switched off
		

The operating state in which you can change a parameter is provided in the List Manual for each parameter.

A.4 Interconnecting signals in the inverter

A.4.1 Fundamentals

The following functions are implemented in the inverter:

- Open-loop and closed-loop control functions
- Communication functions
- Diagnosis and operating functions

Every function comprises one or several blocks that are interconnected with one another.

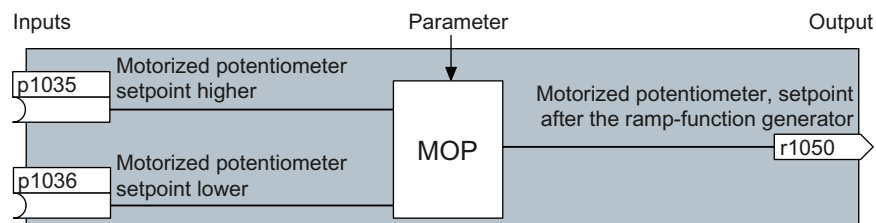

Figure A-3 Example of a block: Motorized potentiometer (MOP)

Most of the blocks can be adapted to specific applications using parameters.

You cannot change the signal interconnection within the block. However, the interconnection between blocks can be changed by interconnecting the inputs of a block with the appropriate outputs of another block.

The signal interconnection of the blocks is realized, contrary to electric circuitry, not using cables, but in the software.

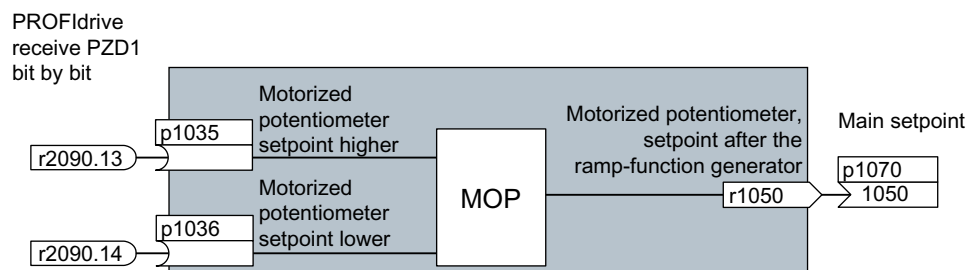

Figure A-4 Example: Signal interconnection of two blocks for digital input 0

Binectors and connectors

Connectors and binectors are used to exchange signals between the individual blocks:

- Connectors are used to interconnect "analog" signals (e.g. MOP output speed)
- Binectors are used to interconnect digital signals (e.g. "Enable MOP up" command)

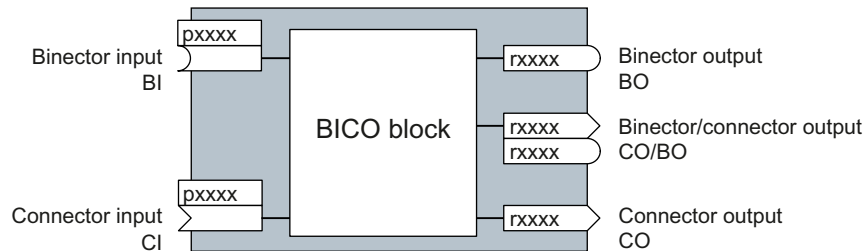

Figure A-5 Symbols for binector and connector inputs and outputs

Binector/connector outputs (CO/BO) are parameters that combine more than one binector output in a single word (e.g. r0052 CO/BO: status word 1). Each bit in the word represents a digital (binary) signal. This summary reduces the number of parameters and simplifies parameter assignment.

Binector or connector outputs (CO, BO or CO/BO) can be used more than once.

Interconnecting signals

When must you interconnect signals in the inverter?

If you change the signal interconnection in the inverter, you can adapt the inverter to a wide range of requirements. This does not necessarily have to involve highly complex functions.

Example 1: Assign a different function to a digital input.

Example 2: Switch the speed setpoint from the fixed speed to the analog input.

Principle when connecting BICO blocks using BICO technology

When interconnecting the signal, the following principle applies: **Where does the signal come from?**

An interconnection between two BICO blocks consists of a connector or a binector and a BICO parameter. The input of a block must be assigned the output of a different block: In the BICO parameters, enter the parameter numbers of the connector/binector that should supply its output signal to the BICO parameter.

How much care is required when you change the signal interconnection?

Note which changes you make. A subsequent analysis of the set signal interconnections is possible only by evaluating the parameter list.

We recommend that you use the STARTER and Startdrive commissioning tools for setting the signal interconnections.

Where can you find additional information?

- This manual suffices for assigning a different meaning to the digital inputs.
- The parameter list in the List Manual is sufficient for more complex signal interconnections.
- The function diagrams in the List Manual provide a complete overview of the factory setting for the signal interconnections and the setting options.

A.4.2 Application example**Shift the control logic into the inverter**

It is only permissible that a conveyor system starts when two signals are present simultaneously. These could be the following signals, for example:

- The oil pump is running (the required pressure level is not reached, however, until after 5 seconds)
- The protective door is closed

To implement this task, you must insert free function blocks between digital input 0 and the command to switch on the motor (ON/OFF1).

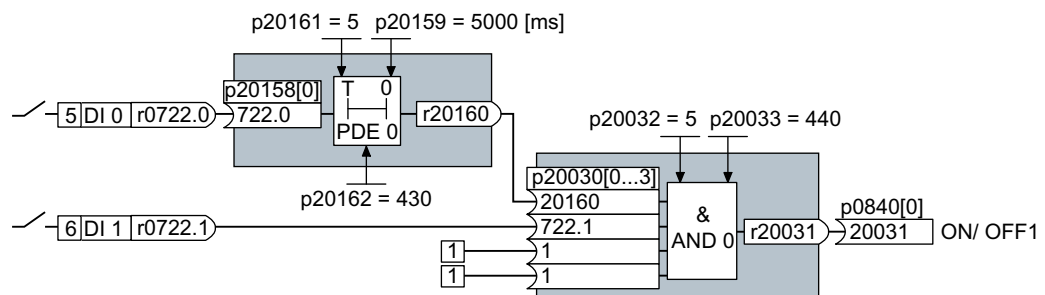

Figure A-6 Signal interconnection for control logic

The signal of digital input 0 (DI 0) is fed through a time block (PDE 0) and is interconnected with the input of a logic block (AND 0). The signal of digital input 1 (DI 1) is interconnected to the second input of the logic block. The logic block output issues the ON/OFF1 command to switch-on the motor.

Setting the control logic

Parameter	Description
p20161 = 5	The time block is enabled by assigning to runtime group 5 (time slice of 128 ms)
p20162 = 430	Run sequence of the time block within runtime group 5 (processing before the AND logic block)
p20032 = 5	The AND logic block is enabled by assigning to runtime group 5 (time slice of 128 ms)
p20033 = 440	Run sequence of the AND logic block within runtime group 5 (processing after the time block)
p20159 = 5000.00	Setting the delay time [ms] of the time module: 5 seconds

Parameter	Description
p20158 = 722.0	Connect the status of DI 0 to the input of the time block r0722.0 = Parameter that displays the status of digital input 0.
p20030[0] = 20160	Interconnecting the time block to the 1st AND input
p20030[1] = 722.1	Interconnecting the status of DI 1 to the 2nd AND input r0722.1 = Parameter that displays the status of digital input 1.
p0840 = 20031	Interconnect the AND output to ON/OFF1

Explanation of the application example using the ON/OFF1 command

Parameter p0840[0] is the input of the "ON/OFF1" block of the inverter. Parameter r20031 is the output of the AND block. To interconnect ON/OFF1 with the output of the AND block, set p0840 = 20031.

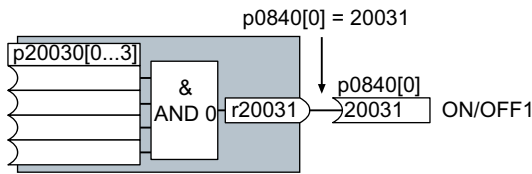

Figure A-7 Interconnecting blocks by setting p0840[0] = 20031

A.5 Application Examples

A.5.1 Setting an absolute encoder

Example for encoder data

In the following example, the inverter must evaluate an SSI encoder. The encoder data sheet also includes the following encoder data:



Table A-8 Excerpt from the data sheet of the absolute encoder

Property	Value
Principle of operation	Multiturn
Operating voltage	10 V ... 30 V
Clock frequency of the SSI interface	100 kHz ... 1 MHz
Digital resolution	25 bit (8192 steps x 4096 revolutions)
SSI telegram	25 bit, without parity
Code type	Gray

Configuring an encoder with Startdrive

When configuring the encoder, you must select an encoder type that has the best possible fit to the real encoder.

Precondition

You have started the commissioning Wizard of the inverter.

Procedure

1. In the "Encoder" commissioning step, select the multiturn encoder with SSI interface.

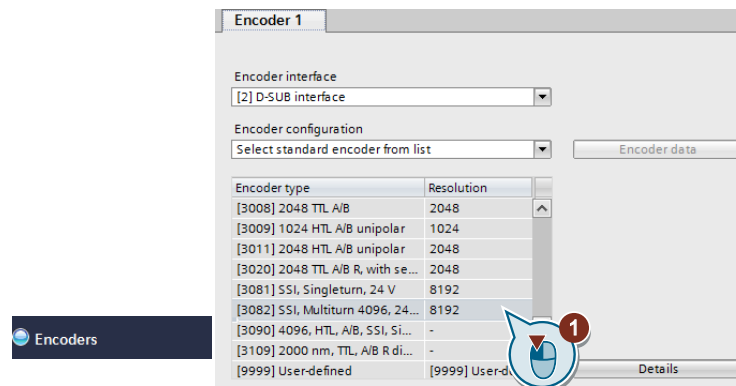

Property	Value	Parameter
Principle of operation	Multiturn	p0404.2 = 1

2. Complete the commissioning Wizard.

You have now configured the absolute encoder.



Adapting the encoder data

After the configuration you may now adapt the encoder data.

Preconditions

- You have now configured an absolute encoder.
- You have completely configured the drive.

Procedure

1. Select the "Motor encoder" screen form.

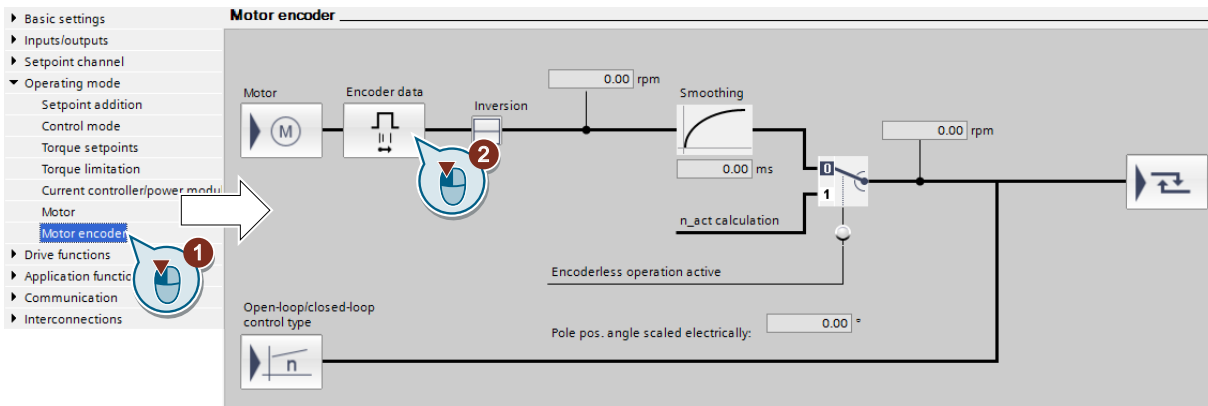

2. Select the "Encoder data" button.

3. ... 10. In the "Encoder data" screen form, adapt the settings corresponding to the data sheet of your encoder.

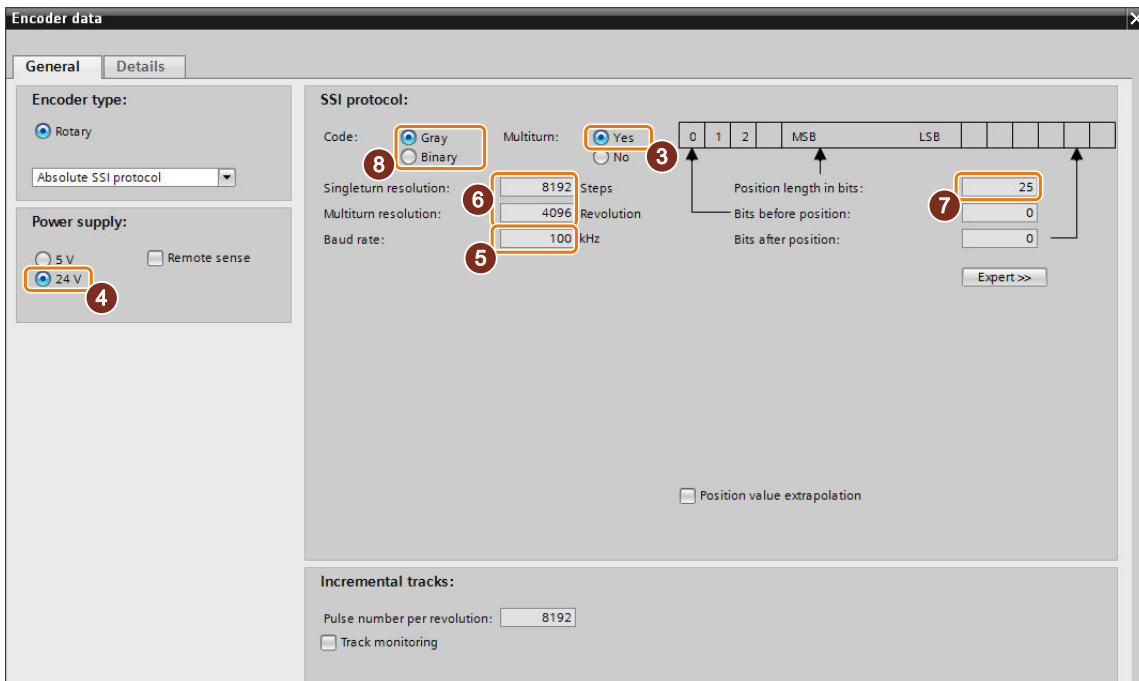

Property	Value	General encoder data	Parameter
Principle of operation	Multiturn	③	p0404.2 = 1
Operating voltage	10 V ... 30 V	④	p0404.21 = 1
Clock frequency of the SSI interface	100 kHz ... 1 MHz	⑤	p0427 = 100
Digital resolution	25 bit (8192 steps x 4096 revolutions)	⑥	p0423 = 8192 p0421 = 4096
SSI telegram	25 bit, without parity	⑦	p0447 = 25
Code type	Gray	⑧	p429.0 = 0

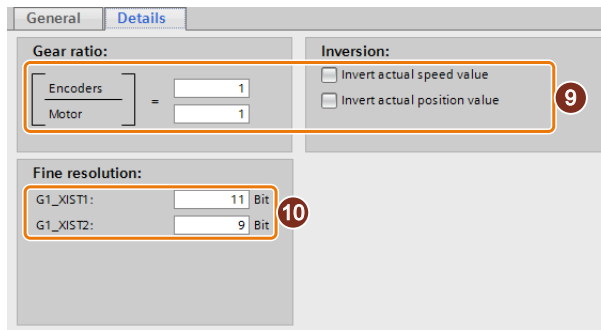

The "Details" tab is used for application-specific settings:

- ⑨ When required, invert the encoder signal.
- ⑩ The fine resolution can be separately set for the process data Gx_XIST1 and Gx_XIST2.
2 bit fine resolution is practical for square wave encoders. Typically, sin/cos encoders have an 11 bit fine resolution.

You have adapted the encoder data.



A.5.2 Connecting a fail-safe digital input

The following examples show the interconnection of a fail-safe digital input corresponding to PL d according to EN 13849-1 and SIL2 according to IEC61508. You can find additional examples and information in the "Safety Integrated" function manual.

Special requirements placed on EMC-compliant installation

Use shielded signal cables. Connect the shield at both conductor ends.

In order to connect two or more inverter terminals, use the shortest possible jumpers directly at the terminals themselves.

The inverter allows a PM-switching output as well as a PP-switching output to be connected.

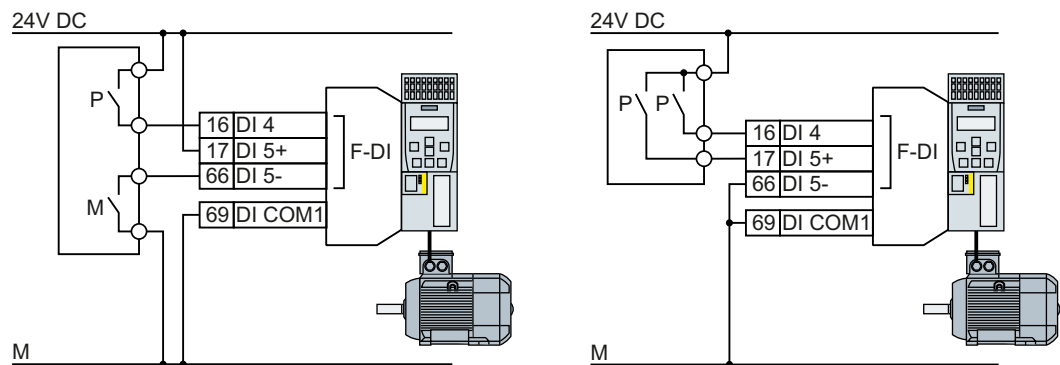

Figure A-8 Connecting a PM-switching and a PP-switching output

The following examples comply with PL d according to EN 13849-1 and SIL2 according to IEC 61508 for the case that all components are installed within one control cabinet.

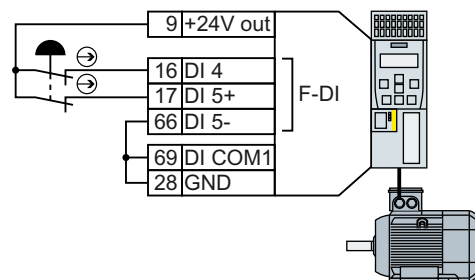

Figure A-9 Connecting a sensor, e.g. Emergency Stop mushroom pushbutton or limit switch

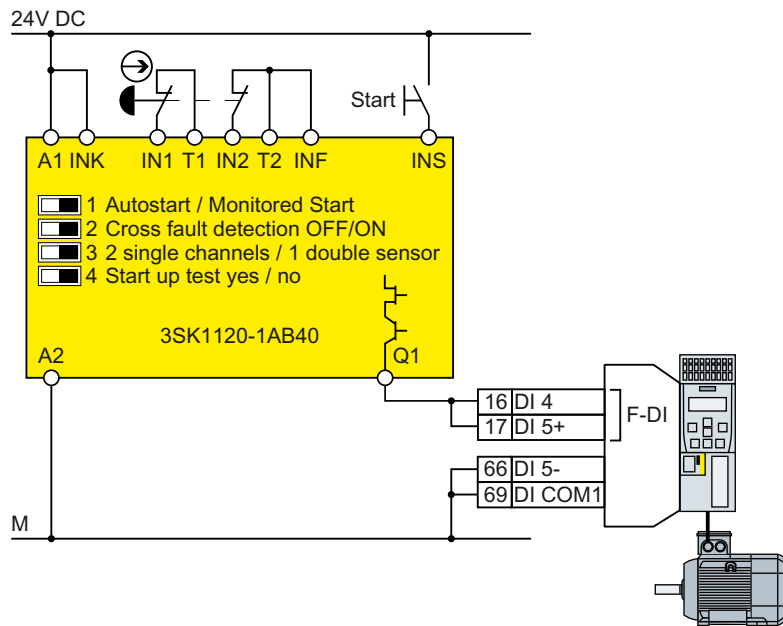

Figure A-10 Connecting a safety relay, e.g. SIRIUS 3SK11

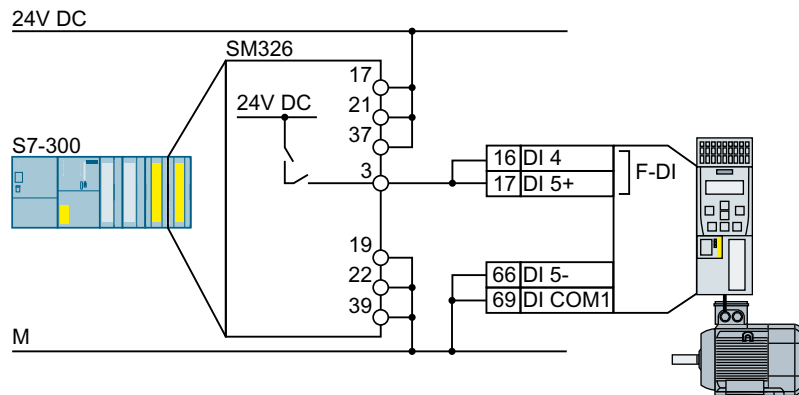



Figure A-11 Connecting an F digital output module, e.g. SIMATIC F digital output module

The Safety Integrated function manual provides additional connection options and connections in separate control cabinets.

 Overview of the manuals (Page 519)

A.6 Acceptance tests for the safety functions

A.6.1 Recommended acceptance test

The following descriptions for the acceptance test are recommendations that illustrate the principle of acceptance. You may deviate from these recommendations if you check the following once you have completed commissioning:

- Correct assignment of the interfaces of each converter with the safety function:
 - Fail-safe inputs
 - PROFIsafe address
- Correct setting of the STO safety function.

Note

Perform the acceptance test with the maximum possible velocity and acceleration in order to test the expected maximum braking distances and braking times.

Note**Non-critical alarms**

The following alarms are issued following each system ramp-up and are not critical for acceptance:

- A01697
 - A01796
-

A.6.2 Acceptance test STO (basic functions)

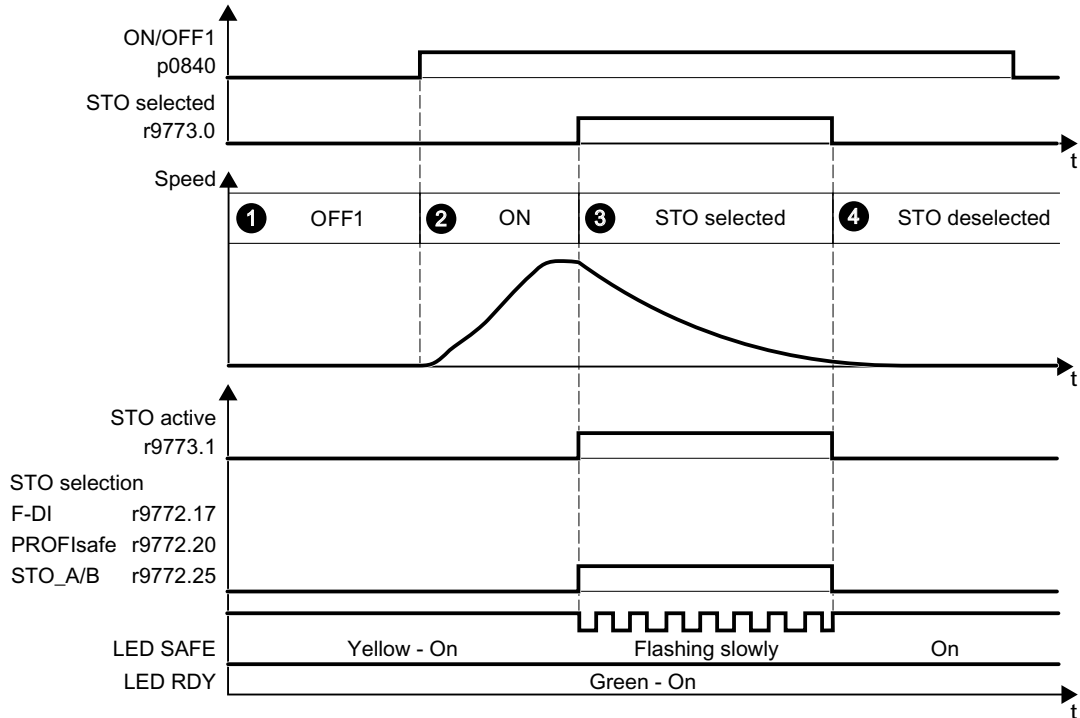

Figure A-12 Acceptance test for STO (Basic Functions)

Procedure

		Status
1.	The inverter is ready	
	<ul style="list-style-type: none"> The inverter signals neither faults nor alarms of the safety functions (r0945[0...7], r2122[0...7]). STO is not active (r9773.1 = 0). 	
2.	Switch on motor	
	2.1. Enter a speed setpoint ≠ 0.	
	2.2. Switch on the motor (ON command).	
	2.3. Check that the correct motor is running.	

			Status
3.	Select STO		
3.1.	Select STO while the motor is running. <i>Test each configured activation, e.g. via digital inputs and PROFIsafe.</i>		
3.2.	Check the following:		
	When controlled via PROFIsafe	When controlled via an F-DI failsafe digital input	When controlled via STO_A and STO_B terminals on a PM240-2 or PM240P-2 Power Module
	<ul style="list-style-type: none"> The inverter signals the following: "STO selection via PROFIsafe" (r9772.20 = 1) 	<ul style="list-style-type: none"> The inverter signals the following: "STO Selection via terminal" (r9772.17 = 1) 	<ul style="list-style-type: none"> The inverter signals the following: "STO Selection via terminal on Power Module" (r9772.25 = 1)
	<ul style="list-style-type: none"> If a mechanical brake is not available, the motor coasts down. A mechanical brake brakes the motor and holds it to ensure that it remains at standstill. 		
	<ul style="list-style-type: none"> The inverter signals neither faults nor alarms of the safety functions (r0945[0...7], r2122[0...7]). 		
	<ul style="list-style-type: none"> The inverter signals the following: "STO is selected" (r9773.0 = 1). "STO is active" (r9773.1 = 1). 		
4.	Deselect STO		
4.1.	Deselect STO.		
4.2.	Check the following:		
	<ul style="list-style-type: none"> STO is not active (r9773.1 = 0). 		
	<ul style="list-style-type: none"> The inverter signals neither faults nor alarms of the safety functions (r0945[0...7], r2122[0...7]). 		

You have performed the acceptance test of the STO function.



A.6.3 Machine documentation

Machine or plant description

Designation	
Type	
Serial number	
Manufacturer	
End customer	
Overview diagram of the machine and/or system:	

Inverter data

The inverter data include the hardware version of the safety-relevant inverter.

Labeling the drive	Article number and hardware version of the inverter

Function table

The active safety functions depending on the operating mode and safety equipment are shown in the function table.

Operating mode	Safety equipment	Drive	Selected safety function	Checked

Table A-9 Example of a function table

Operating mode	Safety equipment	Drive	Selected safety function	Checked
<i>Automatic</i>	<i>Protective door closed</i>	<i>Conveyor belt</i>	---	---
	<i>Protective door open</i>	<i>Conveyor belt</i>	STO	
	<i>Emergency Stop button pressed</i>	<i>Conveyor belt</i>	STO	

Acceptance test reports

File name of the acceptance reports	

Data backup

Data	Storage medium			Holding area
	Archiving type	Designation	Date	
Acceptance test reports				
PLC program				
Circuit diagrams				

Countersignatures**Commissioning engineer**

The commissioning engineer confirms that the tests and checks listed above have been correctly executed.

Date	Name	Company/dept.	Signature
...

Machine manufacturer

The machine OEM confirms the correctness of the settings documented above.

Date	Name	Company/dept.	Signature
...

A.6.4 Documenting the settings for the basic functions, firmware V4.4 ... V4.7 SP6

Drive = <pDO-NAME_v>

Table A-10 Firmware version

Name	Number	Value
Control Unit firmware version	r18	<r18_v>
SI version, safety functions integrated in the drive (processor 1)	r9770	<r9770_v>

Table A-11 Monitoring cycle

Name	Number	Value
SI monitoring clock cycle (processor 1)	r9780	<r9780_v>

Table A-12 Checksums

Name	Number	Value
SI module identifier, Control Unit	r9670	<r9670_v>
SI module identifier, Power Module	r9672	<r9672_v>
SI reference checksum SI parameters (processor 1)	p9799	<p9799_v>
SI reference checksum SI parameters (processor 2)	p9899	<p9899_v>

Table A-13 Settings of the safety functions

Name	Number	Value
SI enable, functions integrated in the drive	p9601	<p9601_v>
<i>Only for the CU250S-2 Control Unit</i> SI enable safe brake control	p9602	<p9602_v>
SI PROFIsafe address	p9610	<p9610_v>
F-DI switch over discrepancy time	p9650	<p9650_v>
SI STO debounce time	p9651	<p9651_v>
<i>Only for the CU250S-2 Control Unit</i> SI Safe Stop 1 delay time	p9652	<p9652_v>
SI forced dormant error detection timer	p9659	<p9659_v>
SI forced checking procedure STO via PM terminals time	p9661	<p9661_v>

Table A-14 Safety logbook

Name	Number	Value
SI change control checksum	r9781[0]	<r9781[0]_v>
SI change control checksum	r9781[1]	<r9781[1]_v>
SI change control time stamp	r9782[0]	<r9782[0]_v>
SI change control time stamp	r9782[1]	<r9782[1]_v>

A.7 Manuals and technical support

A.7.1 Overview of the manuals

Manuals with additional information that can be downloaded

-  CU250S-2 Compact Operating Instructions (<https://support.industry.siemens.com/cs/ww/en/view/109482988>)
Commissioning the inverter.

-  CU250S-2 operating instructions (<https://support.industry.siemens.com/cs/ww/en/view/109482997>)
Installing, commissioning and maintaining the inverters. Advanced commissioning (this manual)

-  EMC installation guideline (<http://support.automation.siemens.com/WWW/view/en/60612658>)
EMC-compliant control cabinet design, equipotential bonding and cable routing









-  "Basic positioner" function manual (<https://support.industry.siemens.com/cs/ww/en/view/109477922>)
Commissioning the basic positioner.

-  "Safety Integrated" function manual (<https://support.industry.siemens.com/cs/ww/en/view/109751320>)
Configuring PROFIsafe. Installing, commissioning and operating failsafe functions of the inverter.

-  "Fieldbus" function manual (<https://support.industry.siemens.com/cs/ww/en/view/109751350>)
Configuring fieldbuses

-  CU250S-2 List Manual (<https://support.industry.siemens.com/cs/ww/en/view/109482981>)
Parameter list, alarms and faults. Graphic function diagrams

-  Power Module Installation Manual (<https://support.industry.siemens.com/cs/ww/en/ps/13224/man>)
Installing Power Modules, reactors and filters. Technical data, maintenance

-  BOP-2 operating instructions (<https://support.industry.siemens.com/cs/ww/en/view/109483379>)
Using the operator panel.

-  Operating instructions IOP-2 (<https://support.industry.siemens.com/cs/ww/en/view/109752613>)
 Using the operator panel, mounting the door mounting kit for IOP.

-  Accessories manual (<https://support.industry.siemens.com/cs/ww/en/ps/13225/man>)
 Descriptions of how to install inverter components, e.g. line reactors and line filters. The printed installation descriptions are supplied together with the components.

-  S110 Manual (<https://support.industry.siemens.com/cs/ww/en/view/109478122>)
 Installing the PM340 Power Module, technical data and maintenance.

-  S120 Manual (<https://support.industry.siemens.com/cs/ww/en/view/109478725>)
 Description of the SMC and SME Sensor Modules

Finding the most recent edition of a manual

If there are multiple editions of a manual, select the latest edition:

> Manual Fieldbus systems: PROFINET, PROFIBUS, EtherNet/IP, CANopen, USS, Bacnet, Modbus, P1

04/2014, FW V4.7.3 Junction manual, A5E34229197B AA

For products: 6SL3544-0MB02-1PA0, 6SL3244-0BB13-1FA0, ... ▶ All products

08/11/2014
ID: 99685159
★★★★☆ (3)

04/2015, FW V4.7.3

04/2015, FW V4.7.3

04/2014, FW V4.7.3

Configuring a manual

Further information about the configurability of manuals is available in the Internet:

 MyDocumentationManager (<https://www.industry.siemens.com/topics/global/en/planning-efficiency/documentation/Pages/default.aspx>).

Select "Display and configure" and add the manual to your "mySupport-documentation":

Function manual
Function Manual
Article number of the documentation: A5E34229197B AA
Description / topic: 04/2014, FW V4.7,

Show and configure
Download (5644 KB)

mySupport Cockpit

> Add to mySupport favorites
> Add to mySupport documentation
> Fav

Not all manuals can be configured.

The configured manual can be exported in RTF, PDF or XML format.

A.7.2 Configuring support

Catalog

Ordering data and technical information for SINAMICS G inverters.



Catalogs for download or online catalog (Industry Mall):

 Everything about SINAMICS G120 (www.siemens.com/sinamics-g120)

SIZER

The configuration tool for SINAMICS, MICROMASTER and DYNAVERT T drives, motor starters, as well as SINUMERIK, SIMOTION controllers and SIMATIC technology



 SIZER on DVD:

Article number: 6SL3070-0AA00-0AG0

 Download SIZER (<http://support.automation.siemens.com/WW/view/en/10804987/130000>)

EMC (electromagnetic compatibility) technical overview

Standards and guidelines, EMC-compliant control cabinet design



 EMC overview (<https://support.industry.siemens.com/cs/ww/en/view/103704610>)

EMC Guidelines configuration manual

EMC-compliant control cabinet design, potential equalization and cable routing



 EMC installation guideline (<http://support.automation.siemens.com/WW/view/en/60612658>)

Safety Integrated for novices technical overview

Application examples for SINAMICS G drives with Safety Integrated



 Safety Integrated for novices (<https://support.industry.siemens.com/cs/ww/en/view/80561520>)

A.7.3 Product Support

You can find additional information about the product on the Internet:



Product support (<https://support.industry.siemens.com/cs/ww/en/>)

This URL provides the following:

- Up-to-date product information (product announcements)
- FAQs
- Downloads
- The Newsletter contains the latest information on the products you use.
- The Knowledge Manager (Intelligent Search) helps you find the documents you need.
- Users and specialists from around the world share their experience and knowledge in the Forum.
- You can find your local representative for Automation & Drives via our contact database under "Contact & Partner".
- Information about local service, repair, spare parts and much more can be found under "Services".

Index

8

87 Hz characteristic, 86

A

Absolute encoder, 507
Absolute value generator, 225
Acceptance test, 256
 Complete, 256
 Reduced scope, 436
 Reduced scope of, 257
 STO (Basic Functions), 514, 515
 Test scope, 257
Acceptance test record, 256
Acyclic communication, 205
ADD, 225
Adder, 225
Agitators, 137, 144
Alarm, 387, 394
Alarm buffer, 394
Alarm code, 394
Alarm history, 395
Alarm time, 394
Alarm value, 394
Ambient temperature, 334
Analog input, 93, 96
 Function, 164, 172
Analog output, 93, 96
 Function, 164, 176
AND, 225
AND block, 225
Application example, 116, 118, 165, 168, 171, 176,
205, 268, 269, 274, 275, 505
 Reading and writing parameters cyclically via
 PROFIBUS, 205
Article number, 30
ASCII code
 Licensing, 497
Automatic mode, 218
Automatic restart, 346
AVA, 225

B

Base load, 444
Base load input current, 444

Base load output current, 444
Base load power, 444
Basic positioner, 158
BF (Bus Fault), 388, 389, 390
BICO block, 503
Bimetallic switch, 330
Binary changeover switch, 226
Binectors, 504
Bit pattern test, 251
Block, 503
BOP-2
 Menu, 498
 Symbols, 498
Brake Relay, 87
Braking
 Regenerative, 325
Braking functions, 316
Braking method, 316, 317
Braking module, 323
Braking resistor, 48, 323
BSW, 226
Bus termination, 92

C

Cable railways, 144
Cable resistance, 288
Catalog, 521
CDS (Command Data Set), 218, 255
Centrifuge, 137, 144, 318, 321, 325
Chain conveyors, 137, 144
Characteristic
 Additional, 292
 Linear, 292, 293
 parabolic, 292, 293
 square-law, 292, 293
Circuit diagram, 517
Clockwise rotation, 177
Closed-loop torque control, 314
Command Data Set, 218
Commissioning
 Guidelines, 125
Communication
 Acyclic, 205
Comparator, 230
Compound braking, 321, 322
Compressor, 137, 144
Computational performance, 133
Configuring support, 521

Connectors, 504
Consistency, 250
Consistent signals, 250
Contact bounce, 251
Control terminals, 96
Control Units, 30
Control word
 Control word 1, 187, 206, 210
 Control word 2, 190
 Control word 3, 191
Control word 2 (STW2), 190
Control word 3 (STW3), 191
Controlling the motor, 177
Conveyor belt, 137, 144, 318
Conveyor systems, 145
Copy
 Series commissioning, 257
Copy parameters (series commissioning), 257
Counter-clockwise rotation, 177
Countersignatures, 517
Crane, 221
Crushers, 137, 144
Current input, 170
Current reduction, 476
Cyclic communication, 186, 187

D

D flip-flop, 226
Data backup, 361, 368, 373, 375, 517
Data set 47 (DS), 205
Data set changeover, 255
Data transfer, 368, 373, 375
DC braking, 191, 318, 319, 320
DC-link overvoltage, 335
DC-link voltage, 335
Dead band, 173
Delta connection, 86
Delta connection (Δ), 127
Derating
 Installation altitude, 478
DFR, 226
DIF, 227
Differentiator, 227
Digital input, 93, 96, 177
 Function, 164
Digital inputs
 Multiple assignment, 255
Digital output, 93, 96
 Function, 164, 168
DIP switch
 Analog input, 170

Direct data exchange, 205
Direction of rotation, 273
Direction reversal, 177
Discrepancy, 250
 Filter, 250
 Tolerance time, 250
DIV, 227
Divider, 227
Download, 368, 373, 375
Drive control, 157
Drive Data Set, DDS, 359
Drive Data Sets, 359
Droop, 303
dv/dt filter, 289
Dynamic braking, 323

E

Elevator, 144, 221
EMC, 53
EMERGENCY STOP, 245
Emergency Stop button, 245
EMERGENCY SWITCHING OFF, 245
EN 60204-1, 245
EN 61800-5-2, 245
Encoder, 300
Encoder cable, 121, 123
Encoder cables, 112
Encoder data, 509
End customer, 516
Energy recovery, 36
Energy recovery option, 325
Energy-saving display, 357
Escalator, 144
EXCLUSIVE OR block, 235
Extruder, 137, 144, 329

F

Factory assignment, 96
Factory settings, 152
 Restoring the, 152, 153, 155
Failsafe digital input, 167
Fan, 137, 144, 145
Fans, 328
Fault, 387, 397
 Acknowledge, 397, 398
 Motor, 438
Fault buffer, 397
Fault case, 399
Fault code, 397

Fault history, 398
 Fault time, 397
 received, 397
 removed, 397
 Fault value, 397
 FCC, 289
 F-DI (Failsafe Digital Input), 167
 F-digital output module, 512
 FFC (Flux Current Control), 292
 Field weakening, 86
 Fieldbus interfaces, 92
 Filter
 Contact bounce, 251
 Discrepancy, 250
 On/off test, 251
 Fine resolution, 510
 Firmware, 30
 Firmware downgrade, 433
 Firmware update, 436
 Firmware version, 413, 481, 482, 483, 484, 485, 486,
 487, 488, 489, 490, 491, 516
 Flip-flop, 226, 234
 Flow control, 283
 Flux current control, 289
 Flying restart, 344
 Forced checking procedure, 252
 Forced dormant error detection
 setting, 253
 Formatting, 363
 Forming the DC link capacitors, 128
 Free function blocks, 224
 Function module, 132
 Function table, 516
 Functional expansions, 257
 Functions
 BOP-2, 498

G

Gantry crane, 144
 Getting Started, 519
 Grinding machine, 318, 321

H

Hardware Installation Manual, 519
 High Overload, 444
 Hoist drive, 325
 Hoisting gear, 221, 323
 Horizontal conveyors, 321, 323, 329
 Hotline, 522

I

I_max controller, 326
 I2t monitoring, 327
 Inclined conveyors, 323
 IND (page index), 200
 Industry Mall, 521
 Installation altitude, 478
 Installing, 60
 INT, 227
 Integrator, 227
 Interfaces, 92
 Interlock, 505
 Inverter, 230
 does not respond, 437
 Update, 436
 Inverter components, 413

J

JOG function, 214

K

Kinetic buffering, 350
 Kneaders, 137, 144
 Know-how protection, 364, 381
 KTY84 sensor, 330

L

LED
 BF, 388, 389, 390
 LNK, 389
 RDY, 388
 SAFE, 389
 LED (light emitting diode), 387
 Level control, 283
 License, 158, 364
 License key
 Create, 493
 Display, 493
 Entering in STARTER, 496
 Entry using the BOP-2, 497
 Licensing
 ASCII code, 497
 Lifter, 144
 LIM, 228
 Limit monitor, 228

Limit position, 216
Limit position control, 216
Limit switch, 216
Limiter, 228
Line and motor connection, frame sizes
FSD ... FSF, 85
Line contactor, 244
Line dip, 350
Line filter, 39
Linear characteristic, 292, 293
List Manual, 519
LNK (PROFINET Link), 389
Load failure, 342
Low Overload, 444
Lowerer, 144
LVM, 228

M

Machine description, 516
Main screen form (basic functions), 249
Manual mode, 218
Manufacturer, 516
Maximum cable length
DRIVE-CLiQ, 442
Encoder, 442
PROFIBUS, 118
PROFINET, 115
Maximum current controller, 326
Maximum speed, 131, 273
MELD_NAMUR (fault word according to the VIK-
Namur definition), 193
Memory cards, 362
Menu
BOP-2, 498
Operator panel, 498
MFP, 229
Mills, 137, 144
Minimum speed, 131, 273, 276
Mixers, 137, 144
MMC (memory card), 363
Moment of inertia estimator, 308
MOP (motorized potentiometer), 264
Motor control, 159
Motor data, 127
Identify, 301, 314
Motor fault, 438
Motor holding brake, 220, 221, 244
Motor standard, 238
Motor temperature sensor, 93, 96, 331
Motorized potentiometer, 264
MUL, 229

Multiple assignment
Digital inputs, 255
Multiplier, 229
Multiturn encoder, 507

N

NCM, 230
NOT, 230
NSW, 230
Numeric changeover switch, 230

O

OFF delay, 232
OFF1 command, 177
OFF3 ramp-down time, 279
ON command, 177
ON delay, 232
On/off test, 251
Operating instruction, 25
Operating Instructions, 519
Operating mode, 516
Operation, 162
Operator panel
BOP-2, 498
Menu, 498
Optimizing the closed-loop speed controller, 301
OR, 231
OR block, 231
Output reactor, 288
Overload, 326
Overview
Section, 26, 27
Overvoltage, 335

P

Page index, 200
Parabolic characteristic, 292, 293
Parameter channel, 198
IND, 200
Parameter index, 200
Parameter number, 200, 501
Parameter value, 501
Partial load operation, 477
password, 247
PCL, 231
PDE, 232
PDF, 232
PFH (Probability of failure per hour), 441

PID controller, 283
 PKW (parameter, ID value), 183
 Plant description, 516
 PLC functionality, 505
 PLC program, 517
 PLI, 233
 Polyline, 233
 Power failure, 346
 Power Module, 30
 Pre-control, 311
 Prefabricated encoder cable, 121, 123
 Pressure control, 283
 Probe, 271, 343
 Procedure, 25
 PROFIBUS, 118
 PROFIdrive, 113, 114
 PROFIenergy, 113, 114
 PROFIsafe, 113, 114
 Protection functions, 159
 PST, 233
 PT1, 234
 Pt1000 sensor, 330
 PTC sensor, 330
 Pulse cancelation, 187, 207, 210
 Pulse enable, 187, 207, 210
 Pulse frequency, 328, 329, 476
 Pulse generator, 229
 Pulse shortener, 231
 Pulse stretcher, 233
 Pulse train, 271
 Pump, 137, 144, 145
 PZD (process data), 183

Q

Questions, 522

R

Ramp-down time, 279, 281
 Scaling, 281
 Ramp-function generator, 273, 278
 Rampup time, 279, 281
 Ramp-up time
 Scaling, 281
 RDY (Ready), 388
 Ready, 162
 Ready for switching on, 162
 Regenerative feedback, 325
 Regenerative operation, 316

Replace
 Control Unit, 436
 Gear unit, 436
 Hardware, 436
 Motor, 436
 Power Module, 436
 Reset
 Parameter, 152, 153, 155
 Reversing, 273
 Roller conveyors, 137, 144
 Rotary furnace, 137, 144
 Rounding, 279
 Rounding OFF3, 279
 RS flip-flop, 234
 RSR, 234
 Run sequence, 224
 Runtime group, 224

S

S7 communication, 113, 114
 SAFE, 389
 Safe Brake Relay, 50, 87, 253
 Safety function, 158
 Safety relay, 512
 Saw, 318, 321
 Scaling
 Analog input, 171
 Analog output, 174
 SD (memory card), 363
 Formatting, 363
 MMC, 363
 Self-test, 252
 Sensor
 Electromechanical, 511
 Sensor Module, 52, 121, 123, 520
 Sequence control, 162
 Serial number, 516
 Series commissioning, 257, 361
 Setpoint processing, 158, 273
 Setpoint source, 158
 Selecting, 260, 262, 264
 Settling time, 137, 144
 Shield connection kit, 38
 Short-circuit monitoring, 330, 331
 Signal cables, 112
 Signal interconnection, 503
 Signal states, 388
 Sine-wave filter, 47, 288
 SIZER, 521
 Skip frequency band, 273
 Slip compensation, 289

SMC (Sensor Module Cabinet), 52, 123
 SMC: Sensor Module Cabinet, 121
 SME (Sensor Module External), 52, 123
 SME: Sensor Module External, 121
 Smoothing element, 234
 Speed
 change with BOP-2, 498
 Limiting, 273
 Speed control, 298
 Speed monitoring, 342
 Spindle, 137, 144
 Square-law characteristic, 292, 293
 Stacker crane, 144
 Standards
 EN 61800-3, 31
 Star connection (Y), 86
 Startdrive, 246, 373
 Startdrive commissioning tool, 246
 Startdrive PC tool, 246
 STARTER, 246
 Download, 126
 STARTER commissioning tool, 246
 STARTER PC tool, 246
 Starting behavior
 Optimization, 294, 296
 Starting current, 290
 State overview, 162
 Status word
 Status word 1, 188, 207, 211
 Status word 2, 190
 Status word 3, 192
 Status word 1 (ZSW2), 190
 STO (Safe Torque Off), 244
 Acceptance test, 514, 515
 select, 244
 Stop Category 0, 245
 Storage medium, 361
 STW1 (control word 1), 187, 206, 210
 SUB, 234
 Subindex, 200
 Subtractor, 234
 Support, 522
 Switch off
 Motor, 163
 OFF1 command, 163
 OFF2 command, 163
 OFF3 command, 163
 Switch on
 Motor, 163
 ON command, 163
 Switching on inhibited, 162, 188, 207, 210
 Switching-on a motor with BOP-2, 498

Switch-off signal paths, 252
 Symbols, 25
 System runtime, 392

T

Technical data
 Control Unit, 439, 440, 441
 Technology controller, 191, 240, 283
 Telegram
 Extending, 203
 Temperature calculation, 333
 Temperature monitoring, 327, 333
 Temperature sensor, 93, 96
 Temperature switch, 330
 Terminal block, 164
 Terminal strip, 111
 Factory setting, 96
 Overview, 93
 Test signals, 251
 Three-wire control, 177
 Time slice, 224
 Torque accuracy, 137, 144
 Two-wire control, 177
 Type plate
 Control Unit, 30
 Power Module, 30

U

Unit system, 238
 Unwinders, 325
 Update
 Firmware, 436
 Upgrading the firmware, 431
 Upload, 365, 373, 375
 Use for the intended purpose, 29
 User interfaces, 92

V

V/f characteristic, 289
 VDC min controller, 350
 Vector control, 298, 301, 314
 Version
 Control Unit, 30
 Firmware, 516
 Hardware, 516
 Power Module, 30
 Safety function, 516
 Vertical conveyors, 323

Voltage boost, 289, 290, 294, 296
Voltage input, 170

W

Winders, 325
Wire breakage, 250
Wire-break monitoring, 171, 330, 331
Write protection, 378

X

XOR, 235

Z

ZSW1 (status word 1), 188, 207, 211
ZSW3 (status word 3), 192

Further information

SINAMICS converters:

www.siemens.com/sinamics

Safety Integrated

www.siemens.com/safety-integrated

PROFINET

www.siemens.com/profinet

Siemens AG
Digital Factory
Motion Control
Postfach 3180
91050 ERLANGEN
Germany

Scan the QR code for
additional
information about
SINAMICS G120.

