

SINAMICS G120

Frequency inverter

with the Control Units

CU240B-2

CU240B-2 DP

CU240E-2

CU240E-2 DP

CU240E-2 F

CU240E-2 DP-F

Operating Instructions · 07/2010



SINAMICS

Answers for industry.

SIEMENS

SIEMENS

SINAMICS

SINAMICS G120 Inverter with CU240B-2 and CU240E-2 Control Units

Operating Instructions

<u>Introduction</u>	1
<u>Description</u>	2
<u>Connecting</u>	3
<u>Commissioning</u>	4
<u>Configuring the terminal block</u>	5
<u>Connection to a fieldbus</u>	6
<u>Functions</u>	7
<u>Service and maintenance</u>	8
<u>Alarms, faults and system messages</u>	9
<u>Technical data</u>	10

07/2010 Edition, Firmware V4.3.2

Legal information

Warning notice system

This manual contains notices you have to observe in order to ensure your personal safety, as well as to prevent damage to property. The notices referring to your personal safety are highlighted in the manual by a safety alert symbol, notices referring only to property damage have no safety alert symbol. These notices shown below are graded according to the degree of danger.

⚠ DANGER
indicates that death or severe personal injury will result if proper precautions are not taken.
⚠ WARNING
indicates that death or severe personal injury may result if proper precautions are not taken.
⚠ CAUTION
with a safety alert symbol, indicates that minor personal injury can result if proper precautions are not taken.
CAUTION
without a safety alert symbol, indicates that property damage can result if proper precautions are not taken.
NOTICE
indicates that an unintended result or situation can occur if the corresponding information is not taken into account.

If more than one degree of danger is present, the warning notice representing the highest degree of danger will be used. A notice warning of injury to persons with a safety alert symbol may also include a warning relating to property damage.

Qualified Personnel

The product/system described in this documentation may be operated only by **personnel qualified** for the specific task in accordance with the relevant documentation for the specific task, in particular its warning notices and safety instructions. Qualified personnel are those who, based on their training and experience, are capable of identifying risks and avoiding potential hazards when working with these products/systems.

Proper use of Siemens products

Note the following:

⚠ WARNING
Siemens products may only be used for the applications described in the catalog and in the relevant technical documentation. If products and components from other manufacturers are used, these must be recommended or approved by Siemens. Proper transport, storage, installation, assembly, commissioning, operation and maintenance are required to ensure that the products operate safely and without any problems. The permissible ambient conditions must be adhered to. The information in the relevant documentation must be observed.

Trademarks

All names identified by ® are registered trademarks of the Siemens AG. The remaining trademarks in this publication may be trademarks whose use by third parties for their own purposes could violate the rights of the owner.

Disclaimer of Liability

We have reviewed the contents of this publication to ensure consistency with the hardware and software described. Since variance cannot be precluded entirely, we cannot guarantee full consistency. However, the information in this publication is reviewed regularly and any necessary corrections are included in subsequent editions.

Table of contents

1	Introduction.....	11
1.1	About this manual	11
1.2	Guide through this manual.....	12
1.3	Overview of documentation	13
1.4	Adapting the inverter in line with the application.....	15
1.4.1	General basics	15
1.4.2	Parameter	16
1.4.3	Parameters with follow-on parameterization.....	16
1.4.4	Parameter changes, which subsequently result in internal calculations.....	17
1.5	Frequently required parameters.....	18
1.6	Extended scope for adaptation	20
1.6.1	BICO technology: basic principles	20
1.6.2	BICO technology: example	22
2	Description.....	25
2.1	Modularity of the converter system	25
2.2	Overview of Control Units	26
2.3	Power Module	27
2.4	Reactors and filters	29
3	Connecting	31
3.1	Procedure for installing the frequency inverter	31
3.2	Installing reactors and filters	32
3.3	Installing the Power Module.....	33
3.3.1	Installing Power Modules	33
3.3.2	Dimensions, hole drilling templates, minimum clearances, tightening torques	34
3.3.3	Connection overview for Power Module	43
3.3.4	Connecting the line supply and motor	44
3.3.5	EMC-compliant connection	46
3.4	Installing Control Unit.....	50
3.4.1	Snapping the Control Unit onto the Power Module.....	50
3.4.2	Interfaces, connectors, switches, terminal blocks and LEDs of the CU	51
3.4.3	Terminal strips on CU240B-2 and CU240E-2 Control Units.....	52
3.4.4	Wiring terminal strips	54
4	Commissioning	55
4.1	Typical commissioning scenarios	55
4.2	Preparing commissioning.....	57
4.3	Commissioning with factory settings.....	60
4.3.1	Prerequisites for using the factory settings.....	60
4.3.2	Inverter factory setting	60

4.3.3	Pre-assignment of the inputs and outputs	62
4.3.4	Wiring examples for the factory settings	64
4.4	Commissioning with the BOP-2	68
4.4.1	Inserting the BOP-2.....	68
4.4.2	Display of the BOP-2.....	68
4.4.3	Menu structure	69
4.4.4	Changing parameter values	70
4.4.5	Basic commissioning.....	71
4.4.6	Additional settings	72
4.5	Commissioning with STARTER	73
4.5.1	Overview	73
4.5.2	Requirements.....	73
4.5.3	Installing USB drivers.....	74
4.5.4	System settings in the PC/PG for the USB interface	75
4.5.5	Creating a STARTER project.....	77
4.5.6	Establishing an online connection between the PC and converter (going "online")	80
4.5.7	Basic commissioning.....	81
4.5.8	Additional settings	84
4.6	Back-up the settings and transfer	86
4.6.1	External data backup and series commissioning.....	86
4.6.2	Backing up and transferring settings using STARTER	86
4.6.3	Backing up and transferring settings using BOP-2	87
4.6.4	Saving setting on memory card	87
4.6.5	Transferring the setting from the memory card.....	89
4.6.6	Safely remove the memory card	90
4.6.7	Other ways to back up settings	91
4.7	Restoring the factory setting	92
5	Configuring the terminal block	93
5.1	Digital inputs.....	93
5.2	Fail-safe digital input	95
5.3	Digital outputs	96
5.4	Analog inputs	97
5.5	Analog outputs	100
6	Connection to a fieldbus	103
6.1	Data exchange via the fieldbus.....	103
6.2	Setting the bus address via DIP switch.....	104
6.3	Communication via PROFIBUS	105
6.3.1	Configuring communication via PROFIBUS	105
6.3.1.1	Task.....	105
6.3.1.2	Required components.....	106
6.3.1.3	Setting the PROFIBUS address.....	107
6.3.1.4	Creating a STEP 7 project	107
6.3.1.5	Inverter GSD	108
6.3.1.6	Inserting the inverter into the STEP 7 project	109
6.3.2	Communication parameters	111
6.3.3	Cyclic communication	112
6.3.3.1	Control and status words	113
6.3.3.2	Data structure of the parameter channel	118

6.3.4	Acyclic communication.....	123
6.3.4.1	Acyclic communication over PROFIBUS DP (DP V1).....	123
6.3.5	STEP 7 program examples.....	124
6.3.5.1	STEP 7 program example for cyclic communication.....	124
6.3.5.2	STEP 7 program example for acyclic communication.....	126
6.4	Communication via RS485.....	130
6.4.1	Integrating inverters into a bus system via the RS485 interface.....	130
6.4.2	Communication via USS.....	131
6.4.2.1	General information about communication with USS via RS485.....	131
6.4.2.2	Structure of a USS telegram.....	133
6.4.2.3	User data range of the USS telegram.....	135
6.4.2.4	Data structure of the USS parameter channel.....	135
6.4.2.5	USS read request.....	140
6.4.2.6	USS write job.....	140
6.4.2.7	USS process data channel (PZD).....	141
6.4.2.8	Telegram monitoring.....	142
6.4.3	Communication over Modbus RTU.....	144
6.4.3.1	Parameters for Modbus communication settings.....	144
6.4.3.2	Modbus RTU telegram.....	146
6.4.3.3	Baud rates and mapping tables.....	147
6.4.3.4	Write and read access via FC 3 and FC 6.....	150
6.4.3.5	Communication procedure.....	152
7	Functions.....	155
7.1	Overview of the inverter functions.....	155
7.2	Inverter control.....	157
7.3	Command sources.....	158
7.4	Setpoint sources.....	159
7.4.1	Selecting the setpoint source.....	159
7.4.2	Analog input as setpoint source.....	160
7.4.3	Motorized potentiometer as setpoint source.....	160
7.4.4	Fixed speed as setpoint source.....	163
7.4.5	Running the motor in jog mode (JOG function).....	165
7.4.6	Specifying the motor speed via the fieldbus.....	166
7.5	Setpoint calculation.....	166
7.5.1	Minimum speed and maximum speed.....	166
7.5.2	Ramp-function generator.....	167
7.6	Motor control.....	168
7.6.1	V/f control.....	169
7.6.1.1	V/f control with linear characteristic.....	170
7.6.1.2	Additional characteristics for the V/f control.....	171
7.6.1.3	Optimizing with a high break loose torque and brief overload.....	172
7.6.2	Vector control.....	173
7.6.2.1	Properties of vector control.....	173
7.6.2.2	Commissioning vector control.....	173
7.6.2.3	Torque control.....	174
7.7	Protection functions.....	175
7.7.1	Inverter temperature monitoring.....	175
7.7.2	Motor temperature monitoring using a temperature sensor.....	176
7.7.3	Protecting the motor by calculating the motor temperature.....	178
7.7.4	Overcurrent protection.....	178
7.7.5	Limiting the maximum DC link voltage.....	179

7.7.6	Load torque monitoring (system protection)	181
7.7.7	Speed and load failure via digital input	183
7.8	Status messages.....	186
7.8.1	Overview, evaluating the inverter state.....	186
7.8.2	System runtime	186
7.9	Technological functions.....	187
7.9.1	Braking functions of the inverter	187
7.9.1.1	Comparison of electrical braking methods.....	187
7.9.1.2	DC braking	190
7.9.1.3	Compound braking.....	192
7.9.1.4	Dynamic braking	194
7.9.1.5	Braking with regenerative feedback to the line	196
7.9.1.6	Motor holding brake	197
7.9.2	Automatic restart and flying restart	203
7.9.2.1	Flying restart – switching on while the motor is running	203
7.9.2.2	Automatic switch-on	205
7.9.3	PID technology controller	209
7.9.4	Logical and arithmetic functions using function blocks	210
7.10	Safe Torque Off (STO) safety function	214
7.10.1	Prerequisite for STO use.....	214
7.10.2	Permitted sensors	214
7.10.3	Connecting fail-safe digital inputs	215
7.10.4	F-DI signal filtering	216
7.10.5	Forced dormant error detection	219
7.10.6	Password.....	220
7.10.7	Commissioning the STO	220
7.10.7.1	Defining commissioning method.....	221
7.10.7.2	Assigning parameters to the STO.....	221
7.10.7.3	Activate settings.....	222
7.10.7.4	Multiple assignment of the DI.....	222
7.10.8	Acceptance test - following completion of commissioning	224
7.10.8.1	Prerequisites and authorized persons	224
7.10.8.2	Complete acceptance test.....	224
7.10.8.3	Reduced acceptance test.....	225
7.10.8.4	Documentation	226
7.10.8.5	Completion of the certificate.....	228
7.11	Switchover between different settings	230
7.11.1	Changing over the command data sets (manual, automatic)	230
7.11.2	Switching over drive data sets (different motors connected to an inverter).....	233
8	Service and maintenance	237
8.1	Replacing the inverter components	237
8.2	Replacing the Control Unit	239
8.3	Replacing the Power Module	241
9	Alarms, faults and system messages.....	243
9.1	Operating states indicated on LEDs	244
9.2	Alarms	246
9.3	List of warnings	249
9.4	Faults.....	251

9.5	List of faults	256
10	Technical data	261
10.1	Technical data, CU240B-2 Control Unit.....	261
10.2	Technical data, CU240E-2 Control Unit.....	262
10.3	Technical data, Power Modules.....	263
10.3.1	Technical data, PM240	265
10.3.2	Technical data, PM240-2	271
10.3.3	Technical data, PM250	274
10.3.4	Technical data, PM250-2	277
10.3.5	Technical data, PM260	281
	Index.....	283

Introduction

1.1 About this manual

Who requires the operating instructions and what for?

These operating instructions primarily address fitters, commissioning engineers and machine operators. The operating instructions describe the devices and device components and enable the target groups being addressed to install, connect-up, parameterize, and commission the inverters safely and in the correct manner.

What is described in the operating instructions?

These operating instructions provide a summary of all of the information required to operate the inverter under normal, safe conditions.

The information provided in the operating instructions has been compiled in such a way that it is sufficient for all standard applications and enables drives to be commissioned as efficiently as possible. Where it appears useful, additional information for entry level personnel has been added.

The operating instructions also contain information about special applications. Since it is assumed that readers already have a sound technical knowledge of how to configure and parameterize these applications, the relevant information is summarized accordingly. This relates, e.g. to operation with fieldbus systems and safety-related applications.

Mistakes and improvements

If you encounter mistakes when reading this manual or if you have any suggestions for how it can be improved, please contact us at the following address or send your suggestion by E-mail:

Siemens AG
Drive Technologies
Motion Control Systems
Postfach 3180
91050 Erlangen, Germany

E-mail (<mailto:documentation.standard.drives@siemens.com>)

If you have further questions

Further information is provided in the STARTER PC tool's online help, the parameter manual and the installation instructions. In addition, you will find Internet product support: Product support (<http://support.automation.siemens.com/WW/view/en/4000024>).

1.2 Guide through this manual

In this manual, you will find background information on your inverter, as well as a full description of the commissioning procedure:

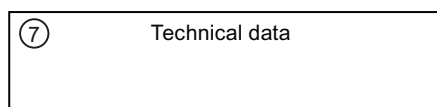
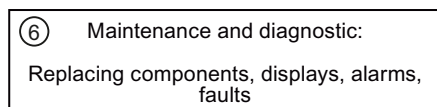
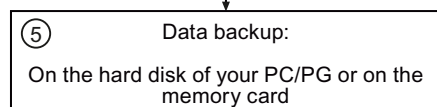
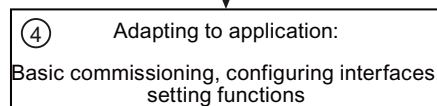
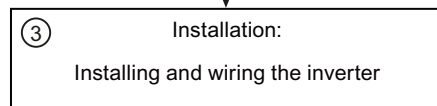
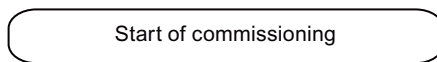
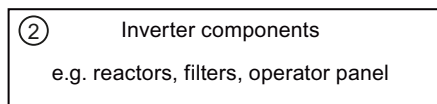
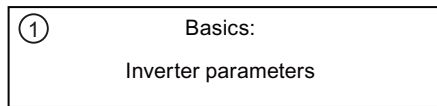

- ① Should you be unfamiliar with assigning parameters to the inverter, background information can be found here:
- Adapting the inverter in line with the application (Page 15)
 - Frequently required parameters (Page 18)
 - Extended scope for adaptation (Page 20)
- ② Information on the inverter hardware can be found here:
- Modularity of the converter system (Page 25)

All information relating to the commissioning of your inverter is located in the following chapters:

- ③
- Procedure for installing the frequency inverter (Page 31)
- ④
- Commissioning (Page 55)
 - Configuring the terminal block (Page 93)
 - Connection to a fieldbus (Page 103)
- ⑤
- Back-up the settings and transfer (Page 86)

- ⑥ Information regarding the maintenance and diagnostics of your inverter is located in the following chapters:
- Service and maintenance (Page 237)
 - Alarms, faults and system messages (Page 243)
- ⑦ The most important technical data for your inverter is located in this chapter:
- Technical data (Page 261)

1.3 Overview of documentation

Manuals and software are available for every inverter application:

Table 1- 1 Documentation for SINAMICS G120

Planning and configuring	Installation and connection	Commissioning	Service and maintenance
SIZER engineering tool	---	---	---
Configuration Manual Selecting geared motors, motors and inverters using calculation examples	---	---	---
Hardware Installation Manual, Power Modules Comprehensive information on every Power Module. Available for: <ul style="list-style-type: none"> • PM230 • PM240 • PM250 • PM260 		---	Hardware Installation Manual, Power Modules (refer to the lefthand column)
Function Manual, Safety Integrated Comprehensive information about the integrated safety functions of the CU240E-2 Control Unit			
Operating instructions Contains extensive information for most applications. Available for the following Control Units: <ul style="list-style-type: none"> • CU230P-2 • CU240B-2 and CU240E-2 • CU240E and CU240S 			
---	---	STARTER Commissioning tool	
Getting Started For entry level personnel to switch on the motor for the first time. Available for Control Units: <ul style="list-style-type: none"> • CU230P-2 • CU240B-2 and CU240E-2 • CU240E • CU240S 			---
---	---	Parameter Manual Contains detailed lists of all parameters, alarms and faults as well as graphic function block diagrams. Available for the following Control Units: <ul style="list-style-type: none"> • CU230P-2 • CU240B-2 and CU240E-2 • CU240E and CU240S 	

This is how you find the software and the manuals

SIZER	You obtain SIZER on a DVD (Order number: 6SL3070-0AA00-0AG0) and can be downloaded from the Internet: SIZER (http://support.automation.siemens.com/WW/view/en/10804987/130000)
Configuration Manual	You can obtain the Configuration Manual from your local sales office
STARTER	You obtain STARTER on a DVD (Order number: 6SL3072-0AA00-0AG0) and can be downloaded from the Internet: STARTER (http://support.automation.siemens.com/WW/view/en/10804985/130000)
Getting Started	A paper copy of "Getting Started" is provided with each Control Unit
Operating instructions and manuals	All of the manuals can be downloaded from the Internet: Documentation (http://support.automation.siemens.com/WW/view/en/22339653/133300) and are also available on DVD: SD Manual Collection - all of the manuals on low-voltage motors, geared motors and low-voltage inverters, 5 languages <ul style="list-style-type: none">• Order number: 6SL3298-0CA00-0MG0 (supplied once)• Order number: 6SL3298-0CA10-0MG0 (update service for 1 year; supplied 4 times)

1.4 Adapting the inverter in line with the application

1.4.1 General basics

Adapting the inverter to the drive task

By means of commissioning with prompting, the inverter is adapted to the motor and the drive task so that the motor can be optimally operated and protected.

Functions extending beyond commissioning are activated and adapted by changing parameters directly.

Both commissioning and the parameterization of functions may be undertaken with one of the following operating units:

- Keyboard and display unit (Operator Panel) that is snapped onto the inverter.
 - BOP-2 Basic Operator Panel-2
 - IOP Intelligent Operator Panel
- Software (STARTER commissioning tool) that allows the inverter to be parameterized and controlled from a PC.

Inverters are especially used to improve and expand the starting and speed response of motors.

Many standard applications can function with the default parameters set in the factory

Although inverters can be parameterized for very specific applications, many standard applications can be configured by means of just a few parameters.

Use the factory settings (where possible)

For basic applications, commissioning can be carried out using just the factory settings (see Commissioning with factory settings (Page 60)).

Use quick commissioning (for simple, standard applications)

In the majority of standard applications, commissioning can be carried out by entering or changing just a few parameters during quick commissioning.

1.4.2 Parameter

There are two types of parameters, adjustable and display parameters.

Adjustable parameters

Adjustable parameters are preceded with the letter "P". You can change the value of these parameters within a defined range.

Example:

P0305 is the parameter for the rated motor current in Amps. This parameter is set during commissioning. You can enter values between 0.01 and 10000.

Change protection for setting parameters

The process of changing parameter values is subject to certain conditions. If an attempt to change a parameter is rejected by the inverter, this can have a number of causes:

1. The inverter operating state does not allow you to change parameters.
For example, certain parameters can only be changed when the inverter is in commissioning mode.
2. In some cases, you may not be able to change certain parameters due to automatic follow-on parameterization.
Example: Use P0922 to define the PROFIdrive telegram that the inverter uses to communicate with the higher-level control. As follow-on parameterization, P0840 (source of the ON/OFF1 command), for example, is assigned a permanent protected value depending on the value of P0922.

For each parameter, the List Manual specifies whether and which conditions apply for changing the values.

Display parameters

Display parameters are preceded with the letter "r". You cannot change the value of these parameters.

Example:

r0027 is the parameter for the inverter output current. The inverter measures the current and writes the current value to the parameter. You can display the parameter value, e.g. using an analog output of the inverter.

1.4.3 Parameters with follow-on parameterization

When you change certain parameters, the system may automatically change other parameters accordingly. This makes it much easier to parameterize complex functions.

Example: Parameter P0700 (command source)

Parameter P0700 can be used to switch the command source from the fieldbus to digital inputs. When the value of P0700 is changed from 6 (command source "fieldbus") to 2 (command source "digital inputs"), other parameter values are changed automatically:

- New functions are assigned to the digital inputs (P0701 ... P0713)
- New functions are assigned to the digital outputs (P0731 ... P0733)
- Inverter control is interconnected with the signals from the digital inputs (P0800, P0801, P0840, etc.)

You will find more information about follow-on parameterization for P0700 in the List Manual.

1.4.4 Parameter changes, which subsequently result in internal calculations

When changing the following parameters, the inverter is busy with internal calculations for several seconds. During this time, no entries are possible.

- p0014 Buffer mode
- p0340 Calculation of control parameters
- p0970 DO/reset drive
- p0971 DO/save drive
- p1082 Maximum speed
- p3235 Phase failure monitoring time
- p3900 Completion quick commissioning
- p1030 Motorized potentiometer config
- p2230 Tech motorized potentiometer config
- p0918 PROFIBUS address
- p2020 Fieldbus baud rate
- p2021 Fieldbus address
- p2030 Fieldbus selection
- p2042 PROFIBUS ident
- p8620 CAN address
- p0804 Data copy, MMC - flash
- p1900 MotID

This state "busy with internal calculations" is displayed as follows:

- at the BOP-2: "Busy"
- at the IOP: Progress bars

Further, the state can also be read-out using p3996:

- r3996 = 0 Inputs possible
- r3996 > 0 Inverter busy, inputs not possible

1.5 Frequently required parameters

Parameters that in many cases help

Table 1-2 How to switch to commissioning mode or restore the factory setting

Parameter	Description
P0010	Commissioning parameters 0: Ready (factory setting) 1: Perform quick commissioning 3: Perform motor commissioning 5: Technological applications and units 15: Define number of data records 30: Factory setting - initiate restore factory settings

Table 1-3 How to determine the firmware version of the Control Unit

Parameter	Description
r0018	The firmware version is displayed:

Table 1-4 This is how you select the command source of the control signals (ON/OFF, reversing) of the inverter

Parameter	Description
P0700	2: Digital inputs (P0701 ... P0709); factory setting for inverters without PROFIBUS interface 6: Fieldbus (P2050 ... P2091), factory setting for inverters with PROFIBUS interface

Table 1-5 This is how you select the setpoint source for the speed

Parameter	Description
P1000	0: No main setpoint 1: Motorized potentiometer 2: Analog setpoint; factory setting for inverters without PROFIBUS interface 3: Fixed speed setpoint 6: Fieldbus; factory setting for inverters with PROFIBUS interface 7: Analog setpoint 2

Table 1-6 This is how you parameterize the up and down ramps

Parameter	Description
P1080	Minimum speed 0.00 [rpm] factory setting
P1082	Maximum speed 1500.000 [rpm] factory setting
P1120	Rampup time 10.00 [s]
P1121	Rampdown time 10.00 [s]

Table 1- 7 This is how you set the closed-loop type

Parameter	Description
P1300	0: V/f control with linear characteristic 1: V/f control with linear characteristic and FCC 2: V/f control with parabolic characteristic 3: V/f control with parameterizable characteristic 4: V/f control with linear characteristic and ECO 5: V/f control for drives requiring a precise frequency (textile area) 6: V/f control for drive requiring a precise frequency and FCC 7: V/f control with parabolic characteristic and ECO 19: V/f control with independent voltage setpoint 20: Speed control (without encoder) 22: Torque control (without encoder)

Table 1- 8 This is how you optimize the starting behavior of the V/f control for a high break loose torque and overload

Parameter	Description
P1310	Voltage boost to compensate ohmic losses The voltage boost is active from standstill up to the rated speed. It is at its highest at speed 0 and continually decreases as the speed increases. Value of voltage boost at zero speed in V: $1.732 \times \text{rated motor current (P0305)} \times \text{stator resistance (r0395)} \times \text{P1310} / 100\%$
P1311	Voltage boost when accelerating The voltage boost is effective from standstill up to the rated speed. It is independent of the speed and has a value in V of: $1.732 \times \text{rated motor current (P305)} \times \text{stator resistance (P350)} \times \text{P1311} / 100\%$

1.6 Extended scope for adaptation

1.6.1 BICO technology: basic principles

Principle of operation of BICO technology

Open/closed-loop control functions, communication functions as well as diagnostic and operator functions are implemented in the inverter. Every function comprises one or several BICO blocks that are interconnected with one another.

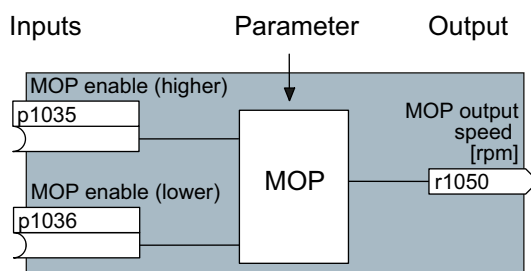

Figure 1-1 Example of a BICO block: Motorized potentiometer (MOP)

Most of the BICO blocks can be parameterized. You can adapt the blocks to your application using parameters.

You cannot change the signal interconnection within the block. However, the interconnection between blocks can be changed by interconnecting the inputs of a block with the appropriate outputs of another block.

The signal interconnection of the blocks is realized, contrary to electric circuitry, not using cables, but in the software.

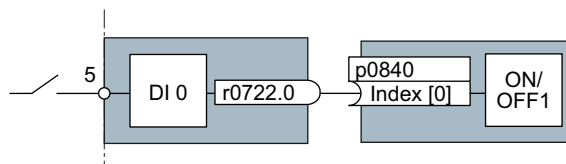

Figure 1-2 Example: Signal interconnection of two BICO blocks for digital input 0

Binectors and connectors

Connectors and binectors are used to exchange signals between the individual BICO blocks:

- Connectors are used to interconnect "analog" signals. (e.g. MOP output speed)
- Binectors are used to interconnect "digital" signals. (e.g. 'Enable MOP up' command)

Definition of BICO technology

BICO technology represents a type of parameterization that can be used to disconnect all internal signal interconnections between BICO blocks or establish new connections. This is realized using **B**inectors and **C**onnectors. Hence the name **BICO** technology. (Binector Connector Technology)

BICO parameters

You can use the BICO parameters to define the sources of the input signals of a block. Using BICO parameters you define from which connectors and binectors a block reads-in its input signals. This is how you "interconnect" the blocks stored in the devices according to your particular application requirements. The five different BICO parameter types are shown in the following diagram:

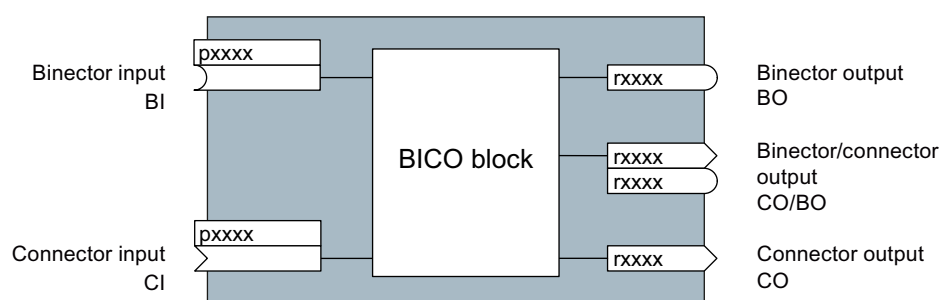

Figure 1-3 BICO symbols

Binector/connector outputs (CO/BO) are parameters that combine more than one binector output in a single word (e.g. r0052 CO/BO: status word 1). Each bit in the word represents a digital (binary) signal. This summary reduces the number of parameters and simplifies parameter assignment.

BICO outputs (CO, BO, or CO/BO) can be used more than once.

When do you need to use BICO technology?

BICO technology allows you to adapt the inverter to a wide range of different requirements. This does not necessarily have to involve highly complex functions.

Example 1: Assign a different function to a digital input.

Example 2: Switch the speed setpoint from the fixed speed to the analog input.

What precautions should you take when using BICO technology?

Always apply caution when handling internal interconnections. Note which changes you make as you go along since the process of analyzing them later can be quite difficult.

The STARTER commissioning tool offers various screens that make it much easier for you to use BICO technology. The signals that you can interconnect are displayed in plain text, which means that you do not need any prior knowledge of BICO technology.

What sources of information do you need to help you set parameters using BICO technology?

- This manual is sufficient for simple signal interconnections, e.g. assigning a different significance to the to digital inputs.
- The parameter list in the List Manual is sufficient for signal interconnections that go beyond just simple ones.
- You can also refer to the function diagrams in the List Manual for complex signal interconnections.

1.6.2 BICO technology: example

Example: Shifting a basic PLC functionality into the inverter

A conveyor system is to be configured in such a way that it can only start when two signals are present simultaneously. These could be the following signals, for example:

- The oil pump is running (the required pressure level is not reached, however, until after five seconds)
- The protective door is closed

The task is realized by inserting free blocks between the digital input 0 and the internal ON/OFF1 command and interconnecting them.

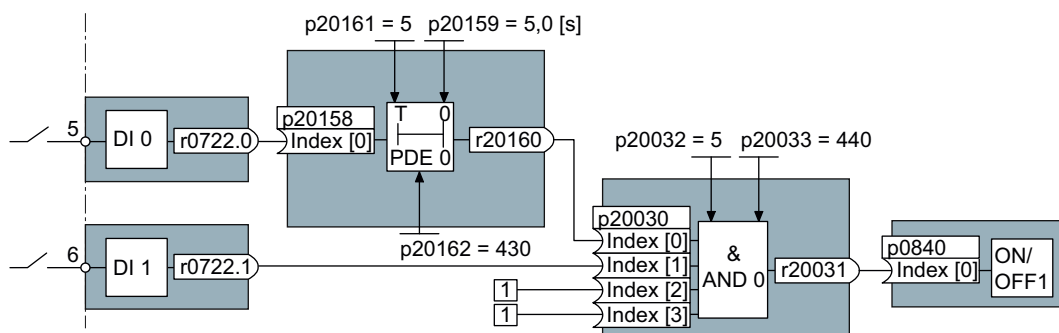

Figure 1-4 Example: Signal interconnection for interlock

The signal of digital input 0 (DI 0) is fed through a time block (PDE 0) and is interconnected with the input of a logic block (AND 0). The signal of digital input 1 (DI 1) is interconnected to the second input of the logic block. The logic block output issues the ON/OFF1 command to switch-on the motor.

Table 1-9 Parameterizing an interlock

Parameter	Description
P0700 = 2	Selecting the command source: Digital inputs
P0701 = 0	Enable ("open") digital input 0 (DI 0) for BICO parameterization
P0702 = 0	Enable ("open") digital input 1 (DI 1) for BICO parameterization
P20161 = 5	The time block is enabled by assigning to runtime group 5 (time slice of 128 ms)

Parameter	Description
P20162 = 430	Run sequence of the time block within runtime group 5 (processing before the AND logic block)
P20032 = 5	The AND logic block is enabled by assigning to runtime group 5 (time slice of 128 ms)
P20033 = 440	Run sequence of the AND logic block within runtime group 5 (processing after the time block)
P20159 = 5.0	Setting the delay time of the time block: 5 seconds
P20158 = 722.0	Connect the status of DI 0 to the input of the time block r0722.0 = Parameter that displays the status of digital input 0.
P20030 [0] = 20160	Interconnecting the time block to the 1st input of the AND
P20030 [1] = 722.1	Interconnecting the status of DI 1 to the 2nd AND input r0722.1 = Parameter that displays the status of digital input 1.
P0840 = 20031	Interconnecting the AND output to the control command ON/OFF1

Explanation of the example using the ON/OFF1 command

Open the default signal interconnection for BICO parameterization

After selecting the digital inputs as command source (P0700 = 2), digital input 0 is automatically interconnected to the ON/OFF1 command. Parameter P0840[0] has the value 722.0.

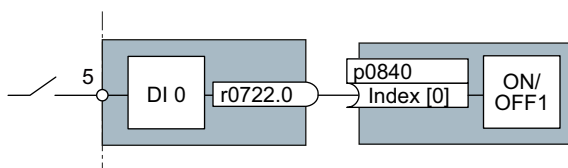

Figure 1-5 Interconnect the BICO block DI 0 and ON/OFF1 command

The setting P0701 = 0 means that this interconnection is disconnected.

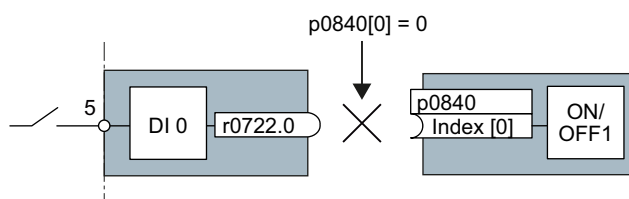

Figure 1-6 Disconnect the default interconnection: p0840[0] = 0

The "ON/OFF1 command" can now be interconnected again using BICO parameterization. The binector input of the BICO block ON/OFF1 is interconnected with the output of the AND logic block (P0840 = 20031).

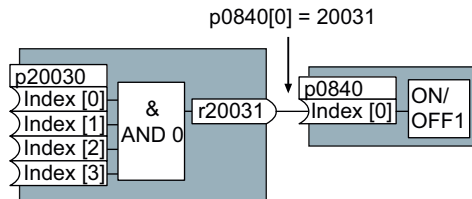

Figure 1-7 Interconnecting two BICO blocks by setting p0840[0] = 20031

Principle when connecting BICO blocks using BICO technology

An interconnection between two BICO blocks comprises a connector or binector and a BICO parameter. The interconnection is always established from the perspective of the input of a particular BICO block. This means that the output of an upstream block must always be assigned to the input of a downstream block. The assignment is always made by entering the number of the connector/binector from which the required input signals are read in a BICO parameter.

This interconnection logic involves the question: **where does the signal come from?**

Description

2.1 Modularity of the converter system



Thanks to their modular design, the inverters can be used in a wide range of applications with respect to functionality and power.

The following overview describes the inverter components, which you require for your application.

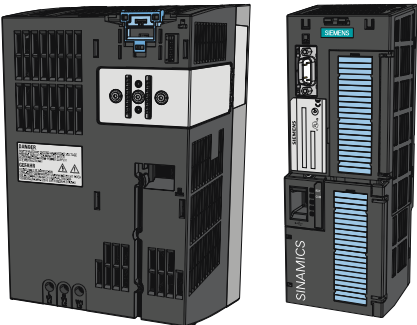

Main components of the inverter

 <p style="text-align: center;">Power Module Control Unit</p>	<p>Each SINAMICS G120 inverter comprises a Control Unit and Power Module.</p> <ul style="list-style-type: none"> • The Control Unit controls and monitors the Power Module and the connected motor in various control modes (which can be selected as required). The Control Unit is used to control the inverter locally or centrally. • The Power Modules are available for motors with a power range of between 0.37 kW and 250 kW.
--	--

Components for commissioning, diagnostics and controlling inverters

	<p>Intelligent Operator Panel (IOP)</p> <ul style="list-style-type: none"> • Operator panel for convenient commissioning, diagnostics and controlling of inverters • As handheld device or on the inverter itself • Properties: <ul style="list-style-type: none"> – Copies drive parameters – Plain text display – Menu-based operation and application wizards.
	<p>Basic Operator Panel-2 (BOP-2)</p> <ul style="list-style-type: none"> • Operator panel for commissioning, diagnostics and controlling of inverters. • is plugged onto the inverter • Properties: <ul style="list-style-type: none"> – Copies drive parameters – Two-line display – Guided commissioning

2.2 Overview of Control Units

	Memory card (MMC or SD) for carrying out standard commissioning of more than one inverter and for external data backup.
	PC Connection Kit, comprising STARTER DVD and USB cable for connecting an inverter to a computer

Components, which you require depending on your particular application

Filters and reactors

- Line filters, Classes A and B
- Line reactors
- Braking resistors
- Output reactors
- Sine-wave filter

Further options

- Brake Relay
- Adapter for DIN rail mounting (only PM240, FSA)
- Shield connection kit (for Control Unit and Power Module)

2.2 Overview of Control Units

The Control Units differ in relation to the integrated safety functions, the type of fieldbuses, and the number of inputs and outputs.

	CU240B-2	CU240B-2 DP	CU240E-2	CU240E-2 F	CU240E-2 DP	CU240E-2 DP-F
Fieldbus	USS or Modbus RTU	PROFIBUS DP	USS or Modbus RTU	USS or Modbus RTU	PROFIBUS DP	PROFIBUS DP with PROFIsafe
Integrated safety functions	-	-	STO	STO, SS1, SLS	STO	STO, SS1, SLS
Digital inputs	4		6			
Fail-safe digital inputs *)	-		1	3	1	3
Analog inputs	1		2			
Digital outputs	1		3			
Analog outputs	1		2			

*) A fail-safe digital input is created by combining two "standard" digital inputs

2.3 Power Module

Power Modules are available in various degrees of protection with a different topology in the power range from between 0.37 kW up to 250 kW. The Power Modules are sub-divided into various frame sizes (FS).



Figure 2-1 Power Module with degree of protection IP20, PM240, PM250, PM260



Figure 2-2 Power Module with degree of protection IP20, PM240-2, PM250-2

Table 2- 1 Power Module with degree of protection IP20

Frame size	FSA	FSB	FSC	FSD	FSE	FSF	FSGX
PM240, 3AC 400V - power units with integrated braking chopper²⁾							
Power range (LO)	0.37 kW ... 1.5 kW	2.2 kW ... 4 kW	7.5 kW ... 15 kW	18.5 kW ... 30 kW	37 kW ... 45 kW	55 kW ... 132 kW	160 kW ... 250 kW
With integr. line filter, Class A	○	●	●	●	●	○ ¹⁾	○ ¹⁾
PM240-2, 3AC 400V - power units with integrated braking chopper²⁾							
Power range (LO)	0.55 kW ... 3 kW	---	---	---	---	---	---
With integr. line filter, Class A	○/●	---	---	---	---	---	---
PM250, 3AC 400V - power units capable of energy recovery							
Power range (LO)	---	---	7.5 kW ... 15 kW	18.5 kW ... 30 kW	37 kW ... 45 kW	55 kW ... 90 kW	---
With integr. line filter, Class A	---	---	●	●	●	●	---

Description

2.3 Power Module

PM250-2, 3AC 400V - power units capable of energy recovery							
Power range (LO)	0.55 kW ... 3 kW	4 kW ... 7.5 kW	---	---	---	---	---
With integr. line filter, Class A	○/●	○/●	---	---	---	---	---
PM260, 3AC 690V - power units capable of energy recovery							
Power range (LO)	---	---	---	11 kW ... 18.5 kW	---	30 kW ... 55 kW	---
With integr. line filter, Class A	---	---	---	○/●	---	○/●	---
With integr. sine-wave filter	---	---	---	●	---	●	---

● = Feature available; ○ = Feature not available; ◐ = Feature available, modified

1) PM240 Power Modules, 110 kW and higher, are only available without an integrated class A filter. Instead, an optional class A line filter for lateral mounting is available.

2) The Power Module PM240 FSGX is delivered without braking chopper, but is prepared for installation of an optional braking chopper.



Figure 2-3 PushThrough Power Modules, PM240-2, PM250-2

Table 2-2 PushThrough Power Modules, PM240-2, PM250-2

Frame size	FSA	FSB	FSC	FSD	FSE	FSF
PM240, 3AC 400V - power units with integrated braking chopper ²⁾						
Power range (LO)	2.2 kW ... 3 kW	---	---	---	---	---
With integr. line filter, Class A	○/●	---	---	---	---	---
PM250, 3AC 400V - power units capable of energy recovery						
Power range (LO)	3 kW	7.5 kW	---	---	---	---
With integr. line filter, Class A	○/●	○/●	---	---	---	---

2.4 Reactors and filters

Overview

Depending on the Power Module, the following combinations with filters and reactors are permitted:

Power Module	Line-side components			Load-side components	
	Line reactor	Line filters class B	Braking resistor	Sine-wave filter	Output reactor
PM240	•	•	•	•	•
PM250	-	•	-	•	•
PM260	-	•	-	integrated	-

For further details, refer to the connection example in section Procedure for installing the frequency inverter (Page 31).

Description

2.4 Reactors and filters

Connecting

3.1 Procedure for installing the frequency inverter

Prerequisites for installing the inverter

Check that the following prerequisites are fulfilled before you install the inverter:

- Are the components, tools and small parts required for installation available?
- Are the ambient conditions permissible? See Technical data (Page 261).
- Have the cables and wires been routed in accordance with the applicable regulations? See EMC-compliant connection (Page 46).
- Are the minimum distances from other equipment complied with? (Cooling sufficient?) See Dimensions, hole drilling templates, minimum clearances, tightening torques (Page 34).

Installation sequence

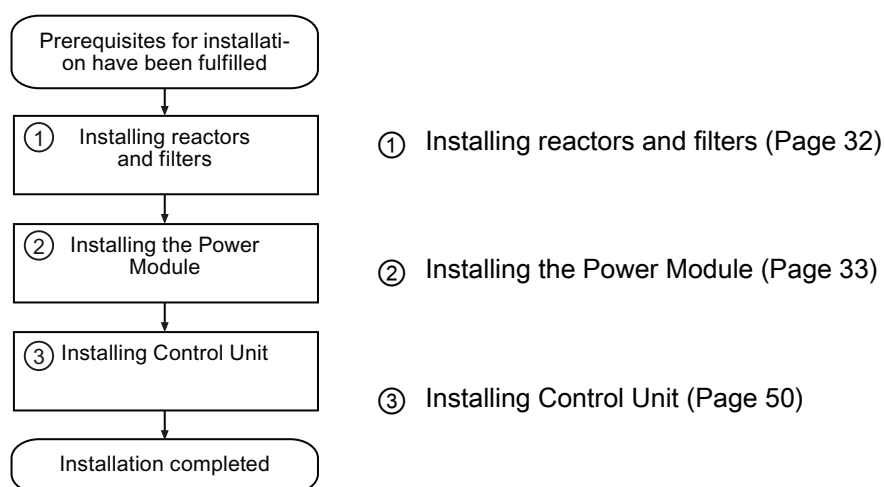

You will find details on how to install the inverter in the Internet: Hardware Installation Manual (<http://support.automation.siemens.com/WW/view/en/30563173/133300>).

You can start to commission the inverter once installation has been completed.

3.2 Installing reactors and filters

Fitting inverter system components in space-saving manner

Many inverter system components are designed as base components, that is, the component is mounted on the baseplate and the inverter mounted above it to save space. Up to two base components can be mounted above one another.

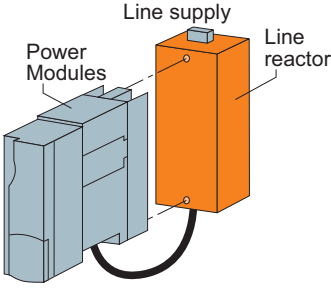
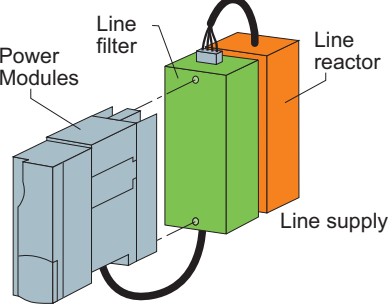
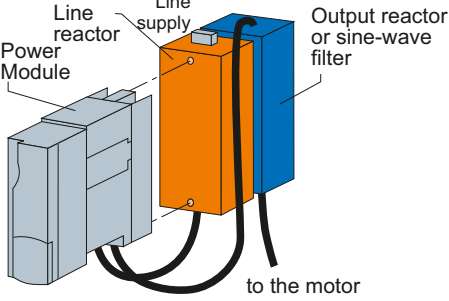
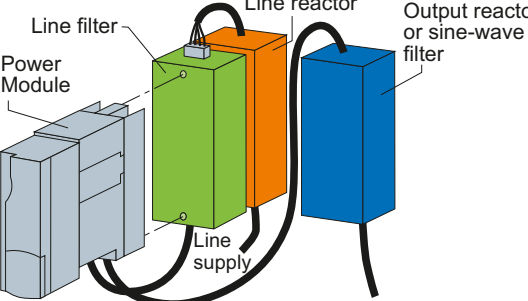
PM240	
	
<p>Basic layout of a PM240 Power Module with line reactor as base component</p>	<p>PM240 Power Module frame size FSA with line reactor and class A line filter</p>
<p>The line-side reactors are equipped with terminals while the reactors on the Power Module side are equipped with a prefabricated cable. In the final installation position, the mains terminals are at the top on frame sizes FSA to FSC, and at the bottom on frame sizes FSD to FSE.</p> <p>For frame size FSA, in addition to the line reactor, a class A line filter can be used. In this case, the mains connection is at the bottom.</p> <p>Power Modules of frame size FSB and higher are available with integrated class A line filters (an external class A line filter is not required in this case).</p>	
	
<p>PM240: frame size FSA with line reactor and output reactor or sine-wave filter</p>	<p>PM240 Power Module frame size FSA with line reactor, line filter and output reactor or sine-wave filter</p>
<p>In installations containing more than two base-type system components (e.g. line filter + line reactor + output reactor), the components must be installed to the side of the Power Module whereby the line reactor and line filter are installed under the Power Module and the output reactor to the side.</p>	

PM250	
Basic layout of a PM250 Power Module with class B line filter as a base component	Basic layout of a PM250 Power Module with a class B line filter as a base component and output reactor or sine-wave filter

3.3 Installing the Power Module

3.3.1 Installing Power Modules

Options for installing Power Modules with degree of protection IP20

Depending on the format, various options are available for installing inverters. This manual describes how to install inverters directly on the cabinet wall.

Installation options	Frame size						
	A	B	C	D	E	F	GX
Installation on standard rails	X	X	X	---	---	---	---
Mounting on a cabinet panel with shield connection kit	X	X	X	X	X	X	---
Installation directly on the cabinet wall	X	X	X	X	X	X	X

Installing Power Modules

Choose the best installation option for your application and install the Power Module in accordance with the instructions provided in this section.

Notes for installing Power Modules

The Power Module must not be installed horizontally.



Correct



Incorrect

Devices that could impede the flow of cooling air must not be installed in this area. Make sure that the ventilation openings for the cooling air for the inverter are not covered and that the flow of cooling air is not obstructed.

Installing additional components

Depending on the application, additional line reactors, filters, braking resistors, brake relays etc., may also be used.

Please observe the mounting and installation instructions supplied with these components!

3.3.2 Dimensions, hole drilling templates, minimum clearances, tightening torques

Note

With the exception of inverters in the 160 kW ... 250 kW power range, the CU240B-2 und CU240E-2 increase the inverter's total depth by 40 mm and by a further 30 mm if using an IOP.

Dimensions and drilling patterns for the PM240 Power Modules

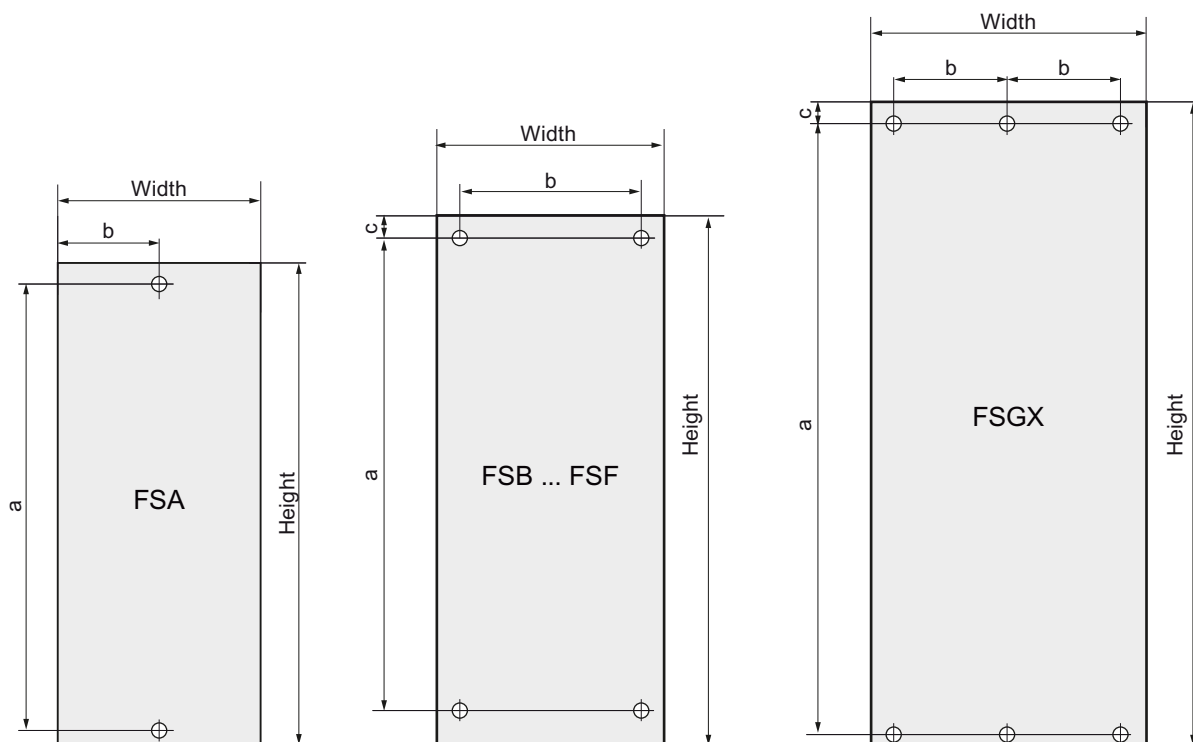

Figure 3-1 PM240 dimension drawing

Table 3-1 Dimensions for the PM240 Power Modules, IP20

PM240	Power	Dimensions						Clearances			
		Height	Width	Depth	a	b	c	top	bottom	lateral	
FSA	0,37 ... 1,5	mm	173	73	145	160	36,5		100	100	30*
		inch	6,81	2,87	5,71	6,30	1,44		3,94	3,94	1,18*
Fixing: M4 screws, Torque: 2.5 Nm / 22.1 lbf.in											
FSB	2,2 ... 4	mm	270	153	165	258	133		100	100	40*
		inch	10,63	6,02	6,5	10,16	5,24		3,94	3,94	1,57*
Fixing: M4 screws, Torque: 2.5 Nm / 22.1 lbf.in											
FSC	7,5 ... 15	mm	334	189	185	323	167		125	125	50*
		inch	13,15	7,44	7,28	12,72	6,57		4,92	4,92	1,97*
Fixing: M5 screws, Torque: 2.5 Nm / 22.1 lbf.in											
FSD without filter	18,5 ... 30	mm	419	275	204	325	235	11	300	300	0
		inch	16,50	10,83	8,03	12,8	9,25	0,4	11,81	11,81	0
Fixing: M6 screws, Torque: 6 Nm / 53 lbf.in											
FSD with filter, Class A	18,5 ... 30	mm	512	275	204	419	235	11	300	300	0
		inch	20,16	10,83	8,03	16,50	9,25	0,4	11,81	11,81	0
Fixing: M6 screws, Torque: 6 Nm / 53 lbf.in											

Connecting

3.3 Installing the Power Module

PM240	Power	Dimensions							Clearances		
IP20	kW		Height	Width	Depth	a	b	c	top	bottom	lateral
FSE without filter	37 ... 45	mm	499	275	204	405	235	11	300	300	0
		inch	19,65	10,83	8,03	15,9	9,25	0,4	11,81	11,81	0
		Fixing: M6 screws, Torque: 6 Nm / 53 lbf.in									
FSE with filter, Class A	37 ... 45	mm	635	275	204	541	235	11	300	300	0
		inch	25,00	10,83	8,03	21,30	9,25	0,4	11,81	11,81	0
		Fixing: M6 screws, Torque: 6 Nm / 53 lbf.in									
FSF without filter	55 ... 132	mm	634	350	316	598	300	11	350	350	0
		inch	24,96	13,78	12,44	23,54	11,81	0,4	13,78	13,78	0
		Fixing: M8 screws, Torque: 13 Nm / 115 lbf.in									
FSF with filter, Class A	55 ... 90	mm	934	350	316	899	300	11	350	350	0
		inch	36,77	13,78	12,44	35,39	11,81	0,4	13,78	13,78	0
		Fixing: M8 screws, Torque: 13 Nm / 115 lbf.in									
FSGX	160 ... 250	mm	1533	326	547	1506	125	14,5	250	150	50/0
		inch	60,35	12,9	21,5	59,29	4,92	0,57	9,84	5,91	1,970
		Fixing: M8 screws, Torque: 13 Nm / 115 lbf.in									

*) up to 40 °C without any lateral clearance

Dimensions and drilling patterns for the PM240-2 Power Modules

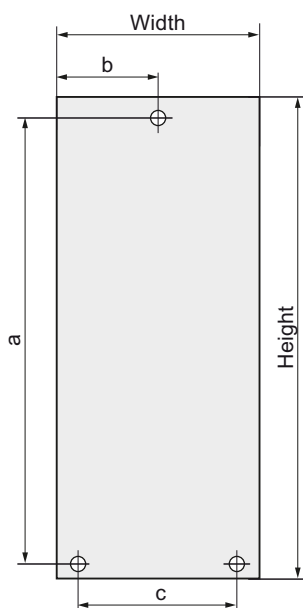

Figure 3-2 Dimensions and drilling pattern, PM240-2 IP20

Table 3- 2 Power Modules PM240-2, IP20

PM240-2 IP20	Power kW	Dimensions							Clearances		
		Height	Width	Depth	a	b	c	top	bottom	lateral	
FSA	0,55 ... 3	mm	196	73	165	186	36,5	61	100	100	30*
without / with filter		inch	7,72	2,87	6,50	7,32	1,44	2,40	3,94	3,94	1,18*
		Fixing: M4 screws, Torque: 2.5 Nm / 22.1 lbf.in									

*) up to 40 °C without any lateral clearance

3.3 Installing the Power Module

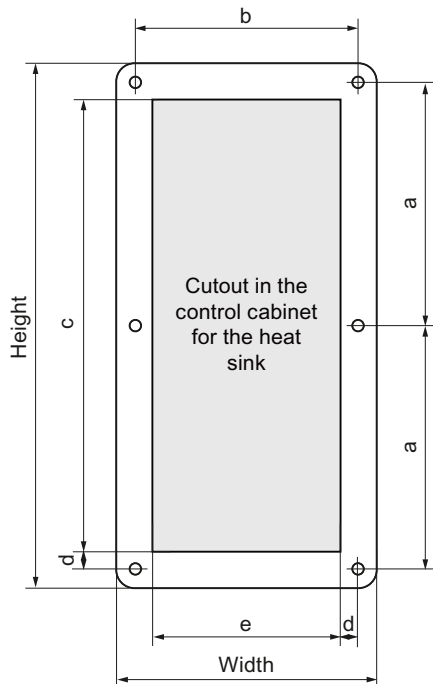

Figure 3-3 Dimensions and drilling pattern, PM240-2 PT

Table 3- 3 Power Module PM240-2, push-through

PM240-2 PT	Power kW	Dimensions					Clearances						
		Heigh t	Width	Depth	a	b	c	d	e	top	bottom	lateral	
FSA without / with filter	2,2 ... 3	mm	226	126	165	103	106	188	9	88	100	100	0
		inch	8,90	4,96	6,50	4,06	4,17	7,04	0,35	3,46	3,94	3,94	0
		Fixing: M4 screws, Torque: 2.5 Nm / 22.1 lbf.in											

Dimensions and drilling patterns for the PM250 Power Modules

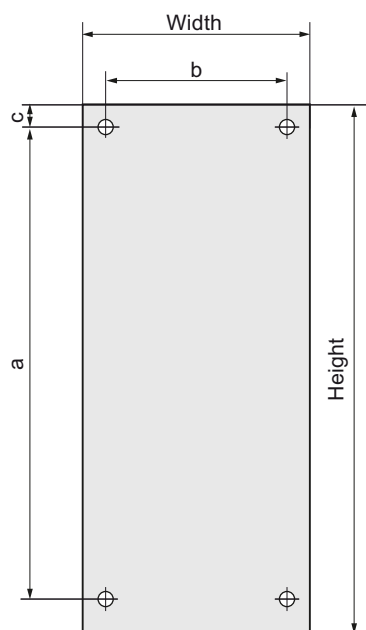

Figure 3-4 Dimensions and drilling patterns, PM250

Table 3- 4 PM250 Power modules, IP20

PM250 IP20	Power kW	Dimensions							Clearances		
			Height	Width	Depth	a	b	c	top	bottom	lateral
FSC	7,5 ... 15	mm	334	189	185	323	167	11	125	125	50*
		inch	13,15	7,44	7,28	12,72	6,57	0,43	4,92	4,92	1,97*
		Fixing: M5 screws, Torque: 2.5 Nm / 22.1 lbf.in									
FSD without filter	18,5 ... 30	mm	419	275	204	325	235	11	300	300	0
		inch	16,50	10,83	8,03	12,8	9,25	0,43	11,81	11,81	0
		Fixing: M6 screws, Torque: 6 Nm / 53 lbf.in									
FSD with filter, Class A	18,5 ... 30	mm	512	275	204	419	235	11	300	300	0
		inch	20,16	10,83	8,03	16,50	9,25	0,43	11,81	11,81	0
		Fixing: M6 screws, Torque: 6 Nm / 53 lbf.in									
FSE with filter, Class A	37 ... 45	mm	635	275	204	541	235	11	300	300	0
		inch	25,00	10,83	8,03	21,30	9,25	0,43	11,81	11,81	0
FSE without filter	37 ... 45	mm	499	275	204	405	235	11	300	300	0
		inch	19,65	10,83	8,03	15,9	9,25	0,43	11,81	11,81	0
		Fixing: M6 screws, Torque: 6 Nm / 53 lbf.in									
		Fixing: M6 screws, Torque: 6 Nm / 53 lbf.in									
FSF without filter	55 ... 90	mm	634	350	316	598	300	11	350	350	0
		inch	24,96	13,78	12,44	23,54	11,81	0,43	13,78	13,78	0
		Fixing: M8 screws, Torque: 13 Nm / 115 lbf.in									

3.3 Installing the Power Module

PM250	Power	Dimensions							Clearances		
IP20	kW	Height	Width	Depth	a	b	c	top	bottom	lateral	
FSF with filter, Class A	55 ... 90	mm	934	350	316	899	300	11	350	350	0
		inch	36,77	13,78	12,44	35,39	11,81	0,43	13,78	13,78	0
		Fixing: M8 screws,		Torque: 13 Nm / 115 lbf.in							

*) up to 40 °C without any lateral clearance

Dimensions and drilling patterns for the PM250-2 Power Modules

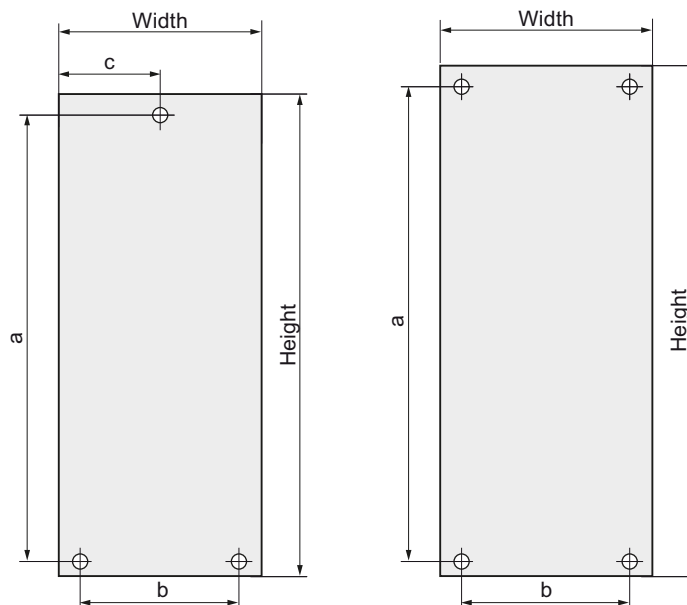

Figure 3-5 Dimensions and drilling patterns, PM250-2, IP20

Table 3- 5 PM250-2 Power Modules, IP20

PM250-2	Power	Dimensions							Clearances		
IP20	kW	Height	Width	Depth	a	b	c	top	bottom	lateral	
FSA without / with filter	0,55 ... 3	mm	196	73	165	186	61	36,5	100	100	30*
		inch	7,72	2,87	6,50	7,32	2,40	1,44	3,94	3,94	1,18*
		Fixing: M4 screws,		Torque: 2.5 Nm / 22.1 lbf.in							
FSB without / with filter	4... 7,5	mm	292	100	165	281	80	--	100	100	30*
		inch	11,50	3,94	6,50	11,06	3,15	--	3,94	3,94	1,18*
		Fixing: M4 screws,		Torque: 2.5 Nm / 22.1 lbf.in							

*) up to 40 °C without any lateral clearance

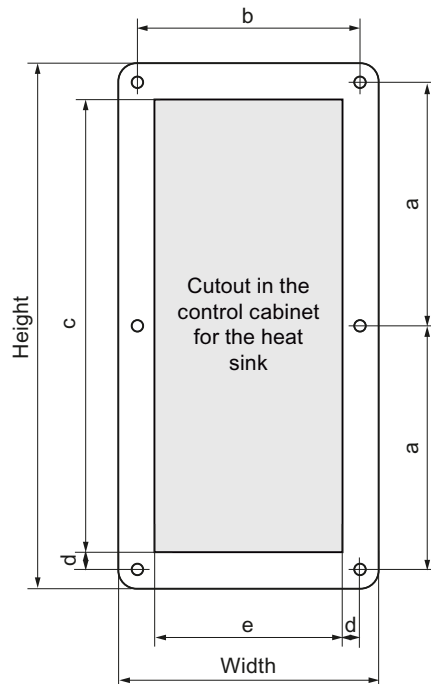

Figure 3-6 Dimensions and drilling pattern, M250-2, PT

Table 3- 6 Power Module PM250-2, push-through

PM250-2 PT	Power kW	Dimensions			Clearances								
		Heigh t	Width	Depth	a	b	c	d	e	top	bottom	lateral	
FSA without / with filter	3	mm	226	126	165	103	106	188	9	88	100	100	0
		inch	8,90	4,96	6,50	4,06	4,17	7,04	0,35	3,46	3,94	3,94	0
		Fixing: M4 screws, Torque: 2.5 Nm / 22.1 lbf.in											
FSB without / with filter	7,5	mm	315	154	165	147,5	134	188	10	117	100	100	0
		inch	12,40	6,06	6,50	5,81	5,28	7,04	0,39	4,61	3,94	3,94	0
		Fixing: M4 screws, Torque: 2.5 Nm / 22.1 lbf.in											

Dimensions and drilling patterns of the Power Modules

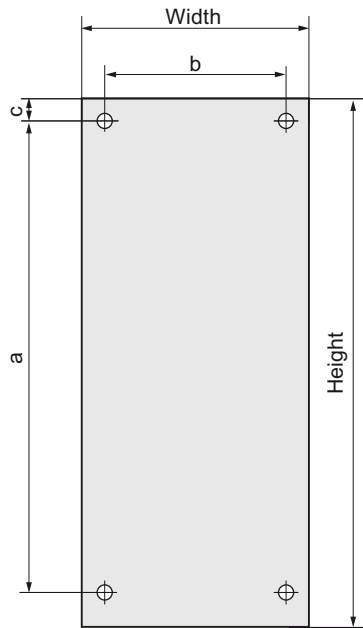

Figure 3-7 Dimensions and drilling pattern PM260

Table 3- 7 Power Module PM260, IP20

PM260 IP20	Power kW	Dimensions							Clearances		
		Height	Width	Depth	a	b	c	top	bottom	lateral	
FSD without / with filter	3	mm	511	275	195	419	235	11	100	100	30*
		inch	20,12	10,83	7,68	16,5	9,3	0,43	3,94	3,94	1,18*
Fixing: M6 screws, Torque: 6 Nm / 53 lbf.in											
FSF without / with filter	7,5	mm	634	350	307	598	300	11	100	100	0
		inch	24,96	13,78	12,09	23,54	11,81	0,43	3,94	3,94	0
Fixing: M8 screws, Torque: 13 Nm / 115 lbf.in											

*) up to 40 °C without any lateral clearance

3.3.3 Connection overview for Power Module

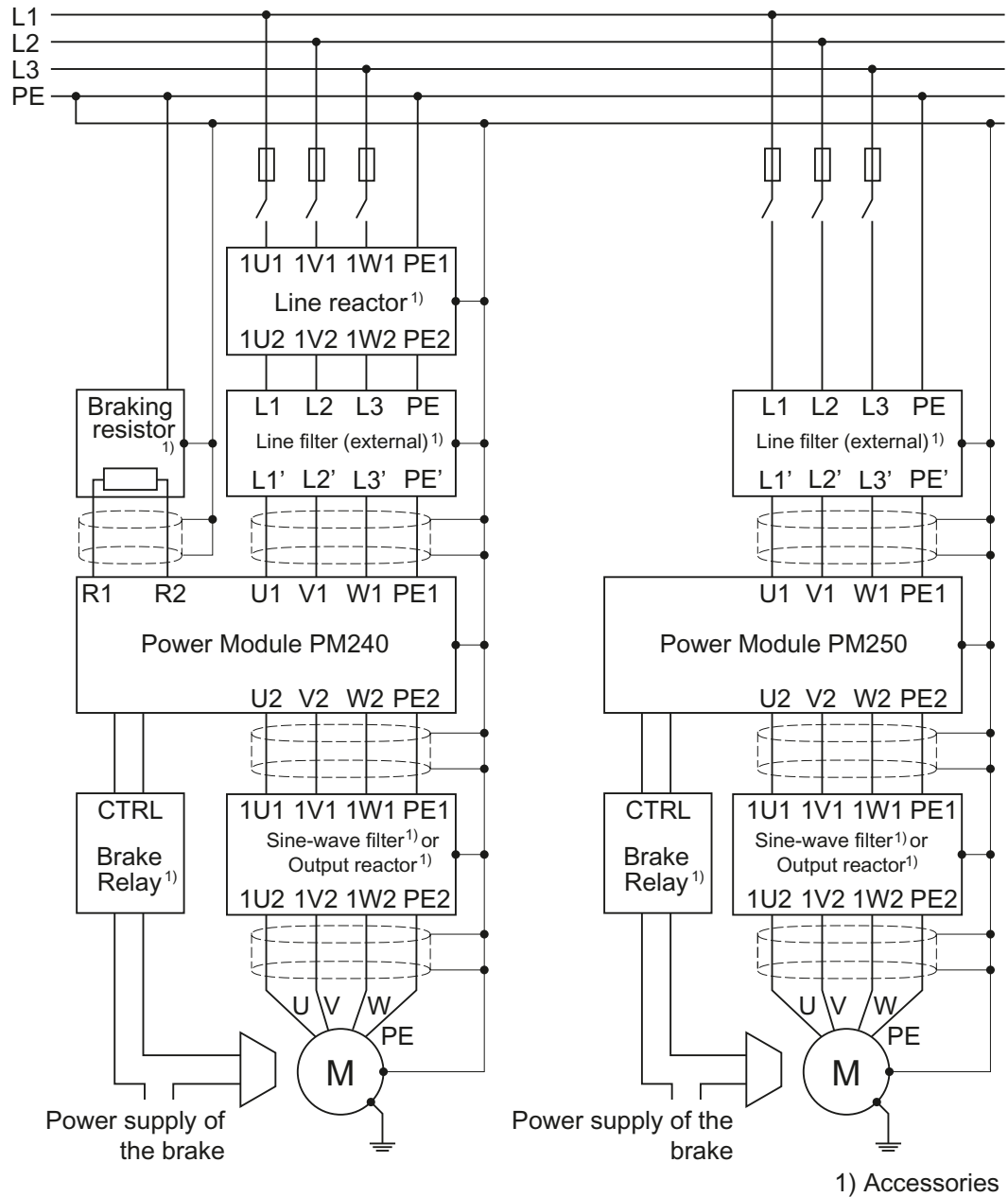

Figure 3-8 Connections for PM240 and PM250 Power Modules

In addition to the Power Modules shown above, you can also combine Control Units with a PM260 Power Module. The PM260 connection corresponds to that of a PM250, however, a sine-wave filter is integrated in the PM260.

The PM240, PM250 and PM260 Power Modules are available with and without integrated class A line filters. An external filter has to be installed for all Power Modules to satisfy more stringent EMC requirements (Class B).

3.3.4 Connecting the line supply and motor

Preconditions

Once the inverter has been properly installed, the line and motor connections can now be established. The following warning information must be observed here.

 WARNING
Line and motor connections <p>The inverter must be grounded on the line supply and motor side. If the inverter is not correctly grounded, this can lead to extremely hazardous conditions which, under certain circumstances, can result in death.</p> <p>The device must be disconnected from the electrical power supply before any connections with the device are established or in any way altered.</p> <p>The inverter terminals be at hazardous voltages even after the inverter has been switched off. After disconnecting the line supply, wait at least 5 minutes until the device has discharged itself. Only then, carry out any installation and mounting work.</p> <p>When connecting the inverter to the line supply, ensure that the motor terminal box is closed.</p> <p>Even if the LED or other indicators do not light up or remain inactive when a function is switched from ON to OFF, this does not necessarily mean that the unit has been switched off or is de-energized.</p> <p>The short-circuit ratio of the power supply must be at least 100.</p> <p>Make sure that the inverter is configured for the correct supply voltage (the inverter must not be connected to a higher supply voltage).</p> <p>If a residual-current circuit breaker is installed on the supply side of the electronic devices to protect against direct or indirect contact, only type B is permissible. In all other cases, other protective measures must be implemented, such as creating a barrier between the electronic devices and the environment by means of double or reinforced insulation or isolating them from the supply using a transformer.</p>

CAUTION
Supply cable and signal lines <p>The signal lines must be routed separately from the supply cables to ensure that the system is not affected by inductive or capacitive interference.</p>

Note

Electrical protective equipment

Ensure that the appropriate circuit breakers / fuses for the inverter's rated current are fitted between the line and inverter (see catalog D11.1).

Connecting the motor: Star connection and delta connection

With SIEMENS motors, you will see a diagram of both connection methods on the inside of the cover of the terminal box:

- Star connection (Y)
- Delta connection (Δ)

The motor rating plate provides information about the correct connection data.

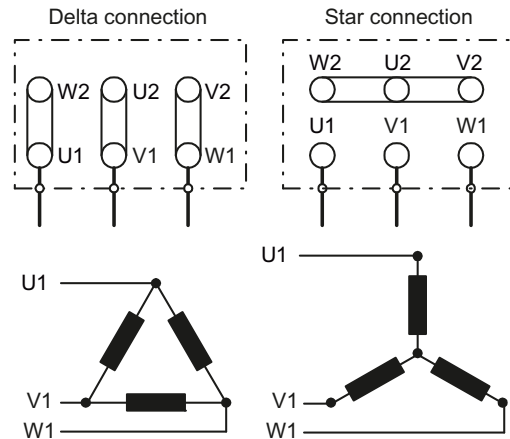

Examples for operating the inverter and motor on a 400 V line supply

Assumption: The motor rating plate states 230/400 V Δ /Y.

Example 1: A motor is normally operated between standstill and its rated speed (i.e. a speed corresponding to the line frequency). In this case, you need to connect the motor in Y. Operating the motor above its rated speed is only possible in field weakening, i.e. the motor torque available is reduced above the rated speed.

Example 2: If you want to operate the motor with the "87 Hz characteristic", you need to connect the motor in Δ .

With the 87 Hz characteristic, the motor's power output increases. The 87 Hz characteristic is mainly used with geared motors.

Connecting the inverter

Motor connection

- If available, open the terminal covers of the inverter.
- Connect the motor to terminals U2, V2 and W2.
Carefully observe the regulations for EMC-compliant wiring:
EMC-compliant connection (Page 46)
- Connect the protective conductor of the motor to the terminal  of the inverter.
The following cable lengths are permissible:
 - Unshielded 100 m
 - Shielded:
 - 50 m for inverters without filter
 - 25 m for inverters with filter
 You will find additional information in Catalog D11.1 for longer cable lengths

Line supply connection

- Connect the line supply to terminals U1/L1, V1/L2 and W1/L3.
- Connect the protective conductor of the line supply to terminal PE of the inverter.
- If available, close the terminal covers of the inverter.

Note

Inverters without an integrated line filter can be connected to grounded (TN, TT) and non-grounded (IT) line supply systems. The inverters with integrated line filter are suitable only for connection to TN line supply systems.

The permissible cable cross sections for the individual devices and power ratings are provided in Section Technical data (Page 261).

3.3.5 EMC-compliant connection

The inverters are designed for operation in industrial environments where high values of electromagnetic interference are expected. Safe, reliable and disturbance-free operation is only guaranteed if the devices are professionally installed.

Inverters with degree of protection IP20 must be installed and operated in an enclosed control cabinet.

Control cabinet design

- All metal parts and components of the control cabinet (side panels, rear panels, roof and base plates) must be connected to the control cabinet frame through a good electrical connection – this is best achieved using the highest possible surface area or a high number of individual screw connections
- The PE bar and the EMC shield bar must be connected to the control cabinet frame through a good electrical connection established through a large surface area.
- All of the metal enclosures of the devices and supplementary components installed in the cabinet – e.g. inverter or line filter – must be connected to the control cabinet frame through a good electrical connection through the largest possible surface area. The most favorable design is to mount these devices and supplementary components on a bare metal mounting plate with good conducting characteristics; this in turn is connected to the control cabinet frame through a good electrical connection and the largest possible surface area. It is especially important that they are connected to the PE and EMC shield bars.
- All of the connections must be implemented so that they are durable. Screw connections to painted or anodized metal components must either be established using special contact (serrated) washers that cut through the insulating surface and therefore establish a metallic conductor contact, or the insulating surface must be removed at the contact locations.
- Coils of contactors, relays, solenoid valves and motor holding brakes must be equipped with interference suppression elements in order to dampen high-frequency radiation when switching-off (RC elements or varistors with AC coils and free-wheeling diodes or varistors for DC coils). The protective circuit must be directly connected at the coil.

Cable routing and shielding

- All inverter power cables (line supply cables, connecting cables between the braking chopper and the associated braking resistance as well as the motor cables) must be separately routed away from signal and data cables. The minimum clearance should be approx. 25 cm. As an alternative, the decoupling can be realized in the control cabinet using metal partitions (separating elements) connected to the mounting plate through a good electrical connection
- The cables from the line supply to the line filter must be routed separately away from non-filtered power cables with a high noise level (cables between the line filter and inverter, connecting cables between the braking chopper and the associated braking resistor as well as motor cables)
- Signal and data cables as well as filtered line supply cables may only cross non-filtered power cables at right angles
- All cables should be kept as short as possible
- Signal and data cables and the associated equipotential bonding cables must always be routed in parallel with the smallest possible clearance between them
- Shielded motor cables must be used
- The shielded motor cable should be routed separately away from the cables to the motor temperature sensors (PTC/KTY)
- Signal and data cables must be shielded.
- Especially sensitive control cables - such as setpoint and actual value cables - should be routed without any interruption with optimum shield connection at both ends
- Shields should be connected at both ends to the grounded enclosures through a good electrical connection and through a large surface area
- Cable shields should be connected as close as possible to where the cable enters the cabinet
- EMC shield bars should be used for power cables; the shield connection elements provided in the inverter should be used for signal and data cables
- If at all possible, cable shields should not be interrupted by intermediate terminals
- Cable shields should be retained both for power cables as well as for signal and data cables using the appropriate EMC clamps. The shield clamps must connect the shield to the EMC shield bar or the shield connection element for control cables through a low inductive connection through a large surface area.
- Only metallic or metallized connector enclosures must be used for plug connectors for shielded data cables (e.g. PROFIBUS cables)

EMC-compliant installation of Power Modules in degree of protection IP20

The EMC-compliant installation of power modules is shown in the following diagram using two examples.

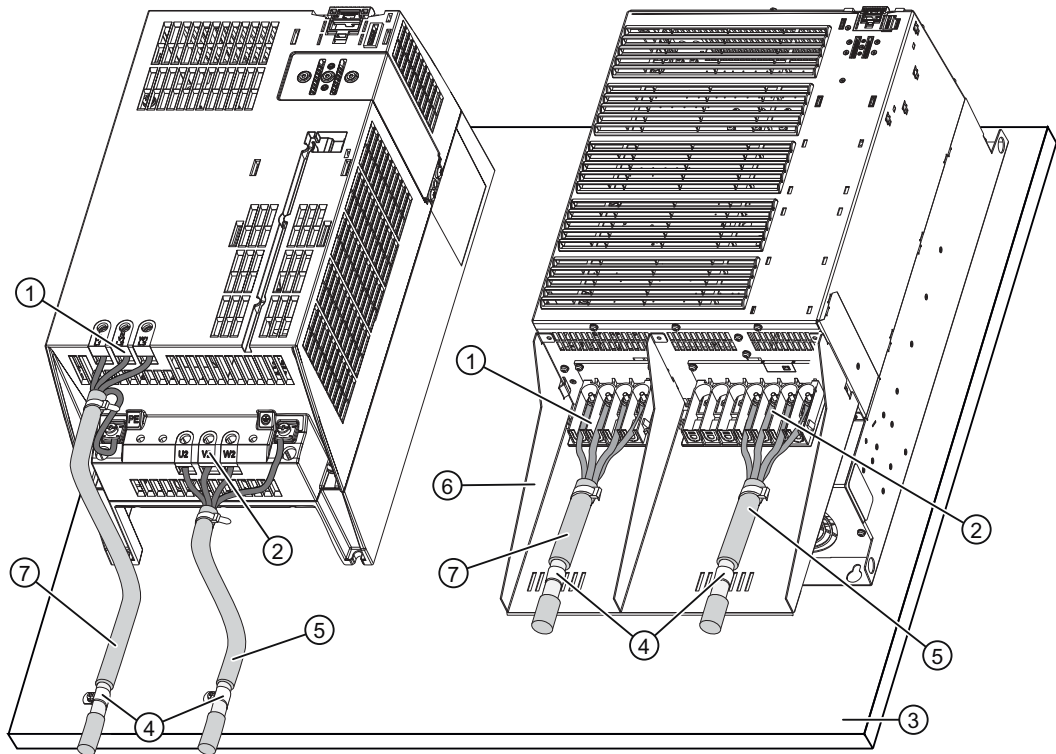

- ① Line supply connection
- ② Motor connection
- ③ Metal mounting plate (unpainted and with a good electrical conductivity)
- ④ Cable clamps for a good conductive electrical connection through a large surface area between the shield and mounting plate or shield connection kit.
- ⑤ Shielded motor cable
- ⑥ Shield connection kit
- ⑦ Unshielded cable for Power Modules with integrated line filter.
Shielded cable to connect a Power Module to an external line filter

Figure 3-9 Power Module shielding

Shielding with shield connection kit:	Shield connection kits are available for all Power Module frame sizes (you will find more information in Catalog D11.1). The cable shields must be connected to the shield connection kit through the greatest possible surface area using shield clamps.
Shielding without shield connection kit:	EMC-compliant shielding can also be implemented without an optional shield connection kit. In this case, you must ensure that the cable shields are connected to the ground potential through the largest possible surface area.
Braking resistor connection:	The braking resistor is connected using a shielded cable. Using a clamp, the shield should be connected to the mounting plate or to the shield connection kit through a good electrical connection and through the largest possible surface area.

3.4 Installing Control Unit

3.4.1 Snapping the Control Unit onto the Power Module

IP20 Power Modules

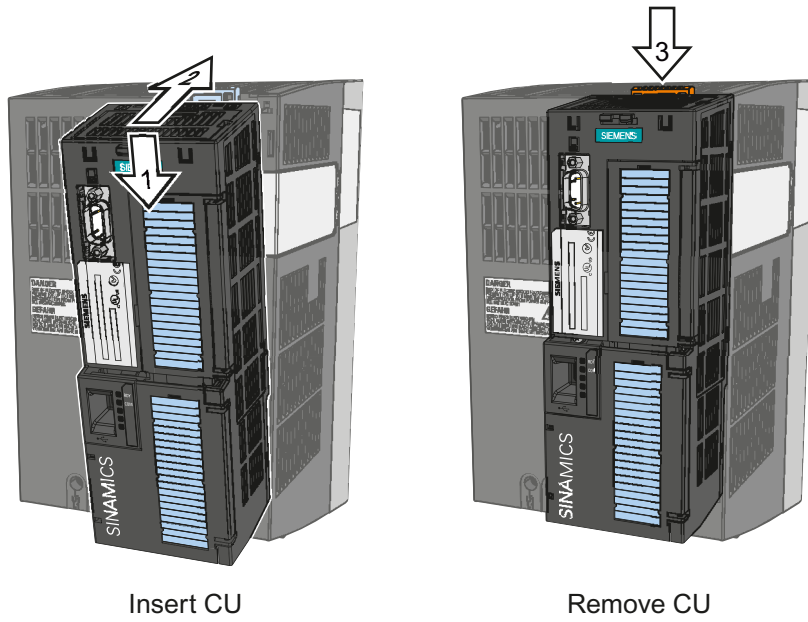
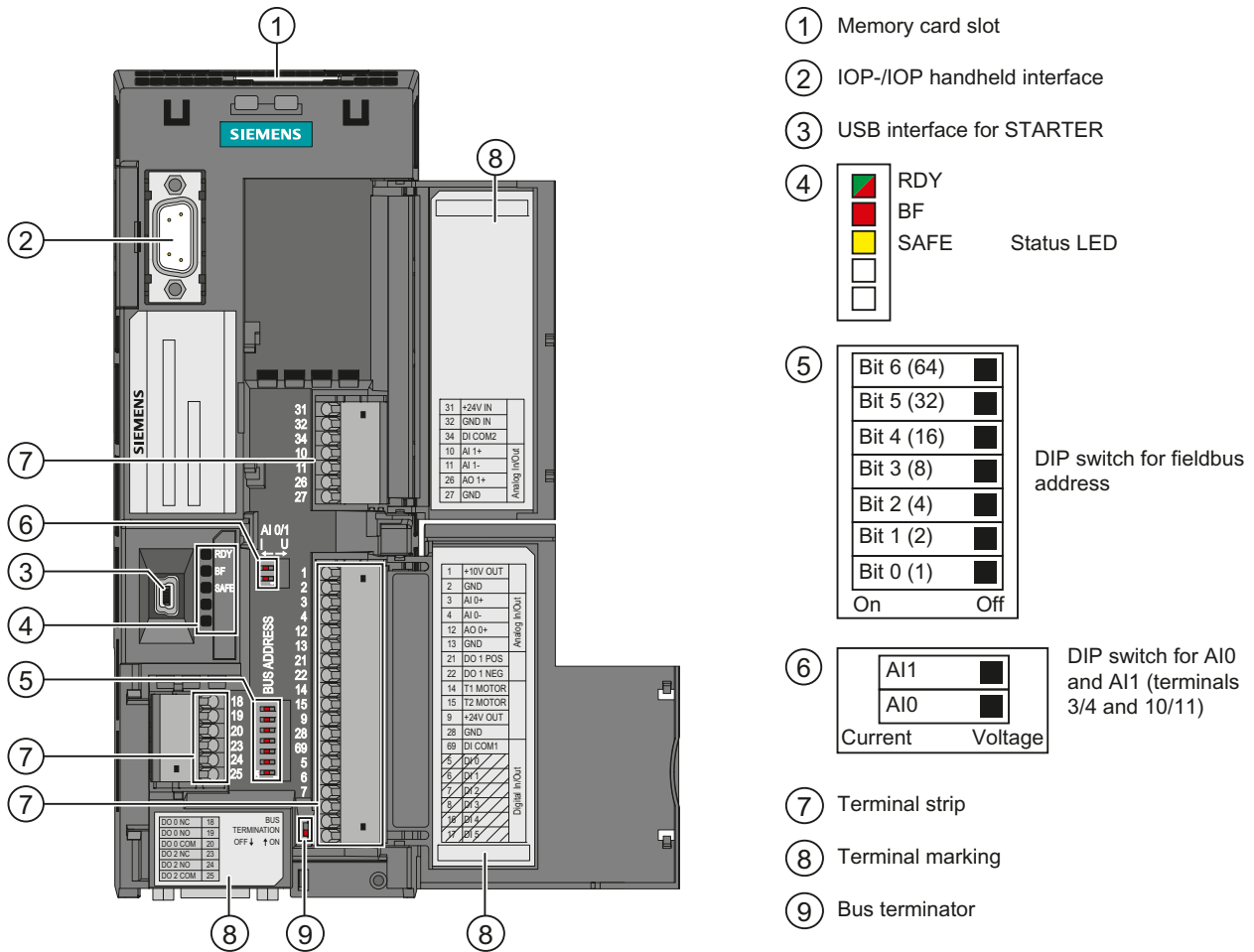

Figure 3-10 Insert the Control Unit on the Power Module and then remove

To gain access to the terminal strips, open the top and bottom front doors to the right. The terminal strips use spring-loaded terminals.

3.4.2 Interfaces, connectors, switches, terminal blocks and LEDs of the CU



CU240B-2, CU240E-2, CU240E-2 F

CU240B-2 DP, CU240E-2 DP,
CU240E-2 DP-F

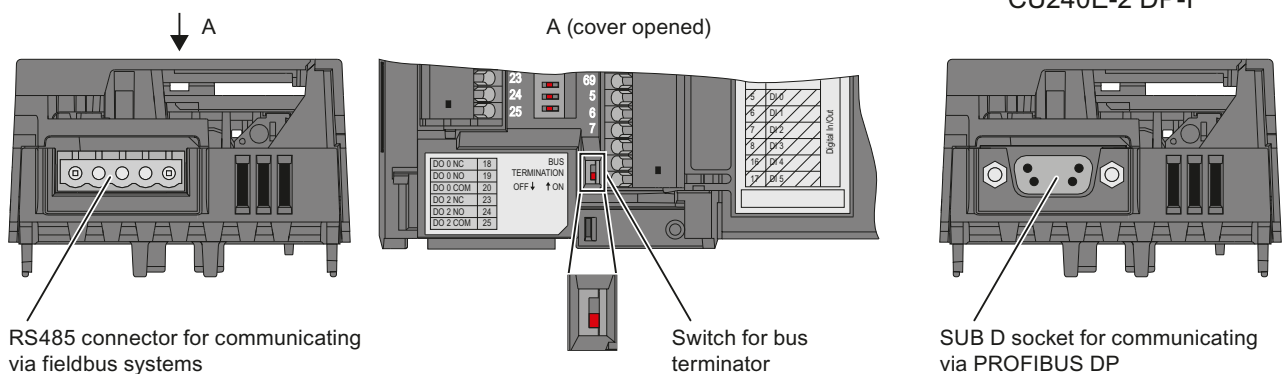



Figure 3-11 User interfaces using the example of the CU240E-2 DP

3.4.3 Terminal strips on CU240B-2 and CU240E-2 Control Units

Terminals	Terminal markings	Explanations
	31 +24V IN	18 V ... 30 V electronic supply input relating to GND
	32 GND IN	Reference potential for terminal 31
	- -	
	- -	
	- -	
	- -	
	- -	
	- -	
	- -	
	- -	
	1 +10V OUT	10 V output relating to GND, max. 10mA
	2 GND	overall reference potential
	3 AI 0+	Analog input 0 (-10 V ... 10 V, 0/4 mA ... 20 mA)
	4 AI 0-	Reference potential for analog input 0
	12 AO 0+	Analog output 0 (0 V ... 10 V, 0 mA ... 20 mA, max. 500 Ω)
	13 GND	overall reference potential
	- -	
	- -	
	14 T1 MOTOR	Motor temperature sensor (PTC, KTY84-130 or bimetal NC contact)
	15 T2 MOTOR	Motor temperature sensor (PTC, KTY84-130 or bimetal NC contact)
	9 +24V OUT	24 V output, reference potential GND, max. 200 mA
	28 GND	overall reference potential
	69 DI COM	Reference potential for digital inputs
	5 DI 0	Digital input 0
	6 DI 1	Digital input 1
	7 DI 2	Digital input 2
	8 DI 3	Digital input 3
	- -	
	- -	
	18 DO 0 NC	Digital output 0, break contact
	19 DO 0 NO	Digital output 0, NO contact 0,5 A, 30 V DC
	20 DO 0 COM	Digital output 0, root contact

Figure 3-12 Terminal strip on CU240B-2 and CU240B-2 DP

If you require more than four digital inputs, use analog input AI 0 as additional digital input DI 11.

 CAUTION
<p>If your application requires UL certification, please observe the note regarding the digital output in Section Technical data, CU240B-2 Control Unit (Page 261).</p>

Terminals	Terminal markings	Explanations
	31 +24V IN	18 V ... 30 V Electronic supply input referred to GND
	32 GND IN	Reference potential for terminal 32
	34 DI COM2	Reference potential for digital inputs 1, 3, 5, 12
	10 AI1+	Analog input 1 (-10 V ... 10 V, 0/4 mA ... 20 mA) or digital input 12
	11 AI1-	Reference potential for analog input 1
	26 AO1+	Analog output 1 (0 V ... 10 V, 0 mA ... 20 mA, max. 500 Ω)
	27 GND	overall reference potential
	1 +10V OUT	10 V output referred to GND, max. 10mA
	2 GND	overall reference potential
	3 AI 0+	Analog input 0 (-10 V ... 10 V, 0/4 mA ... 20 mA) or digital input 11
	4 AI 0-	Reference potential for analog input 0
	12 AO 0+	Analog output 0 (0 V ... 10 V, 0 mA ... 20 mA, max. 500 Ω)
	13 GND	overall reference potential
	21 DO 1 +	Digital output 1, positive, 0.5 A, 30 V DC
	22 DO 1 -	Digital output 1, negative, 0.5 A, 30 V DC
	14 T1 MOTOR	Motor temperature sensor (PTC, KTY84-130 or bimetal NC contact)
	15 T2 MOTOR	Motor temperature sensor (PTC, KTY84-130 or bimetal NC contact)
	9 +24V OUT	24 V output, reference potential GND, max. 200 mA
	28 GND	overall reference potential
	69 DI COM1	Reference potential for digital inputs 0, 2, 4, 11
	5 DI 0	Digital input 0
	6 DI 1	Digital input 1
	7 DI 2	Digital input 2
	8 DI 3	Digital input 3
	16 DI 4	Digital input 4
	17 DI 5	Digital input 5
	18 DO 0 NC	Digital output 0, break contact
	19 DO 0 NO	Digital output 0, NO contact
	20 DO 0 COM	Digital output 0, root contact
	23 DO 2 NC	Digital output 2, break contact
	24 DO 2 NO	Digital output 2, NO contact
	25 DO 2 COM	Digital output 2, root contact

Figure 3-13 Terminal strip on CU240E-2, CU240E-2 F, CU240E-2 DP and CU240E-2 DP-F

If you require more than six digital inputs, use analog inputs AI 0 or AI 1 as additional digital inputs DI 11 or DI 12.

CAUTION

If your application requires UL certification, please observe the note regarding the digital output in Section Technical data, CU240E-2 Control Unit (Page 262).

For a fail-safe digital input, use two "standard" digital inputs.

Terminals	Designation	Fail-safe digital input with Basic Safety
16	DI4	F-DI0
17	DI5	

If you wish to use several fail-safe digital inputs of the inverter, this is described in the Safety Integrated Function Manual. You will find the link to the Safety Integrated Function Manual in Section Overview of documentation (Page 13).

Additional information on fail-safe digital inputs is available in Chapter Permitted sensors (Page 214).

3.4.4 Wiring terminal strips

Solid or flexible cables are permitted as signal lines. Wire end ferrules must not be used for the spring-loaded terminals.

The permissible cable cross-section ranges between 0.5 mm² (21 AWG) and 1.5 mm² (16 AWG). When completely connecting-up the unit, we recommend cables with a cross-section of 1mm² (18 AWG).

Route the signal lines so that you can again completely close the front doors after connecting-up the terminal strip. If you use shielded cables, then you must connect the shield to the mounting plate of the control cabinet or with the shield support of the inverter through a good electrical connection and a large surface area.

4.1 Typical commissioning scenarios

After installation, you need to commission the inverter to set the inverter functions such that the inverter/motor combination is best adapted to the drive task.

The inverter's functions and parameters are accessed either via the Operator Panel (BOP-2 or IOP) or the STARTER commissioning tool from a PC.

An inverter can also be commissioned by saving the settings of an inverter (which has been fully commissioned) onto a memory card (see External data backup and series commissioning (Page 86)) or the Operator Panel or using STARTER in the PC and then transferring (upload and download) them to another inverter used for the same drive task.

Note

Should anything go wrong during commissioning ...

If you are not able to complete commissioning for any reason, be it due to line voltage failure or because you made an error when setting the parameters and can no longer reproduce the individual settings or do not know whether the inverter has been used before, you can restore the inverter to the factory settings. See Restoring the factory setting (Page 92).

Commissioning guidelines

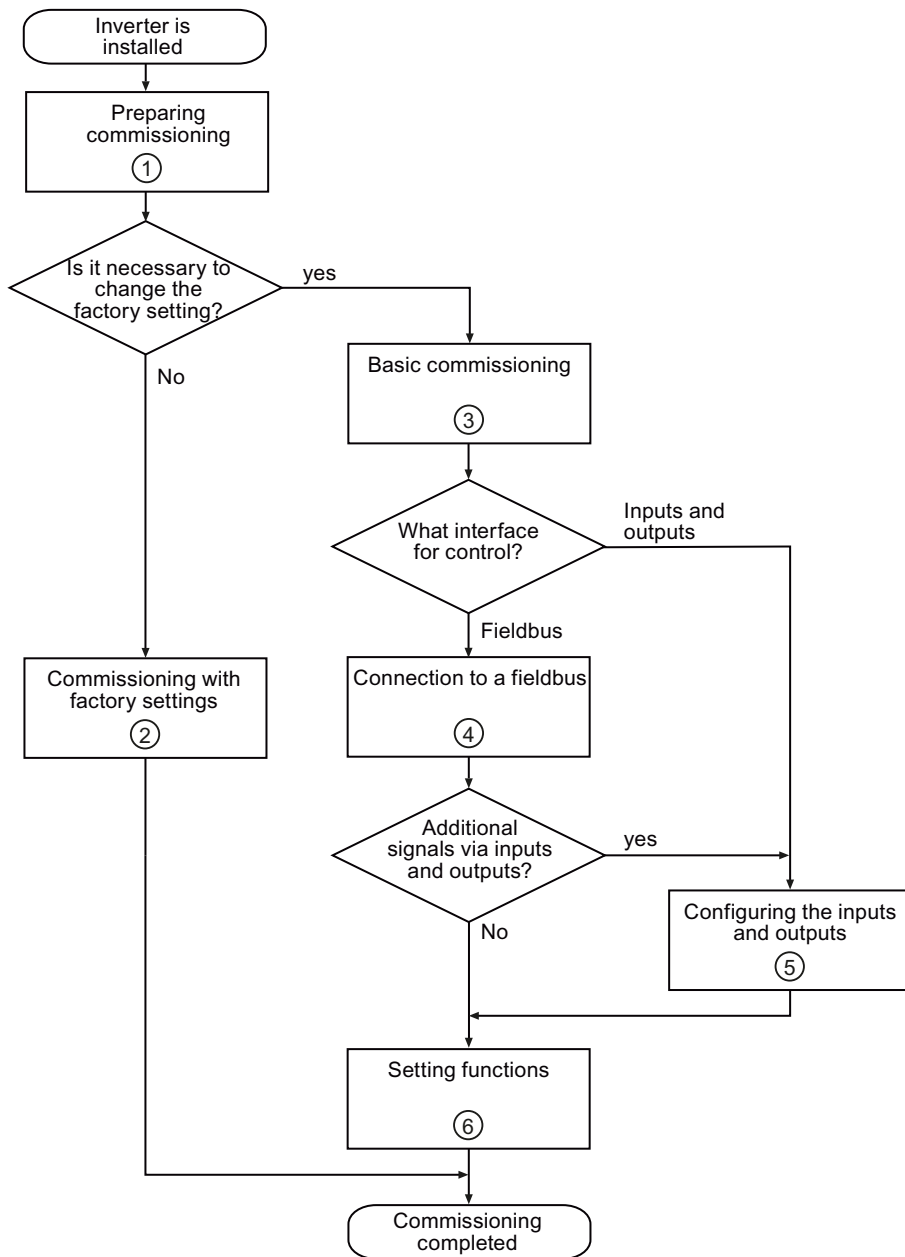

- ① Preparing commissioning (Page 57)
- ② Commissioning with factory settings (Page 60)
- ③ Commissioning with the BOP-2 (Page 68)
Commissioning with STARTER (Page 73)
- ④ Connection to a fieldbus (Page 103)
- ⑤ Configuring the terminal block (Page 93)
- ⑥ Functions (Page 155)

Figure 4-1 Commissioning procedure

Users can access the inverter parameters via the following interfaces

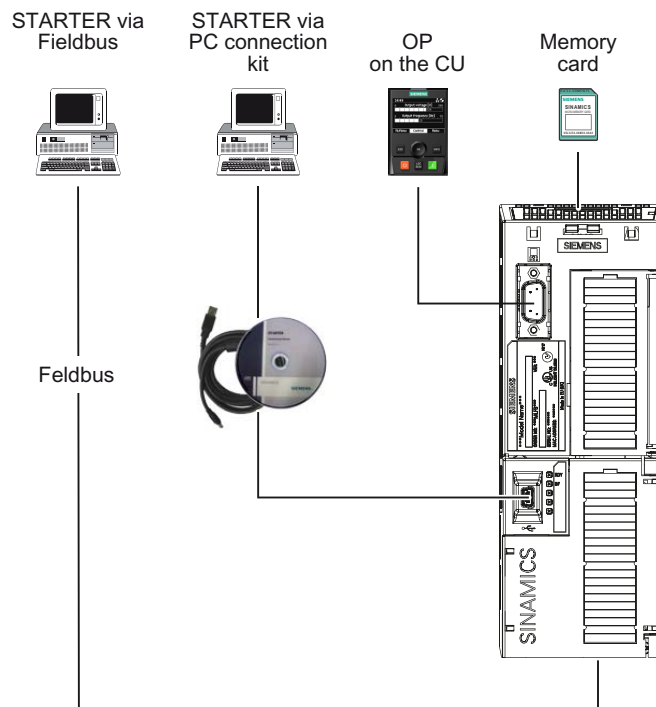

Figure 4-2 Inverter's parameterization interfaces

4.2 Preparing commissioning

Prerequisites: before you start

Before starting the commissioning, you should clarify the following.

Are the factory settings sufficient for your application?

Check which factory settings can be used and which functions need to be changed (see section Commissioning with factory settings (Page 60)). During this check you will probably find that the factory settings only require slight adjustment.

Which motor are you using? [P0300]

A synchronous or induction motor?

The inverters are preset in the factory for applications using 4-pole three-phase induction motors that correspond to the performance data of the inverter.

Motor data / data on the motor rating plate

If you use the STARTER commissioning tool and a SIEMENS motor, you only have to specify the motor Order No. In all other cases, you must read-off the data from the motor rating plate and enter into the appropriate parameters.

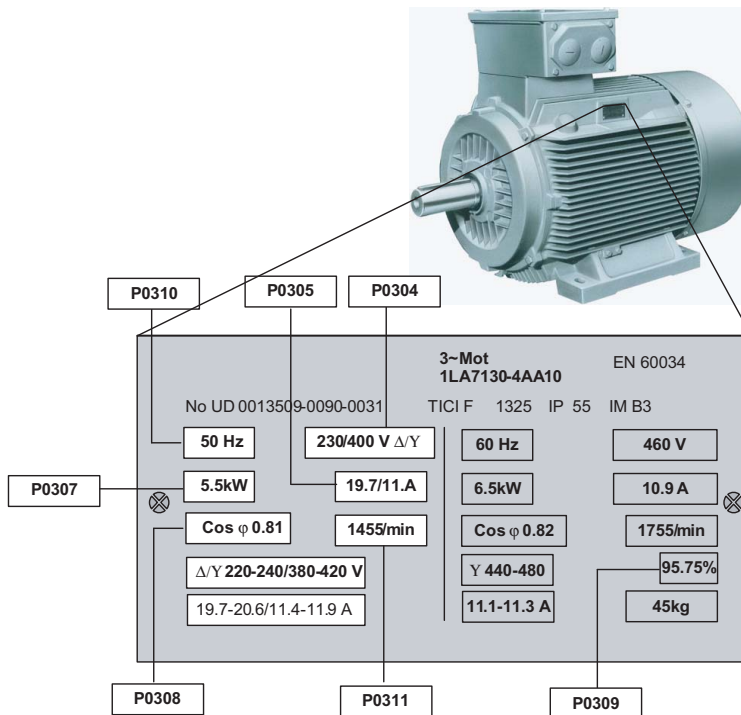

NOTICE

Information about installation

The rating plate data that you enter must correspond to the connection type of the motor (star connection [Y]/ delta connection [Δ]), i.e. for a delta motor connection, the delta rating plate data must be entered.

In which region of the world is the motor used? - Motor standard [P0100]

- Europe IEC: 50 Hz [kW] - factory setting
- North America NEMA: 60 Hz [hp] or 60 Hz [kW]

What is the prevailing temperature where the motor is operated? [P0625]

- Motor ambient temperature [P0625], if it differs from the factory setting = 20° C.

What type of control is needed for the application? [P1300]

A distinction is made between V/f open-loop control and vector closed-loop control.

- The V/f open-loop control is the simplest operating mode for an inverter. For example, it is used for applications involving pumps, fans or motors with belt drives.
- For closed-loop vector control, the speed deviations between the setpoint and actual value are less than for V/f open-loop control; further, it is possible to specify a torque. It is suitable for applications such as winders, hoisting equipment or special conveyor drives.

Which command and setpoint sources are used to control the motor?

The command and setpoint sources available are specified by the inverter's Control Unit.

On Control Units with a PROFIBUS interface the specified commands and setpoints are preset by the control. For all other Control Units the digital inputs and analog inputs are preset.

- **Possible command sources**
 - Fieldbus (when commands are specified by a control) - can be selected using P0700
 - Digital inputs - can be selected using P0700
 - Operator Panel
 - STARTER PC tool (in the commissioning phase with the "operator panel")
- **Possible setpoint sources**
 - Motorized potentiometer - can be selected using P1000
 - Analog setpoint - can be selected using P1000
 - Fixed frequency - can be selected using P1000
 - Fieldbus - can be selected using P1000
 - STARTER PC tool (in the commissioning phase with the "operator panel")

What speed limits should be set? (Minimum and maximum speed)

The minimum and maximum speed with which the motor operates or is limited regardless of the speed setpoint.

- Minimum speed [P1080] - factory setting 0 [rpm]
- Maximum speed [P1082] - factory setting 1500 [rpm]

What motor ramp-up time and ramp-down time are needed for the application?

The ramp-up and ramp-down time define the maximum motor acceleration when the speed setpoint changes. The ramp-up and ramp-down time is the time between motor standstill and the maximum speed, or between the maximum speed and motor standstill.

- Ramp-up time [P1120] - factory setting 10 s
- Ramp-down time [P1121] - factory setting 10 s

4.3 Commissioning with factory settings

4.3.1 Prerequisites for using the factory settings

Prerequisites for using the factory settings

In simple applications, commissioning can be carried out just using the factory settings. This section explains what prerequisites must be fulfilled for this purpose and how they are fulfilled.

1. The inverter and motor must match one another; compare the data on the motor rating plate with the technical data of the Power Module.
 - The rated inverter current must, as a minimum, be the same as the motor.
 - The motor power should match that of the inverter; motors can be operated in the power range from 25 % ... 100 % of the inverter power rating.
2. Commands and setpoints must be specified using the Control Unit sources set in the factory.
3. When connecting to a fieldbus, the bus address must be set using the DIP switch on the front of the Control Unit and the inverter must be connected to the control via the bus interface.
4. If controlling using the digital and analog inputs, the inverter must be connected as shown in the wiring example. (see Wiring examples for the factory settings (Page 64))

4.3.2 Inverter factory setting

Default command and setpoint sources

The inverters with PROFIBUS DP interface are preset in the factory so that the control and status signals can be exchanged via the fieldbus interface.

The other inverters are preset in the factory so that the control and status signals can be exchanged via the terminals.

Please refer to the following description or List Manual for details.

Table 4- 1 Command and setpoint sources

Parameter	Description
P0700 = 2 or 6	Select the command source 2: Digital inputs (P0701 ... P0709) (factory setting for CUs without PROFIBUS interface) 6: Fieldbus (P2050 ... P2091), (factory setting for CUs with PROFIBUS DP interface)
P1000 = 2 or 6	Select the setpoint source 2: Analog setpoint (factory setting for CUs without PROFIBUS DP interface) 6: Fieldbus (factory setting for CUs with PROFIBUS DP interface)

Table 4- 2 Factory settings of additional important parameters

Parameter	Factory setting	Meaning of the factory setting	Name of the parameter and comments
P0010	0	Ready to be entered	Drive, commissioning parameter filter
P0100	0	Europe [50 Hz]	IEC/NEMA motor standard <ul style="list-style-type: none"> IEC, Europe NEMA, North America Note: This parameter cannot be changed in FW4.3.
P0300	1	Induction motor	Motor type selection (induction motors / synchronous motor)
P0304	400	[V]	Rated motor voltage (in accordance with the rating plate in V)
P0305	depends on the Power Module	[A]	Rated motor current (in accordance with the rating plate in A)
P0307	depends on the Power Module	[kW/hp]	Rated motor power (in accordance with the rating plate in kW/hp)
P0308	0	[cos phi]	Rated motor power factor (in accordance with the rating plate in cos 'phi'). If P0100=1, 2, then P0308 has no significance.
P0310	50	[Hz]	Rated motor frequency (in accordance with the rating plate in Hz)
P0311	1395	[rpm]	Rated motor speed (in accordance with the rating plate in rpm)
P0335	0	Non-ventilated: Shaft-mounted fan in the motor	Motor cooling type (specify the motor cooling system)
P0625	20	[°C]	Motor ambient temperature
P0640	200	[A]	Current limit (of the motor)
P0970	0	Locked	Reset drive parameters (restore to the factory settings)
P1080	0	[rpm]	Minimum speed
P1082	50	[rpm]	Maximum speed
P1120	10	[s]	Ramp-function generator, ramp-up time
P1121	10	[s]	Ramp-function generator, ramp-down time
P1300	0	V/f control with linear characteristic	Open-loop/closed-loop control operating mode

4.3.3 Pre-assignment of the inputs and outputs

Terminal strip factory settings

Digital inputs				
Terminal	Abbreviation	Parameter	Factory setting	Meaning of the factory setting
5	DI0	P0701	1 or 0	ON/OFF1
6	DI1	P0702	12 or 0	Direction reversal
7	DI2	P0703	9	Fault acknowledgment
8	DI3	P0704	15	Fixed frequency selector bit 0 (direct) [P1001]
16	DI4	P0705	16	Fixed frequency selector bit 1 (direct) [P1002]
17	DI5	P0706	17	Fixed frequency selector bit 2 (direct) [P1003]

Digital outputs (relay outputs)					
Terminal	Abbreviation	Parameter	Factory setting	Meaning of the factory setting	
18	NC	DO0	P0730	52.3	Drive fault active
19	NO				
20	COM				
21	NO	DO1	P0731	52.7	Drive alarm active
22	COM				
23	NC	DO2	P0732	52.2	Operation enabled
24	NO				
25	COM				

Analog inputs					
Terminal	Abbreviation	Parameter	Factory setting	Meaning of the factory setting	
3	AI0+	AI0	P0756 [0]	4	Set bipolar voltage input -10 V ... +10 V DC in addition to parameterizing DIP switch on CU housing.
4	AI0-				
In the factory setting, analog input 0 supplies the speed setpoint.					
10	AI1+	AI1	P0756 [1]	4	Set bipolar voltage input -10 V ... +10 V DC in addition to parameterizing DIP switch on CU housing.
11	AI1-				

Analog outputs					
Terminal	Abbreviation		Parameter	Factory setting	Meaning of the factory setting
12	AO0+	AO0	P0771[0]	0	Analog output is locked; can be switched from voltage output to current output by means of P0776
13	AO0-				
26	AO1+	AO1	P0771[1]	0	Analog output is locked; can be switched from voltage output to current output by means of P0776
27	AO1-				

PTC/KTY84 interface					
Terminal	Abbreviation		Parameters	Factory setting	Meaning of the factory setting
14	PTC+		P0601	0	Evaluation of the motor temperature sensor is locked
15	PTC-				

4.3.4 Wiring examples for the factory settings

To ensure that the factory setting can be used, you must wire the terminal strip of your inverter as shown in the following examples.

Pre-assignment of the terminal strip for the CU240B-2

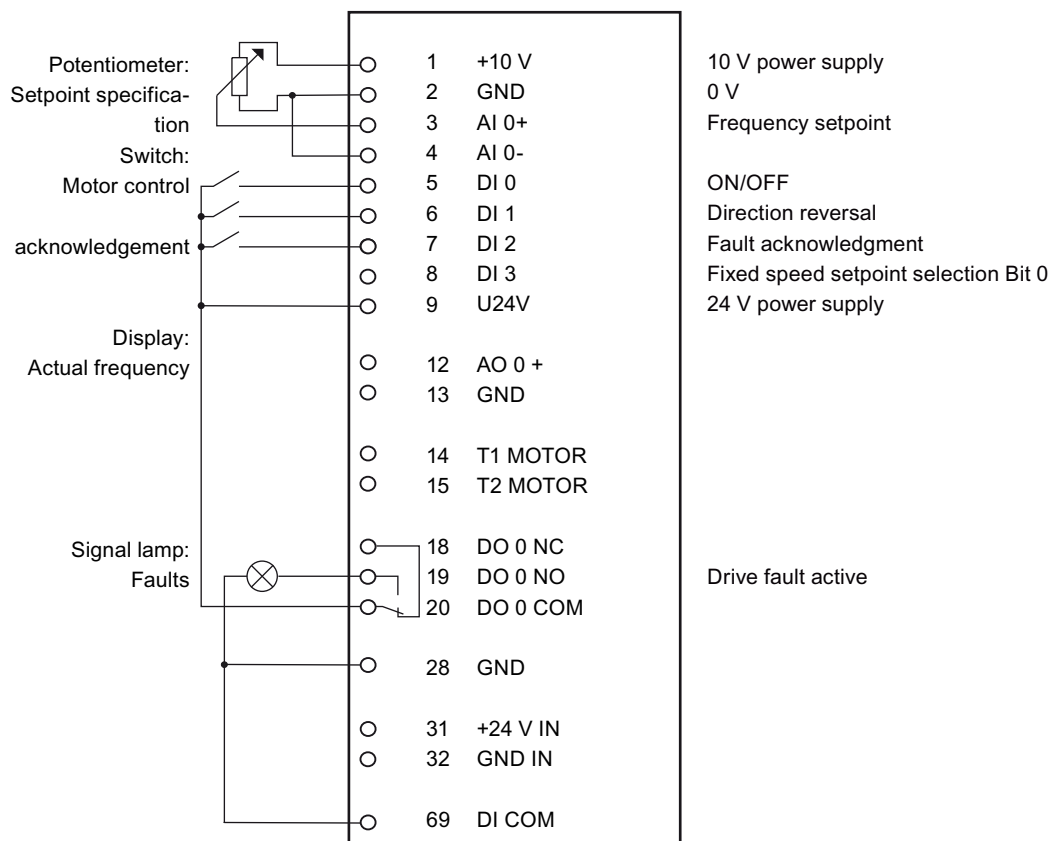

Figure 4-3 CU240B-2: Wiring example for the factory settings

Note

Assignment of the terminal strip after basic commissioning

Once you have performed basic commissioning, the pre-assignment of the terminal strip will not have changed.

Pre-assignment of the terminal strip for the CU240B-2 DP

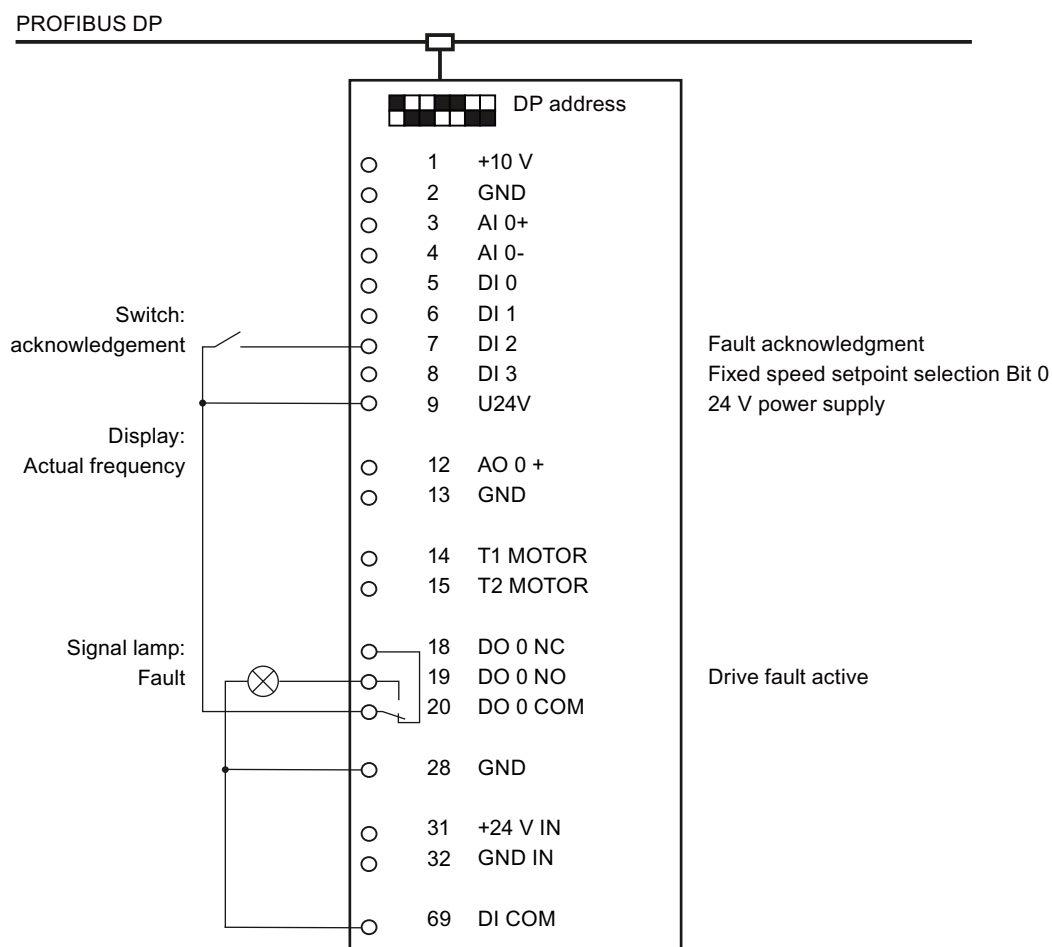

Figure 4-4 CU240B-2 DP: Wiring example for the factory settings

Note

Assignment of the terminal strip after basic commissioning

The CU240B-2 DP Control Unit is assigned in the same way as the CU240B-2 (without PROFIBUS interface) when you deselect bus communication for both the command sources and the setpoint value specification during basic commissioning of the inverter.

Pre-assignment of the terminal strip for the CU240E-2 and CU240E-2 F

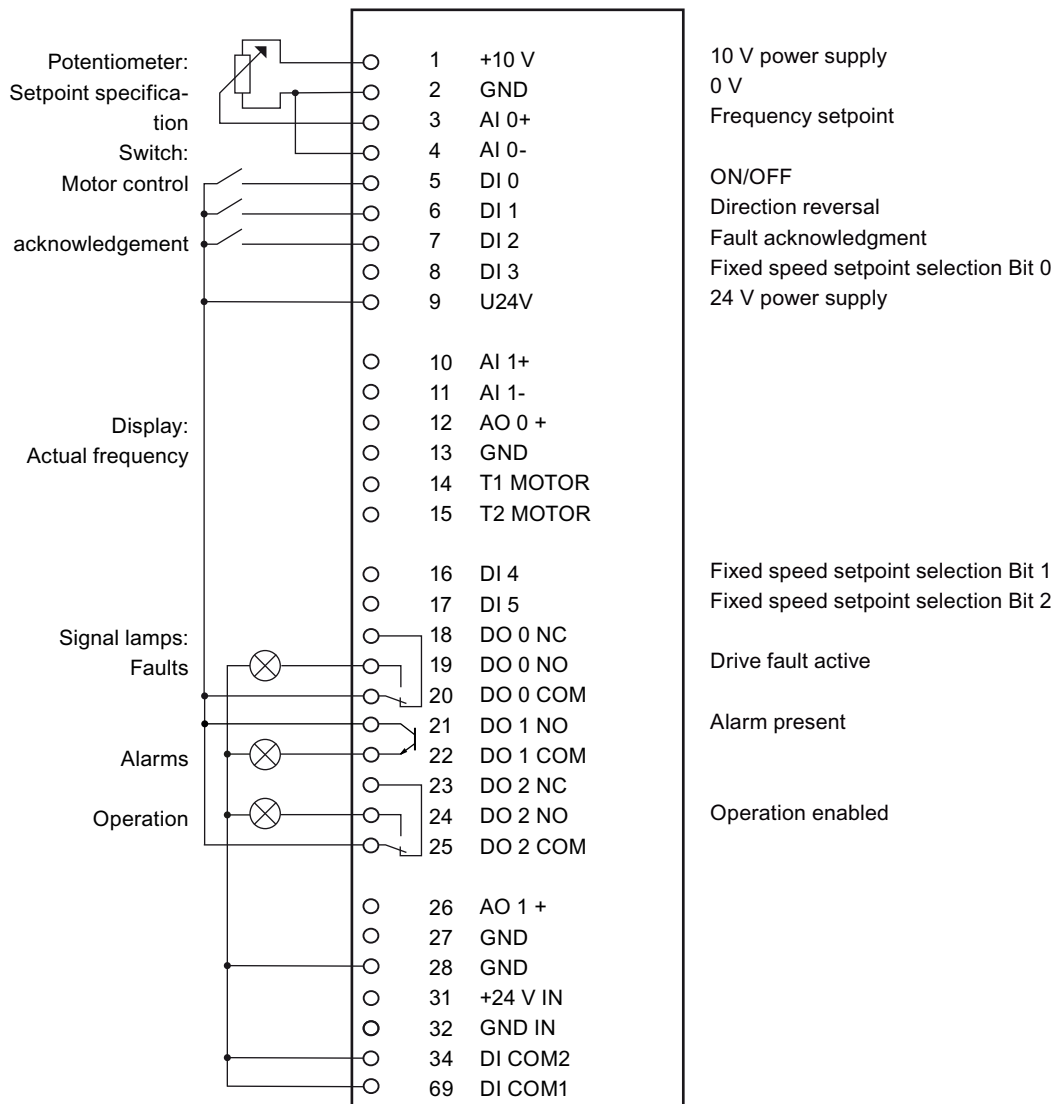

Figure 4-5 CU240E-2 and CU240E-2 F: Wiring example for the factory settings

Note

Assignment of the terminal strip after basic commissioning

The assignment of the terminal strip does not change once you have performed the basic commissioning procedure.

Pre-assignment of the terminal strip for the CU240E-2 DP and CU240E-2 DP-F

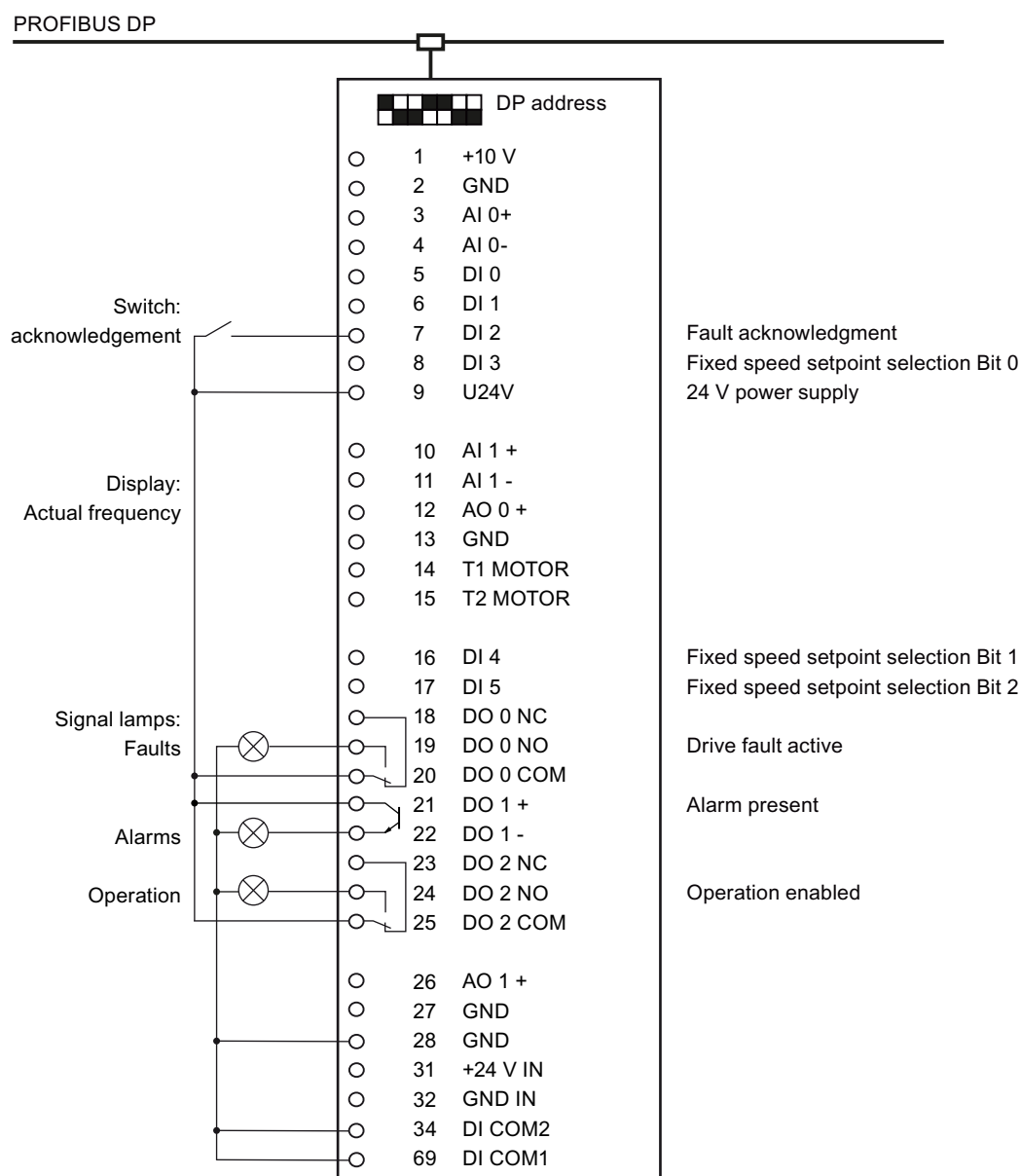

Figure 4-6 CU240E-2 DP and CU240E-2 DP-F: Wiring example for the factory settings

Note**Assignment of the terminal strip after basic commissioning**

The CU240E-2 DP (F) Control Unit is assigned in the same way as the CU240E-2 (F) (without PROFIBUS interface) when you deselect bus communication for both the command sources and the setpoint value specification during basic commissioning of the inverter.

4.4 Commissioning with the BOP-2

4.4.1 Inserting the BOP-2

The "Basic Operator Panel-2" (BOP-2) is an operation and display instrument of the inverter. It is directly inserted onto a Control Unit.

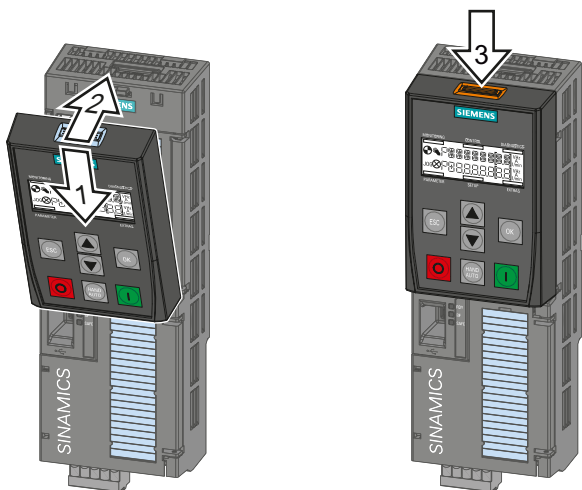

Insert BOP-2

Remove BOP-2

4.4.2 Display of the BOP-2

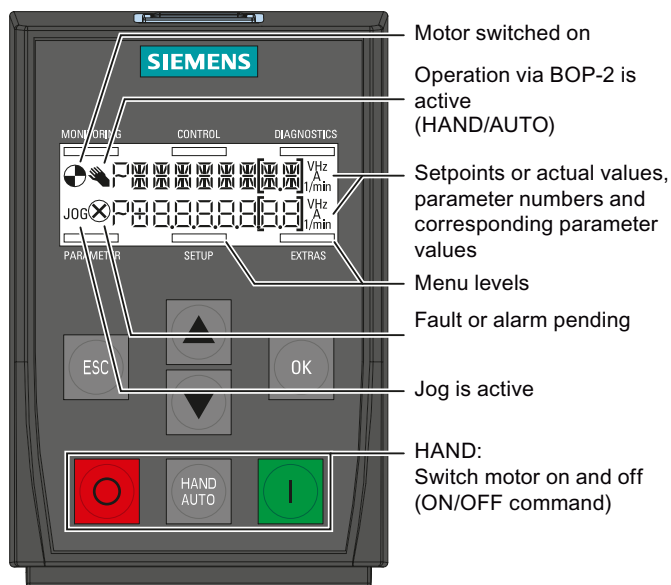
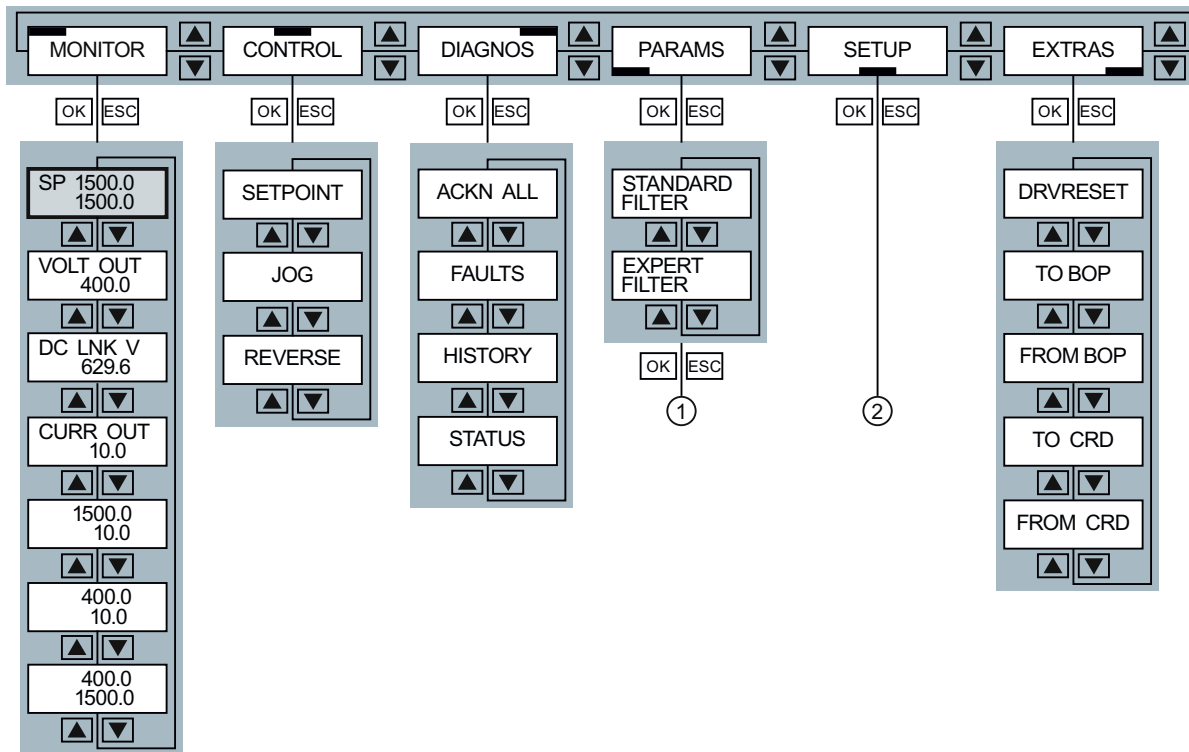

Figure 4-7 Meaning of the display in the BOP-2

4.4.3 Menu structure



- ① Changing parameter values.
- ② Basic commissioning

4.4.4 Changing parameter values.

Use BOP-2 to change your inverter settings, by selecting the appropriate parameter number and changing the parameter value. Parameter values can be changed in the menu "PARAMS" and in the menu "SETUP"

Select the parameter number

- If the parameter number flashes in the display, you have two options of selecting the number:
 - Using the arrow keys, scroll to the required parameter number.
 - Press the OK key for longer than two seconds and enter the required parameter number digit for digit:

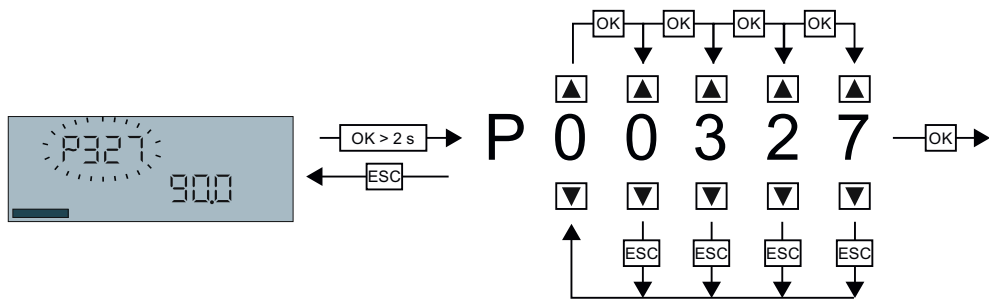

- Accept the parameter number by briefly pressing the OK key.

Changing a parameter value

- If the parameter value flashes in the display, you have two options of changing the value:
 - Changing the parameter value using the arrow keys.
 - Press the OK key for longer than two seconds and enter the required value digit for digit:

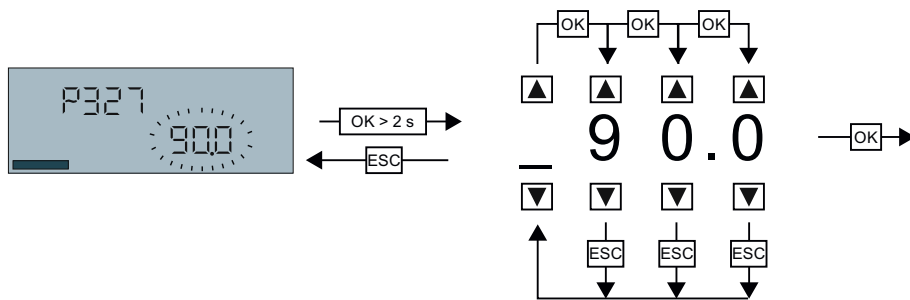

- Accept the parameter value by briefly pressing the OK key.

Saving settings so that they are not lost when the power fails

The inverter immediately saves all changes which you made using the BOP-2 so that they are protected against power failure.

4.4.5 Basic commissioning

Table 4- 3 Set the parameters of this menu one after the other:

Menu	Remark	
<div style="border: 1px solid black; padding: 2px; display: inline-block;">SETUP</div> <div style="border: 1px solid black; padding: 2px; margin-left: 10px;">OK</div>	In the BOP-2, select the menu "SETUP".	
<div style="border: 1px solid black; padding: 2px; display: inline-block;">RESET</div> <div style="border: 1px solid black; padding: 2px; margin-left: 10px;">OK</div> <div style="margin-left: 10px;">▲ ▼</div>	Select Reset (Parameter p0970) if you wish to reset all parameters to the factory setting before the basic commissioning: NO → YES → OK	
<div style="border: 1px solid black; padding: 2px; display: inline-block;">CTRL MOD p1300</div> <div style="border: 1px solid black; padding: 2px; margin-left: 10px;">OK</div> <div style="margin-left: 10px;">▲ ▼</div>	Select the motor control mode:	
	V/f control	Vector control
	VF LIN with linear characteristic	SPD N EN Speed control
	...	TRQ N EN Torque control
	VF QUAD with square-law characteristic	
<div style="border: 1px solid black; padding: 2px; display: inline-block;">EUR USA p100</div> <div style="border: 1px solid black; padding: 2px; margin-left: 10px;">OK</div> <div style="margin-left: 10px;">▲ ▼</div>	② Standard: IEC or NEMA	
<div style="border: 1px solid black; padding: 2px; display: inline-block;">MOT VOLT p304</div> <div style="border: 1px solid black; padding: 2px; margin-left: 10px;">OK</div> <div style="margin-left: 10px;">▲ ▼</div>	① Voltage	
<div style="border: 1px solid black; padding: 2px; display: inline-block;">MOT CURR p305</div> <div style="border: 1px solid black; padding: 2px; margin-left: 10px;">OK</div> <div style="margin-left: 10px;">▲ ▼</div>	③ Current	
<div style="border: 1px solid black; padding: 2px; display: inline-block;">MOT POW p307</div> <div style="border: 1px solid black; padding: 2px; margin-left: 10px;">OK</div> <div style="margin-left: 10px;">▲ ▼</div>	④ Power	
<div style="border: 1px solid black; padding: 2px; display: inline-block;">MOT RPM p311</div> <div style="border: 1px solid black; padding: 2px; margin-left: 10px;">OK</div> <div style="margin-left: 10px;">▲ ▼</div>	⑥ Rated speed	
<div style="border: 1px solid black; padding: 2px; display: inline-block;">MOT ID p1900</div> <div style="border: 1px solid black; padding: 2px; margin-left: 10px;">OK</div> <div style="margin-left: 10px;">▲ ▼</div>	We recommend the setting STIL ROT (Identify motor data at standstill and with the motor rotating). If the motor cannot rotate freely, e.g. where travel is mechanically limited, select the setting STILL (Identify motor data at standstill).	
<div style="border: 1px solid black; padding: 2px; display: inline-block;">CMD SRC p700</div> <div style="border: 1px solid black; padding: 2px; margin-left: 10px;">OK</div> <div style="margin-left: 10px;">▲ ▼</div>	Select the command source (terminal strip or fieldbus).	
<div style="border: 1px solid black; padding: 2px; display: inline-block;">MAIN SP p1000</div> <div style="border: 1px solid black; padding: 2px; margin-left: 10px;">OK</div> <div style="margin-left: 10px;">▲ ▼</div>	Select the source for the main setpoint (analog input, motorized potentiometer, fixed setpoint or fieldbus).	
<div style="border: 1px solid black; padding: 2px; display: inline-block;">ADD SP p1075</div> <div style="border: 1px solid black; padding: 2px; margin-left: 10px;">OK</div> <div style="margin-left: 10px;">▲ ▼</div>	If you wish to use an additional setpoint, select the source.	

SIEMENS (H) (EFF1) CE

D-91056 Erlangen
3~Mot. 1LE10011AC434AA0 | E0807/0496382_02 003

IEC/EN 60034 100L		IMB3	IP55
25 kg	Th.Cl. 155(F)	-20°C	Tamb 40°C

Bearing	UNIREX-N3
DE 6206-2ZC3	15g
NE 6206-2ZC3	11g
Intervall: 4000hrs	

60Hz: SF 1.15 CONT NEMA MG1-12 TEFC Design A 2.0 HP

V	Hz	A	kW	PF	NOM.EFF	rpm	V	A	CL
400 Δ	50	3.5	1.5	0.73	84.5%	970	380 - 420	3.55-3.55	
690 Y	50	2.05	1.5	0.73	84.5%	970	660 - 725	2.05-2.05	
460 Δ	60	3.15	1.5	0.69	86.5%	1175			K

① ② ③ ④ ⑤ ⑥

Motor data on the rating plate

Menu	Remark
<div style="border: 1px solid black; padding: 2px; display: inline-block;"> MIN RPM p1080 ▲ ▼ </div> <div style="border: 1px solid black; padding: 2px; display: inline-block; margin-left: 10px;">OK</div>	Minimum motor speed.
<div style="border: 1px solid black; padding: 2px; display: inline-block;"> RAMP UP p1120 ▲ ▼ </div> <div style="border: 1px solid black; padding: 2px; display: inline-block; margin-left: 10px;">OK</div>	Motor ramp-up time.
<div style="border: 1px solid black; padding: 2px; display: inline-block;"> RAMP DWN p1121 ▲ ▼ </div> <div style="border: 1px solid black; padding: 2px; display: inline-block; margin-left: 10px;">OK</div>	Motor ramp-down time.
<div style="border: 1px solid black; padding: 2px; display: inline-block;"> FINISH ▲ ▼ </div> <div style="border: 1px solid black; padding: 2px; display: inline-block; margin-left: 10px;">OK</div>	Confirm that the basic commissioning has been completed (Parameter p3900): NO → YES → OK

Identifying motor data

Alarm A07791 is output as long as the inverter has not identified the motor data. You must switch on the motor (e.g. from the BOP-2) to identify the motor data. The inverter switches off the motor after the motor data identification has been completed.

CAUTION

Motor data identification for dangerous loads

Secure dangerous plant and system parts before starting the motor data identification, e.g. by fencing off the dangerous location or lowering a suspended load to the floor.

4.4.6 Additional settings

After basic commissioning, you need to carry out further settings in your inverter.

In the section Typical commissioning scenarios (Page 55) we recommend a certain procedure to adjust your inverter to your application.

4.5 Commissioning with STARTER

4.5.1 Overview

If you are working with STARTER for the first time, you must initially carry out the following steps:

1. Install STARTER.
2. Install the USB interface.
3. Create a new STARTER project, or open an existing project.
4. Set-up the online connection from your PC or PG to the inverter.

After you have done this, perform the basic commissioning of your drive.

4.5.2 Requirements

The STARTER commissioning tool features a project Wizard that guides you step-by-step through the commissioning process.

The following is required to commission the inverter via the PC:

- A PC connection kit for connecting the inverter to a PC. This comprises:
 - USB cable for connecting inverter to PC
 - Installation DVD for STARTER
- A PC with installed STARTER software V4.1.5 or higher.
Information on the actual STARTER version and a possibility of downloading it from the Internet under STARTER (<http://support.automation.siemens.com/WW/view/en/26233208>).
- The motor must be connected to the inverter.

Note

The STARTER screens show general examples. You may therefore find that a screen contains more or fewer setting options than are shown in these instructions. A commissioning stage may also be shown using a Control Unit other than the one you are using.

4.5.3 Installing USB drivers

Description

You must install and set the USB driver if you are connecting your converter for the first time to your PC via the USB interface.

To start the installation:

- Connect the inverter to the PC using the USB cable supplied
- Switch on the inverter supply voltage

If you have still not installed the driver, then the following screen is displayed:

Without making any changes, click on "Next" and in the following screen select "Continue installation".

Installing the driver does not have any negative impact on your computer.

This completes the installation of the driver.

You must still set the interface address before you can start generating a STARTER project.

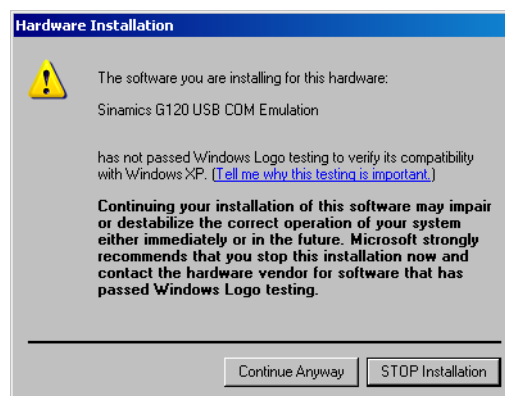

4.5.4 System settings in the PC/PG for the USB interface

Additional settings for the USB interface

Before you can commission the inverter using the computer, you must assign the USB interface to a COM interface in the range COM1 ... COM7 using the control panel. The procedure is explained in the following paragraphs.

Using the subsequently performed actions, you can identify which COM interface is assigned to the USB-COM emulation for the SINAMICS inverter.

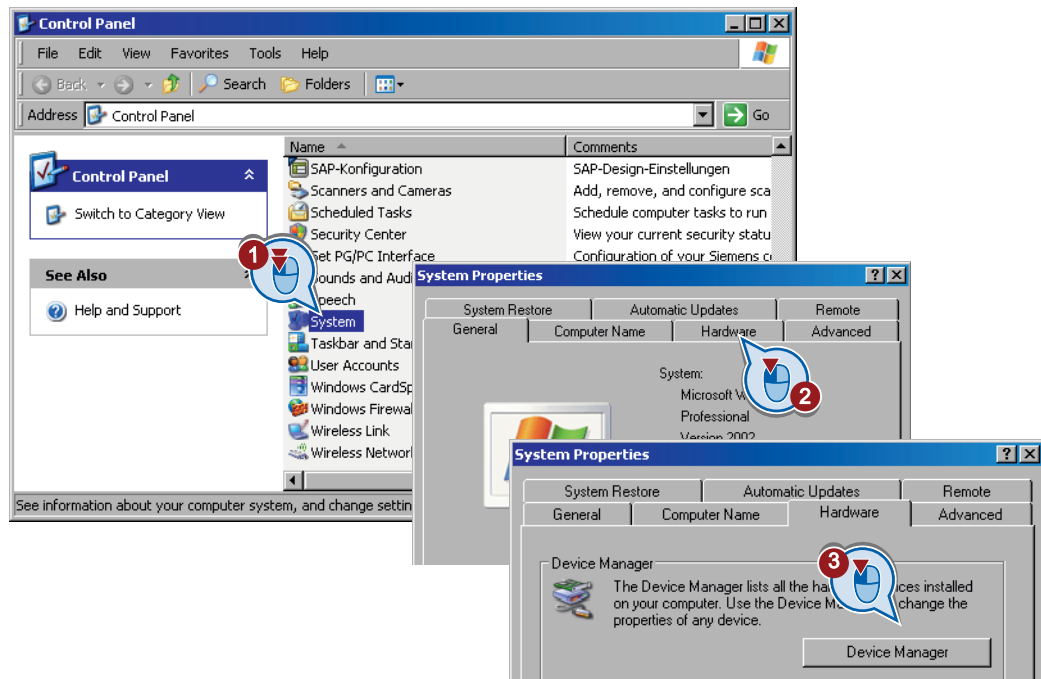

If the assignment lies in the range COM1 ... COM7, then you do not have to make any changes and you can close the control panel again. However, you should note the number of the COM interface as you will require it in a later installation step.

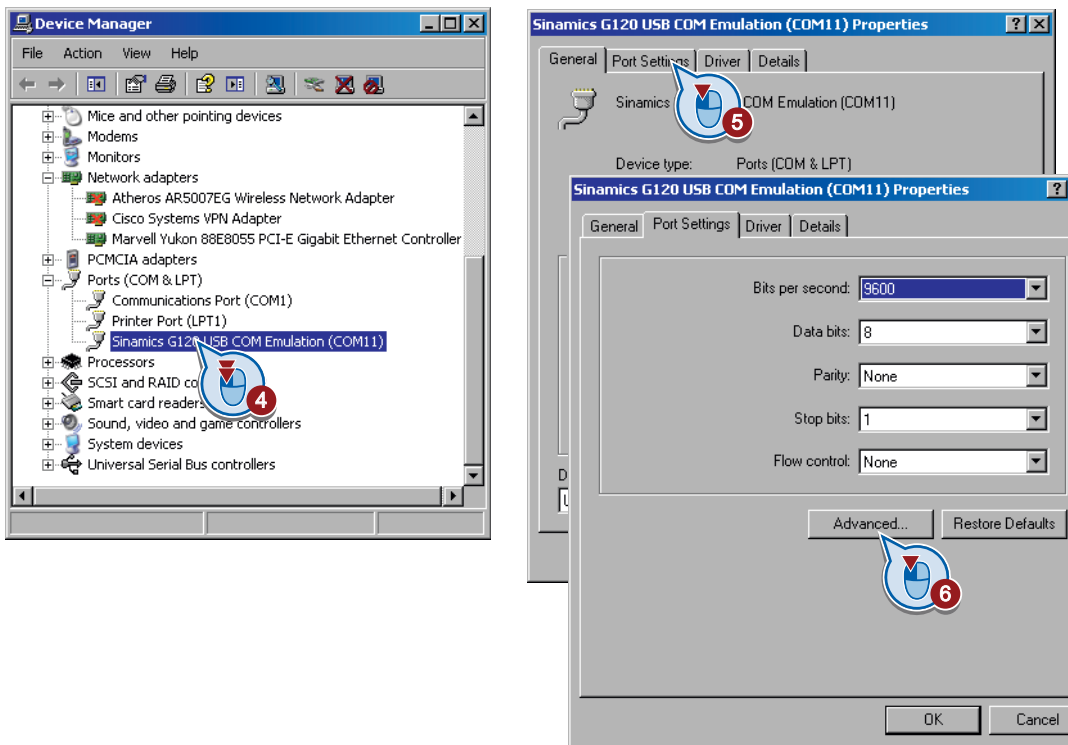

If the USB-COM emulation is assigned to an address higher than COM7, open the properties window by double-clicking on the interface. There you will find the "Advanced" button under the "Port settings" tab.

A click on this button opens the extended properties in which you can assign the COM connection number an address < 8 via a selection box. If all of the COM1 ... COM8 addresses are assigned, then select one of these addresses anyway and confirm the following message with "Yes". Please note the COM interface that you have assigned as you will require it in a subsequent installation step.

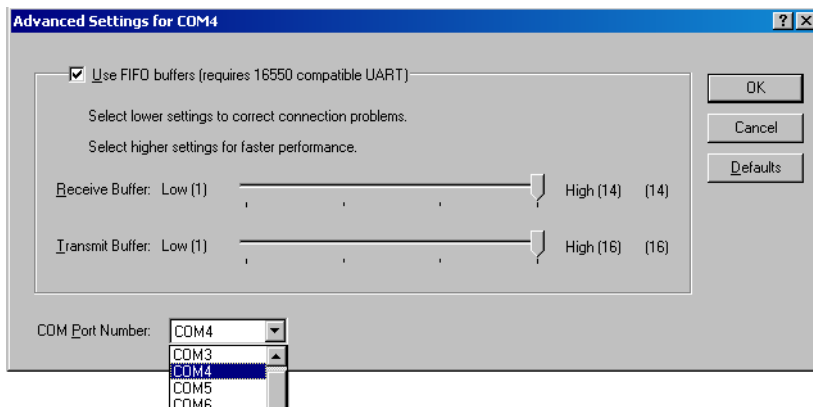

4.5.5 Creating a STARTER project

If you still do not know STARTER, then we recommend that you commission the system using the project wizards.

Procedure

- Switch on the inverter supply voltage.
- Launch the STARTER commissioning tool.
- Start a new project via "Project / New with Wizard".
- Click on "Find drive units online ...".

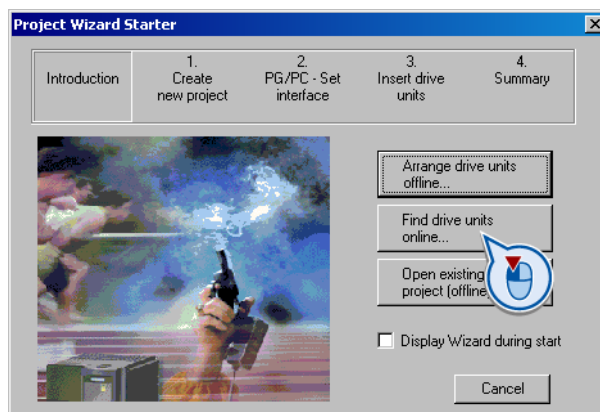

- In the window that follows (not shown here), enter a meaningful name for your project and click on "Continue". The following dialog box is displayed.

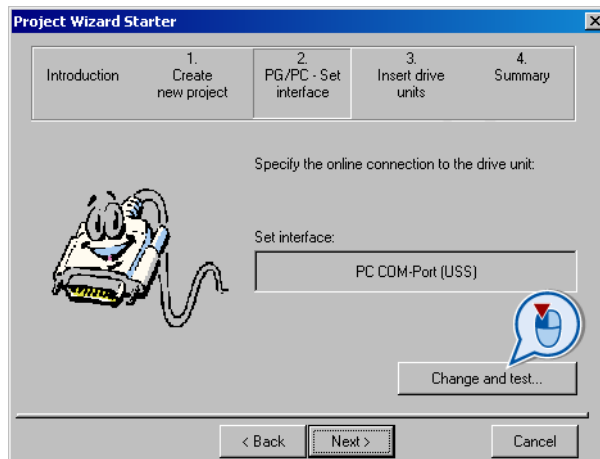

- Click "Change and test..." to set up the PG/PC interface.

PG/PC - Set interface

- Select "PC COM-Port (USS)" from the list and click on "Properties ..."

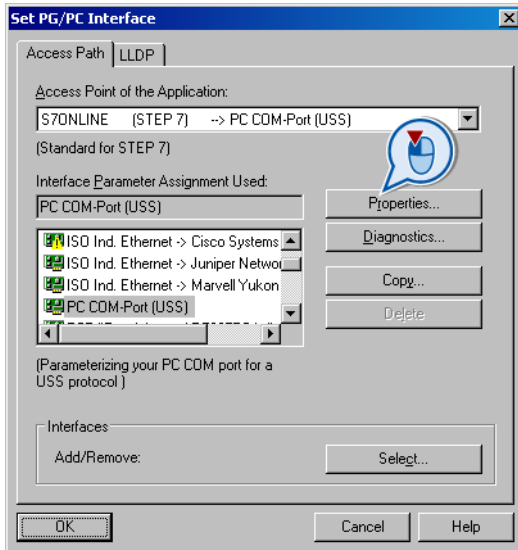

- If "PC COM-Port (USS)" is not available, click on "Select ..." to install the "PC COM-Port (USS)" interface as shown in the "Install/Remove Interfaces" dialog box.

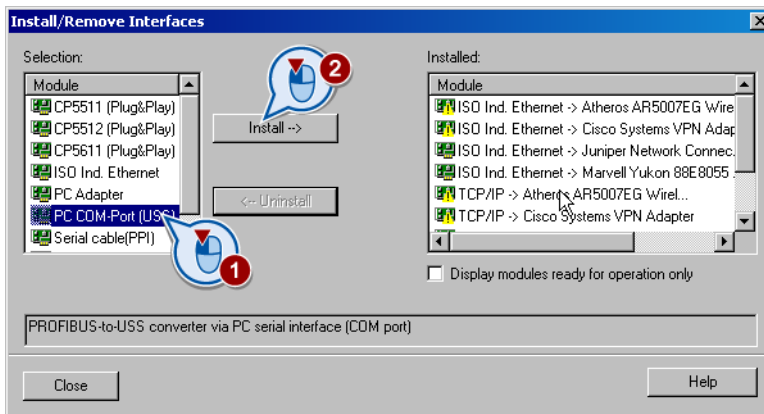

- If you have installed the PC COM-Port (USS) interface, close the dialog box and now call up "Properties - PC COM-Port (USS)".

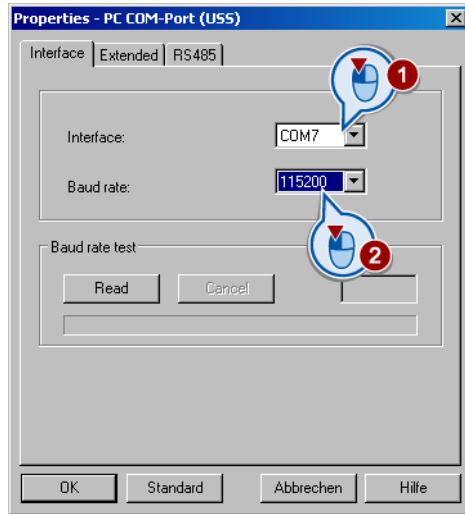

- In this dialog box, select the COM address that you defined when setting the USB interface. Select 115200 as baud rate.
- You can check the correctness of the settings using the "Read" button in the "Baud rate test" field. If your interface has been correctly set, then you see the baud rate that has been determined:

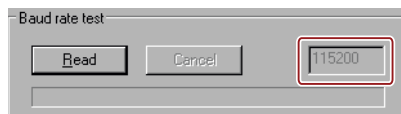

- If the PC cannot establish a connection to the converter, then "???" appears in the baud rate display field. In this case, check the number of the COM interface and the connecting cable.
- Under the "RS 485" tab, in addition, select the "Automatic mode".
- When you click "OK", the "Set PG/PC Interface" dialog box is displayed again.
- When you choose "OK" again, this takes you back to the Project Wizard.

- By clicking on "Continue" you start the search for available devices.

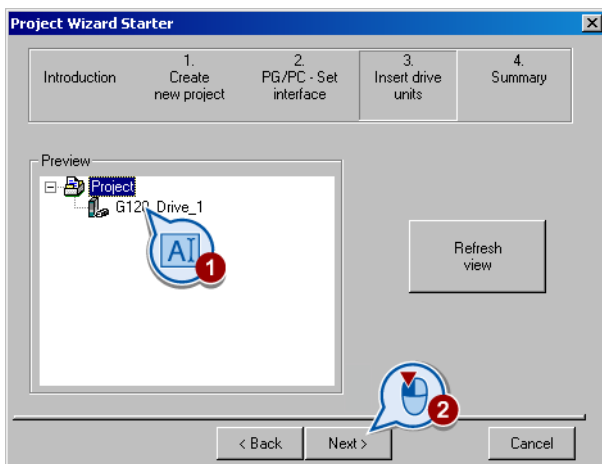

- In this dialog box, you can change the designation of your converter (no spaces or special characters).
- Click on "Continue" and close the following dialog box by clicking on "Complete".

This means that you have generated the STARTER project and the inverter is inserted in the STARTER project tree.

4.5.6 Establishing an online connection between the PC and converter (going "online")

Description

With the procedure described above, the project has been created and your inverter is integrated into the project tree. However, there is no online connection.

- In the STARTER, click on the  ("Connect to target system") button. In the next dialog box, select the inverter (✓) and confirm with OK.

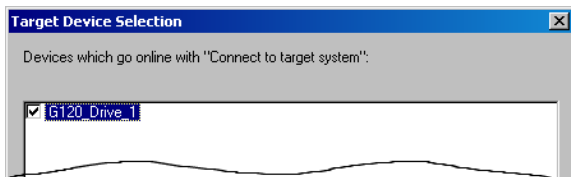

- The following dialog screen lists the inverter settings in the "Online" column. The "Offline" column will be empty for a new project.

- Click on "Load hardware configuration to PG" to save the online setup to your PC and create an online link between the inverter and PC.

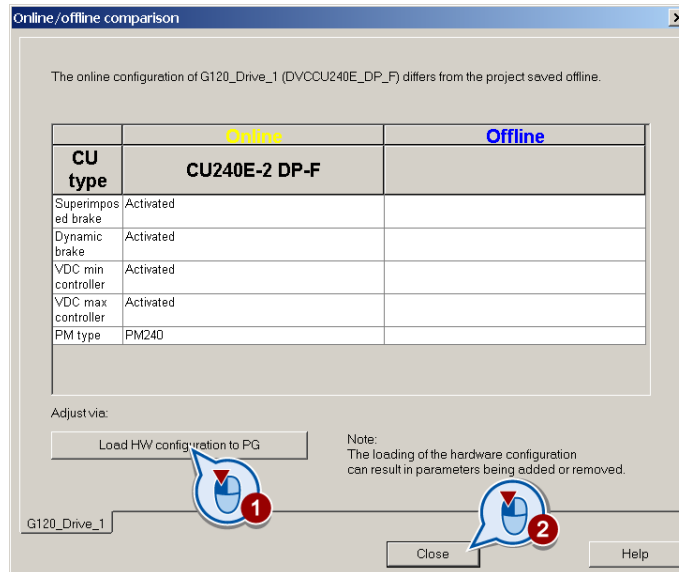

- To conclude your entry, choose "Close".
- The status display changes from the "Offline mode" with blue background into the "Online mode" with yellow background.

Note

If you click on "Close" without having first run "Load hardware configuration to PG", the data is not saved and the inverter remains offline.

4.5.7 Basic commissioning

- In the online state, open the STARTER screen of the Control Unit with a double click and there click on the "Wizard" button.

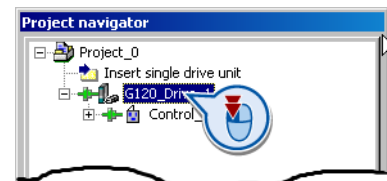

Carry-out basic commissioning

The configuration wizard guides you step by step through the commissioning procedure. After the basic commissioning, you can change all of the settings and make detailed changes.

- In the start dialog box of the basic commissioning, select the control mode of the motor. If you are not certain which control mode you require for your application, then initially select V/f control. Help on how to select the control mode is provided in Chapter Motor control (Page 168).

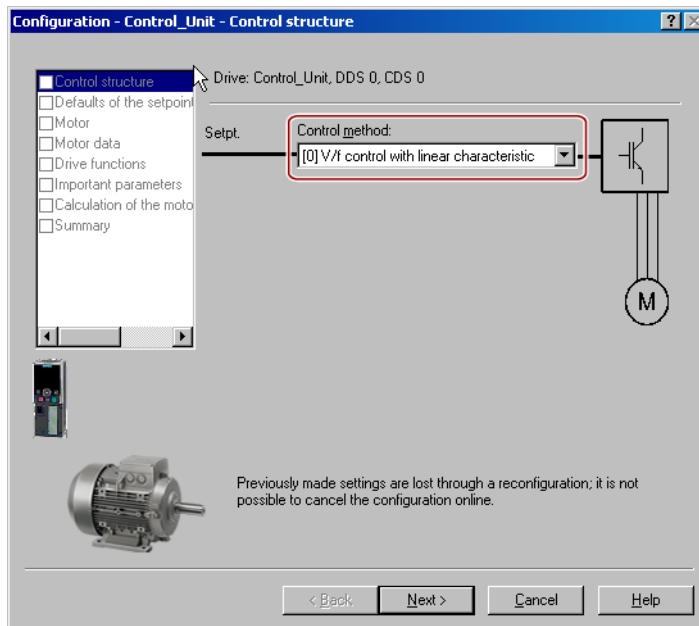
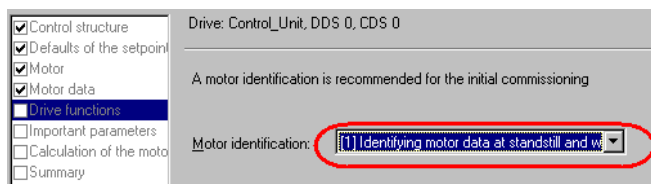

Figure 4-8 Basic commissioning with V/f control

- With "Continue" you can go to the next dialog boxes where you must make the appropriate settings for your particular application.
- In the "Drive functions" dialog, we recommend the setting "Identify motor data at standstill and with the motor rotating".



- If the motor cannot rotate freely, e.g. where travel is mechanically limited, select the setting "Identify motor data at standstill".

- We recommend the following setting in the dialog box "Calculate motor data":

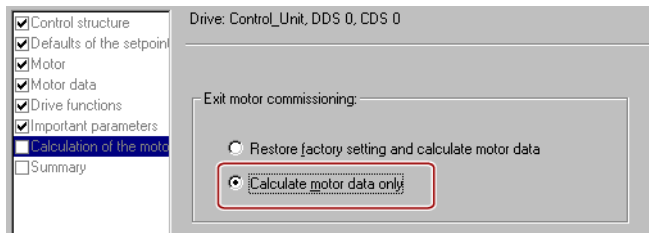

- Set the check mark for "RAM to ROM (save data in the drive)" in order to save your data in the inverter so that it is not lost when the power fails:

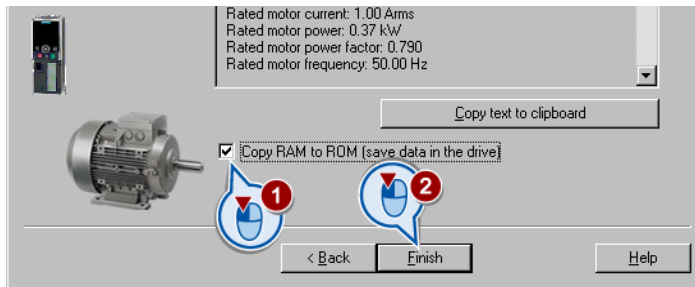

Identifying motor data

If the inverter has still not identified the motor data, alarm A07791 is output. You must switch-on the motor to identify its data.

CAUTION

Motor data identification for dangerous loads

Secure dangerous plant and system parts before starting the motor data identification, e.g. by fencing off the dangerous location or lowering a suspended load to the floor.

- In STARTER, select the control panel with a double click.

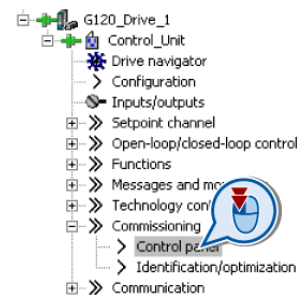

- In the control panel, click on the "Assume control priority" button. Then set the check mark for "Enables" signals and switch-on the motor.

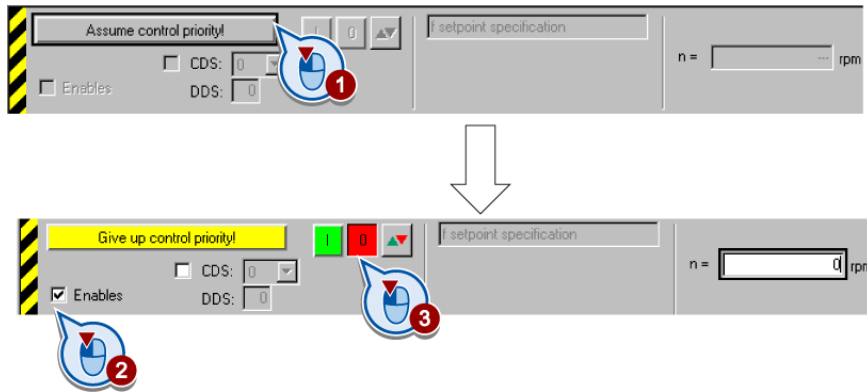

The inverter identifies the motor data after it has been switched-on. The measurement can take several minutes. After the measurement has been completed, the inverter automatically switches off the motor and alarm A07791 is cancelled.

- In the control panel, click on the "Give up control priority" button.

4.5.8 Additional settings

After basic commissioning, you need to carry out further settings in your inverter. Using STARTER, you can change your inverter settings in two ways:

1. Change the parameter values via the STARTER screens.
The screens show the most important parameters of an inverter function. If you change the parameter values using the STARTER screens, you do not need to know the parameter number.
2. Change the parameter values via the STARTER expert list.
If you wish to change the parameter values using the expert list, you need to know the parameter number.

In the section Typical commissioning scenarios (Page 55) we recommend a certain procedure to adjust your inverter to your application in the best way possible.

Changing parameter values using the expert list

- If you wish to specifically change parameters, then - as shown below - call the expert list; there, scroll to the parameter and then change its value. You close the expert list by double clicking on an entry in the STARTER project tree.

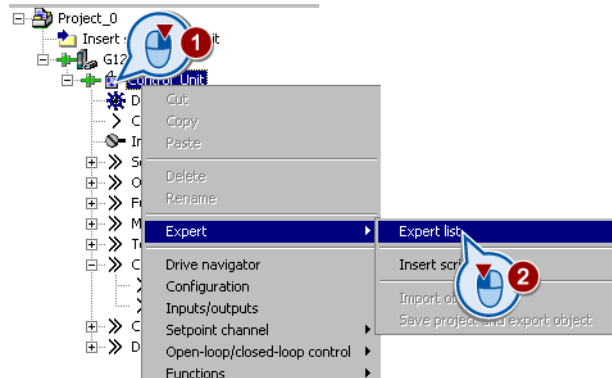

Saving settings so that they are not lost when the power fails

All of the changes that you make are temporarily saved in the inverter and are lost the next time the power supply is switched off. For your changes to be permanently saved in the inverter, you must save the changes using the  button (RAM to ROM). Before you press the button, you need to mark the appropriate drive in the project navigator.

Go offline

You can now exit the online connection after the data backup (RAM to ROM) with  "Disconnect from target system".

4.6 Back-up the settings and transfer

4.6.1 External data backup and series commissioning

After commissioning, your settings are saved in the inverter so that they are protected against power failure.

In addition, you should also save the parameters on a storage medium outside the inverter: By backing up your data on an external storage medium, if the inverter develops a defect, your settings will not be lost.

You have three different options for externally backing up data (upload):

1. Memory card
2. PC/PG with STARTER
3. Operator Panel

Series commissioning

Series commissioning means the commissioning of several identical drives in the following steps:

1. Commission the first inverter.
2. Upload the parameters of the first inverter to the storage medium outside the inverter.
3. Download the parameters from the storage medium to a second or additional inverter.



Note

The control unit to which the parameters are transferred must be of the same type and have the same or a higher firmware version as the source control unit (the same 'type' means the same MLFB).



For further information, refer to the following sections.

4.6.2 Backing up and transferring settings using STARTER

Backing up the inverter settings on PC/PG (upload)

- Go online with STARTER .
- Click on the button "Load project to PG": .
- To save data in the PG (computer), click on .

Transferring settings from the PC/PG into the inverter (download)

- Go online with STARTER.
- Click on the button "Load project to target system": .
- To save data in the converter, click on "Copy RAM to ROM" .

4.6.3 Backing up and transferring settings using BOP-2

Transferring parameters from the inverter to the operator panel (upload)

- Start data transfer in the menu "OPTIONS" - "TO BOP".
- Wait until the BOP-2 signals that data transfer has been completed.

Note

Data transfer can take several minutes.

Transferring parameters from the operator panel to the inverter (download)

- Start data transfer in the menu "OPTIONS" - "FROM BOP".
- Wait until the BOP-2 signals that data transfer has been completed.

4.6.4 Saving setting on memory card

The memory card is a removable, non-volatile flash memory for all inverter parameters.

We recommend that you use one of the memory cards with the following order numbers:

- MMC (order number 6SL3254-0AM00-0AA0)
- SD (order number 6ES7954-8LB00-0AA0)

If you wish to use other SD or MMC memory cards, then you must format the memory card as follows:

- MMC: Format FAT 16
 - Insert the card into your PC's card reader.
 - Start a "command prompt" on your PC and enter the following: format x: /fs:fat (x: Drive code of the memory card on your PC.)
- SD: Format FAT 32
 - Insert the card into your PC's card reader.
 - Start a "command prompt" on your PC and enter the following: format x: /fs:fat32 (x: Drive code of the memory card on your PC.)

Backing up your settings

We recommend that you insert the card before switching on the inverter for the first time. The inverter then automatically ensures that the actual parameter setting is saved both in the inverter as well as on the card.

The following describes how you can save the inverter parameter setting on the memory card subsequently.

Note

The data transfer can take several minutes.

If you wish to transfer the parameter setting from the inverter on to a memory card (Upload), you have two options:

Automatic upload

- Switch off the inverter power supply (or disconnect the Control Unit from the Power Module).
- Insert an empty memory card into the inverter.
- Then switch the inverter power supply back on again (or reconnect the Control Unit to the Power Module).

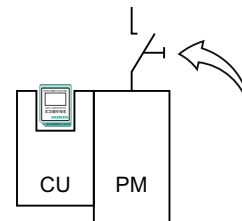

Transfer the setting to the empty memory card

Afterwards, the inverter copies its parameter setting onto the memory card.

NOTICE
If the memory card is not empty and already contains a parameter setting, the inverter will take on the parameter setting from the memory card. The previous setting in the inverter will be deleted.

Manual upload

If you do not wish to switch off the inverter power supply or you do not have an empty memory card available, you will need to transfer the parameter setting to the memory card as follows:

- Insert a memory card into the Control Unit.
The Control Unit power supply is switched-on.

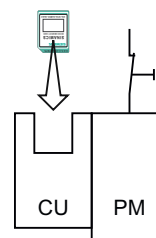

STARTER	BOP-2
<ul style="list-style-type: none"> • Start data transfer with p0971 = 1. • Check the value of parameter p0971. If data transfer has been completed, p0971 is automatically set to 0. 	<ul style="list-style-type: none"> • Start data transfer in the menu "OPTIONS" - "TO CRD". • Wait until the BOP-2 signals that data transfer has been completed.

4.6.5 Transferring the setting from the memory card

If you wish to transfer the parameter setting from a memory card into the inverter (download), you have two options:

Automatic download

- Switch off the inverter power supply (or disconnect the Control Unit from the Power Module).
- Insert the memory card into the inverter.
- Then switch the inverter power supply back on again (or insert the CU onto the Power Module).

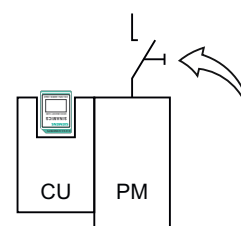

If there is valid parameter data on the memory card, then the inverter accepts this automatically.

Manual download

If you do not want to switch off the power supply, then you must transfer the parameter setting into the inverter in the following way:

- Insert the memory card into the Control Unit.
The Control Unit power supply is switched-on.

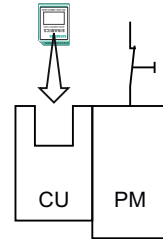

STARTER	BOP-2
<ul style="list-style-type: none"> • Set p0804 to 1. • Check the value of parameter p0804. If data transfer has been completed, p0804 is automatically set to 0. 	<ul style="list-style-type: none"> • Start data transfer in the menu "OPTIONS" - "TO CRD". • Wait until the BOP-2 signals that data transfer has been completed.

4.6.6 Safely remove the memory card

CAUTION
<p>The file system on the memory card can be destroyed if the memory card is removed without first requesting and confirming this using the "safe removal" function. The memory card will then no longer function.</p>

Procedure:

- Set p9400 to 2.
- Check the value of parameter p9400.
If it is permissible to remove the memory card, p9400 is set to 3.
- Remove the memory card.

4.6.7 Other ways to back up settings

You can backup three additional settings of the parameters in memory areas of the inverter reserved for this purpose. You will find additional information in the List Manual under the following parameters:

Parameter	Description
p0970	Resetting drive parameters Load the back-up setting (number 10, 11 or 12). You overwrite your actual parameter setting when loading.
p0971	Saving parameters Backing up the setting (10, 11 or 12).

You can back-up up to 99 additional parameter settings on the memory card. You will find additional information in the List Manual under the following parameters:

Parameter	Description
p0802	Data transfer with memory card as source/target
p0803	Data transfer with device memory as source/target
p0804	Start data transfer

4.7 Restoring the factory setting

The inverter is reset to the delivery condition by restoring the parameters to the factory setting, with the exception of the following parameters.

Note

The reset operation is not applied to parameters p0014, p0100, p0201, p0205 or the communication parameters. Motor parameters p0300 ... p0311 are suitably preassigned for the power unit.

Restoring the factory settings using STARTER

- Go online with STARTER, see Establishing an online connection between the PC and converter (going "online") (Page 80).
- In STARTER, click on the button .

Resetting to factory setting with BOP-2

- In the "Options" menu, select the "DRVRESET" entry
- Confirm the reset using the OK key.

Resetting parameters when the safety functions are active

In order to reset the safety function parameters together with all other parameters of the inverter, proceed as follows:

- Go online with STARTER.
- Open the safety functions screen and deactivate the safety functions.
- Go offline with STARTER.
- Switch off the Control Unit power supply for approximately 10 seconds (Power ON Reset).
- Go online with STARTER.
- Reset the Control Unit to the factory setting.

Configuring the terminal block

Before you configure the inputs and outputs of the inverter, you should have completed the basic commissioning, see Chapter Commissioning (Page 55) .

The assignment of the inputs and outputs in the factory setting and after the basic commissioning are listed in Chapter Wiring examples for the factory settings (Page 64).

5.1 Digital inputs

The digital inputs are pre-assigned specific functions in the factory. Depending on the Control Unit version, up to 8 digital inputs are available, of which, digital inputs DI 11 and DI 12 (terminals 3 and 10) can also be used as analog inputs.

Table 5- 1 Pre-assignment of the digital inputs

Terminal	Input	Pre-assignment after basic commissioning		Changing the pre-assignment via
		Control via terminal strip	Control via fieldbus	
5	DI 0	Switch motor on and off (ON/OFF1) (p0701 = 1)	No pre-assignment (p0701 = 0)	p0701
6	DI 1	Reverse direction of motor rotation (p0702 = 12)	No pre-assignment (p0702 = 0)	p0702
7	DI 2	Acknowledge faults (p0703 = 9)		p0703
8	DI 3	Fixed speed setpoint selection bit 0 (p0704 = 15)		p0704
16	DI 4	Fixed speed setpoint selection bit 1 (p0705 = 16) Not available with Control Units CU240B-2 and CU240B-2 DP		p0705
17	DI 5	Fixed speed setpoint selection bit 2 (p0705 = 17) Not available with Control Units CU240B-2 and CU240B-2 DP		p0706

5.1 Digital inputs

Table 5-2 Terminals, that can be used as either digital or analog input

Terminal	Terminal for ...	Parameter
3	... Analog input 0	p0712 = 0
	... Digital input 11	p0712 > 0: The reference potential is terminal 4.
10	... Analog input 1	p0713 = 0
	... Digital input 12	p0713 > 0: : The reference potential is terminal 11.

If you wish to change the function of the digital inputs, then select one of the following options.

1. Select one of the existing pre-assignments for the digital input.
2. Interconnecting the input using BICO technology.

Selecting the pre-assignment for a digital input

Table 5-3 Functions for all digital inputs

p0701 ... p0706, p0712 or p0713 = ...			
= 0	No pre-assignment	= 15	Fixed speed setpoint selection bit 0
= 1	ON/OFF1	= 16	Fixed speed setpoint selection bit 1
= 3	2. OFF2	= 17	Fixed speed setpoint selection bit 2
= 4	2. OFF3	= 18	Fixed speed setpoint selection bit 3
= 9	2. Acknowledge faults	= 25	Activate DC brake
= 10	Jog bit 0	= 27	Enable technology controller
= 11	Jog bit 1	= 29	External fault 1
= 12	Direction reversal	= 35	Command data set selection CDS bit 0
= 13	Motorized potentiometer, setpoint, raise	= 50	Load monitoring, failure detection
= 14	Motorized potentiometer, setpoint, lower	= 51 ¹⁾	Load monitoring, speed actual value

¹⁾ This setting is only available for Control Units CU240E-2 ... for DI 3

Interconnecting a digital input via BICO

- Deselect the pre-assignment (corresponding parameter value acc. to the tables above = 0)
- Interconnect the input with the corresponding binector input.

Example: If you wish to open a motor holding brake via a digital input, set p0855.0 = 722.5.

For more information, see the parameter list and in the function block diagrams 2220 ff of the List Manual. A list of all of the binector inputs is also provided in the List Manual.

5.2 Fail-safe digital input

This manual describes "Basic Safety", i.e. the STO safety function with control via a fail-safe input. Additional safety functions and additional fail-safe digital inputs of the inverter ("Extended Safety") are described in the Safety Integrated Function Manual. You will find the link to the Safety Integrated Function Manual in Section Overview of documentation (Page 13).

Assignment of the fail-safe digital input

If you activated the inverter safety functions, the inverter combines digital inputs DI4 and DI5 to form a fail-safe digital input.

Table 5- 4 Fail-safe digital input on the Control Units CU240E-2 ...

Terminal	Digital input	Fail-safe input
Terminal 16	DI 4	F-DI
Terminal 17	DI 5	

Information about wiring the F-DI is provided in Section Permitted sensors (Page 214).

5.3 Digital outputs

Up to three digital outputs are available that can be programmed to display different inverter states, e.g. faults, alarms and upper limit violations.

Table 5- 5 Pre-assignment of the digital outputs

Terminal	Digital output		Pre-assignment	Pre-assignment can be changed via
18	NC	DO 0	Inverter fault active	p0730
19	NO			
20	COM			
21	NO	DO 1	Inverter alarm active Not available with Control Units CU240B-2 and bCU240B-2 DP	p0731
22	COM			
23	NC	DO 2	Motor is switched on Not available with Control Units CU240B-2 and bCU240B-2 DP	p0732
24	NO			
25	COM			

Table 5- 6 Changing the assignment of digital outputs to common signals

p0730, p0731 or p0732 = ...			
= 0	Deactivating digital output	= 52.10	f _{actual} >= P1082 (f _{max})
= 52.0	Drive ready	= 52.11	Alarm: Motor current/torque limit
= 52.1	Drive ready for operation	= 52.12	Brake active
= 52.2	Drive running	= 52.13	Motor overload
= 52.3	Drive fault active	= 52.14	Motor CW rotation
= 52.4	OFF2 active	= 52.15	Inverter overload
= 52.5	OFF3 active	= 53.0	DC brake active
= 52.6	Switching on inhibited active	= 53.1	f _{actual} < P2167 (f _{off})
= 52.7	Drive alarm active	= 53.2	f _{actual} > P1080 (f _{min})
= 52.8	Setpoint/actual value discrepancy	= 53.3	Actual current value r0027 ≥ P2170
= 52.9	Process data control	= 53.6	f _{actual} ≥ setpoint (f _{setpoint})

If you wish to connect other inverter signals to a digital output, interconnect the corresponding binector output to the output using BICO technology. For more information, see the parameter list and the function block diagrams 2230 ff of the List Manual. A list of all of the binector outputs is also provided in the List Manual.

If you wish to invert the digital outputs, set the corresponding index of the parameter P0748 to 1:

- p0748.0 = 1, signal of digital output 0 is inverted
- p0748.1 = 1, signal of digital output 1 is inverted
- p0748.2 = 1, signal of digital output 2 is inverted

5.4 Analog inputs

Depending on the design of the Control Unit, the inverter features one or two analog inputs.

Table 5- 7 Pre-assignment of the analog inputs

Terminal	Analog input	Parameter	Factory setting
3 4	AI 0+ AI 0-	AI 0 p0756[0]	4 Bipolar voltage input -10 V ... +10 V
10 11	AI 1+ AI 1-	AI 1 p0756[1]	4 Bipolar voltage input -10 V ... +10 V Not available with Control Units CU240B-2 and CU240B-2 DP

This section shows how to set the analog input as either a voltage or current input. BICO technology can be used to set further interconnection of the analog input, e.g. as a speed setpoint or setpoint for the technology controller. For more information, see the parameter list and in the function block diagrams 9566 ff of the List Manual.

If you have selected "Control via terminals" in the basic commissioning, then analog input 0 is already interconnected with the speed setpoint.

Analog input as voltage or current input

Using parameter p0756, you define whether the analog input is used as voltage input (10 V) or as current input (20 mA). p0756[0] is valid for analog input 0 and p0756[1] for analog input 1.

The following options are available:

AI 0	Unipolar voltage input	0 V ... +10 V	p0756[0] =	0
	Unipolar voltage input monitored	+2 V ... +10 V		1
	Unipolar current input	0 mA ... +20 mA		2
	Unipolar current input monitored	+4 mA ... +20 mA		3
	Bipolar voltage input	-10 V ... +10 V		4
	No sensor connected			8
AI 1	Unipolar voltage input	0 V ... +10 V	p0756[1] =	0
	Unipolar voltage input monitored	+2 V ... +10 V		1
	Unipolar current input	0 mA ... +20 mA		2
	Unipolar current input monitored	+4 mA ... +20 mA		3
	Bipolar voltage input	-10 V ... +10 V		4
	No sensor connected			8

You must also set the DIP switch for the analog input on the Control Unit.

The DIP switch is located on the Control Unit behind the lower front doors.

- Voltage input: Switch position U (factory setting)
- Current input: Switch position I



Scaling characteristic of the analog input

When p0756 is changed, a linear scaling characteristic matching the setting is automatically set. The characteristic is determined by two points (p0757[0...1], p0758[0...1]) and (p0759[0...1], p0760[0...1]). The parameters with index 0 apply to analog input 0 and parameters with index 1 apply to analog input 1.

The scaling characteristic can be adjusted to suit your requirements.

Table 5- 8 Scaling characteristic and wire-breakage monitoring

Parameter	Description
p0757[0...1]	x-coordinate of 1st characteristic point [V or mA]
p0758[0...1]	y coordinate of the 1st characteristic point [% of p200x] p200x are the parameters of the reference variables, e.g. p2000 is the reference speed.
p0759[0...1]	x-coordinate of 2nd characteristic point [V or mA]
p0760[0...1]	y-coordinate of 2nd characteristic point [% of p200x]
p0761[0...1]	Wire breakage monitoring response threshold

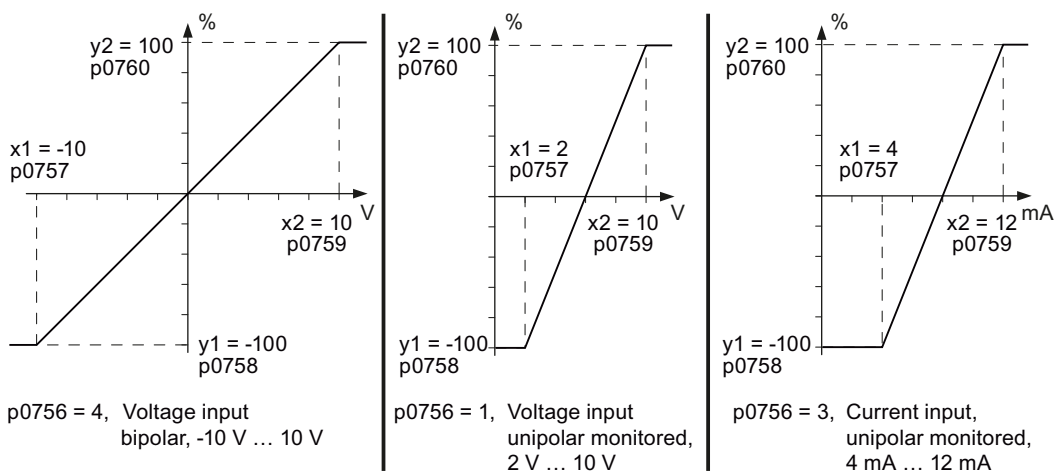
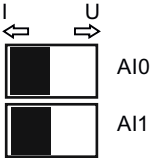

Figure 5-1 Examples for scaling characteristics

Example: Setting the analog inputs to 4 - 20 mA

Terminal No. and Significance		Parameter	Description
3	AI 0+	p0756[0] = 3	Analog input type 0 2: Unipolar current input (0 mA ...20 mA)
4	AI 0-		
10	AI 1+	p0756[1] = 3	Analog input type 1 2: Unipolar current input (0 mA ...20 mA)
11	AI 1-		
Setting DIP switch to current input ("I"): 			
When p0756 is changed to value 3, the parameters of the scaling characteristic are automatically overwritten with the following values: p0757 = 4.0, p0758 = 0.0, p0759 = 20, p0760 = 100			
		p0761[0] = 4.0 p0761[1] = 4.0	Wire breakage monitoring response threshold

5.5 Analog outputs

The Control Unit has one or two analog outputs (AO) depending on its design. You can use the analog outputs to display a wide variety of signals, e.g. the actual speed, the actual output voltage or the actual output current.

Table 5- 9 Pre-assignment of the analog outputs

Terminal	Analog output		Function	Factory setting can be changed via
12 13	AO 0+ AO 0-	AO 0	Locked	p0771[0]
26 27	AO 1+ AO 1-	AO 1	Locked Not available with Control Units CU240B-2 and CU240B-2 DP	p0771[1]

Significance of the analog output

Table 5- 10 Changing analog outputs to the most common signals

AO 0	Display via AO 0 locked	(Factory setting)	p0771[0] =	0
	Actual frequency	Scaling according to p2000		21
	Actual output frequency	Scaling according to p2000		24
	Actual output voltage	Scaling according to p2001		25
	Actual DC link voltage	Scaling according to p2001		26
	Output current	Scaling according to p2002		27
AO 1	Display via AO 1 locked	(Factory setting)	p0771[1] =	0
	Actual frequency	Scaling according to p2000		21
	Actual output frequency	Scaling according to p2000		24
	Actual output voltage	Scaling according to p2001		25
	Actual DC link voltage	Scaling according to p2001		26
	Output current	Scaling according to p2002		27

If you wish to connect other inverter signals to an analog output, interconnect the corresponding connector output to the analog output using BICO technology. For more information, see the parameter list and the function block diagrams 9572 ff of the List Manual. A list of all connector outputs is also provided in the List Manual.

Analog output as voltage or current output

Use parameter p0776 to define whether the analog output will be used as a voltage output (10 V) or a current output (20 mA).

The following options are available:

AO 0	Current output (factory setting)	0 mA ... +20 mA	p0776[0] =	0
	Voltage output	0 V ... +10 V		1
	Current output	+4 mA ... +20 mA		2
AO 1	Current output (factory setting)	0 mA ... +20 mA	p0776[1] =	0
	Voltage output	0 V ... +10 V		1
	Current output	+4 mA ... +20 mA		2

Scaling characteristic of the analog output

The scaling characteristic of an analog output is defined using 2 points.

If you change the value of p0776, the inverter automatically assigns appropriate values to the four parameters of the scaling characteristic (p0777, p0778, p0779, p0780).

Table 5- 11 Scaling characteristic

Parameter p07xx[0]: AO 0 p07xx[1]: AO 1	Description
p0777[x]	X coordinate of the 1st characteristic point [% of P200x] P200x are the parameters of the reference variables, e.g. P2000 is the reference speed.
p0778[x]	Y coordinate of the 1st characteristic point [V or mA]
p0779[x]	X coordinate of the 2nd characteristic point [% of P200x]
p0780[x]	Y coordinate of the 2nd characteristic point [V or mA]

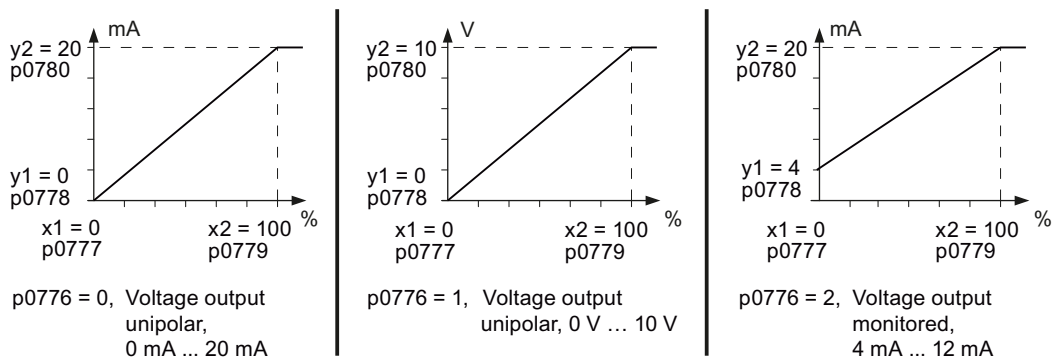

Figure 5-2 Examples for scaling characteristics

Table 5- 12 Additional analog output settings

Parameter p07xx[0]: AO 0 p07xx[1]: AO 1	Description
p0773[x]	Analog outputs smoothing time constant Smoothing time constant of 1st order low-pass filter for the analog outputs
p0775[x]	Activate absolute-value generation 0: No absolute-value generation (factory setting) 1. The absolute value of the analog output is used. If the original value was negative, the corresponding bit is set in the status word of the analog input (r0785).
p0782[x]	Analog outputs signal source for inverting Signal source to invert the analog output signals

Connection to a fieldbus

Before you connect the inverter to the field bus, you should have completed the basic commissioning, see Chapter Commissioning (Page 55)

Fieldbus interfaces of the Control Units

The Control Units are available in different versions for communication with higher-level controls with the subsequently listed fieldbus interfaces:

Fieldbus	Profile	Telegrams	Control Unit
USS	-	Configurable	CU240B-2
Modbus RTU	-	-	CU240E-2 CU240E-2 F
PROFIBUS DP	PROFIdrive	Telegram 1 Telegram 20 Telegram 350 Telegram 352 Telegram 999	CU240B-2 DP CU240E-2 DP CU240E-2 DP-F
	PROFIsafe	Telegram 30 Telegram 900	

6.1 Data exchange via the fieldbus

Analog signals

The inverter always scales signals, which are transferred via the fieldbus, to the hexadecimal value of 4000. The significance of this numerical value depends on the category of the signal that you transfer:

Signal category	4000H corresponds to a parameter value of ...
Speeds, frequencies	p2000
Voltage	p2001
Current	p2002
Torque	p2003
Power	p2004
Angle	p2005
Acceleration	p2007

Control and status words

Control and status words always comprise two bytes. Depending on the control type, the two bytes are differently interpreted as higher or lower significance. An example for transferring control and status words with a SIMATIC control is provided in Chapter STEP 7 program example for cyclic communication (Page 124).

6.2 Setting the bus address via DIP switch

You can set the bus address via DIP switch or via parameter. The DIP switches have priority over the parameter.

The inverter always uses the parameter to make the setting if all DIP switches for the bus address are at "OFF" (0) or "ON" (127) or if the address is not valid (e.g. 124 for USS).

Setting via parameter is described in the sections for the particular fieldbus interfaces.

You can find the position of the DIP switches at the inverter in Interfaces, connectors, switches, terminal blocks and LEDs of the CU (Page 51).

Table 6- 1 Examples of setting the bus addresses

DIP switch		1	2	3	4	5	6	7
Address = added values of the DIP switches that are set to ON.		1	2	4	8	16	32	64
Example 1: Address = 10 = 2 + 8	ON OFF							
Example 2: Address = 39 = 1 + 2 + 4 + 32	ON OFF							

6.3 Communication via PROFIBUS

Connect the frequency inverter to PROFIBUS

Inverters with PROFIBUS DP interface have a nine-pin SUB-D socket on the lower side of the Control Unit to integrate the inverter into a PROFIBUS network.

The SUB D connection is suitable for the SIMATIC RS485 bus connector.

Recommended PROFIBUS connectors

We recommend one of the following connectors for the PROFIBUS cable:

1. 6GK1500-0FC00
2. 6GK1500-0EA02

Both connectors are suitable for all SINAMICS G120 Control Units with respect to the angle of the outgoing cable.

Note

PROFIBUS communication when the 400 V supply for the inverter is switched off

If the inverter is only supplied via the 400 V line connection for the Power Module, the PROFIBUS connection for the Control Unit is interrupted as soon as the power supply is disconnected. To prevent this, the Control Unit must be connected to a separate 24 V power supply via terminals 31 (+24 V I_n) and 32 (0 V I_n).

Permissible cable lengths, routing and shielding the PROFIBUS cable

Information can be found in the Internet
(<http://support.automation.siemens.com/WW/view/en/1971286>).

6.3.1 Configuring communication via PROFIBUS

6.3.1.1 Task

The inverter is to be controlled from a central SIMATIC controller via PROFIBUS, whereby the control signals and speed setpoint are to be transferred from an S7-300 CPU to the drive. In the other direction, the drive is to transfer its status messages and actual speed value to the central controller via PROFIBUS.

Using a suitable example, the following section provides instructions explaining how to connect an inverter to a higher-level SIMATIC controller via PROFIBUS. To extend the PROFIBUS network to include additional inverters, simply repeat the relevant steps.

What prior knowledge is required?

In this example, it is assumed that readers know how to basically use an S7 control and the STEP 7 engineering tool and is not part of this description.

6.3.1.2 Required components

The examples given in this manual for configuring communication between the control and inverter are based on the hardware listed below:

Table 6-2 Hardware components (example)

Component	Type	Order no.	Qty
Central controller			
Power supply	PS307 2 A	6ES7307-1BA00-0AA0	1
S7 CPU	CPU 315-2DP	6ES7315-2AG10-0AB0	1
Memory card	MMC 2MB	6ES7953-8LL11-0AA0	1
DIN rail	DIN rail	6ES7390-1AE80-0AA0	1
PROFIBUS connector	PROFIBUS connector	6ES7972-0BB50-0XA0	1
PROFIBUS cable	PROFIBUS cable	6XV1830-3BH10	1
Drive			
SINAMICS G120 Control Unit	CU240E-2 DP	6SL3244-0BB12-1PA0	1
SINAMICS G120 Power Module	Any	-	1
PROFIBUS connector	PROFIBUS connector	6GK1500-0FC00	1

In order to configure communication you also require the following software packages:

Table 6-3 Software components

Component	Type (or higher)	Order no.	Qty
SIMATIC STEP 7	V5.3 + SP3	6ES7810-4CC07-0YA5	1
STARTER	V4.1 SP5	6SL3072-0AA00-0AG0	1
Drive ES Basic	V5.4	6SW1700-5JA00-4AA0	1

Drive ES Basic is the basic software of the engineering system, which combines the drive technology and Siemens controllers. The STEP 7 Manager user interface acts as a basis with which Drive ES Basic is used to integrate drives in the automation environment with respect to communication, configuration, and data storage.

6.3.1.3 Setting the PROFIBUS address

Setting the PROFIBUS address of the inverter

The inverter's PROFIBUS address is set using DIP switches on the Control Unit or using p0918. Using p0918, the address can only be set if all DIP switches for the bus address are either set to "OFF" (0) or to "ON" (127).

If the address switches are set to a value \neq 0 or 127, this address is always active and p0918 is read-only.

The setting using DIP switches is described in Setting the bus address via DIP switch (Page 104).

Valid PROFIBUS addresses: 1 ... 125
Invalid PROFIBUS addresses: 126, 127

CAUTION

A bus address that has been changed is only effective after switching-off and switching-on again. It is particularly important that any external 24 V supply is switched off.

6.3.1.4 Creating a STEP 7 project

PROFIBUS communication between the inverter and a SIMATIC control is configured using the SIMATIC STEP 7 and HW Config software tools.

Procedure

- Create a new STEP 7 project and assign a project name, e.g. "G120_in_S7". Add an S7 300 CPU.

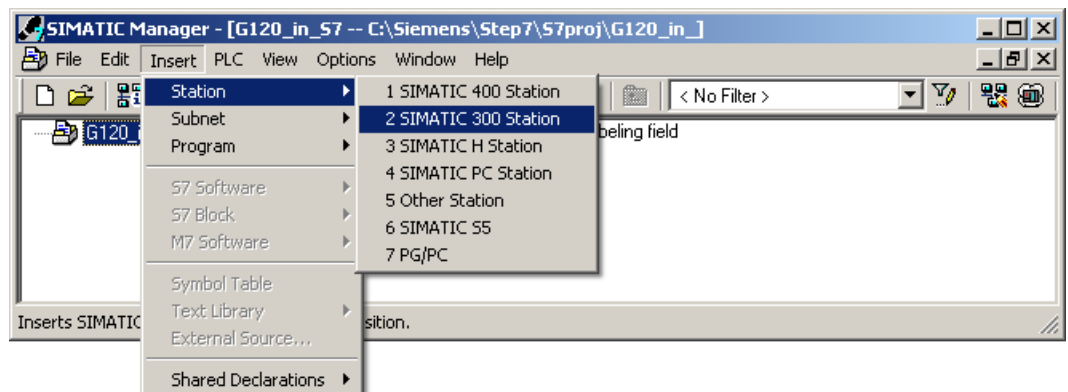

Figure 6-1 Inserting a SIMATIC 300 station into a STEP 7 project

- Select the SIMATIC 300 station in your project and open the hardware configuration (HW Config) by double clicking on "Hardware".
- Add an S7 300 mounting rail to your project by dragging and dropping it from the "SIMATIC 300" hardware catalog. Locate a power supply at slot 1 of the mounting rail and a CPU 315-2 DP at slot 2.

When you add the SIMATIC 300, a window is displayed in which you can define the network.

- Create a PROFIBUS DP network.

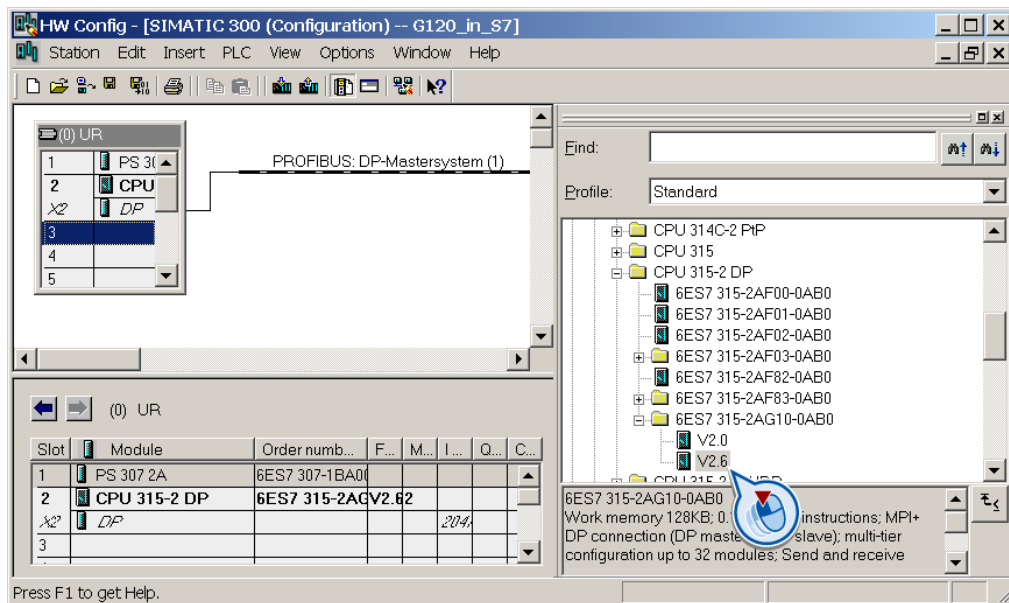

Figure 6-2 Inserting a SIMATIC 300 station with PROFIBUS DP network

6.3.1.5 Inverter GSD

In STEP 7, the inverter can be connected to an S7 control in two ways:

1. Using the inverter GSD

The GSD is a standardized description file for a PROFIBUS slave. The GSD is used by all controls, which are the PROFIBUS master.

You have two options to obtain the GSD for your inverter:

- You can find the SINAMICS inverter GSD on the Internet (<http://support.automation.siemens.com/WW/view/en/22339653/133100>).
- The GSD is saved in the inverter. The GSD is written to the memory card if you insert the memory card in the Control Unit and set p0804 to 12. Using the memory card, you can then transfer the GSD to your PG/your PC.

2. Using the STEP 7 object manager

This somewhat more user-friendly method is only available for S7 controls and installed Drive_ES_Basic.

The following section describes how to configure the inverter using the GSD.

6.3.1.6 Inserting the inverter into the STEP 7 project

- Install the GSD of the inverter in STEP 7 via HW Config (Menu "Options - Install GSD files").
Once the GSD has been installed, the inverter appears as "SINAMICS G120 CU240x-2 DP V4.3" object under "PROFIBUS DP - Additional field devices" in the hardware catalog of HW Config.

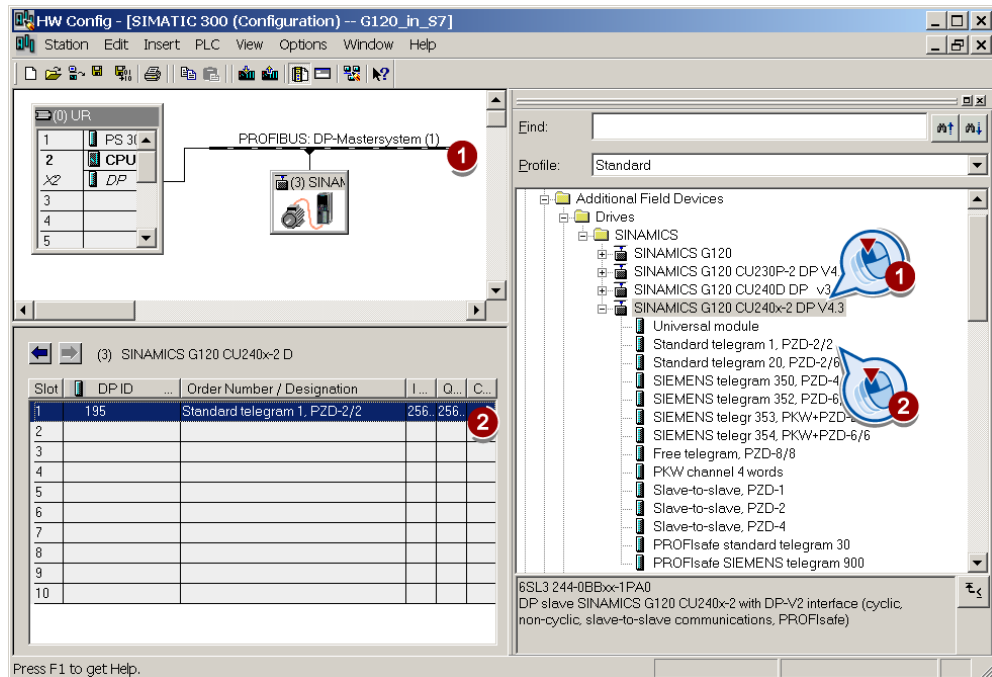

- Drag and drop the inverter into the PROFIBUS network. Enter the PROFIBUS address set at the inverter in HW Config.
- Insert the required telegram type from the HW Catalog to slot 1 of the inverter by 'dragging and dropping'.
STEP 7 automatically allocates the address range in which the inverter process data are located.

The inverter object in the HW Config product catalog contains several telegram types. The telegram type defines which data is exchanged between the control and inverter. More information on the telegram types can be found in Chapter Cyclic communication (Page 112).

Information on connecting the inverter via PROFIsafe can be found in the Safety Integrated Function Manual.

Rules for the slot sequence

Maintain the following sequence when assigning the slots:

1. PROFIsafe module (if one is used)
2. PKW channel (if one is used)
3. Standard, SIEMENS or free telegram (if one is used)
4. Slave-to-slave module

If you do not use one or several of the modules 1, 2 or 3, configure the remaining modules starting with the 1st slot.

Note regarding the universal module

It is not permissible to configure the universal module with the following properties:

- PZD length 4/4 words
- Consistent over the complete length

With these properties, the universal module has the same DP identifier (4AX) as the "PKW channel 4 words" and is therefore identified as such by the higher-level control. As a consequence, the control does not establish cyclic communication with the inverter.

Remedy: Change the length to 8/8 bytes in the properties of the DP slave. As an alternative, you can also change the consistency to "unit".

Final steps

- Save and compile the project in STEP 7.
- Establish an online connection between your PC and the S7 CPU and download the project data to the S7 CPU.
- In the inverter, select the telegram type, which you configured in STEP 7, using parameter P0922.

The inverter is now connected to the S7 CPU. This therefore defines the communication interface between the CPU and the inverter. An example of how you can supply this interface with data can be found in the section STEP 7 program examples (Page 124).

6.3.2 Communication parameters

Table 6- 4 The most important parameters

Parameter	Description	
p0700 = 6	Command source selection Selecting the fieldbus as command source	You set the command and setpoint source during the basic commissioning, see Commissioning (Page 55)
p1000 = 6	Speed setpoint selection Selecting the fieldbus as setpoint source	
p0922	PROFIdrive telegram selection (factory setting for CU with PROFIBUS interface: 1) Set the send and receive telegram, see	
	1: 20: 350: 352: 353: 354: 999:	Standard telegram 1, PZD-2/2 Standard telegram 20, PZD-2/6 SIEMENS telegram 350, PZD-4/4 SIEMENS telegram 352, PZD-6/6 SIEMENS telegram 353, PZD-2/2, BW-PKW-4/4 SIEMENS telegram 354, PZD-6/6, BW-PKW-4/4 Free telegram configuring with BICO

Using parameter p0922, you automatically interconnect the corresponding signals of the inverter to the telegram.

This BICO interconnection can only be changed, if you set p0922 to 999. In this case, select your required telegram using p2079 and then adapt the BICO interconnection of the signals.

Table 6- 5 Advanced settings

Parameter	Description
p2079	PROFIdrive PZD telegram selection extended Contrary to p0922, using p2079, a telegram can be set and subsequently extended. For p0922 < 999, the following applies: p2079 has the same value and is locked. All of the interconnections and extensions contained in the telegram are locked. For p0922 = 999, the following applies: p2079 can be freely set. If p2079 is also set to 999, then all interconnections can be set. For p0922 = 999 and p2079 < 999, the following applies: The interconnections contained in the telegram are locked. However, the telegram can be extended.

For further information, please refer to the Parameter Manual.

6.3.3 Cyclic communication

The PROFIdrive profile defines different telegram types. Telegrams contain the data for cyclic communication with a defined meaning and sequence. The inverter has the telegram types listed in the table below.

Table 6-6 Inverter telegram types

Telegram type (p0922)	Process data (PZD) - control and status words, setpoints and actual values							
	PZD01 STW1 ZSW1	PZD02 HSW HIW	PZD03	PZD04	PZD05	PZD06	PZD07	PZD08
Telegram 1 Speed control PZD 2/2	STW1	NSOLL_A	← The inverter receives this data from the control					
	ZSW1	NIST_A	⇒ The inverter sends this data to the control					
Telegram 20 Speed control, VIK/NAMUR PZD 2/6	STW1	NSOLL_A						
	ZSW1	NIST_A_ GLATT	IAIST_ GLATT	MIST_ GLATT	PIST_ GLATT	MELD_ NAMUR		
Telegram 350 Speed control PZD 4/4	STW1	NSOLL_A	M_LIM	STW3				
	ZSW1	NIST_A_ GLATT	IAIST_ GLATT	ZSW3				
Telegram 352 Speed control, PCS7 PZD 6/6	STW1	NSOLL_A	PCS7 process data					
	ZSW1	NIST_A_ GLATT	IAIST_ GLATT	MIST_ GLATT	WARN_ CODE	FAULT_ CODE		
Telegram 353 Speed control, PKW 4/4 and PZD 2/2	STW1	NSOLL_A						
	ZSW1	NIST_A_ GLATT						
Telegram 354 Speed control, PKW 4/4 and PZD 6/6	STW1	NSOLL_A	PCS7 process data					
	ZSW1	NIST_A_ GLATT	IAIST_ GLATT	MIST_ GLATT	WARN_ CODE	FAULT_ CODE		
Telegram 999 Free interconnection via BICO PZD n/m (n,m = 1 ... 8)	STW1	Telegram length on receipt can be configured up to max. 8 words						
	ZSW1	Telegram length on transmission can be configured up to max. 8 words						

Table 6-7 Explanation of the abbreviations

Abbreviation	Significance	Abbreviation	Significance
STW1/2	Control word 1/2	PIST_GLATT	Actual active power
ZSW1/2	Status word 1/2	MELD_NAMUR	Control word according to the VIK-NAMUR definition
NSOLL_A	Speed setpoint	M_LIM	Torque limit value
NIST_A_GLATT	Smoothed speed actual value	FAULT_CODE	Fault number
IAIST_GLATT	Smoothed actual current value	WARN_CODE	Alarm number
MIST_GLATT	Actual torque		

Table 6- 8 Telegram status in the inverter

Process data item	Control ⇒ inverter		Inverter ⇒ control	
	Status of the received word	Bits 0...15 in the received word	Defining the word to be sent	Status of the sent word
PZD01	r2050[0]	r2090.0 ... r2090.15	p2051[0]	r2053[0]
PZD02	r2050[1]	r2091.0 ... r2091.15	p2051[1]	r2053[1]
PZD03	r2050[2]	r2092.0 ... r2092.15	p2051[2]	r2053[2]
PZD04	r2050[3]	r2093.0 ... r2093.15	p2051[3]	r2053[3]
PZD05	r2050[4]	-	p2051[4]	r2053[4]
PZD06	r2050[5]	-	p2051[5]	r2053[5]
PZD07	r2050[6]	-	p2051[6]	r2053[6]
PZD08	r2050[7]	-	p2051[7]	r2053[7]

Select telegram

Select the communication telegram using parameters p0922 and p2079. The following dependencies apply:

- **P0922 < 999:**
For p0922 < 999, the inverter sets p2079 to the same value as p0922. With this setting, the inverter defines the length and the content of the telegram. The inverter does not permit any changes to the telegram.
- **p0922 = 999, p2079 < 999:**
For p0922 = 999, select a telegram via p2079. Also with this setting, the inverter defines the length and the content of the telegram. The inverter does not permit any changes to the telegram content. However, you can extend the telegram.
- **p0922 = p2079 = 999:**
For p0922 = p2079 = 999, enter the length and the content of the telegram. With this setting, you can define the telegram length via the central PROFIdrive configuration in the master. You define the telegram contents via the signal interconnections of the BICO technology. Using p2038, you can define the assignment of the control word according to SINAMICS or VIK/NAMUR.

You will find more details on the interconnection of command and setpoint sources, depending on the selected protocol, in the List Manual in function block diagrams 2420 to 2472.

6.3.3.1 Control and status words

Description

The control and status words fulfill the specifications of PROFIdrive profile version 4.1 for "speed control" mode.

Control word 1 (STW1)

Control word 1 (bits 0 ... 10 in accordance with PROFIdrive profile and VIK/NAMUR, bits 11 ... 15 specific to inverter).

Table 6- 9 Control word 1 and interconnection with parameters in the inverter

Bit	Value	Significance		Remarks	P No.
		Telegram 20	All other telegrams		
0	0	OFF1		Motor brakes with the ramp-down time p1121 at standstill ($f < f_{min}$) the motor is switched off.	p0840[0] = r2090.0
	1	ON		With a positive edge, the inverter goes into the "ready" state, with additionally bit 3 = 1, the inverter switches on the motor.	
1	0	OFF2		Switch off motor immediately, motor coasts to a standstill.	p0844[0] = r2090.1
	1	No OFF2		---	
2	0	Quick stop (OFF3)		Quick stop: Motor brakes with the OFF3 ramp-down time p1135 down to standstill.	p0848[0] = r2090.2
	1	No quick stop (OFF3)		---	
3	0	Disable operation		Immediately switch-off motor (cancel pulses).	p0852[0] = r2090.3
	1	Enable operation		Switch-on motor (pulses can be enabled).	
4	0	Lock ramp-function generator		The ramp-function generator output is set to 0 (quickest possible deceleration).	p1140[0] = r2090.4
	1	Operating condition		Ramp-function generator can be enabled	
5	0	Stop ramp-function generator		The output of the ramp-function generator is "frozen".	p1141[0] = r2090.5
	1	Ramp-function generator enable			
6	0	Inhibit setpoint		Motor brakes with the ramp-down time p1121.	p1142[0] = r2090.6
	1	Enable setpoint		Motor accelerates with the ramp-up time p1120 to the setpoint.	
7	1	Acknowledging faults		Fault is acknowledged with a positive edge. If the ON command is still active, the inverter switches to "closing lockout" state.	p2103[0] = r2090.7
8		Not used			
9		Not used			
10	0	PLC has no master control		Process data invalid, "sign of life" expected.	p0854[0] = r2090.10
	1	Master control by PLC		Control via fieldbus, process data valid.	
11	1	--- ¹⁾	Direction reversal	Setpoint is inverted in the inverter.	p1113[0] = r2090.11
12		Not used			
13	1	--- ¹⁾	MOP up	The setpoint stored in the motorized potentiometer is increased.	p1035[0] = r2090.13
14	1	--- ¹⁾	MOP down	The setpoint stored in the motorized potentiometer is decreased.	p1036[0] = r2090.14
15	1	CDS bit 0	Not used	Changes over between settings for different operation interfaces (command data sets).	p0810 = r2090.15

¹⁾ If you change over from another telegram to telegram 20, then the assignment of the previous telegram is kept.

Control word 3 (STW3)

Control word 3 has the following default assignment. You can change the assignment with BICO technology.

Table 6- 10 Control word 3 and interconnection with parameters in the inverter

Bit	Value	Significance		Remarks	P No.
		Telegram 350	All other telegrams		
0	1	Fixed setpoint, bit 0	Not used	Selects up to 16 different fixed setpoints.	p1020[0] = r2093.0
1	1	Fixed setpoint, bit 1	Not used		p1021[0] = r2093.1
2	1	Fixed setpoint, bit 2	Not used		p1022[0] = r2093.2
3	1	Fixed setpoint, bit 3	Not used		p1023[0] = r2093.3
4	1	DDS selection, bit 0	¹⁾	Changes over between settings for different motors (drive data sets).	p0810 = r2093.4
5	1	DDS selection, bit 1	¹⁾		p0811 = r2093.5
6	–	Not used			
7	–	Not used			
8	1	Technology controller enable	¹⁾	--	p2200[0] = r2093.8
9	1	DC braking enable	¹⁾	--	p1230[0] = r2093.9
10	–	Not used			
11	1	1 = Enable droop	¹⁾	Enable or inhibit speed controller droop.	p1492[0] = r2093.11
12	1	Torque control active	¹⁾	Changes over the control mode for vector control.	p1501[0] = r2093.12
	0	Speed control active			
14	–	Not used			
15	1	CDS bit 1	¹⁾	Changes over between settings for different operation interfaces (command data sets).	p0811[0] = r2093.15

¹⁾ If you change over from telegram 350 to another one, then the assignment of the telegram 350 is kept.

Status word 1 (ZSW1)

Status word 1 (bits 0 to 10 in accordance with PROFIdrive profile and VIK/NAMUR, bits 11 to 15 for SINAMICS G120 only).

Table 6- 11 Status word 1 and interconnection with parameters in the inverter

Bit	Value	Significance		Remarks	P No.
		Telegram 20	All other telegrams		
0	1	Ready for switching on		Power supply switched on; electronics initialized; pulses locked.	p2080[0] = r0899.0
1	1	Ready for operation		Motor is switched on (ON1 command present), no active fault, motor can start as soon as "enable operation" command is issued. See control word 1, bit 0.	p2080[1] = r0899.1
2	1	Operation enabled		Motor follows setpoint. See control word 1, bit 3.	p2080[2] = r0899.2
3	1	Fault present		The inverter has a fault.	p2080[3] = r2139.3
4	1	OFF2 inactive		Coast to standstill not activated (no OFF2)	p2080[4] = r0899.4
5	1	OFF3 inactive		No fast stop active	p2080[5] = r0899.5
6	1	Closing lockout active		The motor is only switched on after a further ON1 command	p2080[6] = r0899.6
7	1	Alarm active		Motor remains switched on; acknowledgement is not required; see r2110.	p2080[7] = r2139.7
8	1	Speed deviation within tolerance range		Setpoint/actual value deviation within tolerance range.	p2080[8] = r2197.7
9	1	Control requested		The automation system is requested to assume control.	p2080[9] = r0899.9
10	1	Comparison speed reached or exceeded		Speed is greater than or equal to the corresponding maximum speed.	p2080[10] = r2199.1
11	0	I, M or P limit reached		Comparison value for current, torque or power has been reached or exceeded.	p2080[11] = r1407.7
12	1	--- ¹⁾	Holding brake open	Signal to open and close a motor holding brake.	p2080[12] = r0899.12
13	0	Alarm motor overtemperature		--	p2080[13] = r2135.14
14	1	Motor rotates forwards		Internal inverter actual value > 0	p2080[14] = r2197.3
	0	Motor rotates backwards		Internal inverter actual value < 0	
15	1	CDS display	No alarm, thermal power unit overload		p2080[15] = r0836.0 / r2135.15

¹⁾ If you change over from another telegram to telegram 20, then the assignment of the previous telegram is kept.

Status word 3 (ZSW3)

Status word 3 has the following standard assignment. You can change the assignment with BICO technology.

Table 6- 12 Status word 3 and interconnection with parameters in the inverter

Bit	Value	Significance	Description	P No.
0	1	DC braking active	--	p2051[3] = r0053
1	1	$ n_{act} > p1226$	Absolute current speed > stationary state detection	
2	1	$ n_{act} > p1080$	Absolute actual speed > minimum speed	
3	1	$i_{act} \geq p2170$	Actual current \geq current threshold value	
4	1	$ n_{act} > p2155$	Absolute actual speed > speed threshold value 2	
5	1	$ n_{act} \leq p2155$	Absolute actual speed < speed threshold value 2	
6	1	$ n_{act} \geq r1119$	Speed setpoint reached	
7	1	DC link voltage $\leq p2172$	Actual DC link voltage \leq threshold value	
8	1	DC link voltage > p2172	Actual DC link voltage > threshold value	
9	1	Ramping completed	Ramp-function generator is not active.	
10	1	Technology controller output at lower limit	Technology controller output $\leq p2292$	
11	1	Technology controller output at upper limit	Technology controller output > p2291	
12		Not used		
13		Not used		
14		Not used		
15		Not used		

6.3.3.2 Data structure of the parameter channel

Parameter channel

You can write and read parameter values via the parameter channel, e.g. in order to monitor process data. The parameter channel always comprises four words.

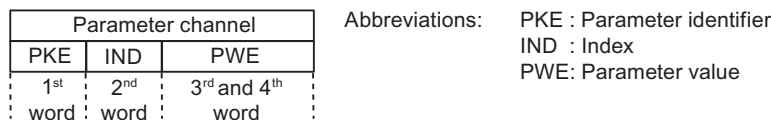

Figure 6-3 Structure of the parameter channel

Parameter identifier (PKE), 1st word

The parameter identifier (PKE) contains 16 bits.

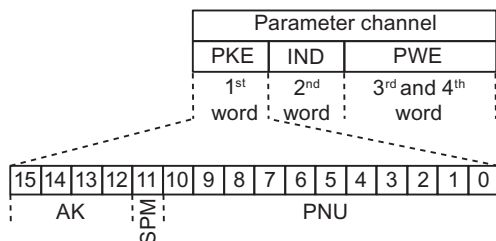

Figure 6-4 PKE - 1st word in parameter channel

- Bits 12 to 15 (AK) contain the request or response identifier.
- Bit 11 (SPM) is reserved and is always 0.
- Bits 0 to 10 (PNU) contain parameter numbers 1 ... 1999. For parameter numbers ≥ 2000 an offset must be added that is defined in the 2nd word of the parameter channel (IND).

The meaning of the request identifier for request telegrams (control → inverter) is explained in the following table.

Table 6- 13 Request identifier (control → inverter)

Request identifier	Description	Response identifier	
		positive	negative
0	No request	0	7 / 8
1	Request parameter value	1 / 2	↑
2	Change parameter value (word)	1	
3	Change parameter value (double word)	2	
4	Request descriptive element ¹⁾	3	
6	Request parameter value (field) ¹⁾	4 / 5	

Request identifier	Description	Response identifier	
		positive	negative
7	Change parameter value (field, word) ¹⁾	4	
8	Change parameter value (field, double word) ¹⁾	5	
9	Request number of field elements	6	
11	Change parameter value (field, double word) and save in EEPROM ²⁾	5	
12	Change parameter value (field, word) and save in EEPROM ²⁾	4	
13	Change parameter value (double word) and save in EEPROM	2	↓
14	Change parameter value (word) and save in EEPROM	1	7 / 8
1) The required element of the parameter description is specified in IND (second word). 2) The required element of the indexed parameter is specified in IND (second word).			

The meaning of the response identifier for response telegrams (inverter → control) is explained in the following table. The request identifier determines which response identifiers are possible.

Table 6- 14 Response identifier (inverter → control)

Response identifier	Description
0	No response
1	Transfer parameter value (word)
2	Transfer parameter value (double word)
3	Transfer descriptive element ¹⁾
4	Transfer parameter value (field, word) ²⁾
5	Transfer parameter value (field, double word) ²⁾
6	Transfer number of field elements
7	Request cannot be processed, task cannot be executed (with error number)
8	No master controller status / no authorization to change parameters of the parameter channel interface
1) The required element of the parameter description is specified in IND (second word). 2) The required element of the indexed parameter is specified in IND (second word).	

If the response identifier is 7 (request cannot be processed), one of the error numbers listed in the following table will be saved in parameter value 2 (PWE2).

Table 6- 15 Error numbers for the response "Request cannot be processed"

No.	Description	Comments
0	Impermissible parameter number (PNU)	Parameter does not exist
1	Parameter value cannot be changed	The parameter can only be read
2	Minimum/maximum not achieved or exceeded	–
3	Wrong subindex	–
4	No field	An individual parameter was addressed with a field request and subindex > 0
5	Wrong parameter type / wrong data type	Confusion of word and double word
6	Setting is not permitted (only resetting)	–
7	The descriptive element cannot be changed	Description cannot be changed
11	Not in the "master control" mode	Change request without "master control" mode (see P0927)
12	Keyword missing	–
17	Request cannot be processed on account of the operating state	The current inverter status is not compatible with the received request
20	Illegal value	Modification access with a value which is within the value limits but which is illegal for other permanent reasons (parameter with defined individual values)
101	Parameter number is currently deactivated	Dependent on the operating state of the inverter
102	Channel width is insufficient	Communication channel is too small for response
104	Illegal parameter value	The parameter can only assume certain values.
106	Request not included / task is not supported	After request ID 5, 10, 15
107	No write access with enabled controller	The operating state of the inverter prevents a parameter change
200/201	Changed minimum/maximum not achieved or exceeded	The maximum or minimum can be limited further during operation.
204	The available access authorization does not cover parameter changes.	–

Parameter index (IND)

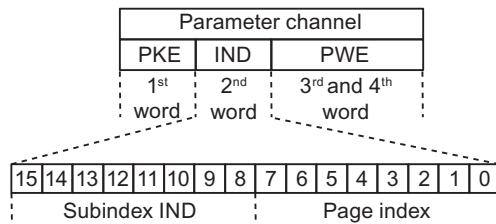

Figure 6-5 Structure of the parameter index (IND)

- For indexed parameters, select the index of the parameter by transferring the appropriate value between 0 and 254 to the subindex within a job.
- The page index is used to switch over the parameter numbers. Use this byte to add an offset to the parameter number that is transferred in the 1st word of the parameter channel (PKE).

Page index: Offset of parameter number

The parameter numbers are assigned to several parameter ranges. The following table shows which value you must transfer to the page index to achieve a particular parameter number.

Table 6- 16 Page index setting dependent on parameter range

Parameter range	Page index								Hex value
	Bit 7	Bit 6	Bit 5	Bit 4	Bit 3	Bit 2	Bit 1	Bit 0	
0000 ... 1999	0	0	0	0	0	0	0	0	0x00
2000 ... 3999	1	0	0	0	0	0	0	0	0x80
6000 ... 7999	1	0	0	1	0	0	0	0	0x90
8000 ... 9999	0	0	1	0	0	0	0	0	0x20
10000 ... 11999	1	0	1	0	0	0	0	0	0xA0
20000 ... 21999	0	1	0	1	0	0	0	0	0x50

Parameter value (PWE)

The parameter value (PWE) is transferred as a double word (32 bits). Only one parameter value may be transferred per telegram.

A 32 bit parameter value includes PWE1 (high-order word, third word) and PWE2 (low-order word, fourth word).

A 16 bit parameter value is transferred in PWE2 (low-order word, fourth word). In this case, PWE1 (high-order word, 3rd word) must be set to 0.

Example of read request for parameter P7841[2]

To obtain the value of the indexed parameter P7841, you must fill the telegram of the parameter channel with the following data:

- Request parameter value (field): Bits 15 ... 12 in the PKE word:
Request identifier = 6
- Parameter number without offset: Bits 10 ... 0 in the PKE word:
Because you can only code parameter numbers from 1 ... 1999 in the PKE, you must deduct as large an offset as possible, a number divisible by 2000, from the parameter number, and transfer the result of this calculation to the PKE word.
In our example, this means: 7841 - 6000 = 1841
- Coding the offset of the parameter number in the page index byte of the IND word:
In this example: When offset = 6000, this corresponds to a page index value of 0x90.
- Index of parameter in the subindex byte of the IND word:
In this example: Index = 2
- Because you want to read the parameter value, words 3 and 4 in the parameter channel for requesting the parameter value are irrelevant. They should be assigned a value of 0, for example.

Table 6- 17 Request to read parameter P7841[2]

PKE (1st word)		IND (2nd word)		PWE (3rd and 4th words)	
AK	PNU (10 bits)	Subindex (H byte)	Page index (L byte)	PWE1 (high-order word)	PWE2 (low-order word)
0x6	0	0x731 (decimal: 1841)	0x02	0x90	0x0000

Rules for editing requests and responses

- You can only request one parameter per transmitted telegram
- Each received telegram contains only one response
- The request must be repeated until the right response is received
- The response is assigned to a request by means of the following identifiers:
 - Suitable response identifier
 - Suitable parameter number
 - Suitable parameter index IND, if required
 - Suitable parameter value PWE, if necessary
- The complete request must be sent in a telegram. Request telegrams cannot be subdivided. The same applies to responses.

6.3.4 Acyclic communication

The contents of the transferred data set corresponds to the structure of the acyclic parameter channel according to the PROFIdrive profile, Version 4.1 (<http://www.profibus.com/>).

The acyclic data transfer mode generally allows:

- The transfer of large volumes of user data (up to 240 bytes). A parameter request/response must fit into a data set (max. 240 bytes). The requests/responses are not distributed over several data sets.
- Transfer of complete fields or field parts or the complete parameter description.
- Transfer of different parameters in one access (multiple request).
- Reading of profile-specific parameters over an acyclic channel
- Acyclic data transfer in parallel with cyclic data transfer.

Only one parameter request is processed at a time (no pipelining). No spontaneous messages are transferred.

6.3.4.1 Acyclic communication over PROFIBUS DP (DP V1)

The PROFIBUS DP expansions DPV1 comprise the definition of acyclic data exchange.

It supports concurrent access by other PROFIBUS masters (Class 2 master, e.g. commissioning tool).

Suitable channels are provided in the inverters of the SINAMICS G120 series for the different masters/different data transfer types:

- Acyclic data exchange with the same Class 1 master using the DPV1 functions READ and WRITE (with data set 47 (DS47)).
- Acyclic data exchange with the help of a SIEMENS startup tool (Class 2 master, e.g. STARTER). The startup tool can acyclically access parameters and process data in the inverter.
- Acyclic data exchange with a SIMATIC HMI (Human Machine Interface) (second Class 2 master). The SIMATIC HMI can acyclically access parameters in the inverter.
- Instead of a SIEMENS startup tool or a SIMATIC HMI, it is also possible for an external master (Class 2 master) as defined in the acyclic parameter channel according to the PROFIdrive profile, Version 4.1 (with DS47), to access the inverter.

An example of acyclic data transmission can be found in the STEP 7 program example for acyclic communication (Page 126) section.

6.3.5 STEP 7 program examples

6.3.5.1 STEP 7 program example for cyclic communication

S7 program for controlling the inverter

In the following example, the control and inverter communicate via standard telegram 1. The control specifies control word 1 (STW1) and the speed setpoint, while the inverter responds with status word 1 (ZSW1) and its actual speed.

Network 1: Create control word 1 and speed setpoint

```
STW1: 0x47E  
Freq: 0x2500
```

```
L    W#16#47E  
T    MW    1  
L    W#16#2500  
T    MW    3
```

Network 2: Acknowledge fault

```
Comment:
```

```
U    E    0.6  
=    M    2.7
```

Network 3: Start and stop

```
Comment:
```

```
U    E    0.0  
=    M    2.0
```

Network 4: Write process data

```
Comment:
```

```
L    MW    1  
T    PAW  256  
L    MW    3  
T    PAW  258
```

Figure 6-6 Controlling the inverter via PROFIBUS

Network 5 : Read process data

Comment:

```

L    PEW  256
T    MW   5
L    PEW  258
T    MW   7
    
```

Figure 6-7 Status evaluation of the inverter via PROFIBUS

Information about the S7 program

The hexadecimal numeric value 047E is written to control word 1. The bits of control word 1 are listed in the following table.

Table 6- 18 Assignment of the control bits in the inverter to the SIMATIC flags and inputs

HEX	BIN	Bit in STW1	Significance	Bit in MW1	Bit in MB1	Bit in MB2	Inputs
E	0	0	ON/OFF1	8		0	E0.0
	1	1	ON/OFF2	9		1	
	1	2	ON/OFF3	10		2	
	1	3	Operation enable	11		3	
7	1	4	Ramp-function generator enable	12		4	
	1	5	Start ramp-function generator	13		5	
	1	6	Setpoint enable	14		6	
	0	7	Acknowledge fault	15		7	E0.6
4	0	8	Jog 1	0		0	
	0	9	Jog 2	1		1	
	1	10	PLC control	2		2	
	0	11	Setpoint inversion	3		3	
0	0	12	Irrelevant	4		4	
	0	13	Motorized potentiometer ↑	5		5	
	0	14	Motorized potentiometer ↓	6		6	
	0	15	Data set changeover	7	7		

In this example, inputs E0.0 and E0.6 are linked to the -bit ON/OFF1 or to the "acknowledge fault" bit of STW 1.

The hexadecimal numeric value 2500 specifies the setpoint frequency of the inverter. The maximum frequency is the hexadecimal value 4000 (also see Data exchange via the fieldbus (Page 103)).

The control cyclically writes the process data to logical address 256 of the inverter. The inverter also writes its process data to logical address 256. You define the address area in HW Config, see inserting the inverter into the STEP 7 project (Page 109).

6.3.5.2 STEP 7 program example for acyclic communication

Simple S7 program for parameterizing the inverter

The number of simultaneous requests for acyclic communication is limited. More detailed information can be found in the Internet (<http://support.automation.siemens.com/WW/view/en/15364459>).

OB1 : "Main Program Sweep (Cycle)"

Kommentar:

Netzwerk 1 : Define Read or write

Kommentar:

```
// Read parameter
O(
  U      M      9.2
  UN     M      9.1
)
O(
  U      M      9.0
  UN     M      9.1
)
R      M      9.3

SPB   RD

// write parameter
O(
  U      M      9.3
  UN     M      9.0
)
O(
  U      M      9.1
  UN     M      9.0
)
R      M      9.2

SPB   WR
BEA

RD:   NOP   0
      CALL FC   1
      BEA
WR:   NOP   0
      CALL FC   3
```

- M9.0 Starts reading parameters
- M9.1 Starts writing parameters
- M9.2 displays the read process
- M9.3 displays the write process

Figure 6-8 STEP 7 program example for acyclic communication - OB1

FC1 to read parameters from the inverter

Inverter parameters are read via SFC 58 and SFC 59.

FC1 : PAR_RD

Kommentar:

Netzwerk 1 : Parameters for reading

Kommentar:

```

      L   MB   62
      T   DB1.DBB  3
//-----
      L   MW   50
      T   DB1.DBW  6
      L   MB   58
      T   DB1.DBB  5
      L   MW   63
      T   DB1.DBW  8
//-----
      L   MW   52
      T   DB1.DBW 12
      L   MB   59
      T   DB1.DBB 11
      L   MW   65
      T   DB1.DBW 14
//-----
      L   MW   54
      T   DB1.DBW 18
      L   MB   60
      T   DB1.DBB 17
      L   MW   67
      T   DB1.DBW 20
//-----
      L   MW   56
      T   DB1.DBW 24
      L   MB   61
      T   DB1.DBB 23
      L   MW   69
      T   DB1.DBW 26
```

Netzwerk 2 : Read request

Kommentar:

```

CALL SFC 58
REQ :=M9.0
IOID :=B#16#54
LADDR :=W#16#170
RECNUM :=B#16#2F
RECORD :=P#DB1.DBX0.0 BYTE 28
RET_VAL:=MW10
BUSY :=M8.1

U M 8.1
R M 9.0
S M 9.2
    
```

Netzwerk 3 : Read delay after sending the read request

Kommentar:

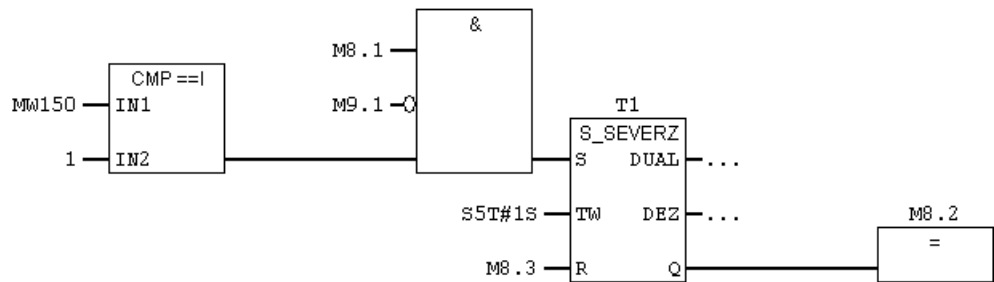

Netzwerk 4 : Read request

Kommentar:

```

CALL SFC 59
REQ :=M8.2
IOID :=B#16#54
LADDR :=W#16#170
RECNUM :=B#16#2F
RET_VAL:=MW12
BUSY :=M8.3
RECORD :=P#DB2.DBX0.0 BYTE 36

U M 8.3
R M 8.2
    
```

Figure 6-9 Function block for reading parameters

You first have to define how many parameters (MB62), which parameter numbers (MW50, MW52, etc.), and how many parameter indices (MB58, MB59, etc.) are read for each parameter number. The specifications are saved in DB1.

SFC 58 copies the specifications for the parameters to be read from DB1 and sends them to the inverter as a read request. No other read requests are permitted while this one is being processed.

Once the read request has been issued and a waiting time of one second has elapsed, the parameter values are copied from the inverter via SFC 59 and saved in DB2.

FC3 to write parameters to the inverter

FC3 : PAR_WR

Kommentar:

Netzwerk 1 : Parameter for writing

Kommentar:

```
L    MW    21
T    DB3.DBW  6
L    MW    23
T    DB3.DBW  8
L    MW    35
T    DB3.DBW 12
```

Netzwerk 2 : Write request

Kommentar:

```
CALL SFC 58
REQ  :=M9.1
IOID :=B#16#54
LADDR :=W#16#170
RECNUM :=B#16#2F
RECORD :=P#DB3.DBX0.0 BYTE 14
RET_VAL:=MW10
BUSY  :=M8.1

U    M    8.1
R    M    9.1
S    M    9.3
```

Figure 6-10 Function block for writing parameters

You first have to define which value (MW35) is written to which parameter index (MW23) of which parameter (MW21). The specifications are saved in DB3.

SFC 58 copies the specifications for the parameters to be written from DB3 and sends them to the inverter. No other write requests are permitted while this one is being processed.

For more information about SFC 58 and SFC 59, consult the STEP 7 online help.

6.4 Communication via RS485

6.4.1 Integrating inverters into a bus system via the RS485 interface

Connecting to a network via RS485

The Control Unit has a two-section terminal strip on its lower side which allows the inverter to be integrated into a bus system via the RS485 interface. This connector has short-circuit proof, isolated pins. You will find the terminal assignments in the following table.

Table 6- 19 Assignments for the terminal strip of the RS485 interface

Contact	Designation	Description	
1	0 V	Reference potential	
2	RS485P	Receive and send signal (+)	
3	RS485N	Receive and send signal (-)	
4	Shield	Cable shield	
5	---	---	

General specifications and requirements for error-free communication

NOTICE

When the bus is operating, the first and last bus station must be continuously connected to the supply.

Note

Communication with the controller, even when the supply voltage on the Power Module is switched off

You will have to supply the Control Unit with 24 V DC on terminals 31 and 32 if you require communication to take place with the controller when the line voltage is switched off.

You must switch-in the bus terminating resistor for the first and last participants. The bus terminating resistor is either located on the lower side next to the RS485 connector or on the front side of the Control Unit behind the front door, see Chapter Interfaces, connectors, switches, terminal blocks and LEDs of the CU (Page 51).

You can disconnect one or more slaves from the bus (by unplugging the bus connector) without interrupting the communication for the other stations, but not the first or last.

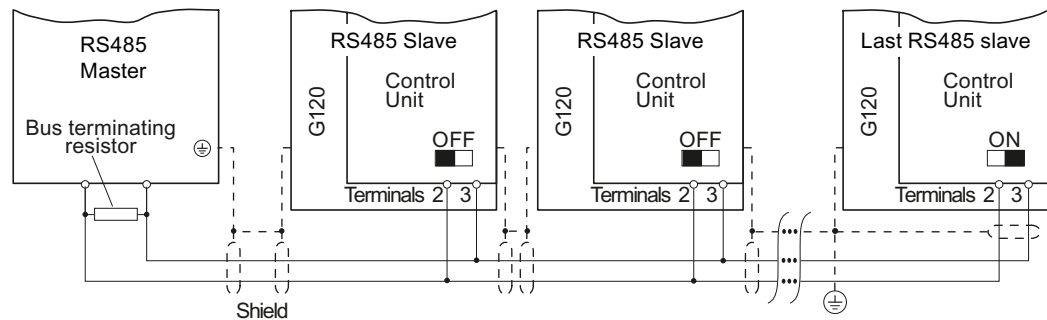

Figure 6-11 Communication network via RS485

6.4.2 Communication via USS

6.4.2.1 General information about communication with USS via RS485

Using the USS protocol (protocol of the universal serial interface), users can set up a serial data connection between a higher-level master system and several slave systems (RS 485 interface). Master systems include programmable logic controllers (e.g. SIMATIC S7-200) or PCs. The inverters are always slaves on the bus system.

Communication using the USS protocol takes place over the RS485 interface with a maximum of 31 slaves.

The maximum cable length is 1200 m (3300 ft)

Information about how to connect the inverter to the USS fieldbus is provided in Section: Integrating inverters into a bus system via the RS485 interface (Page 130).

Setting the bus address of the inverter

The inverter's USS address can be set via DIP switches on the Control Unit or using p2021. Using p2021, the address can only be set if all DIP switches for the bus address are either set to "OFF" (0) or to "ON" (127).

If the address switches are set to a value = 1 ... 30, then this address is always active and p2021 is read-only.

Valid USS address area: 1 ... 30

The setting using DIP switches is described in Setting the bus address via DIP switch (Page 104).

CAUTION

A bus address that has been changed is only effective after switching-off and switching-on again. It is particularly important that any external 24 V supply is switched off.

Additional communication settings

Parameter	Description	
p0700 = 6	Command source selection Selecting the fieldbus as command source	
p1000 = 6	Speed setpoint selection Selecting the fieldbus as setpoint source	
p2020	Value	Baud rate
	4	2400
	5	4800
	6	9600
	7	19200
	8	38400
	9	57600
	10	76800
	11	93750
	12	115200
	13	187500
p2022	Fieldbus interface, USS PZD count Setting the number of 16-bit words in the PZD part of the USS telegram	
p2023	Fieldbus interface, USS PKW count Setting the number of 16-bit words in the PKW part of the USS telegram:	
	Value	PKW count
	0	PKW 0 words
	3	PKW 3 words
	4	PKW 4 words
	127	PKW variable
p2030 = 1	Fieldbus interface protocol selection 1: USS	
p2040	Fieldbus interface, monitoring time [ms] Setting the monitoring time to monitor the received process data via fieldbus. If no process data are received within this time, an appropriate message is output	

Additional information and parameters are provided on the following pages.

6.4.2.2 Structure of a USS telegram

A USS telegram comprises a sequence of characters, which are sent in a defined sequence. The sequence of characters of a USS telegram is shown in the following diagram.

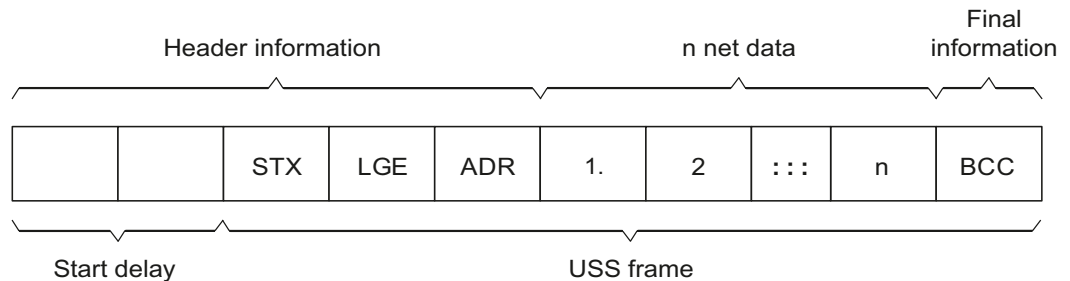
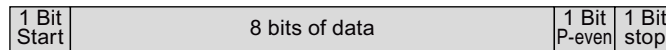

Figure 6-12 Structure of a USS telegram

Every character within the telegram comprises 11 bits.



Description

Telegrams with both a variable and fixed length can be used. This can be selected using parameters p2022 and p2023 to define the length of the PZD and the PKW within the net data.

STX	1 byte	
LGE	1 byte	
ADR	1 byte	
Net data	PKW	8 bytes (4 words: PKE + IND + PWE1 + PWE2)
(example)	PZD	4 bytes (2 words: PZD1 + PZD2)
BCC	1 byte	

Start delay

The start delay must be maintained before a new master telegram is started.

STX

The STX block is an ASCII character (0x02) and indicates the beginning of a message.

LGE

LGE specifies the number of bytes that following in the telegram. It is defined as the sum of the following bytes

- Net data
- ADR
- BCC

The actual overall telegram length is two bytes longer because STX and LGE are not counted in LGE.

ADR

The ADR range contains the address of the slave node (e.g. of the inverter). The individual bits in the address byte are addressed as follows:

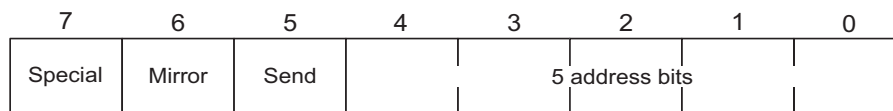

- Bit 5 is the broadcast bit.

Note

The Broadcast function is not supported in the current software version.

- Bit 6 = 1 indicates a mirror telegram.
The node address is evaluated and the addressed slave returns the telegram to the master unchanged.

Bit 5 = 0, bit 6 = 0 and bit 7 = 0 indicate normal data communication for devices. The node address (bit 0 to bit 4) is evaluated.

BCC

BCC (Block Check Character). It is an exclusive OR checksum (XOR) over all telegram bytes with the exception of the BCC itself.

6.4.2.3 User data range of the USS telegram

The user data range of the USS protocol is used to transmit application data. This comprises the parameter channel data and the process data (PZD).

The user data occupy the bytes within the USS frame (STX, LGE, ADR, BCC). The size of the user data can be configured using parameters p2023 and p2022. The structure and sequence of the parameter channel and process data (PZD) are shown in the figure below.

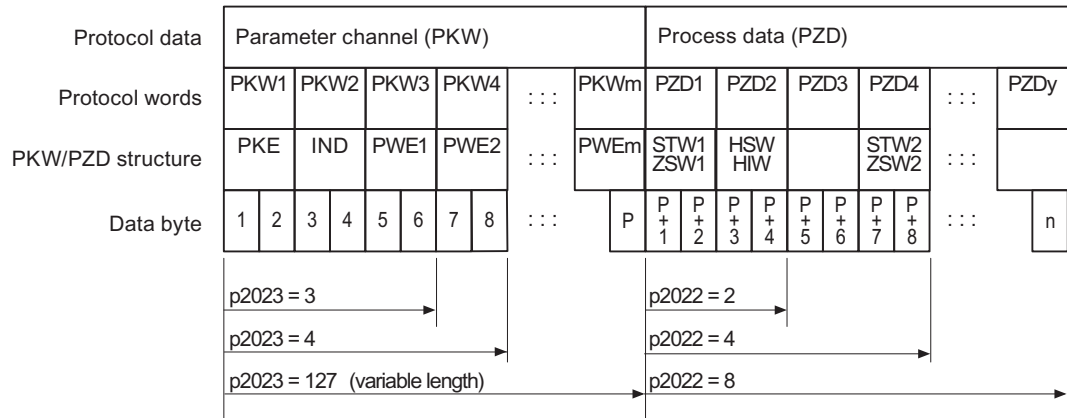

Figure 6-13 USS user data structure

The length for the parameter channel is determined by parameter p2023 and the length for the process data is specified by parameter p2022. If the parameter channel or the PZD is not required, the appropriate parameters can be set to zero ("PKW only" or "PZD only").

It is not possible to transfer "PKW only" and "PZD only" alternatively. If both channels are required, they must be transferred together.

6.4.2.4 Data structure of the USS parameter channel

The USS protocol defines for inverters the user data structure via which a master accesses the slave inverter. The parameter channel is used to read and write parameters in the inverter.

Parameter channel

You can use the parameter channel with a fixed length of 3 or 4 data words or with a variable length.

The first data word always contains the parameter identifier (PKE) and the second contains the parameter index.

The third, fourth and subsequent data words contain parameter values, texts and descriptions.

Parameter identifier (PKE), 1st word

The parameter identifier (PKE) is always a 16-bit value.

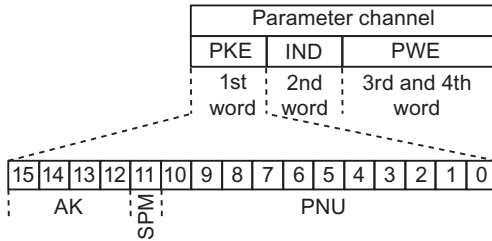

Figure 6-14 PKE structure

- Bits 12 to 15 (AK) contain the request or response identifier.
- Bit 11 (SPM) is reserved and always = 0.
- Bits 0 to 10 (PNU) contain parameter numbers 1 ... 1999. For parameter numbers ≥ 2000 , you must add an offset in the 2nd word of the parameter channel (IND).

The following table includes the request ID for telegrams between the master → inverter.

Table 6-20 Request identifier (master → inverter)

Request identifier	Description	Response identifier	
		Positive	Negative
0	No request	0	7
1	Request parameter value	1 / 2	7
2	Change parameter value (word)	1	7
3	Change parameter value (double word)	2	7
4	Request descriptive element ¹⁾	3	7
6	Request parameter value ^{1) 2)}	4 / 5	7
7	Change parameter value (word) ^{1) 2)}	4	7
8	Change parameter value (double word) ^{1) 2)}	5	7

1) The required element of the parameter description is specified in IND (second word).
 2) Identifier 1 is identical to identifier 6, ID 2 is identical to 7, and 3 is identical to 8. We recommend that you use identifiers 6, 7, and 8.

The following table includes the response ID for telegrams between the inverter → master. The response ID depends on the request ID.

Table 6- 21 Response identifier (inverter → master)

Response identifier	Description
0	No response
1	Transfer parameter value (word)
2	Transfer parameter value (double word)
3	Transfer descriptive element ¹⁾
4	Transfer parameter value (field, word) ²⁾
5	Transfer parameter value (field, double word) ²⁾
6	Transfer number of field elements
7	Request cannot be processed, task cannot be executed (with error number)
1) The required element of the parameter description is specified in IND (second word).	
2) The required element of the indexed parameter is specified in IND (second word).	

If the response ID = 7, then the inverter sends one of the error numbers listed in the following table in parameter value 2 (PWE2).

Table 6- 22 Error numbers for the response "Request cannot be processed"

No.	Description	Comments
0	Impermissible parameter number (PNU)	Parameter does not exist
1	Parameter value cannot be changed	The parameter can only be read
2	Minimum/maximum not achieved or exceeded	–
3	Wrong subindex	–
4	No field	An individual parameter was addressed with a field request and subindex > 0
5	Wrong parameter type / wrong data type	Confusion of word and double word
6	Setting is not permitted (only resetting)	Index is outside the parameter field[]
7	The descriptive element cannot be changed	Description cannot be changed
11	Not in the "master control" mode	Change request without "master control" mode (see p0927)
12	Keyword missing	–
17	Request cannot be processed on account of the operating state	The actual inverter operating state is not compatible with the received request
20	Illegal value	Modification access with a value which is within the value limits but which is illegal for other permanent reasons (parameter with defined individual values)
101	Parameter number is currently deactivated	Dependent on the operating state of the inverter
102	Channel width is insufficient	Communication channel is too small for response
104	Illegal parameter value	The parameter can only assume certain values.

No.	Description	Comments
106	Request not included / task is not supported	After request identifier 5,11,12,13,14,15
107	No write access with enabled controller	The operating state of the inverter prevents a parameter change
200/201	Changed minimum/maximum not achieved or exceeded	The maximum or minimum can be limited further during operation.
204	The available access authorization does not cover parameter changes.	-

Parameter index (IND)

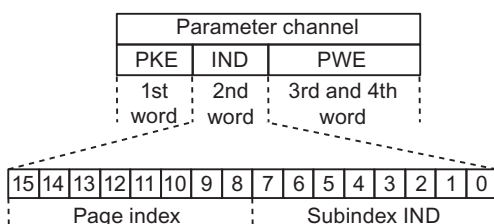

Figure 6-15 Structure of the parameter index (IND)

- For indexed parameters, select the index of the parameter by transferring the appropriate value between 0 and 254 to the subindex within a job.
- The page index is used to switch over the parameter numbers. Use this byte to add an offset to the parameter number that is transferred in the 1st word of the parameter channel (PKE).

Page index: Offset of parameter number

The parameter numbers are assigned to several parameter ranges. The following table shows which value you must transfer to the page index to achieve a particular parameter number.

Table 6-23 Page index setting dependent on parameter range

Parameter range	Page index								Hex value
	Bit 15	Bit 14	Bit 13	Bit 12	Bit 11	Bit 10	Bit 9	Bit 8	
0000 ... 1999	0	0	0	0	0	0	0	0	0x00
2000 ... 3999	1	0	0	0	0	0	0	0	0x80
6000 ... 7999	1	0	0	1	0	0	0	0	0x90
8000 ... 9999	0	0	1	0	0	0	0	0	0x20
10000 ... 11999	1	0	1	0	0	0	0	0	0xA0
20000 ... 21999	0	1	0	1	0	0	0	0	0x50

Parameter value (PWE)

You can vary the number of PWEs using parameter p2023.

Parameter channel with fixed length	Parameter channel with variable length
<p>P2023 = 4</p> <p>A parameter channel with fixed length should contain 4 words as this setting is sufficient for all parameters (including double words).</p>	<p>P2023 = 127</p> <p>For a variable length of parameter channel, the master will only send the number of PWEs necessary for the task in the parameter channel. The response telegram is also no longer than necessary.</p>
<p>P2023 = 3</p> <p>You can select this setting if you only want to read or write 16-bit data or alarm signals.</p> <ul style="list-style-type: none"> • 16-bit data: e.g. p0210 supply voltage • 32-bit data: Indexed parameter, e.g. p0700[0...n] Bit parameter, e.g. 722.0...12) 	
<p>The master must always transmit the permanently set number of words in the parameter channel. Otherwise the slave will not respond to the telegram.</p> <p>When the slave responds it must always respond with the defined number of words.</p>	

Note

8-bit values are transmitted as 16-bit values; the higher-order byte is zero. The fields of 8-bit values require one PWE per index.

Rules for editing requests/responses

- You can only request one parameter for each telegram sent.
- Each received telegram contains only one response.
- The master must repeat a request until it receives a suitable response.
- Request and response are assigned to one another using the following identifiers:
 - Suitable response identifier
 - Suitable parameter number
 - Suitable parameter index IND, if required
 - Suitable parameter value PWE, if necessary
- The master must send the complete request in one telegram. Request telegrams cannot be split up. The same applies to responses.

6.4.2.5 USS read request

Example: Reading out alarm messages from the inverter.

The parameter channel comprises four words (p2023 = 4). In order to obtain the values of the indexed parameter r2122, you must fill the telegram of the parameter channel with the following data:

- Request parameter value (field): Bits 15 ... 12 in the PKE word:
Request identifier = 6
- Parameter number without offset: Bits 10 ... 0 in the PKE word:
Because you can only code parameter numbers from 1 ... 1999 in the PKE, you must deduct as large an offset as possible, a number divisible by 2000, from the parameter number, and transfer the result of this calculation to the PKE word.
In our example, this means: 2122 - 2000 = 122 = 7AH
- Offset of the parameter number in the byte page index of the word IND:
for this example: When offset = 2000, this corresponds to a page index value of 0x80
- Index of the parameter in the byte subindex of the word IND:
If you wish to read-out the last alarm, then you must enter index 0, for the third from last, index 2 (example). You can find a detailed description on the history of the alarm messages in the Section Alarms (Page 246) .
- Because you want to read the parameter value, words 3 and 4 in the parameter channel for requesting the parameter value are irrelevant. They should be assigned a value of 0, for example.

Table 6- 24 Request to read parameter r2122[2]

PKE (1st word)		IND (2nd word)			PWE (3rd and 4th words)		
AK		PNU:	Page index (H byte)	Subindex (L byte)	PWE1(H word)	PWE2(L word)	
15 ... 12	11	10 ... 0	15 ... 8	7 ... 0	15 ... 0	Drive Object	15 ... 10
0x6	0	0x7A (dec: 122)	0x80	0x02	0x0000	0x0000	0x0000

6.4.2.6 USS write job

Example: Define digital input 2 as source for ON/OFF in CDS1

In this case, parameter p0840[1] (source, ON/OFF) must be assigned the value 722.2 (digital input 2).

The parameter channel comprises four words (p2023 = 4). To change the value of the indexed parameter P0840, you must fill the telegram of the parameter channel with the following data:

- Change parameter value (field): Enter bit 15 ... 12 in PKE (1st word):
Request identifier = 7
- Parameter number without offset: Enter bit 10 ... 0 in PKE (1st word):
As the parameter is < 1999, it can be directly entered without an offset - converted into hex - in the example 840 = 348H.

- Enter the offset of the parameter number in byte page index of word IND (2nd word):
in this example = 0.
- Enter the index of parameter in the byte subindex of word IND (2nd word):
for this example = 1 (CDS1)
- Enter a new parameter value in PWE1 (Word3):
in the example 722 = 2D2H.
- Drive Object: Enter bit 10 ... 15 in PWE2 (4th word):
for SINAMICS G120, always 63 = 3FH
- Index of the parameter: Enter bit 0 ... 9 in PWE2 (word4):
in example 2.

Table 6- 25 Request to change p0840[1]

PKE (1st word)		IND (2nd word)			PWE (3rd and 4th words)		
AK		PNU:	Page index (H byte)	Subindex (L byte)	PWE1(H word)	PWE2(L word)	
15 ... 12	11	10 ... 0	15 ... 8	7 ... 0	15 ... 0	Drive Object	9 ... 0
0x7	0	0x348 (dec: 840)	0x0000	0x01	0x2D2 (dec: 722)	3F (fixed) (dec: 66)	0x0002

6.4.2.7 USS process data channel (PZD)

Description

Process data (PZD) is exchanged between the master and slave in this telegram range. Depending on the direction of transfer, the process data channel contains request data for the slave or response data to the master. The request contains control words and setpoints for the slaves, while the response contains status words and actual values for the master.

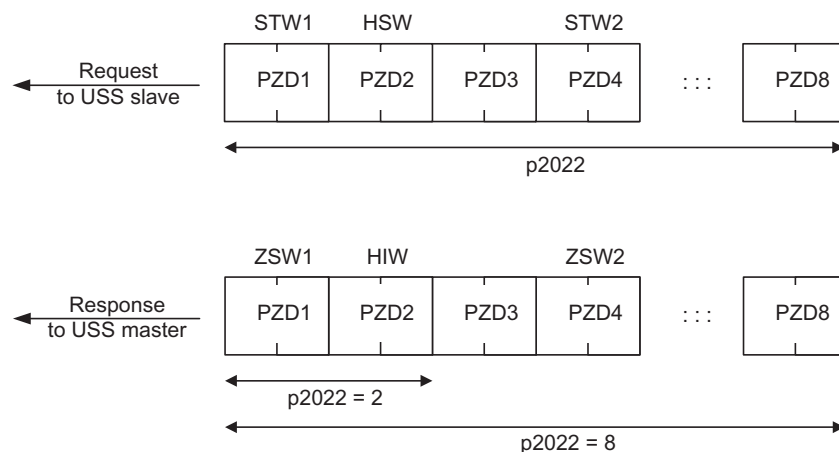

Figure 6-16 Process data channel

The number of PZD words in a USS telegram is defined by parameter p2022. The first two words are:

- Control 1 (STW1, r0054) and main setpoint (HSW)
- Status word 1 (ZSW1, r0052) and main actual value (HIW)

If P2022 is greater than or the same as 4, the additional control word (STW2, r0055) is transferred as the fourth PZD word (default setting).

You define the sources of the PZD using parameter p2051.

For further information, please refer to the Parameter Manual.

6.4.2.8 Telegram monitoring

You require the telegram runtimes in order to set the telegram monitoring. The character runtime is the basis of the telegram runtime:

Table 6- 26 Character runtime

Baud rate in bit/s	Transmission time per bit	Character run time (= 11 bits)
9600	104.170 μ s	1.146 ms
19200	52.084 μ s	0.573 ms
38400	26.042 μ s	0.286 ms
115200	5.340 μ s	0.059 ms

The telegram runtime is longer than just purely adding all of the character runtimes (=residual runtime). The character delay time between the individual characters of the telegram also has to be taken into account.

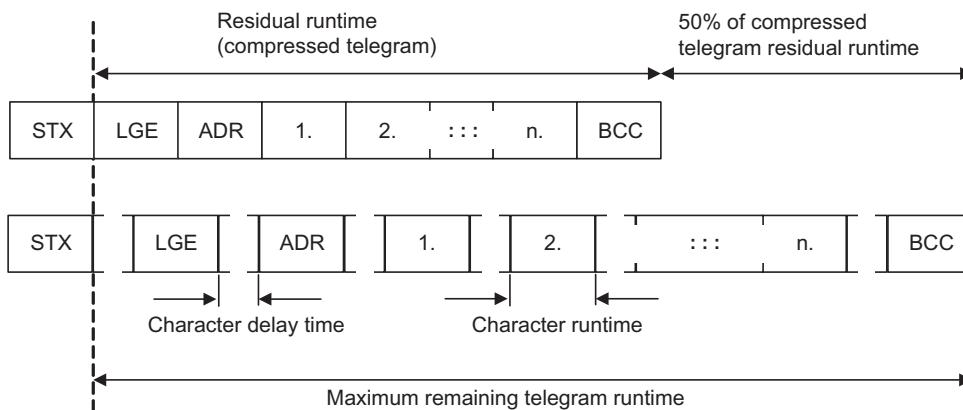

Figure 6-17 Telegram runtime as the sum of the residual runtime and character delay times

The total telegram runtime is always less than 150% of the pure residual runtime.

Before each request telegram, the master must maintain the start delay. The start delay must be $> 2 * \text{character runtime}$.

The slave only responds after the response delay has expired.

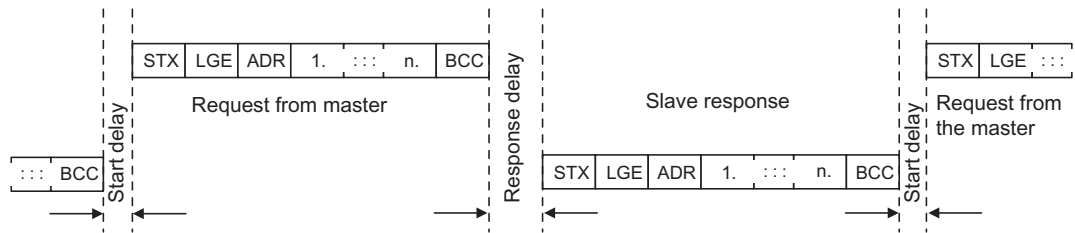

Figure 6-18 Start delay and response delay

The duration of the start delay must at least be as long as the time for two characters and depends on the baud rate.

Table 6- 27 Duration of the start delay

Baud rate in bit/s	Transmission time per character (= 11 bits)	Min. start delay
9600	1.146 ms	> 2.291 ms
19200	0.573 ms	> 1.146 ms
38400	0.286 ms	> 0.573 ms
57600	0.191 ms	> 0.382 ms
115200	0.059 ms	> 0.117 ms

Note: The character delay time must be shorter than the start delay.

Telegram monitoring of the master

The USS master must monitor the following times:

- Response delay: Response time of the slave to a request from the master
The response delay must be < 20 ms, but longer than the start delay
- Telegram runtime: Transmission time of the response telegram sent from the slave

Telegram monitoring of the inverter

The inverter monitors the time between two requests of the master. Parameter p2040 defines the permissible time in ms. If this time is exceeded, it is interpreted as a telegram failure and results in fault message F01910.

150% of the residual runtime is the guide value for the setting of p2040, i.e. the telegram runtime without taking into account the character delay times.

There is no monitoring for p2040 = 0.

If the USS is configured as a command source for the drive and p2040 is not zero, bit 10 of the received control word 1 is checked. If the bit is not set, then fault message F07220 is immediately output.

6.4.3 Communication over Modbus RTU

Overview of communication using Modbus

The Modbus protocol is a communication protocol with linear topology based on a master/slave architecture.

Modbus offers three transmission modes:

- **Modbus ASCII**
Data is transferred in ASCII code. The data can therefore be read directly by humans, however, the data throughput is lower in comparison to RTU.
- **Modbus RTU**
Modbus RTU (RTU: Remote Terminal Unit): Data is transferred in binary format and the data throughput is greater than in ASCII code.
- **Modbus TCP**
This type of data transmission is very similar to RTU, except that TCP/IP packages are used to send the data. TCP port 502 is reserved for Modbus TCP. Modbus TCP is currently undergoing definition as a standard (IEC PAS 62030 (pre-standard)).

The Control Unit supports Modbus RTU as a slave with even parity.

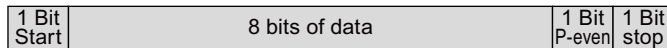

Communication settings

- Communication using Modbus RTU takes place over the RS485 interface with a maximum of 247 slaves.
- The maximum cable length is 1200 m (3281 ft).
- Two 100 kΩ resistors are provided to polarize the receive and send cables.

6.4.3.1 Parameters for Modbus communication settings

Setting the bus address of the inverter

The Modbus address of the inverter can be set using DIP switches on the Control Unit or using p2021. Using p2021, the address can only be set if all DIP switches for the bus address are either set to "OFF" (0) or to "ON" (127).

If the address switches are set to a value = 1 ... 127, then this address is always active and p2021 is read-only.

Valid Modbus addressing range: 1 ... 247.

The setting using DIP switches is described in Setting the bus address via DIP switch (Page 104).

CAUTION
A bus address that has been changed is only effective after switching-off and switching-on again. It is particularly important that any external 24 V supply is switched off.

Additional communication settings

Table 6- 28 Parameters for setting communication via Modbus

Parameter	Description
p0700 = 6	Select the command source 6: Via fieldbus
p1000 = 6	Select the setpoint source 6: Via fieldbus
p2030 = 2	Fieldbus telegram selection 2: Modbus
p2020	Fieldbus baud rate Baud rates from 4800 bit/s to 19200 bit/s can be set for communication, factory setting = 19200 bit/s.
p2024	Modbus timing (see Section "Baud rates and mapping tables (Page 147)") <ul style="list-style-type: none"> • Index 0: Maximum slave telegram processing time: The time after which the slave must have sent a response to the master. • Index 1: Character delay time: Character delay time: Maximum permissible delay time between the individual characters in the Modbus frame. (Modbus standard processing time for 1.5 bytes). • Index2: Inter-telegram delay: Maximum permissible delay time between Modbus telegrams. (Modbus standard processing time for 3.5 bytes).
p2029	Fieldbus fault statistics Displays receive faults on the fieldbus interface
p2040	Process data monitoring time Determines the time after which an alarm is generated if no process data are transferred. Note: This time must be adapted depending on the number of slaves and the baud rate set for the bus (factory setting = 100 ms).

Possible causes of a timeout

Alarm No.	Parameter name	Note
A1910	Setpoint timeout	The alarm is generated when p2040 ≠ 0 ms and one of the following causes is present: <ul style="list-style-type: none"> • The bus connection is interrupted • The MODBUS master is switched off • Communication error (CRC, parity bit, logical error) • An excessively low value for the fieldbus monitoring time (p2040)

6.4.3.2 Modbus RTU telegram

Description

For Modbus, there is precisely one master and up to 247 slaves. Communication is always triggered by the master. The slaves can only transfer data at the request of the master. Slave-to-slave communication is not possible. The Control Unit always operates as slave.

The following figure shows the structure of a Modbus RTU telegram.

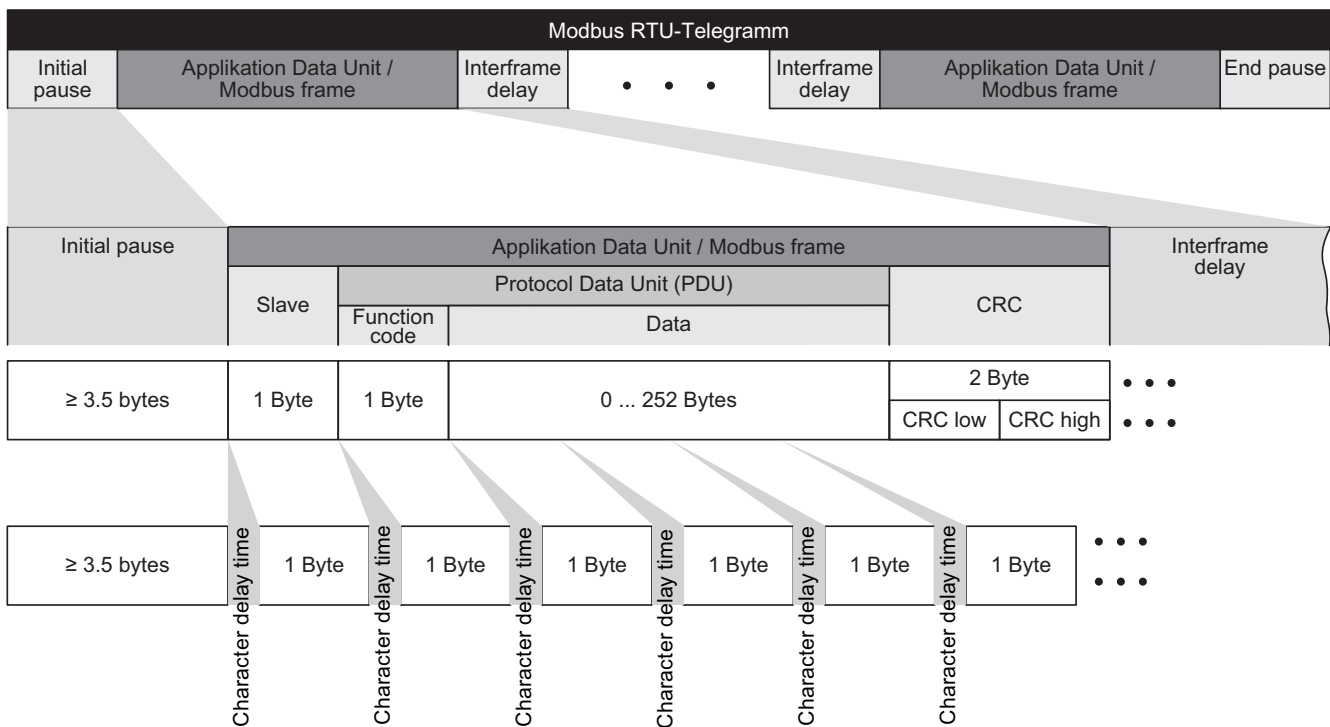

Figure 6-19 Modbus with delay times

The data area of the telegram is structured according to the mapping tables.

As a user, you can use both the register from the MM436 area and from the SINAMICS G120 area.

The registers 40100 to 40111 are described as process data. A telegram monitoring time can be activated in p2040 for these registers.

Note

R"; "W"; "R/W" in the column Modbus access stands for read (with FC03); write (with FC06); read/write.

Table 6- 30 Assigning the Modbus register to the parameters of the Control Unit

Modbus Reg. No.	Description	Modbus access	Unit	Scaling factor	On/Off text or value range		Data / parameter
Process data							
Control data							
40100	Control word	R/W	--	1			Process data 1
40101	Main setpoint	R/W	--	1			Process data 2
Status data							
40110	Status word	R	--	1			Process data 1
40111	Main actual value	R	--	1			Process data 2
Parameter data							
Digital outputs							
40200	DO 0	R/W	--	1	HIGH	LOW	p0730, r747.0, p748.0
40201	DO 1	R/W	--	1	HIGH	LOW	p0731, r747.1, p748.1
40202	DO 2	R/W	--	1	HIGH	LOW	p0732, r747.2, p748.2
Analog outputs							
40220	AO 0	R	%	100	-100.0 ... 100.0		r0774.0
40221	AO 1	R	%	100	-100.0 ... 100.0		r0774.1
Digital inputs							
40240	DI 0	R	--	1	HIGH	LOW	r0722.0
40241	DI 1	R	--	1	HIGH	LOW	r0722.1
40242	DI 2	R	--	1	HIGH	LOW	r0722.2
40243	DI 3	R	--	1	HIGH	LOW	r0722.3
40244	DI 4	R	--	1	HIGH	LOW	r0722.4
40245	DI 5	R	--	1	HIGH	LOW	r0722.5
Analog inputs							
40260	AI 0	R	%	100	-300.0 ... 300.0		r0755 [0]
40261	AI 1	R	%	100	-300.0 ... 300.0		r0755 [1]
40262	AI 2	R	%	100	-300.0 ... 300.0		r0755 [2]
40263	AI 3	R	%	100	-300.0 ... 300.0		r0755 [3]

Modbus Reg. No.	Description	Modbus accesses	Unit	Scaling factor	On/Off text or value range	Data / parameter
Inverter identification						
40300	Powerstack number	R	--	1	0 ... 32767	r0200
40301	CU firmware	R	--	0.0001	0.00 ... 327.67	r0018
Inverter data						
40320	Rated power of the power unit	R	kW	100	0 ... 327.67	r0206
40321	Current Limit	R/W	%	10	10.0 ... 400.0	p0640
40322	Rampup time	R/W	s	100	0.00 ... 650.0	p1120
40323	Ramp-down time	R/W	s	100	0.00 ... 650.0	p1121
40324	Reference speed	R/W	RPM	1	6.000 ... 32767	p2000
Inverter diagnostics						
40340	Speed setpoint	R	RPM	1	-16250 ... 16250	r0020
40341	Speed actual value	R	RPM	1	-16250 ... 16250	r0022
40342	Output frequency	R	Hz	100	- 327.68 ... 327.67	r0024
40343	Output voltage	R	V	1	0 ... 32767	r0025
40344	DC link voltage	R	V	1	0 ... 32767	r0026
40345	Actual value of current	R	A	100	0 ... 163.83	r0027
40346	Actual torque value	R	Nm	100	- 325.00 ... 325.00	r0031
40347	Actual active power	R	kW	100	0 ... 327.67	r0032
40348	Energy consumption	R	kWh	1	0 ... 32767	r0039
40349	Control priority	R	--	1	HAND AUTO	r0807
Fault diagnostics						
40400	Fault number, Index 0	R	--	1	0 ... 32767	r0947 [0]
40401	Fault number, Index 1	R	--	1	0 ... 32767	r0947 [1]
40402	Fault number, Index 2	R	--	1	0 ... 32767	r0947 [2]
40403	Fault number, Index 2	R	--	1	0 ... 32767	r0947 [3]
40404	Fault number, Index 3	R	--	1	0 ... 32767	r0947 [4]
40405	Fault number, Index 4	R	--	1	0 ... 32767	r0947 [5]
40406	Fault number, Index 5	R	--	1	0 ... 32767	r0947 [6]
40407	Fault number, Index 6	R	--	1	0 ... 32767	r0947 [7]
40408	Alarm number	R	--	1	0 ... 32767	r2110 [0]
40499	PRM ERROR code	R	--	1	0 ... 99	--
Technology controller						
40500	Technology controller enable	R/W	--	1	0 ... 1	p2200, r2349.0
40501	Technology controller MOP	R/W	%	100	-200.0 ... 200.0	p2240

6.4 Communication via RS485

Modbus Reg. No.	Description	Modbus accesses	Unit	Scaling factor	On/Off text or value range	Data / parameter
Technology controller adjustment						
40510	Time constant for actual value filter of the technology controller	R/W	--	100	0.00 ... 60.0	p2265
40511	Scaling factor for actual value of the technology controller	R/W	%	100	0.00 ... 500.00	p2269
40512	Proportional amplification of the technology controller	R/W	--	1000	0.000 ... 65.000	p2280
40513	Integral time of the technology controller	R/W	s	1	0 ... 60	p2285
40514	Time constant D-component of the technology controller	R/W	--	1	0 ... 60	p2274
40515	Max. limit of technology controller	R/W	%	100	-200.0 ... 200.0	p2291
40516	Min. limit technology controller	R/W	%	100	-200.0 ... 200.0	p2292
PID diagnostics						
40520	Effective setpoint acc. to internal technology controller MOP ramp-function generator	R	%	100	-100.0 ... 100.0	r2250
40521	Actual value of technology controller after filter	R	%	100	-100.0 ... 100.0	r2266
40522	Output signal technology controller	R	%	100	-100.0 ... 100.0	r2294

6.4.3.4 Write and read access via FC 3 and FC 6

Function codes used

For data exchange between the master and slave, predefined function codes are used for communication via Modbus.

The Control Unit uses the Modbus function code 03, FC 03, (read holding registers) for reading and the Modbus function code 06, FC 06, (preset single register) for writing.

Structure of a read request via Modbus function code 03 (FC 03)

All valid register addresses are permitted as a start address. If a register address is invalid, exception code 02 (invalid data address) is returned. An attempt to read a write-only register or a reserved register is replied to with a normal telegram in which all values are set to 0.

Using FC 03, it is possible to address more than 1 register with one request. The number of addressed registers is contained in bytes 4 and 5 of the read request.

Number of registers

If more than 125 registers are addressed, exception code 03 (Illegal data value) is returned. If the start address plus the number of registers for an address are outside of a defined register block, exception code 02 (invalid data address) is returned.

Table 6- 31 Structure of a read request for slave number 17

Example		
	Byte	Description
11 h	0	Slave address
03 h	1	Function code
00 h	2	Register start address "High" (register 40110)
6D h	3	Register start address "Low"
00 h	4	No. of registers "High" (2 registers: 40110; 40111)
02 h	5	Number of registers "Low"
xx h	6	CRC "Low"
xx h	7	CRC "High"

The response returns the corresponding data set:

Table 6- 32 Slave response to the read request

Example		
	Byte	Description
11 h	0	Slave address
03 h	1	Function code
04 h	2	No. of bytes (4 bytes are returned)
11 h	3	Data of first register "High"
22 h	4	Data of first register "Low"
33 h	5	Data of second register "High"
44 h	6	Data of second register "Low"
xx h	7	CRC "Low"
xx h	8	CRC "High"

Structure of a write request via Modbus function code 06 (FC 06)

The start address is the holding register address. If an incorrect address is entered (a holding register address does not exist), exception code 02 (invalid data address) is returned. An attempt to write to a "read-only" register or a reserved register is replied to with a Modbus error telegram (Exception Code 4 - device failure). In this instance, the detailed internal error code that occurred on the last parameter access via the holding registers can be read out via holding register 40499.

Using FC 06, precisely one register can always be addressed with one request. The value which is to be written to the addressed register is contained in bytes 4 and 5 of the write request.

Table 6- 33 Structure of a write request for slave number 17

Example		
	Byte	Description
11 h	0	Slave address
06 h	1	Function code
00 h	2	Register start address "High" (write register 40100)
63 h	3	Register start address "Low"
55 h	4	Register data "High"
66 h	5	Register data "Low"
xx h	6	CRC "Low"
xx h	7	CRC "High"

The response returns the register address (bytes 2 and 3) and the value (bytes 4 and 5) that was written to the register.

Table 6- 34 Slave response to the write request

Example		
	Byte	Description
11 h	0	Slave address
06 h	1	Function code
00 h	2	Register start address "High"
63 h	3	Register start address "Low"
55 h	4	Register data "High"
66 h	5	Register data "Low"
xx h	6	CRC "Low"
xx h	7	CRC "High"

6.4.3.5 Communication procedure

Procedure for communication in a normal case

Normally, the master sends a telegram to a slave (address range 1 ... 247). The slave sends a response telegram to the master. This response telegram mirrors the function code, and the slave enters its own address in the telegram, which enables the master to assign the slave.

The slave only processes orders and telegrams which are directly addressed to it.

Communication errors

If the slave detects a communication error on receipt (parity, CRC), it does not send a response to the master (this can lead to "setpoint timeout").

Logical error

If the slave detects a logical error within a request, it responds to the master with an "exception response". In the response, the highest bit in the function code is set to 1. If the slave receives, for example, an unsupported function code from the master, the slave responds with an "exception response" with code 01 (Illegal function code).

Table 6- 35 Overview of exception codes

Exception code	Modbus name	Remark
01	Illegal function code	An unknown (not supported) function code was sent to the slave.
02	Illegal Data Address	An invalid address was requested.
03	Illegal data value	An invalid data value was detected.
04	Server failure	Slave has terminated during processing.

Maximum processing time, p2024[0]

For error-free communication, the slave response time (time within which the Modbus master expects a response to a request) must have the same value in the master and the slave (p2024[0] in the inverter).

Process data monitoring time (setpoint timeout), p2040

The alarm "Setpoint timeout" (F1910) is issued by the Modbus if p2040 is set to a value > 0 ms and no process data are requested within this time period.

The alarm "Setpoint timeout" only applies for access to process data (40100, 40101, 40110, 40111). The alarm "Setpoint timeout" is not generated for parameter data (40200 ... 40522).

Note

This time must be adapted depending on the number of slaves and the baud rate set for the bus (factory setting = 100 ms).

Before you set the inverter functions, you should have completed the following commissioning steps:

- Commissioning (Page 55)
- If necessary: Configuring the terminal block (Page 93)
- If necessary: Connection to a fieldbus (Page 103)

7.1 Overview of the inverter functions

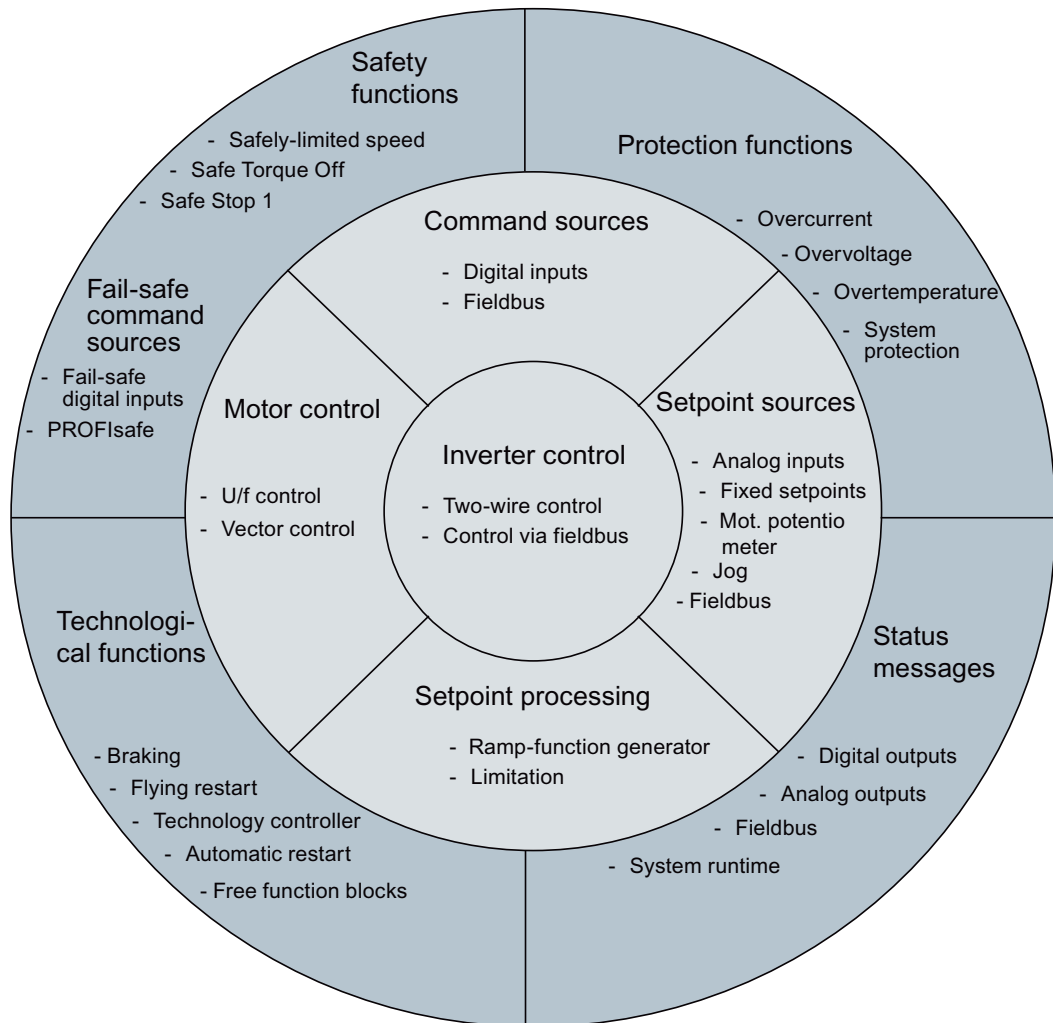
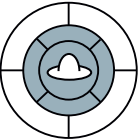
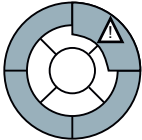
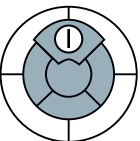
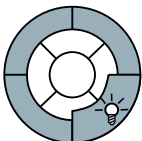
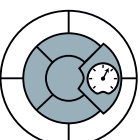
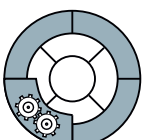
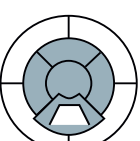
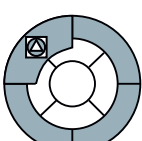
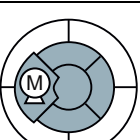
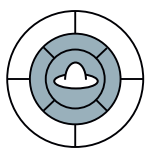

Figure 7-1 Overview of inverter functions

7.1 Overview of the inverter functions

Functions relevant to all applications		Functions required in special applications only	
<p>The functions that you require in your application are provided in the center of the function overview above. In the quick commissioning, the parameters of these functions are assigned an appropriate basic setting, so that in many cases the motor can be operated without having to assign any other parameters.</p>		<p>The functions whose parameters you only need to adapt when actually required are located at the outer edge of the upper function overview.</p>	
	<p>Inverter control is responsible for all of the other inverter functions. Among other things, it defines how the inverter responds to external control signals.</p> <p>Inverter control (Page 157)</p>		<p>The production functions avoid overloads and operating states that could cause damage to the motor, inverter and driven load. The motor temperature monitoring, for example, is set here.</p> <p>Protection functions (Page 175)</p>
	<p>The command source defines where the control signals are received from to switch on the motor, e.g. via digital inputs or a fieldbus.</p> <p>Command sources (Page 158)</p>		<p>The status messages provide digital and analog signals at the outputs of the Control Unit or via the fieldbus. Examples include the actual speed of the motor or fault message issued by the inverter.</p> <p>Status messages (Page 186)</p>
	<p>The setpoint source defines how the speed setpoint for the motor is specified, e.g. via an analog input or a fieldbus.</p> <p>Setpoint sources (Page 159)</p>		<p>The technological functions allow you to activate a motor holding brake or implement a higher-level pressure or temperature control using the technology controller, for example.</p> <p>Technological functions (Page 187)</p>
	<p>The setpoint processing uses a ramp-function generator to prevent speed steps occurring and to limit the speed to a permissible maximum value.</p> <p>Setpoint calculation (Page 166)</p>		<p>The safety functions are used in applications that must fulfill special requirements placed on the functional safety.</p> <p>Safe Torque Off (STO) safety function (Page 214)</p>
	<p>The motor closed-loop control ensures that the motor speed or torque follows its setpoint.</p> <p>Motor control (Page 168)</p>		

7.2 Inverter control



If the inverter is controlled using digital inputs, two control commands define when the motor starts, stops and whether clockwise or counter-clockwise rotation is selected (two-wire control).

Table 7- 1 Controlling the motor

Control commands	Explanation
<p>Motor rotating CW Motor stops Motor rotating CCW Motor stops</p>	
Two-wire control	
	<p>1. Control command: Switch motor on or off (ON/OFF command)</p> <p>2. Control command: Reverses the motor direction of rotation</p>

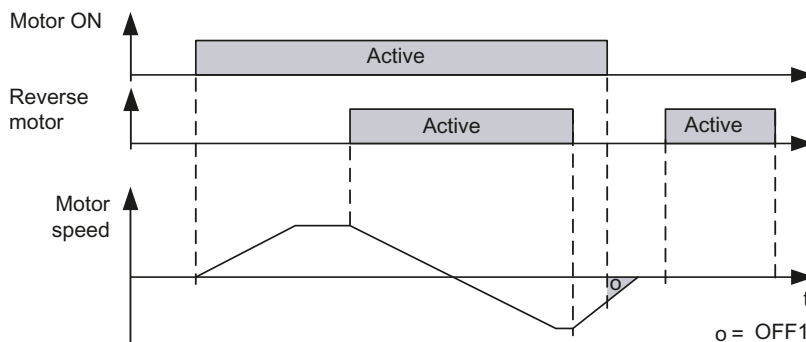

Figure 7-2 Motor control using digital inputs

Table 7- 2 Function table

Motor ON	Reverse motor	Function
0	0	OFF1: The motor decelerates to a standstill
0	1	OFF1: The motor decelerates to a standstill
1	0	The motor accelerates to the setpoint
1	1	The motor accelerates to the inverted setpoint

Table 7- 3 Parameterizing the function

Parameter	Description
P0700 = 2	Controls the motor using the digital inputs of the inverter
P0701 = 1	The motor is power-up with digital input 0 (factory setting) Further options: The motor can be powered-up with any other digital input, e.g. with digital input 3 via P0704 = 1
P0702 = 12	The motor is reversed with digital input 1 (factory setting) Further options: The motor can be reversed with any other digital input, e.g. with digital input 3 via P0704 = 12

7.3 Command sources

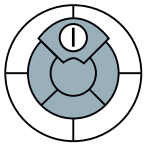

The command source is the interface via which the inverter receives its control commands. The following interfaces are available:

- Digital inputs
- Fieldbus

Note

The "Get master control" or "Manual/Auto changeover" function can also be used to specify commands and setpoints via STARTER or the Operator Panel.

Change command source

You selected the command source in the basic commissioning. If you must subsequently change the command source, set the following parameters:

- P0700 = 2 Digital inputs,
factory setting for inverters without PROFIBUS interface.
- = 6 Fieldbus,
factory setting for inverters with PROFIBUS interface.

Digital inputs as command source

If you wish to control the motor via digital inputs, select one of the two following options:

1. You use the factory settings for the digital inputs. Additional information is available in the section Wiring examples for the factory settings (Page 64).
2. You adapt the function of the digital inputs to your application. How you do this is described in Section Digital inputs (Page 93).

Fieldbus as command source

If you wish to control the motor via a fieldbus, you must connect the inverter to a higher-level control. For additional information, see chapter Connection to a fieldbus (Page 103).

7.4 Setpoint sources

7.4.1 Selecting the setpoint source

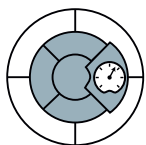

The setpoint source is the interface via which the inverter receives its setpoint. The following options are available:

- Motorized potentiometer simulated in the inverter.
- Inverter analog input.
- Fixed setpoints saved in the inverter.
- Inverter fieldbus interface.

Depending on the parameterization, the setpoint in the inverter has one of the following meanings:

- Speed setpoint for the motor.
- Torque setpoint for the motor.
- Setpoint for a process variable.

The inverter receives a setpoint for a process variable, e.g. the level of liquid in a container, and calculates its speed setpoint using the internal technology controller.

Changing the setpoint source

You selected the setpoint source in the basic commissioning. If you must subsequently change the setpoint source, set the following parameters:

p1000	= 0	No main setpoint
	= 1	MOP setpoint / motorized potentiometer
	= 2	Analog setpoint Factory setting for inverters without PROFIBUS interface
	= 3	Fixed setpoint
	= 6	Fieldbus Factory setting for inverters with PROFIBUS interface
	= 7	Analog setpoint 2

Adding setpoints from different sources

Parameter P1000 can also be used to add more setpoint sources, e.g. you can specify the speed setpoint as the result of adding together the fieldbus and analog input setpoints.

For more information, see the List Manual (P1000 in the parameter list and function diagram 3030).

7.4.2 Analog input as setpoint source

If you use an analog input as setpoint source, then you must adapt this analog input to the type of connected signal (± 10 V, 4 ... 20 mA, ...). Additional information is available in Section Analog inputs (Page 97).

7.4.3 Motorized potentiometer as setpoint source

The 'motorized potentiometer' (MOP) function simulates an electromechanical potentiometer for entering setpoints. You can continuously adjust the motorized potentiometer (MOP) using the control signals "raise" and "lower". The control signals are received via the digital inputs of the inverter or from the operator panel that has been inserted.

Typical applications

- Entering the speed setpoint during the commissioning phase.
- Manual operation of the motor should the higher-level control fail.
- Entering the speed setpoint after changeover from automatic operation to manual operation.
- Applications with largely constant setpoint and without higher-level control.

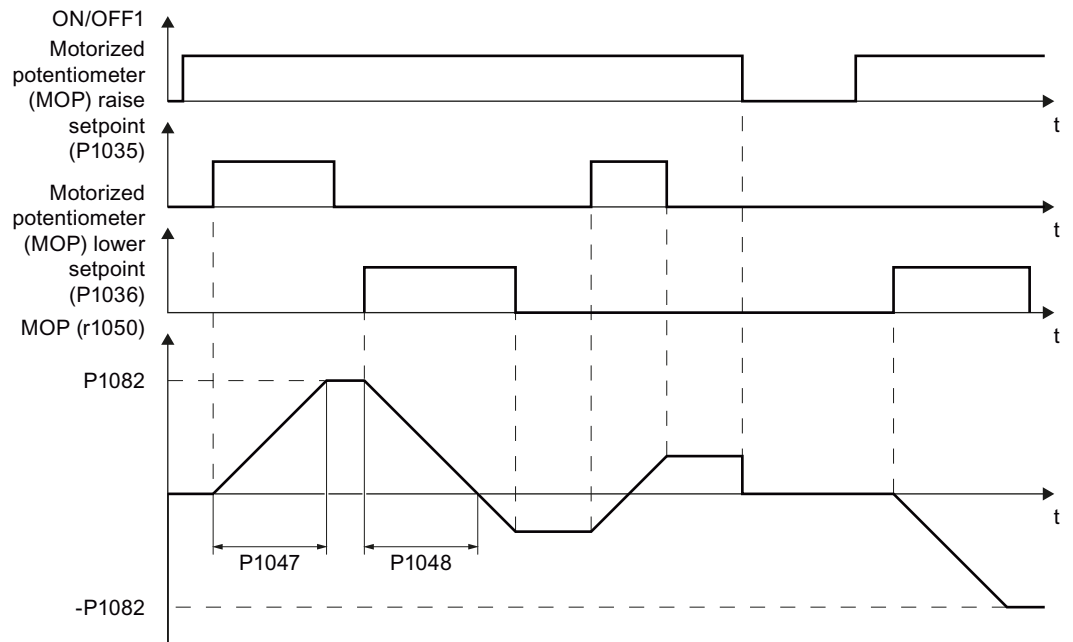

Figure 7-3 Function chart of motorized potentiometer

Motorized potentiometer parameters

Table 7- 4 Basic setup of motorized potentiometer

Parameter	Description
P1000 = 1	Select speed setpoint 1: Motorized potentiometer
P1047	MOP ramp-up time (factory setting 10 s)
P1048	MOP ramp-down time (factory setting 10 s)
P1040	Start value of MOP (factory setting 0 rpm) Determines the start value [rpm] that becomes effective when the motor is switched on

Table 7- 5 Extended setup of motorized potentiometer

Parameter	Description
P1030	<p>Configuration of the MOP, parameter value with four independently adjustable bits 00 ... 03 (factory setting 0110 bin)</p> <p>Bit 00: Save setpoint after switching off motor 0: After the motor is switched on, p1040 is specified as the setpoint 1: Setpoint is saved after the motor is switched off and set to the saved value once it is switched on</p> <p>Bit 01: Configure ramp-function generator in automatic mode (1-signal via BI: p1041) 0: No ramp-function generator in automatic mode (ramp-up/-down time = 0) 1: With ramp-function generator in automatic mode In manual mode (0-signal via BI: p1041) the ramp-function generator is always active</p> <p>Bit 02: Configure initial rounding 0: No initial rounding 1: With initial rounding. The initial rounding is a sensitive way of specifying small setpoint changes (progressive reaction when keys are pressed).</p> <p>Bit 03: Store setpoint in power-independent manner 0: No power-independent saving 1: Setpoint is saved in the event of a power failure (bit 00 = 1)</p>
P1035	<p>Signal source to increase setpoint (factory setting 0) Automatically pre-assigned during commissioning, e.g. with the button on the Operator Panel</p>
P1036	<p>Signal source to reduce setpoint (factory setting 0) Automatically pre-assigned during commissioning, e.g. with the button on the operator panel</p>
P1037	<p>Maximum setpoint (factory setting 0 rpm) Automatically pre-assigned during commissioning</p>
P1038	<p>Minimum setpoint (factory setting 0 rpm) Automatically pre-assigned during commissioning</p>
P1039	<p>Signal source to invert minimum and maximum setpoints (factory setting 0)</p>
P1041	<p>Signal source to switch from manual to automatic (factory setting 0)</p>
P1042	<p>Signal source for setpoint in automatic mode (factory setting 0)</p>
P1043	<p>Signal source to accept set value (factory setting 0) E.g. command to switch on motor</p>
P1044	<p>Signal source for set value (factory setting 0)</p>

For more information about the motorized potentiometer, see the List Manual (function diagram 3020 and the parameter list).

Example of parameterization of the motorized potentiometer

Table 7- 6 Implementing a motorized potentiometer using digital inputs

Parameter	Description
P0700 = 2	Command source Digital inputs
P0701 = 1	Pre-assignment for digital input 0 The motor is switched on and off via digital input 0
P0702 = 13	Pre-assignment for digital input 1 The MOP setpoint is increased via digital input 1
P0703 = 14	Pre-assignment for digital input 2 The MOP setpoint is reduced via digital input 2
P1000 = 1	Setpoint selection: MOP setpoint
P1040 = 10	MOP start value Each time the motor is switched on a setpoint corresponding to 10 rpm is specified
P1047 = 5	MOP ramp-up time: The MOP setpoint is increased from zero to maximum (p1082) in 5 seconds
P1048 = 5	MOP ramp-down time: The MOP setpoint is reduced from maximum (p1082) to zero in 5 seconds

7.4.4 Fixed speed as setpoint source

In many applications after switching on the motor, all that is needed is to run the motor at a constant speed or to switch between different speeds. Examples of this simplified specification of speed setpoint are:

- Conveyor belt with two different speeds.
- Grinding machine with different speeds corresponding to the diameter of the grinding wheel.

If you use the technology controller in the inverter, then you can enter process variables that remain constant over time using a fixed setpoint, e.g.:

- Closed-loop control of a constant flow with a pump.
- Closed-loop control of a constant temperature using a fan.

Procedure

You can set up to 16 various fixed setpoints and select these either via digital inputs or the fieldbus. The fixed setpoints are defined using parameters P1001 to P1004 and can be assigned to the corresponding command sources (e.g. the digital inputs) using P1020 to P1023.

7.4 Setpoint sources

The various fixed setpoints can be selected in two ways:

1. Direct selection:
 Precisely one fixed speed setpoint is assigned to each selection signal (e.g. a digital input). As several selection signals are selected, the associated fixed speed setpoints are added together to form a total setpoint.
 Direct selection is particularly well suited to controlling the motor using the inverter's digital inputs.
2. Binary selection:
 Precisely one fixed speed setpoint is assigned to each possible combination of selection signals.
 Binary selection should preferably be used with a central control and when linking the inverter to a fieldbus.

Table 7-7 Parameters for direct selection of fixed setpoints

Parameter	Description
P1016 = 1	Direct selection of fixed setpoints (factory setting)
P1001	Fixed setpoint 1 Factory setting: 0 rpm)
P1002	Fixed setpoint 2 Factory setting: 0 rpm)
P1003	Fixed setpoint 3 Factory setting: 0 rpm)
P1004	Fixed setpoint 4 Factory setting: 0 rpm)
P1020	Signal source for selection of fixed setpoint 1 (factory setting: 722.3, i.e. selection via digital input 3)
P1021	Signal source for selection of fixed setpoint 2 (factory setting: 722.4, i.e. selection via digital input 4)
P1022	Signal source for selection of fixed setpoint 3 (factory setting: 722.5, i.e. selection via digital input 5)
P1023	Signal source for selection of fixed setpoint 4 (factory setting: 0, i.e. selection is locked)

Table 7-8 Function diagram of direct selection of fixed setpoints

Fixed setpoint selected by	BICO interconnection of selection signals (example)	The resultant fixed setpoint corresponds to the parameter values of ...
Digital input 3 (DI 3)	P1020 = 722.3	P1001
Digital input 4 (DI 4)	P1021 = 722.4	P1002
Digital input 5 (DI 5)	P1022 = 722.5	P1003
Digital input 6 (DI 6)	P1023 = 722.6	P1004
DI 3 and DI 4		P1001 + P1002
DI 3 and DI 5		P1001 + P1003
DI 3, DI 4 and DI 5		P1001 + P1002 + P1003
DI 3, DI 4, DI 5 and DI 6		P1001 + P1002 + P1003 + P1004

You will find further information about the fixed setpoints and *binary* selection in function block diagrams 3010 and 3011 in the List Manual.

Example: Selecting two fixed speed setpoints using digital input 2 and digital input 3

The motor is to run at two different speeds:

- The motor is switched on with digital input 0
- When digital input 2 is selected, the motor is to run at a speed of 300 rpm.
- When digital input 3 is selected, the motor is to accelerate to a speed of 2000 rpm.
- When digital input 1 is selected, the motor should go into reverse

Table 7- 9 Parameter settings for the example

Parameter	Description
P0700 = 2	Selecting the command source: Digital inputs
P0701 = 1	Switching on motor using DI 0 - factory setting
P0702 = 12	Direction reversal using DI 1 - factory setting
P1001 = 300.000	Defines the fixed setpoint 1 in [rpm]
P1002 = 2000.000	Defines the fixed setpoint 2 in [rpm]
P1020 = 722.2	Connect up fixed setpoint 2 with DI 2. r0722.2 = Parameter, which displays the status of digital input 2.
P1021 = 722.3	Connect fixed setpoint 3 with the status of DI 3. r0722.3 = Parameter, which displays the status of digital input 3.

7.4.5 Running the motor in jog mode (JOG function)

Using the "jog" function (JOG function), you can switch the motor on and off using a control command or the operator panel. The speed to which the motor accelerates for "Jog" can be set.

The motor must be switched-off before you issue the "jog" control command. "Jog" has no effect when the motor is switched on.

The "Jog" function is typically used to manually switch-on a motor after switching over from automatic to manual operation.

Setting jogging

The "Jog" function has two different speed setpoints, e.g. for motor counter-clockwise rotation and clockwise rotation.

With an operator panel, you can always select the "Jog" function. If you wish to use additional digital inputs as control commands, you must interconnect the particular signal source with a digital input.

Table 7- 10 Parameters for the "Jog" function

Parameters	Description
p1055	Signal source for jogging 1 - jog bit 0 (factory setting: 0) If you wish to jog via a digital input, then set p1055 = 722.x
p1056	Signal source for jogging 2 - jog bit 1 (factory setting: 0) If you wish to jog via a digital input, then set p1056 = 722.x
p1058	Jogging 1 speed setpoint (factory setting, 150 rpm)
p1059	Jogging 2 speed setpoint (factory setting, 150 rpm)

7.4.6 Specifying the motor speed via the fieldbus

If you enter the setpoint via a fieldbus, you must connect the inverter to a higher-level control. For additional information, see chapter Connection to a fieldbus (Page 103).

7.5 Setpoint calculation

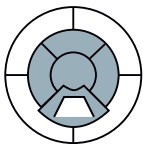

The setpoint calculation modifies the speed setpoint, e.g. it limits the setpoint to a maximum and minimum value and using the ramp-function generator prevents the motor from executing speed steps.

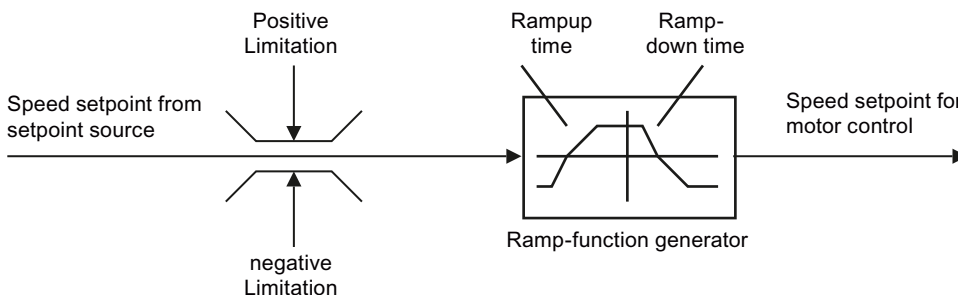

Figure 7-4 Setpoint calculation in the inverter

7.5.1 Minimum speed and maximum speed

The speed setpoint is limited by both the minimum and maximum speed.

When the motor is switched on, it accelerates to the minimum speed regardless of the speed setpoint. The set parameter value applies to both directions of rotation. Beyond its limiting function, the minimum speed serves as a reference value for a series of monitoring functions.

The speed setpoint is limited to the maximum speed in both directions of rotation. The inverter generates a message (fault or alarm) when the maximum speed is exceeded.

The maximum speed also acts as an important reference value for various functions (e.g. the ramp-function generator).

Table 7- 11 Parameters for minimum and maximum speed

Parameter	Description
P1080	Minimum speed
P1082	Maximum speed

7.5.2 Ramp-function generator

The ramp-function generator in the setpoint channel limits the speed of changes to the speed setpoint. The ramp-function generator does the following:

- The soft acceleration and braking of the motor reduces the stress on the mechanical system of the driven machine.
- Acceleration and braking distance of the driven machine (e.g. a conveyor belt) are independent of the motor load.

Ramp-up/down time

The ramp-up and ramp-down times of the ramp-function generator can be set independently of each other. The times that you select depend purely on the application in question and can range from just a few 100 ms (e.g. for belt conveyor drives) to several minutes (e.g. for centrifuges).

When the motor is switched on/off via ON/OFF1, the motor also accelerates/decelerates in accordance with the times set in the ramp-function generator.

Table 7- 12 Parameters for ramp-up time and ramp-down time

Parameter	Description	
P1120	Ramp-up time Duration of acceleration (in seconds) from zero speed to the maximum speed P1082	
P1121	Ramp-down time Duration of deceleration in seconds from the maximum speed P1082 to standstill	

For more information about this function, see the List Manual (function diagram 3060 and the parameter list).

The quick-stop function (OFF3) has a separate ramp-down time, which is set with P1135.

Note

If the ramp-up/down times are too short, the motor accelerates/decelerates with the maximum possible torque and the set times will be exceeded.

Extended ramp-function generator

In the extended ramp-function generator, the acceleration process can be made "softer" using initial and final rounding via parameters p1130 ... p1134. Here, the ramp-up and ramp-down times of the motor are increased by the rounding times.

Rounding does not affect the ramp-down time in the event of a quick stop (OFF3).

For more information, see the List Manual (the parameter list and function diagram 3070).

7.6 Motor control

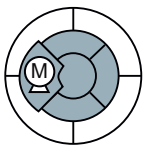

For induction motors, there are two different open-loop control or closed-loop control techniques:

- Open-loop control with V/f-characteristic (V/f control)
- Field-oriented control (vector control)

Criteria for selecting either V/f control or vector control

V/f control is perfectly suitable for almost any application in which the speed of induction motors is to be changed. Examples of typical applications for V/f control include:

- Pumps
- Fans
- Compressors
- Horizontal conveyors

Commissioning vector control takes more time than when commissioning V/f control. When compared to V/f control, vector control offers the following advantages:

- The speed is more stable for motor load changes.
- Shorter accelerating times when the setpoint changes.
- Acceleration and braking are possible with an adjustable maximum torque.
- Improved protection of the motor and the driven machine as a result of the adjustable torque limiting.
- The full torque is possible at standstill.
- Torque control is only possible with vector control.

Examples of typical applications in which vector control is used:

- Hoisting gear and vertical conveyors
- Winders
- Extruders

It is not permissible to use vector control in the following cases:

- If the motor is too small in comparison to the inverter (the rated motor power may not be less than one quarter of the rated inverter power)
- If several motors are connected to one inverter
- If a power contactor is used between the inverter and motor and is opened while the motor is powered up
- If the maximum motor speed exceeds the following values:

Inverter pulse frequency	2 kHz			4 kHz and higher		
Pole number of the motor	2-pole	4-pole	6-pole	2-pole	4-pole	6-pole
Maximum motor speed [rpm]	9960	4980	3320	14400	7200	4800

7.6.1 V/f control

V/f control sets the voltage at the motor terminals on the basis of the specified speed setpoint. The relationship between the speed setpoint and stator voltage is calculated using characteristic curves. The inverter provides the two most important characteristics (linear and square-law). User-defined characteristic curves are also supported.

V/f control is not a high-precision method of controlling the speed of the motor. The speed setpoint and the speed of the motor shaft are always slightly different. The deviation depends on the motor load. If the connected motor is loaded with the rated torque, the motor speed is below the speed setpoint by the amount of the rated slip. If the load is driving the motor (i.e. the motor is operating as a generator), the motor speed is above the speed setpoint.

7.6.1.1 V/f control with linear characteristic

V/f control with a linear characteristic is mainly used in applications in which the motor torque must be independent of the motor speed. Examples of such applications include horizontal conveyors or compressors.

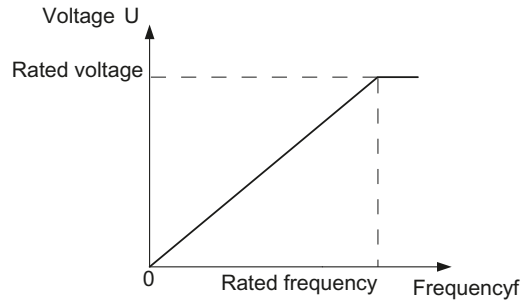

V/f control with a parabolic characteristic is used in applications in which the motor torque increases with the motor speed. Examples of such applications include pumps and fans.

V/f control with square-law characteristic reduces the losses in the motor and inverter due to lower currents than when a linear characteristic is used.

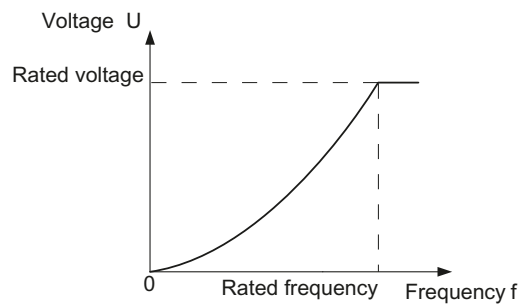

Parameters	Description
P1300	Open-loop/closed-loop control operating mode 0: V/f control with linear characteristic 2: V/f control with parabolic characteristic

Note

V/f control with a square-law characteristic must not be used in applications in which a high torque is required at low speeds.

7.6.1.2 Additional characteristics for the V/f control

In addition to linear and square-law characteristics, there are the following additional versions of the V/f control that are suitable for special applications.

Table 7- 13 Additional V/f control versions (P1300)

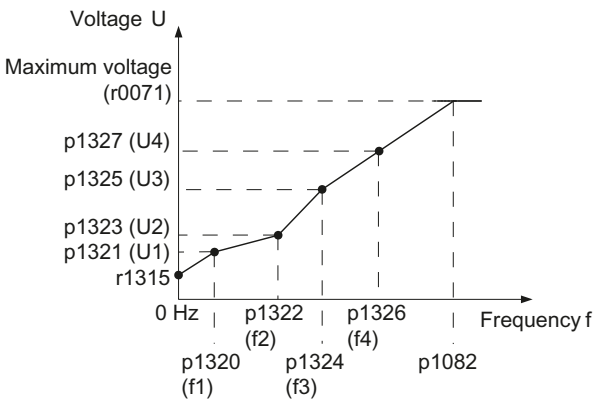
Parameter	Application
P1300 = 1	<p>Linear V/f characteristic with Flux Current Control (FCC) Voltage losses across the stator resistance are automatically compensated. This is particularly useful for small motors since they have a relatively high stator resistance. The prerequisite is that the value of the stator resistance in P350 is parameterized as accurately as possible.</p>
P1300 = 3	<p>Freely adjustable V/f characteristic, which supports the torque behavior of synchronous motors (SIEMOSYN motors)</p> 
P1300 = 4 P1300 = 7	<p>Linear V/f characteristic with ECO Square-law V/f characteristic with ECO ECO mode is suitable for applications requiring a lower level of dynamic performance and a constant speed setpoint and delivers an energy saving of up to 40 %. When the setpoint is reached and remains unchanged for 5 s, the inverter automatically reduces its output voltage to optimize the motor's operating point. ECO mode is deactivated in the event of setpoint changes or if the inverter's DC-link voltage is too high or too low. In ECO mode set the slip compensation (P1335) to 100 %. In the event of minor fluctuations in the setpoint, you have to raise the ramp-function generator tolerance using p1148. Note: Sudden load variations can cause the motor to stall.</p>
P1300 = 5 P1300 = 6	<p>Linear V/f characteristic for textile applications where it is important that the motor speed is kept constant under all circumstances. This setting has the following effects:</p> <ol style="list-style-type: none"> 1. When the maximum current limit is reached, the stator voltage is reduced but not the speed. 2. Slip compensation is locked.
P1300 = 19	<p>V/f control without characteristic. The interrelationship between the frequency and voltage is not calculated in the inverter, but is specified by the user. With BICO technology, P1330 defines the interface via which the voltage setpoint is entered (e.g. analog input → P1330 = 755).</p>

For more information about this function, see function diagram 6300 in the List Manual.

7.6.1.3 Optimizing with a high break loose torque and brief overload

The ohmic losses in the motor stator resistance and the motor cable play a more significant role the smaller the motor and the lower the motor speed. You can compensate for these losses by raising the V/f characteristic.

There are also applications where the motor temporarily needs more than its rated current in the lower speed range or during acceleration in order to adhere to the speed setpoint. Examples of such applications are:

- Driven machines with a high break loose torque
- Utilizing the brief overload capability of the motor when accelerating

Voltage increase in V/f control (boost)

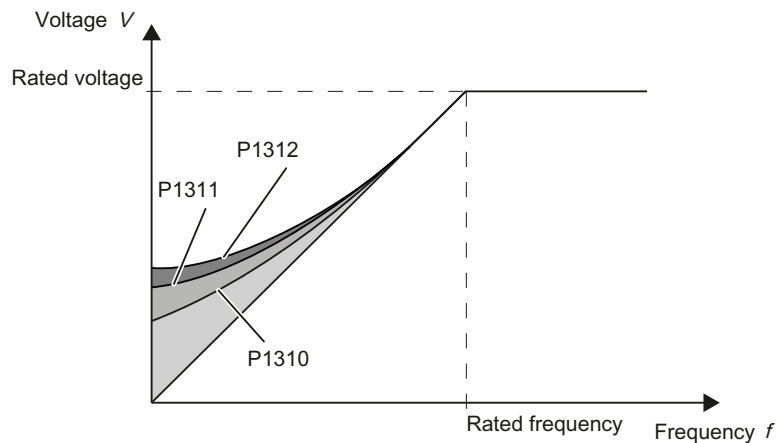

Figure 7-5 Voltage boost using a linear V/f characteristic as an example

Voltage losses resulting from long motor cables and the ohmic losses in the motor are compensated for using parameter p1310. An increased break loose torque when starting and accelerating is compensated using parameter p1312 and/or p1311.

The voltage boost is active for every characteristic type of the V/f control.

Note

Only increase the voltage boost in small steps until satisfactory motor behavior is reached. Excessively high values in p1310 ... p1312 can cause the motor to overheat and switch off (trip) the inverter due to overcurrent .

Table 7- 14 Optimizing the starting characteristics for a linear characteristic

Parameter	Description
P1310	<p>Permanent voltage boost (factory setting 50 %)</p> <p>The voltage boost is effective from standstill up to the rated speed. It is at its highest at zero speed and reduces continuously as the speed increases. Value of voltage boost at zero speed in V: $1.732 \times \text{rated motor current (p0305)} \times \text{stator resistance (r0395)} \times \text{p1310} / 100 \%$.</p>
P1311	<p>Voltage boost on acceleration</p> <p>The voltage boost on acceleration is independent of speed and occurs when the setpoint is increased. It disappears as soon as the setpoint is reached. Value in V: $1.732 \times \text{rated motor current (p0305)} \times \text{stator resistance (r0395)} \times \text{p1311} / 100 \%$</p>
P1312	<p>Voltage boost at start up</p> <p>The voltage boost during start-up results in an additional voltage boost during power-up, but only for the first time the motor accelerates after having been switched on. Value in V: $1.732 \times \text{rated motor current (p0305)} \times \text{stator resistance (r0395)} \times \text{p1312} / 100 \%$</p>

You will find more information about this function in the parameter list and in function diagram 6300 of the List Manual.

7.6.2 Vector control

7.6.2.1 Properties of vector control

Using a motor model, the vector control calculates the load and the motor slip. As a result of this calculation, the inverter controls its output voltage and frequency so that the motor speed follows the setpoint, independent of the motor load.

Vector control is possible without directly measuring the motor speed. This closed-loop control is also known as sensorless vector control.

7.6.2.2 Commissioning vector control

Vector control only functions error-free if, during the basic commissioning, the motor data were correctly parameterized and a motor data identification was performed with the motor in the cold state.

You can find the basic commissioning in the following sections:

- Commissioning with the BOP-2 (Page 68)
- Commissioning with STARTER (Page 73)

Optimizing vector control

- Carry out the automatic speed controller optimization using (P1960 = 1)

Table 7- 15 The most important vector control parameters

Parameter	Description
P1300 = 20	Control type: Vector control without speed encoder
P0300 ... P0360	Motor data are transferred from the motor rating plate during the quick commissioning and calculated with the motor data identification
P1442 ... P1496	Speed controller parameters
P1511	Additional torque
P1520	Upper torque limit
P1521	Lower torque limit
P1530	Motoring power limit
P1531	Regenerative power limit

Additional information about this function is provided in the parameter list and in function diagrams 6030 onwards in the List Manual.

You will find more information On the Internet:

(<http://support.automation.siemens.com/WW/view/en/7494205>):

7.6.2.3 Torque control

Torque control is part of the vector control and normally receives its setpoint from the speed controller output. By deactivating the speed controller and directly entering the torque setpoint, the closed-loop speed control becomes closed-loop torque control. The inverter then no longer controls the motor speed, but the torque that the motor generates.

Typical applications for torque control

The torque control is used in applications where the motor speed is specified by the connected driven load. Examples of such applications include:

- Load distribution between master and slave drives:
The master drive is speed controlled, the slave drive is torque controlled.
- Winding machines

Commissioning the torque control

The torque control only functions error-free if, during the basic commissioning, you correctly parameterized the motor data and performed the motor data identification with the motor in the cold state.

You can find the basic commissioning in the following sections:

- Commissioning with the BOP-2 (Page 68)
- Commissioning with STARTER (Page 73)

Table 7- 16 The most important torque control parameters

Parameter	Description
P1300 = ...	Control type: 20: Vector control without speed encoder 22: Torque control without speed encoder
P0300 ... P0360	Motor data are transferred from the motor rating plate during the quick commissioning and calculated with the motor data identification
P1511 = ...	Additional torque
P1520 = ...	Upper torque limit
P1521 = ...	Lower torque limit
P1530 = ...	Motoring power limit
P1531 = ...	Regenerative power limit

Additional information about this function is provided in the parameter list and in function diagrams 6030 onwards in the List Manual.

7.7

Protection functions

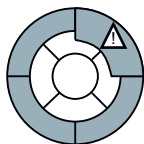

The frequency inverter offers protective functions against overtemperature and overcurrent for both the frequency inverter as well as the motor. Further, the frequency inverter protects itself against an excessively high DC link voltage when the motor is regenerating.

The load torque monitoring functions provide effective plant and system protection.

7.7.1

Inverter temperature monitoring

The inverter temperature is essentially determined by the resistive losses of the output current and the switching losses which occur when pulsing the Power Module. The inverter temperature falls when either the output current or the pulse frequency of the Power Module is reduced.

I2t monitoring (A07805 - F30005)

The Power Module's I2t monitoring controls the inverter utilization by means of a current reference value. The utilization is specified in r0036 [%].

Monitoring the chip temperature of the power unit (A05006 - F30024)

The temperature difference between the power chip (IGBT) and heat sink is monitored using A05006 and F30024. The measured values are specified in r0037[1] [°C].

Heat sink monitoring (A05000 - F30004)

The power unit heat sink temperature is monitored using A05000 and F30004. The values are specified in r0037[0] [°C].

Inverter response

Parameter	Description
P0290	<p>Power unit overload response(Factory setting for all Power Modules except for PM260: 2nd factory setting for PM260: 0)</p> <p>Setting the reaction to a thermal overload of the power unit: 0: Reduce output current (in vector control mode) or speed (in V/f mode) 1: No reduction, shutdown when overload threshold is reached (F30024) 2: Reduce pulse frequency and output current (in vector control mode) or pulse frequency and speed (in V/f mode) 3: Reduce pulse frequency</p>
P0292	<p>Power unit temperature warning threshold (factory setting: Heat sink [0] 5°C, power semiconductor [1] 15°C)</p> <p>The value is set as a difference to the shutdown temperature.</p>

7.7.2 Motor temperature monitoring using a temperature sensor

You can use temperature measurement in the motor to offer the motor thermal protection as follows:

- with PTC sensor
- KTY 84 sensor
- ThermoClick sensor

The motor's temperature sensor is connected to the Control Unit.

Temperature measurement via PTC

The PTC sensor is connected to terminals 14 and 15.

- **Overtemperature:** The threshold value to switch over to an alarm or fault is 1650 Ω. After the PTC responds, alarm A07910 or shutdown with fault F07011 is initiated corresponding to the setting in p0610.
- **Short-circuit monitoring:** Resistance values < 20 Ω indicate a temperature sensor short-circuit

Temperature measurement using KTY 84

The device is connected to terminals 14 (anode) and 15 (cathode) in the forward direction of the diode. The measured temperature is limited to between -48 °C and +248°C and is made available for further evaluation.

- When the alarm threshold is reached (set via p0604; factory setting: 130 °C), alarm A7910 is triggered. Response -> p0610)
- Fault F07011 is output (depending on the setting in p0610) if
 - the fault threshold temperature (settable in p0605) is reached
 - the alarm threshold temperature (settable in p0604) is reached and is still present after the delay time as expired.

Wire-break and short-circuit monitoring via KTY 84

- Wire break: Resistance value > 2120 Ω
- Short circuit: Resistance value < 50 Ω

As soon as a resistance outside this range is measured, A07015 "Alarm temperature sensor fault" is activated and after the delay time expires, F07016 "Motor temperature sensor fault" is initiated.

Temperature monitoring via ThermoClick sensor

The ThermoClick sensor responds at values $\geq 100 \Omega$. After the ThermoClick sensors has responded, either alarm A07910 or shutdown with fault F07011 is initiated corresponding to the setting in p0610.

Parameters to set the motor temperature monitoring with sensor

Table 7- 17 Parameters for detecting the motor temperature via a temperature sensor

Parameter	Description		
P0335	Specify the motor cooling 0: Self-ventilated - with fan on the motor shaft (IC410* or IC411*) - (factory setting) 1: Forced ventilation - with a separately driven fan (IC416*) 2: Self-ventilated and inner cooling* (open-circuit air cooled) 3: Forced ventilated and inner cooling* (open-circuit air cooled)		
P0601	Motor temperature sensor type 0: No sensor (factory setting) 1: PTC thermistor (→ P0604) 2: KTY84 (→ P0604) 4: ThermoClick sensor	Terminal no.	
		14	PTC+ KTY anode ThermoClick
		15	PTC- KTY cathode ThermoClick
P0604	Motor temperature alarm threshold (factory setting 130°C) The alarm threshold is the value at which the inverter is either shut down or I_{max} is reduced (P0610)		
P0605	Motor temperature fault threshold (Factory setting: 145°C)		
P0610	Motor overtemperature response Determines the response when the motor temperature reaches the alarm threshold. 0: No motor response, only an alarm 1: Alarm and reduction of I_{max} (factory setting) reduces the output speed 2: Fault message and shutdown (F07011)		
P0640	Current limit (input in A)		

*According to EN 60034-6

7.7.3 Protecting the motor by calculating the motor temperature

The temperature calculation is only possible in the vector control mode ($P1300 \geq 20$) and functions by calculating a thermal motor model.

Table 7- 18 Parameter to sense the temperature without using a temperature sensor

Parameters	Description
P0621 = 1	Motor temperature measurement after restarting 0: No temperature measurement (factory setting) 1: Temperature measurement after the motor is switched on for the first time 2: Temperature measurement each time that the motor is switched on
P0622	Magnetization time of the motor for temperature measurement after starting (<i>set automatically as the result of motor data identification</i>)
P0625 = 20	Ambient motor temperature Enter the ambient motor temperature in °C at the instant that the motor data is acquired (factory setting: 20°C). The difference between the motor temperature and motor environment (P0625) must lie within a tolerance range of approx. ± 5 °C.

7.7.4 Overcurrent protection

During vector control, the motor current remains within the torque limits set there.

During V/f control, the maximum current controller (I_{max} controller) protects the motor and inverter against overload by limiting the output current.

Method of operation of I_{max} controller

If an overload situation occurs, the speed and stator voltage of the motor are reduced until the current is within the permissible range. If the motor is in regenerative mode, i.e. it is being driven by the connected machine, the I_{max} controller increases the speed and stator voltage of the motor to reduce the current.

Note

The inverter load is only reduced if the motor torque decreases at lower speeds (e.g. for fans).

In the regenerative mode, the current only decreases if the torque decreases at a higher speed.

Settings

NOTICE
The factory setting of the I_{max} controller only needs to be changed in exceptional cases by appropriately trained personnel.

Table 7- 19 I_{max} controller parameters

Parameter	Description
P0305	Rated motor current
P0640	Motor current limit
P1340	Proportional gain of the I_{max} controller for speed reduction
P1341	Integral time of the I_{max} controller for speed reduction
P1345	Proportional gain of the I_{max} controller for voltage reduction
P1346	Integral time of the I_{max} controller for voltage reduction
r0056.13	Status: I_{max} controller active
r1343	Speed output of I_{max} controller Shows the amount to which the I-max controller reduces the speed.
r1344	Voltage output of I_{max} controller Shows the amount by which the I-max controller reduces the inverter output voltage.

For more information about this function, see function diagram 1690 in the List Manual.

7.7.5 Limiting the maximum DC link voltage

How does the motor generate overvoltage?

An induction motor operates as a generator if it is driven by the connected load. A generator converts mechanical power into electrical power. The electrical power flows back into the inverter.

As a consequence, the DC link voltage in the inverter increases. The inverter can only reduce the DC link voltage again if it has an energy recovery feature or it has a braking resistor.

Above a critical DC link voltage both the inverter as well as the motor will be damaged. Before the voltage can reach critical levels, however, the inverter switches the motor off with the fault message "DC link overvoltage".

Protecting the motor and inverter against overvoltage

The V_{DCmax} controller prevents – as far as is technically possible – the DC link voltage from reaching critical levels.

The V_{DCmax} controller is not suitable for applications in which the motor is permanently in the regenerative mode, e.g. in hoisting gear or when large flywheel masses are subject to braking. For applications such as these, you must select an inverter that is equipped with a braking resistor (Power Module PM240 plus external braking resistor) or can feed energy back into the line supply (Power Modules PM250 and PM260).

There are two different groups of parameters for the V_{DCmax} controller, depending on whether the motor is being operated with V/f control or vector control.

Table 7- 20 V_{DCmax} controller parameters

Parameter for V/f control	Parameter for vector control	Description
p1280 = 1	p1240 = 1	V_{DC} controller or V_{DC} monitoring configuration (factory setting: 1)1: Enable V_{DCmax} controller
r1282	r1242	V_{DCmax} controller switch-on level Shows the value of the DC-link voltage above which the V_{DCmax} controller is active
p1283	p1243	V_{DCmax} controller dynamic factor (factory setting: 100 %) scaling of the control parameters P1290, P1291 and P1292
p1290	p1250	V_{DCmax} controller proportional gain (factory setting: 1)
p1291	p1251	V_{DCmax} controller reset time (factory setting p1291: 40 ms, factory setting p1251: 0 ms)
p1292	p1252	V_{DCmax} controller rate time (factory setting p1292: 10 ms, factory setting p1252: 0 ms)
p1294	p1254	V_{DCmax} controller automatic recording ON-signal level (factory setting p1294: 0, factory setting p1254: 1)Activates or deactivates automatic detection of the switch-on levels of the V_{DCmax} controller. 0: Automatic detection disabled 1: Automatic detection enabled
p0210	p0210	Device connection voltage If p1254 or p1294 = 0, the inverter uses this parameter to calculate the intervention threshold of the V_{DCmax} controller. Set this parameter to the actual value of the input voltage.

For more information about this function, see the List Manual (function diagrams 6320 and 6220).

7.7.6 Load torque monitoring (system protection)

In many applications, it is advisable to monitor the motor torque:

- Applications where the load speed can be indirectly monitored by means of the load torque. For example, in fans and conveyor belts too low a torque indicates that the drive belt is torn.
- Applications that are to be protected against overload or locking (e.g. extruders or mixers).
- Applications in which no-load operation of the motor represents an impermissible situation (e.g. pumps).

Load torque monitoring functions

The inverter monitors the torque of the motor in different ways:

1. No-load monitoring:
The inverter generates a message if the motor torque is too low.
2. Blocking protection:
The inverter generates a message if the motor speed cannot match the speed setpoint despite maximum torque.
3. Stall protection:
The inverter generates a message if the inverter control has lost the orientation of the motor.
4. Speed-dependent torque monitoring
The inverter measures the actual torque and compares it with a parameterized speed/torque characteristic.

Table 7- 21 Parameterizing the monitoring functions

Parameter	Description
No-load monitoring	
P2179	Current limit for no-load detection If the inverter current is below this value, the message "no load" is output.
P2180	Delay time for the "no load" message
Blocking protection	
P2177	Delay time for the "motor locked" message
Stall protection	
P2178	Delay time for the "motor stalled" message
P1745	Deviation of the setpoint from the actual value of the motor flux as of which the "motor stalled" message is generated This parameter is only evaluated as part of encoderless vector control.

Parameter	Description
Speed-dependent torque monitoring	
P2181	Load monitoring, response Setting the response when evaluating the load monitoring. 0: Load monitoring disabled >0: Load monitoring enabled
P2182	Load monitoring, speed threshold 1
P2183	Load monitoring, speed threshold 2
P2184	Load monitoring, speed threshold 3
P2185	Load monitoring torque threshold 1, upper
P2186	Load monitoring torque threshold 1, lower
P2187	Load monitoring torque threshold 2, upper
P2188	Load monitoring torque threshold 2, lower
P2189	Load monitoring torque threshold 3, upper
P2190	Load monitoring torque threshold 3, lower
P2192	Load monitoring, delay time Delay time for the message "Leave torque monitoring tolerance band"

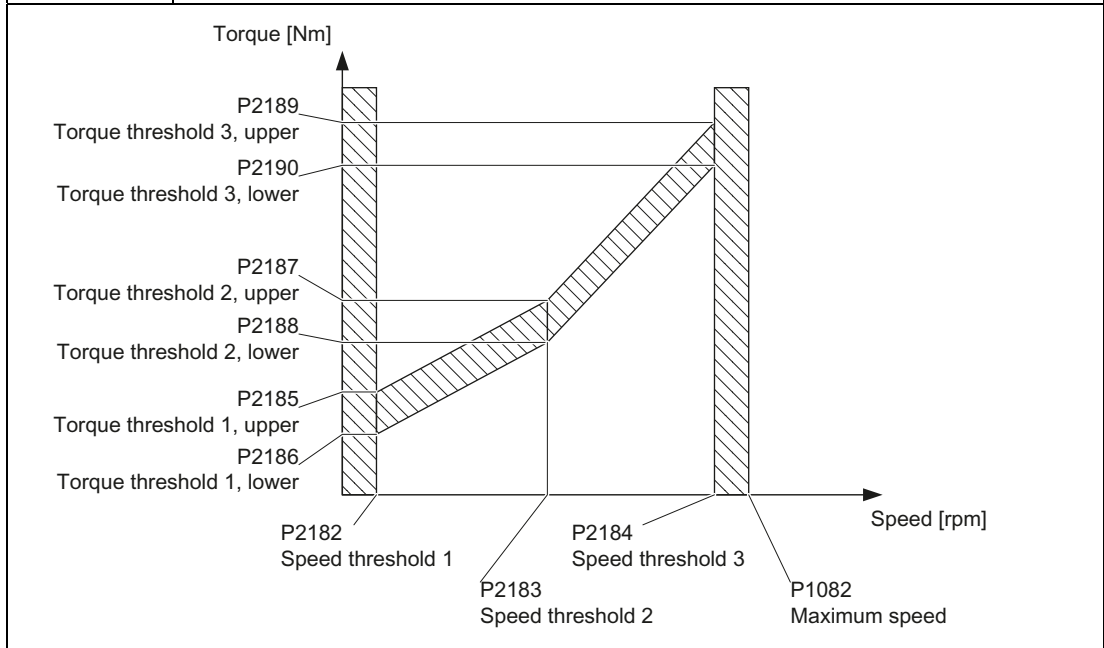

For more information about these functions, see the List Manual (function diagram 8013 and the parameter list).

7.7.7 Speed and load failure via digital input

With this function you can directly monitor not only the motor speed but also the speed of the driven load. Examples include:

- Gearbox monitoring, e.g. in traction drives or hoisting gear
- Drive belt monitoring, e.g. in fans or conveyor belts
- Monitoring for blocked driven load

Speed or velocity monitoring functions

There are two ways of directly monitoring speed in your application:

1. Load failure monitoring: The inverter evaluates whether the sensor signal is present.
2. Speed deviation monitoring: The inverter calculates a speed from the signal of the connected sensor and compares it with the internal motor control signal.

Speed monitoring requires a binary sensor (e.g. a BERO), the output signal from which is evaluated as a pulse sequence by a digital input on the inverter.

Load failure monitoring

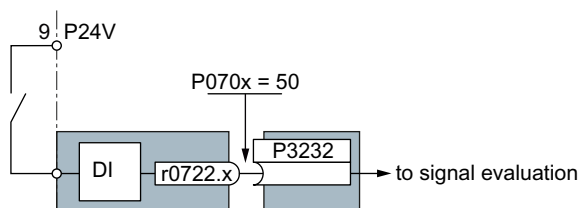

Figure 7-6 Load failure monitoring by means of a digital input

If you parameterize the function of a digital input for load failure monitoring (P070x = 50), you automatically interconnect this input to signal evaluation via BICO technology.

Table 7-22 Setting load failure monitoring

Parameter	Description
P2193 = 1...3	Load monitoring configuration (factory setting: 1) 0: Monitoring is disabled 1: Torque and load failure monitoring 2: Speed and load failure monitoring 3: Load failure monitoring
P070x = 50	Pre-assignment of digital input 50: Load monitoring failure detection Monitoring is possible via each of the CU's digital inputs. If you want to use digital input 2, for example, parameterize P0703 = 50
P2192	Load monitoring delay time (factory setting 10 s) If, after the motor is switched on, the "LOW" signal is present on the associated digital input for longer than this time, a load failure is assumed (F07936)

For more information, see the List Manual (the parameter list and function diagram 8013).

Speed deviation monitoring

This function is only available for Control Units CU240E-2, CU240E-2 DP, CU240E-2 F and CU240E-2 DP-F. The monitoring sensor is connected to digital input 3.

The inverter can process a pulse sequence of up to 32 kHz.

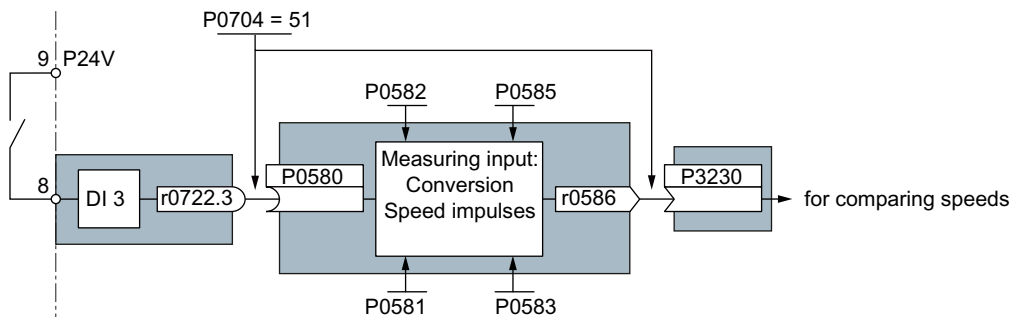

Figure 7-7 Speed deviation monitoring by means of digital input DI3

The speed is calculated from the pulse signal of the digital input in the "probe".

With P0704 = 51, the probe input (P0580) is connected to digital input 3, and P3230 (setting of the source for speed monitoring) is connected to the probe output (r0586) with BICO technology.

The calculated speed is compared with the actual speed value from the motor control and, if an (adjustable) deviation is detected, a response (also adjustable) is triggered.

Table 7- 23 Setting speed deviation monitoring

Parameter	Description
P2193 = 2	Load monitoring configuration (factory setting: 1) 2: Speed and load failure monitoring
P2192	Load monitoring delay time (factory setting 10 s) Setting the delay time for evaluation of load monitoring
P2181	Load monitoring response (factory setting 0) Setting the response for evaluation of load monitoring
P3231	Load monitoring speed deviation (factory setting 150 rpm) Permissible speed deviation of load monitoring
P0704 = 51	Pre-assignment of digital input 51: Load monitoring, failure detection
P0581	Probe edge (factory setting 0) Setting the edge for evaluation of the probe signal to measure actual speed value 0: 0/1 edge 1: 1/0 edge
P0582	Probe pulses per revolution (factory setting 1) Setting the number of pulses per revolution
P0583	Maximum probe measuring time (factory setting 10 s) Setting the maximum measuring time for the probe. If there is no new pulse before the maximum measuring time elapses, the actual speed value in r0586 is set to zero. With the next pulse, the time is restarted.
P0585	Probe gear factor (factory setting 1) The measured speed is multiplied by the gear factor before being displayed in r0586.
P0490	Invert probe (factory setting 0000bin) The 3rd bit of the parameter value inverts the input signals of digital input 3 for the probe.

For more information, see the List Manual (the parameter list and function diagram 8013).

7.8 Status messages

7.8.1 Overview, evaluating the inverter state

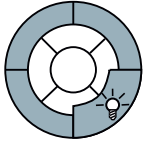

Information about the inverter state (alarms, faults, actual values) can be output via inputs and outputs and also via the communication interface.

Details on evaluating the inverter state via inputs and outputs are provided in Section Configuring the terminal block (Page 93).

The evaluation of the inverter state via the communication interface is realized using the inverter status word. Details on this are provided in the individual sections of Chapter Connection to a fieldbus (Page 103).

7.8.2 System runtime

By evaluating the system runtime of the inverter, you can decide whether you must replace components subject to wear such as fans, motors and gear units.

Principle of operation

The system runtime is started as soon as the Control Unit power supply is switched-on. The system runtime stops when the Control Unit is switched off.

The system runtime comprises r2114[0] (milliseconds) and r2114[1] (days):

System runtime = r2114[1] × days + r2114[0] × milliseconds

If r2114[0] has reached a value of 86,400,000 ms (24 hours), r2114[0] is set to the value 0 and the value of r2114[1] is increased by 1.

Using system runtime, you can track the sequence of faults and alarms over time. When a corresponding message is triggered, parameter values r2114 are transferred unchanged to the corresponding parameters of the alarm or fault buffer, see chapter entitled Alarms, faults and system messages (Page 243).

Parameters	Description
r2114[0]	System runtime (ms)
r2114[1]	System runtime (days)

You cannot reset the system runtime.

7.9 Technological functions

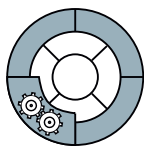

The inverter offers a series of technology functions, e.g.:

- Braking functions
- Automatic restart and flying restart
- Basic process control functions
- Logical and arithmetic functions using function blocks that can be freely interconnected

Please refer to the following sections for detailed descriptions.

7.9.1 Braking functions of the inverter

A differentiation is made between electrically braking and mechanically braking a motor:

- The motor is electrically braked by the inverter. An electrical braking is completely wear-free. Generally, a motor is switched off at standstill in order to save energy and so that the motor temperature is not unnecessarily increased.
- Mechanical brakes are generally motor holding brakes that are closed when the motor is at a standstill. Mechanical operating brakes, that are closed while the motor is rotating are subject to a high wear and are therefore often only used as an emergency brake.

7.9.1.1 Comparison of electrical braking methods

Regenerative power

If an induction motor electrically brakes the connected load and the mechanical power exceeds the electrical losses, then it operates as a generator. The motor converts mechanical power into electrical power. Examples of applications, in which regenerative operation briefly occurs, include:

- Grinding disk drives
- Fans

For certain drive applications, the motor can operate in the regenerative mode for longer periods of time, e.g.:

- Centrifuges
- Hoisting gear and cranes
- Conveyor belts with downward movement of load (vertical or inclined conveyors)

Inverter braking methods

Depending on the particular application, there are different methods for dealing with regenerative energy.

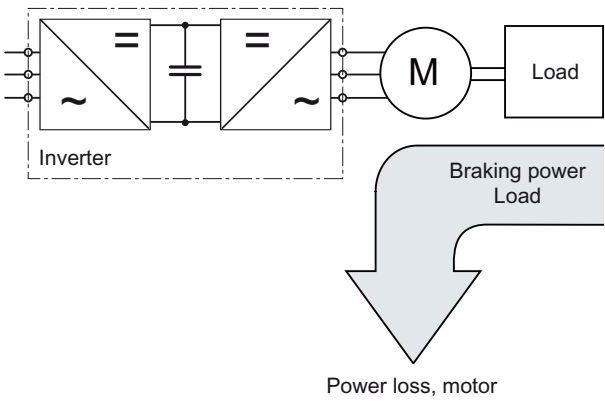
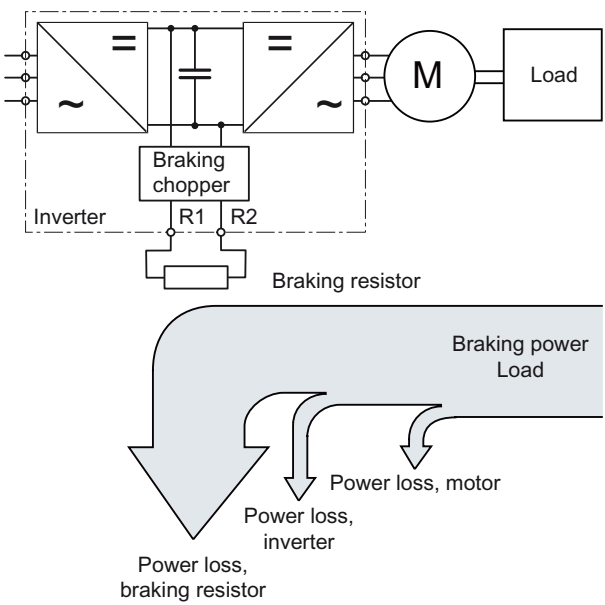
<p>DC braking</p> <ul style="list-style-type: none"> • <i>Advantage:</i> The motor is braked without the inverter having to convert the regenerative energy • <i>Disadvantages:</i> significant increase in the motor temperature; no defined braking characteristics; no constant braking torque; no braking torque at standstill; braking power is lost as heat; does not function when the power fails <p>Compound braking</p> <ul style="list-style-type: none"> • <i>Advantage:</i> Defined braking characteristics, the motor is braked without the inverter having to convert any regenerative energy • <i>Disadvantages:</i> significant motor temperature rise; no constant braking torque; braking power is dissipated as heat; does not function when the power fails 	 <p>The regenerative energy is converted to heat in the motor.</p>
<p>Dynamic braking</p> <ul style="list-style-type: none"> • <i>Advantages:</i> defined braking characteristics; no additional motor temperature increase; constant braking torque; in principle, also functions when the power fails • <i>Disadvantages:</i> A braking resistor is required; regenerative power is lost as heat; the permissible thermal load of the braking resistor must be taken into account 	 <p>The inverter converts the regenerative power into heat using a braking resistor</p>

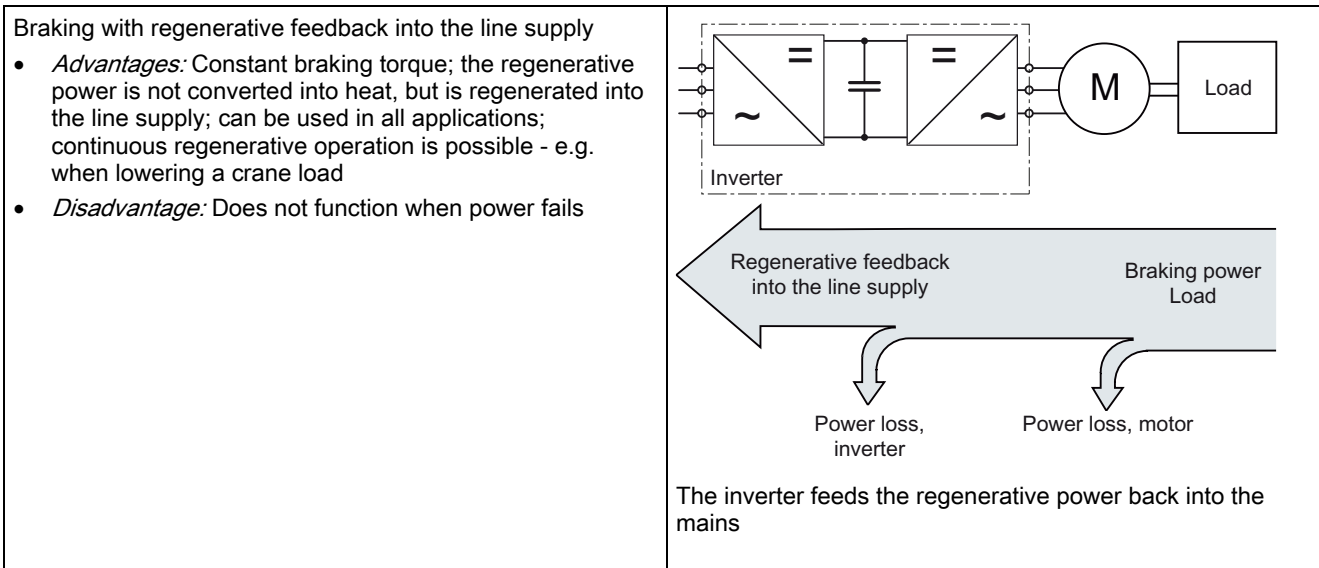

Braking method depending on the application

Table 7- 24 What braking method is suitable for what application?

Application examples	Electrical braking methods	Power Modules that can be used
Pumps, fans, mixers, compressors, extruders	Not required	PM240, PM250, PM260
Grinding machines, conveyor belts	DC braking, compound braking	PM240
Centrifuges, vertical conveyors, hoisting gear, cranes, winders	Dynamic braking	PM240
	Braking with regenerative feedback into the line supply	PM250, PM260

Table 7- 25 What Power Module do you require for a specific braking method?

	SINAMICS G120 Power Module		
	PM240	PM250	PM260
DC braking	X	X	X
Compound braking	X	---	---
Dynamic braking	X	---	---
Braking with regenerative feedback into the line supply	---	X	X

7.9.1.2 DC braking

DC braking is typically used for applications in which the motor is normally operated at a constant speed and is only braked down to standstill in longer time intervals, e.g.:

- Centrifuges
- Saws
- Grinding machines
- Conveyor belts

Principle of operation

You can select the DC braking in two different ways:

1. Using any binary signal, e.g. a digital input.
2. When a fault occurs.

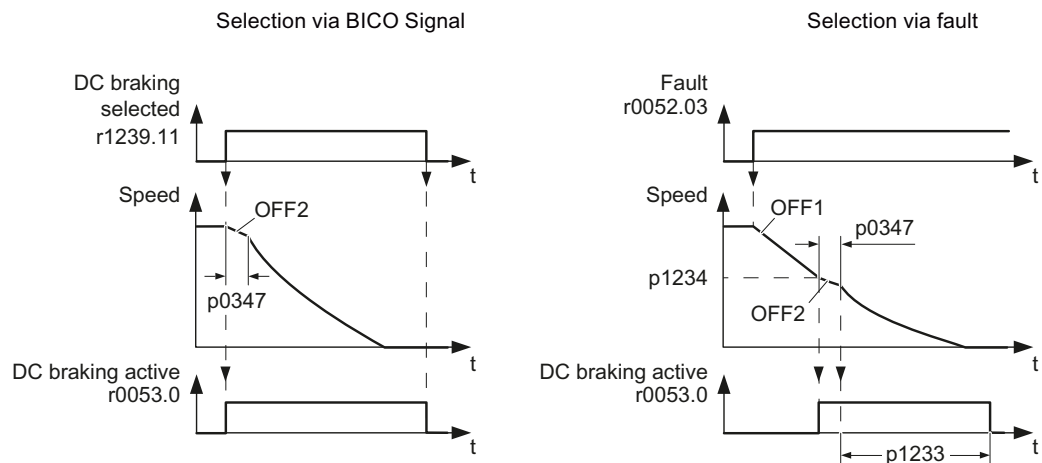



Figure 7-8 Principle of operation of the DC braking

	Selection via BICO Signal	Selection via fault
1.	---	Initially, the inverter brakes the motor with the ramp-down time of the ramp-function generator (OFF1 ramp-down time) until an adjustable speed threshold is reached.
2.	The inverter temporarily issues an internal OFF2 command.	If the motor speed falls below this threshold, the inverter issues a temporary internal OFF2 command.
3.	If the motor is demagnetized (p0347 has expired), the inverter injects a direct current into the motor. The magnitude of the DC current can be adjusted using p1230.	
4.	Direct current flows through the motor until DC braking has been deactivated.	The duration of DC braking can be adjusted using p1233.

 CAUTION
DC braking converts some of the kinetic energy of the motor and load into heat in the motor (temperature rise). The motor will overheat if the braking operation lasts too long or the motor is braked too often.

Parameterizing DC braking

Table 7- 26 DC braking enabling:

Parameter	Description
	Select DC braking via external command:
p1230	BI: DC braking activation (factory setting: 0) Selects DC braking via a signal that was used by an external source (BICO). The function remains active as long as the external signal is active.
	Selection of DC braking via fault:
p2100	Set the fault number for fault reaction (Factory setting: 0) Set the fault number for which DC braking should be activated, e.g.: p2100[3] = 7860 (external fault 1).
p2101 = 6	Set the fault reaction Factory setting: 0) Setting the fault reaction for the selected fault e.g. p2100[3] = 6 (DC braking for external fault 1). DC braking cannot be selected for all faults.

Table 7- 27 Setting the DC braking:

Parameter	Description
p1231	DC braking configuration (factory setting: 0) Activate DC braking. 0: No function (factory setting) 4: DC braking
p1232	DC braking braking current (factory setting: 0 A) Setting the braking current for the DC braking.
p1233	DC braking duration (factory setting: 1 s)
p1234	DC braking start speed (factory setting: 210000 rpm) If the actual speed falls below this threshold, DC braking is activated.
p0347	Motor de-excitation The parameter is calculated via p0340 = 1, 3. The inverter can trip due to an overcurrent during DC braking if the de-excitation time is too short.

7.9.1.3 Compound braking

Compound braking is typically used for applications in which the motor is normally operated at a constant speed and is only braked down to standstill in longer time intervals, e.g.:

- Centrifuges
- Saws
- Grinding machines
- Horizontal conveyors

Principle of operation

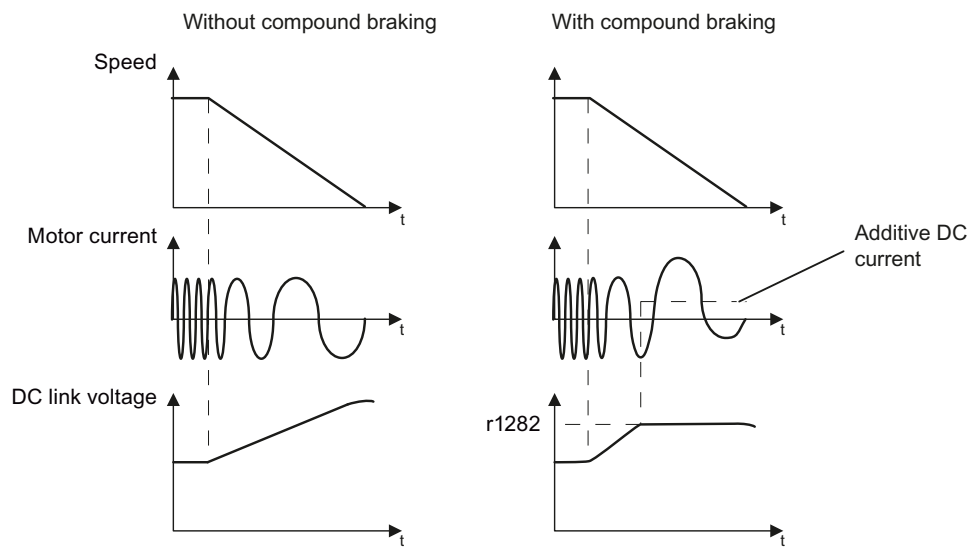

Figure 7-9 Motor brakes with and without active compound braking

Compound braking prevents the DC link voltage increasing above a critical value. The inverter activates compound braking depending on the DC link voltage. Above a DC link voltage threshold (r1282), the inverter adds a DC current to the motor current. The DC current brakes the motor and prevents an excessive increase in the DC link voltage.

Note

Compound braking is only active in conjunction with the V/f control.

Compound braking does not operate in the following cases:

- The "flying restart" function is active
- DC braking is active
- Vector control is selected

Parameterizing compound braking

Table 7- 28 Parameters to enable and set compound braking

Parameter	Description
P3856	<p>Compound braking current (%)</p> <p>With the compound braking current, the magnitude of the DC current is defined, which is additionally generated when stopping the motor for operation with V/f control to increase the braking effect.</p> <p>P3856 = 0 Compound braking locked</p> <p>P3856 = 1 ... 250 Current level of the DC braking current as a % of the rated motor current (P0305)</p> <p>Recommendation: $p3856 < 100 \% \times (r0209 - r0331) / p0305 / 2$</p>
r3859.0	<p>Status word, compound braking</p> <p>r3859.0 = 1: Compound braking is active</p>

CAUTION

Compound braking converts part of the kinetic energy of the motor and load into motor heat (temperature rise). The motor can overheat if braking lasts too long or the drive is braked too frequently.

7.9.1.4 Dynamic braking

Dynamic braking is typically used in applications in which dynamic motor behavior is required at different speeds or continuous direction changes, e.g.:

- Horizontal conveyors
- Vertical and inclined conveyors
- Hoisting gear

Principle of operation

The inverter controls the braking chopper depending on its DC link voltage. The DC link voltage increases as soon as the inverter absorbs the regenerative power when braking the motor. The braking chopper converts this power into heat in the braking resistor. This therefore prevents the DC link voltage increasing above the limit value $V_{DC\ link, max}$.

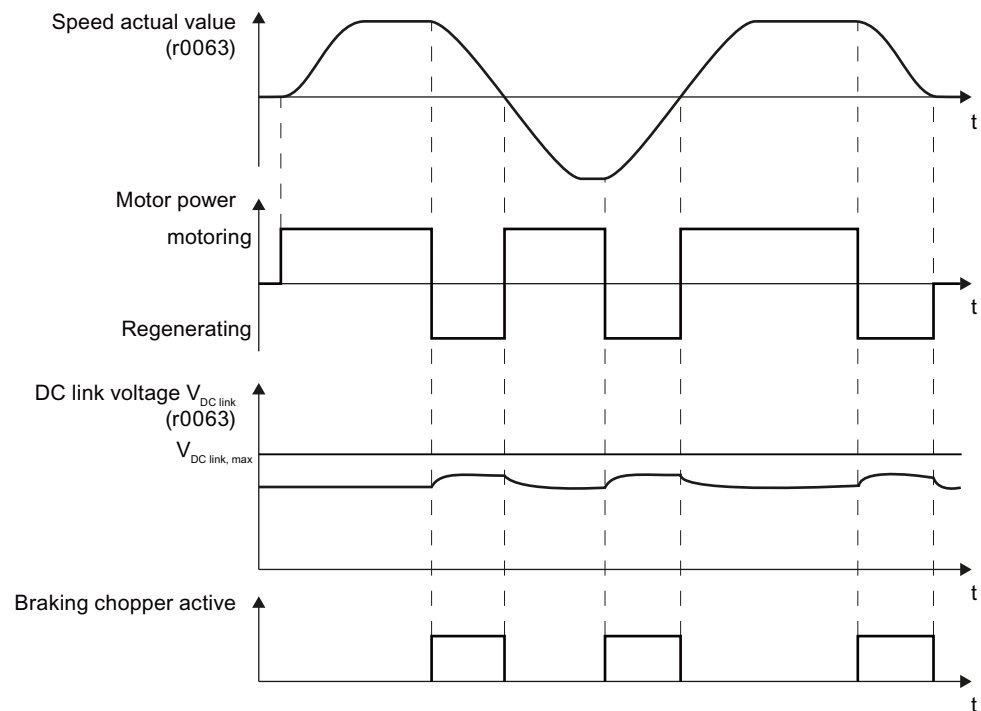

Figure 7-10 Simplified representation of dynamic braking with respect to time

Braking resistor connection

- Connect the braking resistor to terminals R1 and R2 of the Power Module
- Ground the braking resistor directly to the control cabinet's grounding bar. The braking resistor must not be grounded via the PE terminals on the Power Module

- Evaluate the braking resistor's temperature monitoring (terminals T1 and T2) such that the motor is switched off when the resistor has an overtemperature condition. You can do this in the following two ways:
 - Use a contactor to disconnect the inverter from the line as soon as temperature monitoring requests it
 - Specify the inverter's OFF2 command via the braking resistor's temperature monitoring

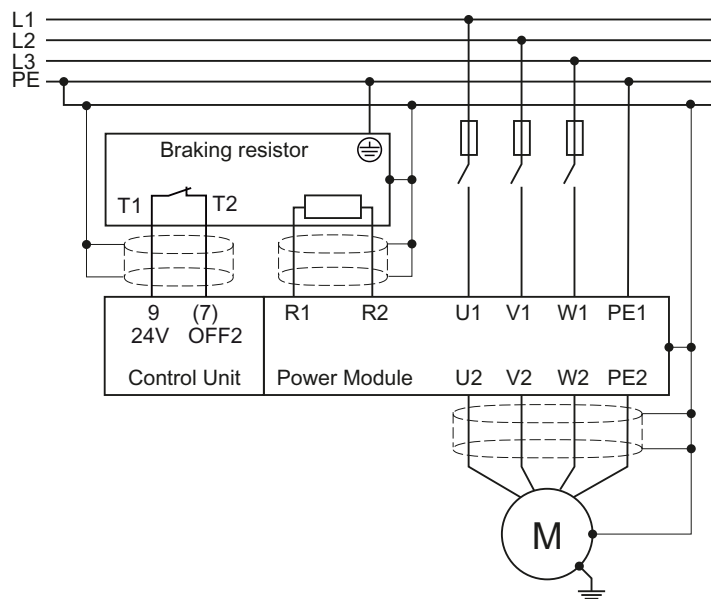

Figure 7-11 Braking resistor connection

You will find more information about the braking resistor in the installation instructions for Power Module PM240

(<http://support.automation.siemens.com/WW/view/en/30563173/133300>).

⚠ WARNING

If an unsuitable braking resistor is used, this could result in a fire and severely damage the inverter.

The temperature of braking resistors increases during operation. For this reason, avoid coming into direct contact with braking resistors. Maintain sufficient clearances around the braking resistor and ensure that there is adequate ventilation.

Parameterizing the dynamic braking

Deactivate the V_{DCmax} controller. The V_{DCmax} controller is described in Section Limiting the maximum DC link voltage (Page 179).

The dynamic braking does not have to be parameterized any further.

7.9.1.5 Braking with regenerative feedback to the line

Regenerative braking is typically used in applications where braking energy is generated either frequently or for longer periods of time, e.g.:

- Centrifuges
- Unwinders
- Cranes and hoisting gear

Pre-requisite for regenerative braking is the Power Module PM250 or PM260.

The inverter can feed back up to 100% of its power into the line supply (referred to "High Overload" base load, see Section Technical data, Power Modules (Page 263)).

Parameterization of braking with regenerative feedback to the line

Table 7- 29 Settings for braking with regenerative feedback to the line

Parameter	Description
Limiting the regenerative feedback for V/f control (P1300 < 20)	
p0640	<p>Motor overload factor</p> <p>Limiting the regenerative power is not directly possible with V/f control, but can be achieved indirectly by limiting the motor current.</p> <p>If the current exceeds this value for longer than 10 s, the inverter shuts down the motor with fault message F07806.</p>
Limiting feedback with vector control (P1300 ≥ 20)	
P1531	<p>Regenerative power limit</p> <p>The maximum regenerative load is entered as negative value via p1531. (-0.01 ... -100000.00 kW).</p> <p>Values higher than the rated value of the power unit (r0206) are not possible.</p>

7.9.1.6 Motor holding brake

The motor holding brake prevents the motor turning when it is switched off. The inverter has internal logic to control a motor holding brake.

The motor holding brake control inside the inverter is suitable for the following typical applications:

- Horizontal, inclined and vertical conveyors
- Pumps
- Fans

Connecting the motor holding brake

The Brake Relay serves as an interface between the Power Module and the motor's brake coil.

The Brake Relay can be mounted on a mounting plate, the cabinet wall or the inverter's shield connection kit. For more information, refer to Installation instructions for the Brake Relay (<http://support.automation.siemens.com/WW/view/en/23623179>).

Connect the Brake Relay to the Power Module using the cable form provided.

Table 7- 30 Connecting the Brake Relay to the Power Module

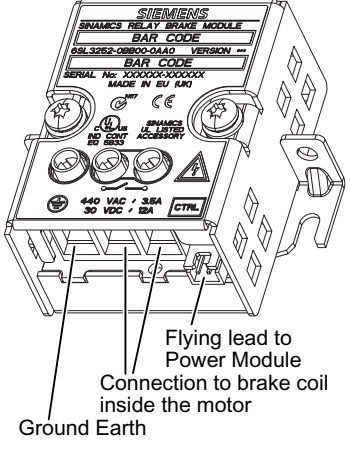
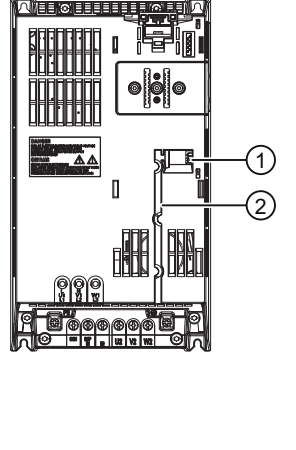
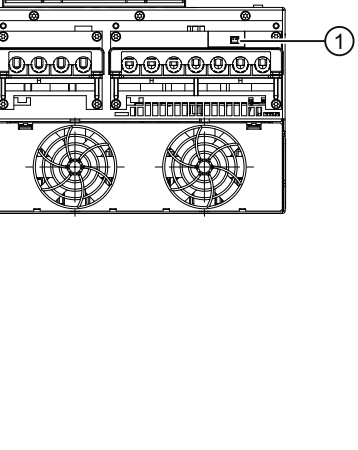
Brake Relay	Power Module FSA ... FSC 0.37 kW ... 15 kW	Power Module FSD ... FSF 18.5 kW ... 110 kW
		
<p>The Brake Relay's control connection is marked "CTRL".</p>	<p>The Brake Relay's control connection ① is on the front panel of the Power Module. The Power Module has a cable guide ② for the control cable</p>	<p>The Brake Relay's control connection ① is on the lower side of the Power Module.</p>

Connect the motor holding brake to the terminals of the Brake Relay.

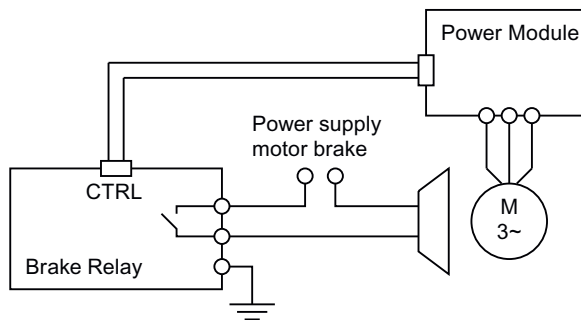

Figure 7-12 Connecting the motor holding brake

Further information can be found in the Hardware Installation Manual for your Power Module.

Principle of operation after OFF1 and OFF3 command

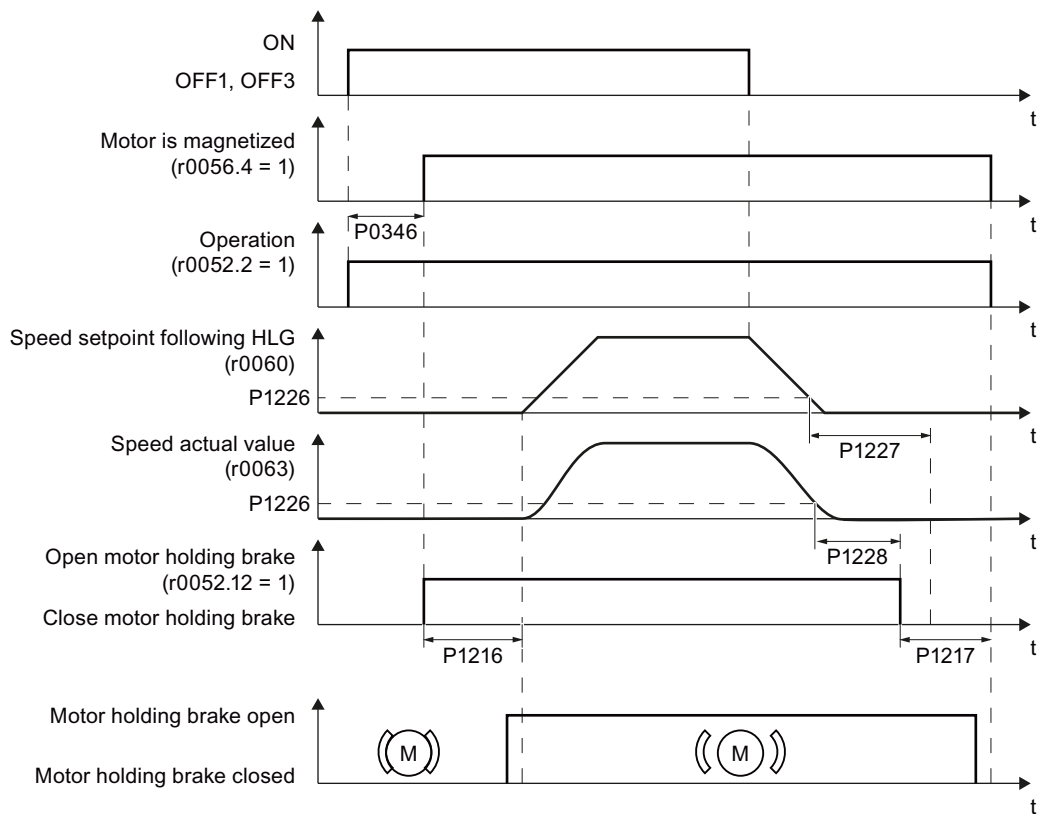

Figure 7-13 Function diagram of the motor holding brake control after an OFF1 or OFF3 command

The motor brake is controlled as shown in the following diagram:

1. After the ON command (switch on motor), the motor is magnetized. At the end of the magnetizing time (P0346) the inverter issues the command to open the brake.
2. The motor remains at a standstill until the end of the brake opening time P1216. The motor holding brake must open within this time.
3. At the end of the brake opening time the motor accelerates to its speed setpoint.
4. After the OFF command (OFF1 or OFF3) the motor brakes to a standstill.
5. If the speed setpoint and the current speed fall below threshold P1226, the monitoring time P1227 or P1228 is started.
6. As soon as the first of the two monitoring times (P1227 or P1228) has elapsed, the inverter issues the command to close the brake. The motor comes to a standstill but remains switched on.
7. At the end of the brake closing time P1217, the motor is switched off. The motor holding brake must close within this time.

Principle of operation after OFF2 or STO command

For the following signals, the brake closing time is not taken into account:

- OFF2 command
- For fail-safe applications, in addition, after "Safe Torque Off" (STO)

After these control commands, the signal to close the motor holding brake is immediately output independent of the motor speed. The inverter does not monitor the motor speed until the brake closes.

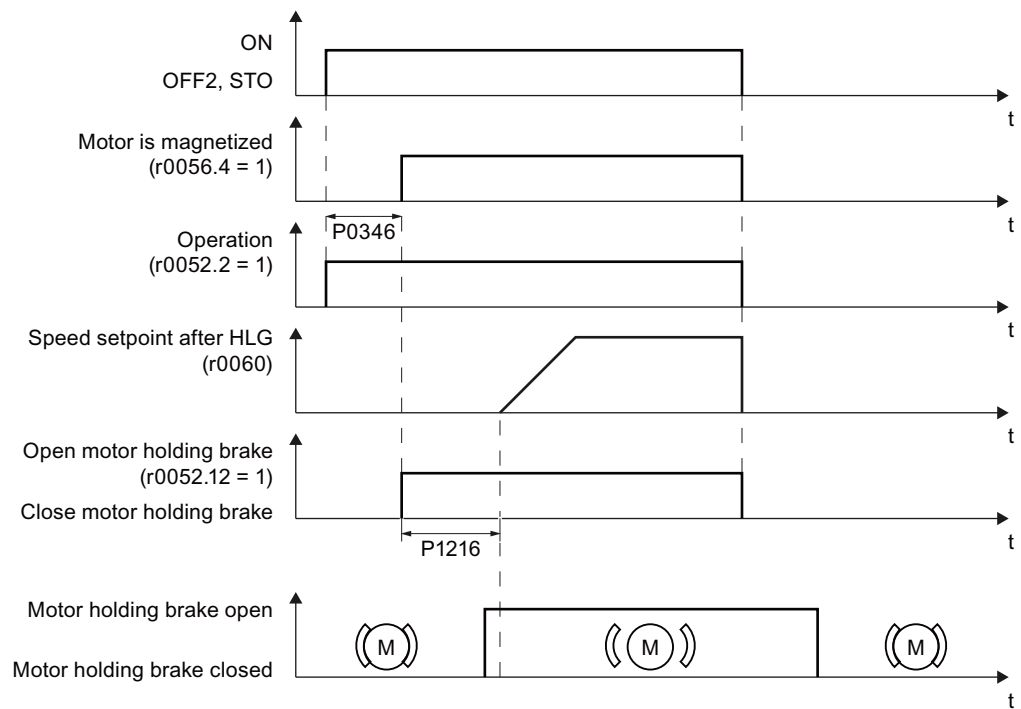

Figure 7-14 Function diagram of the motor holding brake control after an OFF2 or STO command

Commissioning

⚠ WARNING

The following applications require special settings of the motor holding brake. In these cases, the motor holding brake control may only be commissioned by experienced personnel:

- All applications that involve moving and transporting people
 - Hoisting gear
 - Elevators
 - Cranes
-
- Before commissioning, secure any dangerous loads (e.g. loads on inclined conveyors)
 - Suppress the motor holding brake control, e.g. by disconnecting the control cables
 - When opening the motor holding brake, ensure that a torque is established that prevents the load from briefly dropping.
 - Check the magnetizing time P0346; the magnetizing time is pre-assigned when commissioning the system and must be greater than zero
 - V/f control (P1300 = 0 to 3):
Set the boost parameters P1310 and P1311.
Define the motor torque when switching on using P1351 and P1352.
 - Vector control (P1300 ≥ 20):
Define the motor torque when switching on using P1475.
 - Assigning parameters for the opening and closing times of the motor holding brake.
It is extremely important that electromechanical brakes are controlled with the correct timing in order to protect the brakes against long-term damage. The exact values can be found in the technical data of the connected brake. Typical values:
 - Depending on the brake size, brake opening times lie between 25 ms and 500 ms.
 - Depending on the brake size, brake closing times lie between 15 ms and 300 ms.
 - Reestablish the control of the motor holding brake.
r0052.12 ("Motor holding brake open") controls the brake.

When a motor with a built-in holding brake is commissioned, a "clicking" sound in the motor indicates that the brake has been properly released.

Table 7- 31 Control logic parameters of the motor holding brake

Parameter	Description
P1215 = 1	Enable motor holding brake 0 Motor holding brake locked (factory setting) 1 Motor holding brake just like the sequence control 2: Motor holding brake permanently open 3: Motor holding brake just like the sequential control, connected via BICO
P1216	Motor holding brake opening time (factory setting 0.1 s) P1216 > Braking signal relay runtimes + Brake release time
P1217	Motor holding brake closing time (factory setting 0.1 s) P1217 > Braking signal relay runtimes + Brake closing time
P1226	Stationary state detection speed threshold (factory setting 20 1/min) When braking with OFF1 or OFF3, when the speed falls below this threshold, standstill is detected and the monitoring time P1227 or P1228 is started
r0052.12	"Open motor holding brake" status

Table 7- 32 Advanced settings

Parameter	Description
P0346	Magnetizing time (factory setting 0 s) During this time the induction motor is magnetized. The inverter calculates this parameter using P0340 = 1 or 3.
P0855	Open motor holding brake (imperative) (factory setting 0)
P0858	Close motor holding brake (imperative) (factory setting 0)
P1227	Stationary state detection monitoring time (factory setting 300 s)
P1228	Pulse deletion delay time (factory setting 0.01 s)
P1351	Starting frequency of motor holding brake (factory setting 0%) Setting the frequency set value at the slip compensation output when starting with motor holding brake. When the parameter p1351 is set to > 0, slip compensation is automatically switched on.
P1352	Starting frequency for motor holding brake (factory setting 1351) Setting the signal source for the frequency set value at the slip compensation output when starting with motor holding brake.
P1475	Speed controller torque set value for motor holding brake (factory setting 0) Setting the signal source for the torque set value when starting with motor holding brake.

7.9.2 Automatic restart and flying restart

7.9.2.1 Flying restart – switching on while the motor is running

If you switch on the motor while it is still running, then with a high degree of probability, a fault will occur due to overcurrent (overcurrent fault F07801). Examples of applications involving an unintentionally rotating motor directly before switching on:

- The motor rotates after a brief line interruption.
- A flow of air turns the fan impeller.
- A load with a high moment of inertia drives the motor.

After the ON command, the "flying restart" function initially synchronizes the inverter output frequency to the motor speed and then accelerates the motor up to the setpoint.

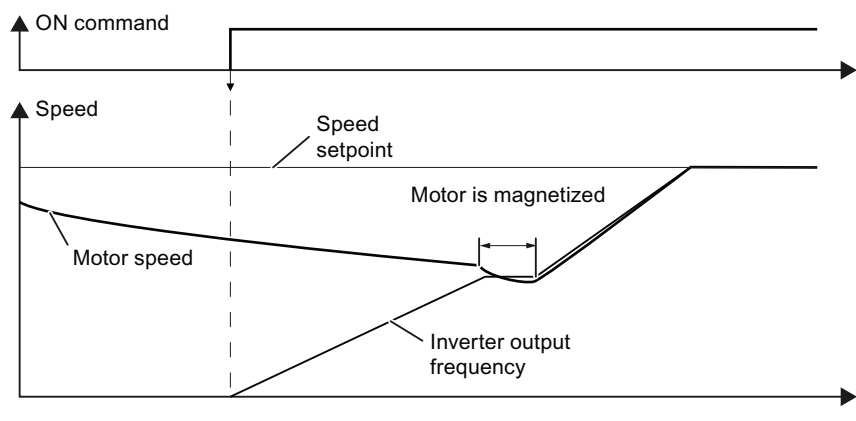

Figure 7-15 Principle of operation of the "flying restart" function

Setting "flying restart" function

If the inverter simultaneously drives several motors, then you must only use the "flying restart" function if the speed of all of the motors is always the same (group drive with a mechanical coupling).

Table 7- 33 Basic setting

Parameter	Description
P1200	Flying restart operating mode (factory setting: 0)
0	Flying restart is locked
1	Flying restart is enabled, look for the motor in both directions, start in direction of setpoint
4	Flying restart is enabled, only search in direction of setpoint

Table 7- 34 Advanced settings

Parameter	Description
P1201	Flying restart enable signal source (factory setting: 1) Defines a control command, e.g. a digital input, through which the flying restart function is enabled.
P1202	Flying restart search current (factory setting 100 %) Defines the search current with respect to the motor magnetizing current (r0331), which flows in the motor while the flying restart function is being used.
P1203	Flying restart search speed factor (factory setting 100 %) The value influences the speed with which the output frequency is changed during the flying restart. A higher value results in a longer search time. If the inverter does not find the motor, reduce the search speed (increase p1203).

7.9.2.2 Automatic switch-on

The automatic restart includes two different functions:

1. The inverter automatically acknowledges faults.
2. After a fault occurs or after a power failure, the inverter automatically switches-on the motor again.

This automatic restart function is primarily used in applications where the motor is controlled locally via the inverter's inputs. In applications with a connection to a fieldbus, the central control should evaluate the feedback signals of the drives, specifically acknowledge faults or switch-on the motor.

A power failure is defined by one of the two following events:

- The power supply of the Power Module has failed (fault F30003, undervoltage in the DC link).
- The 24 V power supply of the CU has failed.

⚠ WARNING

When the "automatic restart" function is active ($p1210 > 1$), the motor automatically starts after a power failure. This is especially critical after longer power failures.

Reduce the risk of accidents in your machine or system to an acceptable level by applying suitable measures, e.g. protective doors or covers.

Commissioning the automatic restart

- If it is possible that the motor is still rotating for a longer period of time after a power failure or after a fault, then in addition, you must activate the "flying restart" function, see Flying restart – switching on while the motor is running (Page 203).
- Using p1210, select the automatic restart mode that best suits your application.

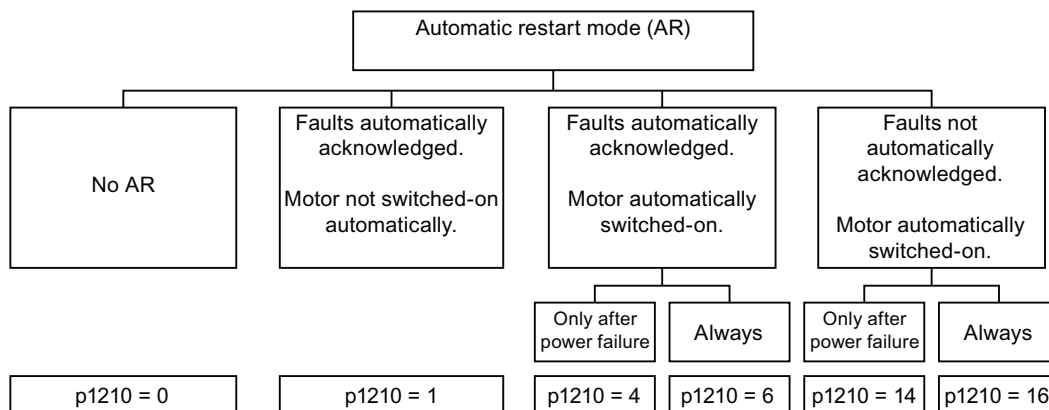
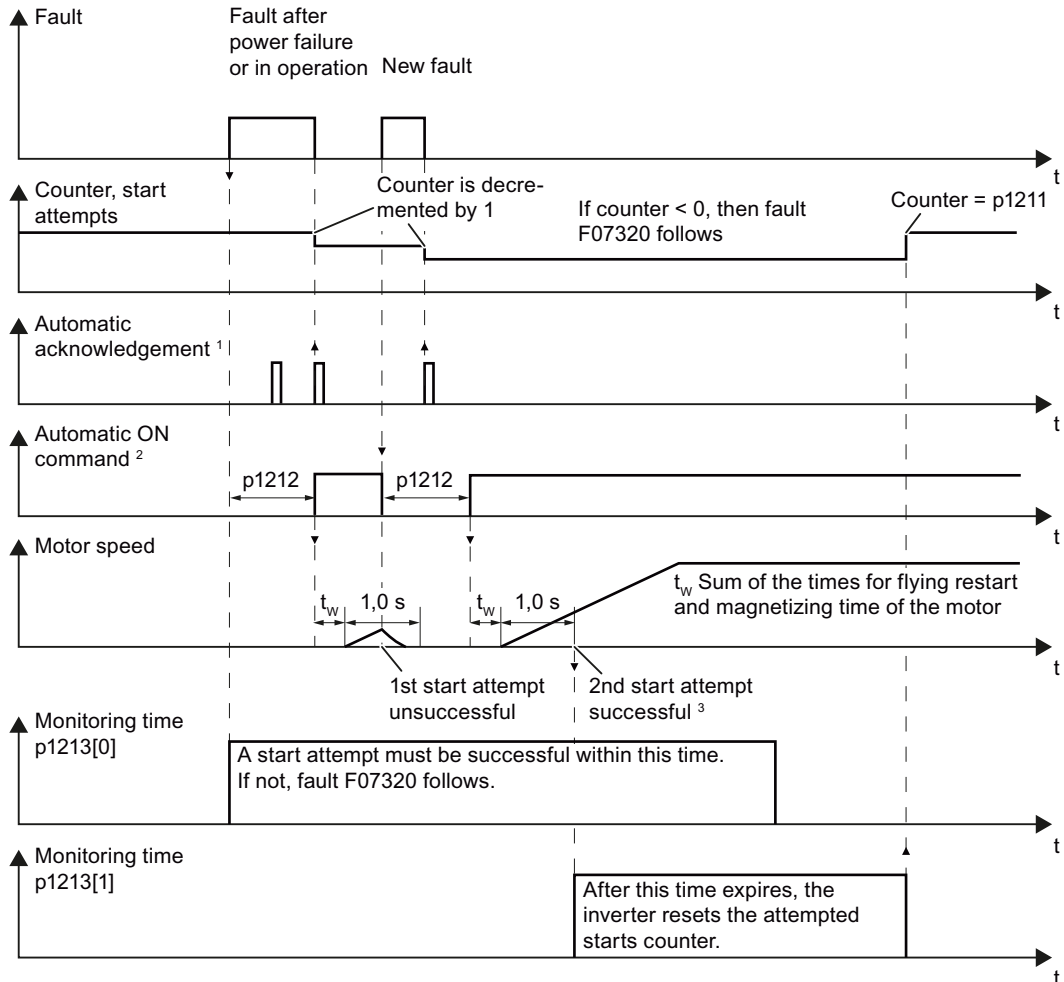

Figure 7-16 Selecting the automatic restart mode

- Set the parameters of the automatic restart function.
The method of operation of the parameters is explained in the following diagram and in the table.



¹ The inverter automatically acknowledges faults under the following conditions:

- p1210 = 1: always.
- p1210 = 4 or 6: If the command to switch-on the motor is available at a digital input or via the fieldbus (ON command = HIGH).
- p1210 = 14 or 16: never.

² The inverter attempts to automatically switch-on the motor under the following conditions:

- p1210 = 1: never.
- p1210 = 4, 6, 14 or 16: If the command to switch-on the motor is available at a digital input or via the fieldbus (ON command = HIGH).

³ The start attempt is successful if flying restart has been completed and the motor has been magnetized (r0056.4 = 1) and one additional second has expired without a new fault having occurred.

Figure 7-17 Time response of the automatic restart

Table 7- 35 Overview of parameters to set the automatic restart

Parameter	Explanation
p1210	<p>Automatic restart mode (factory setting: 0)</p> <p>0: Disable automatic restart 1: Acknowledge all faults without restarting 4: Restart after power failure without further restart attempts 6: Restart after fault with further restart attempts 14: Restart after power failure after manual fault acknowledgement 16: Restart after fault after manual fault acknowledgement</p>
p1211	<p>Automatic restart start attempts (factory setting: 3)</p> <p>This parameter is only effective for the settings p1210 = 4, 6, 14, 16.</p> <p>You define the maximum number of start attempts using p1211. After each successful fault acknowledgement, the inverter decrements its internal counter of start attempts by 1.</p> <p>For p1211 = n, up to n + 1 start attempts are made. Fault F07320 is output after n + 1 unsuccessful start attempts.</p> <p>The inverter sets the start attempt counter back again to the value of p1211, if one of the following conditions is fulfilled:</p> <ul style="list-style-type: none"> • After a successful start attempt, the time in p1213[1] has expired. • After fault F07320, withdraw the ON command and acknowledge the fault. • You change the start value p1211 or the mode p1210. • You switch-off the motor on (OFF command).
p1212	<p>Automatic restart wait time start attempt (factory setting: 1.0 s)</p> <p>This parameter is only effective if p1210 = 4, 6.</p> <p>Examples for setting this parameter:</p> <ol style="list-style-type: none"> 1. After a power failure, a certain time must elapse before the motor can be switched-on, e.g. because other machine components are not immediately ready. In this case, set p1212 longer than the time, after which all of the fault causes have been removed. 2. In operation, the inverter develops a fault condition. The lower you select p1212, then the sooner the inverter attempts to switch-on the motor again.

Parameter	Explanation
p1213[0]	<p>Automatic restart monitoring time for restart (factory setting: 60 s)</p> <p>This parameter is only effective for the settings p1210 = 4, 6, 14, 16.</p> <p>With this monitoring function, you limit the time in which the inverter may attempt to automatically switch-on the motor again.</p> <p>The monitoring function starts when a fault is identified and ends with a successful start attempt. If the motor has not successfully started after the monitoring time has expired, fault F07320 is signaled.</p> <p>Set the monitoring time longer than the sum of the following times:</p> <ul style="list-style-type: none"> + P1212 + time that the inverter requires to start the motor on the fly. + Motor magnetizing time (p0346) + 1 second <p>You deactivate the monitoring function with p1213 = 0.</p>
p1213[1]	<p>Automatic restart monitoring time to reset the fault counter (factory setting: 7200 s)</p> <p>This parameter is only effective for the settings p1210 = 4, 6, 14, 16.</p> <p>Using this monitoring time, you prevent that faults, which continually occur within a certain time period, are automatically acknowledged each time.</p> <p>The monitoring function starts with a successful start attempt and ends after the monitoring time has expired.</p> <p>If the inverter has made more than (p1211 + 1) successful start attempts within monitoring time p1213[1], the inverter cancels the automatic restart function and signals fault F07320. In order to switch on the motor again, you must acknowledge the fault and issue a new ON command.</p>

Additional information is provided in the parameter list of the List Manual.

Advanced settings

If you wish to suppress the automatic restart function for certain faults, then you must enter the appropriate fault numbers in p1206[0 ... 9].

Example: P1206[0] = 07331 ⇒ No restart for fault F07331.

Suppressing the automatic restart only functions for the setting p1210 = 6 or 16.

 WARNING
<p>In the case of communication via the field bus interface, the motor restarts with the setting p1210 = 6 even if the communication link is interrupted. This means that the motor cannot be stopped via the open-loop control. To avoid this dangerous situation, you must enter the fault code of the communications error in parameter p1206.</p> <p>Example: A communication failure via PROFIBUS is signaled using fault code F01910. You should therefore set p1206[n] = 1910 (n = 0 ... 9).</p>

7.9.3 PID technology controller

The technology controller permits all types of simple process controls to be implemented. You can use the technology controller for e.g. pressure controllers, level controls or flow controls.

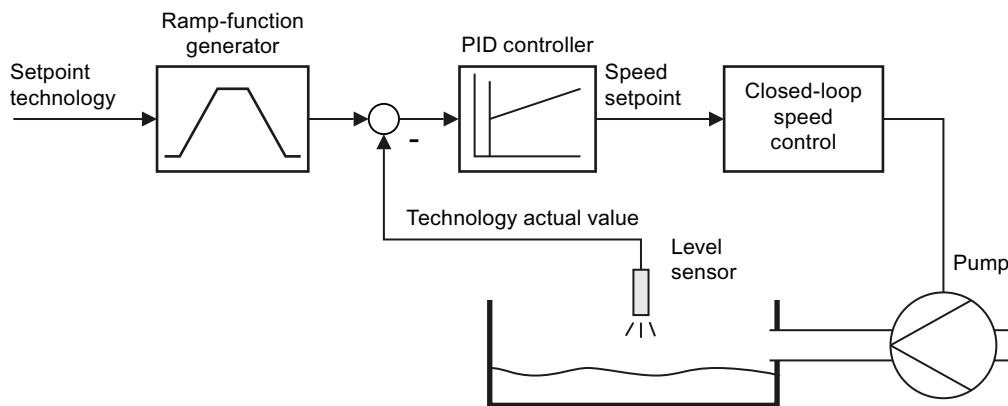

Figure 7-18 Example: technology controller as a level controller

Principle of operation

The technology controller specifies the speed setpoint of the motor in such a way that the process variable to be controlled corresponds to its setpoint. The technology controller is designed as a PID controller, which makes it highly flexible.

The technology controller setpoint is entered via an analog input or via the fieldbus.

Table 7- 36 Technology controller parameters

Parameter	Description
P2200 = ...	Enable technology controller
P2201 ... r2225	Fixed speeds for the technology controller
P2231 ... P2248	Motorized potentiometer for the technology controller
P2251 ... r2294	General adjustment parameters of the technology controller
P2345 = ...	Changing the fault reaction for the technology controller

Additional information about this function is provided in the parameter list and in the function diagrams 7950 ... 7958 in the List Manual.

7.9.4 Logical and arithmetic functions using function blocks

Additional signal interconnections in the inverter can be established by means of free function blocks. Every digital and analog signal available via BICO technology can be routed to the appropriate inputs of the free function blocks. The outputs of the free function blocks are also interconnected to other functions using BICO technology.

Among others, the following free function blocks are available:

- Logic modules AND, OR, XOR, NOT
- Arithmetic blocks ADD, SUB, MUL, DIV, AVA (device for forming absolute values), NCM (numeric comparator), PLI (polyline)
- Time modules MFP (pulse generator), PCL (pulse shortening), PDE (ON delay), PDF (OFF delay), PST (pulse stretching)
- Memories: RSR (RS flip-flop), DSR (D flip-flop)
- Switches NSW (numeric change-over switch) BSW (binary change-over switch)
- Controllers LIM (limiter), PT1 (smoothing element), INT (integrator), DIF (differentiating element)
- Limit value monitoring LVM

You will find an overview of all of the free function blocks and their parameters in the List Manual, in Chapter "Function diagrams" in the section "Free function blocks" (function diagrams 7210 ff).

Activating the free blocks

None of the free function blocks in the inverter are used in the factory setting. In order to be able to use a free function block, you must perform the following steps:

- In the parameter list, select the function block from the function diagrams - there you will find all of the parameters that you require to interconnect the block
- Assign the block to a runtime group
- Define the run sequence within the runtime group - this is only required if you have assigned several blocks to the same runtime group.
- Interconnect the block's inputs and outputs with the corresponding signals on the inverter.

The runtime groups are calculated at different intervals (time slices). Please refer to the following table to see which free function blocks can be assigned to which time slices.

Table 7- 37 Runtime groups and possible assignments of the free function blocks

Free function blocks	Runtime groups 1 ... 6 with associated time slices					
	1	2	3	4	5	6
	8 ms	16 ms	32 ms	64 ms	128 ms	256 ms
Logic modules AND, OR, XOR, NOT	✓	✓	✓	✓	✓	✓
Arithmetic blocks ADD, SUB, MUL, DIV, AVA, NCM, PLI	-	-	-	-	✓	✓
Time modules MFP, PCL, PDE, PDF, PST	-	-	-	-	✓	✓
Memories RSR, DSR	✓	✓	✓	✓	✓	✓
Switches NSW	-	-	-	-	✓	✓
Switches BSW	✓	✓	✓	✓	✓	✓
Controllers LIM, PT1, INT, DIF	-	-	-	-	✓	✓
Limit value monitoring LVM	-	-	-	-	✓	✓

✓: The block can be assigned to the runtime group
 -: The block cannot be assigned to this runtime group

Analog signal scaling

If you interconnect a physical quantity, e.g. speed or voltage to the input of a free function block using BICO technology, then the signal is automatically scaled to a value of 1. The analog output signals of the free function blocks are also available as scaled quantities (0 \triangleq 0 %, 1 \triangleq 100 %).

As soon as you have interconnected the scaled output signal of a free function block to functions, which require physical input quantities - e.g. the signal source of the upper torque limit (p1522) - then the signal is automatically converted into the physical quantity.

The quantities with their associated scaling parameters are listed in the following:

- Speeds P2000 Reference speed (\triangleq 100 %)
- Voltage values P2001 Reference voltage (\triangleq 100 %)
- Current values P2002 Reference current (\triangleq 100 %)
- Torque values P2003 Reference torque (\triangleq 100 %)
- Power values P2004 Reference power (\triangleq 100 %)
- Angle P2005 Reference angle (\triangleq 100 %)
- Acceleration P2007 Reference acceleration (\triangleq 100 %)
- Temperature 100 °C \triangleq 100 %

Scaling examples

- Speed:
Reference speed p2000 = 3000 rpm, actual speed 2100 rpm. As a consequence, the following applies to the scaled input quantity: $2100 / 3000 = 0.7$.
- Temperature:
Reference quantity is 100 °C. For an actual temperature of 120 °C, the input value is obtained from $120 \text{ °C} / 100 \text{ °C} = 1.2$.

Note

Limits within the function blocks should be entered as scaled values. The scaled value can be calculated as follows using the reference parameter: Scaled limit value = physical limit value / value of the reference parameter.

The assignment to reference parameters is provided in the parameter list in the individual parameter descriptions.

Example: Logic combination of two digital inputs

You want to switch on the motor via digital input 0 and also via digital input 1:

1. Activate a free OR block by assigning it to a runtime group, and define the run sequence.
2. Interconnect the status signals of the two digital inputs DI 0 and DI 1 via BICO to the two inputs of the OR block.
3. Finally, interconnect the OR block output with the internal ON command (P0840).

Table 7- 38 Parameters for using the free function blocks

Parameter	Description
P20048 = 1	Assignment of block OR 0 to runtime group 1 (factory setting: 9999) The block OR 0 is calculated in the time slice with 8 ms
P20049 = 60	Definition of run sequence within runtime group 1 (factory setting: 60) Within one runtime group, the block with the smallest value is calculated first.
P0701 = 0	Pre-assignment of digital input 0 (factory setting: 1) Delete pre-assignment of digital input 0 to allow for interconnection via BICO
P0702 = 0	Pre-assignment of digital input 1 (factory setting: 12) Delete pre-assignment of digital input 1 to allow for interconnection via BICO
P20046 [0] = 722.0	Interconnection of first OR 0 input (factory setting: 0) The first OR 0 input is linked to digital input 0 (r0722.0)
P20046 [1] = 722.1	Interconnection of second OR 0 input (factory setting: 0) The second OR 0 input is linked to digital input 1 (r0722.1)
P0840 = 20047	Interconnection of OR 0 output (factory setting: 0) The OR 0 output (r20047) is connected with the motor's ON command

Example: AND operation

An example of an AND logic operation, explained in detail, including the use of a time block is provided in the BICO technology: example (Page 22)chapter.

You can find additional information in the following manuals:

- Function Manual "Description of the Standard DCC Blocks"
(<http://support.automation.siemens.com/WW/view/en/29193002>)
- Function Manual "Free Function Blocks"
(<http://support.automation.siemens.com/WW/view/en/35125827>)

7.10 Safe Torque Off (STO) safety function

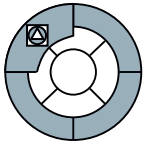

These operating instructions describe the commissioning of the STO safety function when it is controlled via a fail-safe digital input.

You will find a detailed description of all safety functions and control using PROFIsafe in the Safety Integrated Function Manual, see Section Overview of documentation (Page 13).

Note

We strongly recommend commissioning the safety functions exclusively with the STARTER commissioning tool.

7.10.1 Prerequisite for STO use

In order to use the STO safety function, your machine should have already performed a risk assessment (e.g. in compliance with EN ISO 1050, "Safety of machinery - Risk assessment - Part 1: Principles"). The risk assessment must confirm that the inverter is permitted for use in accordance with SIL 2 or PL d.

7.10.2 Permitted sensors

The fail-safe inputs of the inverter are designed for connecting sensors with two NC contacts.

It is not possible to directly connect sensors with two NO contacts and antivalent contacts (1 NO contact and 1 NC contact).

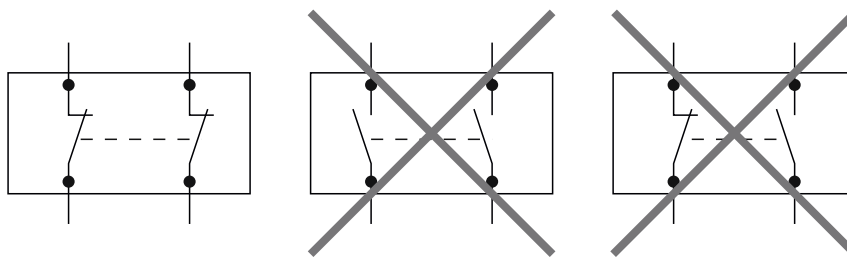

Figure 7-19 Sensors that can be connected to the fail-safe inputs

The fail-safe digital inputs are configured for both directly connecting safety sensors, e.g. emergency stop control devices or light curtains, as well as for connecting pre-processing safety relays, e.g. fail-safe controls.

On the following pages, you will find examples of interconnecting the fail-safe digital input from "Basic safety", in accordance with PL d to EN 13849-1 and SIL2 to IEC 61508. You can find further examples and information in the Safety Integrated Function Manual.

7.10.3 Connecting fail-safe digital inputs

On the following pages, you will find examples of connecting the fail-safe digital input from "Basic safety", in accordance with PL d according to EN 13849-1 and SIL2 according to IEC 61508 for the case that all of the components are installed in a control cabinet.

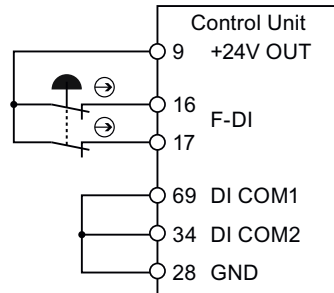

Figure 7-20 Connecting a sensor, e.g. Emergency Stop mushroom pushbutton or limit switch

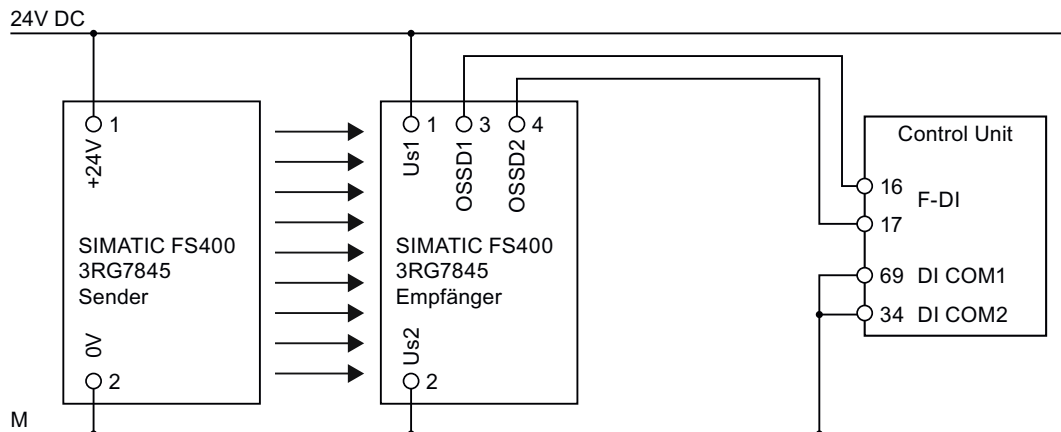

Figure 7-21 Connecting an electronic sensor, e.g. SIMATIC FS-400 light curtain

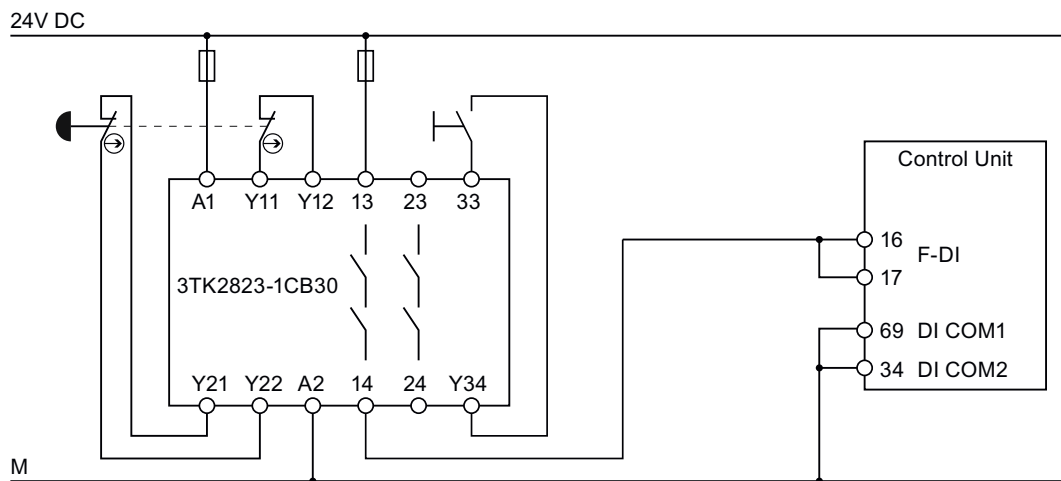

Figure 7-22 Connecting a safety relay, e.g. SIRIUS 3TK28

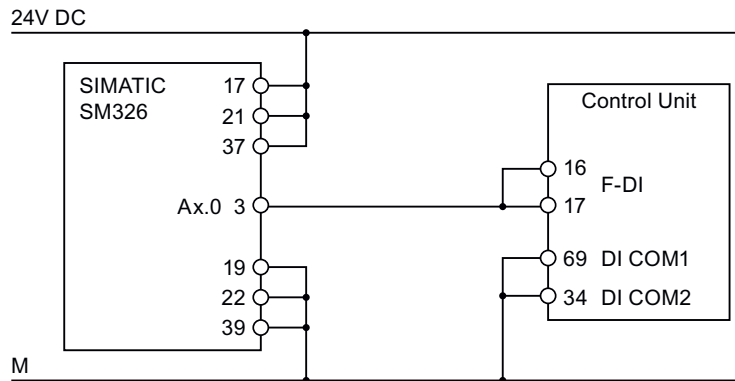

Figure 7-23 Connecting an F digital output module, e.g. SIMATIC F digital output module

You can find additional connection options and connections in separate control cabinets in the Safety Integrated Function Manual, see Section Overview of documentation (Page 13).

7.10.4 F-DI signal filtering

The inverter checks the signals of the fail-safe digital input for consistency. Consistent signals at both inputs always assume the same signal state (high or low).

Discrepancy

With electromechanical sensors (e.g. emergency stop buttons or door switches), the two sensor contacts never switch at exactly the same time and are therefore temporarily inconsistent (discrepancy). A long-term discrepancy points toward a fault in the wiring of a fail-safe input, e.g. a wire break.

An adjustable filter in the inverter prevents faults caused by temporary discrepancy. Within the filter tolerance time (parameters p9650 and p9850), the inverter suppresses the discrepancy monitoring of the fail-safe inputs.

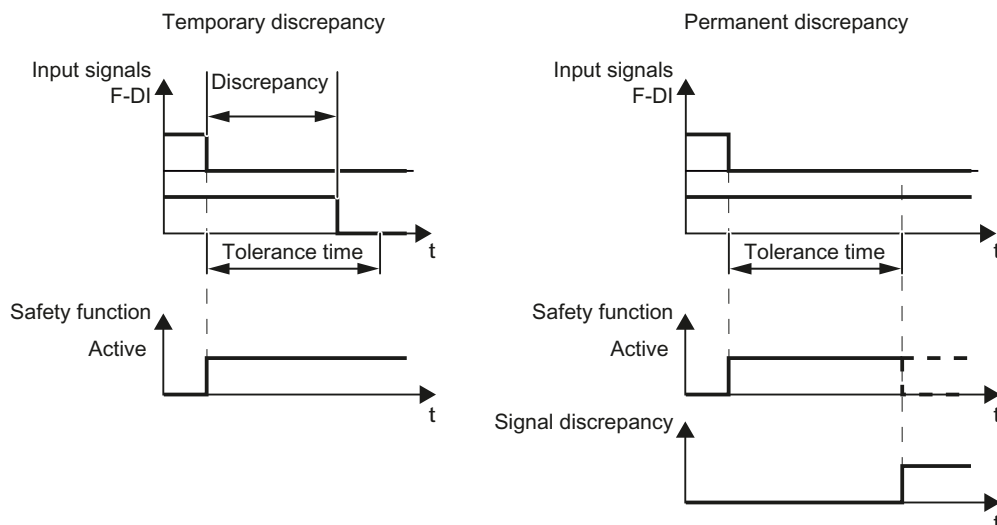

Figure 7-24 Filter for suppressing discrepancy monitoring

The filter does not increase the inverter response time. The inverter activates its safety functions as soon as one of the two F-DI signals changes its state from high to low.

Bit pattern test of fail-safe outputs and contact bounces of sensors

The inverter normally responds immediately to signal changes at its fail-safe input. This is not required in the following cases:

1. When you interconnect the fail-safe input of the inverter with an electromechanical sensor, contact bounce may result in signal changes occurring, to which the inverter responds.
2. Several control modules test their fail-safe outputs using bit pattern tests (on/off tests), in order to identify faults due to either short or cross circuiting. When you interconnect the fail-safe input of the inverter with a fail-safe output of a control module, the inverter responds to these test signals.

A signal change during a bit pattern test usually lasts 1 ms.

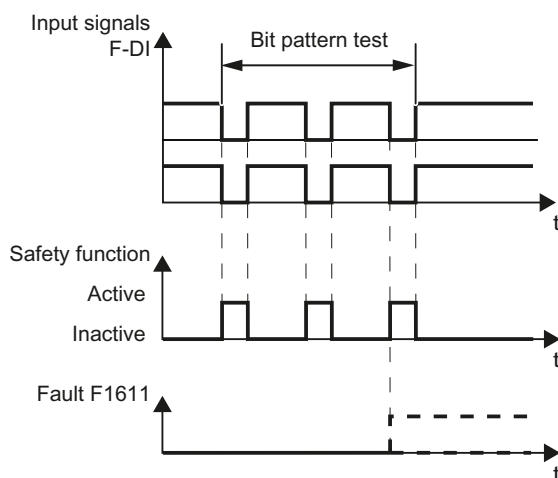

Figure 7-25 Inverter response to a bit pattern test

7.10 Safe Torque Off (STO) safety function

If the signal to control STO is not "stable", then the inverter responds with a fault.
 (Definition of a stable signal: Following a change to the F-DI input signals, the inverter triggers an internal monitoring time. Up until the end of the time interval $5 \times p9650$, both input signals must have a constant signal level. A constant signal level is a high or a low state, for a period of at least $p9650$).

An adjustable signal filter in the inverter suppresses temporary signal changes using bit pattern test or contact bounce.

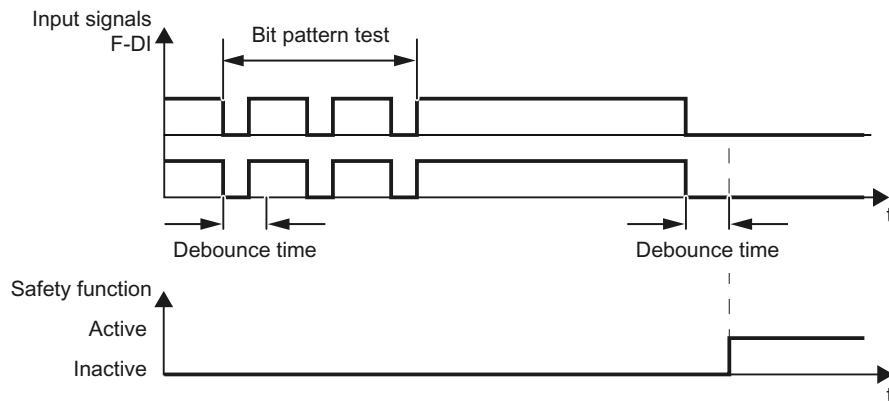

Figure 7-26 Filter for suppressing temporary signal changes

Note

The filter increases the inverter response time. The inverter only activates its safety function after the debounce time has elapsed (parameters $p9651$ and $p9851$).

Note

Debounce times for standard and safety functions

The debounce time $p0724$ for "standard" digital inputs has no influence over the fail-safe input signals. Conversely, the same applies: The F-DI debounce time does not influence the signals of the "standard" inputs.

If you use an input as a standard input, set the debounce time at $p0724$.

If you use an input as fail-safe input, set the debounce time as described above.

7.10.5 Forced dormant error detection

To fulfill the requirements of standards EN 954-1, ISO 13849-1 and IEC 61508 regarding timely error detection, the inverter must regularly test its safety-relevant circuits to ensure that they function correctly - this must be performed at least once every year.

Forced dormant error detection (test stop)

After the power supply has been connected, the inverter checks its circuits to switch-off the torque each time the STO function is selected.

The inverter monitors the regular test of its safety-relevant circuits using a time module.

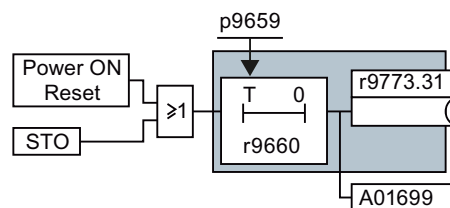

Figure 7-27 Forced dormant error detection monitoring

r9660 contains the remaining time until the monitoring responds. The inverter signals Alarm A01699 after the monitoring time expires.

You define the monitoring time while commissioning the system depending on your particular application.

Examples for the times when forced dormant error detection is performed:

- When the drives are at a standstill after the system has been switched on.
- When the protective door is opened.
- At defined intervals (e.g. every 8 hours).
- In automatic mode (time and event dependent).

If alarm A01699 signals that the monitoring time has expired, then you must initiate the forced dormant error detection at the next opportunity. These alarms do not affect the operation of your machine.

7.10.6 Password

The safety functions are protected against unauthorized changes by a password.

Note

If you want to change the parameters of the safety functions, but do not know the password, please contact customer support.

The factory setting for the password is "0". During commissioning, choose your password from the permissible range 1 ... FFFF FFFF.

7.10.7 Commissioning the STO

Procedure

- Go online with STARTER.
- In STARTER, call up the screens displaying the fail-safe functions and click on "Change settings":

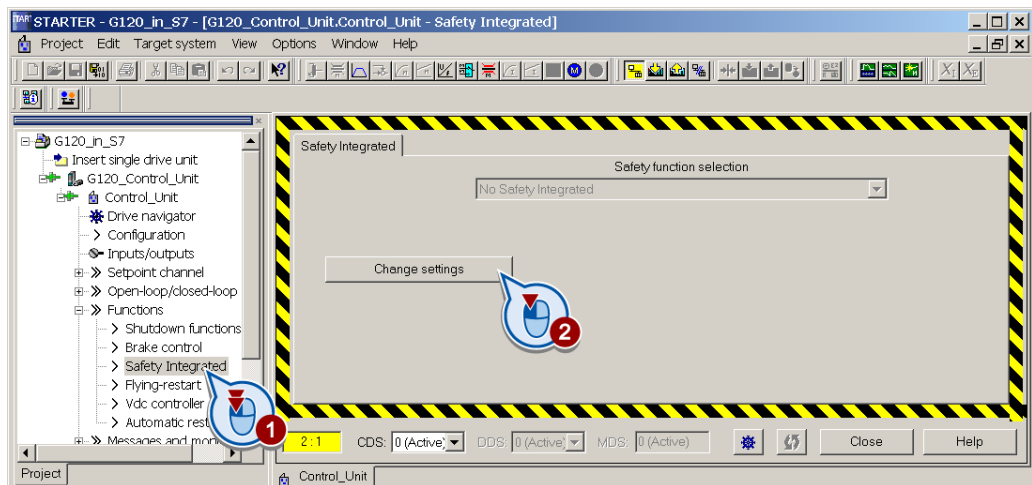

7.10.7.1 Defining commissioning method

- Select "STO via terminal".

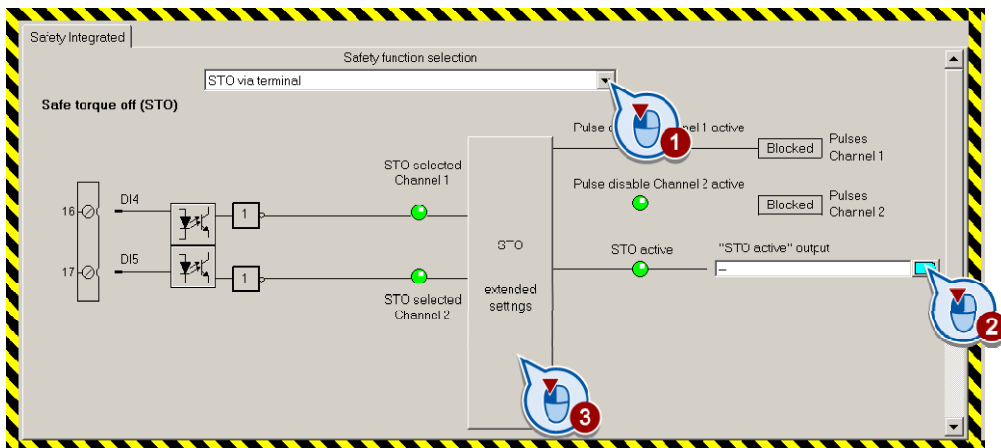

- If you require the status signal "STO active" in your higher-level controller, interconnect it accordingly.
- Click the button to call up the advanced settings for STO.

7.10.7.2 Assigning parameters to the STO

- You can adapt the STO function according to your requirements in the following screen.

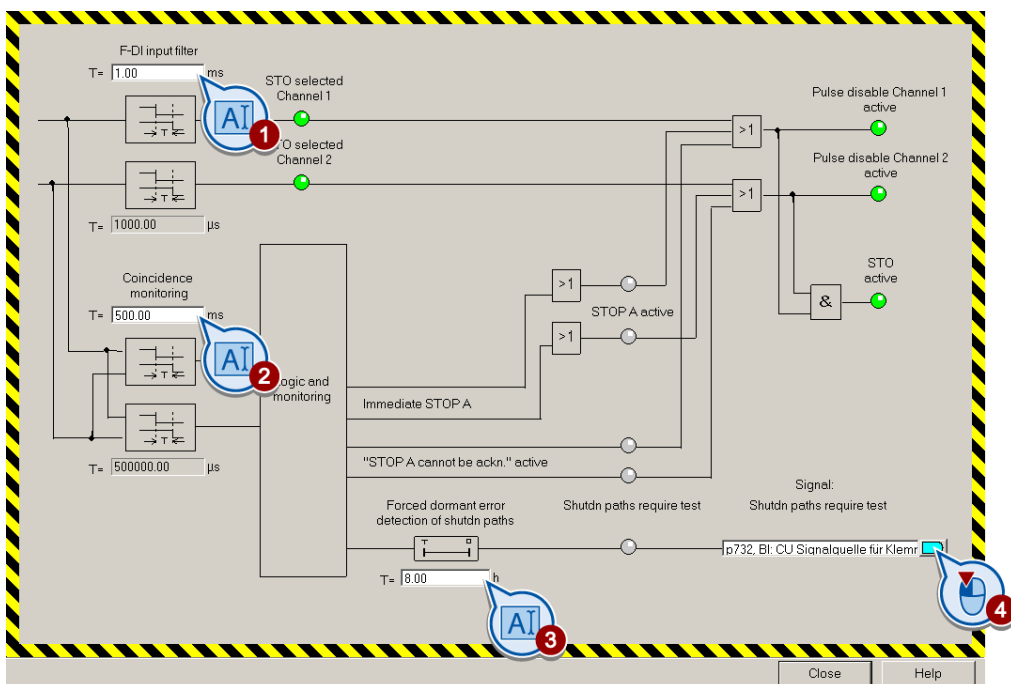

7.10 Safe Torque Off (STO) safety function

- Set the following in the above screen:
 - ① ② **F-DI input filter (debounce time) and monitoring for simultaneous operation (discrepancy):**
The method of functioning of the two filters is described in the section entitled F-DI signal filtering (Page 216).
 - ③ ④ **Time interval for forced dormant error detection:**
Information regarding forced dormant error detection can be found in the Forced dormant error detection (Page 219) section.
- Close the screen.

7.10.7.3 Activate settings

- Click "Copy parameters" and then click "Activate settings":

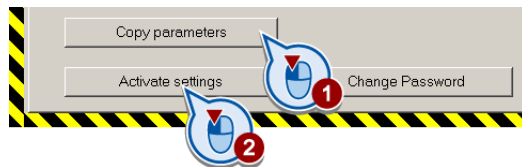

- If the password = 0 (factory setting), follow the prompts in order to set a password. If you try to set a password that is not permissible, the old password will not be changed. Further information can be found in the section Password (Page 220).
- Confirm the prompt for saving your settings (copy RAM to ROM).
- Switch off the Control Unit power supply for approximately 10 seconds (Power ON Reset). Only then will your changes become effective.

7.10.7.4 Multiple assignment of the DI

- Check whether the digital inputs used as fail-safe input are also assigned a further function.

NOTICE
Both, the assignment of digital inputs with the selection of a safety function or with a "standard" function can lead to an unexpected behavior of the motor.

- Remove multiple assignments of the digital inputs:

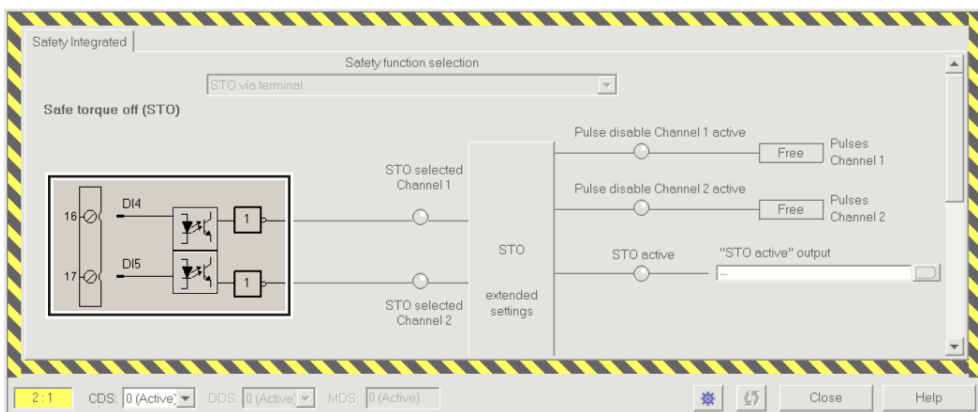

Figure 7-28 Example: automatic assignment of digital inputs DI 4 and DI 5 with STO

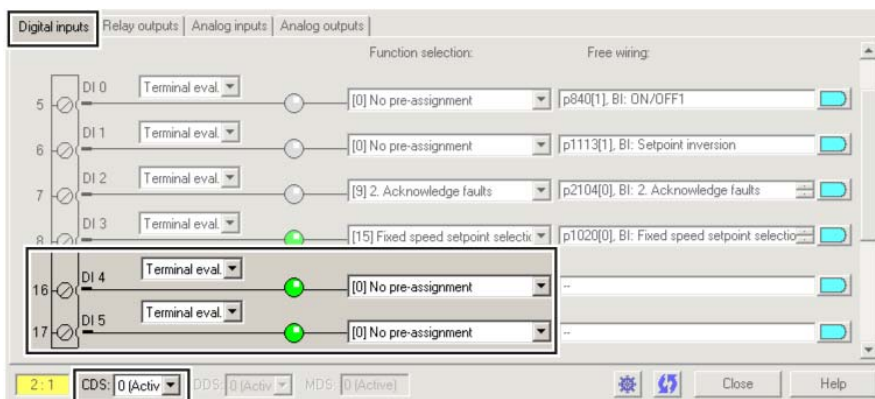

Figure 7-29 Remove pre-assignment of digital inputs DI 4 and DI 5

- When you use the data set changeover CDS, you must delete the multiple assignment of the digital inputs for all CDS.

7.10.8 Acceptance test - following completion of commissioning

7.10.8.1 Prerequisites and authorized persons

Requirements for acceptance tests are derived from the EC Machinery Directive and ISO 13849-1.

- Check the safety-related functions and machine parts following commissioning.
- Issue an "Acceptance certificate" which describes the test results.

Prerequisites for the acceptance test

- The machine is properly wired.
- All safety equipment such as protective door monitoring devices, light barriers or emergency-off switches are connected and ready for operation.
- Commissioning of the open-loop and closed-loop control must be complete. These include, for example:
 - Configuration of the setpoint channel.
 - Position control in the higher-level controller.
 - Drive control.

Authorized persons

Authorization within the scope of the acceptance test is a person authorized by the machine manufacturer who, on account of his or her technical qualifications and knowledge of the safety functions, is in a position to perform the acceptance test in the correct manner.

7.10.8.2 Complete acceptance test

A complete acceptance test includes the following:

1. Documentation
 - Description of the machines and overview/block diagram
 - Safety functions of the drive
 - Description of safety equipment
2. Function test
 - Test of the shutdown paths
 - Test of safety functions used
3. Conclusion of the report
 - Inspection of safety function parameters
 - Recording of the checksums
 - Verify the data backup
 - Countersignatures

7.10.8.3 Reduced acceptance test

A complete acceptance test is only necessary following first commissioning. An acceptance test with a reduced scope is sufficient for expansions of safety functions.

The reduced acceptance tests must be carried out separately for each individual drive, as far as the machine allows.

Reduced acceptance test for function extensions

Table 7- 39 Scope of the acceptance test depending on specific measures

Measure	Acceptance test		
	Documentation	Function test	Completion of the certificate
Replacing the Control Unit or the Power Modules.	Supplement: <ul style="list-style-type: none"> • Hardware data • Configuration • Firmware Versions 	Yes.	Supplement: <ul style="list-style-type: none"> • New checksums and countersignature
Hardware replacement of safety-related distributed I/O devices (e.g. emergency off switch).	Supplement: <ul style="list-style-type: none"> • Hardware data • Configuration • Firmware Versions 	Partially. Limitation to replaced components.	No.
Firmware - upgrading the Control Unit.	Supplement: <ul style="list-style-type: none"> • Version data • New safety functions 	Yes.	Supplement: <ul style="list-style-type: none"> • New checksums and countersignature.
Functional expansion of the machine (additional drive).	Supplementary safety functions for each drive and function table.	Yes. Testing the additional functions.	Supplement: <ul style="list-style-type: none"> • New checksums and countersignature.
Functional expansion of a drive (e.g. enable STO).	Supplement to the safety functions for each drive and function table.	Yes. Testing the additional functions.	Supplement. <ul style="list-style-type: none"> • New checksums and countersignature.
Transfer of inverter parameters to other identical machines by means of series commissioning.	Supplement to the machine description (checking of the firmware versions).	No.	No, if data are identical (checking of checksums).

7.10.8.4 Documentation

Machine overview

Enter your machine's data into the following table.

Designation	...
Type	...
Serial number	...
Manufacturer	...
End customer	...
Overview image of the machine: <div style="text-align: center;"> <p>...</p> <p>...</p> <p>...</p> <p>...</p> <p>...</p> <p>...</p> <p>...</p> <p>...</p> </div>	

Inverter hardware and firmware versions

Document the firmware version for each safety-related inverter of your machine.

Labeling the drive	MLFB of the Control Unit and Power Module	Firmware version of the Control Unit	Version of the safety functions			
			r9770[0]	r9770[1]	r9770[2]	r9770[3]
(Drive 1)	...	r0018 = ...	r9870[0]	r9870[1]	r9870[2]	r9870[3]
			r9390[0]	r9390[1]	r9390[2]	r9390[3]
			r9590[0]	r9590[1]	r9590[2]	r9590[3]
(Drive 2)	...	r0018 = ...	r9770[0]	r9770[1]	r9770[2]	r9770[3]
			r9870[0]	r9870[1]	r9870[2]	r9870[3]
			r9390[0]	r9390[1]	r9390[2]	r9390[3]
			r9590[0]	r9590[1]	r9590[2]	r9590[3]

Function table

Fill in the following table for your machine.

Mode of operation	Safety device	Drive	Controlling the safety function	Status of the safety function
...
...

Table 7- 40 Example:

Mode of operation	Safety device	Drive	Controlling the safety function	Status of the safety function
Production	Protective door closed and locked	1 2	- -	not active not active
	Protective door unlocked	1 2	F-DI 0 PROFIsafe	STO active STO active
Setup	Protective door closed and locked	1 2	- PROFIsafe	not active STO active
	Protective door unlocked	1 2	F-DI 0 PROFIsafe	STO active STO active

The following is checked during the function test:

- The hardware is functioning properly.
- The digital inputs of the inverter are assigned correctly for the safety function.
- The PROFIsafe address of the inverter is set correctly.
- The safety function is parameterized correctly.
- Routine for forced dormant error detection of the switch-off signal paths on the Control Unit.

Note

Perform the acceptance test with the maximum possible speed and acceleration.

Procedure

Table 7- 41 "Safe Torque Off" (STO) function

No.	Description	Status
1.	Initial state:	
	• The inverter is in "Ready" state (p0010 = 0).	
	• The inverter indicates neither faults nor alarms for safety functions (r0945, r2122, r2132).	
	• STO is not active.	

7.10 Safe Torque Off (STO) safety function

No.	Description	Status
2.	Switch on the motor (ON command).	
3.	Ensure that the correct motor is running.	
4.	Select STO while the motor is running Note: Test each configured activation, e.g. via digital inputs and PROFIsafe.	
5.	Check the following:	
	<ul style="list-style-type: none"> If a mechanical brake is not available, the motor coasts down. A mechanical brake brakes the motor and holds it to ensure that it remains at a standstill. The inverter indicates neither faults nor alarms for safety functions. 	
	<ul style="list-style-type: none"> The inverter indicates: "STO is selected" (r9773.0 = 1). "STO is active" (r9773.1 = 1). 	
6.	Deselect STO.	
7.	Check the following:	
	<ul style="list-style-type: none"> The inverter indicates neither faults nor alarms for safety functions. The inverter indicates: "STO is not selected" (r9773.0 = 0). "STO is not active" (r9773.1 = 0). 	
	<ul style="list-style-type: none"> The inverter is in "Closing lockout" state (p0046.0 = 1). 	
8.	Switch the motor off (OFF1 command) and then on again (ON command).	
9.	Ensure that the correct motor is running.	

7.10.8.5 Completion of the certificate

Document your machine's data for each drive based on the following specifications.

Parameters of the safety functions

The function test does not detect all faults in the parameter assignment of safety functions, e.g. forced dormant error detection time or filtering time of fail-safe inputs. Therefore, check all parameters once more.

Labeling the drive	All parameter values checked
...	
...	

Checksums of the safety functions

The inverter calculates checksums across all parameters and safety functions. The parameters of Basic Safety and Extended Safety have their own checksums.

When you change the safety function settings, the inverter calculates new checksums. This means that subsequent changes in your machine can be tracked.

In addition to the individual checksums of the parameters, the inverter calculates and saves the following values:

1. The "total" checksum across all checksums.
2. Time of the last parameter changed.

Labeling the drive	Checksums			
	Processor 1	Processor 2	Total	Time stamp
...	p9798	p9898	r9781[0]	r9782[0]
...	p9799	p9899		
...	p9798	p9898	r9781[0]	r9782[0]
...	p9799	p9899		

Data backup

	Storage medium			Holding area
	Type	Designation	Date	
Parameter				
PLC program				
Circuit diagrams				

Countersignatures

Commissioning engineer

This confirms that the tests and checks have been carried out properly.

Date	Name	Company/dept.	Signature

Machine manufacturer

This confirms that the parameters recorded above are correct.

Date	Name	Company/dept.	Signature

7.11 Switchover between different settings

7.11.1 Changing over the command data sets (manual, automatic)

Switching over master control

In some applications, the inverter is operated from different locations.

Example: Switchover from the automatic mode into the manual mode

A central control can switch a motor on/off or change its speed either via a fieldbus or via local switches. A key-operated switch close to the motor can be used to switch the master control of the inverter from "control via fieldbus" to "local control".

Command data set (CDS)

The inverter offers options to parameterize the settings for the command sources, setpoint sources and status messages (with the exception of analog outputs) in up to four different ways. The associated parameters are indexed (index 0, 1, 2 or 3). When the inverter is operational, control commands select one of the four indices and therefore one of the four settings that has been saved. This means that as described in the example above, the master control of the inverter can be switched over.

All of the switchable parameters for command sources, setpoint sources and status messages with the same index are known as a "command data set".

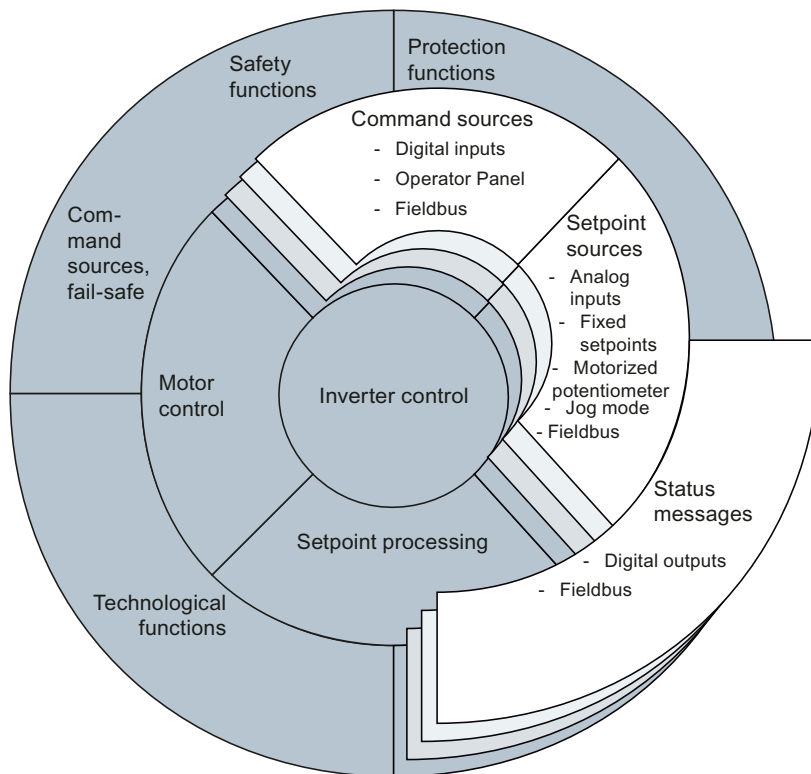

Figure 7-30 CDS switchover in the inverter

Use parameter P0170 to define the number of command data sets (2, 3 or 4).

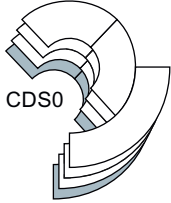
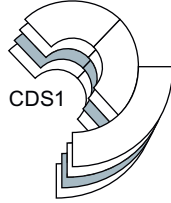
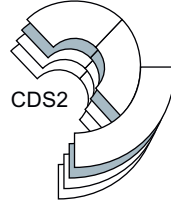

Table 7- 42 Selecting the number of command data sets

Parameter	Description
P0010 = 15	Drive commissioning: Data sets
P0170	Number of command data sets (factory setting: 2) P0170 = 2, 3 or 4
P0010 = 0	Drive commissioning: Ready

The command data sets are switched over using parameters P0810 and P0811. Parameters P0810 and P0811 are interlinked to control commands, e.g. the digital inputs of the inverter, using BICO technology.

7.11 Switchover between different settings

Table 7- 43 Command data set changeover using parameters P0810 and P0811.

Status of binector P0810	0	1	0	1
Status of binector P0811	0	0	1	1
The command data set that is presently active has a gray background.			 CDS2 is only available when P0170 = 3 or 4	 CDS3 is only available when P0170 = 4
Selected parameter index	0	1	2	3
Examples	Fieldbus as setpoint source: The speed setpoint is specified via the fieldbus.	Analog input as setpoint source: The speed setpoint is specified via an analog input	-	-
	Fieldbus as command source: The motor is switched on/off via the fieldbus.	Digital inputs as command source: The motor is switched on/off via digital inputs	-	-

Note

Command data sets can be switched over in the "ready for operation" and "operation" state. The switchover time is approx. 4 ms.

Table 7- 44 Parameters for switching the command data sets

Parameter	Description
P0810	1st control command for switching the command data sets Example: When P0810 = 722.0, the system switches from command data set 0 to command data set 1 via digital input 0.
P0811	2nd control command for switching the command data sets
r0050	Displaying the number of the CDS that is currently active

For an overview of all the parameters that belong to the drive data sets and can be switched, see the Parameter Manual.

A copy function is available making it easier to commission more than one command data set.

Table 7- 45 Parameters for copying the command data sets

Parameter	Description
P0809[0]	Number of the command data set to be copied (source)
P0809[1]	Number of the command data set to which the data is to be copied (target)
P0809[2] = 1	Start copying Once the data has been copied, p0809[2] is automatically set to 0
Example	
P0809[0] = 0	The parameters of command data set 0 are copied to command data set 1
P0809[1] = 1	
P0809[2] = 1	

7.11.2 Switching over drive data sets (different motors connected to an inverter)

When the drive's properties change, the inverter's parameterization must be changed.

Example: Operating different motors on one inverter

One inverter should operate one of two different motors. Depending on which motor is to run at any given time, the motor data and the ramp-function generator times for the different motors must be adjusted accordingly in the inverter.

Drive data sets (DDS)

The inverter provides the possibility of parameterizing the following functions in up to four different ways:

1. Setpoint sources
(exceptions: Analog inputs and fieldbus)
2. Setpoint processing
3. Motor control
4. Motor and inverter protection
5. Technological functions
(Exception: Technology controller, brake control, automatic restart and unassigned function blocks)

The associated parameters are indexed (index 0, 1, 2 or 3). Control commands select one of the four indices and therefore one of the four saved settings.

This means, that as described in the example above, you can switch over all of the settings of the inverter matching the particular motor.

The term "command data set" is used to indicate all of the switchable parameters of the five functions mentioned above with the same index.

7.11 Switchover between different settings

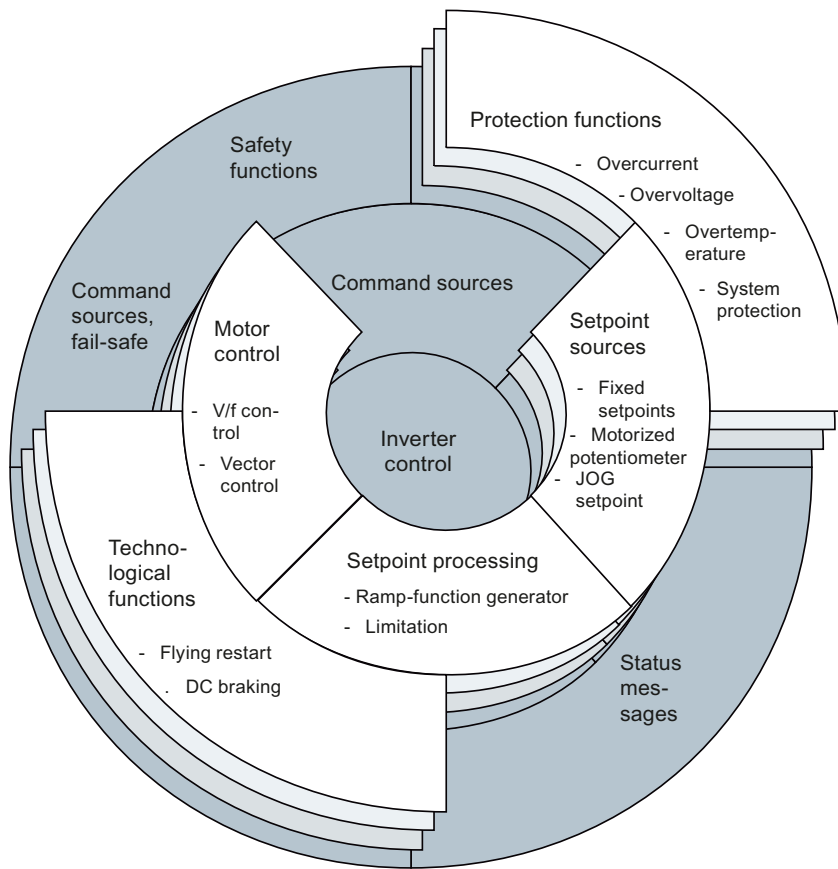

Figure 7-31 DDS switchover in the inverter

Use parameter P0180 to define the number of command data sets (2, 3 or 4).

Table 7- 46 Selecting the number of command data sets

Parameter	Description
P0010 = 15	Drive commissioning: Data sets
P0180	Number of drive data sets (factory setting: 1) P0180 = 1, 2, 3 or 4
P0010 = 0	Drive commissioning: Ready

The drive data sets are switched over using parameters P0820 and P0821. Parameters P0820 and P0821 are interlinked to control commands, e.g. the digital inputs of the inverter, using BICO technology.

Table 7- 47 Parameters for switching the drive data sets:

Parameter	Description
P0820	1st cntrol command for switching the drive data sets Example: When P0820 = 722.0, the system switches from drive data set 0 to drive data set 1 via digital input 0
P0821	2nd control command for switching the drive data sets
P0826	Motor switchover, motor number If the motor is to be switched over at the same time as the data set, different motor numbers should be used. If this happens, the data set can only be switched over under pulse inhibit.
r0051	Displaying the number of the DDS that is currently effective

Note

The motor data of the drive data sets can only be changed over in the "ready for operation" state. The switchover time is approx. 50 ms.

If you do not switch motor data over along with the drive data sets (i.e. same motor number in P0826), you can switch the drive data sets over during operation.

For an overview of all the parameters that belong to the drive data sets and can be switched, see the Parameter Manual.

A copy function is available making it easier to commission more than one drive data set.

Table 7- 48 Parameters for copying the drive data sets

Parameter	Description
P0819[0]	Number of the drive data set to be copied (source)
P0819[1]	Number of the drive data to which the data is to be copied (target)
P0819[2] = 1	Start copying
Example	
P0819[0] = 0	The parameters of drive data set 0 are copied to drive data set 1
P0819[1] = 1	
P0819[2] = 1	

8.1 Replacing the inverter components

In the event of a long-term function fault, you can replace the inverter's Power Module or Control Unit separately. In many cases, you can switch the motor back on again straight after the replacement.

Replacing components without recommissioning the drive

In the scenarios listed below, the inverter can be used straight after components have been replaced:

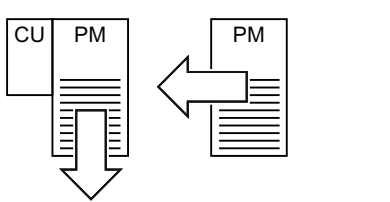
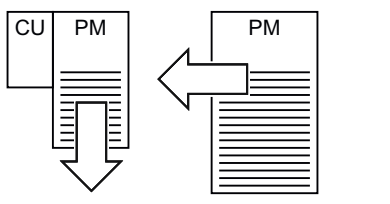
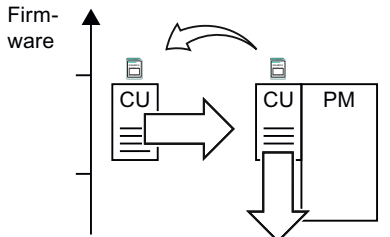
Component replacement		Remark
	Replacing Power Module with a Power Module <ul style="list-style-type: none"> • of the same type and • same power rating 	-
	Replacing Power Module with a Power Module <ul style="list-style-type: none"> • of the same type and • <i>greater</i> power rating 	Power Module and motor must be adapted to one another (ratio of motor and Power Module rated power > 1/8)
	Replacing Control Unit with memory card with a Control Unit <ul style="list-style-type: none"> • of the same type and • same firmware version 	The settings, which are saved on the memory card of the CU that has been replaced, are transferred into the new CU

8.1 Replacing the inverter components

Component replacement	Remark
	<p>Replacing Control Unit with memory card with a Control Unit</p> <ul style="list-style-type: none"> • of the same type and • <i>higher</i> firmware version: (e.g. replacing a CU with FW V4.2 by a CU with FW V4.3)

Replacing components where recommissioning is needed

In the cases below, you will need to reparameterize the inverter when the components have been replaced:

Component replacement	
	<p>Replacing Power Module with a Power Module</p> <ul style="list-style-type: none"> • of the same type and • <i>lower</i> power rating
	<p>Replacing Power Module with a Power Module of a <i>different</i> type (e.g. replacing a PM240 with a PM250)</p>
	<p>Replacing Control Unit with a Control Unit</p> <ul style="list-style-type: none"> • of the same type and • <i>lower</i> firmware version (e.g. replacing a CU with FW V4.3 with a CU with FW V4.2)

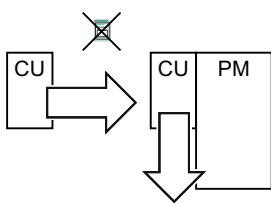
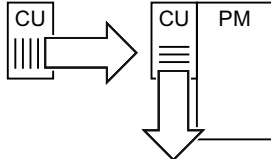
Component replacement	
	Replacing Control Unit <i>without</i> a memory card
	Replacing Control Unit with a Control Unit of a <i>different</i> type (e.g. replacing a CU230P-2 with a CU240E-2 DP)

8.2 Replacing the Control Unit

We recommend that you back up the Control Unit parameters externally once commissioning has been completed. The options are as follows:

1. Back up using the commissioning tool STARTER on your PG/PC.
2. Back up your parameters on a memory card in the inverter.
3. Back up in the Operator Panel.

If you do not back up your parameters, you have to recommission the drive when you replace the Control Unit.

Procedure for replacing a Control Unit with a memory card

- Disconnect the line voltage of the Power Module and (if installed) the external 24 V supply or the voltage for the relay outputs DO 0 and DO 2 of the Control Unit.
- Remove the signal cables of the Control Unit.
- Remove the defective CU from the Power Module.
- Plug the new CU on to the Power Module. The new CU must have the same order number and the same or a higher firmware version as the CU that was replaced.
- Remove the memory card from the old Control Unit and insert it in the new Control Unit.
- Reconnect the signal cables of the Control Unit.
- Connect up the line voltage again.
- The inverter adopts the settings from the memory card, saves them (protected against power failure) in its internal parameter memory, and switches to "ready to start" state.
- Switch on the motor and check the function of the drive.

Procedure for replacing a Control Unit without a memory card

- Disconnect the line voltage of the Power Module and (if installed) the external 24 V supply or the voltage for the relay outputs DO 0 and DO 2 of the Control Unit.
- Remove the signal cables of the Control Unit.
- Remove the defective CU from the Power Module.
- Plug the new CU on to the Power Module.
- Reconnect the signal cables of the Control Unit.
- Connect up the line voltage again.
- The inverter goes into the "ready-to-switch-on" state.
- Check whether the new CU has the same order number and the same or a higher firmware version as the CU that was replaced.
- If yes, and if you have backed-up the parameters of the Control Unit that was replaced, then proceed as follows:
 - Load the parameters into the new CU using STARTER or an Operator Panel.
 - Switch on the motor and check the function of the drive.
- In all other cases, you must recommission the inverter.

Acceptance test of the safety functions

If you have activated the safety functions in the inverter, after you have downloaded the parameters into the inverter, the following steps are required:

- If you have newly commissioned the inverter, proceed as follows:
 - Temporarily switch-off the CU power supply (Power ON Reset).
 - Perform a complete acceptance test, see Complete acceptance test (Page 224).
- In all other cases, after downloading the parameters into the inverter, the following steps are required:
 - Temporarily switch-off the CU power supply (Power ON Reset).
 - Perform a reduced acceptance test. The necessary measures are described in the Chapter Reduced acceptance test (Page 225).

8.3 Replacing the Power Module

Procedure for replacing a Power Module

- Disconnect the Power Module from the line.
- If present, switch off the 24 V supply of the Control Unit.
- After switching off the line voltage, wait 5 minutes until the device has discharged itself.
- Remove the line supply cables of the Power Module.
- Remove the Control Unit from the Power Module.
- Replace the old Power Module with the new Power Module.
- Snap the Control Unit onto the new Power Module.
- Correctly connect the line supply cables to the new Power Module.
- Connect the line supply and, if present, the 24 V supply for the Control Unit.
- If necessary, recommission. (See Replacing the inverter components (Page 237)).

Acceptance test of the safety functions

If you have activated the safety functions in the inverter, after replacing the Power Module, the following steps are required:

- Acknowledge the fault code issued by the inverter.
- Perform a reduced acceptance test. The necessary measures are described in the Chapter Reduced acceptance test (Page 225).

Alarms, faults and system messages

The inverter has the following diagnostic types:

- LED
You can obtain an overview of the inverter state locally at the Control Unit LED.
- Alarms and faults
Alarms and faults have a unique number. The inverter displays the numbers on the Operator Panel and via STARTER - or signals them to a higher-level control.

If the inverter no longer responds

Due to faulty parameter settings, e.g. by loading a defective file from the memory card, the inverter can adopt the following condition:

- The motor is switched off.
- You cannot communicate with the inverter, either via the Operator Panel or other interfaces.

In this event proceed as follows:

- Switch-off and switch-on the Control Unit power supply three times.
- If the inverter signals the fault F01018, carry out the corrective actions for this fault shown in section List of faults (Page 256).

F01018 can only be acknowledged by switching the CU on and off again.

9.1 Operating states indicated on LEDs

The LED RDY (Ready) is temporarily orange after the power supply voltage is switched-on. As soon as the color of the LED RDY changes to either red or green, the LEDs on the Control Unit indicate the inverter state.

LED RDY and LED BF displays

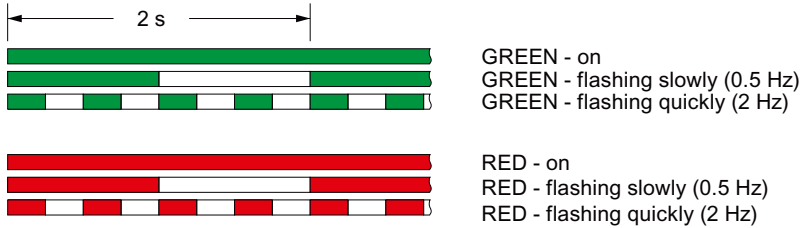

Table 9-1 Inverter diagnostics

LED		Explanation
RDY	BF	
GREEN - on	---	Ready for operation (no active fault)
GREEN - slow	---	Commissioning or reset to factory settings
RED - on	OFF	Firmware update in progress
RED - slow	RED - slow	Firmware Update is complete, Power ON Reset required
RED - fast	---	General fault
RED - fast	RED - on	Fault during firmware update
RED - fast	RED - fast	Incompatible firmware / incorrect memory card

Table 9-2 Communication diagnostics via RS485

LED BF	Explanation
OFF	Receive process data
RED - slow	Bus active - no process data
RED - fast	No bus activity

Table 9-3 Communication diagnostics via PROFIBUS DP

LED BF	Explanation
off	Cyclic data exchange (or PROFIBUS not used, p2030 = 0)
RED - slow	Bus fault - configuration fault
RED - fast	Bus fault - no data exchange - baud rate search - no connection

SAFE LED displays

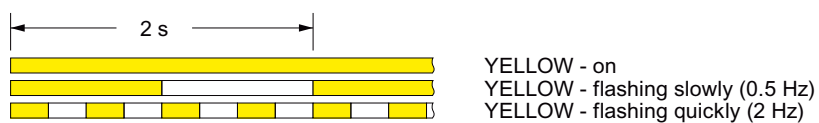



Table 9- 4 Diagnostics of the safety functions

SAFE LED	Meaning
YELLOW - on	One or more safety functions are enabled, but not active.
YELLOW - slow	One or more safety functions are active; no safety function faults have occurred.
YELLOW - rapid	The inverter has detected a safety function fault and initiated a stop response.

9.2 Alarms

Alarms have the following properties:

- They do not have a direct effect in the inverter and disappear once the cause has been removed
- They do not need have to be acknowledged
- They are signaled as follows
 - Status display via bit 7 in status word 1 (r0052)
 - at the Operator Panel with a Axxxxx
 - via STARTER, if you click on TAB  at the bottom left of the STARTER screen

In order to pinpoint the cause of an alarm, there is a unique alarm code and also a value for each alarm.

Alarm buffer

For each incoming alarm, the inverter saves the alarm, alarm value and the time that the alarm was received.

	Alarm code	Alarm value		Alarm time received		Alarm time removed	
1. Alarm	r2122[0]	r2124[0]	r2134[0]	r2145[0]	r2123[0]	r2146[0]	r2125[0]
		I32	Float	Days	ms	Days	ms

Figure 9-1 Saving the first alarm in the alarm buffer

r2124 and r2134 contain the alarm value - important for diagnostics - as "fixed point" or "floating point" number.

The alarm times are displayed in r2145 and r2146 (in complete days) as well as in r2123 and r2125 (in milliseconds referred to the day of the alarm).

The inverter uses an internal time calculation to save the alarm times. More information on the internal time calculation can be found in Chapter System runtime (Page 186).

As soon as the alarm has been removed, the inverter writes the associated instant in time into parameters r2125 and r2146. The alarm remains in the alarm buffer even if the alarm has been removed.

If an additional alarm is received, then this is also saved. The first alarm is still saved. The alarms that have occurred are counted in p2111.

	Alarm code	Alarm value		Alarm time received		Alarm time removed	
1. Alarm	r2122[0]	r2124[0]	r2134[0]	r2145[0]	r2123[0]	r2146[0]	r2125[0]
2. Alarm	[1]	[1]	[1]	[1]	[1]	[1]	[1]

Figure 9-2 Saving the second alarm in the alarm buffer

The alarm buffer can contain up to eight alarms. If an additional alarm is received after the eighth alarm - and none of the last eight alarms have been removed - then the next to last alarm is overwritten.

	Alarm code	Alarm value		Alarm time received		Alarm time removed	
1. Alarm	r2122[0]	r2124[0]	r2134[0]	r2145[0]	r2123[0]	r2146[0]	r2125[0]
2. Alarm	[1]	[1]	[1]	[1]	[1]	[1]	[1]
3. Alarm	[2]	[2]	[2]	[2]	[2]	[2]	[2]
4. Alarm	[3]	[3]	[3]	[3]	[3]	[3]	[3]
5. Alarm	[4]	[4]	[4]	[4]	[4]	[4]	[4]
6. Alarm	[5]	[5]	[5]	[5]	[5]	[5]	[5]
7. Alarm	[6]	[6]	[6]	[6]	[6]	[6]	[6]
Last alarm	[7]	[7]	[7]	[7]	[7]	[7]	[7]

Figure 9-3 Complete alarm buffer

Emptying the alarm buffer: Alarm history

The alarm history traces up to 56 alarms.

The alarm history only takes alarms that have been removed from the alarm buffer. If the alarm buffer is completely filled - and an additional alarm occurs - then the inverter shifts all alarms that have been removed from the alarm buffer into the alarm history. In the alarm history, alarms are also sorted according to the "alarm time received", however, when compared to the alarm buffer, in the inverse sequence:

- the youngest alarm is in index 8
- the second youngest alarm is in index 9
- etc.

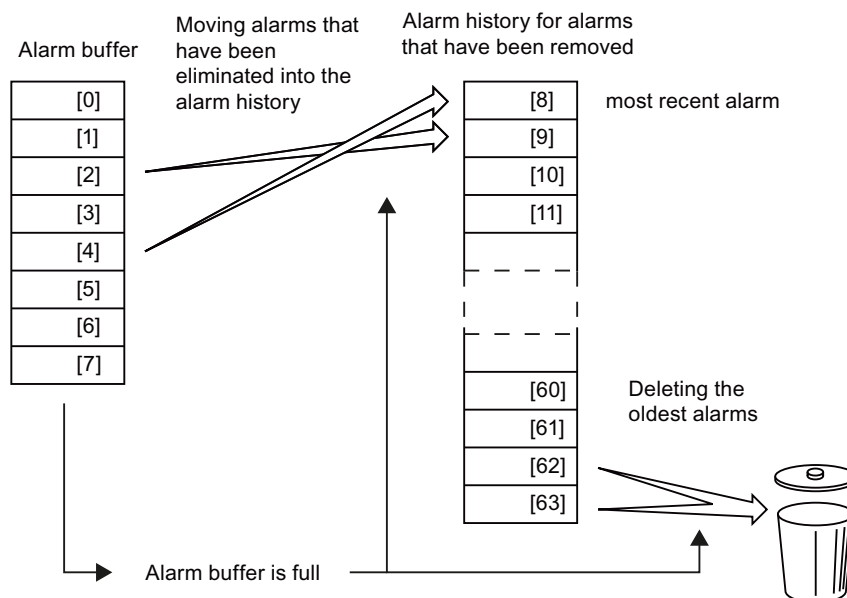

Figure 9-4 Shifting alarms that have been removed into the alarm history

The alarms that have still not been removed remain in the alarm buffer and are resorted so that gaps between the alarms are filled.

If the alarm history is filled up to index 63, each time a new alarm is accepted in the alarm history, the oldest alarm is deleted.

Parameters of the alarm buffer and the alarm history

Table 9- 5 Important parameters for alarms

Parameter	Description
r2122	Alarm code Displays the numbers of alarms that have occurred
r2123	Alarm time received in milliseconds Displays the time in milliseconds when the alarm occurred
r2124	Alarm value Displays additional information about the alarm
r2125	Alarm time removed in milliseconds Displays the time in milliseconds when the alarm was removed
p2111	Alarm counter Number of alarms that have occurred after the last reset When setting p2111 = 0, all of the alarms that have been removed from the alarm buffer [0...7] are transferred into the alarm history [8...63]
r2145	Alarm time received in days Displays the time in days when the alarm occurred
r2132	Actual alarm code Displays the code of the alarm that last occurred
r2134	Alarm value for float values Displays additional information about the alarm that occurred for float values
r2146	Alarm time removed in days Displays the time in days when the alarm was removed

Extended settings for alarms

Table 9- 6 Extended settings for alarms

Parameter	Description
You can change up to 20 different alarms into a fault or suppress alarms:	
p2118	Setting the message number for the message type Select the alarms for which the message type should be changed
p2119	Setting the message type Setting the message type for the selected alarm 1: Fault 2: Alarm 3: No message

You will find details in function block diagram 8075 and in the parameter description of the List Manual.

9.3 List of warnings

Table 9- 7 The most important warnings

Number	Cause	Remedy
A01028	Configuration error	Explanation: Parameterization on the memory card has been created with a different type of module (order number, MLFB) Check the module parameters and recommission if necessary.
A01590	Motor maintenance interval lapsed	Carry out maintenance and reset the maintenance interval (p0651).
A01900	PROFIBUS: Configuration telegram faulty	Explanation: A PROFIBUS master is attempting to establish a connection with a faulty configuration telegram. Check the bus configuration on the master and slave side.
A01920	PROFIBUS: Cyclic connection interrupt	Explanation: The cyclic connection to PROFIBUS master is interrupted. Establish the PROFIBUS connection and activate the PROFIBUS master with cyclic operation.
A03520	Temperature sensor fault	Check that the sensor is connected correctly.
A05000 A05001	Power Module overtemperature	Check the following: - Is the ambient temperature within the defined limit values? - Are the load conditions and duty cycle configured accordingly? - Has the cooling failed?
A07012	I2t Motor Module overtemperature	Check and if necessary reduce the motor load. Check the motor's ambient temperature. Check thermal time constant p0611. Check overtemperature fault threshold p0605.
A07015	Motor temperature sensor alarm	Check that the sensor is connected correctly. Check the parameter assignment (p0601).
A07321	Automatic restart active	Explanation: The automatic restart (AR) is active. During voltage recovery and/or when remedying the causes of pending faults, the drive is automatically switched back on.
A07850 A07851 A07852	External alarm 1 ... 3	The signal for "external alarm 1" has been triggered. Parameters p2112, p2116 and p2117 determine the signal sources for the external alarm 1... 3. Remedy: Rectify the cause of this alarm.
A07903	Motor speed deviation	Increase p2163 and/or p2166. Increase the torque, current and power limits.
A07910	Motor overtemperature	Check the motor load. Check the motor's ambient temperature. Check the KTY84 sensor. Check the overtemperatures of the thermal model (p0626 ... p0628).
A07927	DC braking active	Not required
A07980	Rotary measurement activated	Not required
A07981	No enabling for rotary measurement	Acknowledge pending faults. Establish missing enables (see r00002, r0046).

9.3 List of warnings

Number	Cause	Remedy
A07991	Motor data identification activated	Switch on the motor and identify the motor data.
A30920	Temperature sensor fault	Check that the sensor is connected correctly.

You will find additional information in the List Manual or in the STARTER online help.

Table 9- 8 The most important alarms for safety functions

Number	Cause	Remedy
A01666	Static 1 signal on the F-DI for secure acknowledgement	Setting F-DI to logical 0 signal
A01698	Commissioning mode active for safety functions	This message is withdrawn after the safety functions have been commissioned
A01699	Shutdown path test required	After the next time that the "STO" function is deselected, the message is withdrawn and the monitoring time is reset

You will find additional information in the parameter manual or in the online help of STARTER.

9.4 Faults

A fault displays a severe fault during operation of the inverter.

The inverter signals a fault as follows:

- at the Operator Panel with Fxxxxx
- at the Control Unit using the red LED RDY
- in bit 3 of the status word 1 (r0052)
- via STARTER

To delete a fault message, you need to remedy the cause of the fault and acknowledge the fault.

Every fault has a clear fault code and also a fault value. You need this information to determine the cause of the fault.

Fault buffer of actual values

For each fault received, the inverter saves the fault code, fault value and the time of the fault.

	Fault code	Fault value	Fault time received	Fault time removed
1st fault	r0945[0]	r0949[0] r2133[0] I32 Float	r2130[0] r0948[0] Days ms	r2136[0] r2109[0] Days ms

Figure 9-5 Saving the first fault in the fault buffer

r0949 and r2133 contain the fault value - important for diagnostics - as "fixed point" or "floating point" number.

The "fault time received" is in parameter r2130 (in complete days) as well as in parameter r0948 (in milliseconds referred to the day of the fault). The "fault time removed" is written into parameters r2109 and r2136 when the fault has been acknowledged.

The inverter uses its internal time calculation to save the fault times. More information on the internal time calculation can be found in Chapter System runtime (Page 186).

If an additional fault occurs before the first fault has been acknowledged, then this is also saved. The first alarm remains saved. The fault cases that have occurred are counted in p0952. A fault case can contain one or several faults.

	Fault code	Fault value	Fault time received	Fault time removed
1st fault	r0945[0]	r0949[0] r2133[0] I32 Float	r2130[0] r0948[0] Days ms	r2136[0] r2109[0] Days ms
2nd fault	[1]	[1] [1]	[1] [1]	[1] [1]

Figure 9-6 Saving the second fault in the fault buffer

9.4 Faults

The fault buffer can accept up to eight actual faults. The next to last fault is overwritten if an additional fault occurs after the eighth fault.

	Fault code	Fault value			Fault time received		Fault time removed	
1st fault	r0945[0]	r0949[0]	r2133[0]	r2130[0]	r0948[0]	r2136[0]	r2109[0]	
2nd fault	[1]	[1]	[1]	[1]	[1]	[1]	[1]	
3rd fault	[2]	[2]	[2]	[2]	[2]	[2]	[2]	
4th fault	[3]	[3]	[3]	[3]	[3]	[3]	[3]	
5th fault	[4]	[4]	[4]	[4]	[4]	[4]	[4]	
6th fault	[5]	[5]	[5]	[5]	[5]	[5]	[5]	
7th fault	[6]	[6]	[6]	[6]	[6]	[6]	[6]	
Last fault	[7]	[7]	[7]	[7]	[7]	[7]	[7]	

Figure 9-7 Complete fault buffer

Fault acknowledgement

In most cases, you have the following options to acknowledge a fault:

- Switch the inverter off and then on again
- (switch off the main power supply and the external 24 V supply for the Control Unit and switch it on again).
- Press the acknowledgement button on the operator panel
- Acknowledgement signal at digital input 2
- Acknowledgement signal in bit 7 of control word 1 (r0054) for Control Units with fieldbus interface

Faults that are triggered by monitoring of hardware and firmware inside the inverter can only be acknowledged by switching off and on again. You will find a note about this restricted option to acknowledge faults in the fault list of the List Manual.

Emptying the fault buffer: Fault history

The fault history can contain up to 56 faults.

The fault acknowledgement has no effect as long as none of the fault causes of the fault buffer have been removed. If at least one of the faults in the fault buffer has been removed (the cause of the fault has been removed) and you acknowledge the faults, then the following happens:

1. The inverter accepts all faults from the fault buffer in the first eight memory locations of the fault history (indices 8 ... 15).
2. The inverter deletes the faults that have been removed from the fault buffer.
3. The inverter writes the time of acknowledgement of the faults that have been removed into parameters r2136 and r2109 (fault time removed).

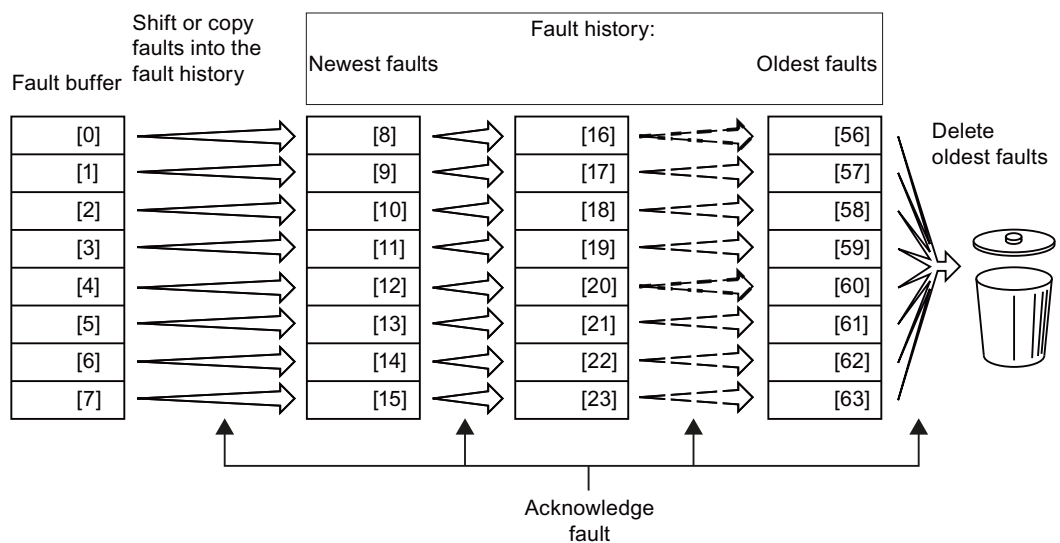

Figure 9-8 Fault history after acknowledging the faults

After acknowledgement, the faults that have not been removed are located in the fault buffer as well as in the fault history. For these faults, the "fault time coming" remains unchanged and the "fault time removed" remains empty.

If less than eight faults were shifted or copied into the fault history, the memory locations with the higher indices remain empty.

The inverters shifts the values previously saved in the fault history each by eight indices. Faults, which were saved in indices 56 ... 63 before the acknowledgement, are deleted.

Deleting the fault history

If you wish to delete all faults from the fault history, set parameter p0952 to zero.

Parameters of the fault buffer and the fault history

Table 9- 9 Important parameters for faults

Parameter	Description
r0945	Fault code Displays the numbers of faults that have occurred
r0948	Fault time received in milliseconds Displays the time in milliseconds when the fault occurred
r0949	Fault value Displays additional information about the fault
p0952	Fault cases, counter Number of fault cases that have occurred since the last acknowledgement The fault buffer is deleted with p0952 = 0.
r2109	Fault time removed in milliseconds Displays the time in milliseconds when the fault occurred
r2130	Fault time received in days Displays the time in days when the fault occurred
r2131	Actual fault code Displays the code of the oldest fault that is still active
r2133	Fault value for float values Displays additional information about the fault that occurred for float values
r2136	Fault time removed in days Displays the time in days when the fault was removed

The motor cannot be switched-on

If the motor cannot be switched-on, then check the following:

- Is a fault present?
If yes, then remove the fault cause and acknowledge the fault
- Does p0010 = 0?
If not, the inverter is e.g. still in a commissioning state.
- Is the inverter reporting the "ready to start" status (r0052.0 = 1)?
- Is the inverter missing enabling (r0046)?
- Are the command and setpoint sources for the inverter (p0700 and p1000) correctly parameterized?
In other words, where is the inverter getting its speed setpoint and commands from (fieldbus or analog input)?
- Do the motor and inverter match?
Compare the data on the motor's nameplate with the corresponding parameters in the inverter (P0300 ff).

Extended settings for faults

Table 9- 10 Advanced settings

Parameter	Description
You can change the fault response of the motor for up to 20 different fault codes:	
p2100	Setting the fault number for fault response Selecting the faults for which the fault response should be changed
p2101	Setting, fault response Setting the fault response for the selected fault
You can change the acknowledgement type for up to 20 different fault codes:	
p2126	Setting the fault number for the acknowledgement mode Selecting the faults for which the acknowledgement type should be changed
p2127	Setting, acknowledgement mode Setting the acknowledgement type for the selected fault 1: Can only be acknowledged using POWER ON 2: IMMEDIATE acknowledgment after removing the fault cause
You can change up to 20 different faults into an alarm or suppress faults:	
p2118	Setting the message number for the message type Selecting the message for which the message type should be selected
p2119	Setting the message type Setting the message type for the selected fault 1: Fault 2: Alarm 3: No message

You will find details in function diagram 8075 and in the parameter description of the List Manual.

9.5 List of faults

Table 9- 11 The most important faults

Number	Cause	Remedy
F01910	Fieldbus SS setpoint timeout	Check the bus connection and communication partner, e.g. switch the PROFIBUS master to the RUN status.
F03505	Analog input, wire break	Check the connection to the signal source for interrupts. Check the level of the signal supplied. The input current measured by the analog input can be read out in r0752.
F07011	Motor overtemperature	Reduce the motor load. Check ambient temperature. Check sensor's wiring and connection.
F07016	Motor temperature sensor fault	Make sure that the sensor is connected correctly. Check the parameterization (P0601). Deactivate the temperature sensor fault (P0607 = 0).
F07320	Automatic restart aborted	Increase number of hot restart attempts (P1211). The current number of start attempts is shown in r1214. Increase wait time in P1212 and/or monitoring time in P1213. Create ON command (P0840). Increase monitoring time of power unit or switch off (P0857). Reduce the wait time for resetting the fault counter P1213[1] such that fewer faults are registered in the time interval.
F07330	Search current measured too low	Increase search current (P1202), check motor connection.
F07801	Motor overcurrent	Check current limits (P0640). Vector control: Check current controller (P1715, P1717). V/f control: Check current limiting controller (P1340 ... P1346). Increase acceleration ramp (P1120) or reduce load. Check motor and motor cables for short circuit and ground fault. Check motor for star-delta connection and rating plate parameterization. Check power unit / motor combination. Select flying restart function (P1200) if switched to rotating motor.
F07806	Regenerative power limit exceeded	Increase deceleration ramp. Reduce driving load. Use power unit with greater energy recovery capability. During vector control, the regenerative power limit in P1531 can be reduced until the fault is no longer activated.
F07860 F07861 F07862	External fault 1 ... 3	Remove the external causes for this fault.

Number	Cause	Remedy
F07900	Motor blocked	Check that the motor can run freely. Check the torque limits (r1538 and r1539). Check the parameters of the "Motor blocked" message (P2175, P2177).
F07901	Motor overspeed	Activate precontrol of speed limiting controller (P1401 bit 7 = 1). Increase hysteresis for overspeed message P2162.
F07902	Motor stalled	Check whether the motor data has been parameterized correctly and perform motor identification. Check the current limits (P0640, r0067, r0289). If the current limits are too low, the drive cannot be magnetized. Check whether motor cables are disconnected during operation.
F30001	Overcurrent	Check the following: <ul style="list-style-type: none"> • Motor data, if required, carry out commissioning • Motor's connection method (Y / Δ) • V/f operation: Assignment of rated currents of motor and Power Module • Line quality • Make sure that the line commutating reactor is connected properly • Power cable connections • Power cables for short-circuit or ground fault • Power cable length • Line phases If this doesn't help: <ul style="list-style-type: none"> • V/f operation: Increase the acceleration ramp • Reduce the load • Replace the power unit
F30002	DC-link voltage overvoltage	Increase the ramp-down time (p1121). Set the rounding times (P1130, P1136). Activate the DC-link voltage controller (P1240, P1280). Check the line voltage (P0210). Check the line phases.
F30003	DC-link voltage undervoltage	Check the line voltage (P0210).
F30004	Inverter overtemperature	Check whether the inverter fan is running. Check whether the ambient temperature is in the permissible range. Check whether the motor is overloaded. Reduce the pulse frequency.
F30005	I2t inverter overload	Check the rated currents of the motor and Power Module. Reduce current limit P0640. When operating with V/f characteristic: Reduce P1341.
F30011	Line phase failure	Check the inverter's input fuses. Check the motor cables.

9.5 List of faults

Number	Cause	Remedy
F30015	Motor cable phase failure	Check the motor cables. Increase the ramp-up or ramp-down time (P1120).
F30027	Time monitoring for DC link pre-charging	Check the supply voltage on the input terminals. Check the line voltage setting (P0210).

You will find additional information in the List Manual and in the online help of STARTER.

Table 9- 12 Faults which can only be acknowledged by switching off and on again

Number	Cause	Remedy
F01000	Software fault in CU	Replace CU.
F01001	Floating Point Exception	Switch CU off and on again.
F01015	Software fault in CU	Upgrade firmware or contact hotline.
F01018	Power-up aborted more than once	After this fault has been output, the module is booted based on factory settings. Remedy: Back up factory setting with p0971=1. Switch CU off and on again. Recommission the inverter.
F01040	Parameters must be saved	Save parameters (P0971). Switch CU off and on again.
F01044	Loading of memory data card defective	Replace memory card or CU.
F01105	CU: Insufficient memory	Reduce number of data records.
F01205	CU: Time slice overflow	Contact the Hotline.
F01250	CU hardware fault	Replace CU.
F01512	An attempt has been made to establish a conversion factor for scaling which is not present	Create scaling or check transfer value.
F01662	CU hardware fault	Switch CU off and on again, upgrade firmware or contact hotline.
F30022	Power Module: Monitoring U _{CE}	Check or replace the Power Module.
F30052	Incorrect Power Module data	Replace Power Module or upgrade CU firmware.
F30053	Error in FPGA data	Replace the Power Module.
F30662	CU hardware fault	Switch CU off and on again, upgrade firmware or contact hotline.
F30664	CU power up aborted	Switch CU off and on again, upgrade firmware or contact hotline.
F30850	Software fault in Power Module	Replace Power Module or contact hotline.

You will find additional information in the List Manual or in the STARTER online help.

Table 9- 13 The most important faults for safety functions

Number	Cause	Remedy
F01600	STOP A initiated	Select STO and then deselect again
F01650	Acceptance test required	Carry out acceptance test and create test certificate. Switch the Control Unit off and then on again.
F01659	Write task for parameter rejected	Cause: A parameter reset was selected. The fail-safe parameters have not yet been reset, as the safety functions are enabled Remedy: block safety functions or reset fail-safe parameters (p0970 = 5), then reset the drive parameters once again.
F30600	STOP A initiated	Select STO and then deselect again

You will find additional information in the Parameter Manual and in the online help of STARTER.

Technical data

10.1 Technical data, CU240B-2 Control Unit

Feature	Data
Operating voltage	Supply from the Power Module or an external 24 V DC supply (20.4 V ... 28.8 V, 1 A) via control terminals 31 and 32
Heat loss	5.0 W plus power loss of output voltages
Output voltages	18 V ... 30 V (max. 200 mA) 15 V \pm 10 % (max. 90 mA) 10 V \pm 0.5 V (max. 10 mA)
Setpoint resolution	0.01 Hz
Digital inputs	<ul style="list-style-type: none"> • 4 digital inputs, DI 0 ... DI 3, isolated; • Low < 5 V, high > 11 V, maximum input voltage 30 V, current consumption 5.5 mA • Switchable via terminals <ul style="list-style-type: none"> – PNP: Bridge terminal 69 with terminal 9 – NPN: Bridge terminal 69 with terminal 28 • Response time: 10 ms without debounce time (p0724)
Analog input	AI 0: 12-bit resolution, differential input, 0 V ... 10 V, 0 mA ... 20 mA and -10 V ... +10 V Reaction time: 13 ms \pm 1 ms Can be configured as additional digital input: Low < 1.6 V, High > 4.0 V Reaction time: 13 ms \pm 1 ms without debounce time (p0724)
Digital output	DO 0: Relay output 30 V DC / max. 0.5 A with resistive load, update time 2 ms For applications, which require UL certification, the voltage at DO 0 must not exceed 30 V DC referred to ground potential and must be supplied via a grounded class 2 power supply.
Analog output	AO 0: 0 V ... 10 V or 0 mA ... 20 mA, reference potential: "GND", resolution 16 bit, update time: 4 ms
Temperature sensor	<ul style="list-style-type: none"> • PTC: Short-circuit monitoring 22 Ω, switching threshold 1650 Ω • KTY84 • ThermoClick sensor with dry contact
Dimensions (WxHxD)	73 mm \times 199 mm \times 46 mm
Weight	0.49 kg
Memory cards	MMC (we recommend a card with Order No. 6SL3254-0AM00-0AA0). SD (Secure Digital Memory Card, we recommend the card with Order No. 6ES7954-8LB00-0AA0). SDHC (SD High Capacity) cannot be used.
Operating temperature	0 $^{\circ}$ C ... 55 $^{\circ}$ C (operation without inserted operator panel) 0 $^{\circ}$ C ... 50 $^{\circ}$ C (operation with inserted operator panel) Observe any possible restrictions as a result of the Power Module.

10.2 Technical data, CU240E-2 Control Unit

Feature	Data
Operating voltage	Supply from the Power Module or an external 24 V DC supply (20.4 V ... 28.8 V, 0.5 A) via control terminals 31 and 32
Heat loss	5.0 W plus power loss of output voltages
Output voltages	18 V ... 30 V (max. 200 mA) 15 V ± 10 % (max. 90 mA) 10 V ± 0.5 V (max. 10 mA)
Setpoint resolution	0.01 Hz
Digital inputs	<ul style="list-style-type: none"> • 6 digital inputs, DI 0 ... DI 5, isolated; • Low < 5 V, high > 11 V, maximum input voltage 30 V, current consumption 5.5 mA • Switchable via terminals <ul style="list-style-type: none"> – PNP: Bridge terminal 69 or terminal 34 with terminal 9 – NPN: Bridge terminal 69 or terminal 34 with terminal 28 • Response time: 10 ms without debounce time (p0724)
Pulse input	Digital input 3, maximum pulse frequency 32 kHz
Analog inputs (differential inputs, resolution 12 bits)	AI 0, AI 1: 12-bit resolution, differential inputs, 0 V ... 10 V, 0 mA ... 20 mA and -10 V ... +10 V, reaction time: 13 ms ± 1 ms Can be configured as additional digital inputs: Low < 1.6 V, High > 4.0 V. Reaction time: 13 ms ± 1 ms without debounce time (p0724).
Digital outputs / relay outputs	<ul style="list-style-type: none"> • DO 0: Relay output, 30 V DC / max. 0.5 A with resistive load • DO 1: Transistor output, 30 V DC / max. 0.5 A with resistive load, protection against incorrect voltage polarity • DO 2: Relay output, 30 V DC / max. 0.5 A with resistive load Update time of all DO: 2 ms For applications, which require UL certification, the voltage at DO 0 must not exceed 30 V DC referred to ground potential and must be supplied via a grounded class 2 power supply.
Analog outputs	AO 0, AO 1: 0 V ... 10 V or 0 mA ... 20 mA, reference potential: "GND", resolution 16 bit, update time: 4 ms
Temperature sensor	<ul style="list-style-type: none"> • PTC: Short-circuit monitoring 22 Ω, switching threshold 1650 Ω • KTY84 • ThermoClick sensor with dry contact
Fail-safe digital input (Basic Safety)	<ul style="list-style-type: none"> • DI4 and DI5 form a fail-safe digital input • Maximum input voltage 30 V, 5.5 mA • Response time: <ul style="list-style-type: none"> – Typical: 5 ms + debounce time p9651 (6 ms, if p9651 = 0) – Worst-case scenario: 15 ms + debounce time p9651 (16 ms, if p9651 = 0) You will find the "Extended Safety" data in the Safety Integrated Function Manual, see section Overview of documentation (Page 13).
PFH	5 × 10E-8
Dimensions (WxHxD)	73 mm × 199 mm × 46 mm
Weight	0.49 kg

Feature	Data
Memory cards	MMC (we recommend a card with Order No. 6SL3254-0AM00-0AA0). SD (Secure Digital Memory Card, we recommend the card with Order No. 6ES7954-8LB00-0AA0). SDHC (SD High Capacity) cannot be used.
Operating temperature	If the safety functions of the Control Unit are locked: 0 °C ... 55 °C (operation without inserted operator panel) 0 °C ... 50 °C (operation with inserted operator panel) Observe any possible restrictions as a result of the Power Module.

10.3 Technical data, Power Modules

Permissible overload for SINAMICS G120 Power Modules

There are two different power data specifications for the Power Modules: "Low Overload" (LO) and "High Overload" (HO), depending on the expected load.

If the power data comprise rated values without any further specifications they always refer to an overload capability corresponding to Low Overload.

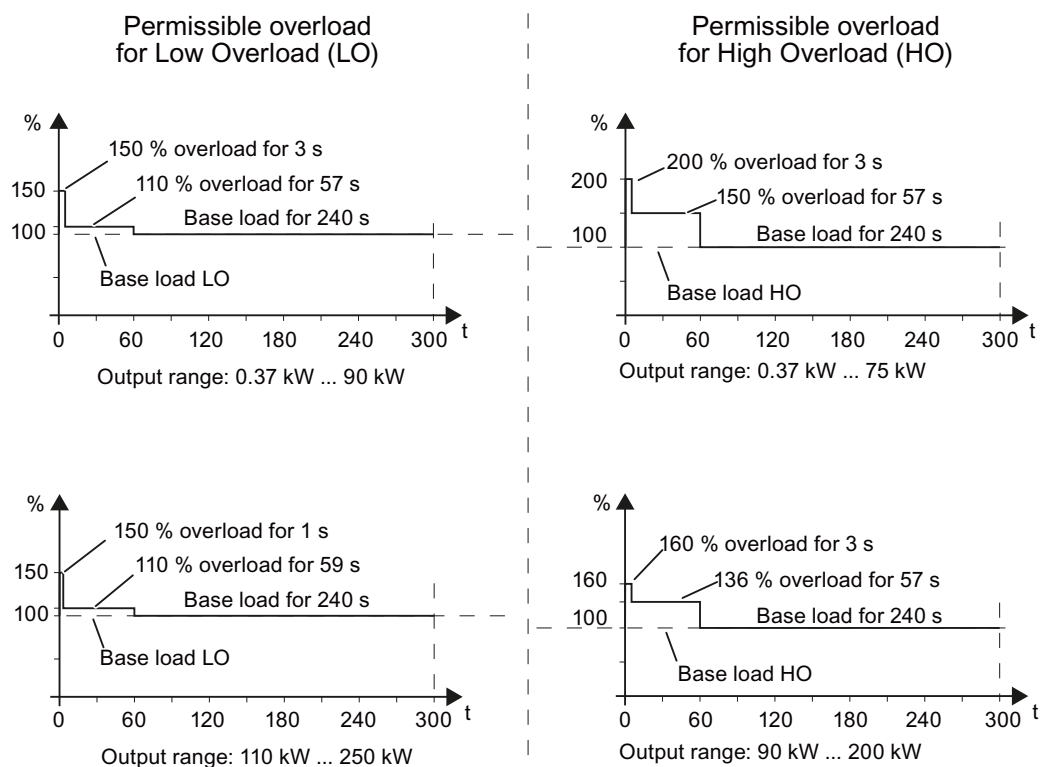

Figure 10-1 Duty cycles, "High Overload" and "Low Overload"

Note

The base load (100% power or current) of "Low Overload" is greater than the base load of "High Overload".

To select the Power Module on the basis of duty cycles, we recommend the "SIZER" engineering software. See section Overview of documentation (Page 13).

Definitions

- **LO input current** 100 % of the permissible input current for a load cycle according to Low Overload (LO base load input current).
- **LO output current** 100 % of the permissible output current for a load cycle according to Low Overload (LO base load output current).
- **LO power** Power of the device for LO output current.
- **HO input current** 100 % of the permissible input current for a load cycle according to High Overload (HO base load input current).
- **HO output current** 100 % of the permissible output current for a load cycle according to High Overload (HO base load output current).
- **HO power** Power of the device for HO output current.

NOTICE
UL-certified fuses must be used
In order that the system is in compliance with UL, UL certified fuses, circuit breakers or self-protected combination motor controllers must be used.

10.3.1 Technical data, PM240

Note

The given input currents are valid for operation without a line reactor for a line voltage of 400 V with $V_k = 1\%$ referred to the rated power of the inverter. If a line reactor is used, the specified values are reduced by a few percent.

General data, PM240 - IP20

Feature	Version
Line voltage	3-ph. 380 V ... 480 V AC $\pm 10\%$ The actual permissible line voltage depends on the installation altitude.
Input frequency	47 Hz ... 63 Hz
Power factor λ	0,7 ... 0,85
Starting current	Less than the input current
Pulse frequency (factory setting)	4 kHz for 0.37 kW ... 90 kW 2 kHz for 110 kW ... 250 kW The pulse frequency can be increased in 2 kHz steps. A higher pulse frequency reduces the permissible output current.
Electromagnetic compatibility	The devices are suitable for environmental classes C1 and C2 in conformance with IEC61800-3. For details, see the Hardware Installation Manual, Appendix A2
Braking methods	DC braking, compound braking, dynamic braking with integrated braking chopper
Degree of protection	IP20
Operating temperature	
• without power reduction	LO operation of all power ratings 0 °C ... +40 °C (32 °F ... 104 °F) 0 °C ... +50 °C (32 °F ... 122 °F) HO operation: 0 °C ... +40 °C (32 °F ... 104 °F)
• with power reduction	0.37 kW ... 110 kW HO operation: 132 kW ... 200 kW up to 60 °C (140 °F), for details, refer to the Hardware Installation Manual all power ratings, HO/LO
Storage temperature	-40 °C ... +70 °C (-40 °F ... 158 °F)
Relative humidity	< 95 % RH - condensation not permissible
Environmental requirements	Protected according to environmental class 3C2 to EN 60721-3-3 against damaging chemical substances
Shock and vibration	Do not allow the inverter to fall and avoid it being subject to hard shocks. Do not install the inverter in an area where it could be continuously subject to vibration.
Electromagnetic radiation	Do not install the inverter close to sources of electromagnetic radiation.
Installation altitude	
• without power reduction	0.37 kW ... 132 kW up to 1000 m (3300 ft) above sea level 160 kW ... 250 kW up to 2000 m (6500 ft) above sea level
• with power reduction	all power ratings up to 4000 m (13000 ft) above sea level, for details refer to the Hardware Installation Manual.
Standards	UL, cUL, CE, C-tick, SEMI F47 In order that the system is UL-compliant, UL-certified fuses, overload circuit-breakers or intrinsically safe motor protection devices must be used.

Power-dependent data, PM240 - IP20

Table 10- 1 PM240 frame size A, 3-ph. 380 V AC... 480 V, ± 10 %

Order number	Without filter	6SL3224-0BE13-7UA0	6SL3224-0BE15-5UA0	6SL3224-0BE17-5UA0
Values based on Low Overload				
• LO power		0.37 kW	0.55 kW	0.75 kW
• LO input current		1.6 A	2.0 A	2.5 A
• LO output current		1.3 A	1.7 A	2.2 A
Values based on High Overload				
• HO power		0.37 kW	0.55 kW	0.75 kW
• HO input current		1.6 A	2.0 A	2.5 A
• HO output current		1.3 A	1.7 A	2.2 A
General values				
• Power loss		0.097 kW	0.099 kW	0.102 kW
• Fuse		10 A	10 A	10 A
• Cooling air requirement		4.8 l/s	4.8 l/s	4.8 l/s
• Cable cross-section for line and motor connection		1 ... 2.5 mm ²	1 ... 2.5 mm ²	1 ... 2.5 mm ²
• Torque for line and motor and motor connection		1.1 Nm	1.1 Nm	1.1 Nm
• Weight		1.2 kg	1.2 kg	1.2 kg

Table 10- 2 PM240 frame size A, 3-ph. 380 V AC... 480 V, ± 10 %

Order number	Without filter	6SL3224-0BE21-1UA0	6SL3224-0BE21-5UA0
Values based on Low Overload			
• LO power		1.1 kW	1.5 kW
• LO input current		3.8 A	4.8 A
• LO output current		3.1 A	4.1 A
Values based on High Overload			
• HO power		1.1 kW	1.5 kW
• HO input current		3.8 A	4.8 A
• HO output current		3.1 A	4.1 A
General values			
• Power loss		0.108 kW	0,114 kW
• Fuse		10 A	10 A
• Cooling air requirement		4.8 l/s	4.8 l/s
• Cable cross-section for line and motor connection		1 ... 2.5 mm ²	1 ... 2.5 mm ²
• Torque for line and motor and motor connection		1.1 Nm	1.1 Nm
• Weight		1.2 kg	1.2 kg

Table 10- 3 PM240 frame size B, 3-ph. 380 V AC... 480 V, ± 10 %

Order number	with filter	6SL3224-0BE22-2AA0	6SL3224-0BE23-0AA0	6SL3224-0BE24-0AA0
	without filter	6SL3224-0BE22-2UA0	6SL3224-0BE23-0UA0	6SL3224-0BE24-0UA0
Values based on Low Overload				
• LO power		2.2 kW	3 kW	4 kW
• LO input current		7.6 A	10.2 A	13.4 A
• LO output current		5.9 A	7.7 A	10.2 A
Values based on High Overload				
• HO power		2.2 kW	3 kW	4 kW
• HO input current		7.6 A	10.2 A	13.4 A
• HO output current		5.9 A	7.7 A	10.2 A
General values				
• Power loss		0.139 kW	0.158 kW	0.183 kW
• Fuse		16 A	16 A	16 A
• Cooling air requirement		24 l/s	24 l/s	24 l/s
• Cable cross-section for line and motor connection		1.5 ... 6 mm ²	1.5 ... 6 mm ²	1.5 ... 6 mm ²
• Torque for line and motor and motor connection		1.5 Nm	1.5 Nm	1.5 Nm
• Weight		4.3 kg	4.3 kg	4.3 kg

Table 10- 4 PM240 frame size C, 3-ph. 380 V AC... 480 V, ± 10 %

Order number	with filter	6SL3224-0BE25-5AA0	6SL3224-0BE27-5AA0	6SL3224-0BE31-1AA0
	without filter	6SL3224-0BE25-5UA0	6SL3224-0BE27-5UA0	6SL3224-0BE31-1UA0
Values based on Low Overload				
• LO power		7.5 kW	11 kW	15 kW
• LO input current		21.9 A	31.5 A	39.4 A
• LO output current		18 A	25 A	32 A
Values based on High Overload				
• HO power		5.5 kW	7.5 kW	11 kW
• HO input current		16.7 A	23.7 A	32.7 A
• HO output current		13.2 A	19 A	26 A
General values				
• Power loss		0.240 kW	0.297 kW	0.396 kW
• Fuse		20 A	32 A	35 A
• Cooling air requirement		55 l/s	55 l/s	55 l/s
• Cable cross-section for line and motor connection		4 ... 10 mm ²	4 ... 10 mm ²	4 ... 10 mm ²
• Torque for line and motor and motor connection		2.3 Nm	2.3 Nm	2.3 Nm
• Weight		6.5 kg	6.5 kg	6.5 kg

Technical data

10.3 Technical data, Power Modules

Table 10- 5 PM240 frame size D, 3-ph. 380 V AC... 480 V, ± 10 %

Order number	with filter without filter	6SL3224-0BE31-5AA0 6SL3224-0BE31-5UA0	6SL3224-0BE31-8AA0 6SL3224-0BE31-8UA0	6SL3224-0BE32-2AA0 6SL3224-0BE32-2UA0
Values based on Low Overload				
• LO power		18.5 kW	22 kW	30 kW
• LO input current		46 A	53 A	72 A
• LO output current		38 A	45 A	60 A
Values based on High Overload				
• HO power		15 kW	18.5 kW	22 kW
• HO input current		40 A	46 A	56 A
• HO output current		32 A	38 A	45 A
General values				
• Power loss		0.44 kW	0.55 kW	0.72 kW
• Fuse		50 A	63 A	80 A
• Cooling air requirement		55 l/s	55 l/s	55 l/s
• Cable cross-section for line and motor connection		10 ... 35 mm ²	10 ... 35 mm ²	10 ... 35 mm ²
• Torque for line and motor and motor connection		6 Nm	6 Nm	6 Nm
• Weight with filter		16 kg	16 kg	16 kg
• Weight without filter		13 kg	13 kg	13 kg

Table 10- 6 PM240 frame size E, 3-ph. 380 V AC... 480 V, ± 10 %

Order number	with filter without filter	6SL3224-0BE33-0AA0 6SL3224-0BE33-0UA0	6SL3224-0BE33-7AA0 6SL3224-0BE33-7UA0
Values based on Low Overload			
• LO power		37 kW	45 kW
• LO input current		88 A	105 A
• LO output current		75 A	90 A
Values based on High Overload			
• HO power		30 kW	37 kW
• HO input current		73 A	90 A
• HO output current		60 A	75 A
General values			
• Power loss		1.04 kW	1.2 kW
• Fuse		100 A	125 A
• Cooling air requirement		110 l/s	110 l/s
• Cable cross-section for line and motor connection		25 ... 35 mm ²	25 ... 35 mm ²
• Torque for line and motor and motor connection		6 Nm	6 Nm
• Weight with filter		23 kg	23 kg
• Weight without filter		16 kg	16 kg

Table 10- 7 PM240 frame size F, 3-ph. 380 V AC... 480 V, ± 10 %

Order number	with filter without filter	6SL3224-0BE34-5AA0 6SL3224-0BE34-5UA0	6SL3224-0BE35-5AA0 6SL3224-0BE35-5UA0	6SL3224-0BE37-5AA0 6SL3224-0BE37-5UA0
Values based on Low Overload				
• LO power		55 kW	75 kW	90 kW
• LO input current		129 A	168 A	204 A
• LO output current		110 A	145 A	178 A
Values based on High Overload				
• HO power		45 kW	55 kW	75 kW
• HO input current		108 A	132 A	169 A
• HO output current		90 A	110 A	145 A
General values				
• Power loss		1.5 kW	2.0 kW	2.4 kW
• Fuse		160 A	200 A	250 A
• Cooling air requirement		150 l/s	150 l/s	150 l/s
• Cable cross-section for line and motor connection		35 ... 120 mm ²	35 ... 120 mm ²	35 ... 120 mm ²
• Torque for line and motor and motor connection		13 Nm	13 Nm	13 Nm
• Weight with filter		52 kg	52 kg	52 kg
• Weight without filter		36 kg	36 kg	36 kg

Table 10- 8 PM240 frame size F, 3-ph. 380 V AC... 480 V, ± 10 %

Order number	Without filter	6SL3224-0BE38-8UA0	6SL3224-0BE41-1UA0
Values based on Low Overload			
• LO power		110 kW	132 kW
• LO input current		234 A	284 A
• LO output current		205 A	250 A
Values based on High Overload			
• HO power		90 kW	110 kW
• HO input current		205 A	235 A
• HO output current		178 A	205 A
General values			
• Power loss		2.4 kW	2.5 kW
• Fuse		250 A	315 A
• Cooling air requirement		150 l/s	150 l/s
• Cable cross-section for line and motor connection		35 ... 120 mm ²	35 ... 120 mm ²
• Torque for line and motor and motor connection		13 Nm	13 Nm
• Weight		39 kg	39 kg

Technical data

10.3 Technical data, Power Modules

Table 10- 9 PM240 frame size GX, 3-ph. 380 V AC... 480 V, ± 10 %

Order number	Without filter	6SL3224-0BE41-3UA0	6SL3224-0BE41-6UA0	6SL3224-0BE42-0UA0
Values based on Low Overload				
• LO power		160 kW	200 kW	250 kW
• LO input current		297 A	354 A	442 A
• LO output current		302 A	370 A	477 A
Values based on High Overload				
• HO power		132 kW	160 kW	200 kW
• HO input current		245 A	297 A	354 A
• HO output current		250 A	302 A	370 A
General values				
• Power loss		3.9 kW	4.4 kW	5.5 kW
• Fuse		355 A	400 A	630 A
• Cooling air requirement		360 l/s	360 l/s	360 l/s
• Cable cross-section for line and motor connection		95 ... 240 mm ²	120 ... 240 mm ²	185 ... 240 mm ²
• Torque for line and motor and motor connection		14 Nm	14 Nm	14 Nm
• Weight		176 kg	176 kg	176 kg

10.3.2 Technical data, PM240-2

Note

The given input currents are valid for operation without a line reactor for a line voltage of 400 V with $V_k = 1\%$ referred to the rated power of the inverter. If a line reactor is used, the specified values are reduced by a few percent.

General data, PM240-2

Feature	Specification
Line voltage	3-ph. 380 V ... 480 V AC $\pm 10\%$ The actual permissible line voltage depends on the installation altitude
Input frequency	47 Hz ... 63 Hz
Modulation depth	93 % (the maximum output voltage is 93 % of the input voltage)
Power factor λ	0.7
Line impedance	$\geq 1\% U_k$, for higher values, a line reactor must be used.
Starting current	Less than the input current
Pulse frequency (factory setting)	4 kHz The pulse frequency can be increased up to 16 kHz in 2 kHz steps. A higher pulse frequency reduces the permissible output current.
Electromagnetic compatibility	The devices are suitable for environmental classes C1 and C2 in conformance with IEC61800-3. For details, see the Hardware Installation Manual, Appendix A2
Braking methods	DC braking, compound braking, dynamic braking with integrated braking chopper
Degree of protection	IP20
Operating temperature	
• without power reduction	LO operation 0 °C ... +40 °C (32 °F ... 104 °F) HO operation 0 °C ... +50 °C (32 °F ... 122 °F)
• with power reduction	LO/HO up to 60 °C (140 °F), for details see the Hardware Installation Manual
Storage temperature	-40 °C ... +70 °C (-40 °F ... 158 °F)
Relative humidity	< 95 % RH - condensation not permissible
Environmental requirements	Protected according to environmental class 3C2 to EN 60721-3-3 against damaging chemical substances
Shock and vibration	Do not allow the inverter to fall and avoid it being subject to hard shocks. Do not install the inverter in an area where it could be continuously subject to vibration.
Electromagnetic radiation	Do not install the inverter close to sources of electromagnetic radiation.
Installation altitude	
• without power reduction	Up to 1000 m (3300 ft) above sea level
• with power reduction	up to 4000 m (13000 ft) above sea level, for details see the Hardware Installation Manual.
Standards	UL, CE,, SEMI F47 In order that the system is UL-compliant, UL-certified fuses, overload circuit-breakers or intrinsically safe motor protection devices must be used.

Performance dependent data - PM240-2

Table 10- 10 Frame size A, 3-ph. 380 V ... 480 V AC, ± 10 % - Part 1

Order number	With filter	6SL3210-1PE11-8AL0	6SL3210-1PE12-3AL0	6SL3210-1PE13-2AL0
	Without filter	6SL3210-1PE11-8UL0	6SL3210-1PE12-3UL0	6SL3210-1PE13-2UL0
Values based on Low Overload				
• LO power		0.55 kW	0.75 kW	1.1 kW
• LO input current		2.3 A	2.9 A	4.1 A
• LO output current		1.7 A	2.2 A	3.1 A
Values based on High Overload				
• HO power		0.37 kW	0.55 kW	0.57 kW
• HO input current		2 A	2.6 A	3.3 A
• HO output current		1.3 A	1.7 A	2.2 A
General values				
• Power loss		0.04 kW	0.05 kW	0.06 kW
• Fuse		3NA3 801 (6 A)	3NA3 801 (6 A)	3NA3 801 (6 A)
• Cooling air requirement		5 l/s	5 l/s	5 l/s
• Cable cross-section for line and motor connection		1.0 ... 2.5 mm ²	1.0 ... 2.5 mm ²	1.0 ... 2.5 mm ²
• Torque for line and motor and motor connection		0.5 Nm	0.5 Nm	0.5 Nm
• Weight filtered		1.5 kg	1.5 kg	1.5 kg
unfiltered		1.4 kg	1.4 kg	1.4 kg

Table 10- 11 Frame size A, 3-ph. 380 V ... 480 V AC, ± 10 % - Part 2

Order number	with filter, IP20 without filter, IP20 with filter, PT without filter, PT	6SL3210-1PE14-3AL0 6SL3210-1PE14-3UL0 --- ---	6SL3210-1PE16-1AL0 6SL3210-1PE16-1UL0 6SL3211-1PE16-1AL0 ---	--- 6SL3210-1PE18-0UL0 --- 6SL3210-1PE18-0UL0
Values based on Low Overload				
• LO power		1.5 kW	2.2 kW	3 kW
• LO input current		5.5 A	7.7 A	10.1 A
• LO output current		4.1 A	5.9 A	7.7 A
Values based on High Overload				
• HO power		1.1 kW	1.5	2.2 kW
• HO input current		4.7 A	6.1 A	8.8 A
• HO output current		3.1 A	4.1 A	5.9 A
General values				
• Power loss		0.07 kW	0.1 kW ¹⁾	0.12 kW ²⁾
• Fuse		3NA3 803 (10 A)	3NA3 803 (10 A)	3NA3 805 (16 A)
• Cooling air requirement IP20		5 l/s	5 l/s	5 l/s
PT		---	7 l/s	7 l/s
• Cable cross-section for line and motor connection		1.0 ... 2.5 mm ²	1.5 ... 2.5 mm ²	1.5 ... 2.5 mm ²
• Torque for line and motor and motor connection		0.5 Nm	0.5 Nm	0.5 Nm
• Weight filtered, IP20		1.5 kg	1.5 kg	---
unfiltered, IP20		1.4 kg	1.4 kg	1.4 kg
filtered, PT		---	1.8 kg	---
unfiltered, PT		---	---	1.7 kg

1) for PT devices 0.08 kW above the heat sink;

2) for PT devices 0.1 kW above the heat sink

10.3.3 Technical data, PM250

General data, PM250 - IP20

Feature	Version
Line voltage	3-ph. 380 V ... 480 V AC \pm 10 % The actual permissible line voltage depends on the installation altitude
Input frequency	47 Hz ... 63 Hz
Modulation depth	93 % (the maximum output voltage is 93 % of the input voltage)
Power factor λ	0.9
Starting current	Less than the input current
Pulse frequency (factory setting)	4 kHz The pulse frequency can be increased up to 16 kHz in 2 kHz steps. A higher pulse frequency reduces the permissible output current.
Electromagnetic compatibility	The devices are suitable for environmental classes C1 and C2 in conformance with IEC61800-3. For details, see the Hardware Installation Manual, Appendix A2
Braking method	DC braking, energy recovery (up to 100% of the output power)
Degree of protection	IP20
Operating temperature	
• without power reduction	LO operation: 0 °C ... +40 °C (32 °F ... 104 °F) HO operation: 0 °C ... +50 °C (32 °F ... 122 °F)
• with power reduction	HO/LO up to 60 °C (140 °F), for details see the Hardware Installation Manual
Storage temperature	-40 °C ... +70 °C (-40 °F ... 158 °F)
Relative humidity	< 95 % RH - condensation not permissible
Environmental requirements	Protected according to environmental class 3C2 to EN 60721-3-3 against damaging chemical substances
Shock and vibration	Do not allow the inverter to fall and avoid it being subject to hard shocks. Do not install the inverter in an area where it could be continuously subject to vibration.
Electromagnetic radiation	Do not install the inverter close to sources of electromagnetic radiation.
Installation altitude	
• without power reduction	Up to 1000 m (3300 ft) above sea level
• with power reduction	up to 4000 m (13000 ft) above sea level, for details see the Hardware Installation Manual.
Standards	UL, CE, CE, SEMI F47 In order that the system is UL-compliant, UL-certified fuses, overload circuit-breakers or intrinsically safe motor protection devices must be used.

Power-dependent data, PM250 - IP20

Table 10- 12 PM250 frame size C, 3-ph. 380 V AC... 480 V, ± 10 %

Order number	6SL3225-0BE25-5AA0	6SL3225-0BE27-5AA0	6SL3225-0BE31-1AA0
Values based on Low Overload			
• LO power	7.5 kW	11.0 kW	15 kW
• LO input current	18.0 A	25.0 A	32.0 A
• LO output current	18.0 A	25.0 A	32.0 A
Values based on High Overload			
• HO power	5.5 kW	7.5 kW	11.0 kW
• HO input current	13.2 A	19.0 A	26.0 A
• HO output current	13.2 A	19.0 A	26.0 A
General values			
• Power loss	Available soon	Available soon	Available soon
• Fuse	20 A	32 A	35 A
• Cooling air requirement	38 l/s	38 l/s	38 l/s
• Cable cross-section for line and motor connection	2.5 ... 10 mm ²	4 ... 10 mm ²	6 ... 10 mm ²
• Torque for line and motor and motor connection	2.3 Nm	2.3 Nm	2.3 Nm
• Weight	7.5 kg	7.5 kg	7.5 kg

Table 10- 13 PM250 frame size D, 3-ph. 380 V AC... 480 V, ± 10 %

Order number	6SL3225-0BE31-5AA0	6SL3225-0BE31-8AA0	6SL3225-0BE32-2AA0
Values based on Low Overload			
• LO power	18.5 kW	22.0 kW	30 kW
• LO input current	36.0 A	42.0 A	56.0 A
• LO output current	38.0 A	45.0 A	60.0 A
Values based on High Overload			
• HO power	15.0 kW	18.5 kW	22.0 kW
• HO input current	30.0 A	36.0 A	42.0 A
• HO output current	32.0 A	38.0 A	45.0 A
General values			
• Power loss	0.44 kW	0.55 kW	0.72 kW
• Fuse	50 A	63 A	80 A
• Cooling air requirement	22 l/s	22 l/s	39 l/s
• Cable cross-section for line and motor connection	10 ... 35 mm ²	10 ... 35 mm ²	16 ... 35 mm ²
• Torque for line and motor and motor connection	6 Nm	6 Nm	6 Nm
• Weight	15 kg	15 kg	16 kg

Technical data

10.3 Technical data, Power Modules

Table 10- 14 PM250 frame size E, 3-ph. 380 V AC... 480 V, ± 10 %

Order number	6SL3225-0BE33-0AA0	6SL3225-0BE33-7AA0
Values based on Low Overload		
• LO power	37 kW	45 kW
• LO input current	70 A	84 A
• LO output current	75 A	90 A
Values based on High Overload		
• HO power	30.0 kW	37.0 kW
• HO input current	56 A	70 A
• HO output current	60 A	75 A
General values		
• Power loss	1 kW	1.3 kW
• Fuse	100 A	125 A
• Cooling air requirement	22 l/s	39 l/s
• Cable cross-section for line and motor connection	25 ... 35	25 ... 35
• Torque for line and motor and motor connection	6 Nm	6 Nm
• Weight	21 kg	21 kg

Table 10- 15 PM250 frame size F, 3-ph. 380 V AC... 480 V, ± 10 %

Order number	6SL3225-0BE34-5AA0	6SL3225-0BE35-5AA0	6SL3225-0BE37-5AA0
Values based on Low Overload			
• LO power	55.0 kW	75 kW	90 kW
• LO input current	102 A	190 A	223 A
• LO output current	110 A	145 A	178 A
Values based on High Overload			
• HO power	45.0 kW	55.0 kW	75 kW
• HO input current	84 A	103 A	135 A
• HO output current	90 A	110 A	145 A
General values			
• Power loss	1.5 kW	2 kW	2.4 kW
• Fuse	160 A	200 A	250 A
• Cooling air requirement	94 l/s	94 l/s	117 l/s
• Cable cross-section for line and motor connection	35 ... 150 mm ²	70 ... 150 mm ²	95 ... 150 mm ²
• Torque for line and motor and motor connection	13 Nm	13 Nm	13 Nm
• Weight	51.0 kg	51.0 kg	51.0 kg

10.3.4 Technical data, PM250-2

General data, PM250-2

Feature	Specification
Line voltage	3-ph. 380 V ... 480 V AC \pm 10 % The actual permissible line voltage depends on the installation altitude
Input frequency	47 Hz ... 63 Hz
Modulation depth	87 % (the maximum output voltage is 87 % of the input voltage)
Power factor λ	0.95
Line impedance	\leq 1 % U_k
Starting current	Less than the input current
Pulse frequency (factory setting)	4 kHz The pulse frequency can be increased up to 16 kHz in 2 kHz steps. A higher pulse frequency reduces the permissible output current.
Electromagnetic compatibility	The devices are suitable for environmental classes C1 and C2 in conformance with IEC61800-3. For details, see the Hardware Installation Manual, Appendix A2
Braking methods	DC braking, energy recovery (up to 100% of the output power)
Degree of protection	IP20
Operating temperature	
<ul style="list-style-type: none"> • without power reduction • with power reduction 	LO operation 0 °C ... +40 °C (32 °F ... 104 °F) HO operation 0 °C ... +50 °C (32 °F ... 122 °F) LO/HO up to 60° C (140° F), for details see the Hardware Installation Manual
Storage temperature	-40 °C ... +70 °C (-40 °F ... 158 °F)
Relative humidity	< 95 % RH - condensation not permissible
Environmental requirements	Protected according to environmental class 3C2 to EN 60721-3-3 against damaging chemical substances
Shock and vibration	Do not allow the inverter to fall and avoid it being subject to hard shocks. Do not install the inverter in an area where it could be continuously subject to vibration.
Electromagnetic radiation	Do not install the inverter close to sources of electromagnetic radiation.
Installation altitude	
<ul style="list-style-type: none"> • without power reduction • with power reduction 	Up to 1000 m (3300 ft) above sea level up to 4000 m (13000 ft) above sea level, for details see the Hardware Installation Manual.
Standards	UL, CE, SEMI F47 In order that the system is UL-compliant, UL-certified fuses, overload circuit-breakers or intrinsically safe motor protection devices must be used.

Performance dependent data, PM250-2

Table 10- 16 Frame sizes A, 3-ph. 380 V ... 480 V AC, ± 10 % - Part 1

Order No.	with filter, IP20 without filter, IP20	6SL3210-1QE11-8AL0 6SL3210-1QE11-8UL0	6SL3210-1QE12-3AL0 6SL3210-1QE12-3UL0	6SL3210-1QE13-2AL0 6SL3210-1QE13-2UL0
Values based on Low Overload				
• LO power		0.55 kW	0.75 kW	1.1 kW
• LO input current		1.9 A	2.4 A	3.3 A
• LO output current		1.7 A	2.2 A	3.1 A
Values based on High Overload				
• HO power		0.37 kW	0.55 kW	0.75 kW
• HO input current		1.7 A	2.1 A	2.7 A
• HO output current		1.3 A	1.7 A	2.2 A
General values				
• Power loss		0.05 kW	0.05 kW	0.06 kW
• Fuse		3NA3 801 (6 A)	3NA3 801 (6 A)	3NA3 801 (6 A)
• Cooling air requirement		5 l/s	5 l/s	5 l/s
• Cable cross-section for line and motor connection		1.0 ... 2.5 mm ²	1.0 ... 2.5 mm ²	1.0 ... 2.5 mm ²
• Torque for line and motor connection		0.5 Nm	0.5 Nm	0.5 Nm
• Weight	with filter without filter	1.5 kg 1.4 kg	1.5 kg 1.4 kg	1.5 kg 1.4 kg

Table 10- 17 Frame sizes A, 3-ph. 380 V ... 480 V AC, ± 10 % - Part 2

Order No.	with filter, IP20 without filter, IP20 with filter, PT without filter, PT	6SL3210-1QE14-3AL0 6SL3210-1QE14-3UL0 --- ---	6SL3210-1QE16-1AL0 6SL3210-1QE16-1UL0 --- ---	6SL3210-1QE18-0AL0 6SL3210-1QE18-0UL0 6SL3211-1QE18-0AL0 6SL3211-1QE18-0UL0
Values based on Low Overload				
• LO power		1.5 kW	2.2 kW	3 kW
• LO input current		4.5 A	6.3 A	8.3 A
• LO output current		4.1 A	5.9 A	7.7 A
Values based on High Overload				
• HO power		1.1 kW	1.5 kW	2.2 kW
• HO input current		3.9 A	5 A	7.2 A
• HO output current		3.1 A	4.1 A	5.9 A
General values				
• Power loss		0.08 kW	0.11 kW	0.15 kW ¹⁾
• Fuse		3NA3 803 (10 A)	3NA3 803 (10 A)	3NA3 805 (16 A)
• Cooling air requirement		5 l/s	5 l/s	5 l/s
IP20		---	---	7 l/s
PT				
• Cable cross-section for line and motor connection		1.0 ... 2.5 mm ²	1.5 ... 2.5 mm ²	1.5 ... 2.5 mm ²
• Torque for line and motor connection		0.5 Nm 1.5 kg	0.5 Nm 1.5 kg	0.5 Nm 1.5 kg
• Weight	with filter, IP20	1.4 kg	1.4 kg	1.4 kg
	without filter, IP20	---	---	1.8 kg
	with filter, PT	---	---	1.7 kg
	without filter, PT	---	---	---

1) for PT devices 0.12 kW above the heat sink

Technical data

10.3 Technical data, Power Modules

Table 10- 18 Frame sizes B, 3-ph. 380 V ... 480 V AC, ± 10 % - Part 1

Order No.	with filter, IP20 without filter, IP20 with filter, PT without filter, PT	6SL3210-1QE21-0AL0 6SL3210-1QE21-0UL0 --- ---	6SL3210-1QE21-3AL0 6SL3210-1QE21-3UL0 --- ---	6SL3210-1QE21-8AL0 6SL3210-1QE21-8UL0 6SL3211-1QE21-8AL0 6SL3211-1QE21-8UL0
Values based on Low Overload				
• LO power		4 kW	5.5 kW	7.5 kW
• LO input current		10.8 A	14 A	19.1 A
• LO output current		10.2	13.2	18
Values based on High Overload				
• HO power		3 kW	4 kW	5.5 kW
• HO input current		9.3 A	12.3 A	15.9 A
• HO output current		7.7	10.2	13.2
General values				
• Power loss		0.14 kW	0.19 kW	0.27 kW ¹⁾
• Fuse		3NA3 805 (16 A)	3NA3 807 (20 A)	3NA3 810 (25 A)
• Cooling air requirement		9 l/s	9 l/s	9 l/s
IP20		9 l/s	9 l/s	9 l/s
PT				
• Cable cross-section for line and motor connection		4.0 ... 6.0 mm ²	4.0 ... 6.0 mm ²	4.0 ... 6.0 mm ²
• Torque for line and motor connection		0.5 Nm	0.5 Nm	0.5 Nm
• Weight		3.1 kg	3.1 kg	3.1 kg
with filter, IP20		2.9 kg	2.9 kg	2.9 kg
without filter, IP20		---	---	3.6 kg
with filter, PT		---	---	3.4 kg
without filter, PT		---	---	---

1) for PT devices 0.24 kW above the heat sink

10.3.5 Technical data, PM260

General data, PM260 - IP20

Feature	Version
Line voltage	3-ph. 660 V ... 690 V AC \pm 10% The permissible line voltage depends on the installation altitude The power units can also be operated with a minimum voltage of 500 V -10 %. In this case, the power is linearly reduced as required.
Input frequency	47 Hz ... 63 Hz
Power factor λ	0.9
Starting current	Less than the input current
Pulse frequency	16 kHz
Electromagnetic compatibility	The devices are suitable for environmental classes C1 and C2 in conformance with IEC61800-3. For details, see the Hardware Installation Manual, Appendix A2
Braking method	DC braking, energy recovery (up to 100% of the output power)
Degree of protection	IP20
Operating temperature	
<ul style="list-style-type: none"> • without power reduction • with power reduction 	LO operation: 0 °C ... +40 °C (32 °F ... 104 °F) HO operation: 0 °C ... +50 °C (32 °F ... 122 °F) HO/LO up to 60 °C (140 °F), for details see the Hardware Installation Manual
Storage temperature	-40 °C ... +70 °C (-40 °F ... 158 °F)
Relative humidity	< 95% RH - condensation not permissible
Environmental requirements	Protected according to environmental class 3C2 to EN 60721-3-3 against damaging chemical substances
Shock and vibration	Do not allow the inverter to fall and avoid it being subject to hard shocks. Do not install the inverter in an area where it could be continuously subject to vibration.
Electromagnetic radiation	Do not install the inverter close to sources of electromagnetic radiation.
Installation altitude	
<ul style="list-style-type: none"> • without power reduction • with power reduction 	Up to 1000 m (3300 ft) above sea level up to 4000 m (13000 ft) above sea level, for details see the Hardware Installation Manual.
Standards	CE, C-TICK

Power-dependent data, PM260 - IP20

Table 10- 19 PM260 frame size D, 3-ph. 660 V AC... 690 V, ± 10% (500 V - 10%)

Order number	with filter without filter	6SL3225- 0BH27-5AA1 6SL3225- 0BH27-5UA1	6SL3225- 0BH31-1AA1 6SL3225- 0BH31-1UA1	6SL3225- 0BH31-5AA1 6SL3225- 0BH31-5UA1
Values based on Low Overload				
• LO power		11 kW	15 kW	18.5 kW
• LO input current		13 A	18 A	22 A
• LO output current		14 A	19 A	23 A
Values based on High Overload				
• HO power		7.5 kW	11 kW	15 kW
• HO input current		10 A	13 A	18 A
• HO output current		10 A	14 A	19 A
General values				
• Power loss		No data	No data	No data
• Fuse		25 A	35 A	35 A
• Cooling air requirement		44 l/s	44 l/s	44 l/s
• Cable cross-section for line and motor connection		2.5 ... 16 mm ²	2.5 ... 16 mm ²	2.5 ... 16 mm ²
• Torque for line and motor connection		1.5 Nm	1.5 Nm	1.5 Nm
• Weight with filter		23 kg	23 kg	23 kg
• without filter		22 kg	22 kg	22 kg

Table 10- 20 PM260 frame size F, 3-ph. 660 V AC... 690 V, ± 10% (500 V - 10%)

Order number	with filter without filter	6SL3225- 0BH32-2AA1 6SL3225- 0BH32-2UA1	6SL3225- 0BH33-0AA1 6SL3225- 0BH33-0UA1	6SL3225- 0BH33-7AA1 6SL3225- 0BH33-7UA1
Values based on Low Overload				
• LO power		30 kW	37 kW	55 kW
• LO input current		34 A	41 A	60 A
• LO output current		35 A	42 A	62 A
Values based on High Overload				
• HO power		22 kW	30 kW	37 kW
• HO input current		26 A	34 A	41 A
• HO output current		26 A	35 A	42 A
General values				
• Power loss		No data	No data	No data
• Fuse		63 A	80 A	100 A
• Cooling air requirement		130 l/s	130 l/s	130 l/s
• Cable cross-section for line and motor connection		10 ... 35 mm ²	10 ... 35 mm ²	10 ... 35 mm ²
• Torque for line and motor connection		6 Nm	6 Nm	6 Nm
• Weight with filter		58 kg	58 kg	58 kg
• without filter		56 kg	56 kg	56 kg

Index

8

87 Hz characteristic, 45

A

Acceptance test, 224

 Authorized person, 224

 Preconditions, 224

 reduced, 225, 240, 241

 Requirements, 224

 Test scope, 225

Acceptance test certificate, 224

Adjustable parameters, 16

Alarm, 243, 246

Alarm buffer, 246

Alarm code, 246

Alarm history, 247

Alarm time, 246

Alarm value, 246

Ambient temperature, 58, 178

Analog inputs, 52, 53, 62, 64, 65, 66, 67

Analog outputs, 52, 53, 63, 64, 65, 66, 67

 Functions of the, 100

Authorized person, 224

Automatic mode, 230

Automatic restart, 205

B

Back up

 Parameter, 239

Back up parameters, 239

Basic Operator Panel, 25

Basic Safety, 53, 95

 via F-DI, 221

Baud rates, 79

BF (Bus Fault), 244

BICO block, 20

BICO parameters, 21

BICO technology, 21

Binectors, 20

Bit pattern test, 217

Block, 20

Blocking protection, 181

Boost parameter, 172

BOP-2, 25

 Display, 68

 Menu, 69

Brake Relay, 197

Braking

 Regenerative, 196

Braking chopper, 194

Braking method, 189

Braking resistor, 194

Break loose torque, 19

Bus fault, 244

Bus termination, 51

C

CDS, 230

CDS (Command Data Set), 223

Centrifuge, 187, 190, 192, 196

Changing parameters

 BOP-2, 70

 STARTER, 84

Characteristic

 ECO mode, 171

 Linear, 170

 parabolic, 170

 square-law, 170

 Textile applications, 171

Checksum, 228

Circuit diagram, 229

Clockwise, 157

Command Data Set, 223

Command source, 59, 156

 Default setting, 61

 Selecting, 18, 158

Commissioning

 Guidelines, 56

Compound braking, 192, 193

Compressor, 168

Configuration Manual, 13

Connectors, 20

Consistency, 216

Consistent signals, 216

Contact bounce, 217

Control Data Set, CDS, 230

Control mode, 19, 59

Control panel, 84

Control terminals, 64, 65, 66, 67

Control Unit

- Updating, 225
- Control Units, 25
- Control word, 113
- Control word 1, 114
- Control word 3, 115
- Conveyor belt, 190
- Copy
 - Series commissioning, 225
- Copy parameters
 - Series commissioning, 225
- Counterclockwise, 157
- Countersignatures, 229
- Crane, 187, 196, 201
- Current input, 98
- Current output, 63, 101
- Customer support, 220

D

- Data backup, 86, 87, 89, 229
- Data set changeover, 223
- Data transfer, 86, 87, 89
- DC braking, 115, 190, 191
- DC link overvoltage, 179
- DC link voltage, 179
- Default settings, 60
- Default terminal settings, 62
- Delta connection (Δ), 45, 58
- DI (Digital Input), 95, 223
- Digital input, 62
 - Fail-safe, 53
- Digital inputs, 52, 53, 64, 65, 66, 67
 - Multiple assignment, 223
- Digital output, 62
- Digital outputs, 52, 53, 64, 65, 66, 67
 - Functions of the, 94, 96
- DIP switch
 - Analog input, 98
 - Bus address, 104
- Direction reversal, 157
- Discrepancy, 216
 - Filter, 216
 - Tolerance time, 216
- Display parameters, 16
- Down ramp, 18
- Download, 55, 86, 87, 89
- Drive Data Set, DDS, 233
- Drive Data Sets, 233

E

- Electromagnetic interference, 46
- Electromechanical sensor, 214
- Elevator, 201
- Emergency stop control device, 214
- End customer, 226
- Energy recovery option, 179, 196
- Expert list, 85
- Extended Safety, 95
- Extruders, 169

F

- Factory assignment, 64, 66
- Factory pre-assignment, 65, 67
- Factory settings, 61, 62, 92
 - Restoring the, 92
- Fail-safe digital input, 95
- Fans, 168, 187, 197
- Fault, 244
 - Acknowledgment, 251, 252
- Fault buffer, 251
- Fault case, 251
- Fault code, 251
- Fault history, 253
- Fault time, 251
 - received, 251
 - removed, 251
- Fault value, 251
- F-DI (Fail-safe Digital Input), 95
- F-digital output module, 216
- FFC (Flux Current Control), 171
- Field weakening, 45
- Fieldbus interfaces, 51
- Filter, 216
 - Contact bounce, 217
 - Discrepancy, 216
 - On/off test, 217
- Firmware
 - Updating, 225
- Firmware update, 244
- Firmware version, 18, 226
- Flow control, 209
- Flying restart, 203, 204
- Follow-on parameterization, 16
- Forced dormant error detection, 219
- Formatting, 87
- Frame size, 27
- Frame sizes, 27
- FS (Frame Size), 27
- Function blocks

Free, 210, 212
 Function Manual for Safety Integrated, 13
 Function table, 227
 Function test
 STO, 227
 Functional expansions, 225
 functions
 Technological, 156
 Functions
 BOP-2, 69
 Overview, 155

G

Getting Started, 13
 Grinding machine, 187, 190, 192
 GSD (Generic Station Description), 108

H

Hardware configuration, 108
 Hardware Installation Manual, 13
 Hoisting gear, 169, 187, 194, 196, 201
 Holding brake, 187
 Horizontal conveyor, 192
 Horizontal conveyors, 168, 194, 197
 Hotline, 11
 HW Config, 107
 HW Config (hardware configuration), 107

I

I2t monitoring, 175
 Identifying motor data, 71, 83, 173, 174
 I_{max} controller, 178
 Inclined conveyors, 169, 187, 194, 197
 IND, 121, 138
 Inserting the BOP-2, 68
 Inserting the operator panel, 68
 Installation, 13
 Installation options, 33
 Intelligent Operator Panel, 25
 Interfaces, 51, 57, 62
 Interlock, 22
 Inverter busy
 Inverter busy, 17
 Inverter control, 156
 Inverter state, 96
 IOP, 25

J

JOG function, 165

K

KTY 84 temperature sensor, 63, 176

L

LED
 BF, 244
 RDY, 244
 SAFE, 245
 LED (light emitting diode), 243
 Level control, 209
 Light curtain, 214, 215
 Line filter, 29, 32
 Line reactor, 29, 32
 Load failure, 183
 Logbook, 228

M

Machine manufacturer, 224
 Machine overview, 226
 Manual mode, 230
 Manuals
 Download, 13
 Overview, 13
 Manufacturer, 226
 Maximum current controller, 178
 Maximum speed, 18, 59, 166
 Memory card, 239
 Formatting, 87
 MMC, 87
 SD, 87
 Menu
 BOP-2, 69
 Operator panel, 69
 Minimum speed, 18, 59, 166
 MLFB, 226
 MMC, 26
 MMC (memory card), 87
 MMC memory card, 26
 Mode of operation, 227
 MOP (motorized potentiometer), 160
 MotID (motor data identification), 71, 83
 Motor connection, 45
 Motor control, 156
 Motor data, 58

Motor holding brake, 187, 198, 200, 201
Motor rating plate, 58
Motor temperature sensor, 52, 63, 64, 65, 66, 67, 177
Motorized potentiometer, 160
Multiple assignment
 Digital inputs, 223

N

No-load monitoring, 181

O

OFF command, 157
ON command, 157
On/off test, 217
Online connection, 80
Operating instructions, 13
Operator panel
 Display, 68
 Menu, 69
Operator Panel, 25
Output reactor, 29, 32
Overload, 19, 178
Overview
 Manuals, 13
 Software tool, 13
Overview of the functions, 155
Overvoltage, 179, 180

P

Page index, 121, 138
Parameter assignment, 15
Parameter channel, 118, 135
 IND, 121, 138
 PKE, 118, 136
 PWE, 121, 139
Parameter identifier, 118, 136
Parameter index, 121, 138
Parameter Manual, 13
parameter number
 Offset of,
Parameter types, 16
Parameters
 Important, 61
 Writing parameters, 17
Password, 220
PC Connection Kit, 26
PID controller, 209
PKE, 118, 136

PKW (parameter, ID, value), 112
PLC functionality, 22
PLC program, 229
Power failure, 205
Power Module, 25, 27
 Technical data, 265, 271, 274, 277, 281
Power Modules
 Technical data, 278
Power ON Reset, 92, 222, 244
Pressure control, 209
Probe, 184
PROFIdrive, 112
PROFIsafe, 109
Protection functions, 156
PTC temperature sensor, 63, 176
PTC/KTY 84, 63
Pump, 168, 197
PWE, 121, 139
PZD (process data), 112

Q

Questions, 11

R

Ramp-down time, 18, 59, 167
Rampup time,
RDY (Ready), 244
Reactors, 29
Regenerative power, 187
Relay output, 62
Removing the BOP-2, 68
Removing the operator panel, 68
Reset
 Parameter, 92
Run sequence, 210
Runtime group, 210

S

SAFE, 245
Safety functions, 156
Safety Integrated Function Manual, 214
Safety relay, 214, 215
Saw, 190, 192
Scaling, 98
 of the analog output, 101
SD, 108
SD (memory card), 87
SD memory card, 26

- Sensor
 - Electromechanical, 215
 - Serial number, 226
 - Series commissioning, 225
 - Setpoint calculation, 166
 - Setpoint processing, 156
 - Setpoint source, 59, 156
 - Selecting, 159
 - Selecting, 159
 - Setting-up the PG/PC interface, 77
 - Short-circuit monitoring, 177
 - Signal interconnection, 20, 21, 23
 - SIMATIC, 105
 - Sine-wave filter, 29
 - SIZER, 13
 - Software tool
 - Download, 13
 - Overview, 13
 - Speed monitoring, 183
 - Deviation, 183
 - Load failure, 183
 - Stall protection, 181
 - Star connection (Y), 45, 58
 - STARTER, 84
 - Starting characteristics
 - Optimization, 172
 - Status messages, 156
 - Status word, 113
 - Status word 1, 116
 - Status word 3, 117
 - STO
 - Function test, 227
 - Storage medium, 86
 - STW (control word), 112
 - STW1 (control word 1), 114
 - STW3 (control word 3), 115
 - Sub-chassis components, 32
 - Sub-D connection, 105
 - Subindex, 121, 138
 - Suggested improvement, 11
 - Support, 11
 - Swap
 - Control Unit, 225
 - Hardware, 225
 - Power Module, 225
 - Synchronous motor, 171
 - System components, 32
 - System runtime, 186
- T**
- Technical data
 - Power Module, 265, 271, 274, 277, 281
 - Technology controller, 115, 209
 - Telegram types, 109, 112
 - Temperature calculation, 178
 - Temperature measurement via KTY, 176
 - Temperature measurement via PTC, 176
 - Temperature monitoring, 175, 176, 178
 - Temperature monitoring via ThermoClick, 177
 - Temperature sensor, 52, 53, 64, 65, 66, 67
 - Terminal overview of CU240B-2, 64
 - Terminal overview of CU240B-2 DP, 65
 - Terminal overview of CU240E-2, 66
 - Terminal overview of CU240E-2 DP, 67
 - Terminal strip, 62
 - Assignment, 64, 66, 67
 - Assignment following basic commissioning, 64, 65, 66, 67
 - Overview, 52, 53
 - Pre-assignment, 65
 - Test signals, 218
 - Test stop, 219
 - ThermoClick temperature sensor, 176
 - Time slices, 210
 - Time stamp, 229
 - Torque monitoring
 - Speed-dependent, 181, 182
 - Two-wire control, 157
- U**
- UL-certified fuses, 264
 - Unwinders, 196
 - Up ramp, 18
 - Updating
 - Control Unit, 225
 - Firmware, 225
 - Upload, 55, 86, 87, 88
 - User interfaces, 51
 - Using the factory settings, 60
- V**
- V/f control, 19, 59, 169
 - additional characteristics), 171
 - Vector control, 19, 59
 - Sensorless, 173
 - Vector control, 19, 59
 - Vector control, 19, 59
 - Version
 - Firmware, 226
 - Hardware, 226

Safety function, 226
Vertical conveyors, 169, 187, 194, 197
Voltage boost, 19, 172, 173
voltage input, 98
Voltage input
 Bipolar, 62
Voltage output, 63, 101

W

Winders, 169, 196
Wire break, 216
Wire-break monitoring, 177

Z

ZSW (status word), 112
ZSW1 (status word 1), 116
ZSW3 (status word 3), 117

Siemens AG
Industry Sector
Drive Technologies
Motion Control Systems
Postfach 3180
91050 ERLANGEN
GERMANY

www.siemens.com/sinamics-g120

We reserve the right to make technical
changes.
© Siemens AG 2010