

H4D-T

Lathe CNC Controller

Manual

Ver : Dec. , 2013

HUST Automation Inc.
No. 80 Kon Yei Road, Toufen, Miaoli, Taiwan
Tel: 886-37-623242
Fax: 886-37- 623241

TABLE OF CONTENTS

1	MAIN FEATURES OF LATHE CNC CONTROLLER	1-1
2	INSTRUCTION	2-1
2.1	Basic Instructions	2-1
	Power-On Display	2-1
	Standby Display	2-1
	Auto Mode Display	2-2
	MDI Mode Display	2-3
	Home Origin Mode Display	2-3
	Jog Mode display	2-4
	Edit Mode display	2-5
	Program Mode Display	2-6
	I/O Mode Display	2-8
	Tool Compensation Display	2-9
	Graphic mode	2-15
2.2	Program Edition	2-16
2.2.1	Programming Introduction	2-16
2.2.1.1	Part Program	2-16
2.2.1.2	Methods Of Programming	2-16
2.2.1.3	The Composition of A Part Program	2-18
2.2.1.4	Coordinate System	2-20
2.2.1.5	Control Range	2-25
2.2.2	Program Editing	2-26
2.2.2.1	Program Selection	2-26
2.2.2.2	New Program Editing	2-27
2.2.2.3	Program Revision	2-30
2.2.2.4	Rules for Numerical Input	2-33
2.2.2.5	Notes on Program Edit	2-34
3	G/M Codes	3-1
3.1	Command codes	3-1
3.2	Positioning, G00	3-4
3.3	Linear Interpolation, G01	3-5

3.4	Circular Interpolation, G02 & G03	3-7
3.5	Dwell, G04	3-11
3.6	Parabolic Cutting, G05	3-12
3.7	Exact Stop Check, G09. G61, G62	3-15
3.8	Spindle Positioning Command, G15	3-16
3.9	Cylindrical Plane, G16	3-16
3.10	Plane Setup, G17~G19	3-20
3.11	Automatic Reference Position Return, G28	3-23
3.12	Retrun From Reference Position, G29	3-24
3.13	2 nd Reference Position Return, G30	3-25
3.14	Thread Cutting, G32	3-26
3.15	G33 Tapping Cutting Canned Cycle	3-30
3.16	G34 Variable Lead Thread Cutting	3-31
3.17	Canned Cycle Functions	3-35
3.17.1	Single Cutting Canned Cycle, G90, G92, G94	3-35
3.17.2	Compound Canned Cycle Functions, G70~G76	3-41
3.18	G50 Coordinate System & Spindle clamp speed setting	3-59
3.19	Constant Surface Speed Control ON, G96	3-60
3.20	Constant surface Speed Control OFF, G97	3-61
3.21	Feed-Rate Setting, G98. G99	3-61
3.22	Inch/Metric Measurement Mode, G20, G21	3-62
3.23	Deep Hole Driling Cycle (Z axis), G83, G80	3-62
3.24	Tapping Cycle, G84, G80	3-63
3.25	Auxiliary Functions, M-code, S-code	3-65
3.26	Subprogram	3-67
3.27	Tool Radius Compensation	3-68
3.27.1	Total Offset Compensation Setting and Cancellation	3-68
3.27.2	Tool-Tip Radius and Direction of Fictitious Tool-Tip, G40~G42	3-70
3.27.3	Interference Check	3-90
3.27.4	Notes of Tool Radius Compensation	3-93
3.28	Coordinate System	3-95
3.28.1	Local Coordinate System Setting, G52	3-95
3.28.2	Basic Machine Coordinate System, G53	3-96
3.28.3	Work Coordinate System, G54~G59	3-97
3.29	Corner Chamfer(,C_), round-angle chamfer (,R_) functions	3-100
3.29.1	Chamfer (,C_)	3-100
3.29.2	Round-angle chamfer (,R_)	3-102
3.30	Liner angle function (,A_)	3-103
3.31	Geometry function command	3-105

3.32	Automatic calculation of Line-Arc Intersection Poing	3-108
------	------------------------------------------------------	-------

4	MCM PARAMETERS	4-1
----------	-----------------------	------------

4.1	MCM Parameter	4-1
4.1.1	Basic Description	4-1
4.1.2	MCM Parameters	4-1
4.2	Description of Parameters	4-5

5	CONNECTIONS	5-1
----------	--------------------	------------

5.1	System Configuration Descriptions	5-1
5.2	System Installation	5-2
5.2.1	Operating Environment	5-2
5.2.2	Considerations for the design of control panel	5-2
5.2.3	Internal temperature Design	5-3
5.2.4	H4D-T External Dimensions	5-4
5.2.5	H4D-T Accessories Dimensions	5-6
5.3	Connector Type	5-8
5.4	Connector Name	5-8
5.5	Connector Pin-out Definiton	5-9
5.5.1	G31 Input Control Singnals	5-12
5.5.2	Axial Control, Pin Assignment and Wiring	5-13
5.5.3	Wiring of Manual Pulse Generator (MPG)	5-14
5.5.4	Wiring of Spindle Control	5-15
5.5.5	I/O Wiring	5-17
5.5.6	I/O Wiring Schematic	5-19
5.5.7	Wiring of System AC Power Supply	5-25
5.5.8	Servo on Wiring Examples	5-26

6	ERROR MESSAGES	6-1
----------	-----------------------	------------

7	MCM (Machine Constant) PARAMETERS	7-1
----------	------------------------------------------	------------

7.1	Description of MCM Machine Constants	7-23
-----	--------------------------------------	------

Input Arrangement	8-1
Output Arrangement	8-2
M-Code Versus I/O	8-2
Compound Canned Cycle Parameters	8-3
PLC Parameters	8-3

1 MAIN FEATURES OF LATHE CNC CONTROLLER

- Controlled Axis: X, Z and Spindle Encoder Feedback
- Program Designed by CAD/CAM on PC. Program input and DNC on-line execution from PC through RS232C interface.
- Memory Capacity for CNC main board - 1024k.
- Battery Backup for CNC program storage in case of power-off.
- Backlash error compensation for worn lead screw.
- Provide 40 sets of tool length offset.
- Self-designed MACRO Program.
- Tool feed rate can be a millimeter per minute or a millimeter each turn.
- Single block and continuous commands.
- Option Skip functions.
- Option Stop and Feed hold functions.
- Simultaneous use of absolute and incremental coordinate in the program.
- Self-diagnostic and error signaling function.
- Direct use of “ R”, “ I” and “ J” incremental value for radius in circular cutting.
- MPG hand-wheel test and collision free function for cutting product at the speed controller by MPG.
- Equipped with 24 standard programmable inputs and 16 outputs.

This operator's manual includes program editing, G/M code, parameter settings, connections and maintenance (plus warn descriptions) with examples and explanations for each command instruction.

If there are any problems in application, please fill out a problem sheet indicating the natures of the problem. Send it by either fax or mail. We will respond to you as soon as possible.

2 INSTRUCTION

2.1 Basic Instructions

Operating Diagrams

● **Power-on Display**

You will see this image after the power is on like the illustration below:

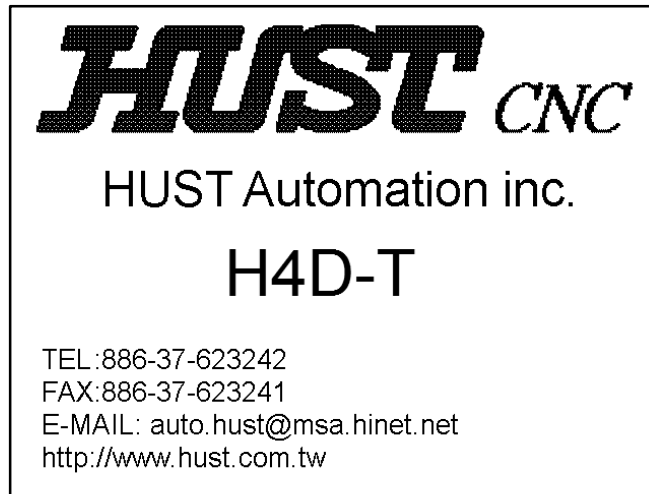

Fig.2-1

● **Standby Display**

After 3 seconds, you will enter the standby display. You can also obtain the same image when you press “Reset” key like the image below:

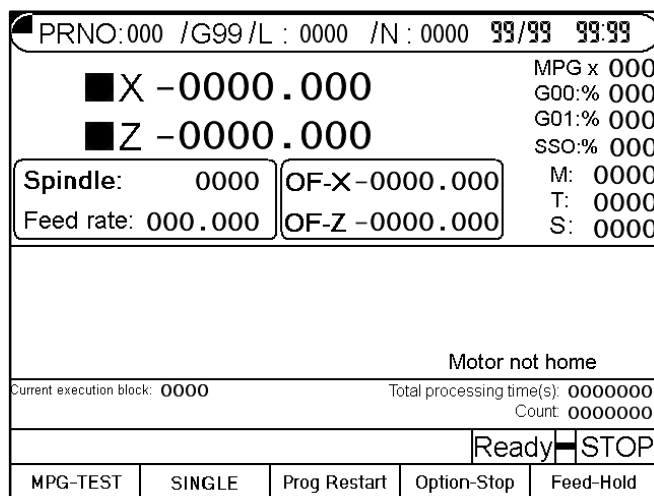

Fig.2-2

● **Auto Mode Display**

Press key “Auto/ MDI” to enter the auto mode, the display is shown below:

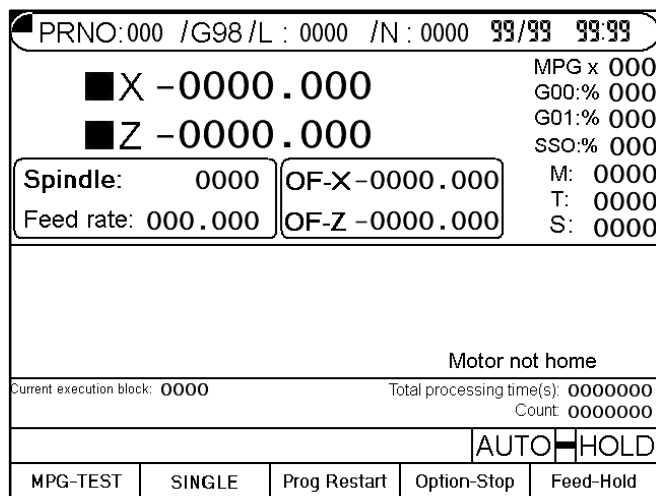

Fig.2-3

Soft keys under the auto mode:

1. Program Feed-Hold: only valid during the program operation.
In the program operation, press the key and the program will stop immediately. You can continue operating the program by press this soft key again or CYCST key.
2. Single Step Execution: users can select the function any time without being limited in the state of operation or stop. This function can only carry one step by each key press of restart instead of executing the whole program continuously.
3. Program Restart: only can be selected before the program execution.
When the program restart is being selected, it will continue the task from the previous single block where it stopped. Users can search the stopped single block or reset the block in the editing display.
4. MPG - TEST: users can select the function any time without being limited in the state of operation or stop. When the function is being selected, the movement of all the axis in the program can only be controlled by MPG. If there is no input of MPG, the axis will stop moving. The users can also use manual key 『X+』、 『Z-』 press to replace MPG.
5. Option Stop: only can be selected before the program execution. When option stop is being selected, M01 commend in the program will be considered as a stop commend. It is meaningless if M01 is not selected.

Part numbers: each execution to M15 will add on one and execution to M16 will return to zero. If users need to return to zero manually, please press the “0” key

twice immediately to return zero.

- ※ When part numbers reach to the parameter counting limit, O13 will output.
Part time: show the current executing time. After each program end or stop, it will automatically return to zero when it restarts.

● MDI Mode Display

Press 『 Auto/ MDI 』 key twice to enter the MDI mode, the display is shown below:

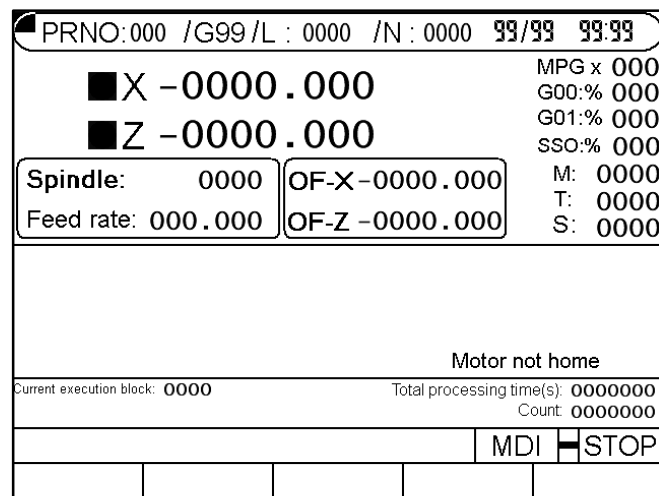

Fig.2-4

● Home Origin Mode Display

Press 『 JOG/HOME 』 key twice to enter the home origin mode, the display is shown below:

H4D-T display

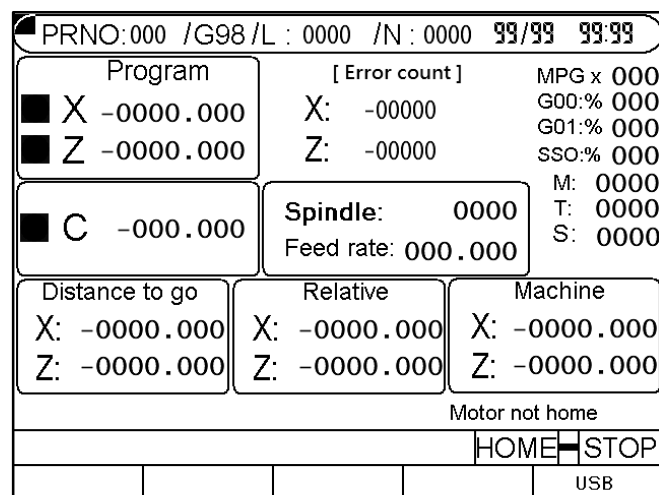

Fig. 2-5

Methods for returning the origin:

1. Select the axis: there are some ways to select the axis. You can either press the English letter “ X ”, “ Z “ on the right of the screen directly or press the key button” X+’, “X-“, “Z+”, “Z-“ to make your selection.
2. Press” CYCST” key

Note: X and Z- axis will be displayed as reversal colors on the screen once they are selected. The initialized screen display is set Z-axis for its starting of origin mode.

● **Jog Mode display**

Press 『 JOG/HOME 』 key to enter jog mode, the display is shown below:

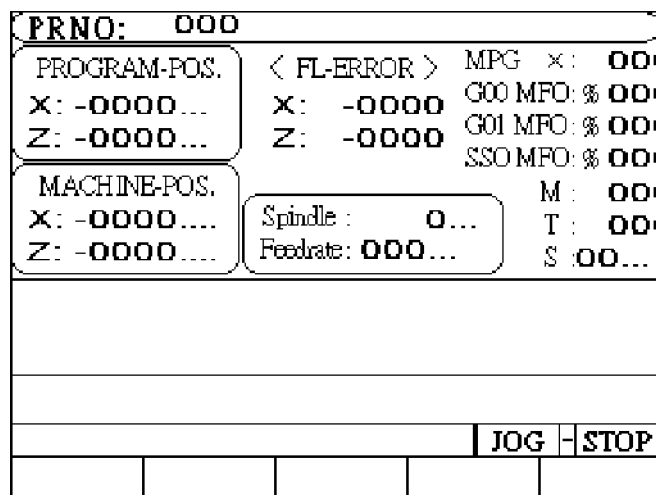

Fig.2-6

There are several functions under the jog mode:

1. Axis positioning:(Three types of positioning)
 - a. Manual jog: select the axis (see the note of home origin mode for reference) to turn the jog. The jog will be in valid if the axis is not selected.
 - b. Continuous movement: (Single step function is not on)
Continuously press “X+” key and X-axis will do positive movement, X-axis will do negative movement. Z-axis is followed the same way.
 - c. Move single step:
Select your desired distance for each single step such as 0.001,0.01,0.1,1 and press X+, X-, Z+,Z-. The system will follow the selection to make the step.

Note: Press the key once more it returns back to continue jog mode.

2. Manual Switch:
 - a. Spindle: Clockwise, Counter Clockwise, Stop.
 - b. Coolant: Press on and off key
 - c. Lubricant: Press the key and it will be provided after 1 second.
LED is the indicator for the operation.

● **Edit Mode display**

Press "Edit/PRNO" to enter the edit mode, the display is shown below:

PRNO:000/G98/L : 0000/N :0000		99/99 99:99
M03S3000 M07 T101 > G00X50. Z80. G90X30. Z30. F0.2 X25. X20. G00X100. Z100. M09		
Motor not home		
X	-0000.000	Z -0000.000
		EDIT <input type="checkbox"/> STOP
	Set Re.N	Last-N

Fig.2-7

This screen mode can be edited directly (Please see the edit chapter for details).

- a. Set-Re.N: In program edit mode, use cursor up and down to assign the single command, press the key, then return the AUTO mode display. It will execute the assign program when press the 『RESTART』 key .
- b. Last-N: When stop the program (If press the Reset 、EM-STOP key ...) , press this key can find the last executed single program.

● **Program Mode Display**

Press twice 『Edit/PRNO』 to enter the program mode, the display is shown below:

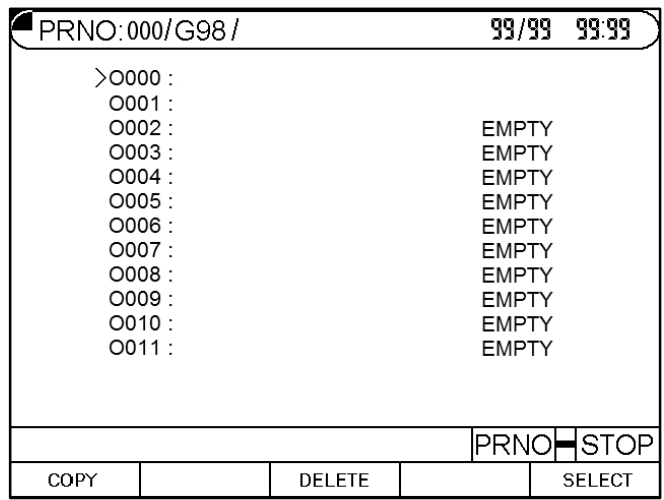

Fig.2-8

Program selecting methods:

1. Select Program:
 - a. Use cursor up and down or page up and down to select the program numbers.
 - b. Press the soft key "Select" or press enter key.
2. Program Note:
 - a. Use cursor up and down or page up and down to select the note numbers.
 - b. Enter the English letter or number.
 - c. Press enter key.
3. Program Delete:
 - a. Use cursor up and down or page up and down to select the delete numbers.
 - b. Press delete key, the dialogue box will appear to confirm your command.
 Press soft key YES or Y to clear the program.
 Press NO or N key to cancel the delete program.
4. Program Copy:
 - a. Press" copy" key, it shows as follows:

PRNO:000/G98/		99/99 99:99	
>O000 :			
O001 :			
O002 :		EMPTY	
O003 :		EMPTY	
O004 :		EMPTY	
O005 :		EMPTY	
O006 :		EMPTY	
O007 :		EMPTY	
O008 :		EMPTY	
O009 :		EMPTY	
O010 :		EMPTY	
O011 :		EMPTY	
SOURCE <u>000</u>		TARGET <u>000</u>	
		PRNO	STOP
Source		Target	Exec.

Fig.2-9

- Use cursor up and down or page up and down to point at the source program numbers.
- Press Source key
- Use cursor up and down or page up and down to select the purpose numbers.
- Press purpose key
- After confirmation for both source and purpose of program numbers, and press executing (Exec.) key. The copy is complete.

● I/O Mode Display

Press twice 『I/O/ MCM』 key to enter I/O mode, the display is shown below:

PRNO:000/G98/		99/99 99:99	
I00 EM-STOP	I12 Tool 1 Position signal		
I01 X Home Limit	I13 Tool 2 Position signal		
I02 Z Home Limit	I14 Tool 3 Position signal		
I03 Foot Switch	I15 Tool 4 Position signal		
I04 Option Skip	I16 Tool 5 Position signal		
I05	I17 Tool 6 Position signal		
I06	I18 Tool 7 Position signal		
I07	I19 Tool 8 Position signal		
I08 CYCST	I20 Turret Clamp		
I09 FEEDHOLD	I21 BAR FEEDER OK		
I10 RESET	I22		
I11 TOOL Change	I23		
X -0000.000		Z -0000.000	
		Ready	STOP
		Output	IOCSA

Fig.2-10



Under this mode it can check the input status of the controller. (Color reversion shows inputting.) Press output soft key, it will cut to the output status display like the figure below:

PRNO:000/G98/		99/99 99:99	
O00 SPINDLE CW	O12		
O01 SPINDLE CCW	O13 WORKPIECE NO. ON		
O02 COOLANT	O14 SERVO ON X		
O03 ALARM LIGHT	O15 SERVO ON Z		
O04 SPINDLE UNCLAMP			
O05 LUBRICATION			
O06 UNCLAMP LIGHT			
O07			
O08 TOOL CW			
O09 TOOL CCW			
O10			
O11 BAR FEED			
X	-0000.000	Y	-0000.000
Z	-0000.000	Ready STOP	
Input			

Fig.2-11

Under this mode it can check the output status of controller. (Color reversion shows outputting.) Press input soft key, it again returns back to input status screen.

IOCSA Monitor : Input page press F5 key

Press   PAGE to change the status

IBIT	0	1	2	3	4	5	6	7	8	9	A	B	C	D	E	F
0000	0	0	0	0	0	0	0	0	0	0	0	0	0	0	0	0
0016	0	0	0	0	0	0	0	0	0	0	0	0	0	0	0	0
0032	0	0	0	0	0	0	0	0	0	0	0	0	0	0	0	0
0048	0	0	0	0	0	0	0	0	0	0	0	0	0	0	0	0
0064	0	0	0	0	0	0	0	0	0	0	0	0	0	0	0	0
0080	0	0	0	0	0	0	0	0	0	0	0	0	0	0	0	0
0096	0	0	0	0	0	0	0	0	0	0	0	0	0	0	0	0
0112	0	0	0	0	0	0	0	0	0	0	0	0	0	0	0	0
0128	0	0	0	0	0	0	0	0	0	0	0	0	0	0	0	0
0144	0	0	0	0	0	0	0	0	0	0	0	0	0	0	0	0
0160	0	0	0	0	0	0	0	0	0	0	0	0	0	0	0	0
0176	0	0	0	0	0	0	0	0	0	0	0	0	0	0	0	0
0192	0	0	0	0	0	0	0	0	0	0	0	0	0	0	0	0
0208	0	0	0	0	0	0	0	0	0	0	0	0	0	0	0	0
0224	0	0	0	0	0	0	0	0	0	0	0	0	0	0	0	0
0240	0	0	0	0	0	0	0	0	0	0	0	0	0	0	0	0

Fig.2-12

● **Tool Compensation Display**

Press 『TOOL.Offset』 to enter offset & wear compensation directly in the tool compensation mode.

Tool offset Compensation				
				Incremental
NO.	X-AXIS	Z-AXIS	T-Radius	T-Dir
00	-0000.000	-0000.000	-0000.000	0
00	-0000.000	-0000.000	-0000.000	0
00	-0000.000	-0000.000	-0000.000	0
00	-0000.000	-0000.000	-0000.000	0
00	-0000.000	-0000.000	-0000.000	0
00	-0000.000	-0000.000	-0000.000	0
00	-0000.000	-0000.000	-0000.000	0
00	-0000.000	-0000.000	-0000.000	0
X	-0000.000 -0000.000		Z	-0000.000 -0000.000
				PAGE
WEAR	OFFSET	MCM	Absoute	Increment

Fig.2-13

Users can utilize the soft key to switch three different screen displays such as tool wear, offset compensations and parameters under this mode.

※ Note : Press the key  the page can be changed.

1. Ways for parameter setting in tool offset compensation are as follows:
 - a. Utilize the cursors to move to the revising parameter.
 - b. Enter numbers.
 - c. Press enter key.
2. Tool wear compensation display is below:

Tool wear Compensation				
Max: 00.000				
			Incremental	
NO.	X-AXIS	Z-AXIS	T-Radius	
00	-0000.000	-0000.000	-0000.000	
00	-0000.000	-0000.000	-0000.000	
00	-0000.000	-0000.000	-0000.000	
00	-0000.000	-0000.000	-0000.000	
00	-0000.000	-0000.000	-0000.000	
00	-0000.000	-0000.000	-0000.000	
00	-0000.000	-0000.000	-0000.000	
00	-0000.000	-0000.000	-0000.000	
X	-0000.000 -0000.000		Z	-0000.000 -0000.000
				PAGE
WEAR	OFFSET	MCM	Absoute	Increment

Fig.2-14

Tool offset compensation setting are as follows:

- a. Utilized the cursors to move to the revising parameter.
- b. Enter numbers.
- c. Press enter key.

3. Parameters display is followed:

G71,G72 go into	-00.000inch		-00.000 inch
G73 amount cutting	-00.000inch		-00.000 inch
G71,G72 retreat	-00.000inch	G73 Segmentation	0000
G74,G75 retreat	-00.000inch	G76 Fine cutting	0000
G76 Angle of tool tip	0000	G76 Chamfer Len	0000
G76 Depth of min cutting	-00.000 inch	G76 Retreat	-00.000 inch
MPG Direction	1:X-Z+ 4:X+Z- 5:X-Z-	0	Graphic proportion 0000.000
G84 Dwell at bottom time	000000	Multi-purpose MPG 1:Yes	0
G84 Acc/Dec fine time	000000	0:Diameter 1:Radius	0
G83 Buffer distance	0000.000	Clamp type 0:inside 1:outside	0
Chuck locked delay time	000000	Metric 0:mm 1:inch	0
Wait for SP speed reaching	0	Screen saver 0:Yes	0
MPG test feedrate Num.	0000	Restart M98 skip 1:Yes	0
MPG test feedrate Den.	0000	Non-stop mode 256:Yes	000
Back Main			
SYSTEM MCM		VERSION	G54~G59

Fig.2-15

Restart, MTS GO4 0:skip	0	Dynamic Acc/Dec 1:Yes	0
Restart, block refetch 0:Yes	0	Edit omit decimal 1:Yes	0
Exec. home after EM-STOP 1:Yes	0	Acc/Dec type	0
G92 A/D time of travel end	0000	Remaining days	0000000
Tapping Acc/Dec time(ms)	0000	Corner connection 1:G02/G03 2:G01/G02/G03	0
G41/G42 interference deal with 0,1,2	0	Monitor function 1:Yes	0
G01 Acc/Dec time	000000	G00 Acc/Dec time	000000
G99 Acc/Dec time	000000	MPG Acc/Dec time	000000
Home setting 0:None 1:X 4:Z 5:XZ 7:XYZ	0	ATC Reverse delay time	000000
Follow error checking 1:ZX	0	Follow error value	000000
Back Main			
SYSTEM MCM		VERSION	G54~G59

Fig.2-16

4. When the error occurs, the system will automatically switch to the error dialogue box or press the D1 key for error messages.

Code	Causes	Code	Causes	Code	Causes
01	MCM Data Error	13	G/M/T & R Code Error	32	G76/G92 E,P Command Error
02	Follow error > setting value	14	Axis Hardware Over-Travel	36	Transferred Error
04	USB/SDC Error	15	Search Grid Distance Exceed	37	OutSide Device Error
05	System Error	18	End of Program Error	38	Screen Reading time > 3s
07	Flash rom "Write to" Error	20	Axis Software Over-Travel	39	Tool-Life Reaching
08	MDI Command Error	22	EM-Stop	50	User Defined Error(G65)
09	G31 Signal Read Error	25	G02/G03 Command Error	53(1)	Tapping Retract Position Error
10	RS232 Error	26	G71~G73 Command Error	53(2)	Tapping Depth < 0
11	Program Check Sum Error	29	A,R,C of G Code Error	54	Tapping F(Pitch) not Defined
12	Program Burning Error	31	PLC Error	55	Tapping Depth not Defined
Spindle	Spindle 1 error Spindle 1 unclamp Spindle 3 error Please press SP "cw" or "ccw", before feed-hold cancel		Spindle 2 error Spindle is running Chuck unclamp		
Feeder	Feeder doesn't meet the positioning				
Other	Turret loose EM-stop X-axis motor error Count limit is reached Z-axis motor error		Tool change time out Hydraulic pump error Y-axis motor error Security door error Coolant pump error		
00					99/99
Back Main					ERROR-LIST

Fig. 2-17

Code	Causes	Code	Causes	Code	Causes
01	MCM Data Error	13	G/M/T & R Code Error	32	G76/G92 E,P Command Error
02	Follow error > setting value	14	Axis Hardware Over-Travel	36	Transferred Error
04	USB/SDC Error	15	Secrch Grid Distance Exceed	37	OutSide Device Error
05	System Error	18	End of Program Error	38	Screen Reading time > 3s
07	Flash rom "Write to" Error	20	Axis Software Over-Travel	39	Tool-Life Reaching
08	MDI Command Error	22	EM-Stop	50	User Defined Error(G65)
09	G31 Signal Read Error	25	G02/G03 Command Error	53(1)	Tapping Retract Position Error
10	RS232 Error	28	G71~G73 Command Error	53(2)	Tapping Depth < 0
11	Program Check Sum Error	29	A,R,C of G Code Error	54	Tapping F(Pitch) not Ddfined
12	Program Burning Error	31	PLC Error	55	Tapping Depth not Defined

NO	Y / M / D	hh : mm	Error list
00	00 / 00 / 00	00 : 00	00
00	00 / 00 / 00	00 : 00	00
00	00 / 00 / 00	00 : 00	00
00	00 / 00 / 00	00 : 00	00
00	00 / 00 / 00	00 : 00	00
00	00 / 00 / 00	00 : 00	00
00	00 / 00 / 00	00 : 00	00
00	00 / 00 / 00	00 : 00	00
00	00 / 00 / 00	00 : 00	00
00	00 / 00 / 00	00 : 00	00
00	00 / 00 / 00	00 : 00	00

Back Main				Back
-----------	--	--	--	------

Fig.2-18

- Press F4 key (Version) at the second page of parameter to enter the display of software version as the figure demonstrated below:

Software version		
		S/N: 0000000
	YYYY	MM/DD
SYSTEM	0000	0000
PLC	0000	0000
CRT	0000	0000
ARM	0000	0000
LATTICE	0000	0000
		SP: -000000 pulse
		X: -0000.000
		Y: -0000.000
		Z: -0000.000
#10889 0000000		
		99/99 99.99
Back Main	Time Setting	Back

Fig.2-19

In the display, it shows the dates of both system and PLC.

Example: 2002 1205 stands for the date on December 5th, 2002.

2003 528 stands for the date on May 28th, 2003 and so on.

- The parameters page, It can into the page if you press the [SYSTEM-MCM] key. Fig. 2-19
 Enter the cipher code, then into the parameters page. Fig. 2-20
 You can change the cipher code in this page.
 Press the [Change the Password] key, then into the password revising page. Fig. 2-21. It will be work if confirm the new password exactly.

※ You can used the [123456] code to into the parameter page and change the password. If you first into this mode.

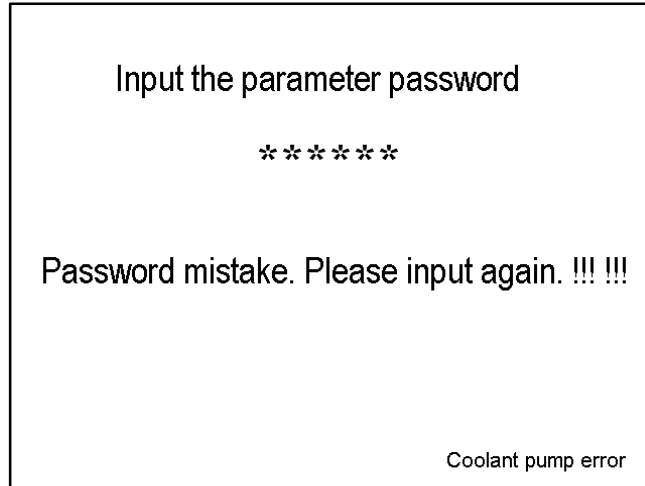

Fig.2-20

Parameter	X-AXIS	Z-AXIS
Resolution-Den.(pulse)	0000000	0000000
Resolution-Num.(pitch)	0000000	0000000
Traverse speed(G00)	0000000	0000000
Traverse speed(G01)	0000000	0000000
Rotate direction	0	0
Home speed-1	0000000	0000000
Home speed-2	0000000	0000000
Home direction	0	0
Find grid direction	000	000
Distance of grid error	-0000.000	-0000.000
Software OT(+)	-0000.000	-0000.000
Software OT(-)	-0000.000	-0000.000

Back Main **Change Password** ALL MCM PITCH ERROR MCM Modify

Fig.2-21

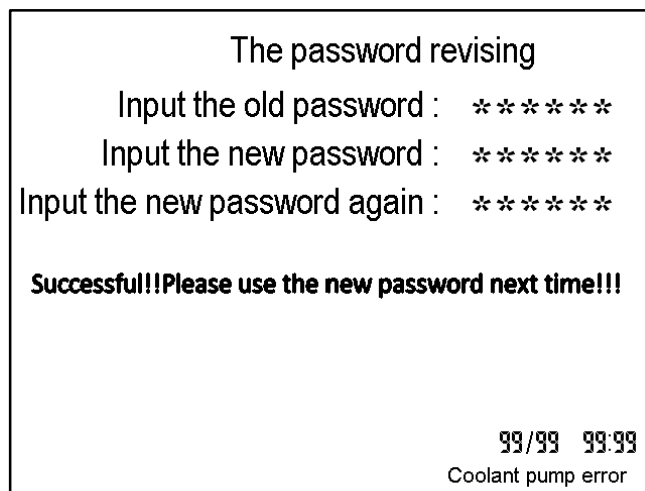

Fig.2-22

- ※ press the key 『TOOL.RADIUS』 to enter the work origin setting: Note that this is only valid in the state of home origin.

Work Origin setting(1) is demonstrated below:

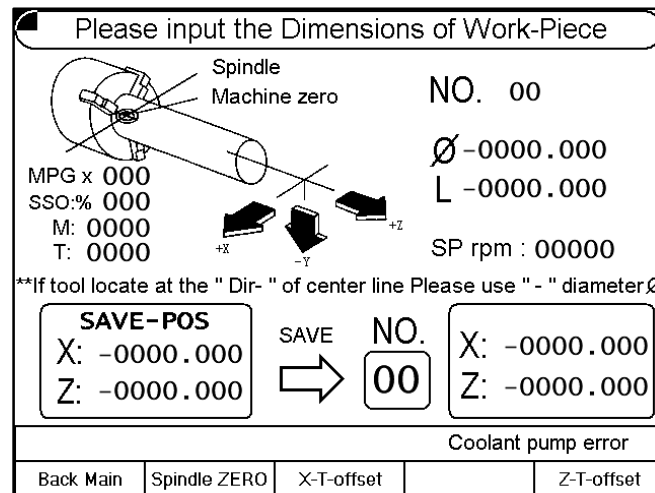

Fig.2-23

Note: When mount the Tool above the Work-piece, it means the Upper Holder (Rear Holder); when mounting under the Work-piece, it means the Lower Holder (Front Holder). The system parameters can be used to set the Holder type, for example, X-Axis means the direction when Tool is leaving the Work-piece (refer to Fig. 2-22). If the Tool is located at “Negative X Direction” at the center of the Work-piece, then negative value should be entered for the diameter (as per Example 2).

Tool Calibration Step:

1. Clamp the Work-piece securely (clamp with Pedal Switch or Manual Chuck key).
2. Set the group number.
3. Write in X-Axis position.
 - a. Move the Tool with Hand Wheel for accepting OD machining. Before the entire Tool leaves the machining coordinates, press the “X Tool Offset” key and at this time, the system will save the machine coordinates of X-Axis in the X-Axis position.
 - b. Move the Tool away with Hand Wheel. After measuring the actual Work-piece diameter, enter the diameter of X-Axis.
 - c. Press “X Tool Offset” key again and the Controller will calculate automatically for writing the result in the designated Tool length offset parameter.

4. Write in Z-Axis Position:
 - a. Move the Tool with the Hand Wheel for accepting end face machining. Before the entire Tool leaves the machining coordinates, press “Z Tool Offset” key and at this time, the system will save the machine coordinates of X-Axis in the Z-Axis position.
 - b. Enter the Work-piece length. To use the machining end face as the working Home Position for Z-Axis, set the length as “0”.
 - c. Press “Z Tool Offset” key again and the Controller will calculate automatically for writing the result in the designated Tool length offset parameter.

Example 1:

1. If the Tool has not entirely left the machining coordinates, the machine coordinates will be (13.000, 13.638.)
2. Enter diameter as 20.000mm (diameter program setting and the Tool is located at the X position direction at the centerline of the Work-piece).
3. Enter the length as 0.000mm (the machining end face will be the working Home Position of Z-Axis).
4. Press “F3-X Tool Offset” and “F5-Z Tool Offset” respectively.
5. The X, Z coordinates saved for the Tool setting screen will be (6.000 and 13.638) respectively. Under Tool length offset screen, the X, Z coordinates of this group will be (6.000, 13.638.)

Example 2:

1. If the Tool has not entirely left the machining coordinates, the machine coordinates will be (-15.400, 12.166.)
2. Enter diameter as -20.000mm (radius program design and the Tool is located at X negative direction at the centerline of the Work-piece).
3. Enter the length as 10.000mm (the machining end face will be the working Home Position of Z-Axis).
4. Press “F3-X Tool Offset” and “F5-Z Tool Offset” respectively.

The X, Z coordinates saved for the Tool setting screen will be (-5.400 and 2.166) respectively. Under Tool length offset screen, the X, Z coordinates of this group will be (-5.400, 2.166.)

● Graphic Mode Display

AUTO mode press the key “ GRAPH “ to enter the graph mode display as follows:

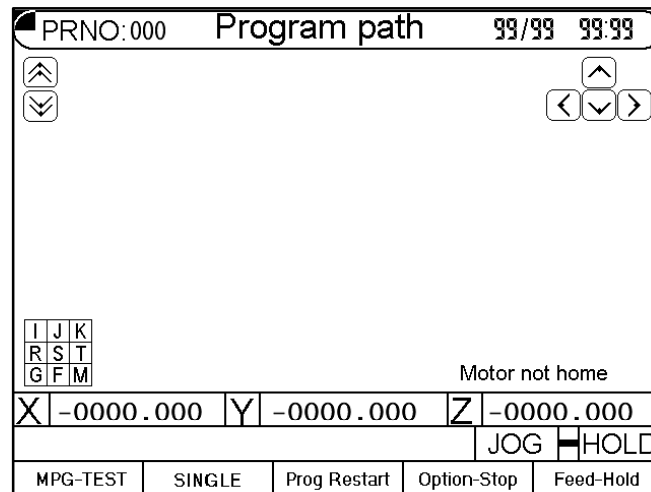

Fig. 2-24

1. Display Percentage: With Page Up/Page Down page key, you may adjust the displayed percentage of the working route flexibly in dynamic way.
2. Display Position: With Up/Down/Left/Right Direction Cursor key, you may adjust the graphical Home Position displayed in the screen or adjust the draft Home Position by letter keys in a quicker manner.
 I-Screen Upper Left; J-Screen Middle Up; K-Screen Upper Right
 R-Screen Middle Left; S-Screen Center; T-Screen Middle Right
 G-Screen Lower Left; F-Screen Lower Middle; M-Screen Lower Right
3. Coordinate Plane Shift: Letter X-XY Plane, Letter Y-YZ Plane, Letter Z-XZ Plane.
4. Clear the drafted working route: By pressing “Clear” key, you may erase the drafted working track from the graph screen.
5. The drafting action will be divided into the the following two types:
 “Hands-on Draft”, “Fast Draft”.

Shift Method: Under Draft Mode and before starting the program, press “Fast” key (once for ON and press again for OFF).

Fast Key Indicator ON → “Fast Draft”

Fast Key Indicator OFF → “Hand-on Draft”

“Hand-on Draft”: Servo axis displacement command together with M, T and S codes will be executed.

“Fast Draft”: Servo axis will be locked without displacement, but M, T and S codes will be executed.

Such function is useful for initial working, as the operator can check if the working route is correctly planned under absolute safe conditions.

2.2 Program Edition

2.2.1 Programming Introduction

2.2.1.1 Part Program

Prior to cutting a machine part by using a CNC cutting tool, a computer program, called a part program, must be created to describe the shape of the parts, which is based on some kind of coordinate system. The cutting tool will then follow these coordinates to do exact cutting. To create a part program, a concise machining plan is a necessity, which includes the coordinates for the machine part, coolant, spindle speed, tool type, I/O-bit, etc.. When design a machining plan, the following factors must be considered:

1. Determine the machining range requirement and select the suitable CNC machine tool.
2. Determine the work-piece loading method and select the appropriate cutting tool and the tool holder.
3. Determine the machining sequence and the tool path.
4. Determine the cutting conditions such as spindle speed (S), federate (F), coolant, etc.

A part program is a group of sequential instructions formulated according to the machining plan. It can be edited either on a personal computer (PC), then transmitted to the CNC controller through RS232C interface or directly on the CNC controller using the editing keys. Lathe can do both. They will be discussed later.

2.2.1.2 Methods Of Programming

A CNC controller will execute the commands exactly in accordance with the instructions of the part program. So, the program design is the most important

task in the whole CNC machining process. There are two ways to design a CNC part program and are to be briefly described as bellows:

1. Manual Programming

Manual programming is a process that the whole process is manually done by hand including the coordinate calculations. It follows this sequence.

- Machine part drawing.
- Part shape description includes coordinate calculations.
- Computer program design includes spindle speed, feed rate, M-code, etc..
- Keying in the program instructions into the CNC controller or transmitted from PC.
- Testing the program.

The coordinate calculation is a simple process if the part shape is composed of straight lines or 90-degree angles. For curve cutting, however, the calculation will be more complicate and trigonometry will be required for correct answers. Once all calculations have been completed, the CNC part program is written in the formats to be discussed later.

The main disadvantage of manual programming, particularly when designing for a very complicated part, is time consuming and prone to making errors. In this case, automatic programming becomes more advantageous than the manual methods.

2. Automatic Programming

Automatic programming is a process in which the design work included coordinate calculation that is done by computer. It follows this sequence.

- Computer added design for part drawing (CAD)
- Computer added manufacturing for CNC part program (CAM)
- Transferring program to CNC controller.
- Testing the program.

By making use of computer's high speed calculating capability, program designer can communicate with the computer in simple language, to describe the shape, size and cutting sequence of the part. The computer will transfer the motions to the machine tool into a part program, which is then transferred into CNC controller through RS232C interface. This process is called CAD/CAM. It is

a necessary tool when designing a part program for a 3-D work-piece.

2.2.1.3 The Composition of A Part Program

A complete part program is composed of program blocks, starting with a program number Oxxx, ended with M2, M30, or M99, and in between with a series of CNC instructions. A CNC instruction is a command to order the cutting tool to move from one location to another with the specified speed, or the peripheral equipment to do some mechanical work. The cutting is done when the cutting tool moves.

An example of a complete part program containing nine blocks is as follows:

```
N10 G0 X40.000 Z10.000
N20 G00 X30.000 Z5.000
N30 M3 S3000
N40 G1 X10.000 F200
N50
W-5.000
N60 X15.000 Z-10.000
N70 X30.000 W-10.000
N80 G0 X40.000 Z10.000
N90 M5
N100
M2
```

A block of program can have one to several instructions and it has a general form as follow. The block sequence number "Nxx" can be omitted. If you do not key in the block number, Lathe has a special function "Auto-N" to automatically generate the number for you during or after program editing (see chapter 6). The program execution starts from top to bottom block and has nothing to do with the order of block sequence number. Each instruction starts with an English letter (A~Z), followed by a integer or floating number, depending on what type of instruction the number is associated with. If the number represents a coordinate, it can be positive (+) or negative (-).

N- ___ G ___ X(U) ___ Z(W) ___ F ___ S ___ T ___ M ___

N : block sequence

G	: function command
X, Z	: coordinate position command (absolute position command)
U, V	: coordinate position command (incremental position command)
F	: Feed rate
S	: Spindle speed
T	: Tool command
M	: Auxiliary command (machine control codes)

In general, the program instructions can be divided into four categories.

1. Function command:
G-code. A CNC command to instruct the cutting tool to do an action, such as straight, circular or thread cut, compound cut, etc.
2. Position command:
X, Z, U, W. A coordinate command to instruct the cutting (Motion command) tool to stop the cutting action at the location specified -- an end point. The end point of the current block is the starting point of the next block.
3. Feed-rate command:
F-code. A command to instruct the cutting tool how fast to do the cutting.
4. Auxiliary command:
M, S, T, L, etc. A command to instruct the peripheral equipment to do an action, such as spindle speed, coolant on/off, program stop, etc.

Note that not every block is composed by these four parts. Some have only one command. We will have further discussions in chapter 3.

Basic command format (similar with position command):

X-10.000

X	: command code
"-"	: positive and negative signs(sign + can be omitted)
10.000	: destination point for tool position

Each command code has a fixed format and a special meaning to the CNC controller and it must be strictly followed when designing a program. The system will not accept the command if the format is in error. Otherwise, a machine error will result. Followings are the command codes that are used in Lathe.

- F :Feed-rate in mm/min or mm/revolution, a decimal.
- G :Function G-code, an integer.
- H :Tool offset compensation number.
- I :The X-axis component of the arc radius @ the start point, a decimal.
- K :The Z-axis component of the arc radius @ the start point, a decimal.
- L :Repetition counter, integer.
- M :Control code for peripheral machine tool, integer.
- N :Program block (sequence) number, integer.
- P :Dwell time; subprogram code; or parameter in canned cycles, integer.
- Q :Parameter in canned cycles, integer.
- R :Arc radius or "R" point in canned cycles, decimal.
- S :Spindle speed, integer.
- T :Tool commands.
- U :Incremental coordinate in X-axis, decimal.
- W :Incremental coordinate in Z-axis, decimal.
- X :Absolute coordinate in X-axis, decimal.
- Z :Absolute coordinate in Z-axis, decimal.

Each serial number of program represents a block. Although it is not necessary to use it, it is recommended to utilize the serial numbers for program searching. Lathe has a special function "Auto-N" to automatically generate the number for you during or after program editing (see chapter 6). The program execution starts from top to bottom block and has nothing to do with the order of block sequence number.

Example: N10.....(1) program execution order
N30.....(2)
N20.....(3)
N50.....(4)
N40.....(5)

2.2.1.4 Coordinate System

The machining action of a cutting tool is accomplished when the tool is moving along a specific path from point A to point B, which represents the shape or the contour of a machine part. In order for the tool to follow the specific path, a computer program describing the shape of the machine part must be created and the shape or the contour is described by the Cartesian coordinate system.

Cartesian Coordinate System

Lathe uses the customarily 2-D Cartesian coordinate system as shown in Fig 2-18, with Z-axis being the center of and parallel to the spindle axis and defined as $x=0$. The other axis is X-axis and $Z=0$ can be anywhere along the Z-axis at some convenient location for coordinate calculation. The intersecting point of the two axis is the origin, $X=0, Z=0$. Depending on the location of the cutting tool with respect to the spindle axis, the sign convention of the coordinate system is shown in Fig 2-25.

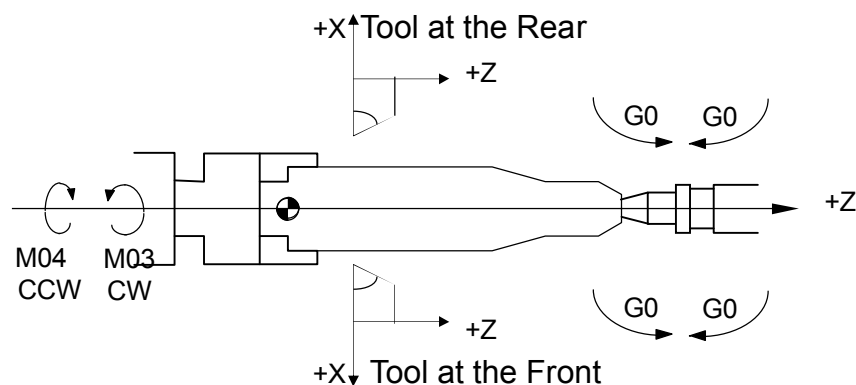

Fig 2-25 Cartesian Coordinate System of CNC Lathe

Fig 2-24 is 3-D system (right-hand rule) with the intersecting point designated as origin $X=Y=Z=0$. The direction of normal rotation for each axis is indicated by the direction of the four fingers when you grab the axis by the right hand with your thumb pointing to the (+) direction of that axis.

Coordinate of Tool Position Command

The instruction for tool position command in H4D-T series can be in either absolute coordinate or incremental coordinate as follows:

- X, Z : Absolute coordinate command. The cutting tool moves to the position specified by the absolute coordinate X, Z.
- U, W : Incremental coordinate command. The cutting tool moves to the position with an incremental amount specified by U, W.

Note : Diameter usually stands for X-axis of coordinate in Lathe CNC no matter it is absolute or incremental.

Absolute Coordinate

The origin is the reference. The coordinates of all points describing the shape of the work-piece (machine part) are calculated from the origin. The coordinates can be positive (+) or negative (-), depending on its relative position with respect to the origin.

Incremental Coordinate

The coordinates of all points describing the shape of the work-piece (machine part) are calculated from the end point of the previous block. They are the amount of coordinate increase from the last point. The incremental coordinates can be either positive (+) or negative (-), depending on its relative position with respect to the end point of the previous block. They are positive (+) if the cutting tool is going in the direction of U, W increment, negative (-), otherwise is in the direction of U, W decrement.

X, Z, U, W can be mixed in the program. The methods are described below:

Absolute Command:

```
P0 to P1---G01 X10.000 F0.200
P0 to P2---X24.000 Z30.000
P2 to P3---X32.000 Z10.000
P3 to P4---Z0.000
```

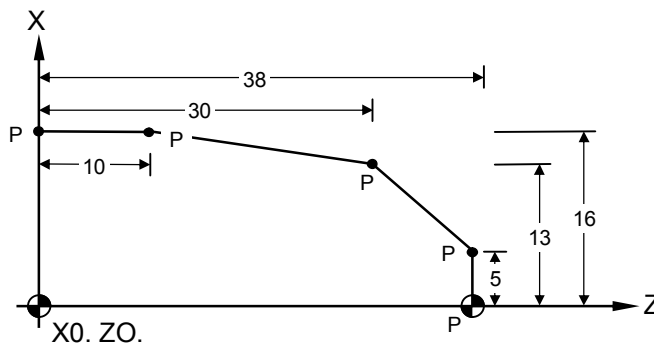

Fig.2-26 Absolute Command

Increment Command:

P0 to P1---G01 U10.000 F0.200

P1 to P2---U14.000 W-8.000

P2 to P3---U8.000 W-20.000

P3 to P4---W-10.000

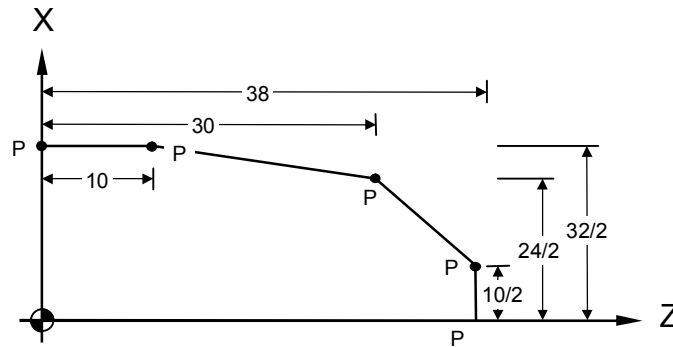

Fig.2-27 Increment Command

Mixed Usage:

P0 to P1---G01 X10.000 F0.200

P1 to P2---X24.000 W-8.000

P2 to P3---U8.000 Z10.000

P3 to P4---W-10.000

Or

P0 to P1---G01 X10.000 F0.200

P1 to P2---U14.000 Z30.000

P2 to P3---X32.000 W-20.000

P3 to P4---Z0.000

In the absolute coordinate, the calculation error of one point will not affect the positioning of next point. In the incremental coordinate, however, an error of a point will affect the positioning of all subsequent points. There isn't any rule as to when to use the incremental or the absolute coordinate. The mixed use of both coordinates appears to be the most convenient.

Work Origin/Work Coordinate

The work origin is the coordinate origin as described before. It is also called the program origin. This is the reference point for all coordinate calculations and the

coordinate so obtained is called work coordinate. The reason to call it as work origin is to differentiate it from the machine origin to be discussed in the next section.

The work origin can be anywhere inside the machine working range. The user should determine the location of this point before making any coordinate calculations. Once the origin is selected, store the coordinate of this point with respect to the machine origin in MCM parameter #1 (see Chap 4). The best selection is the one that will make the coordinate calculation simple and easy.

X-axis of Work Origin in Lathe (X=0) should be at the centerline of Spindle. There are three options for Z-axis of work origin:

1. The left end of Z-axis of work origin for its origin.
2. The right end of Z-axis of work origin for its origin.
3. The frontal claw or chuck for Z-axis origin in work origin.

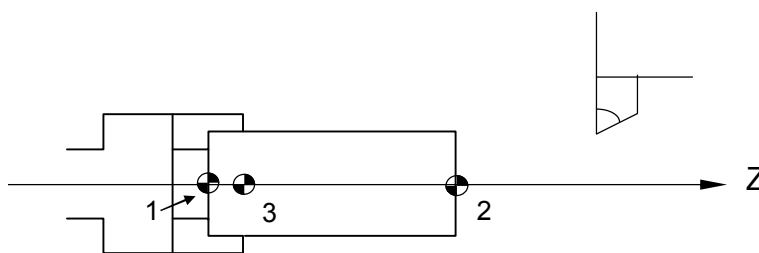

Fig.2-28 Work origin Options (1, 2, 3)

It is an equal shape of a complete workpiece to spindle spin in Lathe CNC. Then, it can be made at the other end. Therefore, it only takes half of the workpiece to make in the program like the figure 2-28 below.

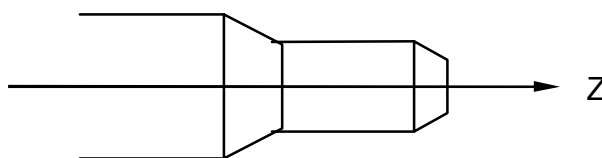

Fig.2-29 Workpiece Cut Diagram

Machine Origin

The machine origin is the HOME location for the cutting tool. This is the reference point for the coordinate determination of the work origin and the tool

offset compensation. The coordinate obtained using the machine origin as calculation base is called the machine coordinate.

The exact location of the machine origin is determined by the location of the home limit switch on each axis. When user executes X and Z Home on a Lathe CNC controller, the cutting tool will move to the machine origin. The exact distances between the machine origin and the work origin must be accurately measured using a fine instrument, such as a linear scale. Otherwise, the completed part will be in an error.

When the electric power is interrupted for any reasons, execute HOME on each axis before resuming any cutting.

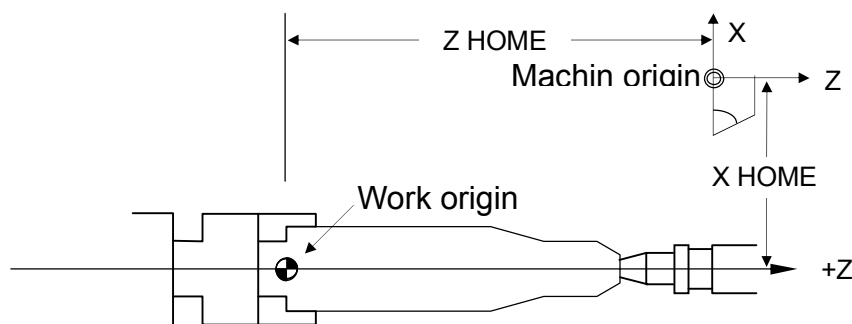

Fig.2-30 Machine Origin Diagram

2.2.1.5 Control Range

The minimum/maximum programmable range for Lathe CNC controller is as follows. Please note that the control range may be limited by the working range of user's machine.

	Metric, mm
Min. setting unit	0.001
Max. setting unit	9999.999
Min. moving unit	0.001
Max. moving unit	9999.999
Max. setting	9999.999

	Metric Unit / English Unit
G-code	G00~G99 (G01=G1)
M-code	M000~M999 (M01=M1)
S-code	S1~S9999 rpm
F-code	0.001~0~9999.999mm/spin
X, Z, U, W, I, K	0.001~+/- 9999.999 mm
R (Radius)	0.001~+/- 9999.999 mm
G04	0~9999.999 seconds
Program number	0~999
T-code	1. There is no tool with two digits, Txx, it is the number of tool compensation. 2. It has tool with four digits, Txxxx, the first two are tool selection and the last two are the number of tool compensation
Memory capacity	128 K
Lead screw compensation	0~255 pulses (related to tool resolution)
Max. Response Speed	500 KPPS

2.2.2 Program Editing

The following topics will be discussed in this section.

1. Select a program for editing.
2. Edit a new program.
3. Revise an existing program.

2.2.2.1 Program Selection

H4D-T controller can store a maximum of 999 programs with number O0~O999. You can select any one of the programs for editing or execution. The program selection process is described as follow.

Press 『EDIT/PRNO』 key twice in 0.5 seconds to enter PRNO mode, move the cursor to the desired program and press the input key. The LCD display is shown as

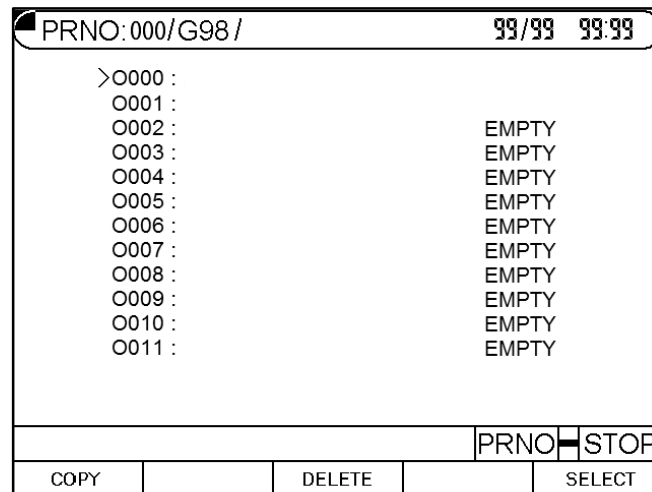

Fig.2-31

Under PRNO mode, the program note can be entered up to 12 different letters and numbers.

Example: If you put the note “TYPE-201” after 001, the instruction is as follows.

1. Move the cursor to 0001
2. Enter the letters and numbers as
3. Press input

2.2.2.2 New Program Editing

When a new program has been selected, press EDIT key to be in editing mode. The LCD screen will be blank with cursor pointing at the first line to be entered as in Fig 2-32.

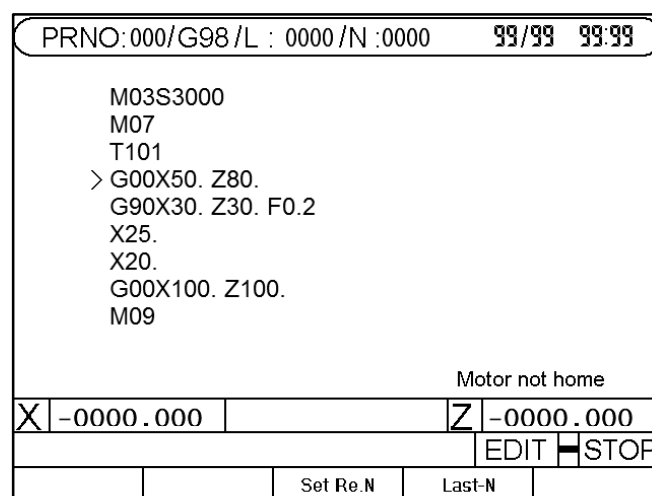

Fig.2-32

During program editing, the following keys will be used.

1. Function keys.
2. Numeric keys, 0~9
3. CURSOR ← and CURSOR → keys for data inspection in the same block.
4. PAGE↑ and PAGE↓ keys for data inspection between lines.
5. NEW LINE key -- Establishing or inserting a new block anywhere in the program.
Key in a function code, then press NEW LINE to establish a new line.
6. INPUT -- For entering a data or a function in the established block.
Key in a function code, then use INPUT to enter more data into the established line.
7. DEL -- For deleting a block (line) of program.

Auto-generation of Block Number (Auto-N)

You can edit a program with or without block number. Following is an **example program** to explain the keystrokes required to edit a new program in the controller.

Ex: Program 1
N1 G0 X0. Z0.
N2 G4 X1.
N3 G0 U480. V-80.
N4 G4 X1
N5 M99

Keystrokes: (Ignore the sign "-" below. It's there for clarity)

1. Please confirm the edit status and press Edit key to enter in the controller.
N1 G0 X0. Z0.
2. Enter first block information G – 0 – NEW LINE

It is a new establishing block. Thus, users need to enter NEW LINE key. After this step, the LCD screen is shown as Fig 2-32.

PRNO:000/G98/L : 0000/N :0000				99/99 99.99	
> G0					
X	-0000.000		Z	-0000.000	
				EDIT	STOP
		Set Re.N	Last-N		

Fig.2-33

And enter:

X 0 • INPUT

Z 0 • INPUT

Key-strokes for the remaining blocks are as follows.

1. N2 G4 X1.

(A) G - 4 - NEW LINE

(B) X - 1 - • - INPUT

2. N3 G0 U480. W-480.

(A) G - 0 - NEW LINE

(B) U - 4 - 8 - 0 - • - INPUT

W - "-" 4 - 8 - 0 - • - INPUT

(The negative sign "-" here can be input anywhere before pressing INPUT key)

3. N4 G4 X1.

(A) G - 4 - NEW LINE

(B) X - 1 - • - INPUT

4. N5 M99

(A) M - 99 - NEW LINE

During program editing, you can use CURSOR ←, CURSOR → key to check the input data within the block. Use PAGE↑, PAGE↓ to move up and down the block (line). When you finish editing the entire program, press RESET key to exit.

2.2.2.3 Program Revision

Let's use Program O001 of previous section as our example for program revision.

Revise or Add a Function

To revise or add a function, simply key in the function code and the correct number, then press INPUT key.

Ex: Revise N3 U480. W-480.
 To N3 U480. W-480. F0.2

1. Make sure the system in EDIT mode.
2. Use PAGE↑, PAGE↓ key to move cursor to N3 block.
3. Add a function of F0.2. by entering data below and LCD will display as in

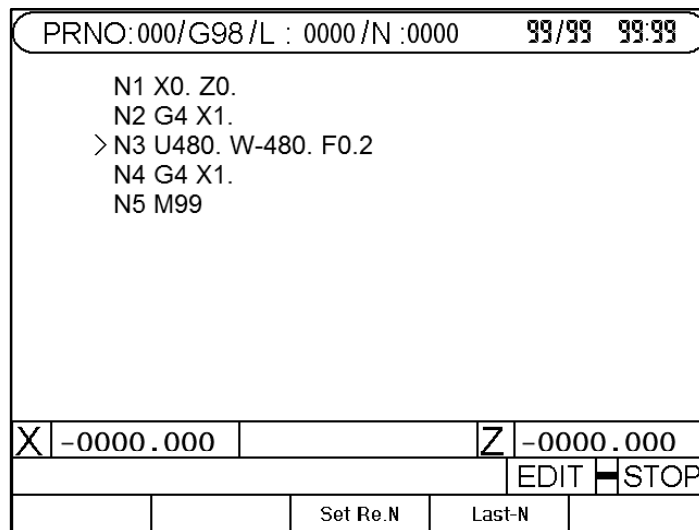

Fig 2-34

F-0 - . - 2 - INPUT

4. Revise U480. to U360. by keying in

U - 3 - 6 - 0 - . - INPUT

Delete a Function

To delete a function, simply key in the function to be deleted without number, then press INPUT key.

Ex: Revise N30 U480. W-480. F0.2
To N30 U480. W-480.

1. Make sure the system in EDIT mode.
2. Use PAGE↑, PAGE↓ key to move cursor to N3 block.
3. Key "F" without numbers and press INPUT key, LCD displays as Fig 2-35.

PRNO:000/G98/L : 0000/N :0000		99/99 99:99	
N1 X0. Z0. N2 G4 X1. > N3 U480. W-480. N4 G4 X1. N5 M99			
X	-0000.000	Z	-0000.000
		EDIT STOP	
		Set Re.N	Last-N

Fig.2-35

Insert a Program Block

To insert a program block, key in the block number (or any function) and use NEW LINE key to establish the block. Then use INPUT key to input the rest of data for the block.

Ex: Insert N31 U20. W-20.
between N3 G0 U480. W-480. and
N4 G4 X1.

1. Make sure the system in EDIT mode.
2. Use PAGE↑, PAGE↓ key to move cursor to N30 block.
3. Enter
N 3 1 new line
U 2 0 . input
W- 2 0 . input

The LCD display is shown as fig.2-36

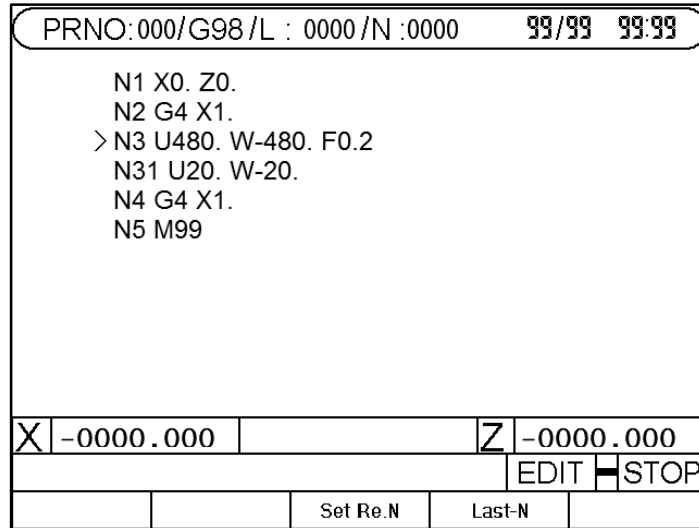

Fig 2-36

Delete a Program Block

To delete a block, use PAGE↑, PAGE↓ key to move cursor to the block that you want to delete and press DEL key. For example: Delete N31 U480 W-480. from last example.

1. Make sure the system in EDIT mode.
2. Use PAGE↑, PAGE↓ key to move cursor to N31 block.
3. Press DEL key and the LCD display is as shown in Fig 2-37 (Block N4)

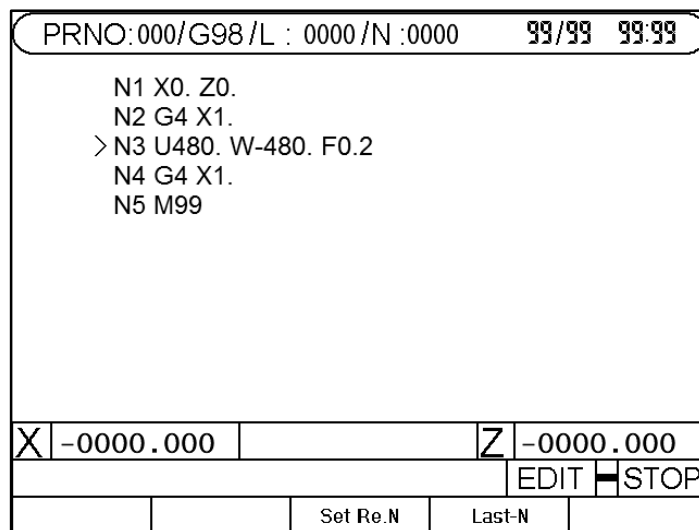

Fig.2-37

Delete a Program

Move the cursor to the program that you want to delete it in PRNO mode and press DEL. The LCD display is shown as fig.2-38

PRNO:000/G98/		99/99 99:99	
>O000 :			
O001 :			
O002 :		EMPTY	
O003 :		EMPTY	
O004 :		EMPTY	
O005 :		EMPTY	
O006 :		EMPTY	
O007 :		EMPTY	
O008 :		EMPTY	
O009 :		EMPTY	
O010 :		EMPTY	
O011 :		EMPTY	
DELETE O000 (Y/N)			
		JOG	<input checked="" type="checkbox"/> HOLD
	Yes		No

Fig.2-38

In the meantime, press Y and clear the content of the 002 program. The key N remains the same.

If you want to delete all programs- 0~999, follow the procedures below:

Enter MDI mode, and give G10 P2001 command.

Then all the content of the program are cleared immediately.

Note: After completing the procedure, all the program data in memory will be vanished. Therefore, do not use this program if it is not necessary.

2.2.2.4 Rules for Numerical Input

Numerical input has two formats such as integer and decimal with a maximum of 7 digits. If you input the numbers in accordance with the format required by the controller, the number will be entered correctly. You cannot enter a decimal point for a number that requires an integer format. So, the only occasion that may cause error input is the one that you enter an integer for a decimal format.

Described more in detail below.

The decimal input such as X, Y, I, J is left blank, the content of the controller will automatically move back to the decimal points of last format with dot at front.

The table below shows the decimal numbers recognized by the controller after internal process for some integer inputs.

Input	4/3 Format
X2	X0.002 mm
Z35	Z0.035mm
U2500	U2.500 mm
W125.	W125.000mm
F300	F0.3 mm/min

The numerical formats for the function codes used in Lathe system are listed below. To avoid any potential error, please use the specified format as follow when key in data. The number "0" after decimal point can be omitted.

G, M, N, S-code: Variables	Integer input
X, Y, Z, U, V, W, I, J-code	Decimal input
F-code	Integer input

Note: TO avoid the confusion, apart from integer inputs such G, M, N, S, the rest of the inputs should be entered by decimal points. The number "0" after decimal point can be omitted.

2.2.2.5 Notes on Program Edit

Program Block Number

1. Block number N can be omitted, but it's better to have it for the convenience of program inspection later.
2. Block number N is recognized by the editing order not by the block sequence or its value. The numbers by the letter N are merely symbols. For instance, inserting block N35 in Block N30. It will become the following result.

```

Program 1
N10 G0 X0 Y0.....first block
N20 G4 X1.....second block
N30 U480 V-480.....third block
N35 U20 V-20.....fourth block
N40 G4 X1.....fifth block
N50 M99.....sixth block
    
```

If block N35 is changed to block N350, the arrangement of program execution remains the same.

3. Block number is recognized by the number of characters, not by its value. Therefore, N10, N010, N0010 are three different block number.

Program Block

1. Do not use two G-codes in the same block. If more than one G-code exists in a block, only the last one is effective.
2. Do not repeat any position code in the same block. The position codes are X, Y, Z, U, V, I, W, J and R.
3. If you specify absolute coordinate and incremental coordinate for the same axis in a block, only the incremental coordinate will be executed.
Example: G1 X100. U50. -- U50 will be executed.
4. Do not exceed 80 bytes of data input for a single block. Otherwise, the CNC controller will show an error message Err-08 at the bottom of the screen.

3 G/M Codes

3.1 Command codes

The previous chapters have introduced the format of part programs. This chapter will describe the command codes of the H4D-T series and provide simple examples for each command to explain its applications.

The definition of G-codes in the H4D-T series is similar to other controllers. They are classified into two groups: (Table 3-1)

1. One-shot G-codes

A One-shot G-code (has no * mark in the table) is valid only in the defined program block.

Ex: N10 G0 X30.000 Z40.000
 N20 G4 X2.000 · · · G4 is a one-shot G-code and is valid only in this block.
 N30 G1 X20.000 Z50.000 · · · G04 no longer valid in this block.

2. Modal G-codes

A Modal G-code (has a * mark in the table) is valid until it is replaced by another G-code of the same group.

Wherein G00, G01, G02, G03 Same group.

G40, G41, G42 Same group.

G96, G97 Same group.

G98, G99 Same group.

Ex: N10 G0 X30.000 Z5.000 · · · G0 is defined.
 N20 X50.000 Z10.000 · · · No G-code defined, G0 remains valid.
 N30 G1 X30.000 F0.2 · · · G1 replaces G0 and becomes valid.

The G-codes of H4D-T controller are listed in Table 3-1.

Table 3-1 G-Code Definitions

G-code	Function
*00	Positioning (fast feed-rate)
⊙*01 #	Linear cutting (cutting feed-rate)
⊙*02	Circular interpolation, CW (cutter at rear)
⊙*03	Circular interpolation, CCW (cutter at rear)
04	Dwell (Feed-hold)
05	Parabolic cutting
09	Exact stop check
15	Spindle positioning command
16	Cylindrical plane
17-19	Plane selection
20	System measurement in INCH mode
21	System measurement in METRIC mode
28	Automatic reference position return
29	Return from reference position
30	2nd reference position return
31	Skip function
★32	Thread cutting
★33	Tapping Cutting Canned Cycle
★34	Variable lead thread cutting
*40 #	Tool radius compensation - cancel
*41	Tool radius compensation - set (left)
*42	Tool radius compensation - set (right)
52	Local Coordinate System Setting
53	Basic machine coordinate system
54-59	Coordinate System Setting
* 61	Exact stop check mode
* 62	Exact stop check mode cancel
70	Finishing cycle
71	Longitudinal rough cutting cycle
72	Face rough cutting cycle
73	Formed material rough cutting cycle
74	Face cut-off cycle
75	Longitudinal cut-off cycle

G-code	Function
★76	Compound thread cutting cycle
80 #	Fixed cycle for drilling cancel
* 83	Deep hole drilling cycle (□ axis)
* 84	Tapping cycle
90	Longitudinal cutting fixed cycle
★* 92	Thread cutting fixed cycle
* 94	Face cutting fixed cycle
*96	Constant surface speed control □ N
*97 #	Constant surface speed control □ FF
*98	Feed per minute (mm□min or in□min)
*99 #	Feed per re□olution(mm□re□olution or in□re□olution)
<p># -- G-codes with "#" are of power-on default setting. * -- G-codes with "*" are modal G-codes. ★-- Function code prefixed with ★ mark needs to be carried out in G99 mode.</p>	

3.2 Positioning, G00

Functions and Purposes:

This command is accompanied with a coordinate name—it takes the current position as the starting point and the coordinate indicated by the coordinate name as the end point, which are positioned by the linear path.

Format:

G00 □(U)□□□□ □(W)□□□□

- , □ □End point in absolute coordinates.
- U, W □End point in incremental coordinates relative to the block starting point.

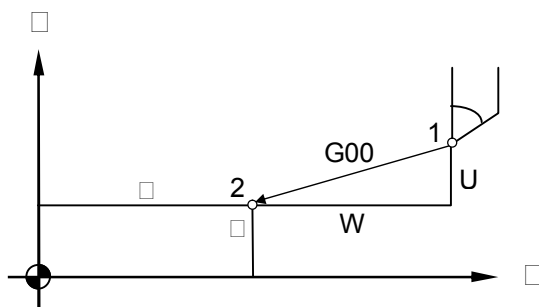

Fig. 3-1 Fast positioning

Details:

1. Once this command is given, the G00 mode is kept effective until a G01, G02, G03, or other single-time G command appears. Therefore if a subsequent command is also G00, only the axis address needs to be specified.
2. The speed of positioning is set by a machine parameter.
3. This command is capable of controlling movements in 1-6 axes simultaneously. No position movement will take place if the command gives no axis direction.

Example—Fig 3-2, A point moves to B point rapidly.

G0 □4.00 □5.60 · · · □ and □-axes are set with absolute commands

G0 U-6.00 W-3.05 · · · □ and □-axes are set with incremental commands

G0 X4.00 W-3.05 . . . X and Z-axes are set with absolute or incremental commands

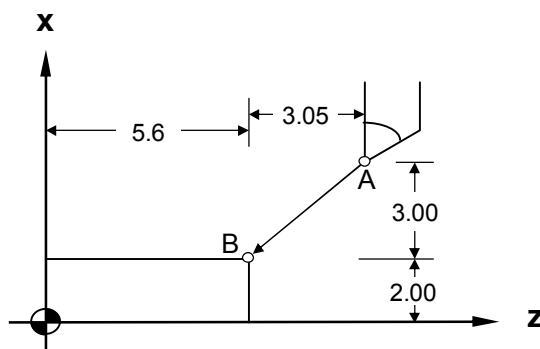

Fig. 3-2 G00 Programming Example

Tool moves to X4.00, Z5.60 rapidly. Since both X and Z axes are repositioning, the tool moves according to the lower feed-rate set in the parameter Highest Feed-rate. Ex: Fig. 3-2 assuming that the Highest Feed-rate is

X 5000.00 mm/min, Z 3000.00 mm/min,

Then F = 3000.00 . . . X-axis feed-rate

$$F_x = 3000.00 * (3.00 / 3.05)$$

= 2950.82 (less than 5000.0, Z-axis set value) . . . X-axis feed-rate

The feed rate of both axes is within the MCM parameter settings. Therefore, the tool will feed at the calculated rate on both axes.

When only a single axis (X or Z) executes fast positioning, it moves at the respective speed set in the Highest Feed-rate parameter.

3.3 Linear Cutting, G01

Functions and Purposes:

This command, together with the coordinates and a feed speed command, makes the tool to move from the current position to the end point specified by the coordinates in a linear movement at the speed specified by address F.

Format

G01 X(U)XXXX Z(W)XXXX FXXXX

- X, Y End point in absolute coordinates
- U, W End point in incremental coordinates relative to the start point of the program block.
- F Cutting feed-rate (F-code can be used in combination with any G-code)

The F-code can be used in the G00 block without affecting the fast positioning movement.

Details:

1. G01 (or G1) is used for linear cutting work. It can control the X, Y-axes simultaneously. The cutting speed is determined by the F-code. The smallest setting value of the F-code is 0.02 mm/min or 0.2 in/min.
2. Once this command is given, the G01 mode is kept effective until a G01, G02, G03, or other single-block G command appears. Therefore if a subsequent command is also G01 and the feed speed is not changed, only the coordinate value needs to be specified.
3. The starting point is the coordinate of the tool when the command is given. The feed-rate defined after an F-code (Modal code) remains valid until it is replaced by a new feed-rate.

The formula to calculate X, Y cutting feed-rate
(U and W are actual incremental values.)

$$X \text{ feed-rate, } F_X = \frac{U}{\sqrt{U^2 + W^2}} \times F \quad (1)$$

$$Y \text{ feed-rate, } F_Z = \frac{W}{\sqrt{U^2 + W^2}} \times F \quad (2)$$

Example Start point is X2.0 (diameter), Z4.60.

- G01 X4.00 Z2.01 F0.300 · · · Absolute command
- G01 U2.00 W-2.59 F0.300 · · · Incremental command

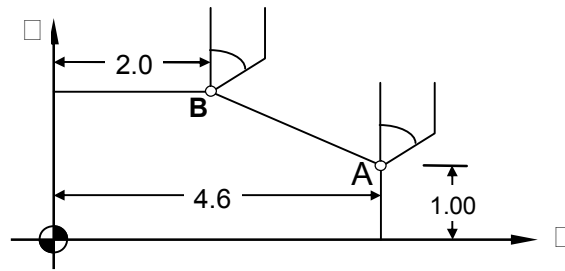

Fig. 3-3 G01 Programming Example

3.4 G02, G03 Circular Interpolation

Functions and Purposes:

This command makes the tool move along an arc.

Format

G02 (U) (W) I () F ()

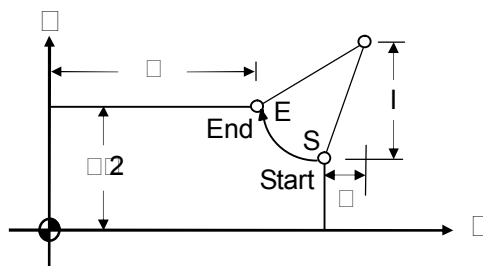

Fig 3-4 G02 Arc cutting

G03 (U) (W) I () F ()

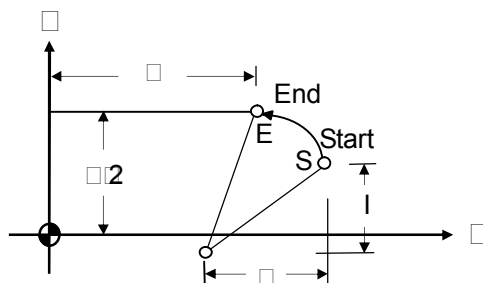

Fig 3-5 G03 Arc Cutting

G02 (U) (W) R () F ()

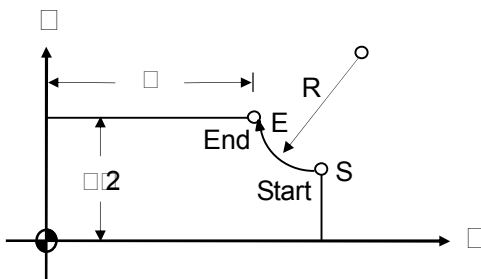

Fig. 3-6 Defined by Radius R

Details

- The arc-cutting program contains four command groups, as showed in the list below. The combination of these commands determine the arc path of the tool in a single block.

Table 3-2

			Command	Description
1	Arc feed direction		G02 G03	Clockwise Counter clockwise
2	End point	Absolute command Incremental command	X, Y U, W	End point in absolute coordinates Increment from arc start point to end point
3	Difference from arc start point to center Arc radius		I, J R	I X -axis, J Y -axis Radius range -9999.9999.mm
4	Arc feed-rate		F	Minimum setting 0.01 mm/rot.

- The end point can be defined either by absolute or incremental coordinates. The size of the arc can be defined either by the coordinate difference or radius. The arc cutting direction (CW or CCW) is relative to the center of the arc. Note that the CW or CCW direction is determined when the tool is at the top (rear) holder. The direction is reversed when the tool is at the bottom (front) holder.

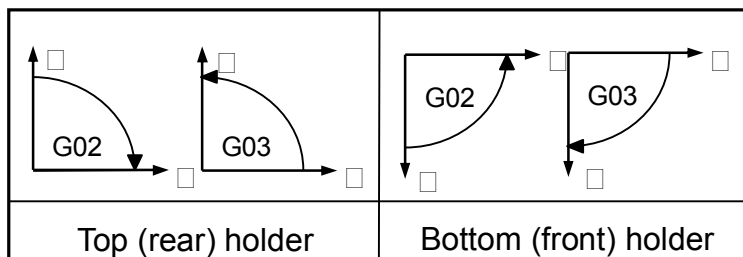

Fig. 3-7 G02, G03 Direction

Arc cutting command

Table 3-3

	Top (rear) holder	Bottom (front) holder
G02	Clockwise	Counter clockwise
G03	Counter clockwise	Clockwise

3. An arc comprises three elements, a start point, and end point and a center (See Fig. 3-8).
 - a. The start point (S) is the tool coordinates when the G02 and G03 execute.
 - b. The end point (E) is the coordinates of U and W in the program format.
 - c. The center (C) is defined by I and K values. They are the coordinate difference between the arc start point and center. This value can be either positive or negative. Definition of the I and K values are same as the increments (U, W). The arc feed-rate is defined by F-value.

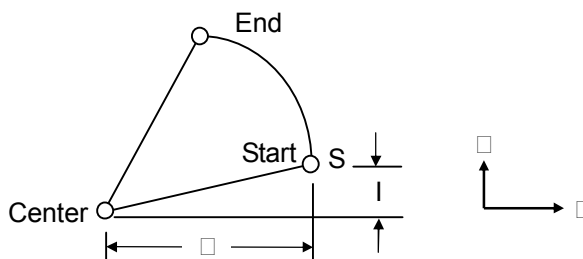

Fig. 3-8 Arc cutting

- d. The arc center can be defined by the radius instead of I and K. But if the arc angle is between -1° and 1° or 179° and 181° only I and K can be used for setting.

Example:

1. The following four commands are different in settings but execute the same arc cutting work.
 - a. G02 X5.000 Y3.000 I2.500 F0.3
 - b. G02 U2.000 W-2.000 I2.500 F0.3
 - c. G02 X5.000 Y3.000 R2.500 F0.3
 - d. G02 U2.000 W-2.000 R2.500 F0.3

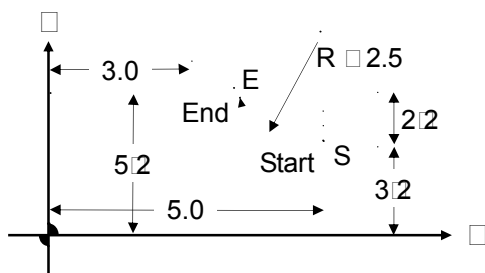

Fig. 3-9 G02 Programming Example

2. There are two different arc types available for arc cutting (Fig. 3-10)
 - a. Use "R" if arc angle $\leq 180^\circ$
 - b. Use "R" if arc angle $\leq 180^\circ$
R is within the range from -4000.mm to +4000.mm.

Ex In Fig. 3-10, an arc is cut with an angle $\leq 180^\circ$ (R)

```
G02 X60.000 Y20.000 R50.000 F0.300
```

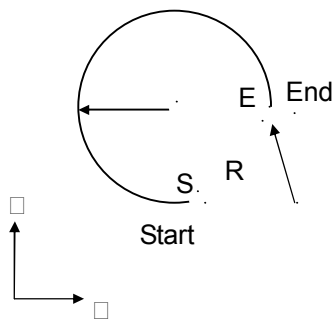

Fig. 3-10 Arc cutting

Please note the following when executing an arc cutting

1. The F-value of the cutting speed is given in a G02/G03 command, indicating the speed along the tangent to the arc—this tangent speed is limited by the arc radius and the given speed limit.

2. When the calculated tangential cutting speed of the arc is greater than the F-value of the program, the F-value is used as the tangential cutting speed. Otherwise, the calculated value prevails.
3. The maximum tangential cutting speed is estimated with the following formula

$$F_c = 85 \times \sqrt{R \times 1000} \text{ mm} \cdot \text{min}$$

Where R = Arc radius in mm.

3.5 Dwell , G04

Functions and Purposes:

This function's purpose is to temporarily hold the machine movement via the program command, realising a waiting status, therefore delaying the start of the subsequent block.

Format

G04 (P)□□□□

- Dwell Time. Unit = second. (The □ here stands for time instead of position, is dependent on the setting of □decimal enable□parameter. Ex. □ G04 □2, when □decimal enable□is disabled, the dwell time is 2s □if □decimal enable□is enabled, the dwell time is 0.002s □ i.e. 2ms.)
- P□ Dwell Time. Unit = millisecond. (Not dependent on the setting of □decimal enable□parameter.)

Details:

To meet machining requirements, the axial movement may need to be held during the execution of a program block, which completes before the command for the next block is executed. This command can be used for this purpose. The G04 function is used for this purpose.

The minimum dwell time is 0.001 sec, the maximum is 8000.0 seconds.

```
Ex G1 X10.000 Y10.000 F0.1
    G4 X2.000          . . . . . hold for 2 seconds
    G00 X0.000 Y0.000
```

3.6 Parabolic cutting, G05

Function and purpose :

The function will make the tool along a parabolic mobile.

Form :

G05 (U)XXXX (W)XXXX PXXXX IXXXX XXXX XXXX FXXXX

X, Y The parabola the end of the absolute coordinates value.

U, W The parabola the end of the incremental value relative to the starting point of the single block.

Note : When parabolic End X coordinate and the parabola starting point X coordinate equal, display will showing [ERR]R 05 .XX

When parabolic End Y coordinate and the parabola starting point Y coordinate equal, display will showing [ERR]R 05 .XX

P Parabolic program $X^2=4PY$ P value, Range(1~9999999), Unit: 0.001mm, Degree of opening of said parabolic shape. (When $P \leq 0$, system will showing [ERR]R 05.P to the display)

I The parabola X-axis interpolation step value, Range (0.001~9999.999) , Step away from the smaller, the precision will more higher. (When the X-axis step distance value $I \leq 0$, system will showing [ERR]R 05 .I to the display)

0 Counterclockwise parabolic parabola trajectory from the beginning to the end.

1 Parabolic trajectory from the beginning to the end clockwise parabolic.

The system default counterclockwise parabolic when \square not fill.

$\square \square \square 0$ The parabola command in pre \square ent processing can do tool compensation, but the surface finish is not high.

$\square \square 1$ The parabola command in at the point of interruption, can not do the tool compensation but high surface finish.

The system default $\square \square 0$ when \square not fill.

F \square Speed feed-rate (Can be used in con \square unction with any G-code).

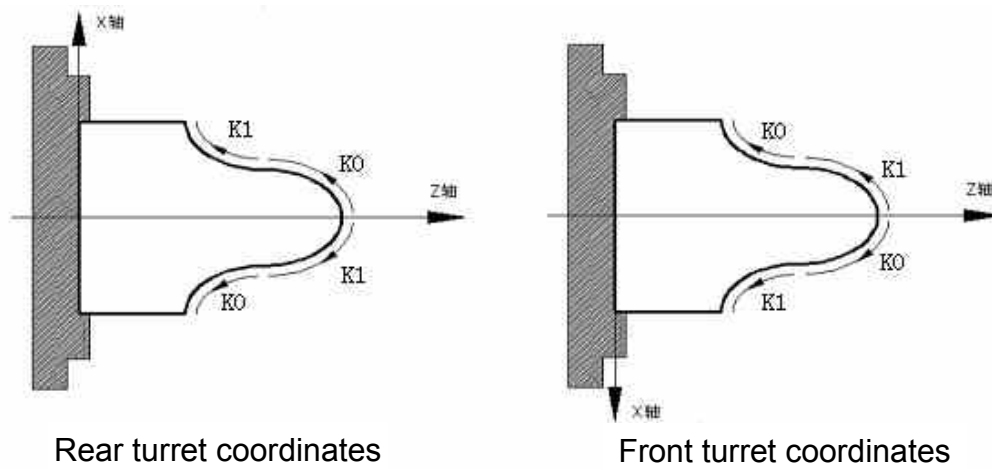

Fig 3-11 \square explanation

Program example :

When Parabolic command P□5mm, Its symmetry axis parallel to the □-axis machining dimensions of the parts shown in the Figure, the finishing program may be prepared as follows :

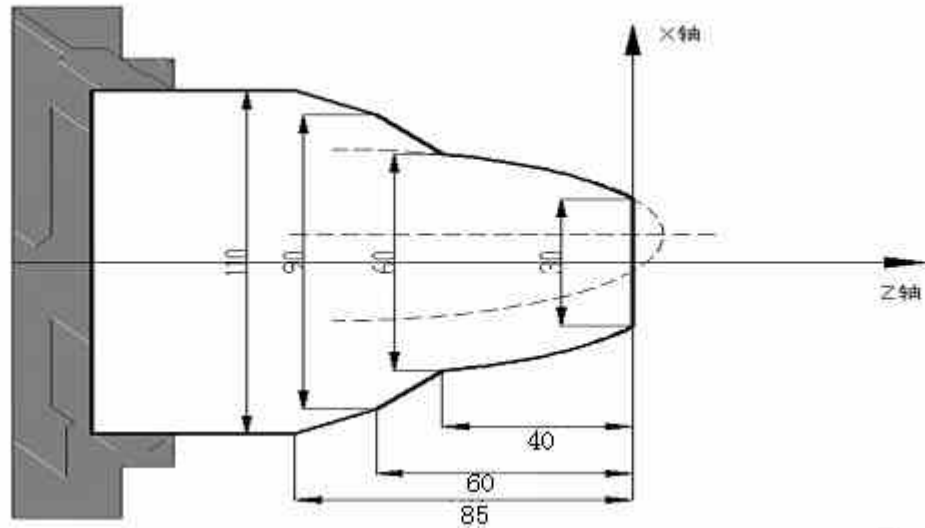

Fig 3-12

```

M03 S800
G00 X10. Y10.
G00 X0.
G01 X0. F120
M08
X30.
G05 X60. Y-40. P5000 X0 I1.
G01 X90. Y-60.
X110. Y-85.
X120.
M09
G00 X10.
M30
    
```

3.7 Exact Stop Check G09, G61, G62

Functions and Purposes:

This command provides the option of precision positioning for certain blocks (MCM#114 □ 256, Turning Corner Round Angle Connection), if so required, when M300 (round-angle connection between blocks) is enabled.

Program Format:

- G09 Exact stop check (effective between 2 blocks posterior to a G09 command)
- G61 Exact stop check mode (modal command, to be disabled by a G62 command when enabled).
- G62 Exact stop check mode cancel (modal command, to disable an enabled G61)

Program Example: (MCM#114 □ 256, Turning Corner Round Angle Connection)

```

M03 S1000
G01 □20. F1000
U10.
N10 U50.
    G09 -----    N20 and N21 Precision Positioning between blocks, on
                    completion of N20 block, □-axis speed decelerates to 0.
N20 U50.
N21 U50.
    G61 -----    Precision Positioning between blocks enable (N30---N50)
N30 U50.
N40 U50.
N50 U50.
    G62 -----    Precision Positioning between blocks disable
    □ □
    □ □
    □ □
G00 □0.
M30

```

3.8 Spindle Positioning Command, G15

Functions and Purposes:

This command sets the Spindle to a Position.

Program Format:

```
G15 R□□□□□P□□□□□
```

Parameters□

R□Stands for the Target Angle of Spindle Positioning

P□Stands for rpm of Spindle Positioning

Details:

R Parameter Format□With decimal point or omit decimal point and add 2 □eros at the end.

Program Example:

E□.□For spindle to be positioned at the angle of 175 degrees, any of the following commands may be gi□en□

Method 1□G15 R175.00

Method 2□G15 R175.

Method 3□G15 R17500

3.9 Cylindrical Plane, G16

Functions and Purposes:

Using the angular mo□ement of an angle command, con□ert it internally into a linear distance of the axis on the outer surface, for performing a linear interpolation or arc interpolation with another axis. After the interpolation, this distance is again con□erted into the mo□ement of the rotating axis.

Program Format:

1. Directly specify a cylinder interpolation axis and cylinder radius.
 - G16 \square xxxx.xxx \square Set \square -axis as the cylinder interpolation axis, xxxx.xxx as \square alue of cylinder radius.
 - G16 Axxxx.xxx \square Set A-axis as the cylinder interpolation axis, xxxx.xxx as \square alue of cylinder radius.
 - G16 Bxxxx.xxx \square Set B-axis as the cylinder interpolation axis, xxxx.xxx as \square alue of cylinder radius.
 - G16 Cxxxx.xxx \square Set C-axis as the cylinder interpolation axis, xxxx.xxx as \square alue of cylinder radius.

2. \square nly set the \square alue of cylinder radius \square the cylinder interpolation axis to be determined by the currently used spindle. (I.e., the axial direction for switching from the spindle mode to the ser \square o axis mode.)
 - G16 Hxxxx.xxx \square Set xxxx.xxx as the \square alue of cylinder radius.

When set with this method, the cylinder interpolation axis to be determined by the currently using spindle, and the current spindle must be con \square erted into ser \square o axis for performing cylinder interpolation.

- Ex \square First Spindle (C-axis) to be switched o \square er to ser \square o spindle mode for performing cylinder interpolation.

\square \square

N01 M50	\square First spindle switched into ser \square o mode
N10 G01 C0.	\square Positioning
N20 G18 \square 0 C0	\square Select \square -C plane
N30 G16 H20.	\square Cylinder interpolation enable, C-axis is cylinder interpolation axis \square cylinder radius 20mm.
N40 G42 \square 10.F1.0	\square Interpolate Tool Tip Radius \square ffset
N50 G01 \square 10.C30.	\square Linear Interpolation
N60 G03 \square 40.C60.R30.	\square Arc Interpolation
N70 G01 \square 60.C90.	\square Linear Interpolation
N80 G40 \square 90.	\square Tool Tip Radius \square ffset disable
N90 G16 C0	\square Cylinder Interpolation disable
N100 M51	\square Switch into spindle mode

\square \square

Note

1. If $xxxx.xxx \neq 0$, cylinder interpolation function is enabled.
If $xxxx.xxx = 0$, cylinder interpolation function is disabled.
2. Specifies G-code selection plane for this plane, the rotation axis is the specified linear axis.
3. E. If the rotation axis is parallel to an \square -axis, G17 must specify an \square - \square plane which is defined by the rotation axis and \square -axis, or a plane that is parallel to the \square -axis.
4. Feed speed specified in cylinder interpolation is the speed upon the spread surface of the cylinder.
5. In cylinder interpolation mode, arc radius in G02/G03 can only be specified with R parameter instead of I, \square , or \square .
E. Cylinder interpolation mode (Cylinder interpolation in \square -axis and C-axis)

```
G18  $\square$  $\square$  $\square$  $\square$  C $\square$  $\square$  $\square$  $\square$ 
G02 (03)  $\square$  $\square$  $\square$  $\square$  C $\square$  $\square$  $\square$  $\square$  R $\square$  $\square$  $\square$  $\square$ 
```
6. Tool-tip compensation is possible in cylinder interpolation mode. In order to carry out tool compensation in cylinder interpolation, any other in-progress tool compensation must be disabled before entering cylinder interpolation, then start and end tool compensation in cylinder interpolation mode.
7. If cylinder interpolation is started when a tool-tip compensation is in application, an arc interpolation cannot be accomplished correctly in cylinder interpolation.
8. In cylinder interpolation, the movement of a rotating axis actuated by an angular command is transformed as a distance in a linear axis for carrying out linear interpolation or arc interpolation with another axis. After interpolation, this distance is transformed back to an angle. For this transformation, input of displacement is the minimum incremental unit. When the cylinder has a small radius, the actual displacement is not equal to the specified displacement however this error is not accumulative.
9. Cylinder interpolation function ends when a reset is actuated.
10. A cylinder interpolation axis must be set as a rotation axis, and only one rotation axis shall be set.

Program Example:

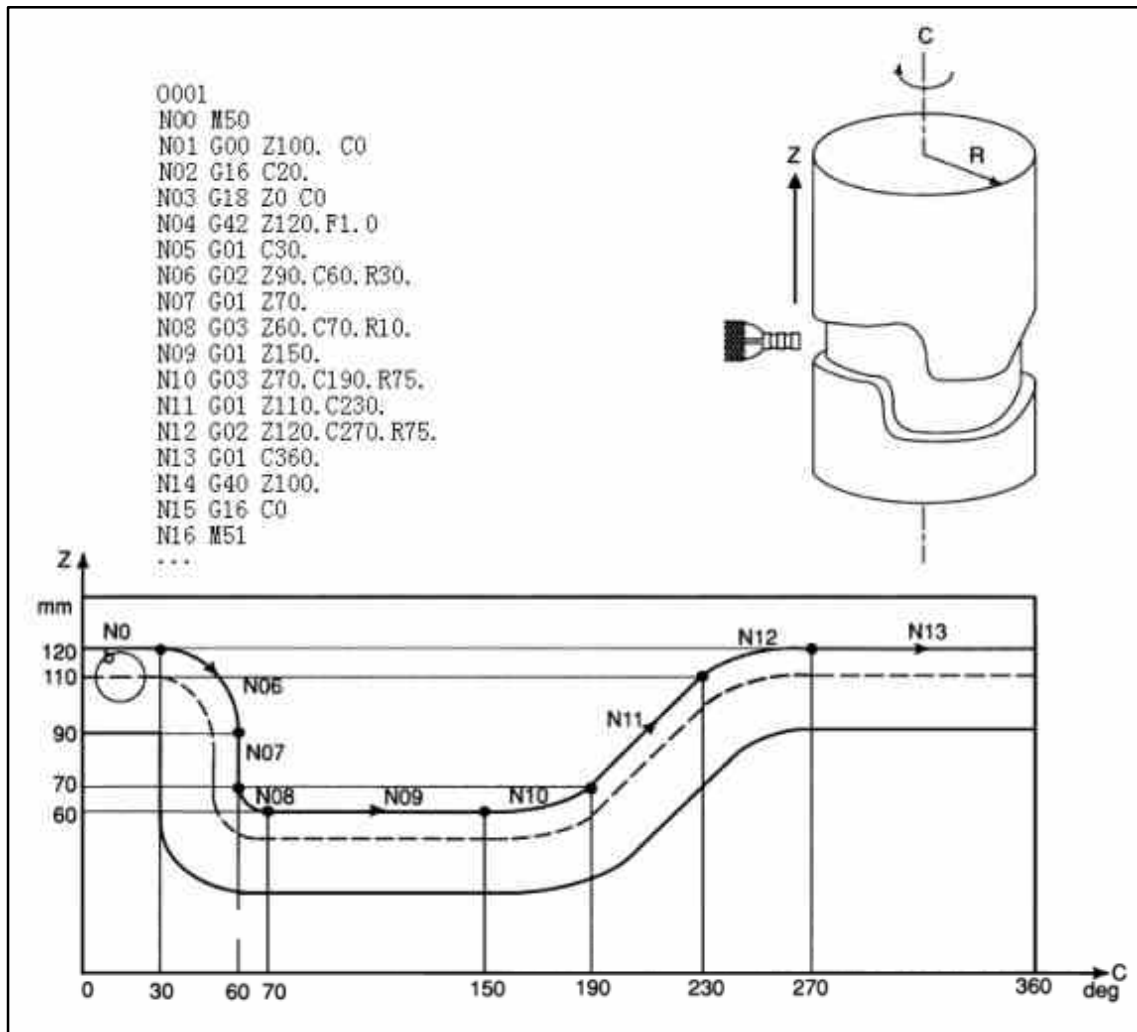

Fig. 3-13 Cylinder Interpolation

3.10 Plane setup, G17-G19

Functions and Purposes:

This command is for selecting a control plan or the plane where an arc is located.

Program Format:

1. If no axis direction is specified after a G17, G18, or G19 command, the arc plane is the default plane as shown below:

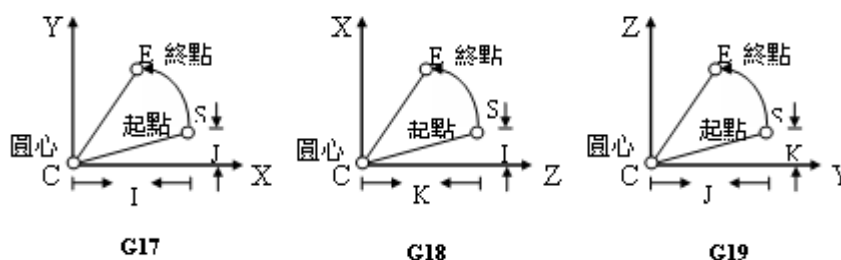

Fig. 3-14 Arc Plane

Table 3-4

Command	Horizontal Axis	Vertical Axis
G17 (IJ Plane selection)	X	Y
G18 (KI Plane selection)	Z	X
G19 (JK Plane selection)	Y	Z

2. G17, G18, G19 command may alter any of the horizontal axes or vertical axes.

G17 (I-J Plane Selection)

Table 3-5

Command	Horizontal Axis	Vertical Axis
G17 $\square 0 \square 0$	\square	\square
G17 $\square 0 A 0$	\square	A
G17 $\square 0 B 0$	\square	B
G17 $\square 0 C 0$	\square	C
G17 $\square 0 \square 0$	\square	\square
G17 A0 $\square 0$	A	\square
G17 B0 $\square 0$	B	\square
G17 C0 $\square 0$	C	\square
G17 $\square 0 \square 0$ (or G17)	\square	\square

G18 (J-K Plane Selection)

Table 3-6

Command	Horizontal Axis	Vertical Axis
G18 $\square 0 \square 0$	\square	\square
G18 $\square 0 A 0$	\square	A
G18 $\square 0 B 0$	\square	B
G18 $\square 0 C 0$	\square	C
G18 $\square 0 \square 0$	\square	\square
G18 A0 $\square 0$	A	\square
G18 B0 $\square 0$	B	\square
G18 C0 $\square 0$	C	\square
G18 $\square 0 \square 0$ (or G18)	\square	\square

G19 (Plane Selection)

Table 3-7

Command	Horizontal Axis	Vertical Axis
G19 $\square 0 \square 0$	\square	\square
G19 $\square 0 A0$	\square	A
G19 $\square 0 B0$	\square	B
G19 $\square 0 C0$	\square	C
G19 $\square 0 \square 0$	\square	\square
G19 A0 $\square 0$	A	\square
G19 B0 $\square 0$	B	\square
G19 C0 $\square 0$	C	\square
G19 $\square 0 \square 0$ (or G19)	\square	\square

Note:

1. In a plane layout command, there is no fixed sequence for the horizontal and vertical axes. E.g. $G17 \square 0 \square 0 \square G17 \square 0 \square 0$.
2. In G17, always use the I value to indicate the radial increment from the start point of an arc.
 In G18, always use the I value to indicate the radial increment from the start point of an arc.
 In G19, always use the I value to indicate the radial increment from the start point of an arc.

E.g.

G17 $\square 0 \square 0$ (Select $\square \square \square$ plane)

G02 $\square 10. \square 10. \square 10.$ (\square stands for the radial increment of the arc from the starting point of the vertical axis (\square -axis) (to the center of the arc).

3.11 Automatic Reference Position Return, G28

Functions and Purposes:

Via a G28 command, the specified axis is returned to the first reference point at the high feed-speed of the respective axis.

Format

```
G28
or G28 X(U)##### Z(W)#####
or G28 X(U)#####
or G28 Z(W)#####
```

Example:

Note that prior to executing the G28 command, the tool compensation command must be canceled.

Ex

```
G00 X1. Z1 . . . (From start-point to the intermediate point)
T100 . . . Tool compensation is canceled (it cannot co-exist
with G28 in the same block).
G28 . . . Tool returns to the 1st reference point on the X Z
-axis.
```

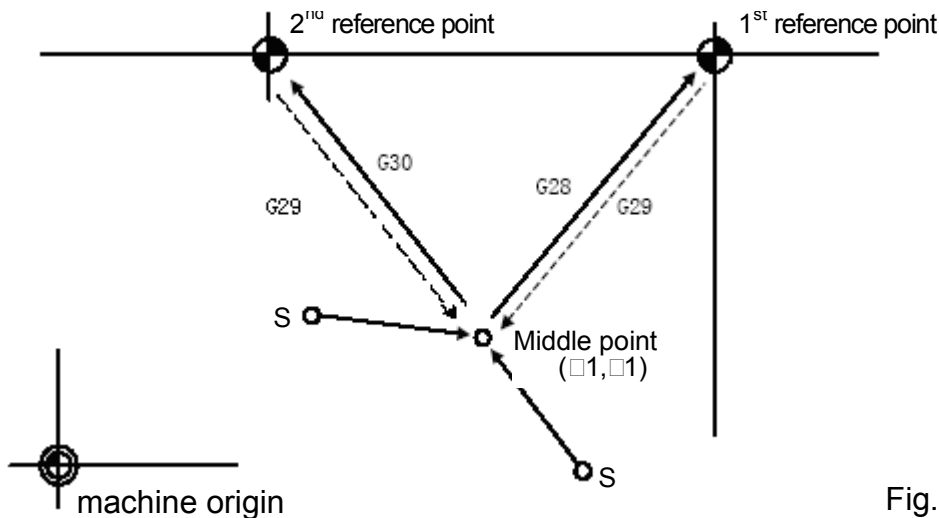

Fig. 3-15

Details:

1. The first reference point coordinates are set based on the □, □, and settings in MCM parameter G28.
2. The □, □ □ values in this format are not used. They only indicate which axis is to return to the reference point. Therefore, regardless of whether G28 is an independent block or contains □, □ commands simultaneously, the tools return to the reference point based on the □, □ settings of the MCM parameter.
3. Prior to executing G28, tool offset must be disabled.

3.12 Return From Reference Position, G29

Functions and Purposes:

After returning to the reference point by executing G28, use this (G29) command to return to the pre□ious target point prior to G28.

Format:

- G28
- or G28 □(U)□□□□□ □(W)□□□□□
- or G28 □(U)□□□□□
- or G28 □(W)□□□□□

Example:

E□□ N1 G00 □1. □1. . . . (From start-point to intermediate point)
 N2 T00 . . . □ffset disabled (shall not situate at the same block
 with G28)
 N3 G28 . . . □-Axis□□-Axis returns to first reference point
 N4 G29 . . . Program returns from first reference point to (□1, □1).
 (See Fig. 3-15)

As the example above, the N3 block may have the following combinations□

N4 G29 □ □□□□□ □ □□□□□ . . . Return to (□1, □1.)
 N4 G29 □ □□□□□ . . . Tool returns to □1.
 N4 G29 □ □□□□□ . . . Tool returns to □1.

Details:

1. The □□□ Value in the program format is insignificant□howe□er, a □alue must be gi□en for entering into the program, it merely tells the machine to which axis the reference point is to be returned.
2. After executing G28, use G29 command to return the tool to its pre□ious position before G28 is executed.
3. The G29 command cannot be used alone. A G28 or G30 must be gi□en prior to G29.

3.13 2nd Reference Position Return, G30

Functions and Purposes:

Via G30 command, the specified axis is returned to the second reference point at high feed-speed of the respecti□e axis.

Format□

G30
 or G30 □(U)□□□□□□ □(W)□□□□□□
 or G30 □(U)□□□□□□
 or G30 □(W)□□□□□□

Execution of this command is the same as G28, but the reference point is set in MCM parameter G30. (See Fig 3-15)

3.14 Thread Cutting, G32

Functions and Purposes:

G32 command performs spindle rotation by synchronized control of tool-feed therefore it is capable of processing linear thread cutting, inclined thread cutting and continuous thread cutting.

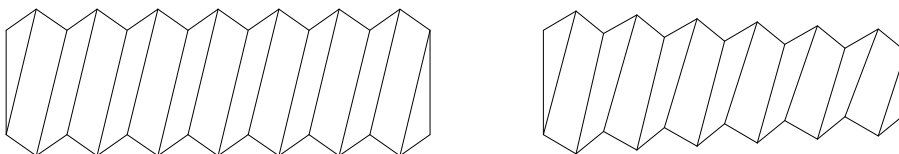

Fig. 3-16 G32 Thread cutting

Format:

G32 \square (U) \square \square \square \square \square (W) \square \square \square \square F \square \square \square \square \square \square \square E \square \square \square \square

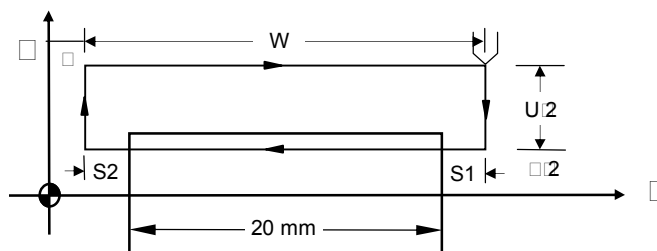

Fig. 3-17 Thread Cutting

(The U/2 Setting Should Not be Less Than Retraction Amount)

- \square , \square \square End point of thread cutting in absolute coordinates
- U, W \square End point of thread cutting in incremental coordinates relative to the start point.
- F \square Thread pitch
- \square \square Start-angle of thread cutting default value \square \square \square 0 (range of angle is 0-359 without a decimal point)
- E \square Number of threads per inch range \square 1.0-100.0. This setting shall not appear when an F setting is given.

Details:

- Both fine cut and rough cut of the thread cutting proceed along the same path. The cutting action on the X-axis does not start until the Grid signal is received from the spindle. All repeated cutting actions start at the same point.
- Due to delay of the server system, imperfections could result at both ends of the thread (S1 and S2). To avoid this problem, the thread length specified in the program should be slightly longer than the actual length of the processed thread. S1 and S2 are leads. The length of S1 and S2 is estimated using the formula below.

$$S1 = (S * F / 1800) * (-1 - \ln A)$$

$$S2 = (S * F / 1800)$$

S1, S2 = Imperfect thread length, mm

S = Spindle speed, rpm

F = Thread pitch, mm

A = Acceptable thread error

Relationship between A and $(-1 - \ln A)$

Table 3-8

A	$-1 - \ln A$
0.005	4.298
0.010	3.605
0.015	3.200
0.020	2.912
0.025	2.689

Example

Ex 1 Non-tapered thread cutting

Specifications

Thread pitch	F = 2 mm,
cutting lead starts	S1 = 3 mm,
cutting lead ends	S2 = 3 mm,
Thread depth	= 1.4 mm (in diameter) by 2 cuts

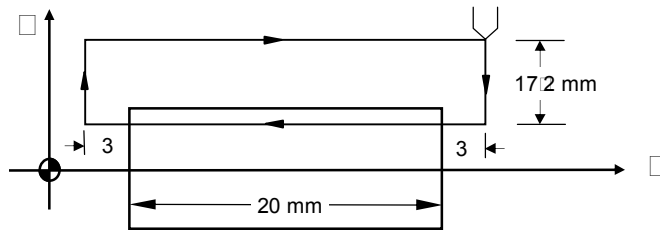

Fig. 3-18 Non-tapered Thread Cutting

```

N10 G0 X30.0 Z50.0
N20 M03 S2000
N30 G0 U-17.000 (first cut X 1.0 Z2mm)
N40 G32 W-26.000 F2.00
N50 G0 U17.000
N60 W26.000
N70 G0 U-17.400 (second cut X 0.4 Z2mm)
N80 G32 W-26.000 F2.00
N90 G0 U17.400
N100 W26.000
N110 M05
N120 M02
    
```

Ex 2 Tapered thread cutting

```
G32 X(U) _____ Z(W) _____ F _____ R _____ A _____ E _____
```

- X, Z End point of thread cutting in absolute coordinates.
- U, W End point of thread cutting in incremental coordinates relative to the start point.
- F Thread pitch.
- R Half of the difference (diameter) between the greater and smaller ends of the tapered thread.
- A Start-angle of thread cutting default value 0 (range of angle is 0-359 without a decimal point)
- E Number of threads per inch range 1.0-100.0. This setting shall not appear when an F setting is given.

Specifications

- Thread pitch F 2 mm
- Cutting lead starts S1 2 mm,

Cutting lead ends S2 \square 2 mm,
 Thread depth \square 1.4 mm (diameter) formed by two cutting
 actions.

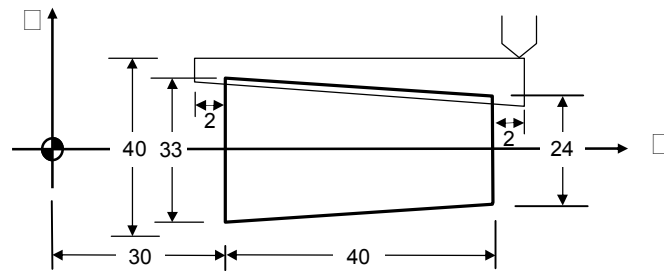

Fig 3-19 Tapered Thread Cutting

Note: Tapered thread

- For the angle between taper plane and \square -axis less than 45° , pitch shall be set along the \square -axis.
- For the angle between taper plane and \square -axis more than 45° , pitch shall be set along the \square -axis.
- For the angle between taper plane and \square -axis equal to 45° , pitch can be set along either the \square -axis or \square -axis.

N10 G0 \square 60.0 \square 100.0
 N20 M03 S2000
 N30 G0 \square 23.0 \square 72.0 (First cut \square 1.0 \square 2mm)
 N40 G32 \square 32.000 \square 28.000 F2.00 R-4.5
 N50 G0 \square 40.000
 N60 \square 72.000
 N70 G0 \square 22.6 (Second cut \square 0.4 \square 2mm)
 N80 G32 \square 31.6 \square 28.0 F2.00 R-4.5
 N90 G0 \square 40.000
 N100 \square 72.000
 N110 M05
 N120 M02

Ex 3 \square Multi-stage continuous thread cutting

G00 \square 0.
 M03 S3000 ; \square quick positioning to start point
 G32 \square 50.F1. ; Thread of first stage
 G32 \square 100.F2. ; Thread of second stage

G32 X150.F3 ; Thread of third stage
M05
M30

If set as above, the thread cutting process will have no stop in the X-axis during thread cutting, therefore the cut threads are **smooth and continuous**.

3.15 G33 Tapping Cutting Canned Cycle

Purpose and Function:

Rigid thread cutting

Command Format:

G33 X(W)XXXXXXXXXX FXXXXXX
G33 X(U)XXXXXXXXXX FXXXXXX

X(W) X(U) XEnd-point coordinate or length of thread cutting
F XPitch

Details: Execution process of X-axis thread cutting

1. X Axis feed of thread cutting
2. Switch off spindle
3. Wait until the spindle fully stops
4. Reverse the spindle (in the opposite direction of the original rotation)
5. X-axis tool retracts
6. Spindle stops

Program Example: One-end thread with 1mm pitch (e.g., in X-axis)

```
N10 M3 S800  
N20 G33 X100. F1.0  
N30
```

Note 1 Ensure the spindle rotation is in the threading direction before starting thread cutting. Spindle will stop rotation when the thread cutting is

completed. For the subsequent process, start the spindle as required.

Note 2 Since this command is a rigid thread cutting, when a spindle stop command is enabled, the spindle decelerates for a certain period of time before reaching the full stop, and X-axis will still move along with spindle rotation before spindle fully stops. Therefore for the actual process, the end of thread cutting will be a little bit deeper than the actual requirement.

Note 3 Other precautions are the same as that of G32 Thread Cutting.

3.16 G34 Variable Lead Thread Cutting

Functions and Purposes:

Applicable for processing variable lead threads

Command Format:

G34(U) (W) F () () () () E ()

- 1) Parallel thread G34 (W) F () () () ()
- 2) Tapered thread G34 (U) (W) F () () () ()

- () \ () End point of thread cutting in absolute coordinates
- U \ W End point of thread cutting in incremental coordinates relative to the start point
- F Thread Pitch
- () Start-angle of thread cutting default value 0 (range of angle is 0-359 without a decimal point)
- E Number of threads per inch range 1.0-100.0. This setting shall not appear when an F setting is given.

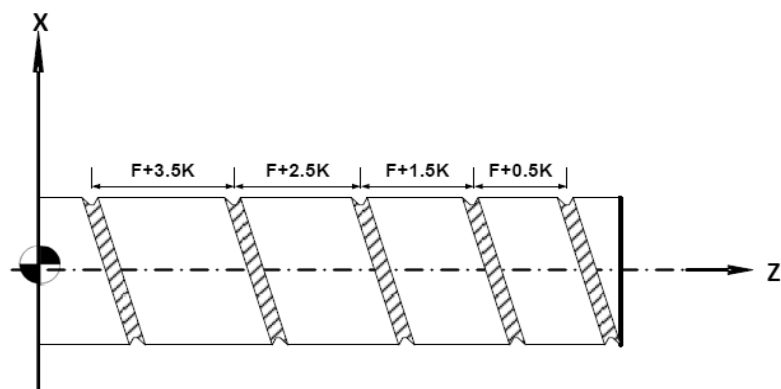

Fig.3-20

Details:

1. For single stage thread cutting, fine cutting and rough cutting are along the same path, therefore when starting the thread cutting, it waits for a GRID signal to be detected from the spindle position before starting X-axis for cutting action (L parameter left blank or set as 0). Each repeated cutting starts from this fixed point.
2. For multi-stage thread cutting, based on technical requirements, in general the subsequent stages starting from the second stage do not need to detect the GRID signal mainly for connecting smoothly with the previous stage. (See Fig.3-20)
3. In general incomplete end threads (S1 and S2) occur due to time lag in the servo system, therefore the specified thread length shall be slightly longer than the processed thread length. S1 and S2 are called thread leads. A simple way to calculate the length of incomplete threads S1 and S2 is shown as follows

$$S1 = (S * F / 1800) * (-1 - \ln A)$$

$$S2 = (S * F / 1800)$$

S1,S2 Length of incomplete threads, mm

S Spindle rotation, rpm

F Pitch, mm

A Thread tolerance

Relation ship between A and (-1 - Ln A) is as follows

Table 3-9

A	-1 - Ln A
0.005	4.298
0.010	3.605
0.015	3.200
0.020	2.912
0.025	2.689

Example Program 1 (parallel thread cutting with equal pitch)

Cutting specification Pitch

F = 2 mm,

Lead for start-of-cutting $S1 = 3 \text{ mm}$,
 Lead for end-of-cutting $S2 = 3 \text{ mm}$,
 Cutting depth $= 1.4 \text{ mm}$ (diameter), in 2 cutting sessions

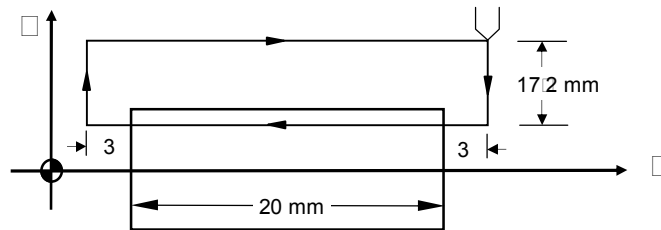

Fig.3-21 Parallel thread cutting with equal pitch

```

N10 G0 X30.0 Z50.0
N20 M03 S2000
N30 G0 U-17.000 (first cutting 1.0mm)
N40 G34 W-26.000 F2.00 I0.5
N50 G0 U17.000
N60 W26.000
N70 G0 U-17.400 (second cutting 0.4mm)
N80 G34 W-26.000 F2.00 I0.5
N90 G0 U17.400
N100 W26.000
N110 M05
N120 M02
    
```

Program Example 2 (Tapered thread cutting)

Cutting specifications \square Pitch $F = 2 \text{ mm}$,
 Lead for start-of-cutting $S1 = 2 \text{ mm}$,
 Lead for end-of-cutting $S2 = 2 \text{ mm}$,
 Cutting depth $= 1.4 \text{ mm}$ (diameter), in 2 cutting sessions

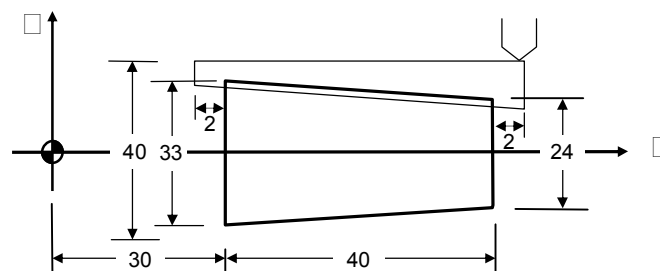

Fig.3-22 Tapered thread cutting

Tapered threads, for angle between taper plane and X-axis less than 45°, pitch shall be set along X-axis, for angle between taper plane and X-axis more than 45°, pitch shall be set along Z-axis.

```

N10 G0 X60.0 Z100.0
N20 M03 S2000
N30 G0 Z23.000 X72.000 (First cutting 1.0mm)
N40 G34 X32.000 Z28.000 F2.00 Z0.5
N50 G0 X40.000
N60 Z72.000
N70 G0 Z22.600 (Second cutting 0.4mm)
N80 G34 X31.600 Z28.000 F2.00 Z0.5
N90 G0 X40.000
N100 Z72.000
N110 M05
N120 M02
    
```

Multi-stage thread cutting with variable-pitches

As shown in Fig.3-21, the first 2 stages are variable-pitch threads with F=1.0mm, Z=0.5mm the transition from first stage to second stage is a smooth connection threads of the third stage have an equal pitch F=3.0mm, the transition from second stage to third stage is a smooth connection.

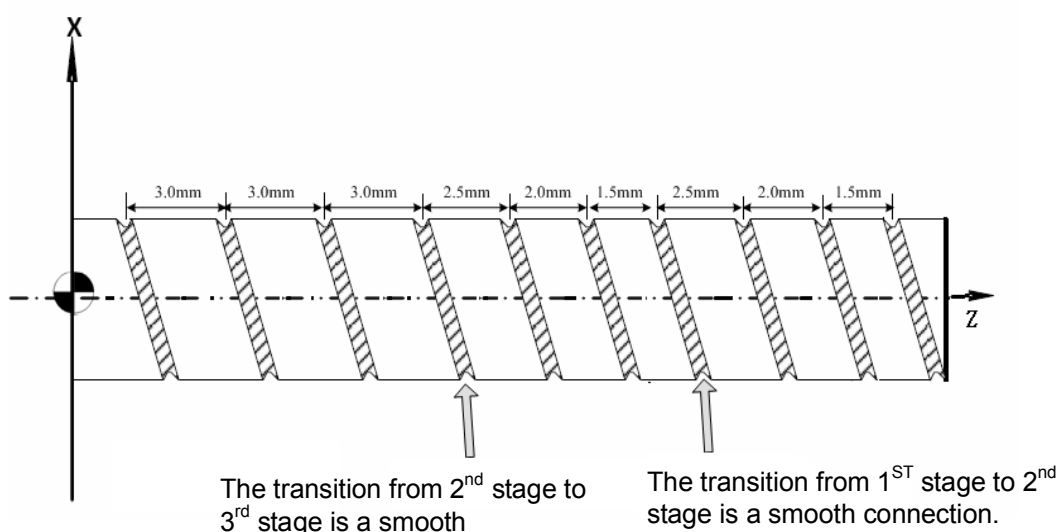

Fig.3-23 Multi-stage thread cutting with variable pitches

Program Example 3

```

T03
M03 S1000
M08
G00 X0.0 Z0.0           □ Quick positioning to start point
G34 X-30.0 F1.0 I0.5     □ Thread of first stage with variable pitch
G34 X-50.0 F1.0 I0.5     □ Thread of second stage with variable
pitch
G32 X-60.0 F2.0         □ Thread of third stage with equal pitch
M09
M05
M30

```

If set as above, the thread cutting process will have no stop in X-axis during thread cutting, therefore the cut threads are **smooth and continuous**.

3.17 Canned Cycle Functions (For implication of programming)

The canned cycle function is a special G-code of command groups. It comprises canned cycle cutting actions commonly used in machining processes. The command groups of H4D-T Series are classified into single canned cycle and compound canned cycle command groups. Both are handy and effective in programming and applications.

3.17.1 Single Cutting Canned Cycle, G90, G92, G94

Functions and Purposes:

This command group executes repeated cutting with a block. It should end with G01 after use otherwise, the cutting cycle will repeat.

1. Longitudinal Cutting Fixed Cycle, G90

Format:

```
G90 X(U)□□□□ Z(W)□□□□ F□□□□
```

- X, Y End point C in absolute coordinates (Fig. 3-22)
- U, W End point C in incremental coordinates relative to the start point A
- F B-C-D feed-rate

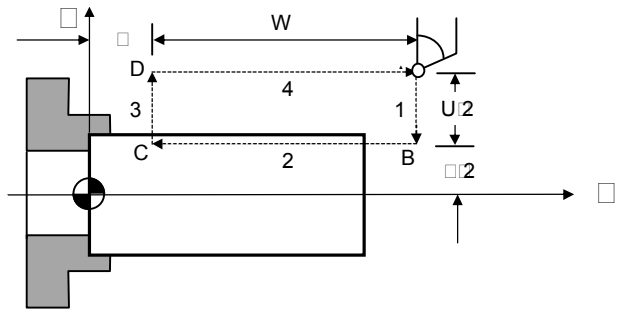

Fig. 3-24 G90 Linear Cutting Path

Details:

In Fig. 3-22, the cutting paths 1 and 4 are fast positioned by G00. The cutting along the paths 2 and 3 is executed at the feed-rate F. Whenever the start button (C-CST) is pressed in a block, the tool moves along the paths 1-2-3-4 to execute a cutting cycle.

2. Outer/Inner Diameter Tapered Lateral Canned Cycle, G90

Format:

G90 $X(U) \quad Y(W) \quad R \quad F$

- R The difference between point B and C in radius.
- X, Y, U, W and F are identical to those in lateral linear canned cycle.

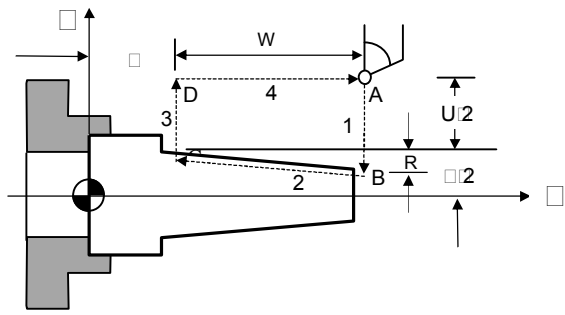

Fig. 3-25 G90 Tapered Cutting Path

Details:

When using incremental coordinates, the signs (±) of U and W are determined by the tool's direction of movement. If the direction is positive, the increment of U and W is (+), and vice versa. R value is as Fig. 3-26.

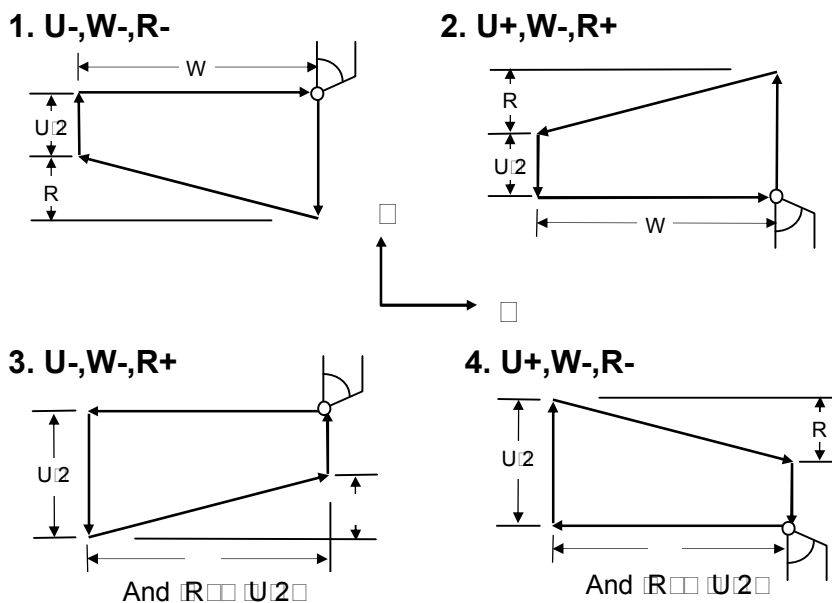

Fig. 3-26 G90 Cutting Path and Direction

3. Thread Cutting Fixed Cycle, G92

The advantage of the G92 block is that it functions as four G32 blocks.

Format:

G92 X(U) Z(W) I L F E

- X, Z End point C in absolute coordinates
- U, W End point C in incremental coordinates
- F Thread pitch (metric)
- E Number of threads per inch range from 1.0-100.0. This setting shall not appear when an F setting is given.
- I The axial travel length on X-axis for ending of the thread cutting. If I ≠ 0, I will be omitted and regarded as 2*I (i.e. ending of the thread cutting at 45°).
- The axial distance on X-axis from the start point to the end point for the end of thread cutting.

- L Multiple-thread setting. Range 1-9. For G92 only.
 L is a modular value and valid all the time once it is set. If L and " " are set at the same time, the L-value will be regarded as invalid.
- Offset setting of the thread initial angle. Range 0-359. For G92 only.

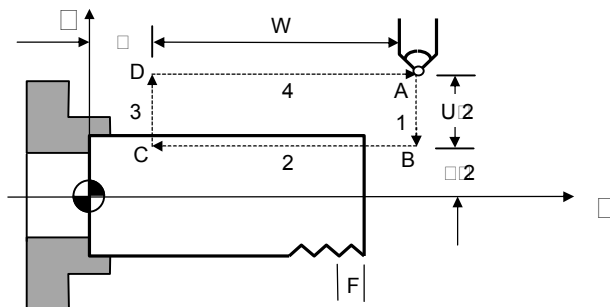

Fig. 3-27 G92 Linear Thread Cutting Canned Cycle

Details:

- (1) The range of the thread lead and the speed limit of the spindle are same as G32 (thread cutting).
- (2) When the start button (C=CST) is pressed in a block, the tool moves along the paths 1-2-3-4 to execute a cutting cycle.
- (3) Subject to the restrictions of G32.
- (4) Where a feed hold command is given during the cutting, the linear thread cutting canned cycle does not stop until the cutting on path 3 is complete.

4. Tapered Thread Cutting Canned Cycle, G92

Format:

G92 (U) (W) R L F E

R The difference between point B and C in radius.

, , U, W, L, , F, E are identical to those of the linear thread cutting canned cycle.

Description of the tapered thread cutting is identical to linear thread cutting.

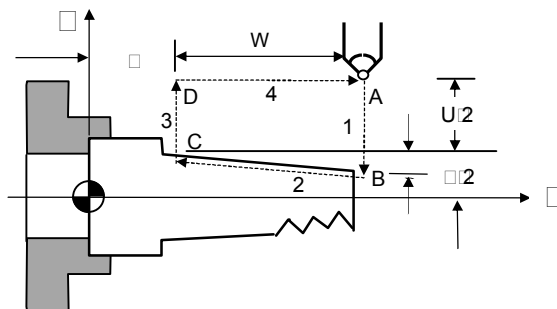

Fig. 3-28 G92 Tapered Thread Cutting Canned Cycle

5. Face Cutting Fixed Cycle, G94

Format

G94 (U) (W) F

- (), () End point C in absolute coordinates.
- U, W End point C in incremental coordinates relative to the start point A.
- F B-C-D feed-rate.

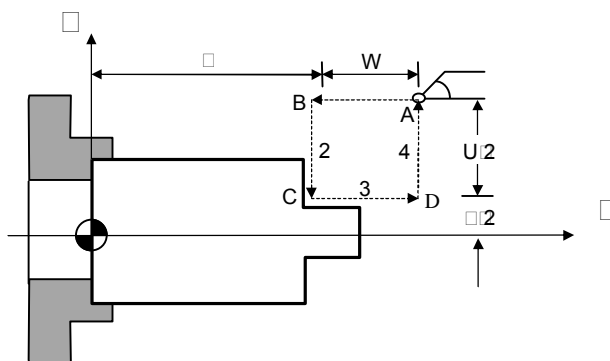

Fig. 3-29 G94 Linear Traversed Cutting Path

In Fig. 3-27, the cutting paths 1 and 4 are fast positioned by G00. The cutting along paths 2 and 3 is executed at the feed-rate F. Whenever the start button (C-CST) is pressed in a block, the tool moves along the paths 1-2-3-4 to execute a cutting cycle.

6. Face Cutting Fixed Cycle, G94

Format

G94 $\Delta(U)\Delta\Delta\Delta\Delta(W)\Delta\Delta\Delta\Delta(R)\Delta\Delta\Delta\Delta(F)\Delta\Delta\Delta\Delta$

R Δ The difference between point B and C in radius.

Δ , Δ , U, W and F are identical to those of the linear tra Δ ersed canned cycle.

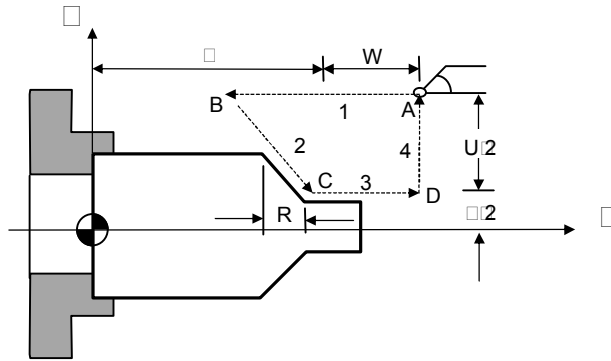

Fig. 3-30 G94 Tapered Traversed Cutting Path

When using incremental coordinates, the signs (Δ) of U and W are determined by the tool's moving directions. If the moving direction is positive, the increment of U and W is (Δ), and vice versa. R value is as Fig. 3-31.

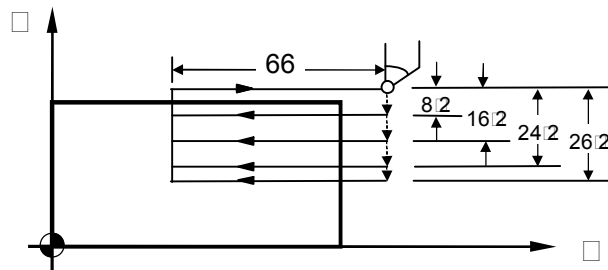

Fig. 3-31 G94 cutting Path and Direction

Note that G90, G94, G92 are modal codes and all the values for $\Delta(U)$, $\Delta(W)$ and R remain valid unless they are redefined or another G-command is given.

As shown in Fig. 3-32, if the length of movement on X-axis is fixed, the canned cycle is repeated merely by executing the X-axis positioning command.

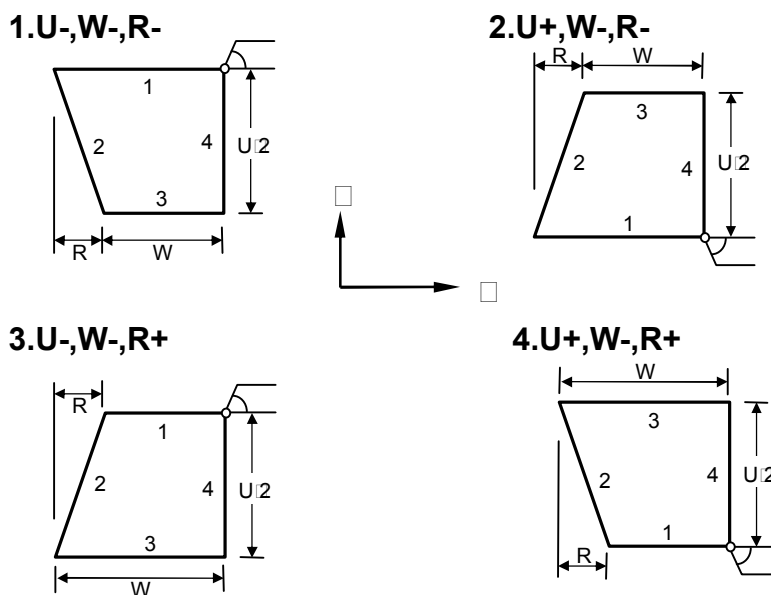

Fig 3-32 G90 Programming Example

```

N10 G0 □80.0 □100.0
N20 M3 S2000
N30 G90 U-8.0 W-66.0 F2.00
N40 U-16.0
N50 U-24.0
N60 G0 U-26.0
N70 G1 W-66.0 F1.00      · · · Finishing cut with G01
N80 U2.0
N90 G0 □80.0 □100.0
N100 M5
N110 M2

```

3.17.2 Compound Canned Cycle Functions, G70~G76

Compound canned cycles simplify the operation of CNC commands, once the data of a work-piece is set for fine cut, the CNC automatically determines the tool path for the rough cut. Compound canned cycles are also used for thread cutting. This function is particularly suited for column cutting.

1. Finishing Cycle, G70

Functions and Purposes:

After a work-piece undergoes rough cut with G71, G72 or G73, G70 is used for fine cut of the work-piece to ensure its precision.

Format:

G70 P(ns)□□□□ □(nf)□□□□

P(ns) □ The number of the first block for a fine cut cycle.

□(nf) □ The number of the last block for a fine cut cycle.

Details:

- (1) The F, S, and T functions of G71, G72, G73 and previous blocks are applicable to G70. wherer F, S, or T is changed in the blocked from P(ns) to □(nf), the changed □alues pra□eil.
- (2) When G70 is executed, the tool returns to the start point and reads the next block.

2. Longitudinal Rough Cutting Cycle, G71

Format:

G71 U(△d)□□□□ R(e)□□□□

G71 P(ns)□□□□ □(nf)□□□□ U(△u)□□□□ W(△w)□□□□ F(f)□□□□ S(s)□□□□

T(t)□□□□

N(ns)

.

.

N(nf)

G00 □□□ □□□

□ Tool mo□e back

Txxxx

□ Change tool (fine cutting)

G00 □□□ □□□

□ Mo□e to the start position of Canned Cycle

G70 P(ns) □(nf)

□ Fine cutting

Parameters:

In Fig. 3-33, the fine cut path is $A \rightarrow A1 \rightarrow B$. $A \rightarrow C$ is the distance reserved for fine cut tool retraction. The cutting depth is $U(\Delta d)$. The amount of the material to be removed for fine cutting is $(\Delta u/2)$ and (Δw) . The amount of retraction after each cut is $R(e)$. The path of the final rough cut is parallel to the path of the fine cut. The definition of command groups in the program format is described below

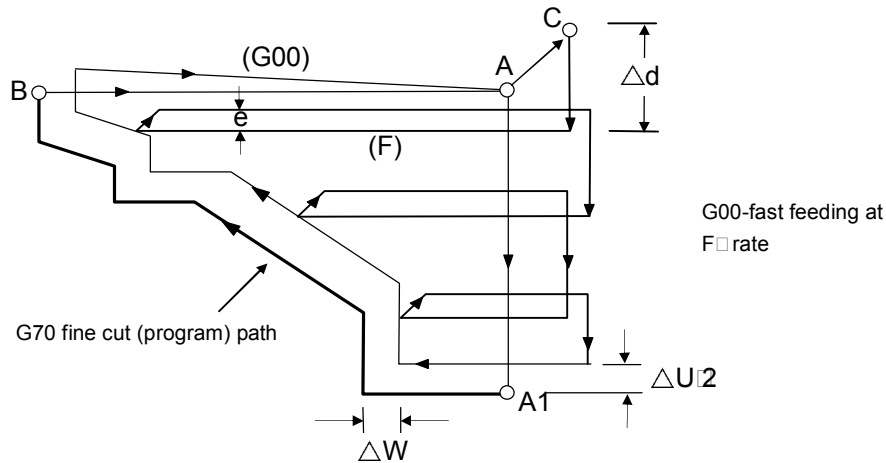

Fig. 3-33 Tool Path of G71 Rough Cut Canned Cycle

- $U(\Delta d)$ □ Cutting depth (radius programming, □).
If not specified, the **parameter "G71, G72 Feeding Amount"** is used.
- $R(e)$ □ Amount of retraction after each rough cut (radius programming).
If not specified, the **parameter "G71, G72 Retraction Amount"** is used.
- $P(ns)$ □ The number of the first block for a fine cut cycle.
- (nf) □ The number of the last block for a fine cut cycle.
- $U(\Delta u)$ □ Amount of material to be removed for fine cut, □-axis.
- $W(\Delta w)$ □ Amount of material to be removed for final cut, □-axis.
- $F(f), S(s), T(t)$ □ F □ feed-rate. S □ spindle speed, T □ tool selection.

The F , S , and T functions of G71 and previous blocks are applicable to G71, but all F , S , and T functions from $N(ns)$ to $N(nf)$ are not applicable to G71. They are only applicable to the fine cut command G70.

Details

- (1) N(ns)~N(nf) specify the machining path of A1~B.
- (2) A maximum of 50 blocks can be inserted from N(ns) to N(nf).
- (3) No subprogram is available from N(ns) to N(nf).
- (4) No assignment of positioning commands on X-axis is allowed from A to A1.
- (5) The feed-rate from A to A1 is either G00 or G01.
- (6) The X and Z tool path from A1 to B must be incremental or decremental.
- (7) The cutting depth U(Δd) and retraction amount of rough cut R(e) are modal codes. They remain valid until another value is specified.
- (8) G71 is applicable to the following four cutting types. They are all parallel to the X-axis. Whether U and W are positive or negative (Fig. 3-34) is determined by the direction of tool path.

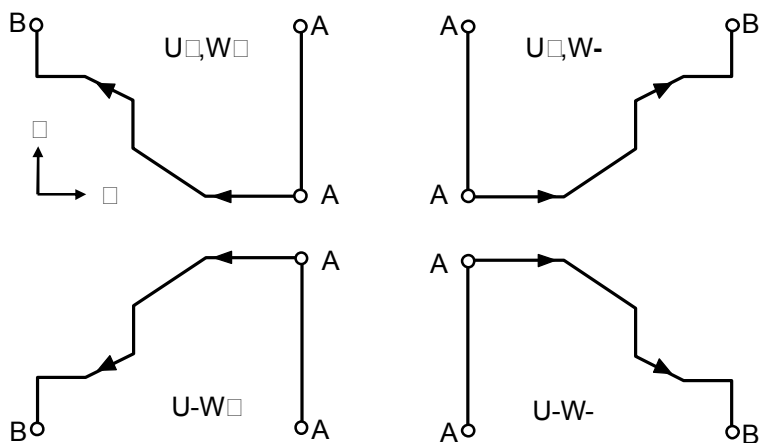

Fig. 3-34 G71 Rough Cut Canned Cycle

Programming example of G70, G71 compound canned cycle:

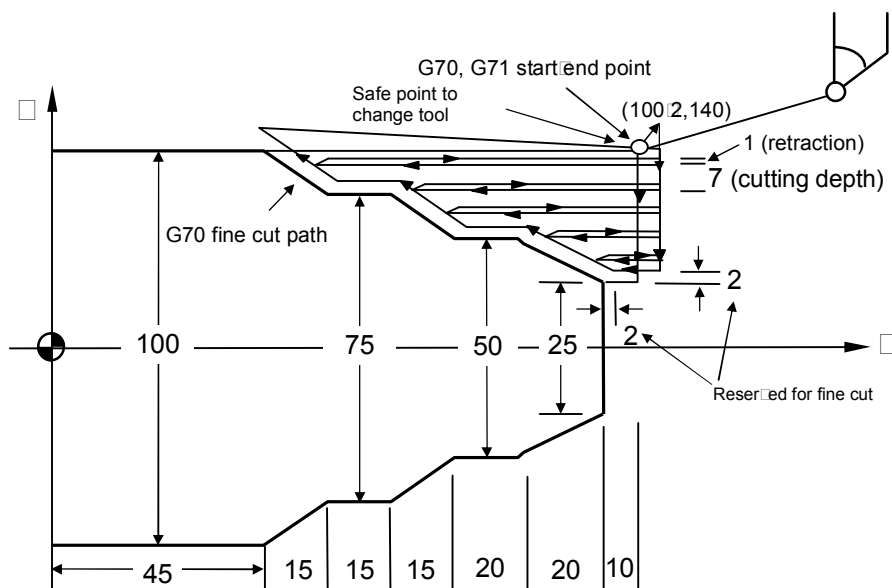

Fig. 3-35 Programming Example of G71, G70 Compound Canned Cycle

```

G28 W0.
T0202
M3 S3000
G00 X100.000
      Z140.000
G71 U7.000 R1.000
G71 P100 X200 U4.000 W2.000 F2.00
N100 G01 X25.0 F1.50
      W-10.000
      X50.000 W-20.000
      W-20.000
      X75.000 W-15.000
      W-15.000
N200 X100.000 W-15.000
G00 X110.
      Z150.
T0303
G00 X100.
      Z140.
G70 P100 X200
M05 S0
M30
    
```

3. Face Rough Cutting Cycle, G72

Functions and Purposes:

Calls a forming program and calculates tool path automatically while executing a transversed rough cutting.

Format:

G72 W(Δd) $\square\square\square$ R(e) $\square\square\square$
 G72 P(ns) $\square\square\square$ \square (nf) $\square\square\square$ U(Δu) $\square\square\square$ W(Δw) $\square\square\square$ F(f) $\square\square\square$ S(s) $\square\square\square$ T(t) $\square\square\square$

N(ns)

 N(nf)

G00 $\square\square\square\square\square\square$ \square Tool move back
 Txxxx \square Change tool (fine cutting)
 G00 $\square\square\square\square\square\square$ \square Move to the start position of Canned Cycle
 G70 P(ns) \square (nf) \square Fine cutting

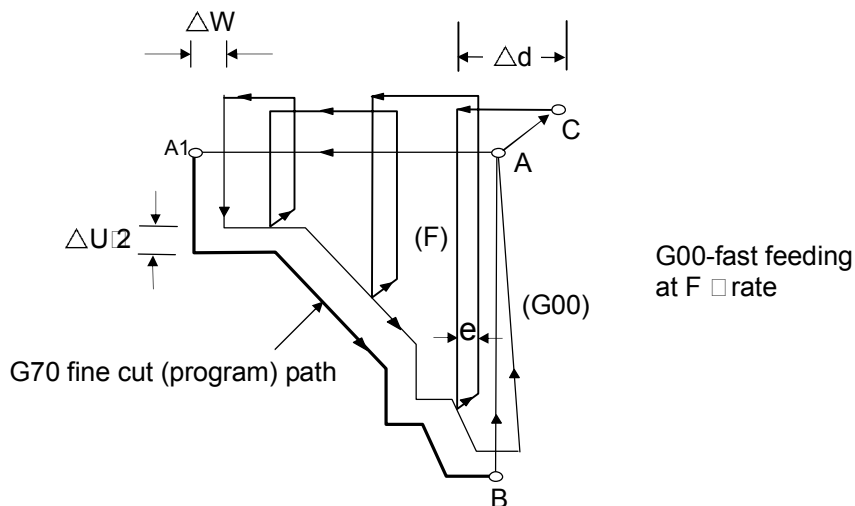

Fig. 3-36 Cutting Path of G72 Compound Canned Cycle

As shown in Fig. 3-36, all functions of G72 are same as G71, except that the cycle path is parallel to the X-axis.

Details:

- (1) N(ns)□N(nf) define the machining path of A1□B.
- (2) No assignment of positioning commands on □-axis is allowed from A to A1.
- (3) The feed-rate from A to A1 is either G00 or G01.
- (4) The □ and □ tool path from A1 to B must be incremental or decremental.
- (5) No subprogram is available from N(ns) to N(nf).
- (6) G72 is applicable to the following four cutting types. They are all parallel to □-axis. Whether U and W are positive or negative (Fig. 3-37) is determined by the direction of tool path.

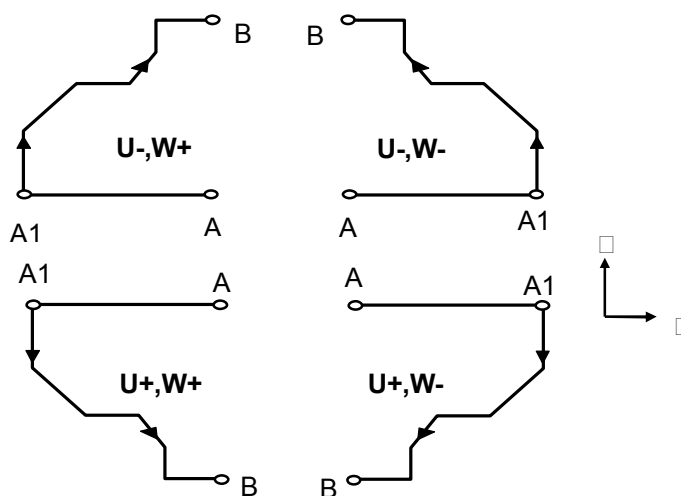

Fig. 3-37 Cutting Path of G72 Compound Canned cycle

Example : G72, G70 compound canned cycles

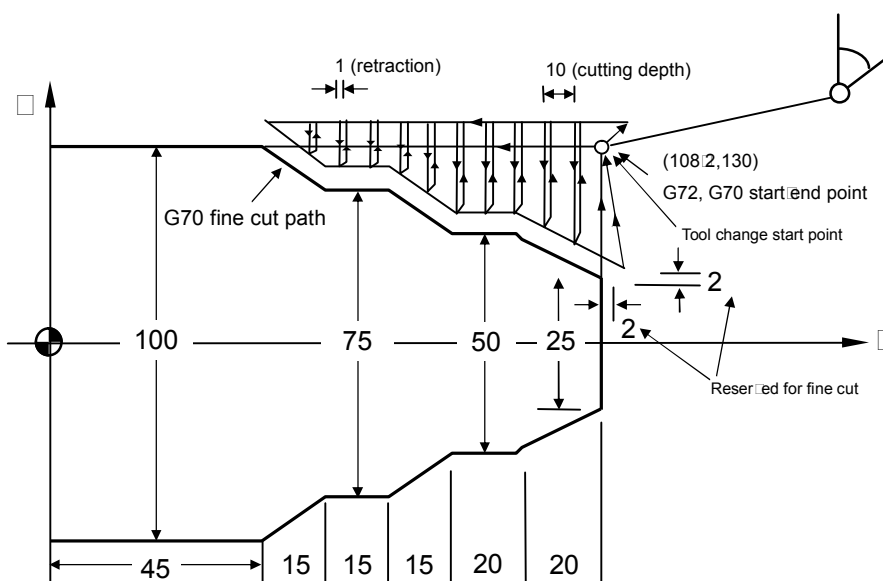

Fig. 3-38 Programming Example of G72, G70 Compound Canned Cycles

```

G28 W0.
T0202
M3 S2000
G00 □108.000 □130.000
G72 W10.000 R1.000
G72 P100 □200 U4.0 W2.0 F3.00
N100 G00 □45.000
G01 □75.000 W15.000 F1.50
W15.000
□50.000 W15.000
W20.000
N200 □25.000 W20.000
G00 □110.
□140.
T0303
G00 □108.
□130.
G70 P100 □200
M05 S0
M30
    
```

4. Formed Material Rough Cutting Cycle, G73

Functions and Purposes:

To save machining time, G73 is used to cut a work-piece that has been machined in a rough cut, forging or casting process and formed with a shape similar to the finished-product.

Format□

```

G73 U(Δi)□□□ W(Δk)□□□ R(d)□□□
G73 P(ns)□□□ □(nf)□□□ U(Δu)□□□ W(Δw)□□□ F(f)□□□ S(s)□□□ T(t)□□□
    
```

```

N(ns)      . . . . .
           . . . . .
           . . . . .
N(nf)     . . . . .
    
```

- G00 □□□ □□□ □ Tool mo□e back
- Txxxx □ Change tool (fine cutting)
- G00 □□□ □□□ □ Mo□e to the start position of Canned Cycle
- G70 P(ns) □(nf) --- □ Fine cutting

Parameters:

- U(Δi) □ Cutting amount on □-axis. (radius programming)
If not defined, the **parameter "G73 Total Cutting Amount "** is used.
- W(Δk) □ Cutting amount on □-axis.
If not defined, the **parameter "G73 Total Cutting Amount"** is used.
- R(d) □ Rough Cutting Cycles
I.e. times of cuts re□uired to reach the defined cutting depth on □ and □-axes. If not defined, the **parameter "G73 Cutting Cycles"** is used.
- P(ns) □ The first block number of a fine cut cycle.
- (nf) □ The last block number of a fine cut cycle.
- U(Δu) □ Amount of material to be remo□ed for fine cut, □-axis.
- W(Δw) □ Amount of material to be remo□ed for final cut, □-axis.

F(f),S(s),T(t)□F □ feed-rate, S □ spindle speed, T □ tool selection.
The F, S, and T functions of G73 and pre□ious blocks are applicable to G73, but all F, S, and T functions from N(ns) to N(nf) are not applicable to G73. They are only applicable to the fine cut command G70.

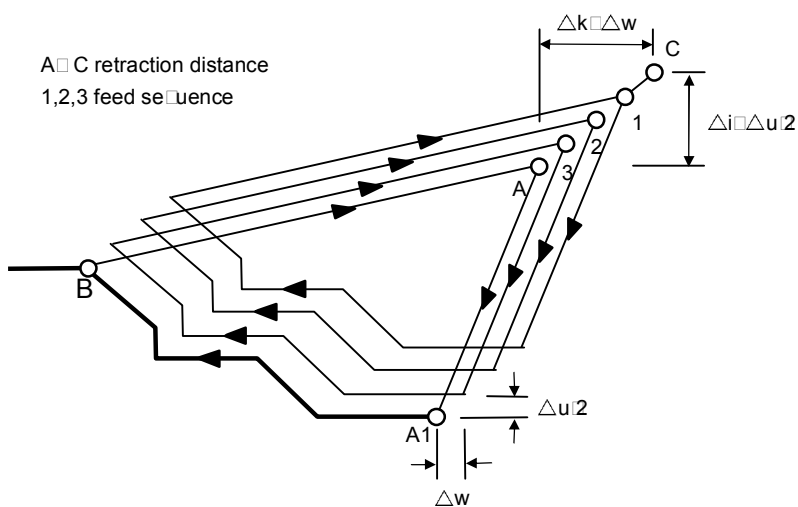

Fig. 3-39 Cutting Path of G73 Compound Canned Cycle

Details:

- (1) N(ns)□N(nf) define the machining path of A←A1←B.
- (2) A maximum of 50 blocks can be inserted from N(ns) to N(nf).
- (3) No subprogram is available from N(ns) to N(nf).
- (4) The tool returns to A when the cycle finishes.
- (5) The cutting amount U(Δi), W(Δk) and the cutting cycles R(d) are modal codes. They remain valid until another value is defined.

Example: G70, G73 compound canned cycles

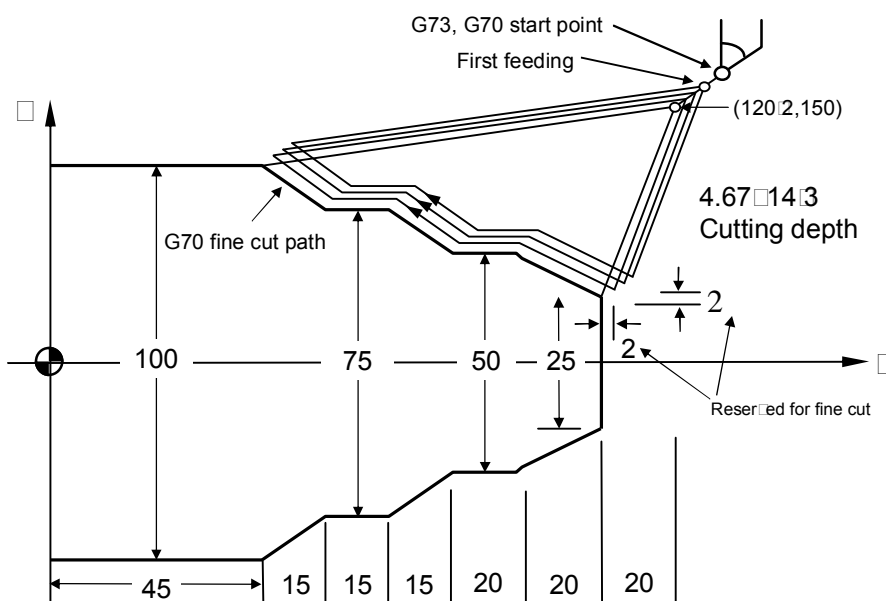

Fig. 3-40 Programming example of G70, G73 Compound Canned Cycles

```

G28 W0.
T0202
M3 S3000
G00 □120.000 □150.000
G73 U14.000 W14.000 R3
G73 P100 □200 U4.000 W2.000 F2.00
N100 G00 □25.000 W-20.000
G01 □50.000 W-20.000 F1.5
W-20.000
□75.000 W-15.000
W-15.000
N200 G01 □100.000 W-15.000
G00 □130.
    
```

□160.
 T0303
 G00 □120.
 □150.
 G70 P100 □200
 M5 S0
 M30

5. Face Cut-Off Cycle, G74

Functions and Purposes:

G74 command automatically performs a fixed loop at the end of the workpiece via commands such as coordinate of groove end, cutting depth, tool retract depth etc.

Format□

G74 R(e)□□□

G74 □(U)□□□ □(W)□□□ P△i□□□ □△k□□□ R△d□□□ F□□□

R(e) : Amount the tool move backward when after □ cutting △k

□ : Absolute positioning command on □-axis

□ : Absolute positioning command on □-axis

U : Incremental positioning command on □-axis

W : Incremental coordinates on □-axis

P△i : Amount the each movement of □ canned cycle.

□△k : □ cutting of the each segment

R△d : Amount the tool move backward when □ end of cutting

F : Cutting speed feed-rate

- (1) Input of a □ or W parameter is a must
- (2) IF R (e) tool extraction parameter is not given, tool extraction depth shall be set using the setting of parameter G74 or G75.
- (3) Total cutting distance must be greater than respective cutting distances.

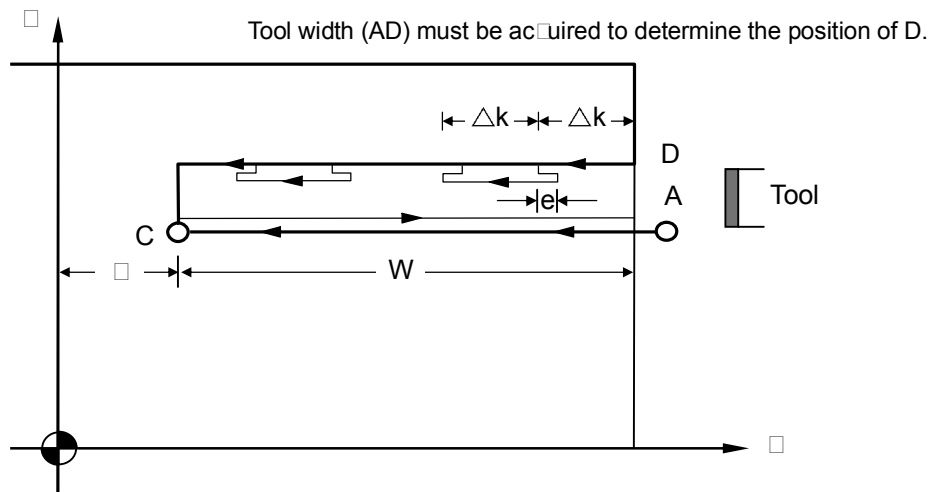

Fig 3-41 Cutting Path of G74 Lateral Grooving Canned Cycle

Axial drilling can be performed when the X axis is at X0 position.

Example 1 : (without tool feed in the X direction)

G0 X0. Z80. ⇒ Move tool quickly to the position X0. Z80. is relative to the work origin.

M03 S2000 ⇒ Positive rotation of spindle, speed 2000(rpm).

G74 R3. ⇒ R3. stands for a tool retraction of 3000(μm) after each drilling depth of 10000(μm).

G74 X30.Z10.R3.F0.2 ⇒ Drilling canned cycle X30.Z10 indicates that the drilling cycle ends at the absolute coordinate X30. Z10 indicates 10,000 (μm) per drilling. R3 indicates 3000 (μm) per retraction.

M05 S0 ⇒ Spindle stops.

M02 ⇒ Program ends.

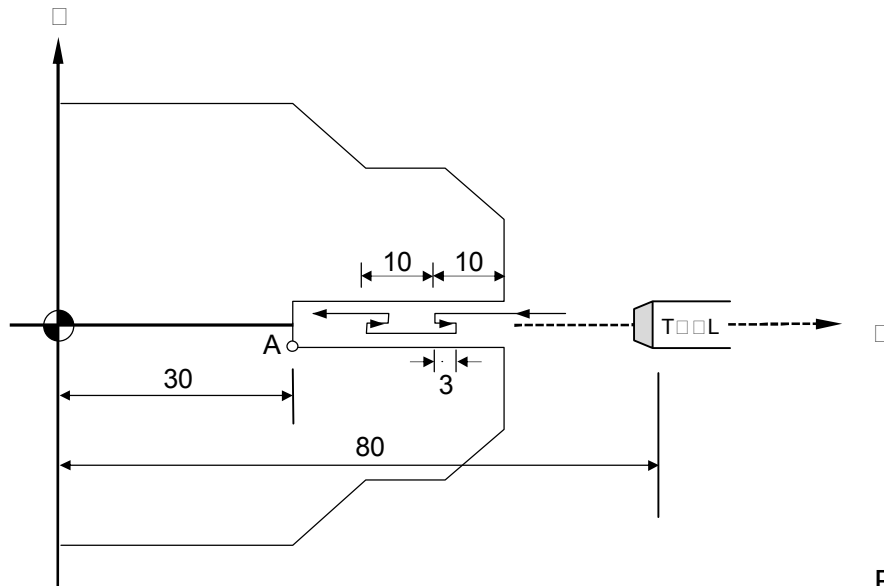

Fig. 3-42

Example 2 : (with tool feed in the \square direction)

G0 \square 0. \square 80. \Rightarrow Move tool quickly to the position \square 0. \square 80. is relative to the work origin.

M03 S2000 \Rightarrow Position rotation of spindle, speed 2000(rpm).

G74 R3. \Rightarrow R3. stands for a tool retraction of 3000(μ m) after each drilling depth of 10000(μ m)

G74 \square 2. \square 30. P400 \square 10000 R1. F0.5 \Rightarrow

Grooving canned cycle \square \square 30. \square Indicates the drilling cycle ends at absolute coordinate 30. in the \square -direction \square \square 2. \square

Indicates the end coordinates of cycling movements in the \square -direction are \square 2. \square P400 \square indicates a 200 (μ m) movement per cycle in the \square -direction \square \square 10000 indicates 10000(μ m) per drilling \square R1. \square Indicates tool retraction of 500(μ m) in the \square -direction when the cutting reaches end position.

(Diameter specification)

M05 S \square \Rightarrow Spindle stops.

M02 \Rightarrow Program ends.

M05 S \square \Rightarrow Spindle stops.

M02 \Rightarrow Program ends.

6. Longitudinal Cut-Off Cycle, G75

Functions and Purposes:

The G75 function is the same as G74 except that the positioning direction of G75 is on the \square -axis.

Format:

G75 R(e)□□□

G75 □(U)□□□ □(W)□□□P△i□□□ □△k□□□ R△d □□□F

Parameters:

R(e) : Amount the tool move backward when after □ cutting △l. (Diameter specification)

□ : Absolute positioning command on □-axis

□ : Absolute positioning command on □-axis

U : Incremental positioning command on □-axis

W : Incremental coordinates on □-axis

P△i : Amount the each movement of □ canned cycle. (Diameter specification)

□△k : □ cutting of the each segment (Integer μm specification)

R△d : Amount the tool move backward when □ end of cutting (Integer μm specification)

F : Cutting speed feed-rate

Details:

1. Input of a □ or W parameter is a must
2. IF R (e) tool extraction parameter is not given, tool extraction depth shall be set using the setting of parameter G74 or G75.
3. Total cutting distance must be greater than respective cutting distances.

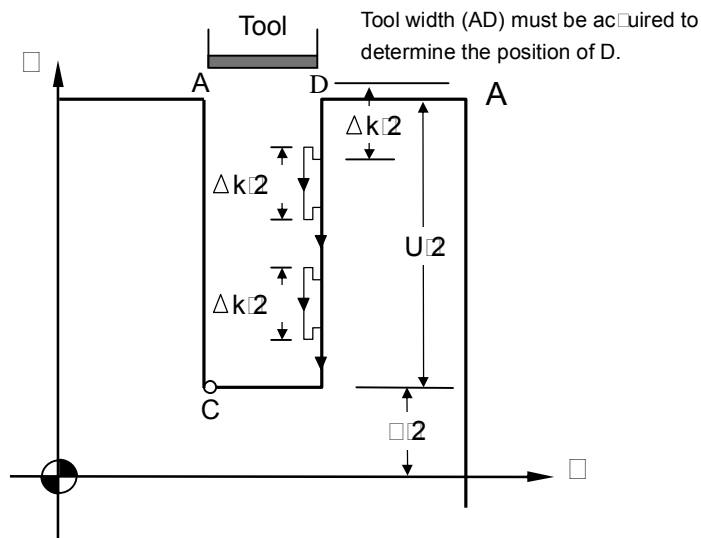

Fig. 3-43 Cutting Path of G75 Transverse Grooving Canned Cycle

Example 1 : (without tool feed in the X direction)

N10 G0 X80.0 Z0.	⇒ Moves tool quickly to the home position of workpiece X80. Z0.
N20 M03 S2000	⇒ Spindle CW, speed 2000(rpm).
N30 G75 R1.	⇒ R1. indicates a 500(μm) tool retraction after each drilling depth of 2500(μm).
N40 G75 X60. P5. F0.5	⇒ Drilling cycle X60. indicates end of drilling cycle is at absolute coordinate 60. in the X-direction. P5. stands for 2500 (μm) per drilling. (Diameter specification)
N50 M5 S0	⇒ Spindle stops.
N60 M2	⇒ End of program.

Example 2 : (with tool feed in X direction)

N10 G0 X80.0 Z0.	⇒ Quickly move tool to X80. Z0 position relative to the work origin
N20 M03 S2000	⇒ Position rotation of spindle, speed 2000(rpm).
N30 G75 R2.	⇒ R2. stands for a tool retraction of 1000(μm) after each drilling depth of 2500 (μm).
N40 G75 X60. Q3. P5. Q500 R1. F0.5	⇒ Groove cutting cycle X60. indicating drilling cycle ends at the absolute coordinate X60. Q3. Indicates that the cycle ends at coordinate Q3. P5. stands for a drilling depth of 2500 (μm) for each drilling cycle. Q0.5 stands for X-direction movement per cycle is 500 (μm). R1. indicates tool retraction of 1000 (μm) in X-direction after reaching the end position. (diameter specification)
N50 M5 S0	⇒ Spindle stop.
N60 M2	⇒ end of program.

7. Compound Thread Cutting Canned Cycle, G76**Functions and Purposes:**

G76 specifies the start point and end point of a thread cutting. This command can be entered at any angle. A fixed number of loops are cut for every cycle with the same cross-section. Thread end point coordinate and specification of slanting height are considered. It is also capable of performing thread cutting in various directions.

Format:

```
G76 P(m)(r)(a) (Δd min) R(d)
G76 (U) (W) R(i) P(k) (Δd) F(l) E
```

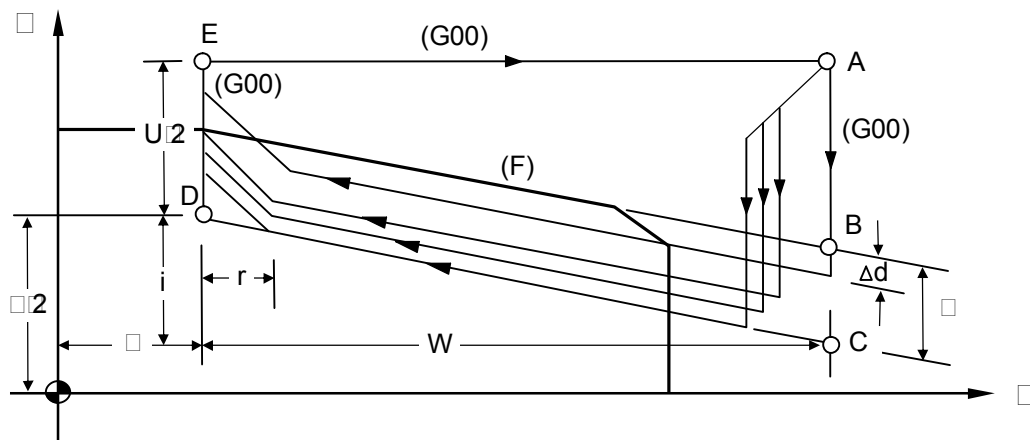

Fig. 3-44 G76 Compound Thread Cutting Canned Cycle

Parameters:

- m Fine cut times (2-digit, 01-99)
If not defined, **parameter "G76 Fine Cut Times"** is used.
- r Chamfering settings (2 digits)
Length of chamfering = 0.1 × chamfering settings (r) × thread pitch.
If not defined, the **parameter "Chamfering Settings"** is used.
- a Tool-tip angle (0-90°).
The available angles are 0°, 5°, 10°, 15°, ... to 90°. If not defined, the **parameter "Tool-tip Angle"** is used.

m, r, and a are defined simultaneously by the command code P.
For m=2, r=12, a=60°, then the command is G76 P021260.

- (Δd min) Minimum cutting amount (integer μm)
When the cutting amount of the nth cutting ($\Delta d\sqrt{n} - \Delta d\sqrt{n-1}$)
= Δd min, the cutting will resume with Δd min as the minimum

cutting amount. If no minimum cutting amount is defined, the **parameter "Minimum Cutting Depth"** is used.

- R(d) □ Amount of material to be removed for the fine cut
If not defined, the **parameter "Reserved Thread Depth"** is used.
- , □ □ Absolute coordinates of cutting end point (D).
- U, W □ Incremental coordinates of the cutting end point (D).
- R(i) □ Radius difference of thread part (i=0 indicates normal linear thread cutting).
- P(k) □ Thread height (radius programming on □-axis, unit=integer μ m)
- (Δ d) □ First cutting depth (radius programming, unit=integer μ m)
- F(l) □ Thread pitch, (same as G32)
- E □ Number of threads per inch □range □1.0-100.0. This setting shall not appear when an F setting is given.

Details: (Fig 3-45 、 Fig 3-46)

- (1) What must be noted is that length of the path DE (U₂) must be greater than the length of the chamfer.
- (2) The fine cut times m, chamfering settings r, tool-tip angle α , minimum cutting amount Δd (Δd min) and reserved thread depth R(d) are modal codes. They remain valid until another value is defined.
- (3) The feed-rate between C and D is defined by F and fast feeding is applied to other paths. The Δd values of the increments in Fig. 3-39 are as follows □

- U, W □ Negative (determined by the directions of AC and CD).
- R □ Negative (determined by the directions of AC).

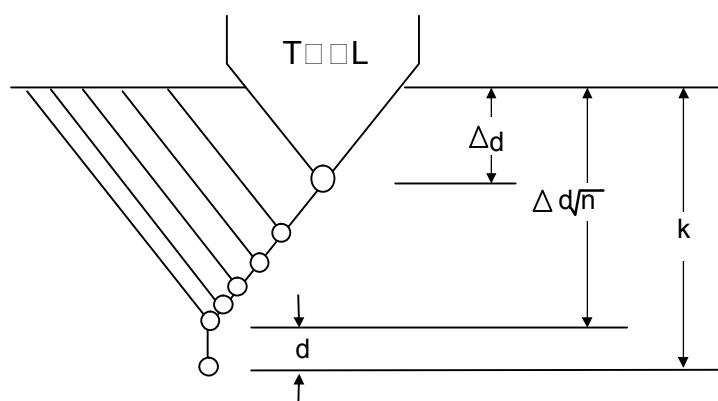

Fig. 3-45 Cutting Description

- (4) The thread height k is acquired from the thread pitch and the tool nose angle. The formula is

Thread height $k = (\text{pitch}/2) \times \tan(\text{angle}/2)$

$\tan(\text{angle}/2)$, acquired from the trigonometric table.

Ex If tool nose angle $\alpha = 60^\circ$, Thread pitch $F(l) = 2 \text{ mm}$.

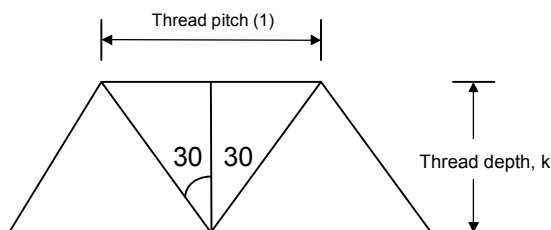

Fig. 3-46

Thread height $k = (2/2) \times \tan(60/2)$

$$= (1) \times \tan 30 = (1) \times 0.5774 = 1.732$$

The first cutting depth (cutting amount) is Δd , the n^{th} cutting depth is $\Delta d \sqrt{n}$, the cutting amount will decrease progressively every time. Note that n should not exceed 30. Otherwise, an alarm will be generated. In this case, please use the normal thread cutting.

Example :

If tool nose angle $\alpha = 60^\circ$, Thread pitch $F(l) = 2 \text{ mm}$.

as shown in the above example, thread height $k = 1.732$

$$= 20 - 2 \times 1.732 = 16.536$$

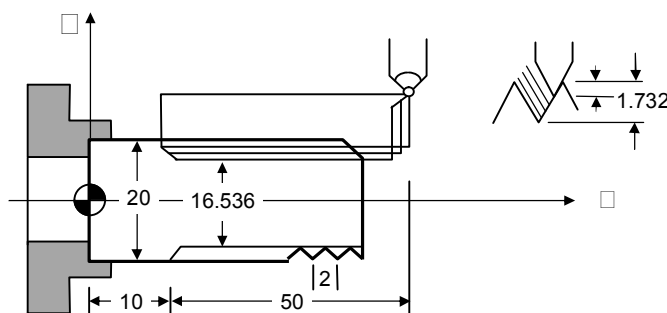

Fig. 3-47 G76 Programming Example

```
N10 G0 X30.0 Z60.0
N20 M03 S2000
N30 G76 P011060 X100 R0.200
```

N40 G76 Q16.536 Q10.000 P1732 Q900 F2.00
 N50 M05
 N60 M02

Notes on thread cutting are identical to G32 and G92. The chamfering settings are also applicable to G92 thread cutting canned cycle.

8. Notes on Compound Canned Cycle (G70~G76):

- Every command of a compound canned cycle must contain correct P, Q, R, U, W and R values.
- In G71, G72, G73 blocks, the block defined by P must contain either G00 or G01. Otherwise, alarm will be generated.
- G70, G71, G72, and G73 are not allowed in MDI mode. Otherwise, an alarm is triggered.
- In G70, G71, G72, or G73, no M98 (call subprograms) and M99 (quit subprograms) are applicable to blocks defined by P and Q.
- When executing G70~G73, the serial numbers defined by P and Q should not be the same.
- In G70, G71, G72, and G73, chamfering and R angle should not be used to terminate the last positioning command used for fine cut shaping blocks defined by P and Q.

3.18 G50 Coordinate system & Spindle clamp speed setting

1. **The setting function for the maximum spindle speed (G50) normally goes with setting function of the constant surface cutting (G96).**

Format

G50 S□□□□

S□Max. spindle speed (rpm or rev/min)

2. **Working coordinate offset function. For continuous process of multiple workpieces, work origin can be set via continuous offset setting of tool start point.**

Format

- (1) G50 U (-direction offset) °
- (2) G50 W (-direction offset) °

Example :

O001 (Main program number)

N10 G10 P500 A1 B0 (direction work coordinate offset clearing)

N20 G10 P500 A3 B0 (direction work coordinate offset clearing)

N30 T01

N40 M98 P02 L5 (Call for 002 subprogram, successively for 5 times)

N50 M99

O002 (number of subprogram)

N1 G50 W10. (10mm offset of tool start point each for every time)

N2 G01 U-10.

N3 G00 U10.

N2 M99

Description:

- (1) Please give G10 P500 A1 B0 and G10 P500 A3 B0at the beginning of program.
- (2) The L suffixof an M98 command indicates number of offsets to be performed. (See description of M98 command).

3.19 Constant Surface Speed Control ON, G96

Format

G96 S

S Surface cutting speed (m/min)

The surface cutting speed refers to the relative velocity between the tool-tip and cutting point (on the surface) of the rotating work-piece. A tool has its advised surface cutting speed range for optimizing the cutting result. G96 is used to

control the surface cutting speed. The relationship between the surface cutting speed, work-piece diameter and spindle rotation speed is expressed by

$$V = \pi DN$$

- V The surface cutting speed is the S value of G96.
- D Diameter of the surface is cut, m.
- N Spindle rotation speed, rev/min.

When the surface cutting speed is constant and the tool cuts the surface inwards, D will become lesser and N will become greater. Hence the max. rotation speed must be limited using G50 S. Once this limit is reached, the speed will not increase any more.

Ex N10 G50 S2000 . . . Max. rotation speed of the spindle is 2000 rpm.
 N20 G96 S200 . . . The constant surface cutting speed is 200 m/min.

3.20 Constant Surface Speed Control OFF, G97

Format

G97 S

This function maintains the spindle speed defined by S. It cancels the constant surface cutting speed at the same time.

3.21 Feed-rate Setting, G98, G99

- G98 Feed per minute, mm/min
- G99 Feed per revolution, mm/rev

The feed-rate F in H4D-T turner series is defined by G98 and G99. G99 is the default value. The conversion formula is

$$F_m = F_r * S$$

- F_m Feed per minute, mm/min.
- F_r Feed per revolution, mm/rev

S Spindle speed, re/min.

3.22 Inch/Metric Measurement Mode , G20, G21

Format:

G20 -- System measurement in INCH mode
 G21 -- System measurement in METRIC mode

3.23 Deep Hole Drilling Cycle (Z axis) G83,G80

Format:

G83 (W) R F Deep hole drilling cycle
 G80 Fixed cycle for drilling cancel

Parameters:

- (W) : Point the hole position with absolute or increment
- : Each depth of drilling (Unit μm , 10000=10mm)
 ※ If with no values that drilling motion will finish one time.
- R : Point of reference with go forward or move backward
 ※ Absolute position
 ※ If R with no values that it will according to now coordinates be R values.
- F : Drilling speed feed-rate (mm/re)

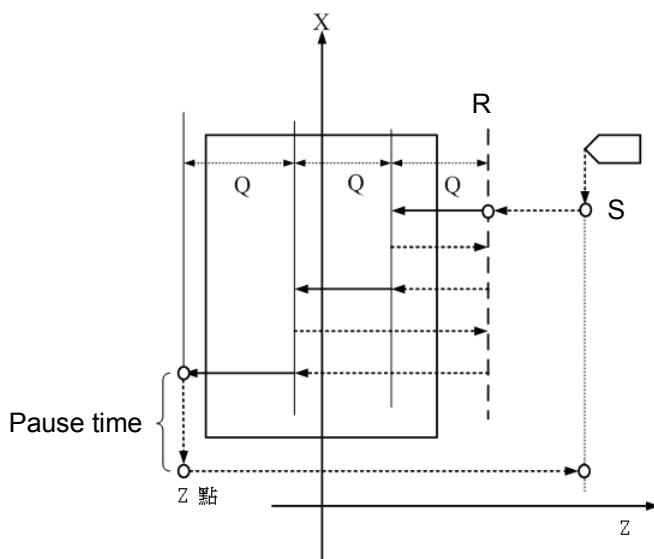

Fig 3-48

3.24 Tapping Cycle G84,G80

G80 : Fixed cycle for drilling cancel

G84 : Tapping cycle

Format:

G84 $\square(U)$ $\square(W)$ $\square\square\square\square$ $\square\square\square\square$ R $\square\square\square$ F $\square\square\square$ D $\square\square\square$

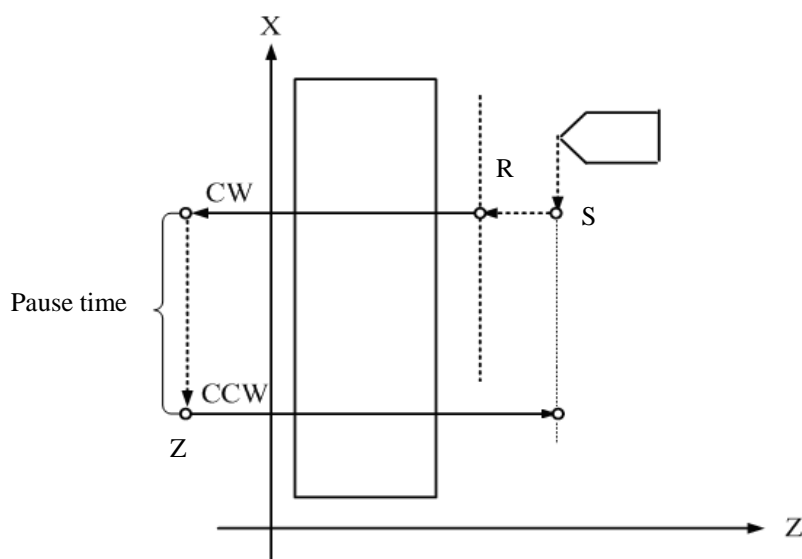

Fig 3-49 G84 Threading

1. Parameters:

$\square(W)$: Point the hole position with absolute or increment (**Z-direction**)

R : Point of reference with go forward or move backward

※ Absolute position

※ If R with no \square values that it will according to now \square coordinates be R \square values.

\square : Each depth of tap cutting (Unit μm , $\square 10000 \square 10\text{mm}$)

※ If \square with no \square values that tapping motion will finish one time.

F : Set the spacing thread pitch of the tapping tools (F1.0 \square 1mm)

D : First spindle end face threading if D parameter is not specified.

2. G84 X(U) __ Q__ R__ F__ D1

(1) $\square(U)$: Position of hole bottom is specified by an absolute or

incremental value (direction)

- (2) D01 : Threading of second spindle lateral face
- (3) Other parameters are the same as above

3. G84 Z(W) __ Q__ R__ F__ D2

- (1) (W) : Position of hole bottom is specified by an absolute or incremental value (direction)
- (2) D02 : Threading of third spindle end face
- (3) Other parameters are the same as above

G84 and G80 are used in pairs. If G80 is missing, program will report an Err18.

G84 Z-axis application example:

```

N10 M70 ( third spindle switched as servo-spindle mode )
N20 T1
N30 G0 -20.C0.
N40 #3.
N50 G84 -20.F1.R2.D2
N60 C60.
N70 C120.
N80 G80
N90 M71 ( third spindle switched back to main spindle mode )
N100G0 #20.
N110 M2
    
```

G84 X-axis application example:

```

N10 M60 ( Second spindle switched as servo-spindle mode )
N20 T1
N30 G0#5.C0.
N40 #3.
N50 G84U-10.F1.R4.D1
N60 C60.
N70 C120.
N80 G80
N90 M61 ( Second spindle switched back to spindle mode )
N100 M02
    
```

3.25 Auxiliary Functions, M-code, S-code

The auxiliary function M-code is comprised of the letter M and 2 digits attached behind (M-codes for general), different codes represents different functions as shown below□

Currently, H4D-T Series provides the following M-codes□

Table 3-10

M-CODE	Function
M00	Program Suspension.
M01	Selective stop
M02	Program End.
M03	Spindle rotates in normal direction
M04	Spindle rotates in reversed direction
M05	Spindle stops
M08	Coolant ON.
M09	Coolant OFF.
M10	Spindle chuck tightened
M11	Spindle chuck loosened
M12	Tailstock forward
M13	Tailstock backward
M15	Count plus 1
M16	Count clear (to zero)
M30	Program end
M33	Workpiece Collector Protrude
M34	Workpiece Collector Extract
M35	Tailstock Chuck Clamp
M36	Tailstock Chuck Release
M40	Chip Remove CW
M41	Chip Remove CCW
M42	Chip Remove Stop
M43	Feeder Start
M45	Select Skip Start
M46	Select Skip Close
M47	The Spindle should rotate after releasing the Chuck
M48	When releasing the Chuck, prohibit the spindle rotation.
M50	Set Spindle 1 to Servo Axis Mode.

M-CODE	Function
M51	Set Spindle 1 back to Spindle Mode.
M55	Start in-process Tool offset change instant a fail.
M60	Set Spindle 2 to Servo Axis Mode.
M61	Set Spindle 2 back to Spindle Mode.
M63	Spindle 2 CW
M64	Spindle 2 CCW
M65	Spindle 2 Stop
M70	Set Spindle 3 to Servo Axis Mode.
M71	Set Spindle 3 back to Spindle Mode.
M73	Spindle 3 CW
M74	Spindle 3 CCW
M75	Spindle 3 Stop
M80	Enable axial direction without homing
M81	Disable axial direction without homing
M84	Spindle brake hold
M85	Spindle brake release
M98	Call subprogram
M99	Program cycle
M30	Program end
M300	Enable round-angle connection between blocks
M301	Disable round-angle connection between blocks
M362	Switch to Spindle 1
M364	Switch to Spindle 2
M365	Switch to Spindle 3

Using CW, CCW of spindle

1. M03 First spindle clockwise (CW)

Format

(1) M03 S

E.g. M03 S1000 ; Command first spindle to rotate CW at 1000rpm.

(2) M03

If M03 is not followed by an S-code, spindle rpm is not specified spindle will rotate CW at the previous speed.

2. M04 First spindle CCW

Format

(1) M04 S

- E.g. M04 S1000 ; Command first spindle to rotate CCW at 1000rpm
- (2) M04
If M04 is not followed by an S-code, spindle rpm is not specified
spindle will rotate CCW at the previous speed.

The auxiliary function code S-code is for spindle rpm control, maximum setting range S999999.

E.g. S1000, means 1000 rpm

3.26 Subprogram

Where there are certain fixed programs or command groups in a main program that demand repeated execution, these commands could be saved in memory as subprograms, so that the main program could be designed with a simplified structure. Subprograms can be called out one after another in auto mode.

1. Structure of the Subprogram

The structure of the subprogram is the same as the main program except that the subprogram ends with an M99 command.

```

PROGRAM 05  . . . . . Subprogram number
              . . . . . Content
              . . . . . Content
M99          . . . . . Subprogram ends
  
```

If a subprogram is not called by the main program but executed directly by pressing [C]CST, the program loops.

2. Execution of the Subprogram

Format

```
M98 P ##### L #####
```

P Subprogram number

L Execution times of the subprogram. If not defined, the

subprogram is to be executed only once.

- Ex□ M98 P05 Execute subprogram No 5 once.
- M98 P05 L3 Execute subprogram No 5 three times.

Stepwise Call□ the main program calls the first subprogram, and the first subprogram calls a second sub-prgrams. The H4D-T Series controller provides a maximum of 8 le□els stepwise calls□ (take for an example of 5 layers)

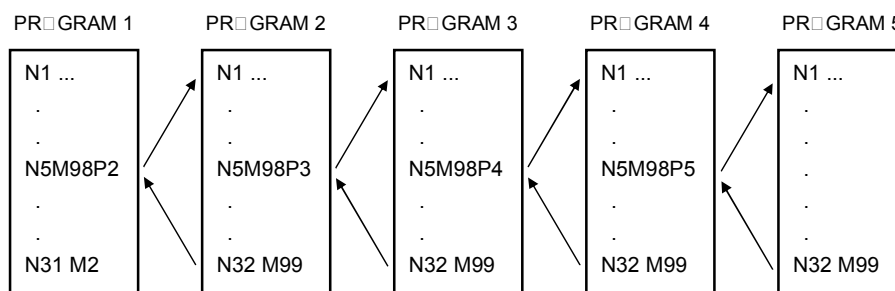

Fig. 3-50 Subprogram Stepwise Call

The M98 and M99 blocks should not contain any positioning commands, such as □□ , □□ .

3.27 Tool Radius Compensation

3.27.1 Total Offset Compensation Setting and Cancellation

Total offset compensation □ Length compensation □ Wear compensation

Format□

Table 3-11

	Compensation Set	Compensation Cancel
Without Turret	T□□	T00
With Turret	T○○□□	T○○00

- Compensation number, indicating which set of compensation data is to be applied.
- Tool number, indicating which tool is to be selected.

When a compensation number is selected, the control unit will simultaneously select the X-axis and Z-axis compensation values for tool length and wear compensation. These values are summed up for compensation of the tool path.

Any small differences between the cut work-piece and specifications found during the cutting test after the tool is calibrated, can be remedied by wear compensation (referring to the Tool Wear Compensation page). If the difference is very small, positive values should be used. If the difference is large, negative values should be used.

Ex: N10 G01 X50.000 Z100.000 T0202

N20 X200.000

N30 X100.000 Z250.000 T0200

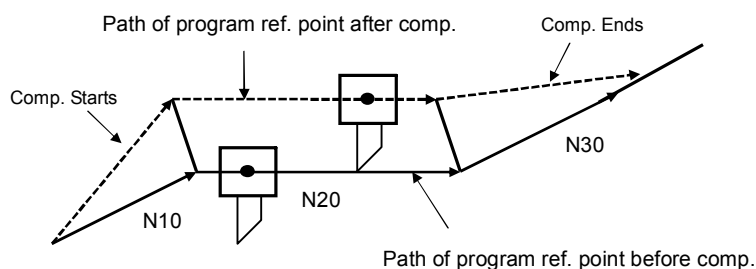

Fig. 3-51 Example of Tool Length Compensation

In this example, T0202(T02) indicates that the second tool and the second set of compensation data are selected. T0200 (or T200) indicates that the tool length compensation is cancelled.

Value of compensation

1. Value of compensation is normally set by the last digit or the last 2 digits of a T-code. Once a T-code is specified, it remains effective until a subsequent specification is made. In addition to tool-tip compensation, a T-code can also be used for specifying tool-length compensation.
2. A change of compensation setting is usually made in compensation-disabled mode when selecting another tool. In the event a change is made during a compensation mode, the end vector of the program will be calculated according to the specified compensation value.

Notes:

1. After powering the CNC, compensation is automatically cancelled and the compensation number is reset to 0 or 00.
2. Compensation must be cancelled to execute "Auto-Compensation".
3. The length compensation command "T-code" can form an independent block in the program without positioning definition. CNC executes an internal computation for compensation, but the tool does not execute any positioning movement.

3.27.2 Tool-tip Radius and Direction of Fictitious Tool-tip, G41, G42, G40

Functions and Purposes:

A tool tip is normally in an arc shape, therefore when a program is run, a tool tip is assumed to be the front end of the tool. In this sense, shape of an actual cutting will be different from the programmed cutting due to the arc-shaped tool tip. The Tool-tip Radius compensation is a function designed for automatically calculating an error for compensation by setting a tool-tip radius.

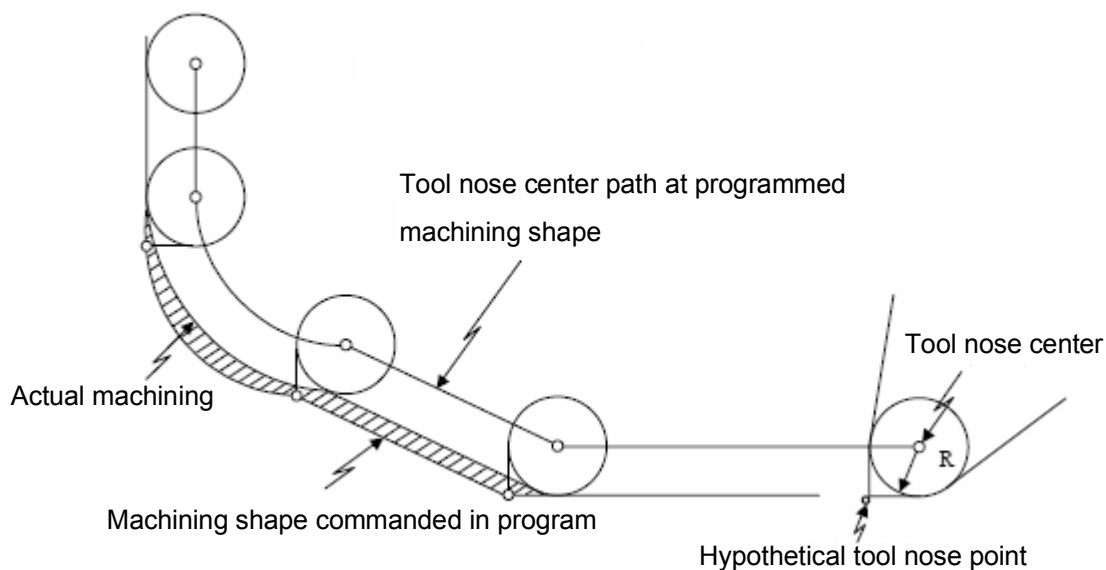

Fig 3-52

Program Format:

- | | |
|--------------------------|-------------------------------------------|
| T□□ or T○□□□ | Call a tool number for compensation |
| G41(G42) □(U)□□□□(W)□□□□ | Set compensation |
| G40 | Cancel compensation |

Before using G41 and G42, inform the NC unit which tool-no. is to be used. The application is totally dependent to the tool path and the relative position of the tool. As shown in Fig. 3-53, looking forward along the tool path, use G42 if the tool tip radius is on the right side of the tool path (radius right side offset compensation) and use G41 if the tool tip radius is on the left side of the tool path (radius left side offset compensation)

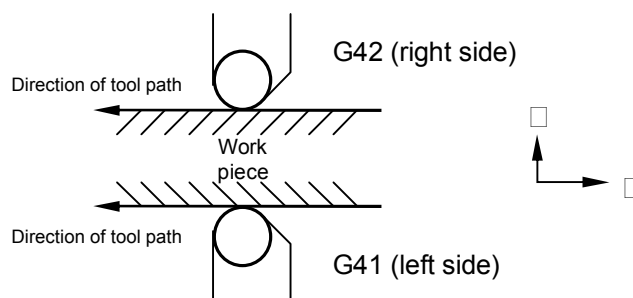

Fig 3-53 Application of G41 and G42

Tool-tip and assumed tool-tip direction

When executing tool-tip radius compensation, the radius and arc must be accurate; otherwise, the cutting result will not be precise. Manufacturers of disposable tools always provide accurate tool-tip radius data. The radius data are to be entered in the "R" field on the Tool Length Compensation page (unit: mm).

Besides the tool-tip radius, the direction of fictitious tool-tips must be acquired (refer to the position of P in Fig. 3-54). The direction is defined by integers 0-9 (Fig. 3-44). In the system with tools on the top (rear) holder, the direction 3 is for outer diameter cutting, while the direction 2 is for inner diameter cutting. The data of fictitious tool-tip direction are to be entered in the "T" field on the Tool Length page.

Once these two data are acquired, the control unit compensates for the tool-tip properly by calculating "R" and "T" values internally after giving the tool-tip radius compensation command.

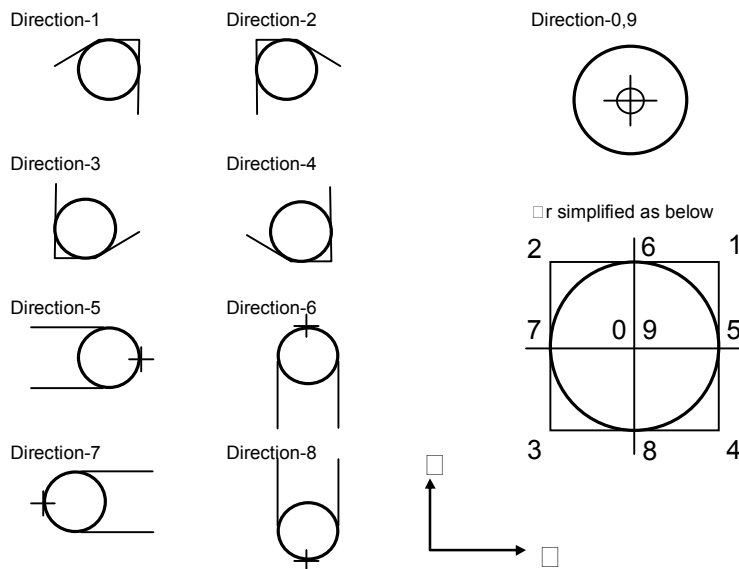

Fig 3-54 Fictitious Tool-tip Direction

Tool-tip point and compensation operation

- (1) Process using center of tool-tip radius as the starting point □

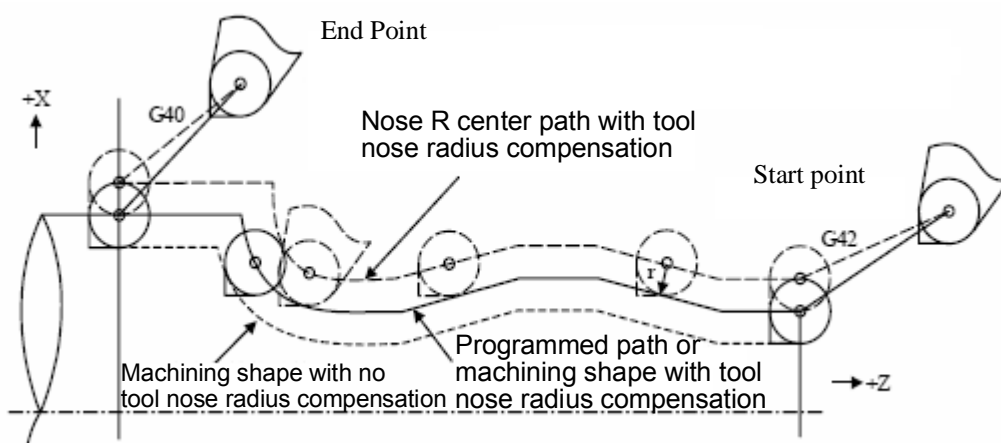

Fig 3-55

(2) Process using tool-tip as the starting point □

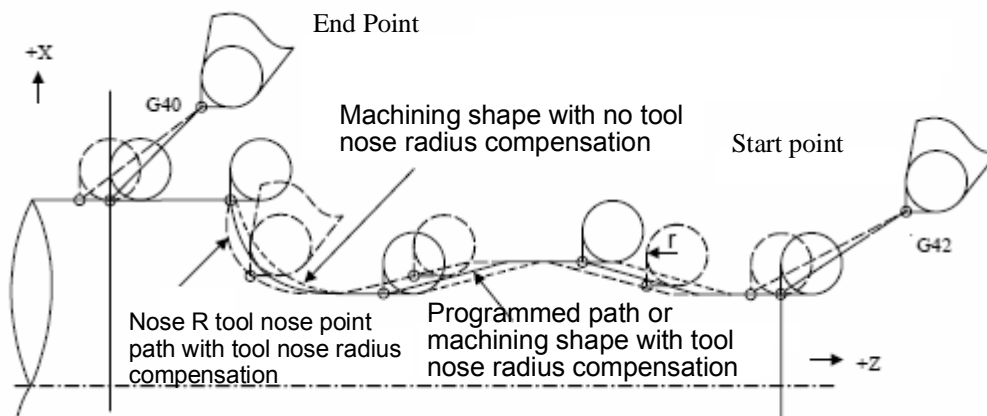

Fig 3-56

Start of tool-tip radius compensation □

When compensation is disabled and all the following conditions are met, tool-tip radius compensation starts □

1. Executing a G41.G42 command.
2. Executing a move command excluding the arc command. When used during a G02, G03 arc-cutting, system will issue an error alarm.

In a continuous or single block execution, when a compensation starts, 2 to 6 program-sections must be read for calculating an intersection point (read 2 program-sections when a move command exists □ read up to 6 program-sections when a move command does not exist).

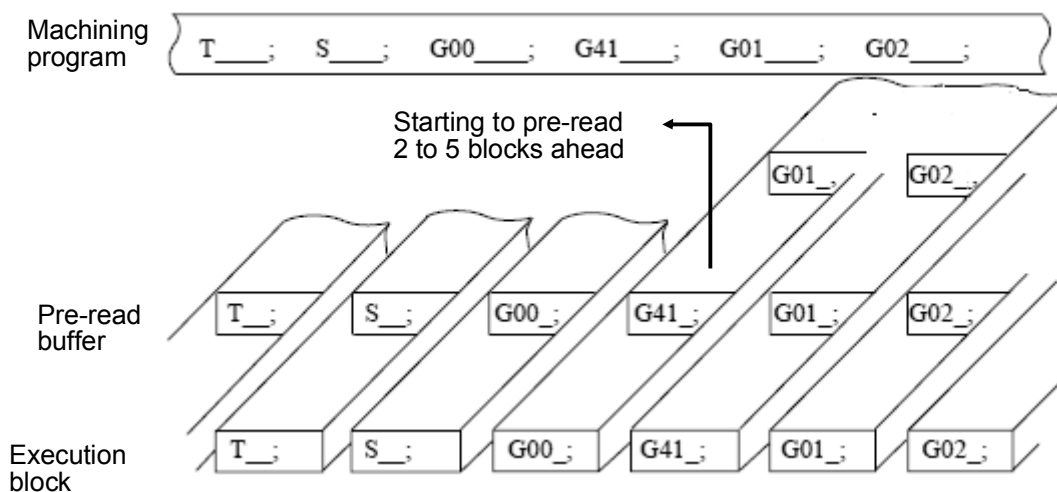

Fig 3-57

Two types of tool-tip compensation can be determined by C251□C251□ 1 for Type A, C251□0 for Type B.

Note: The often seen terms, Inside and □outside, are defined as follows□

Inside: Two movement program-sections having an intersecting angle larger than or equal to 180° .

Outside: Two movement program-sections having an intersecting angle within $0^{\circ} \leq \alpha < 180^{\circ}$.

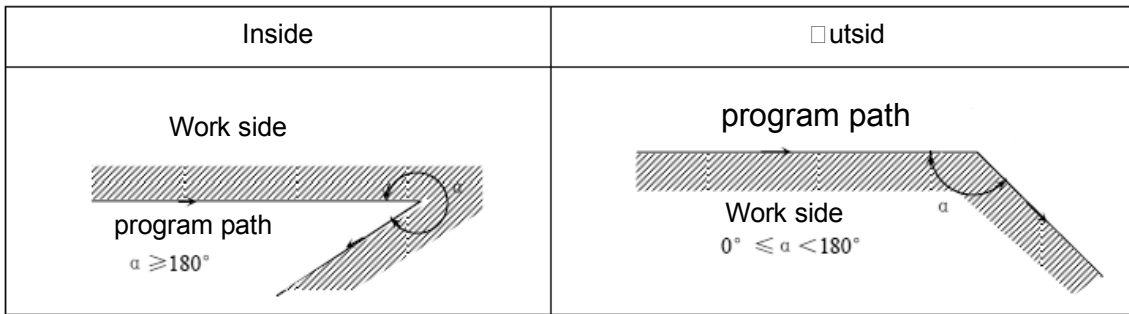

Fig 3-58

Starting of tool-tip radius compensation

With the G41.G42 command alone, the tool will not perform a movement according to tool-tip radius compensation. A tool-tip radius compensation does not start on G00—it only starts on a G01, G02, or G03 command.

When a G41.G42 command exists in the same block with a move command, the move command is processed as a G01 command.

1. In the case of a single command of Chamfer inside G41.G42 (Fig. 3-59)

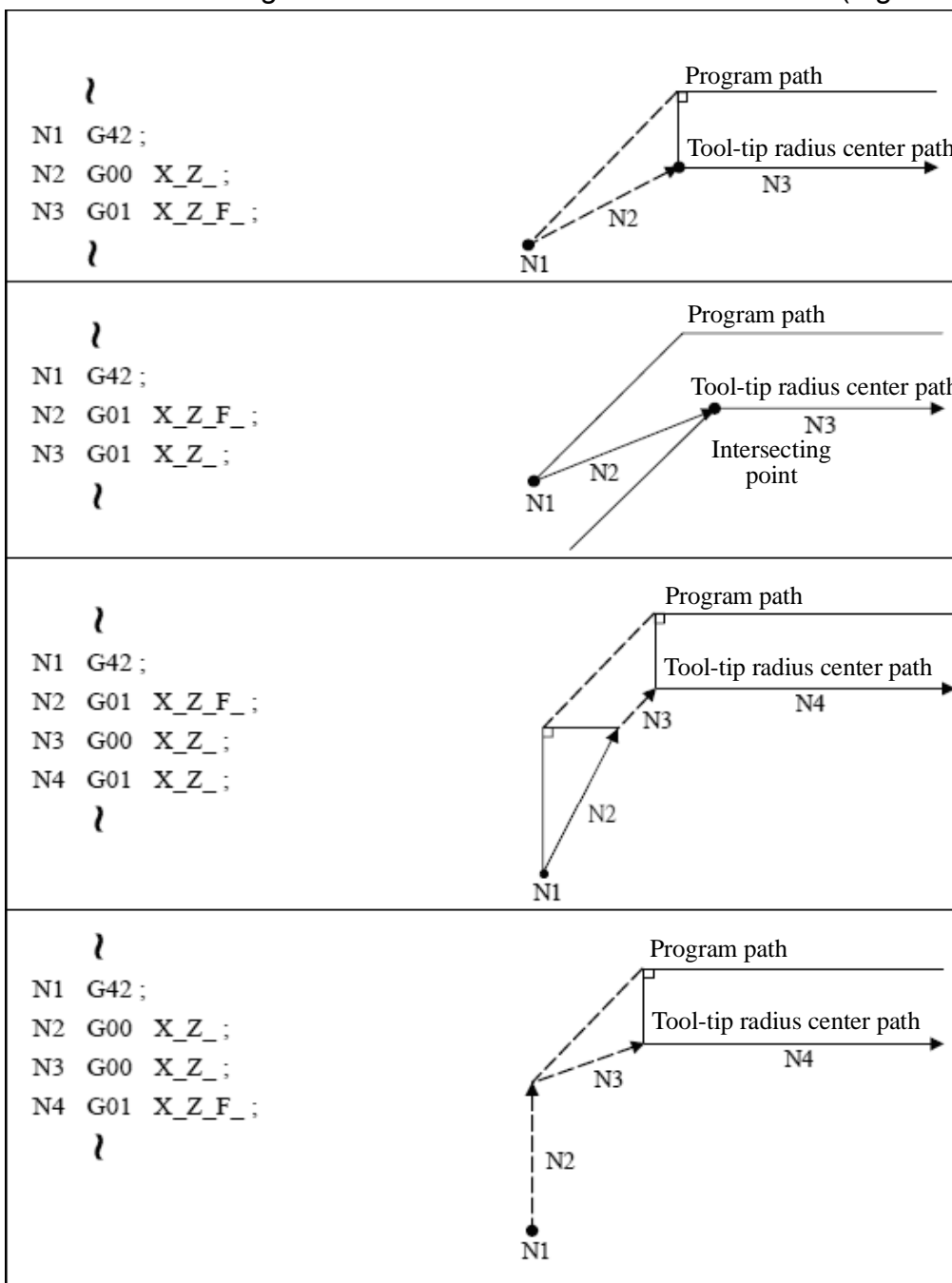

```

□
N1 G42
N2 G00 □□□□
N3 G03 I□□□F□
□
    
```

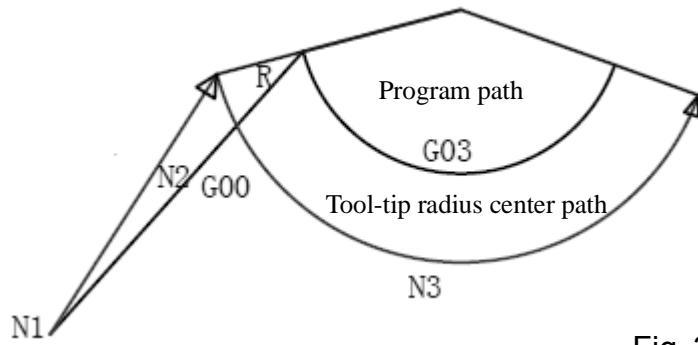

Fig 3-60

```

□
N1 G42
N2 G01 □□□□
N3 G03 I□□□F□
□
    
```

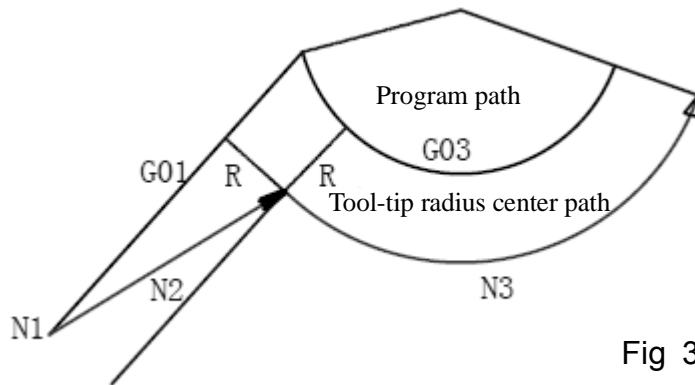

Fig 3-61

- When chamfer inside G41.G42 exists in the same block with a move command

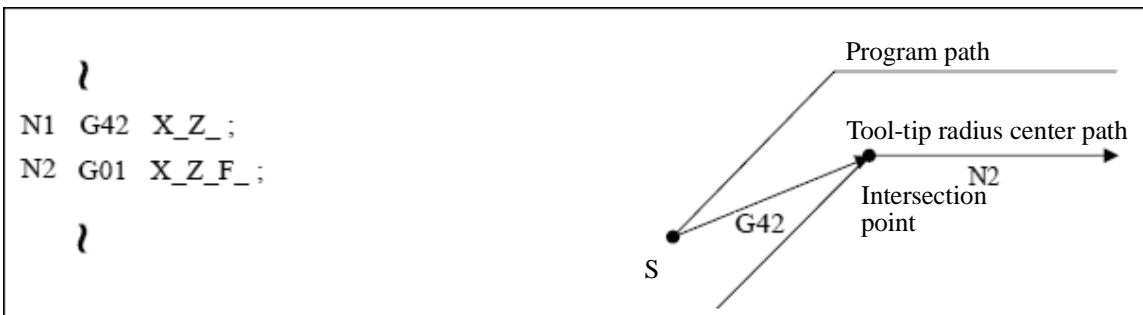
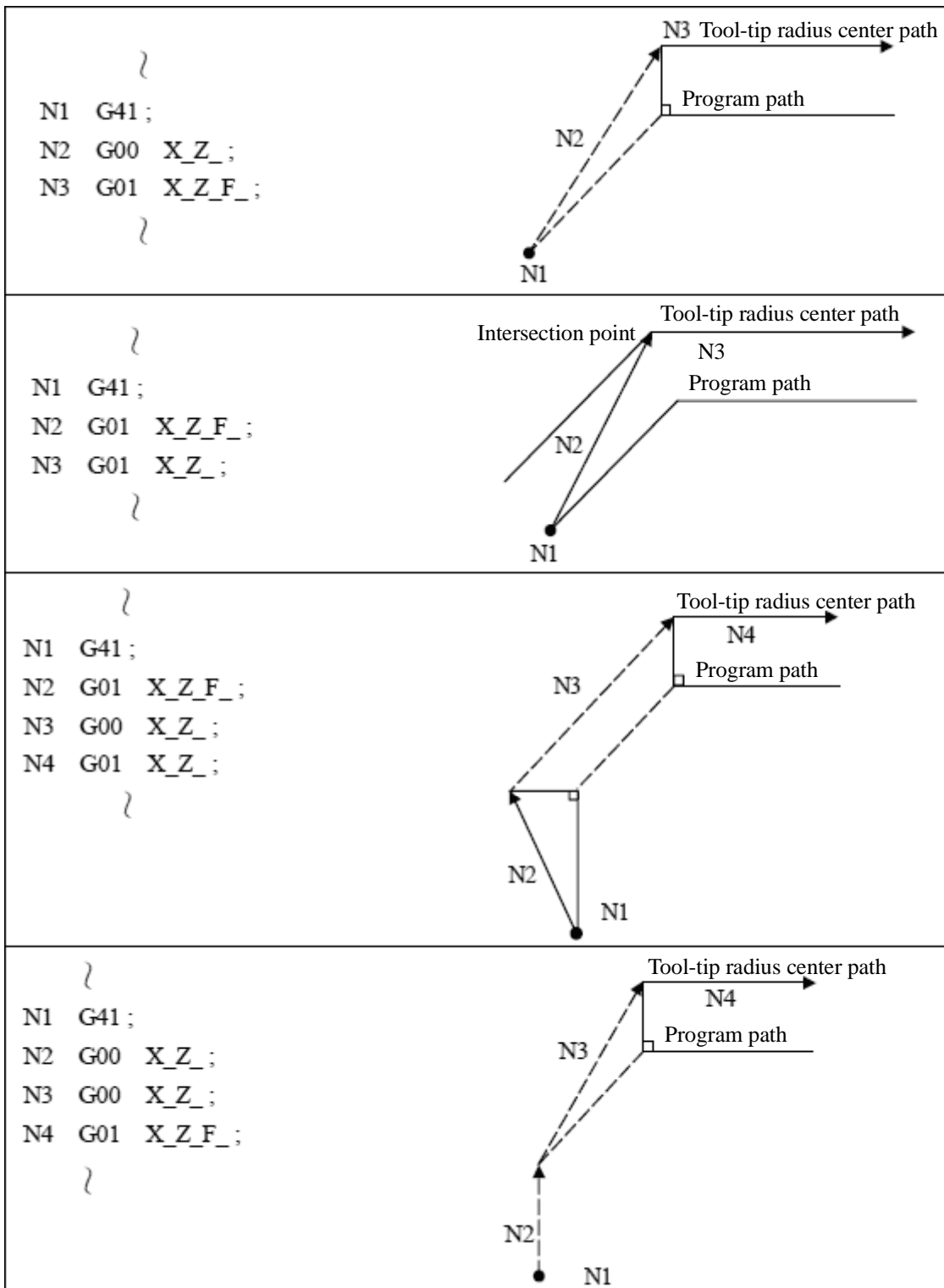

Fig 3-62

3. Chamfer outside (obtuse angle) G41.G42 command only □



4. Chamfer outside (obtuse angle) G41.G42 exists in the same block with a mode command

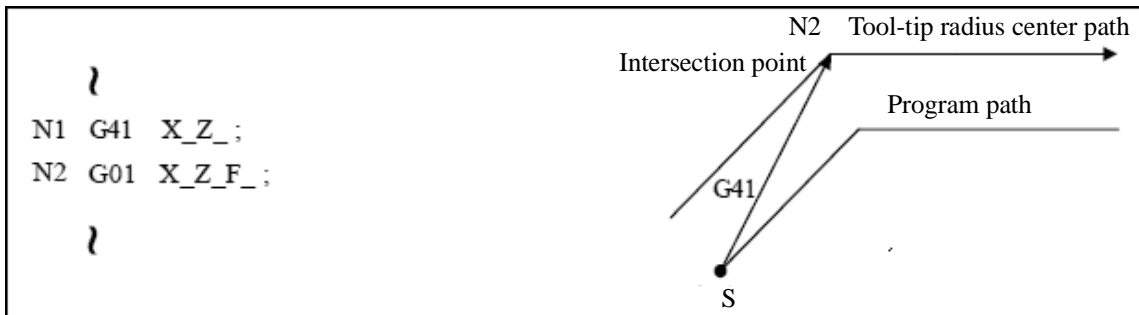

Fig 3-64

5. Chamfer outside (acute angle) G41.G42 command only □

	Type A	Type B
<pre> } N1 G41 ; N2 G00 X_Z_ ; N3 G01 X_Z_F_ ; } </pre>		
<pre> } N1 G41 ; N2 G01 X_Z_F_ ; N3 G01 X_Z_ ; } </pre>		
<pre> } N1 G41 ; N2 G01 X_Z_F_ ; N3 G00 X_Z_ ; N4 G01 X_Z_ ; } </pre>		
<pre> } N1 G41 ; N2 G00 X_Z_ ; N3 G00 X_Z_ ; N4 G01 X_Z_F_ ; } </pre>		

Fig 3-65

6. Chamfer outside (acute angle) G41.G42 exists in the same block with a mode command

	Type A	Type B
<pre> } N1 G41 X_Z_ ; N2 G01 X_Z_F_ ; } </pre>		

Fig 3-66

Operation in a tool-tip compensation mode:

In the tool-tip radius compensation (G41,G42) mode, a tool-tip radius compensation command having the same content is not valid. Pre-reading is prohibited if a G65 L50 command is included in the tool-tip radius compensation.

1. Rotation of chamfer inside□

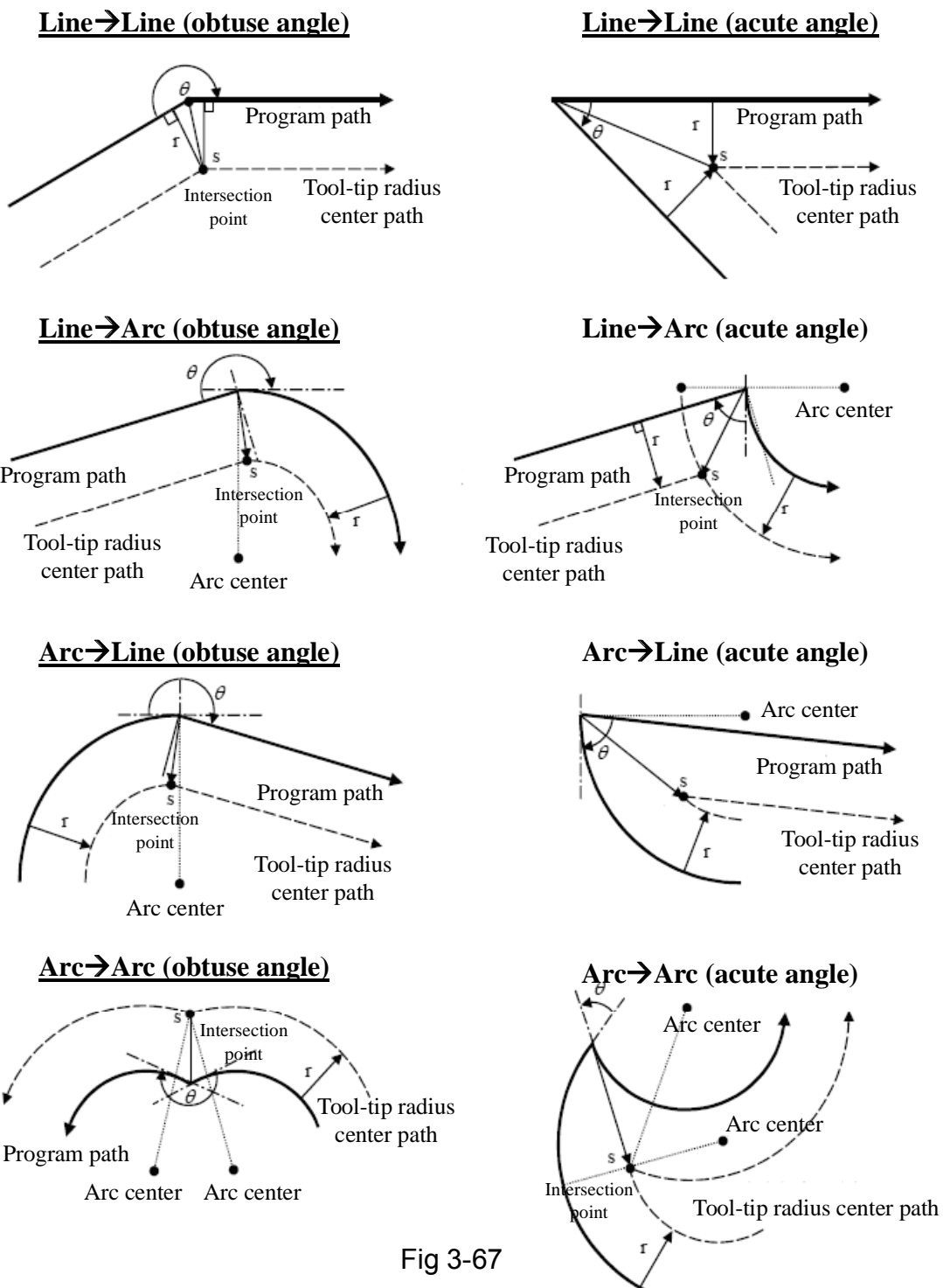

Fig 3-67

2. Rotation of Chamfer outside (Fig. 3-68)

<p>Line→Line $(90^\circ \leq \theta < 180^\circ)$ Type A</p>	<p>Line→Line $(90^\circ \leq \theta < 180^\circ)$ Type B</p>
<p>Line→Line $(0^\circ < \theta < 90^\circ)$ Type A</p>	<p>Line→Line $(0^\circ < \theta < 90^\circ)$ Type B</p>
<p>Line→Arc $(90^\circ \leq \theta < 180^\circ)$ Type A / B</p>	<p>Line→Arc $(0^\circ < \theta < 90^\circ)$ Type A / B</p>
<p>Arc→Line $(90^\circ \leq \theta < 180^\circ)$ Type A / B</p>	<p>Arc→Line $(0^\circ < \theta < 90^\circ)$ Type A / B</p>
<p>Arc→Arc $(90^\circ \leq \theta < 180^\circ)$ Type A / B</p>	<p>Arc→Arc $(0^\circ < \theta < 90^\circ)$ Type A / B</p>

Direction change of tool-tip compensation

Direction of compensation is determined by tool-tip radius compensation command (G41, G42).

During compensation mode, without a cancellation command of the compensation, a change of the compensation command may change the direction of compensation. But the change does not change the starting section of the compensation, nor of the subsequent section of the program.

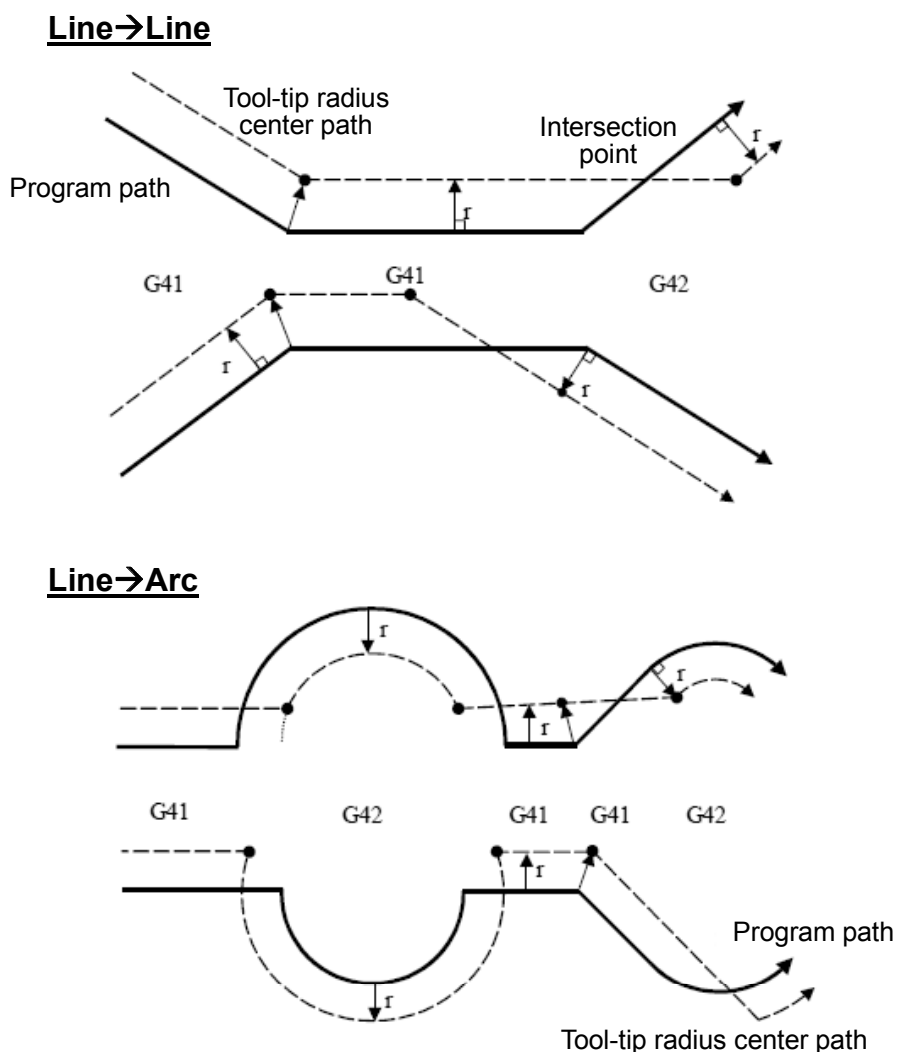

Fig 3-69 Change of compensating direction in a tool-tip radius compensation

Disabling a tool-tip radius compensation

When tool-tip radius compensation is enabled and all the following conditions are met, the tool-tip radius compensation can be disabled

1. A G40 command is executed.
2. Executing a move command excluding the arc command.

After reading-in the disable command of compensation, the program switches into (compensation) disabled mode which comprises the following 3 conditions

1. A tool-tip radius compensation ends, G40 alone disables tool compensation, and a G00 precedes G40, tool compensation is disabled in the block of a G00 move command.
2. A tool-tip radius compensation ends, G40 alone disables tool compensation, and a G01-G02-G03 precedes G40, tool stops at the center of tool-tip radius vertically, tool compensation remains enabled until the first move command after G40. If no move command follows G40, tool compensation remains enabled on the encounter of an end command M02-M30-the compensation is disabled when the program is re-started, without an operation for disabling tool compensation.
3. A tool-tip radius compensation ends, if G40 command is in the same command line with a move command, tool compensation is disabled in the G40 command block.

Disabling tool radius compensation:

1. Chamfer inside G40 command only:

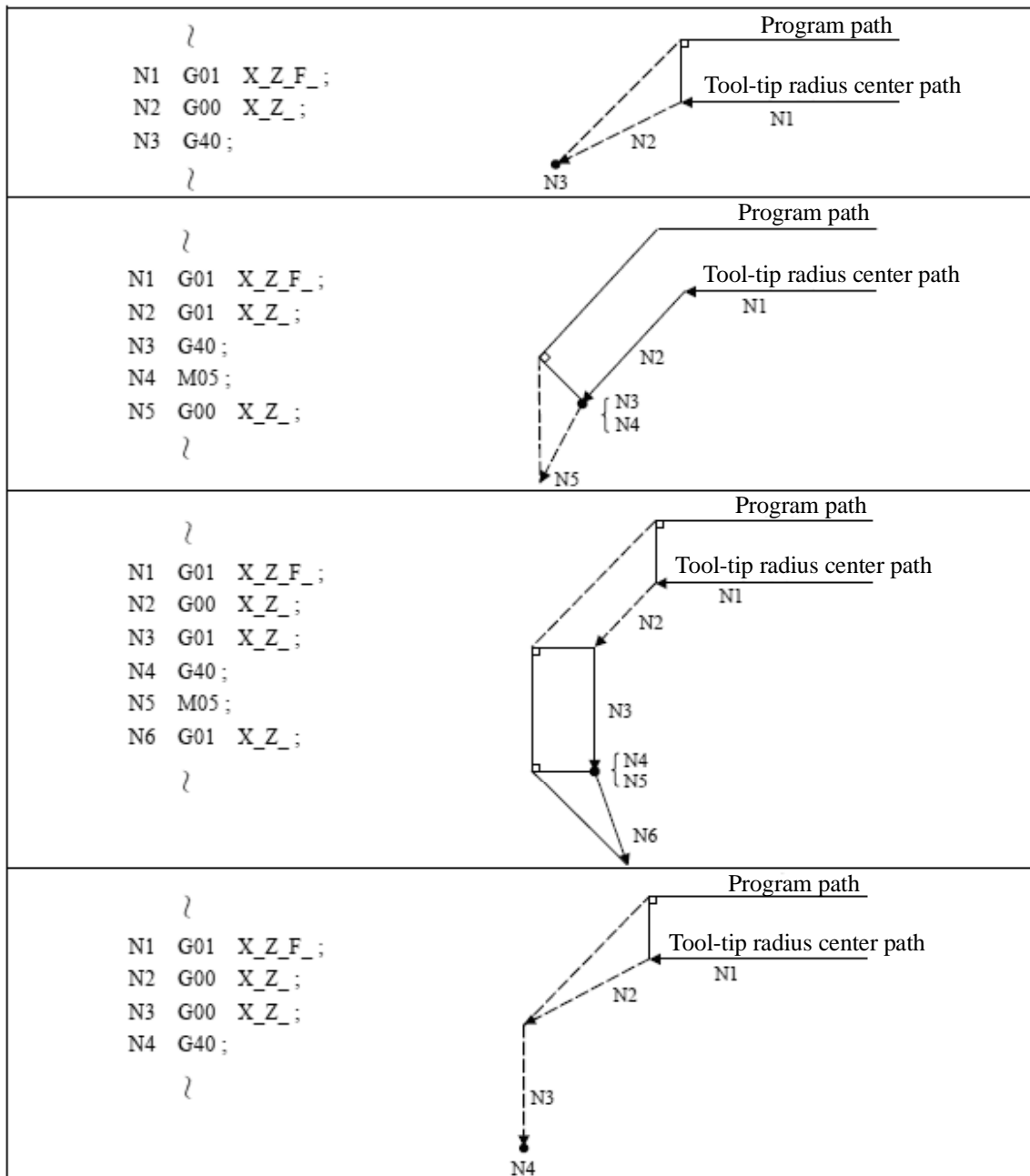

Fig 3-70

2. Chamfer inside G40 is in the same block as a mode command

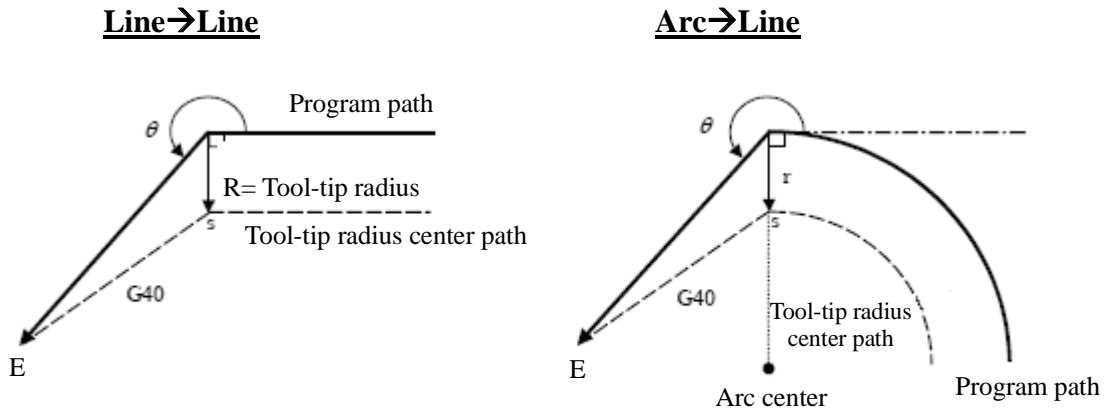

Fig 3-71

3. Chamfer outside (obtuse angle) G40 command only:

	Type A	Type B
<pre> } N1 G01 X_Z_F_; N2 G00 X_Z_; N3 G40; } </pre>		
<pre> } N1 G01 X_Z_F_; N2 G01 X_Z_; N3 G40; N4 M05; N5 G00 X_Z_; } </pre>		
<pre> } N1 G01 X_Z_F_; N2 G00 X_Z_; N3 G01 X_Z_; N4 G40; N5 M05; N6 G01 X_Z_; } </pre>		
<pre> } N1 G01 X_Z_F_; N2 G00 X_Z_; N3 G00 X_Z_; N4 G40; } </pre>		

Fig 3-72

4. Chamfer outside (obtuse angle) G40 and move command in the same block:

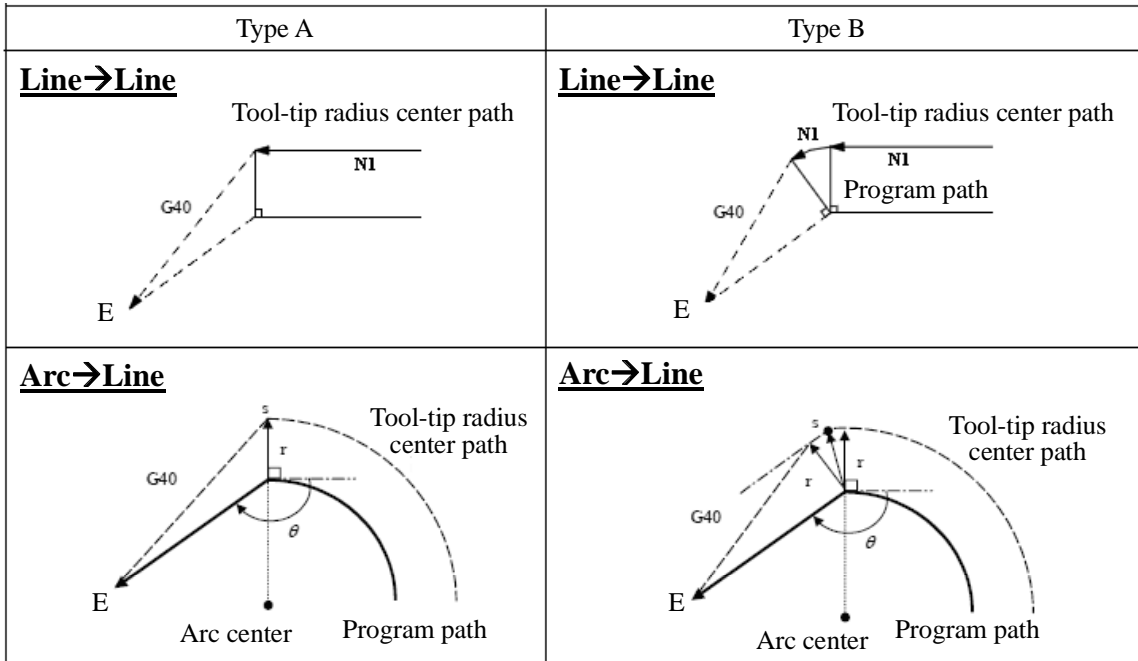

Fig 3-73

5. Chamfer outside (acute angle) G40 command only:

	Type A	Type B
<pre> } N1 G01 X_Z_F_; N2 G00 X_Z_; N3 G40; } </pre>	<p>Tool-tip radius center path</p>	<p>Tool-tip radius center path</p>
<pre> } N1 G01 X_Z_F_; N2 G01 X_Z_; N3 G40; N4 M05; N5 G00 X_Z_; } </pre>	<p>Tool-tip radius center path</p>	<p>Tool-tip radius center path</p>
<pre> } N1 G01 X_Z_F_; N2 G00 X_Z_; N3 G01 X_Z_; N4 G40; N5 M05; N6 G01 X_Z_; } </pre>	<p>Tool-tip radius center path</p>	<p>Tool-tip radius center path</p>
<pre> } N1 G01 X_Z_F_; N2 G00 X_Z_; N3 G00 X_Z_; N4 G40; } </pre>	<p>Tool-tip radius center path</p>	<p>Tool-tip radius center path</p>

Fig 3-74

6. Chamfer outside (acute angle) G40 and mode command in the same block

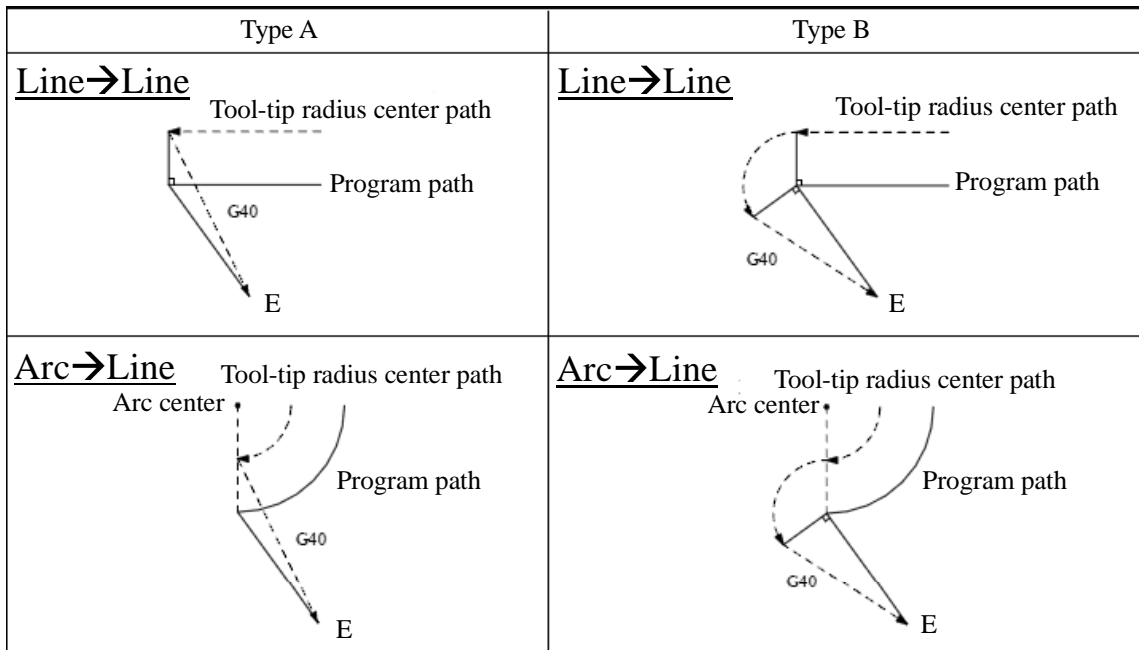

Fig 3-75

3.27.3 Interference Check

Functions and Purposes:

When pre-reading-in 2 program blocks to perform a tool-tip radius compensation, it often results in cutting into the workpiece—this is called an interference.

When cutting a stepwise work-piece with a step value smaller than the tool radius, an over-cutting alarm is generated as shown in Figure 3-51.

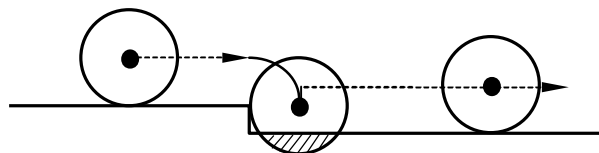

Fig. 3-76 Over-cutting (Shaded Area)

An interference check is a check against such conditions, for taking responding actions according to the parameter.

Interference handling comprises the following 3 functions that can be selected by parameter setting.

Function	Parameter	Action
Interference check alarm	Parameter 20□0	Issues alarm and stop machine before entering block of interference.
Interference avoidance function	Parameter 20□1	Alter the path automatically to avoid interference.
Interference check disable	Parameter 20□2	Cutting action continues, allowing cutting into workpiece.

Details (Ex.)

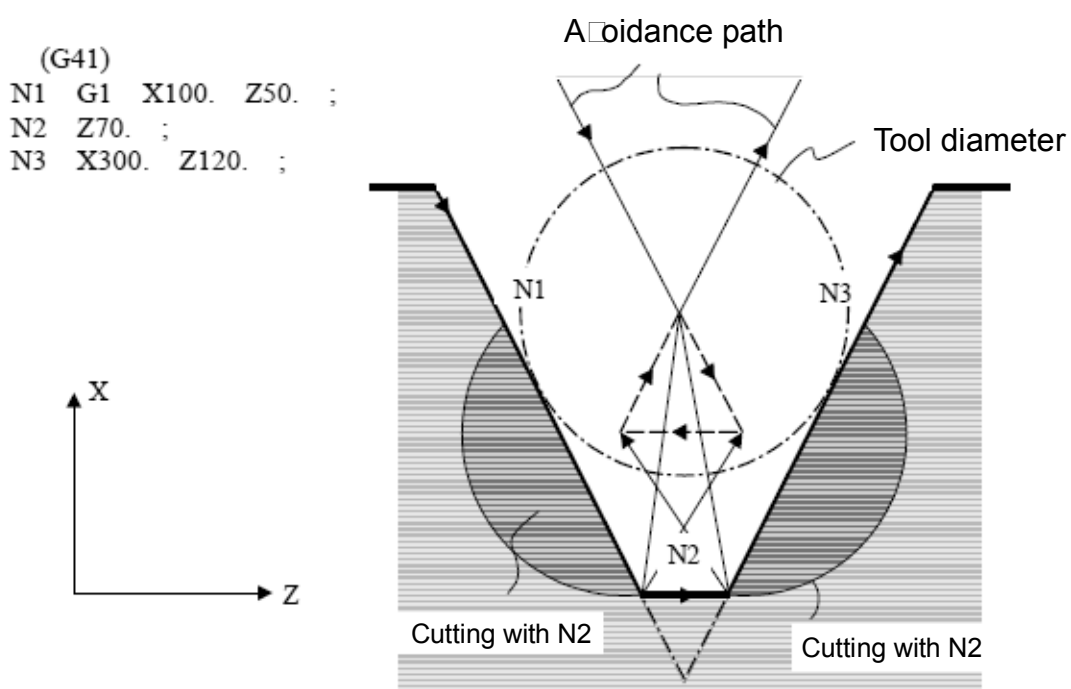

Fig 3-77

1. Interference check alarm □ An alarm occurs before executing N1, process stops.
2. Interference avoidance function □ N1 and N3 calculate intersection point, for altering the path to avoid interference.
3. Interference check disabled □ continue cutting into N1 and N3 lines.

Interference handling alarm

An interference alarm occurs when any of the following conditions take place □

1. Interference check alarm selected □ In the event of interference, an alarm is issued before the block of interference in the program.

- 2. Interference avoidance function selected
 - a. Interference occurs in two consecutive blocks in the program. (Interference in both N2 and N3).

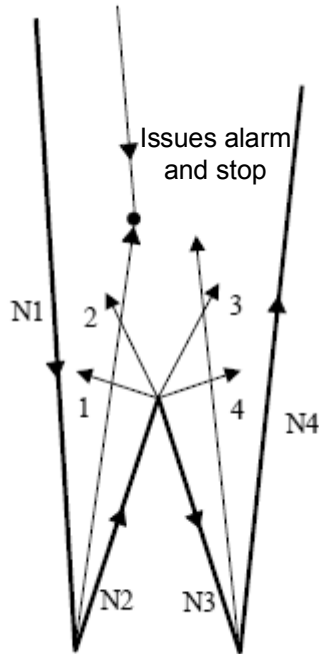

Fig 3-78

- b. An avoidance path cannot be found (no intersection of N2 and N4),

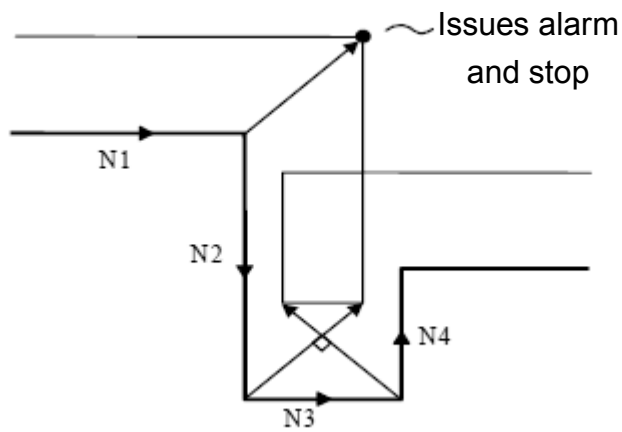

Fig 3-79

- c. Direction of program path is opposite the path after interference avoidance (direction of path after interference avoidance is opposite to N2 direction).

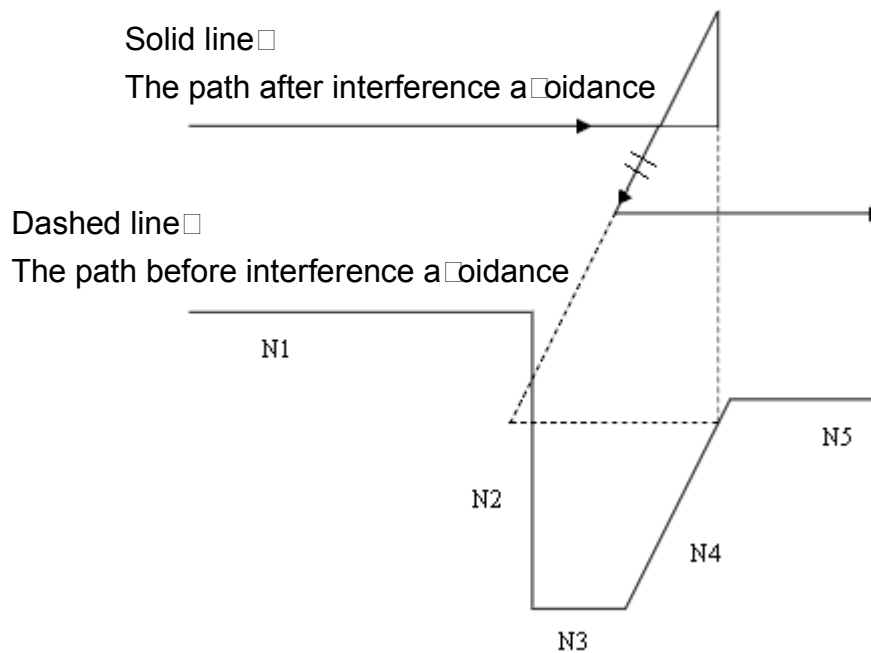

Fig 3-80

3.27.4 Notes on Tool Radius Compensation

1. When radius compensation is executed, there should be at least one block containing positioning commands between two neighboring blocks. The following commands do not perform tool positioning, though they have mechanical actions. Therefore they are not allowed for continuous blocks .

M05	· · · · M-code output
S2100	· · · · S-code output
G4 □1.000	· · · · Suspension
G1 U0.000	· · · · Feed distance□0
G98	· · · · G-code only

2. □nly G00 and G01 are applicable to blocks with tool-tip radius compensation. Arc commands G02, G03 are not allowed
3. The mo□e block before a tool-tip radius compensation command must be G00 or G01. Arc commands G02, G03 are not allowed.
4. The tool radius compensation function is not a□ailable for MDI operation.
5. Tool-tip radius compensation is not allowed for G74, G75, or G76.

6. Pre-read pre-emptive commands (G65, L50) are not allowed during the tool-tip radius compensation mode.

Tool-tip Radius Compensation Example:

Tool number #02, tool-tip direction #3, tool-tip radius #1.5 mm. The #-axis coordinate is defined by the diameter.

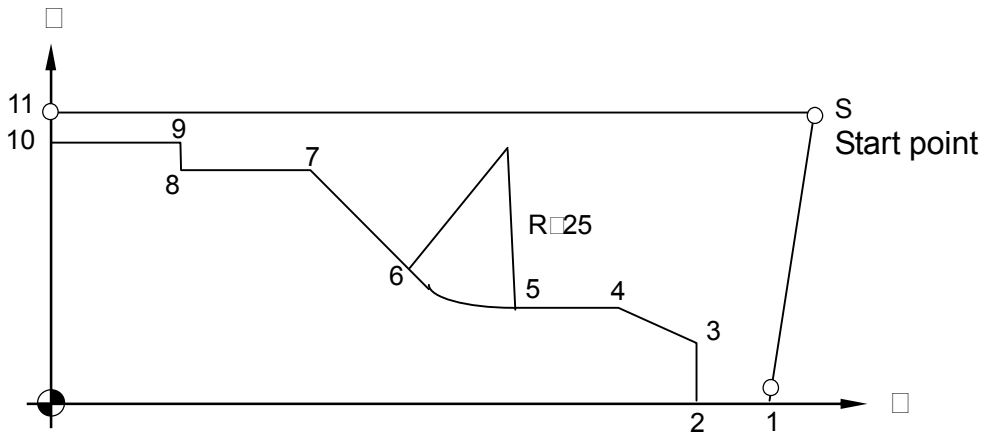

Fig. 3-81

N10 G0 #100. #120.	· · · Point S
N20 G0 #0. #110.	· · · Point 1
N30 M3 S2000	
N40 G42 #100. T02 F3.0	· · · Point 2, compensation insertion
N50 G1 #20.	· · · Point 3
N60 #30. #91.34	· · · Point 4
N70 #75.	· · · Point 5
N80 G02 #44.644 #57.322 I25. F1.5	· · · Point 6, arc cutting
N90 G01 #76. #37.644 F3.0	· · · Point 7
N100 #20.	· · · Point 8
N110 #80.	· · · Point 9
N120 #0.	· · · Point 10
N130 G40 #90.	· · · Point 11, compensation cancellation
N140 G0 #100. #120.	· · · Point S
N150 M05	
N160 M02	

An over-cutting alarm is generated if you try to return to Point S directly from Point 10. This is because the angle of 9-10-S is too sharp. The alarm is also generated if the radius compensation is greater than 2.0 mm, which is the distance from 8 to 9.

3.28 Coordinate System

3.28.1 Local Coordinate System Setting , G52

Command Format:

G52

Command Description:

If it is required to set another sub-coordinate system for the geometric shape of the Workpiece being processed under previous Working Coordinate System (G54..G59), then the said sub-coordinate system will be regarded as the Local Coordinate System.

G52 0.0 0.0 0.0 Cancel Local Coordinate System

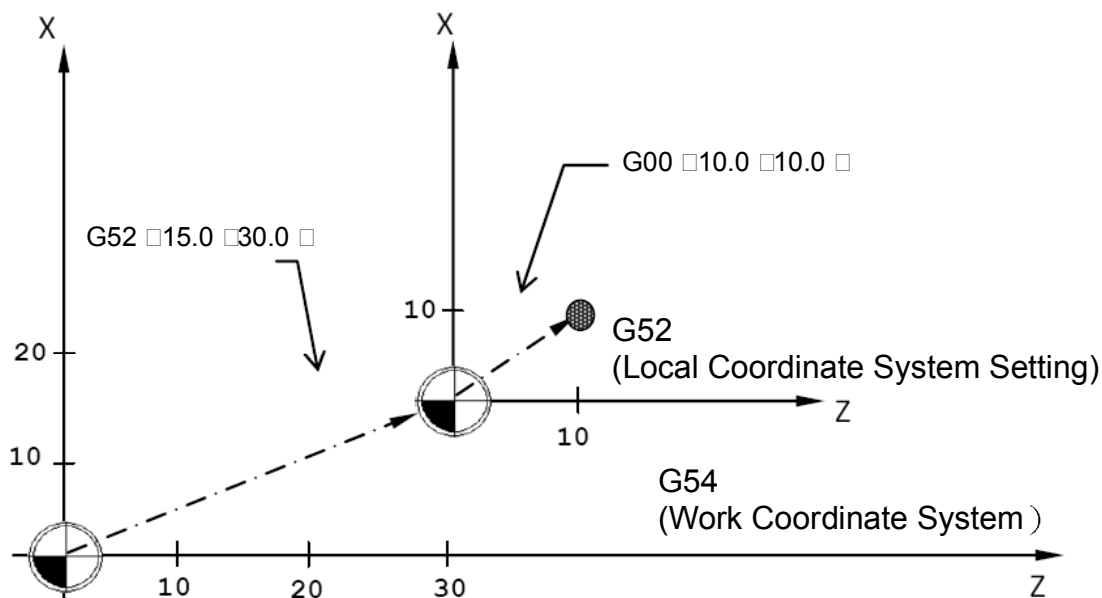

Fig. 3-82

Example of the Program□

G54□ Designate the Working Coordinate System as G54.

G52 □19.0 □30.0□ Designate Local Coordinate System to □15.0 □30.0 position of the current working coordinate system.

G00 □10. □10□ □ quickly mo□e to □10.0 □10.0 position of Local Coordinate System.

G52 □0.0 □0.0□ Cancel the Local Coordinate System setting.

Remark□

1. The Resume Signal will o□erride the Local Coordinate System.
2. When switching G54□ □G59 Working Coordinate System, the Local Coordinate System will be cancelled.

3.28.2 Basic machine coordinate system , G53

Command Format

G53 □□□ □□□ □□□ A□□ B□□ C□□ P0

or G53 □□□ □□□ □□□ A□□ B□□ C□□

□□□-axis mo□es to the designated Machine Coordinate □ position with G00 speed.

□□□-axis mo□es to the designated Machine Coordinate □ position with G00 speed.

□□□-axis mo□es to the designated Machine Coordinate □ position with G00 speed.

A□A-axis mo□es to the designated Machine Coordinate A position with G00 speed.

B□B-axis mo□es to the designated Machine Coordinate B position with G00 speed.

C□C-axis mo□es to the designated Machine Coordinate C position with G00 speed.

G53 □□□ □□□ □□□ A□□ B□□ C□□ P1

□□□-axis mo□es to the designated Machine Coordinate □ position with G01 speed of pre□ious node.

X-axis moves to the designated Machine Coordinate X position with G01 speed of previous node.

Y-axis moves to the designated Machine Coordinate Y position with G01 speed of previous node.

A-axis moves to the designated Machine Coordinate A position with G01 speed of previous node.

B-axis moves to the designated Machine Coordinate B position with G01 speed of previous node.

C-axis moves to the designated Machine Coordinate C position with G01 speed of previous node.

Description

The Home Position of the machine is the fixed home position being set by the manufacturer when manufacturing the CNC machine and such Coordinate System belongs to a fixed system. When designated by G53 Command and coordinate command, the Tool will move to the position designated for the basic coordinate system of the machine. Soon as the Tool returns to zero point (0, 0, 0) of the machine, it means the Home Position of the machine's coordinate system.

Notice

1. G53 Command will be valid for the designate node.
2. Before giving the G53 Command, the Tool offsetting must be cancelled (length, wearing, tip radius offsetting).
3. The command shall be valid under absolute value programming status, and will not fail under incremental value programming.

3.28.3 Work Coordinate System, G54~G59

Purpose and functions:

Six sets of different work origins can be set. The coordinate system comprising these work origins is named Work Coordinate System. The major merit of a Work Coordinate System is the simplified calculation of coordinates in the process program.

Details:

The program use these work coordinate origins via commands G54-G59. According to process requirements and program design, the user may select any set, or 2 sets or even 6 sets for the process. The major merit of these Work Coordinate Systems is the simplified calculation of coordinates in the process program.

1. The following table describes the relationship between G54-G59 Work Coordinate System and setting values of X, Z, A, B, C items of MCM parameters 1-120. These coordinate parameters (work origins) correspond to machine coordinates by setting the machine origin as zero, therefore the work origin settings of work coordinates G54-G59 are as follows. An illustration is given taking X-Z 2 axes as the example

Table 3-12

Work coordinate system	Parameter Item Number	X-axis setting value	Z-axis setting value
G54	1(X), 3(Z)	-100.000	-70.000
G55	21(X), 23(Z)	-30.000	-80.000
G56	41(X), 43(Z)	-50.000	-80.000
G57	61(X), 63(Z)	-50.000	-70.000
G58	81(X), 83(Z)	-60.000	-40.000
G59	101(X), 103(Z)	-40.000	-20.000

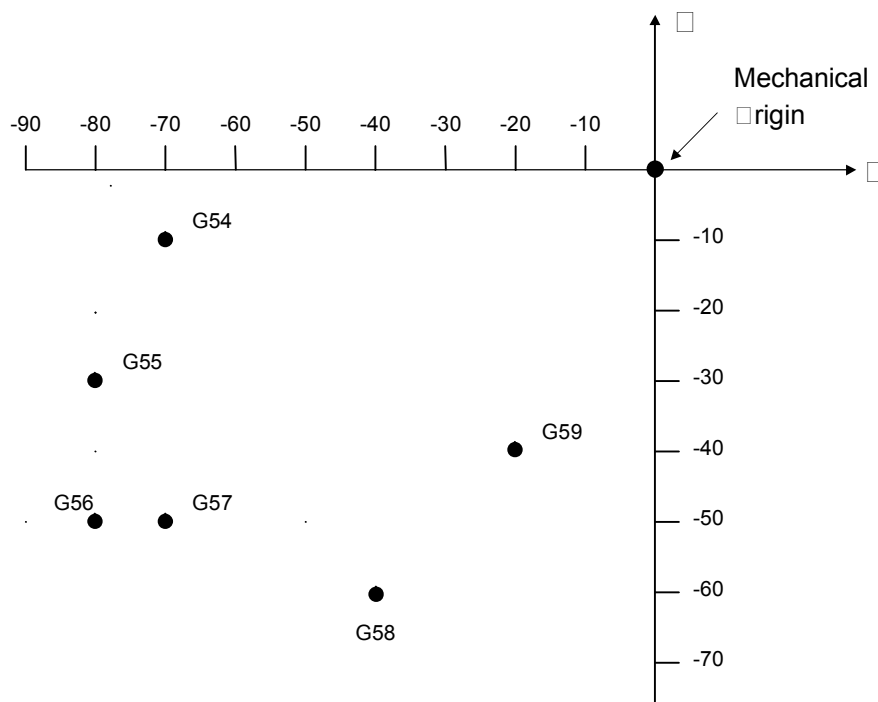

Fig. 3-83 G54-G59 Work Coordinate System

2. When a Work Coordinate System is selected, program coordinates also change accordingly. The altered coordinates are based on the Work Coordinate System. Adding circular and semi-circular cuttings in program of the above figure, the application of G54 and G55 can be described by the following example. (Fig.3-84)

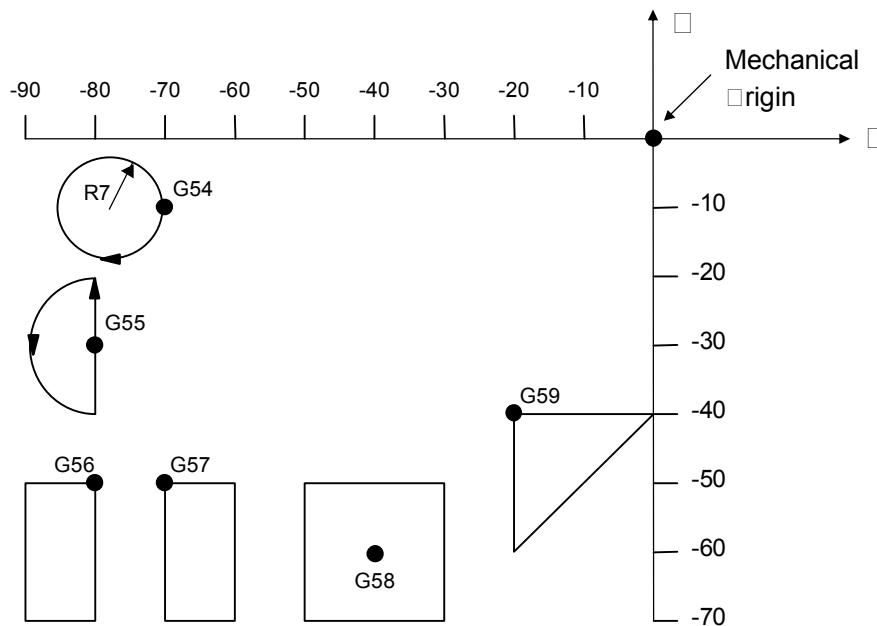

Fig. 3-84 G54-G59 application

Program Example:

N1 G54	... Select the first work coordinate
N2 G0 X0 Y0	... Positioned to program coordinates X0, Y0, (Machine coordinates X-10, Y-70.)
N3 G2 I-7.0 F200	... Cut a full circle with R7.0 clockwise
N4 G0	... Set feed mode as FAST
N5 G55	... Select the second work coordinate
N2 G0 X0 Y0	... Positioned to program coordinates X0, Y0, (Machine coordinates X-30, Y-80.)
N6 G1 W10.0 F300	... X-axis cutting incremental feed command, travel X10.0
N7 G3 W-20.0 R10.0 F300	... Cut a R10.0 semi-circle counterclockwise
N8 G1 W10.0 F300	... X-axis cutting incremental feed command, travel X10.0
N9 G28	... If MCM parameter of first reference point X0,

```

                                program returns to machine origin
N10 M2                            ... Program end
    
```

1. Selection of Work Coordinate System is done by giving G54 ~ G59 commands.
2. After giving G54~G59 commands, machine coordinates of the program origin alter according to the new Work Coordinate System.
3. Controller automatically set as G54 Work Coordinate System when the machine starts or when Reset is pressed.

3.29 Corner chamfer (,C_), round-angle chamfer (,R_) functions:

In a command block for forming a corner from a continuous line of any arbitrary angle or from an arc, **,C_** or **,R_** can be used at the end of block to perform a chamfer or a round-angle chamfer. They are applicable to both absolute and incremental commands.

3.29.1 Chamfer (, C__)

Functions and Purposes:

In 2 consecutive blocks, the **,C_** command in the first block executes a corner chamfer, **,C_** stands for the length from the assumed starting point to the end point of the chamfer.

Command Format:

```

N100 G0x [ ] [ ] [ ] [ ] ,C [ ] [ ] [ ]
N200 G0x [ ] [ ] [ ] [ ] ;
    
```

Where

G0x can be any of the G00, G01, G02, and G03 commands.

,C is the length from the assumed starting point to the end point of the chamfer.

Program Example:

1. Line—Arc

Absolute value command

N1 G28 X Z ;
N2 G00 X50. Z100. ;
N3 G01 X150. Z50. ,C20. F100 ;
N4 G02 X50. Z0 I0 K-50. ;

Relative value command

N1 G28 X Z ;
N2 G00 U25. W100. ;
N3 G01 U50. W-50. ,C20. F100 ;
N4 G02 U-50. W-50. I0 K-50. ;

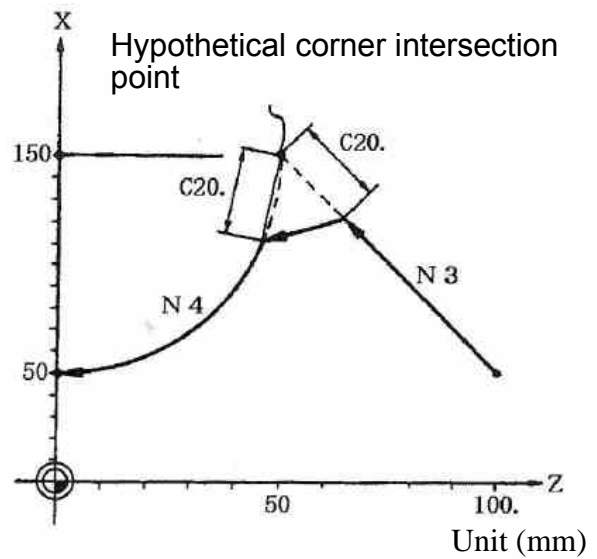

Fig. 3-85

2. Arc—Arc

Absolute value command

N1 G28 X Z ;
N2 G00 X20. Z140. ;
N3 G02 X100. Z60. I100. K0. ,C20. F100 ;
N4 X60. Z0 I80. K-60. ;

Relative value command

N1 G28 X Z ;
N2 G00 U10. W140. ;
N3 G02 U40. W-80. R100. ,C20. F100 ;
N4 U-20. W-60. I80. K-60. ;

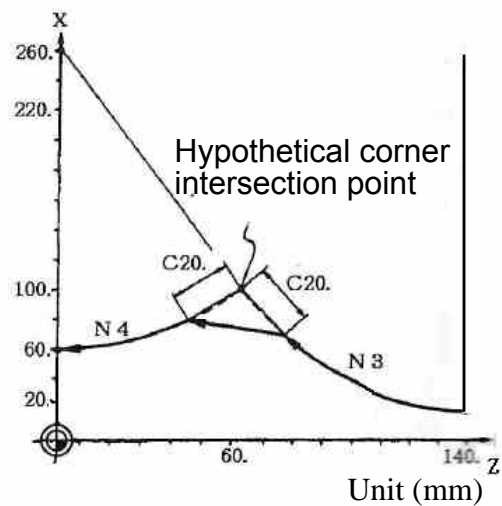

Fig. 3-86

3.29.2 Round-angle chamfer (, R_)

Functions and Purposes:

In 2 consecutive blocks, the `,R_` command in the first block executes a round-angle chamfer. `,R_` stands for the radius of arc of the round-angle chamfer.

Command Format:

```
N100 G0x □□□□ □□□□,R□□□ □
N200 G0x □□□□ □□□□ □
```

Where

G0x : can be any of the G00, G01, G02, and G03 commands.

,R□ : is the radius of round-angle chamfer.

Program Example:

1. Line—Arc

Absolute value command

N1 G28 X Z ;
N2 G00 X60. Z100. ;
N3 G01 X160. Z50. ,R10. F100 ;
N4 G02 X60. Z0 I0 K-50. ;
:

Relative value command

N1 G28 X Z ;
N2 G00 U30. W100. ;
N3 G01 U50. W-50. ,R10. F100 ;
N4 G02 U-50. W-50. I0 K-50. ;
:

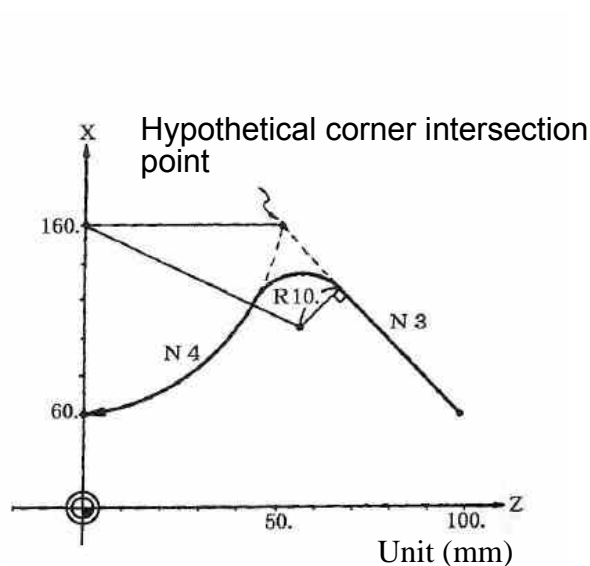

Fig. 3-87

2. Arc—Arc

Absolute value command

N1 G28 X Z;
N2 G00 X60. Z100. ;
N3 G02 X160. Z50. R60 ,R10. F100 ;
N4 X60. Z0 R50. ;
:

Relative value command

N1 G28 X Z;
N2 G00 U30. W100. ;
N3 G02 U50. W-50. I50. K0 ,R10. F100 ;
N4 U-50. W-50. I0. K-50. ;
:

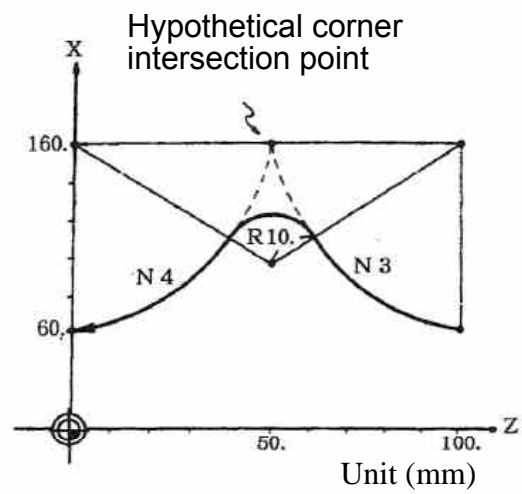

Fig. 3-88

3.30 Linear angle function (,A_)

Functions and Purposes:

Given a line angle and end coordinates of any axis, the end coordinates of another axis can be calculated automatically.

Command Format:

G01 (),A ()

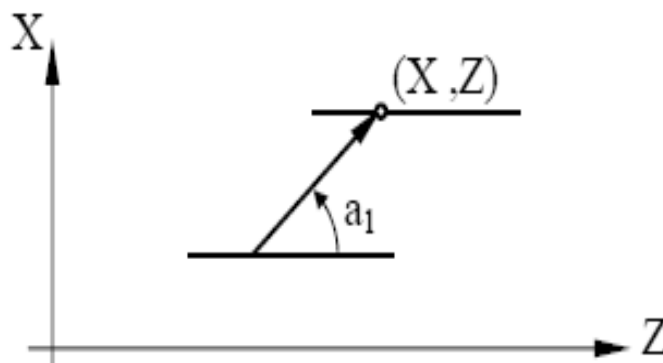

Fig. 3-89

Program Example:

N01 G00 X50.0 Y50.0 Fast positioning to a specified point
 N02 G01 X100.0, A45.0 end point absolute X-coordinate is 100, tool path is
 in a 45° phase difference with the level axis.
 Y-coordinate will be 100 after program execution.

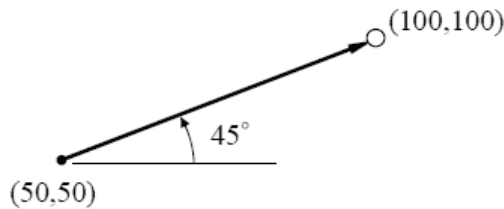

Fig. 3-90

Details:

1. Angle indication
 Starting from the first axis (horizontal axis) of the selected plane, the counterclockwise direction (CCW) is positive, counterclockwise direction (CW) is negative.

2. Range of angle
 $-360.00 \leq \theta \leq 360.00$, for an angle exceeding the 360.00 range, divide the angle by 360.00 degrees and take the remainder. E.g., for an angle of 400.00 degrees, the remainder 40.00 after divided by 360.00 will be the specified angle.

Other relevant functions:

Line angle + Chamfer / Round-angle chamfer

EX1 :

N1 G01 X100.0, A45.0, C10.0
 N2 G03 X100.0 Y100.0 I10.0 J10.0

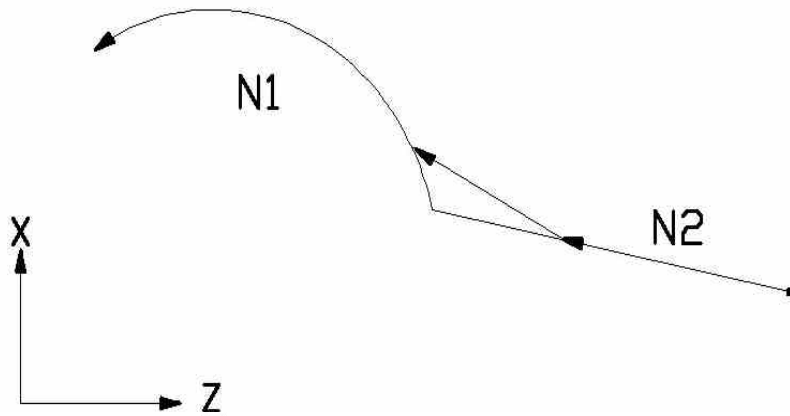

Fig. 3-91

EX2 :

```
N1 G01 [ ][ ][ ][ ],A[ ][ ][ ],R[ ][ ][ ][ ]
N2 G03 [ ][ ][ ][ ] [ ][ ][ ][ ][ ] I[ ][ ][ ][ ][ ][ ][ ][ ]
```

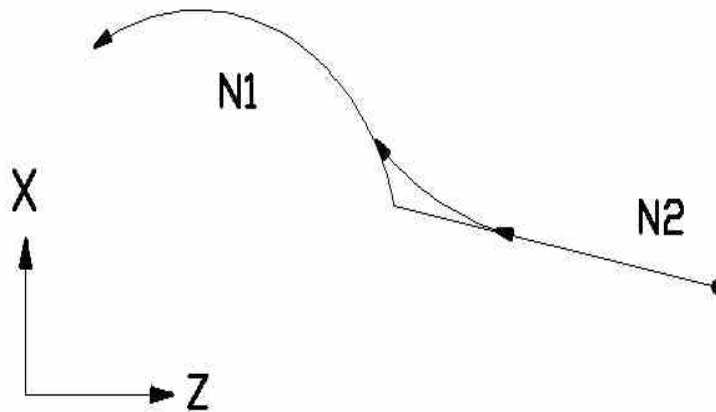

Fig. 3-92

3.31 Geometry function command

Functions and Purposes:

If the intersection point of two line segments is hard to get, using inclination of the first line and absolute coordinates of the end point of the second line and its inclination, the end point of the first line can be determined automatically by the internal system, with the move path controlled automatically.

Command Format:

- G01,A[][][] □ Specifies inclination of the first line
- G01 [][][][][][][][][] , A[][][][] □ Specifies the absolute coordinate of the end of the next block and the inclination.

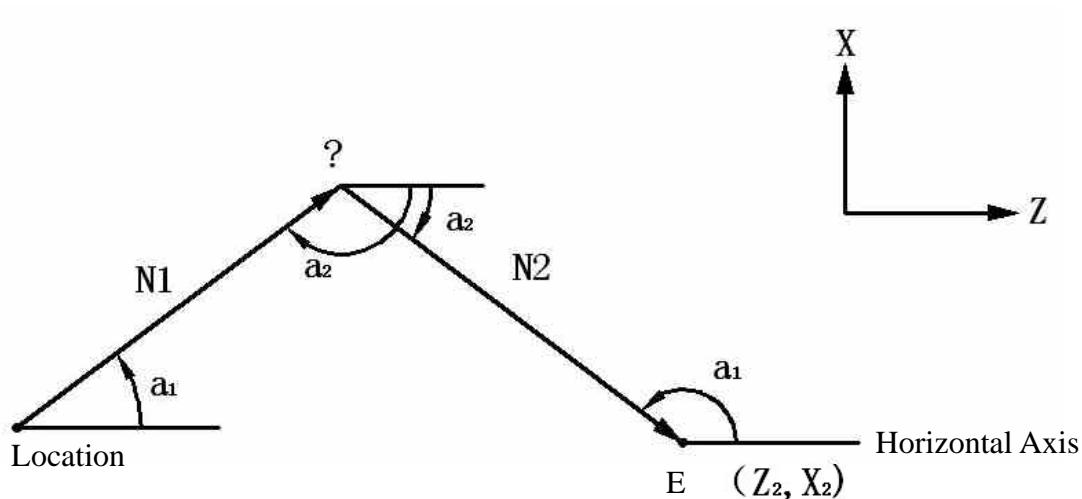

Fig. 3-93

Program Example:

```

N01 G00 □0.0 □0.0 ;
N02 G01,A45.0 ;
N03 □90.0 □0.0 ,A135.0 ;
    
```

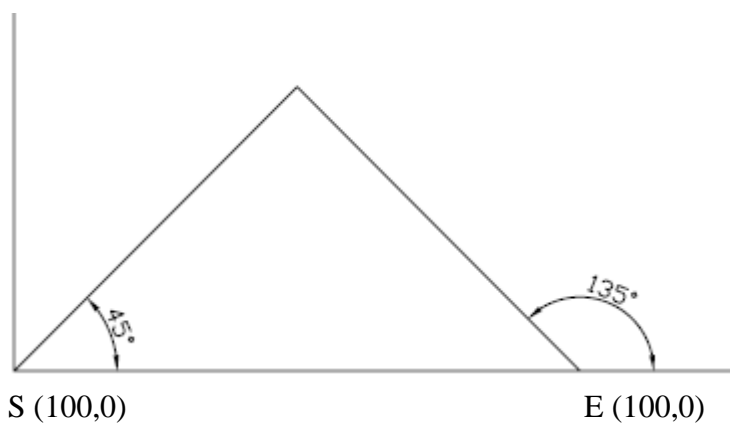

Fig. 3-94

Details:

1. Angle indication □ Starting from the first axis (horizontal axis) of the selected plane, the counterclockwise direction (CCW) is positive, counterclockwise direction (CW) is negative.
2. Range of angle □ $-360.00 \leq \vartheta \leq 360.00$, for an angle exceeding the 360.00 range, divide the angle by 360.00 degrees and take the remainder. E.g., for an angle of 400.00 degrees, the remainder 40.00 after divided by 360.00 will be the specified angle.
3. Report an error if relative coordinates are used for the end coordinates of

the second block.

- Report an error if the two lines have no any intersection point, or the intersection angle is less than 1 degree.

Other relevant functions:

- Specify a chamfer or round-angle chamfer only when the angle of the first block is specified.

EX1 :

```
N1 G01 ,Aa1 , Cc1
N2 G01 □x2 □□2,Aa2
```

EX2 :

```
N1 G01 ,Aa1 , Rr1
N2 G01 □x2 □□2,Aa2
```

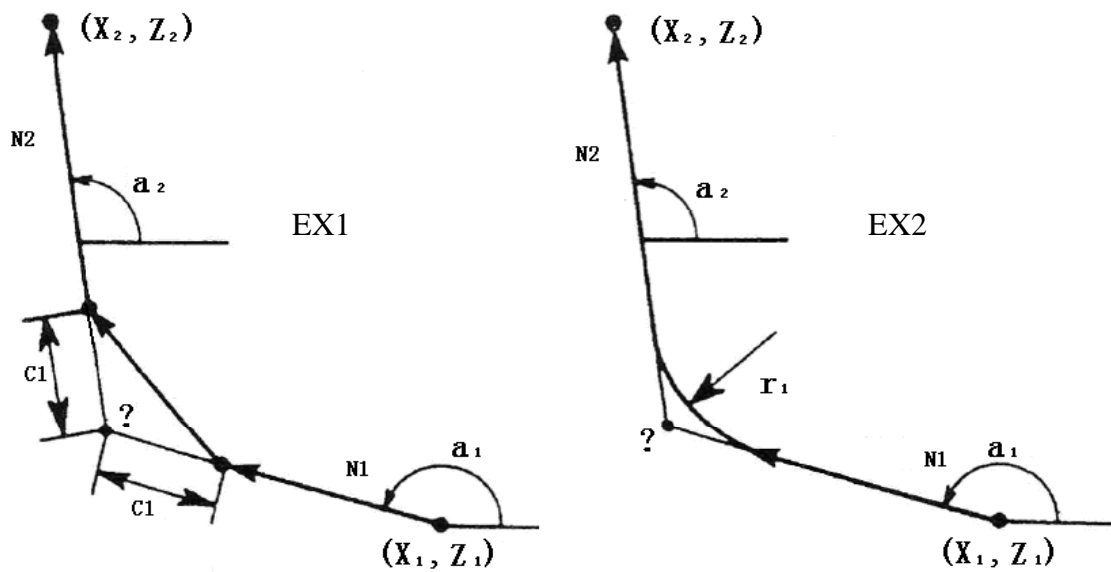

Fig. 3-95

- Geometry function command 1 can be performed after a line angle is specified.

EX1 :

```
N1 G01 Xx2 ,Aa1
N2 G01 ,Aa2N3 G01 Xx3 Yy3 ,Aa3
```

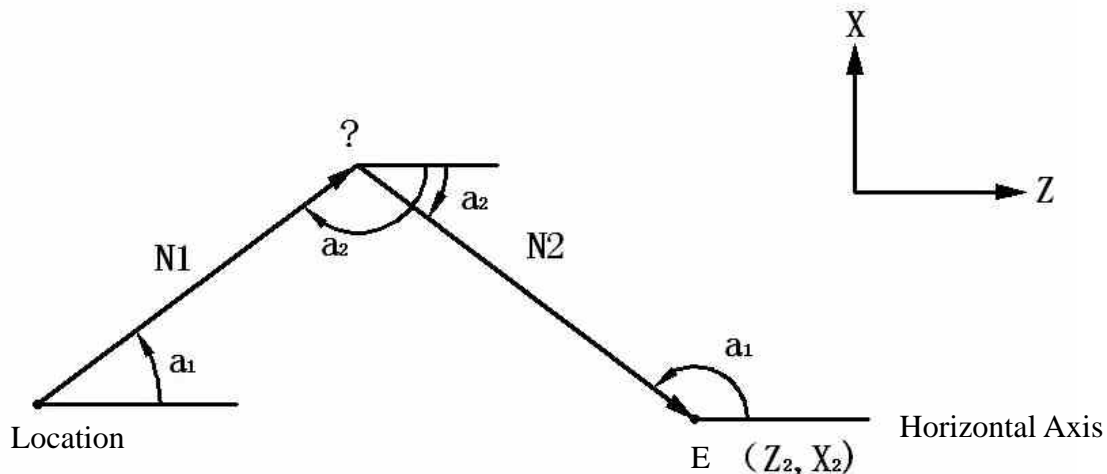

Fig. 3-96

3.32 Automatic calculation of Line-Arc intersection point

Functions and Purposes:

Automatically calculate the coordinates of a line-arc intersection point when it is not specified, with automatic control of the move path,

Command Format:

```
G01,A□□□ □ Specifies inclination of the first line
G02(G03) □□□□□□□□P□□□□ □□□□H□□□□ Specifies the end point and absolute
coordinates of the center of the circle of the next block, and the selection of
the intersection point.
```

Note:

- P, □□ the absolute coordinates of centers of arcs of the □, □-axes
- H : Line-arc intersection selection
- 1 : Using the shorter line as the intersection.

2 : Using the longer line as the intersection. □□□□

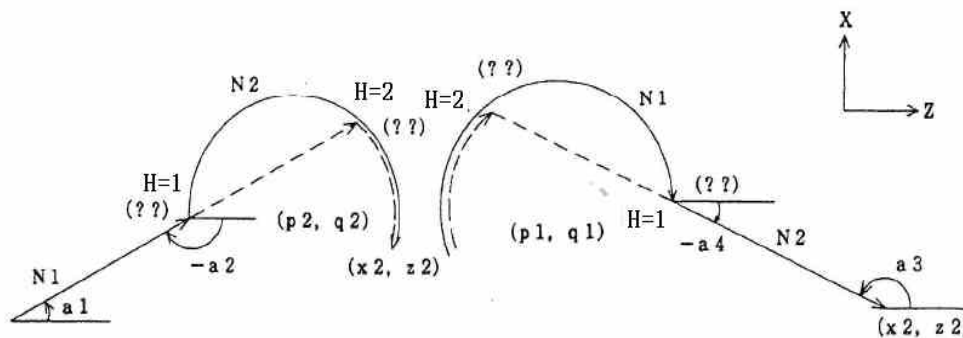

Fig. 3-97

```

N1 G01 ,Aa1                               N1 G02(G03)Pp1 □□1 H□
N2 G02(G03) □x2 □□2 Pp2 □□2 H□           N2 G01 □x2 □□2 ,Aa3
    
```

Details:

1. Report an error when the second block is not absolute coordinates.
2. Report an error when the second block is an arc without P,□ specifications.
3. Report an error if the lines have no intersection point with the arc.

Relationship with other functions:

1. Finding line-arc intersection point □ chamfer

EX1 :

```

N1 G01,A□□□,C□□□
N2 G03 □□□□ □□□□ P□□□ □ □□□ H□□□
    
```

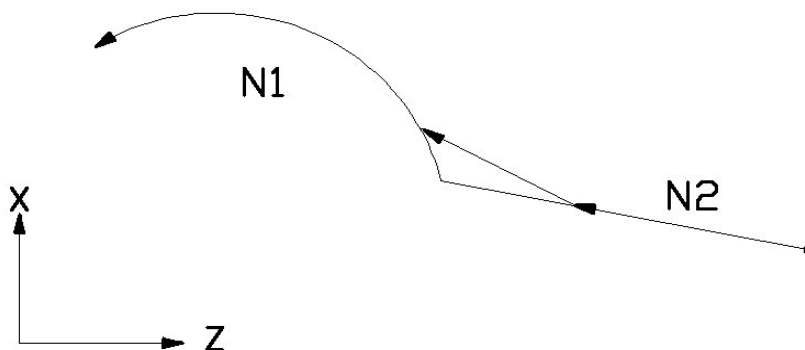

Fig. 3-98

2. Finding line-arc intersection point □ round-angle chamfer

EX2 :

N1 G01,A□□□,R□□□

N2 G03 □□□□ □□□□ P□□□□ □□□□ H□□□□

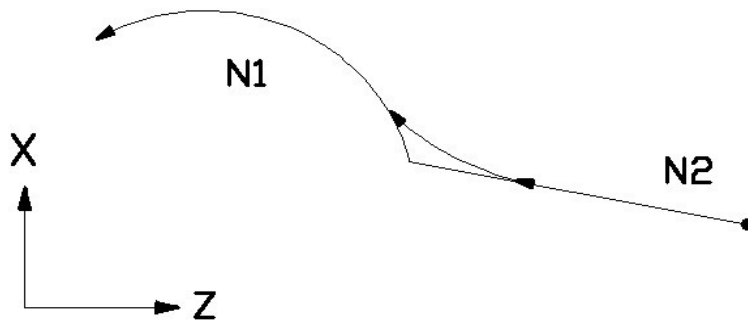

Fig. 3-99

4 MCM Parameters

4.1 MCM Parameters

The MCM parameter setting function allows the user to define the controller system constants according to mechanical specifications and machining conditions.

These parameters are classified into two groups basic parameters and MCM parameters.

4.1.1 Basic Parameters

Quickly press the  key twice to enter the parameter setting screen, as shown below.

G71,G72 go into	X-AXIS	-00.000 inch	Z-AXIS	-00.000 inch
G73 amount cutting		-00.000 inch		-00.000 inch
G71,G72 retreat		-00.000 inch	G73 segmentation	0000
G74,G75 retreat		-00.000 inch	G76 fine cutting	0000
G76 Angle of tool tip		0000	G76 chamfer Len	0000
G76 Depth of minimum cutting		-00.000 inch	G76 retreat	-00.000 inch
MPG Direction $\frac{1}{X/Z}$ $\frac{2}{Y}$ $\frac{3}{Z}$ $\frac{4}{Z}$		0	Graphic proportion	0000.000
G84 dwell at bottom time		000000	Multi-purpose MPG 1:yes	0
G84 Acc/Dec fine tuning time		000000	0:Diameter 1:Radius	0
G83 buffer distancecg		0000.000	Chuck type 0:in 1:out	0
Chuck locked delay time		000000	Metric 0:mm 1:inch	0
Wait for SP speed reaching		0	Screensaver 0:yes	0
MPG-test feedrate Num.		0000	Restart,skip M98 1:yes	0
MPG-test feedrate Den.		0000	Non-stop 0:no 256:yes	000
Restart,MTS G04 0:skip 1:run		0	TLM function 0:open 1:close	0
Restart,block refetch 0:yes		0	Edit omit decimal 1:yes	0
Remaining days		0000000	Lamp yellow <small>0:feedhold 1:M02/M30 2:all</small>	0
Tapping Acc/Dec time (ms)		0000	Corner connection <small>1:G02/G03 2:G11/G02/G03</small>	0
G41/G41 interference deal with 0/1/2		0	Use Y axis 1:yes	0
Coolant pump error				
Back	Main		SYSTEM MCM	VERSION G54..G59

Fig 4-1

4.1.2 MCM Parameters

The correct and proper setting of these parameters is important for operation of the mechanical system and fabrication of the work-piece. Make sure that the setting is correct. Press  to restart the machine when the MCM parameter is successfully set

※ After pressing F5-System Parameter key in User Parameter page, the System Parameter page can be accessed but it can be reviewed and cannot be revised, as per the figure below. To revise the system parameters, press F7-Revise Parameter key and then input system parameter

password → initial value 123456 and you can re-initialise the system parameters.

PARAMETERS	X-AXIS	Y-AXIS	Z-AXIS
Resolution-Den.(pulse)	0000000	0000000	0000000
Resolution-Num.(pitch)	0000000	0000000	0000000
Traverse speed	0000000	0000000	0000000
Rotate direction	0	0	0
Home speed-1	0000000	0000000	0000000
Home speed-2	0000000	0000000	0000000
Home direction	0	0	0
Find grid direction	000	000	000
Distance of grid error	-0000.000	-0000.000	-0000.000
Software OT(+)	-0000.000	-0000.000	-0000.000
Software OT(-)	-0000.000	-0000.000	-0000.000
MPG Den.	0000000	0000000	0000000
MPG Num.	0000000	0000000	0000000
Pitch err comp.(-1,0,1)	-0	-0	-0
Pitch err segment length	0000.000	0000.000	0000.000
Backlash(G01)	00.000	00.000	00.000
Encoder direction	0	0	0
Pulse cmd width ^{2500k} / _N	0	0	0
Grid offset	-000.000	-000.000	-000.000

Coolant pump error

Back	Main	Change password		ALL MCM	Pitch Error	MCM Modify	PAGE
------	------	-----------------	--	---------	-------------	------------	------

Fig. 4-2 System Parameter Page 1

Signal 0:NO1:NC 2:Disable			
I00 EM-stop	0	I19 Z-Axis OT-	0
I01 X home	0	I20 SP1 home signal1	0
I02 Z home	0	I21 SP1 home signal2	0
I03 X-axis error	0	I22 Spindle2 error	0
I04 Z-axis error	0	I23 Spindle3 error	0
I05 Spindle 1 error	0	I24 Y home	0
I16 X-axis OT+	0	I25 Y-axis error	0
I17 X-axis OT-	0	I26 Y-axis OT+	0
I18 Z-axis OT+	0	I27 Y-axis OT-	0
I/O Function format setting			
I16 X-axis OT+	0	O09 Tailstock FOR	0
I17 X-axis OT-	0	O10 Buzzer	0
I18 Z-axis OT+	0	O11 Bar feeder start	0
I19 Z-Axis OT-	0	O12 Received Box	0
I20 SP1 home signal1	0	O13 Tailstock chuck	0
I21 SP1 home signal2	0	O14 Lamp YELLOW	0
I22 Spindle2 error	0	O15 Lamp GREEN	0
I23 Spindle3 error	0		0

Y-axis OT-

Back	Main	Change password				MCM Modify	PAGE
------	------	-----------------	--	--	--	------------	------

Fig 4-3 System Parameter Page 2

PARAMETERS	X-AXIS	Y-AXIS	Z-AXIS
JOG speed	0000000	0000000	0000000
U,W max in execution	000.000	000.000	000.000
Arc compensation "+"	0000	0000	0000
Arc compensation "-"	0000	0000	0000
Arc compensation time(ms)	0000	0000	0000
Arc comp. function 1:cancel	0	Tool number(1~10)	00
Tool positioning delay(10ms)	0000	Tool change time(10ms)	00000
Wear direction	0	Max value of wear	00.000
Lubricate interval(s)	000000	Lubrication time(10ms)	000000
0:row 1:electric 2:hydraulic	0	Tool carrier 0:after 1:before	0
Pulse type 0:P+D 2:AB	0	Full automatic 1:yes	0
G01 Acc/Dec time	000000	G00 Acc/Dec time	000000
G99 Acc/Dec time	000000	MPG Acc/Dec time	000000
Home setting ^{0:None 1:X, 4:Z} / _{5:XZ 7:XYZ}	0	ATC reverse delay time	000000
Follow error checking 1:XZ 2:XYZ	0	Follow error value	000000
G92 A/D time of travel ending 0000 ms		Dynamic Acc/Dec 1:yes	0
Exec. home after EM-stop 1:yes	0	ACC/Dec type 1:linear 2:S-curve	0
Monitor function 1:yes	0	Power off after servo alarm 1:yes	0

Coolant pump error 000

Back	Main	Change password	BN-MCM	CLEAR ALL-PGM	LD-MCM	CLEAR OFFSET	MCM Modify	Unlock
------	------	-----------------	--------	---------------	--------	--------------	------------	--------

Fig 4-4 System Parameter Page 3

Tools number(1~10)	00	0:Row 1:Electric 2:Hydraulic	0
Tool positioning delay	0000	Tool change time(10ms)	00000
Wear direction 0:"-" 1:"+"	0	Max value of wear	00.000
Lubricate interval(s)	000000	Lubrication time(10ms)	000000
Max rpm of chuck unclamp	00000	Screen saver 1:NO	0
Chuck type 0: Hydraulic 1: General	0	Y axis select 1:YES	0
Multi-MPG 0:NO 1:YES	0	Tool carrier 0:After 1:Before	0
Power on default 0:G99 1:G98	0	Acc/Dec type	0
Pulse type 0:P+D 2:AB	0	G00 Acc/Dec time	000000
G01 Acc/Dec time	000000	MPG Acc/Dec time	000000
G99 Acc/Dec time	000000	SP voltage balance	-00.000
MPG direction $\frac{0}{1} \frac{0}{1} \frac{0}{1} \frac{0}{1}$	0	Spindle number	0
Insert blank in the MDI	0	Home setting $\frac{0}{1} \frac{None}{1}$	0
Error count checking 0:NO 1:YES	0	G02/G03 sp fbk filter	0000
SIO filter constant(ms)	0000	Dynamic Acc/Dec 0:NO	0
Non-stop 0:NO 1:YES	000	Error count check value	0000000
SP1 chuck solenoid 0:one 1:two	0	ATC reverse delay time	0000000
MPG-test feedrate Num.	0000000	MPG-test feedrate Den.	0000000

000		▲	PAGE	▼
Back	Change	BN-MCM	CLEAR	LD-MCM
Main	password		ALL-PGM	LD-MCM
			OFFSET	MCM
				Modify
				Unlock

Fig 4-5 System Parameter Page 4

0:voltage 1:pulse	0	SP rotation direction	0
0:open-loop 1:close loop	0	SP find grid 0:no 1:yes	0
SP acceleration time	0000000	SP search grid direction	0
SP deceleration time	0000000	SP positioning direction	0
SP manual rotation speed	0000	SP search home signal 1:yes	0
SP search grid speed	0000	SP encoder filter	0
SP positioning angle	-000.00	SP positioning speed	0000
SP encoder(pulse)	0000000	SP search home speed	0000
SP command(pulse)	0000000	SP home shift	-000.00
Spindle voltage balance	-00000	SP encoder factor	0
SP max rpm at 10V	0000000	SP encoder direction	0
SP +10V slope speed	0000000	Chuck 0:hydraulic 1:general	0
SP -10V slope speed	0000000	SP chuck solenoid 0:one 1:two	0
SP distance of grid error	0000000	Power on default 0:G99 1:G98	0
SP max rpm of chuck unclamp	00000	G02/G03 SP filter constant	0000
Power on default JOG speed	00000	SP stop after pro. end 1:yes	0
SP change into standard			
Resolution-Den.(pulse)	0000000	Travel speed	0000000
Resolution-Num.(pitch)	0000000	Acc./Dec. time	0000
Tapping type 0:G98 1,2:G99	0		

Coolant pump error		▲	PAGE	▼
Back	Change	Spindle1	Spindle2	Spindle3
Main	password			
				MCM
				Modify

Fig 4-6 System Parameter Page 5

SP2			
0:voltage 1:pulse	0	SP rotation direction	0
0:open-loop 1:close loop	0	SP find grid 0:no 1:yes	0
SP acceleration time	0000000	SP search grid direction	0
SP deceleration time	0000000	SP positioning direction	0
SP positioning angle	-000.00	SP encoder filter	0
SP encoder(pulse)	0000000	SP positioning speed	0000
SP command(pulse)	0000000	SP home shift	-000.00
Spindle voltage balance	-00000	SP manual rotation speed	0000
SP max rpm at 10V	0000000	SP search grid speed	0000
SP +10V slope speed	0000000	SP encoder factor	0
SP -10V slope speed	0000000	SP encoder direction	0

SP change into standard			
Resolution-Den.(pulse)	0000000	Traverse speed	0000000
Resolution-Num.(pitch)	0000000	Acc./Dec. time	0000
Tapping type 0:G98 1,2:G99	0		

Coolant pump error		▲	PAGE	▼
Back	Change	Spindle1	Spindle2	Spindle3
Main	password			
				MCM
				Modify

Fig 4-7 System Parameter Page 6

X-axis, compensation amount each segment							
01	-00.000	11	-00.000	21	-00.000	31	-00.000
02	-00.000	12	-00.000	22	-00.000	32	-00.000
03	-00.000	13	-00.000	23	-00.000	33	-00.000
04	-00.000	14	-00.000	24	-00.000	34	-00.000
05	-00.000	15	-00.000	25	-00.000	35	-00.000
06	-00.000	16	-00.000	26	-00.000	36	-00.000
07	-00.000	17	-00.000	27	-00.000	37	-00.000
08	-00.000	18	-00.000	28	-00.000	38	-00.000
09	-00.000	19	-00.000	29	-00.000	39	-00.000
10	-00.000	20	-00.000	30	-00.000	40	-00.000

切削水泵異常

Back	Main	Z-AXIS		Y-AXIS		PAGE
						MCM Modify

Fig. 4-8 X-axis Stud Error offset

Y-axis, compensation amount each segment							
01	-00.000	11	-00.000	21	-00.000	31	-00.000
02	-00.000	12	-00.000	22	-00.000	32	-00.000
03	-00.000	13	-00.000	23	-00.000	33	-00.000
04	-00.000	14	-00.000	24	-00.000	34	-00.000
05	-00.000	15	-00.000	25	-00.000	35	-00.000
06	-00.000	16	-00.000	26	-00.000	36	-00.000
07	-00.000	17	-00.000	27	-00.000	37	-00.000
08	-00.000	18	-00.000	28	-00.000	38	-00.000
09	-00.000	19	-00.000	29	-00.000	39	-00.000
10	-00.000	20	-00.000	30	-00.000	40	-00.000

切削水泵異常

Back	Main	Z-AXIS	X-AXIS			PAGE
						MCM Modify

Fig 4-9 Y-axis Stud Error offset

Z-axis, compensation amount each segment							
01	-00.000	11	-00.000	21	-00.000	31	-00.000
02	-00.000	12	-00.000	22	-00.000	32	-00.000
03	-00.000	13	-00.000	23	-00.000	33	-00.000
04	-00.000	14	-00.000	24	-00.000	34	-00.000
05	-00.000	15	-00.000	25	-00.000	35	-00.000
06	-00.000	16	-00.000	26	-00.000	36	-00.000
07	-00.000	17	-00.000	27	-00.000	37	-00.000
08	-00.000	18	-00.000	28	-00.000	38	-00.000
09	-00.000	19	-00.000	29	-00.000	39	-00.000
10	-00.000	20	-00.000	30	-00.000	40	-00.000

切削水泵異常

Back	Main		Y-AXIS	X-AXIS		PAGE
						MCM Modify

Fig 4-10 Z-axis Stud Error offset

4.2 Description of Parameters

(1) Basic Parameters :

* For the cutting parameters of G71-G76, please refer to the description of respective G-Code command under "G/M Code" of Chapter 3.

1. Set Drilling Cycle Buffering Distance
Format □□.□□□ (default □value□0.000)

When using G83 drilling command, the corresponding axis will move quickly from G00 for converting to the buffering distance setting of G01 feeding.

2. The ratio of the horizontal axis (□ axis) in graph mode
Format□□□□□. □□□

This parameter is for setting the scale of the graph in the graph mode. This parameter is an initial setting□for dynamic adjustment, you may press PageUP□PageDown button in the graph screen for alteration.

3. Initial Value generated by line number during program editing
Format □□(default □value□0)

When editing the program, the line number set for the first node system shall be "N1". If setting the parameter of this item as "10", then the line number of the second node will be "N10".

4. The interval □value obtained from setting the line number during program editing.
Format □□(default □value□0)

To set Item 3 as □10□during program editing, such parameter will be set as □10□so the line number when inserting Node 2 will be □N10□, and that for Node 3 will be □N20□, and so on for the rest of the other nodes.

5. Setting the chuck movement (inner, outer clamp setting)
Format □□ (default □value□0)
Setting □0, loosen

Setting □1, tighten

This parameter is for specifying whether the chuck is loosened or tightened in a protruding action.

6. Working Count Upper Limit Setting

Format □□□□□□□□ (default □alue□0)

If the working count range is set as □0□, then it means the counting limit will be ignored.

To execute the count, please add M15 in the working program (placed at the end of each processed Workpiece).

If receiving M15 Command when running the program, the system will add "1" to the number of the processed Workpieces automatically. Upon reaching the upper limit set for the Workpiece, the System will change to pausing status, reminding the customer that it has completed the set working count.

After reaching the upper limit count, the count arriving status can be cancelled by the following three methods□

- a. In Auto page, click the □0□key twice and the worked count will be cleared and set to □ero.
- b. Restart the program. □ou may also clear and set the worked count □ero in order to restart the counting.
- c. Press the Reset key and the count arriving status can also be cancelled and the worked count will be set to □ero.

7. Time delay for chuck tightening

Format □□□□□ (default □alue□50, unit□10ms)

If your key-in □50, the time delay is□500 ms (50□10ms)

This parameter is set to ensure that the chuck is securely clamped on the workpiece. In case the chuck fails to clamp the workpiece securely before executing the subsequent block, the setting needs to be increased.

8. Remaining Service Days

Such parameter is provided for reading instead of writing.

To remind the user to contact the machine manufacturing when the remaining service days are going to arrive.

9. Whether or not wait for spindle to reach full speed before performing axial feed

Format □□ (default □value□0)

Setting □ 0, proceed the subsequent block without waiting for the full speed of the spindle

Setting □ 1, proceed with the subsequent block after the spindle reaches full speed

For general cutting commands, axial feed can be performed without waiting for the full spindle speed. For threading and drilling commands, to meet the technical criteria, it may demand the spindle to reach a steady speed before performing the cutting, therefore this parameter shall be set to 1, i.e., proceed with the subsequent block after the spindle reaches full speed

Setting this parameter to 1 affects the processing efficiency. Therefore the user must consider and weigh the relationship between the technical criteria and efficiency requirements for setting a proper □value.

10. Radius or diameter programming

Format□□ (Default□0)

Setting□ 0, □-axis is radius programming.

Setting□ 1, □-axis is diameter programming.

Since general drawings indicate drills by its radius, setting this parameter to 0 may facilitate the programming process. The customer may alter this parameter according to the actual requirements, so as to enable an easy and direct way for programming.

11. Manual Tool Change Rotation Direction Setting□

Format □□ (default □value□0)

Setting □ 0, it means CW.

Setting □ 1, it means CCW.

The Turret service parameters can be based to set the rotating direction when the Turret is operated under Manual Mode.

Under Manual Mode, set this parameter to facilitate the site Tool change (e.g. for T1→T8, set as $\square 1$).

To check if the \square Point \square re \square quired for Tool change is working normally when performing the CW and CCW Tool change, you may set this parameter.

12. \square mission of decimal point in programming
Format $\square \square$ (default \square alue $\square 0$)
Setting $\square 0$, no omission of decimal point
Setting $\square 1$, decimal point omitted.

See 2.2.2.3 decimal point principles for details

13. If the Tool lifespan management function is acti \square e
Format $\square \square$ (default \square alue $\square 0$)
Setting $\square 0$, it means start.
Setting $\square 1$, it means close.

If the user sets stricter ser \square ice life for all tools used, it is suggested that this function should be acti \square ated in order to manage the tool and remind the timing for Tool change. After acti \square ating such function, the program will stop at T-Code when the Tool ser \square ice time or the count is up.

14. Metric and imperial settings
Format $\square \square$ (default \square alue $\square 0$)
Setting $\square 0$, metric system (unit \square mm)
Setting $\square 1$, imperial system (unit \square inch)

Setting of the measurement unit (1inch $\square 25.4$ mm). When Setting $\square 1$, both the coordinates and tool compensation are displayed to the 4th digit after the decimal point.

15. Whether or not executing MTS G04 at a re-start
Format $\square \square$ (default \square alue $\square 0$)
Setting $\square 0$, skip
Setting $\square 1$, execute

This setting allows the user to select whether an MST code or a G04 command existing before the re-start block shall be executed or not when

the program re-start function is enabled. The user may freely set this parameter based on actual needs.

When the parameter is set to `0`, the MTS G04 command before the re-start block will be omitted.

When the parameter is set to `1`, the MTS G04 command before the re-start block will be executed normally.

16. Whether a re-start skips M98

Format `□□` (default `value=0`)

Setting `0`, do not skip

Setting `1`, skip

An M98 command (call sub-program) prior to the re-start block will be carried out normally if this parameter is set to 0.

An M98 command (call sub-program) prior to the re-start block will not be carried out if this parameter is set to 1.

17. Whether a re-start retrieves a prior block

Format `□□` (default `value=0`)

Setting `0`, retrieve

Setting `1`, no retrieve

Set to `0`: System retrieves a prior block when the re-start button is pressed. Program goes to the block prior to the re-start block and executes the prior block and the subsequent program.

Set to `1`: System starts execution from the re-start block without retrieving the block prior to the re-start block.

18. Whether or not a smooth transit of tool-tip compensation is enabled

Format `□□` (default `value=0`)

Setting `0`, yes

Setting `1`, no

When G41, G42 function is enabled (see 3.24.2), setting this parameter to 1 will cause the tool-tip outside compensation to disable arc compensation and take a line compensation.

19. Setting for handling interference concerning G41/G42
 Format $\square\square$ (default \square value $\square 0$)
 Setting $\square 0$, issue alarm without execution
 Setting $\square 1$, automatically optimize trace to avoid interference
 Setting $\square 2$, execute without issuing an alarm

In case of interference during the tool-tip compensation command G41, G42, you may set this parameter to select the handling method. (See 3.24.2 for details of this setting)

(2) System Parameter

20. Denominator of Machine Resolution, \square -axis.
21. Numerator of Machine Resolution, \square -axis.
22. Denominator of Machine Resolution, \square -axis.
23. Numerator of Machine Resolution, \square -axis.
24. Denominator of Machine Resolution, \square -axis.
25. Numerator of Machine Resolution, \square -axis

The value of resolution numerator or denominator is set according to the specification of Axial Transmission Device (e.g. Guide Screw) and the pulse count returned by the Servo Motor. Generally speaking, the speed (Voltage) control type is set according to the pulse count returned by the Servo Motor whereas, the position (pulse) control type is set by the pulse count after the Motor rotates for one round. After being confirmed, do not attempt to adjust unless instructed.

Speed Control Type

$$\text{Resolution} = \frac{\text{Guide Screw Pitch}}{\text{Motor Encoder } \square \text{ Multiple}} \square \text{ Tooth Count Ratio}$$

Position Control Type

$$\text{Resolution} = \frac{\text{Guide Screw Pitch}}{\text{Motor 1-round Pulse Count}} \square \text{ Tooth}$$

Example 1 (Speed Control Type):

- \square -axis Guide Screw Pitch $\square 5.000\text{mm}$
- Motor Encoder $\square 2500$ pulse \square Multiple $\square 4$

Tooth Count Ratio 5:1 (5 rounds for Servo Motor, 1 round for Guide Screw)

$$\begin{aligned} \text{Resolution} &= \frac{5000}{2500 \times 4} = \frac{1}{5} \\ &= \frac{1}{10} \end{aligned}$$

-axis Resolution = Denominator Set Value = 10

-axis Resolution = Numerator Set Value = 1

Example 2 (Position Control Type):

-axis Guide Screw Pitch = 5.000mm

Motor 1-round Pulse = 10000 pulse

Tooth Count Ratio 5:1 (5 rounds for Servo Motor, 1 round for Guide Screw)

$$\begin{aligned} \text{Resolution} &= \frac{5000}{10000} = \frac{1}{5} \\ &= \frac{1}{10} \end{aligned}$$

-axis Resolution = Denominator Set Value = 10

-axis Resolution = Numerator Set Value = 1

26. Set axis traverse speed limit

Format : ##### , Unit = mm/min (Default = 10000)

Note □ The format is only for integer.

The traverse speed limit can be calculated from the following equation □

$$F_{\max} = 0.95 * \text{RPM} * \text{Pitch} * \text{GR}$$

RPM □ The ratio. rpm of Servo Motor motor

Pitch □ The pitch of the ball-screw

GR □ Gear ratio of ball-screw/motor

Ex □ Max. rpm □ 3000 rpm for -axis, Pitch □ 5 mm/re, Gear Ratio □ 5:1

$$F_{\max} = 0.95 * 3000 * 5 * 5 = 2850 \text{ mm/min}$$

27. Direction of Motor Rotation, -axis

28. Direction of Motor Rotation, -axis

29. Direction of Motor Rotation, Z-axis

Format : Z , (Default Z0)

Setting Z 0, Motor rotates in the positive direction. (CW)

Setting Z 1, Motor rotates in the negative direction. (CCW)

This MCM can be used to reverse the direction of motor rotation if desired. So you don't have to worry about the direction of rotation when installing motor. These parameters will affect the direction of HOME position

30. Z-Homing speed-1

31. Z-Homing speed-1

32. Z-Homing speed-1

Format ZZZZ (default value Z2500, unit mm/min)

In the homing process, the speed for an axial movement from the current position to the position where the origin-switch is touched.

33. Z-Homing speed-2

34. Z-Homing speed-2

35. Z-Homing speed-2

Format ZZZZ (default value Z40, unit mm/min)

The speed the feedback device searches for Grid Zero after the axial position leaves the origin-switch in the homing process.

Items requiring the attention of the user in the homing process, the machine moves toward the **origin-switch** with the first-stage speed, **the length of the origin-switch must be longer than the deceleration distance**, otherwise the machine will exceed the proximity switch and this results in a HOMING error.

The formula and an example for calculating the length of origin-switch are as follows

$$\text{Length of origin switch} \geq (\text{FDCOM} \times \text{ACC}) \div 60000$$

Note ① FDCOM Z First-stage speed of homing

② ACC Z Accelerate/decelerate time of G01

③ 60000 msec (60s □1000 □ 60000 msec)

E□□ FDC□M, First-stage speed of homing □ 3000 mm□min
 ACC, Accelerate□decelerate time □ 100 ms, then
 Minimum length of origin-switch □ (3000 □ 100) □ 60000 □ 5 mm.

36. □-Homing direction

37. □-Homing direction

38. □-Homing direction

Format □□ (default □value□0)

Setting □ 0, Tool returns to machine origin along positive direction of coordinate.

Setting □ 1, Tool returns to machine origin along negative direction of coordinate.

Set this parameter to adjust the homing direction if the user finds the homing direction is not correct.

39. The direction that Servo Motor search the Grid when □-axis going back to HOME.

40. The direction that Servo Motor search the Grid when □-axis going back to HOME.

41. The direction that Servo Motor search the Grid when □-axis going back to HOME.

Format □□□□ (default □value□0), Scope□0, 1, 128, 256.

Taking □-axis for example□

Setting □0□ Means when □-axis Motor returns to machine's Home Position (HOME), the direction for Section-2 to leave Limit Switch and for Section-3 to find zero point (GRID) will be opposite to Section 1□whereas, the direction for Section-2 to leave Limit Switch and for Section-1 to find zero point (GRID) will be the same, as per Fig. 4-11 (D)

Setting □1□ Means when □-axis Motor returns to machine's Home Position (HOME), the direction for Section-2 to leave the Limit Switch will be consistent with that for Section-1□ whereas, the direction for Section-3 to find zero-point (GRID) will be opposite to that for Section-1 and Section-2, as per Fig. 4-11 (C).

Setting #128# Means when X-axis Motor returns to machine's Home Position (H#ME), the direction for Section-2 to leave the Limit Switch will be opposite to that for Section-1—in the meantime, the direction for Section-3 to find GRID will also be opposite that for Section-2 to leave the Limit Switch, as per Fig. 4-11 (B).

Setting #256# Means when X-axis Motor returns to machine's Home Position (H#ME), the directions for Section 1, Section-2 and Section-3 will all be the same, as per Fig. 4-11 (A).

The speed for returning to H#ME will be divided into the following 3 sections (as per Fig. 4-11)#

Section-1 Speed#Set in #H#ME Return Speed 1#system parameter and the direction will be set in #H#ME Return Direction#

Section-2 Speed#When the speed of Section 1 is reduced to #0#, the speed of Section 2 will be set as 1/4 of that for Section 1—and its direction will be determined according to the #value contained in the system parameter of #Encoder Find #ero Direction#

Section-3 Speed#Used for finding the speed of #ero-point (GRID) for Feedback Device, which will be set by the System Parameter of #H#ME Return Speed 2#—its direction will be determined according to the #value contained in the system parameter of #Encoder Find #ero Direction#

The customer must notice that when returning to H#ME, the machine will move towards the **Limit Switch** with Section-1 speed and the length of said **Limit Switch must be longer than the deceleration distance**; otherwise, the machine will overshoot the Limit Switch and generate incorrect H#ME-returning phenomenon.

Listed below is the example explaining Limit Switch length calculation formula and calculation method#

Limit Switch Length \geq (FDCOM \times ACC) \div 60000

Note#① FDC#M # Section-1 speed for returning to H#ME.

② ACC # G01 acceleration#deceleration time

③ 60000 msec (60 sec □1000 □ 60000 msec)

Example □FDC □M H □ME-returning Section-1 speed □3000mm □min
 ACC plus DECL time □ 100ms, then,
 Limit Switch min. length □ (3000 □ 100) □ 60000 □ 5 mm

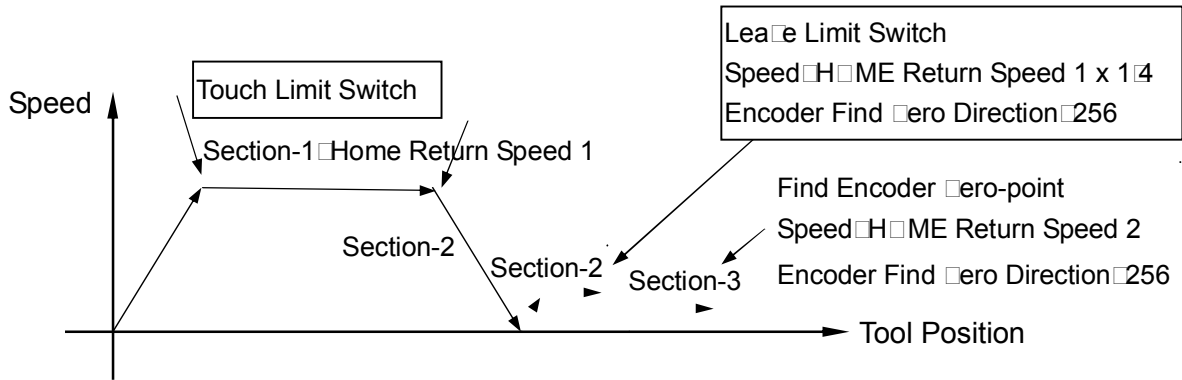

Fig. 4-11 (A) □H □ME Return Speed and Find □ero (GRID) Direction

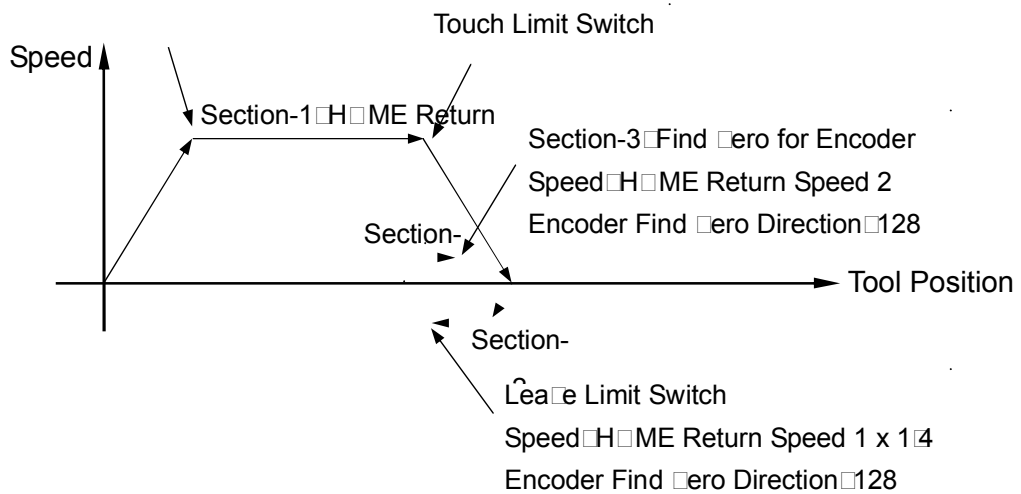

Fig. 4-11 (B) □Machine H □ME Return Speed and Find □ero (GRID) Direction

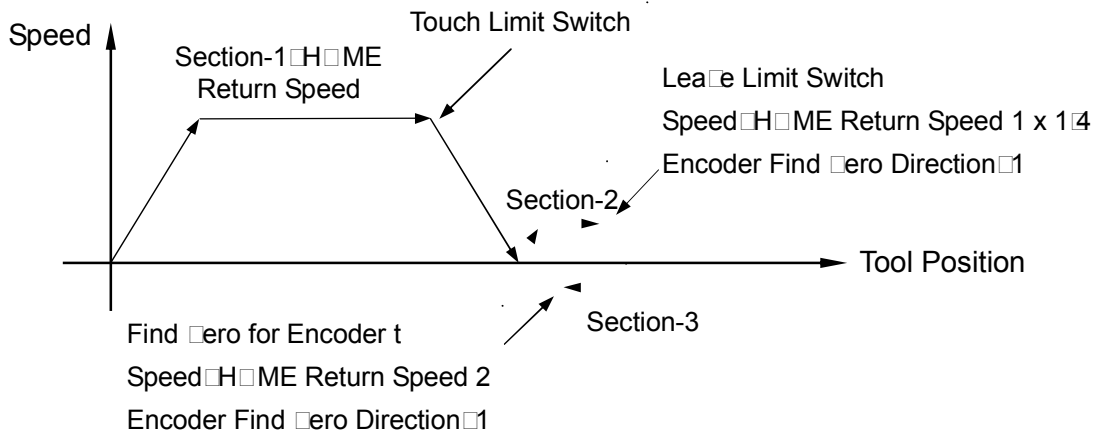

Fig. 4-11 (C) Machine H0ME Return Speed and Find Zero (GRID) Direction

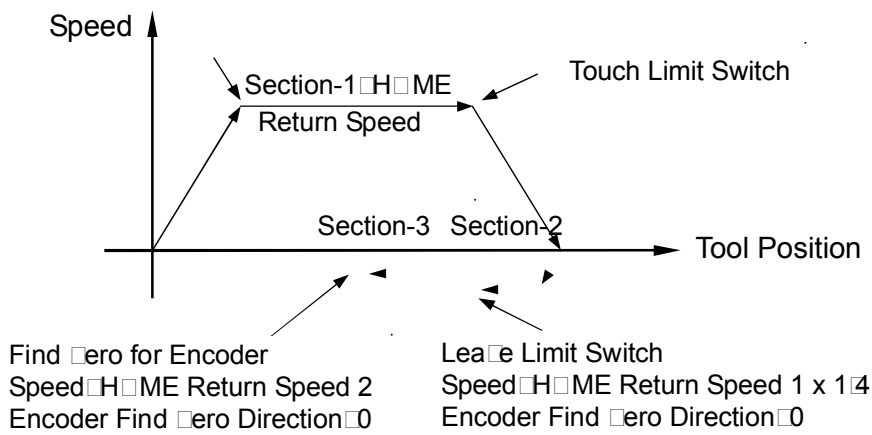

Fig. 4-11 (D) Machine H0ME Return Speed and Find Zero (GRID) Direction

- 42. X-axis Encoder Find Zero-Point Max. Distance
- 43. Y-axis Encoder Find Zero-Point Max. Distance
- 44. Z-axis Encoder Find Zero-Point Max. Distance

Format:##### (default Value:1000.000 Unit:mm)

Scope:0~9999.999mm

Max. distance limit for Servo Motor to find the Grid signal.

Example: If the distance after X-axis Servo Motor turns for 34 round is 5.000mm, then Parameter 42 will be 5.200.

Note: If the Servo Motor fails to find out the Grid point after exceeding the set scope, then the system will display “ERR 15” alarm message.

- 45. Software ZT Limit in (Z) Direction, X-axis.

- 46. Software ZT Limit in (+) Direction, X-axis.
- 47. Software ZT Limit in (+) Direction, X-axis.
Format : 0000000 , Unit:mm/min (Default:9999.999)

Set the software over-travel (ZT) limit in the positive (+) direction, the setting value is equal to the distance from positive ZT location to the machine origin (HOME).

- 48. Software ZT Limit in (-) Direction, X-axis.
- 49. Software ZT Limit in (-) Direction, X-axis.
- 50. Software ZT Limit in (-) Direction, X-axis.
Format : 0000.000 , Unit:mm/min (Default:-9999.999)

Set the software over-travel (ZT) limit in the negative (-) direction, the setting value is equal to the distance from negative ZT location to the machine origin (HOME).

Travel Limit Concept and Description:

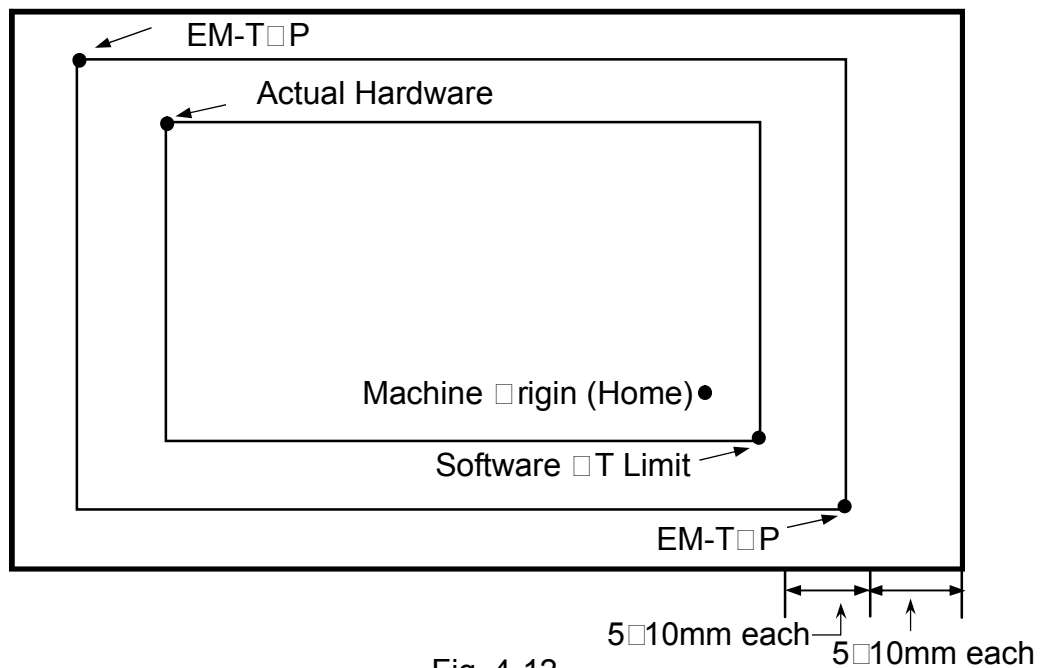

Fig. 4-12

Note: The software travel limit setting point is approx. 5~10mm to EM-TOP.

- 51. X-axis Denominator, MPG Hand-wheel Resolution Adjustment. (pulse)

- 52. X-axis Numerator, MPG Hand-wheel Resolution Adjustment. (μm)
 - 53. X-axis Denominator,MPG Hand-wheel Resolution Adjustment. (pulse)
 - 54. Y-axis Numerator, MPG Hand-wheel Resolution Adjustment. (μm)
 - 55. Y-axis Denominator,MPG Hand-wheel Resolution Adjustment. (pulse)
 - 56. Z-axis Numerator, MPG Hand-wheel Resolution Adjustment. (μm)
- Format : □□□□ , (Default □ 100)

Example □ If Item 51 Parameter □ 100 □ Item 52 Parameter □ 100 □ and Hand Wheel Multiple is 100 □ , then,
 Hand Wheel moving for 1 frame □ 100 Pulse
 and X-axis Feed Distance □ 100x (100 □ 100) □ 0.1mm

- 57. Max. Value of U, W tool compensation can be entered during the operation
 Format □ □.□□□ (default Value □ 2.000, Max. Value is 2.000, unit □ mm)

Alteration of tool compensation data during the operation can only be made with incremental method. This parameter is used to set a maximum Value for preventing tool collision.

Setting Value □ 0.000, denotes no alteration of tool compensation data during the operation.

- 58. Pitch Error Compensation Mode Setting, X-axis.
 - 59. Pitch Error Compensation Mode Setting, Y-axis.
 - 60. Pitch Error Compensation Mode Setting, Z-axis.
- Format □ , Default □ 0

Setting □ 0, Compensation canceled.

Setting □ -1, Negative side of compensation.

Setting □ 1, Positive side of compensation.

Note □ The screw offsetting will be allowed only one direction at a time.

X-axis	Y-axis	Z-axis	Explanation
0	0	0	Compensation cancel
-1	-1	-1	Do compensation when tool is on the (-) side of the reference point
1	1	1	Do compensation when tool is on the (+) side of the reference point.

- 61. Segment Length for Pitch Error Compensation, X-axis

- 62. Segment Length for Pitch Error Compensation, X-axis
- 63. Segment Length for Pitch Error Compensation, X-axis
Format□□□□□.□□□, Default□0, Unit□mm

Note:

- The offset value of each section will be entered by pressing [Screw Offset] soft key, and at most 40 sections will be allowed (as per Fig. 4-8, 4-9, 4-10).
- The length setting scope of each section for offsetting the error of screw pitch will be 20□480mm.
- When the setting of offset length is below 20mm, then the length shall be set at 20mm.
- The offset setting means the **incremental value**, which can be expressed either in positive or negative manner. If the offset section count is less than 40 sections, then the parameter of the remaining sections must be set at zero (0).

Example□Assuming the total length of the X-axis screw is 1m (1000mm), and where it will be divided into 10 sections for offsetting□

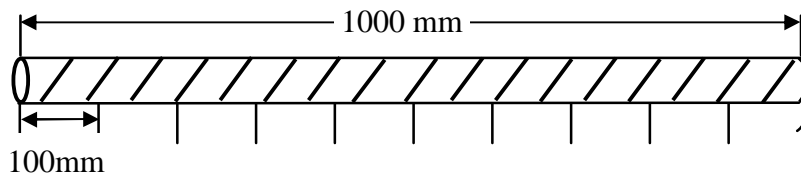

Fig. 4-13

Therefore, the average length of each section is 100mm. It means that the set value of X-axis Screw Pitch Error Offset per Distance Section is □ □ 100.000□in which, the offset of each section is set by parameter items (as per Fig. 4-8, Section 01□10) and Section 11□40 must be set as zero.

- 64. Spindle type (Re-start enabled)
Format □ □ (default value□0)
Setting □ 0, Voltage type spindle
Setting □ 1, Pulse type spindle

User may make corresponding settings according to the actual control of spindle.

- 65. Set Loop Open/Close Control Method (Restart a□ail)
Format □ □ (default value□0)

Setting 0 Spindle open loop control.

Setting 1 Spindle closed loop control (Spindle alignment control).

For the Spindle of Inverter, such parameter shall be set as 0.

For the Spindle of Voltage-type Servo Motor, such parameter can be set according to the wiring method (see 5-15, 5-16).

For the Spindle of Pulse-type Servo Motor, such parameter would be meaningless.

66. Set Spindle Acceleration/Deceleration Time

Format 0000 (default value 100, using ms as the unit).

Setting Scope 2 3000 ms.

Such parameter must be set according to actual characteristics of the machine, and it can be observed through manual Spindle starting and stopping. The said parameter shall be measured to see if it is appropriately set according to the indicators such as if the Spindle is smooth during starting and if it can stop stably during the stopping process.

Note Described below is the setting of acceleration/deceleration time, which must be executed according to the actual characteristics of the machine. After modifying the parameter, it is also necessary to observe if the operating mechanism is working stably and smoothly during the starting and stopping process. As for the Spindle of the Inverter, because the Spindle acceleration/deceleration time is adjusted by the Inverter, so it is needed to set such parameter at the minimum value, i.e. 2.

67. Setting of spindle speed at 10V Voltage

Format 0000 (default value 3000, unit RPM)

For a variable-speed spindle, this parameter is used to adjust the linear relationship between the spindle rpm and the Voltage.

68. Setting of rotation direction of spindle

Format 0 (default value 0)

Setting 0, for positive rotation

Setting 1, for negative rotation

69. Set Manual Spindle Speed

Format □□□□ (default □alue□10, using □RPM□as the unit).

Such parameter can be used to set the Spindle □ogging speed under Manual Mode.

70. Setting of searching for GRID point

Format □□ (default □alue□0)

Setting □ 0, search for GRID point (encoder signal in □-phase)

Setting □ 1, no search for GRID point (encoder signal in □-phase)

For a □oltage type open-circuit spindle, the motor needs not to search for the GRID point (encoder signal in □-phase)□for pulse type spindle and □oltage type closed-circuit spindle, this parameter can be set according to actual needs.

71. Setting of rotation direction of spindle for search of GRID point

Format □□ (default □alue□0)

Setting □ 0, Positi□e rotating direction

Setting □ 1, Negati□e rotating direction

Use this parameter to set the rotation direction of motor for search of GRID point (encoder signal in □-phase).

72. Setting of spindle rpm for search of GRID point

Format □□□□ (default □alue□1), unit□RPM

Use this parameter to set rotation speed of motor for search of GRID point (encoder signal in □-phase)

73. Setting of spindle orientation

Format □□ (default □alue□0)

Setting □ 0, Positi□e rotating direction for spindle orientation

Setting □ 1, Negati□e rotating direction for spindle orientation

Use this parameter to set the rotating direction for spindle orientation in manual mode.

74. Setting of rotation speed of spindle orientation

Format □□□□ (default □alue□1), Unit□RPM

Use this parameter to set rotation speed for spindle orientation in manual mode.

75. Set if to find the Spindle H□ME signal

Format□□(default □alue□0).

Setting □ 0□□uit finding Spindle H□ME Switch signal

Setting □ 1□Find Spindle H□ME Switch signal

When setting the parameter as □1□, it means the finding of External H□ME Switch signal of the Spindle is re□ired. In this case, please install the External H□ME Switch.

76. Set to find the speed of Spindle H□ME signal

Format□□□□ (default □alue□0, using □RPM□Min□as the unit).

Set the RPM of Spindle when finding the external H□ME Switch.

77. Setting of spindle origin offset

Format □□□□.□□ (default □alue□0)

Set □alue of de□iation of spindle origin

In case the position of machine origin when the spindle is assembled de□iates from the ideal position to the customer, this parameter may be used for ad□ustment.

78. Setting of number of spindle feedback pulses

Format □□□□□□□□ (default □alue□4096)

Sets number of feedback pulses per re□olution of spindle based on the number of spindle encoding lines.

79. Setting of number of pulses in the spindle command

Format □□□□□□□□ (default □alue□4096)

Sets number of pulses to be generated by controller when spindle turns one re□olution.

E01 For a servo spindle with a gear mechanism having a gear ratio of 3/4, i.e., spindle rotates 4 turns when motor rotates 3 turns, the servo spindle rotates 1 turn when receiving a pulse command of 10000.

In the above example, spindle rotates 1 turn when the spindle motor rotates 0.75 turns, meaning that the controller only needs to send out 7500 pulses for the spindle to rotate 1 turn. Therefore, the parameter shall be set to 7500 instead of 10000. Since the servo spindle encoder is installed at the electric machinery end, therefore the number of pulses in the spindle feedback shall also be set to 7500. For the above conditions, suppose the encoder is installed at the spindle end instead of the electric machine end, and the encoder is of 1024 lines, then the number of pulses in the spindle feedback shall be set to 4096 (4×1024).

80. Setting of number of tools
Format (default value=0)

Used in combination with powered turret, maximum 10 tools.

81. Set up the Turret type by the actual condition of the machine
Format (default value=0).
Setting 0 Tool Row
Setting 1 Electrical Turret
Setting 2 Hydraulic Turret
Setting 3 Electrical Turret 2

82. Setting of Tool positioning delay
Format (default value=10, unit=10 ms)
Default setting is 10, i.e., 100 ms.

In the event of miss-positioned tool change, properly increase this parameter setting and observe if the tool change is better positioned.

83. Tool Change monitoring time setting
Format (default value=200, using 10ms as the unit).
Such parameter is used to monitor the time consumed during the entire Tool change process. If the actual Tool change time exceeds the set value of such parameter, then the screen will indicate Tool Change overdue

alarm signal. To remove the alarm, please refer to the function alarm described in Chapter 6.

84. Setting of wear direction

Format `G1` (default value 1, positive)

Setting 0, negative direction

Setting 1, positive direction

User may make adjustment according the used direction for making compensation for the wear.

85. Setting of maximum value of tool compensation

Format `G10` (default value 2.000 maximum value is 20.000, unit mm)

This setting is used for setting an upper limit for the tool compensation when the program is not in execution. In case exceeding the upper limit, an alarm "protection limit exceeded" will be issued.

86. Setting of lubrication interval

Format `G10` (default value 1800, unit s)

87. Setting of lubrication duration

Format `G10` (default value 1000, unit ms)

88. Set the maximum rpm at which the chuck can be moved

Format `G10` (default value 100, unit rpm)

Range (0-500rpm)

E

A subsequent block to an M05 (Spindle Stop) command is M10 (chuck loosen) command in the program if this parameter is set as 100, the chuck can be loosened when the spindle decelerates to 100rpm if the parameter is set as 0, the chuck can only be loosened until the spindle comes to a full stop.

For a lathe furnished with an automatic material dispenser, adjusting this parameter may increase the process efficiency.

89. Whether or not to enable the screen saver

Format □ □ (default □ value □ 0)

Setting □ 0, enable

Setting □ 1, disable

When screen saver is enabled, the screen automatically enters sleep mode when the controller remains untouched for 10 minutes, for prolonging lifespan of the screen. Pressing any key will resume the display.

90. Set the type of Chuck Disc according to the actual conditions of the machine

Format □ □ (default □ value □ 0)

Setting □ 0 □ Hydraulic Chuck Disc

Setting □ 1 □ Ordinary Chuck Disc

91. If to start □ axis

Format □ □ (default □ value □ 0)

Setting □ 0 □ No start

Setting □ 1 □ Start

92. If to start Multi-function Hand Wheel

Format □ □ (default □ value □ 0)

Setting □ 0 □ No start

Setting □ 1 □ Start

When setting as □ 1 □ for starting the Multi-function Hand Wheel, the adjustment of Hand Wheel multiple and the selection of axis will be determined by pressing the Multi-function Hand Wheel multiple selection and axis selection key.

93. Retention

94. Setting of Default feed mode at start-up

Format □ □ (default □ value □ 0)

Setting □ 0, feed per revolution (G99).

Setting □ 1, feed per minute (G98).

If G98 is the default mode, decimal point is not allowed in the F □ value. If F □ value is set for pitch, add 3 □ 0 □ to the end, (Input of F500 indicating the pitch □ value is 0.5 mm).

If G99 is the default mode, decimal point is allowed behind F.

95. Setting of tool support type
Format □□ (default □value□0)
Setting □ 0, rear support
Setting □ 1, front support

User may set according to actual tool position. See description of pair-tools for details about front and rear tool supports.

96. Setting of type of pulse type
Format □□ (default □value□0)
Setting □ 0, pulse □ direction
Setting □ 1, positive/negative pulse
Setting □ 2, A/B phase

Setting of this parameter requires setting of servo parameters, for matching with pulse type generated by the pulse generator.

Suggest that the user shall set this parameter to □2, A/B phase□

97. Setting of acceleration/deceleration type
Format □□ (default □value□1)
Setting □ 0, logarithm type
Setting □ 1, linear type
Setting □ 2, S-curve type

If no special requirement is raised for acceleration/deceleration, it is suggested to set this parameter to □1□

98. Setting of G01 acceleration/deceleration time constant
Format □□□□□□ (default □value□100, unit□milli-second (ms))
Setting range□2□3000 ms.

99. Setting of G00 acceleration/deceleration time constant
Format □□□□□□ (default □value□100, unit□milli-second (ms))
Setting range□2□3000 ms

100. Setting of G99 acceleration/deceleration time constant
Format □□□□□□ (default □value□100, unit□ms)

Setting range 2-3000 ms, suggest to set both G00 and G99 to 100.

101. Setting of MPG acceleration/deceleration time

Format □□□□□□ (default value 64, unit ms)

Setting range 2-3000 ms.

Setting of motor acceleration/deceleration time in handwheel mode, suggested setting value is 150.

102. Retention

103. Setting of spindle voltage zero correction value

Format □□.□□□ (default value 0, unit mV)

Range -99.999-99.999

Adjusts spindle voltage zero (effective in open-circuit).

If system output is about -0.1V at system speed S0, then voltage zero parameter (□) is 20 ($0.1V \div 5 * 10V \div 2048$). Adjust output voltage to be as close to 0V as possible at system speed S0. This parameter is normally set to 21.

For adjusting spindle speed by inverter

- a. First adjust this parameter so that output voltage is closest to 0V when the rpm is zero.
- b. Adjust the system parameter Spindle RPM at 10V in the controller end screen to a rational value, so that the linear alteration of spindle speed meets the site requirements.

The above operation is for providing the user with a general method. For the substantial inverter, the user may use these parameters freely to adjust the speed.

104. Setting of handwheel direction

Format □□ (default value 0)

Setting 0, □□, □□.

Setting 1, □-, □□.

Setting 4, □□, □-.

Setting 5, □-, □-.

If the handwheel has a wrong direction after connecting the wires, use may alter the direction by setting this parameter.

105. Set Spindle Count

Format □ □ (default □value□1 □Max. □value□3)

Spindle 1 → C-A□IS Connector

Spindle 2 → A-A□IS Connector

Spindle 3 → B-A□IS Connector

106. If to insert space in the displayed Node

Format □ □ (default □value□0)

Setting □ 0□□es

Setting □ 1□No

Example□In the editing program under N10 line number, the Spindle performs CW rotation at 1000 RPM per minute. If setting this parameter as □0□ then □N10 M03 S1000□will be displayed, with space between the line number and the respective command code□

If setting as □1□ then □N10M03S1000□will be displayed, without space between the line number and the respective command code□

107. Axis setting for returning to H□ME

Format □ □ (default □value□0)

Bit0-----□-Axis □ 0□No H□ME return□1□H□ME return

Bit1-----□-Axis □ 0□No H□ME return□1□H□ME return

Bit2-----□-Axis □ 0□No H□ME return□1□H□ME return

For example□

Setting □ 0□E□ery axis will not return to H□ME.

Setting □ 1□□-Axis is returning to H□ME.

Setting □ 4□□-Axis is returning to H□ME.

Setting □ 5□□□-Axis is returning to H□ME.

108. Retention

109. Sensiti□ity of spindle RPM sensor

Format □ □ □ □ (default □value□1)

The spindle feedback filter is constant when executing an arc cutting in the G99 mode

For a setting $\square 0$, filter is not active. System performs a re-calculation immediately as long as a change occurs in the number of spindle feedback pulses.

For a setting $\square n$, system performs a re-calculation only when the number of feedback pulses exceeds n .

110. Setting for enabling detection against error follow

Format $\square \square$ (default value $\square 0$)

Setting $\square 0$, disable

Setting $\square 1$, enable

For pulse type motors, this function shall be enabled to detect servo motor follow error however the error limit shall be set according to machine conditions. Enabling this function can effectively protect the machine against over-travel resulting from a servo error.

111. Setting of follow error

Format $\square \square \square \square \square \square \square \square$ (default value $\square 4095$)

A Follow Error is defined as the difference between the position of the controller command and the position of the actual servo motor feedback. Servo follow error \square setting value, an ERROR 02 alarm will be issued.

112. Signal Filtration Parameter Setting

Format $\square \square \square \square$ (default value $\square 8$, using $\square \text{ms}$ as the unit)

Example If setting this parameter as $\square 8$, then the I-Point signal with continuous time less than 8ms will not respond. Such parameter is mainly used to resist the noise interference.

For the Electrical Turret or Hydraulic Turret, it is preferably to set the parameter as $\square 2$ in order to assure that the system can quickly respond to the I signal of the Turret.

113. Enabling special acceleration/deceleration form

Format □□ (default □alue□0)

Setting □ 0, disable

Setting □ 1, enable

Enabling the special acceleration□deceleration form allows further enhancement in the acceleration□deceleration efficiency based on the linear type, s-cur□e type and exponential type acceleration□deceleration cur□es, therefore ele□ating the execution efficiency.

In case the user finds that the efficiency of the machine is not enough during the process, he may reach his aim by disabling parameters such as □wait for spindle to reach full speed before performing axial feed□and □Enabling special acceleration□deceleration form□.

114. Turning Corner Round Angle Connection

Format □□□□ (default □alue□0)

0 □ Set the Ser□o Motor acceleration□deceleration type to CNC standard mode.

256 □ Set the round angle connection between each Node.

115. Electrical Maga□ine CCW Delay (10ms)

Format □□□□□ (default □alue□100, using □10ms□as the unit)

It is used to set the time delay re□uired for locking the CCW action of the Electrical Maga□ine.

116. Spindle 1 Chuck 1-Way□2-Way Solenoid Val□e

Format □□ (default □alue□0)

0 □ 1-Way Solenoid Val□e

In this case, the Spindle Chuck action is controlled by □09 independently.

1 □ 2-way Solenoid Val□e

In this case, the Spindle Chuck action is □ointly controlled by □09 and □05.

117. Hand Wheel Test Feed Rate Numerator

118. Hand Wheel Test Feed Rate Denominator

Format □□□□□□□ (default □alue□100)

It is used to ad□ust the fast□slow program feed rate when testing the Hand Wheel.

* **Parameter for switching the Spindle back to standard axis**

119. Set the Rotation Direction

Format $\square\square$ (default \square value \square 0)

Setting \square 0 \square Forward direction

Setting \square 1 \square Re \square erse direction

120. Set the Acceleration/Deceleration Time

Format $\square\square\square\square$ (default \square value \square 100, using \square ms \square as the unit)

Setting Scope \square 4 \square 3000 ms

121. Maximum feed speed

Format $\square\square\square\square\square$ (default \square value \square 10000, unit \square mm \square min)

Note \square Setting \square value shall be an integer (without a decimal point).

E.g. \square Setting \square 5000, indicates a maximum \square -axis feed rate of 5000mm per minute.

Limit of max. feed speed is calculated as follows \square

$$F_{\max} = \underline{0.95} \square \text{Axial ser}\square\text{omotor max. speed} \square \text{axial pitch} \square \text{gear ratio}$$

E $\square\square$ \square -axis ser \square omotor max. speed is 3000 rpm, guide screw is 5 mm, gear ratio is 5 : 1 (ser \square omotor turns 5 re \square olutions, guide screw turns 1 re \square olution)

$$F_{\max} = 0.95 \square 3000 \square 5 \square 5 = 2850. \text{ Recommended setting is 2850.}$$

122. Set Spindle Encoder Multiple

Format $\square\square$ (default \square value \square 4)

Setting \square 1 \square Means feedback signal multiplied by 1.

Setting \square 2 \square Means feedback signal multiplied by 2.

Setting \square 4 \square Means feedback signal multiplied by 4.

\square only one of the said three \square values can be selected.

123. Spindle feedback direction

Format $\square\square$ (default \square value \square 0)

Setting \square 0, feedback in positi \square e direction

Setting \square 1, feedback in negati \square e direction

In case the spindle speed indication displays normal but spindle position displays abnormal, try to alter this parameter from 0 to 1, see if the position becomes accurate.

124. Set Resolution Denominator

Format □□□□□□ (default value 4096)

125. Set Resolution Numerator

Format □□□□□□ (default value 36000)

Example

Assuming C-axis is the rotating axis and the angle when rotating for one round is 360.00 degrees.

Motor Encoder □ 1024 Pulse in multiple □4, and the Spindle feedback pulse count must be set as □4096□

Tooth Count Ratio□5□1 (Every 5 rounds of Servo Motor rotation will drive C-axis to rotate for 1 round).

$$\text{Resolution} = \frac{36000}{1024 \times 4} = \frac{1}{5}$$

$$= \frac{36000}{4096}$$

C-axis Resolution Denominator Set Value □ 4096

C-axis Resolution Numerator Set Value □ 36000

126. Spindle Feedback Filtration Frequency Setting

Format □□ (default value 0)

Setting □ 0 □ Filtration frequency is 500 □Hz

Setting □ 1 □ Filtration frequency is 750 □Hz

Setting □ 2 □ Filtration frequency is 1000 □Hz

Setting □ 3 □ Filtration frequency is 342 □Hz

When setting the corresponding feedback filtration frequency according to the Spindle Encoder setting, the System will be able to prevent the noise interference effectively.

Example □ If setting the parameter as □3□ and Spindle Encoder as □1024□ with 4 times multiple, then the Spindle can reach 5000 RPM of maximum speed. Note □342□□4*1024*5000 (RPM)□60 sec

If setting Spindle Encoder as 2500 and requiring the Spindle to reach 3000 RPM of maximum speed, then such parameter must be set as 0 i.e. 500 Hz. In this case, $500 \text{ Hz} = 1 \times 2500 \times 3000 / 60$.

The customer can set such parameter at moderate value according to the Spindle Encoder installed for the machine and the required maximum Spindle speed.

127. Retention.

128. Set G01 Tooth Gap Offset

Format $\square.\square\square\square$ (default value 0, using mm as the unit)

Scope $-9.999 \sim 9.999$ mm, which can be used to remove the reverse gap of the stud.

When performing reverse action, certain gaps may exist in the stud. In this case, such parameter can be used to make correction.

129. Axis Feedback Direction Setting

Format \square (default value 0)

Setting 0, means the forward feedback direction.

Setting 1, means the reverse feedback direction.

It is mainly used to set the feedback direction of $\square\square\square$ axes in order to save the trouble of line change.

Note If the axis rotation direction is set at 1, it is necessary to change such parameter as 1 to avoid confusing the feedback signal.

130. Feedback Filtration Frequency Setting

Format \square (default value 0)

Setting 0, means the Filtration Frequency is 500 Hz

Setting 1, means the Filtration Frequency is 750 Hz

Setting 2, means the Filtration Frequency is 1000 Hz

Setting 3, means the Filtration Frequency is 342 Hz

When setting the appropriate feedback filtration frequency according to $\square\square\square$ axis Encoder, the System will be able to prevent the noise interference effectively. For detailed content, please refer to the parameter description under Item 123.

131. Setting of pulse-width command (2.5 M \dot{n} or 2500 \dot{n})

Format $\square\square$ (default \square value \square 5)

E \square : Setting \square 5, speed of pulse command is 500 \square PPS (2500 \square 5)

Setting \square 4, speed of pulse command is 625 \square PPS (2500 \square 4)

132. Axis Manual Speed (mm \dot{m} in)

Format $\square\square\square\square\square\square$ (default \square value \square 1000 mm \dot{m} in)

The parameter is used to set the speed for dri \dot{v} ing the axis when operated under Manual Mode.

133. 130 \dot{m} -axis find Grid Front De \dot{v} iation Length

134. 131 \dot{m} -axis find Grid Front De \dot{v} iation Length

135. 132 \dot{m} -axis find Grid Front De \dot{v} iation Length

Format $\square\square\square\square\square\square$ (default \square value \square 0, using \dot{m} mm \dot{m} as the unit)

Scope \square 9999.999 \square 9999.999mm

If de \dot{v} iation fre \dot{q} uently happens to the position before and after the H \dot{O} ME returning during the returning process and where the de \dot{v} iation length e \dot{q} uals to the tra \dot{v} el of one-round Ser \dot{v} o Motor rotation, then such parameter can be ad \dot{u} sted to sol \dot{v} e the aforesaid problem. In this case, the set \square value will be 0-0.5x of the tra \dot{v} el of one-round Ser \dot{v} o Motor rotation.

136. Arc Closed Angle Forward \dot{O} ffset (Pulse)

137. Arc Closed Angle Re \dot{v} erse \dot{O} ffset (Pulse)

138. Arc Closed Angle \dot{O} ffset Time (ms)

139. Arc Closed Angle \dot{O} ffset Function (0 \dot{O} Close \dot{O} 1 \dot{O} pen)

During the true roundness cutting process, the Motor used to present hysteresis phenomenon when making re \dot{v} erse action on the machine due to the mechanical factors. Such phenomenon used to happen to the round hole cutting for G02 or G03 or the 0 \dot{O} , 90 \dot{O} , 180 \dot{O} and 270 \dot{O} Closed Angle phenomenon on the cutting surface of the Workpiece during round hole or cylindrical cutting for G02 or G03.

To offset the Closed Angle, the Controller will type out all the offset \square values instantly after changing the direction (within one offset cycle) and then compensate such offset \square value with straight-line acceleration \dot{O} deceleration

curve. The said offset level and time constant will be determined by the aforesaid three sets of parameters.

Forward Offset Value—Execute the offset when the axis returns from the reverse action for moving towards the forward direction.

Reverse Offset Value—Execute the offset when the axis returns from the forward action for moving towards the reverse direction.

Offset Time—The Controller will send out all of the offset values within the set offset time. When setting such parameter at zero, the system will compensate the said offset within one acceleration/deceleration cycle.

The Arc Closed Angle offset function (0—Close—1—Open) is used to control the availability of the aforesaid parameters.

140. G92 Thread Tail Retreating Acceleration/Deceleration Time (ms)

Format `#####` (default value=100)

When the thread reaches the end point under the command of G92, such parameter is used to set the acceleration/deceleration time when X, Y axes are making fast thread tail retreating.

141. Whether or not to return to origin after E-Stop

Format `#####` (default value=0)

0—Yes, Returning to origin after E-Stop is necessary for activating the process.

1—No. Returning to origin after E-Stop is not necessary for activating the process.

142. If to stop the Spindle after ending the program

Format `#####` (default value=0)

0—No

1—Yes

After activating the Spindle, if the working program does not execute the Spindle stop command before completing the program running, then such parameter can be used to stop the Spindle.

The customer can execute appropriate setting for such parameters according to the operation habitude.

143. If to start Auto Program

Format (default value 0)

0 No

1 Yes

Such parameter is used to start the Semi-Auto/Auto function.

When setting at 0, the system will close the Semi-Auto/Auto function.

When setting at 1, the system will open the Semi-Auto/Auto function.

Semi-Auto Function The program will end the working when receiving M02 or M30.

Auto Function The program will not end the working when receiving M02 or M30 and will continue the loop to run the program.

144. Yellow Lamp means Pause or Finish

Format (default value 0)

0 Yellow lamp means the Pause reminding signal.

1 Yellow lamp means the Finish reminding signal.

2 Yellow lamp means the Finish as well as the Pause reminding signal.

145. Spindle-specific RPM when starting

Format (default value 100)

Such parameter is used to set the Spindle-specific RPM when starting the machine and when activating the Spindle manually or by M-Code before giving the S RPM command.

146. G01/G02/G03 for round-angle connection

Format (default value 2)

0 Precision positioning without handling between G01/G02/G03 blocks

1 Round-angle connection between G02/G03 blocks only

2 Round-angle connection between G01/G02/G03 blocks

User may set proper parameter values according to technical criteria of the substantial product.

147. If to disconnect the power when receiving the Servo Motor alarm

Format (default value 0)

0 No need to disconnect the power of Servo Motor.

1 Need to disconnect the power of Servo Motor.

When the Servo Motor sends off an alarm, depending of varied requirements of the customer, the system can be set to disconnect the Main Circuit power of the Servo Motor and to retain the control power only. After removing the alarm, restore the Main Circuit power again.

If setting such parameter at 1 and when it is required to disconnect the Servo Motor power, then the 05 signal will be the Servo Motor Control NFF signal.

If 05 is under FF status when the Servo Motor sends off alarm, it means the main power of such Servo Motor will be disconnected.

If 05 is under N status when the Servo Motor is working normally, it means the main power of such Servo Motor will not be disconnected.

Notice If setting the parameter at 1 then the 2-Way Solenoid Valve cannot be selected for the Chuck of Spindle 1. If setting the parameter at 0 then the Spindle Chuck type can be set through the Spindle Chuck 1-Way2-Way Solenoid Valveparameter.

5 CONNECTIONS

5.1 System Configuration Descriptions

H4D-T Controller wiring schematic

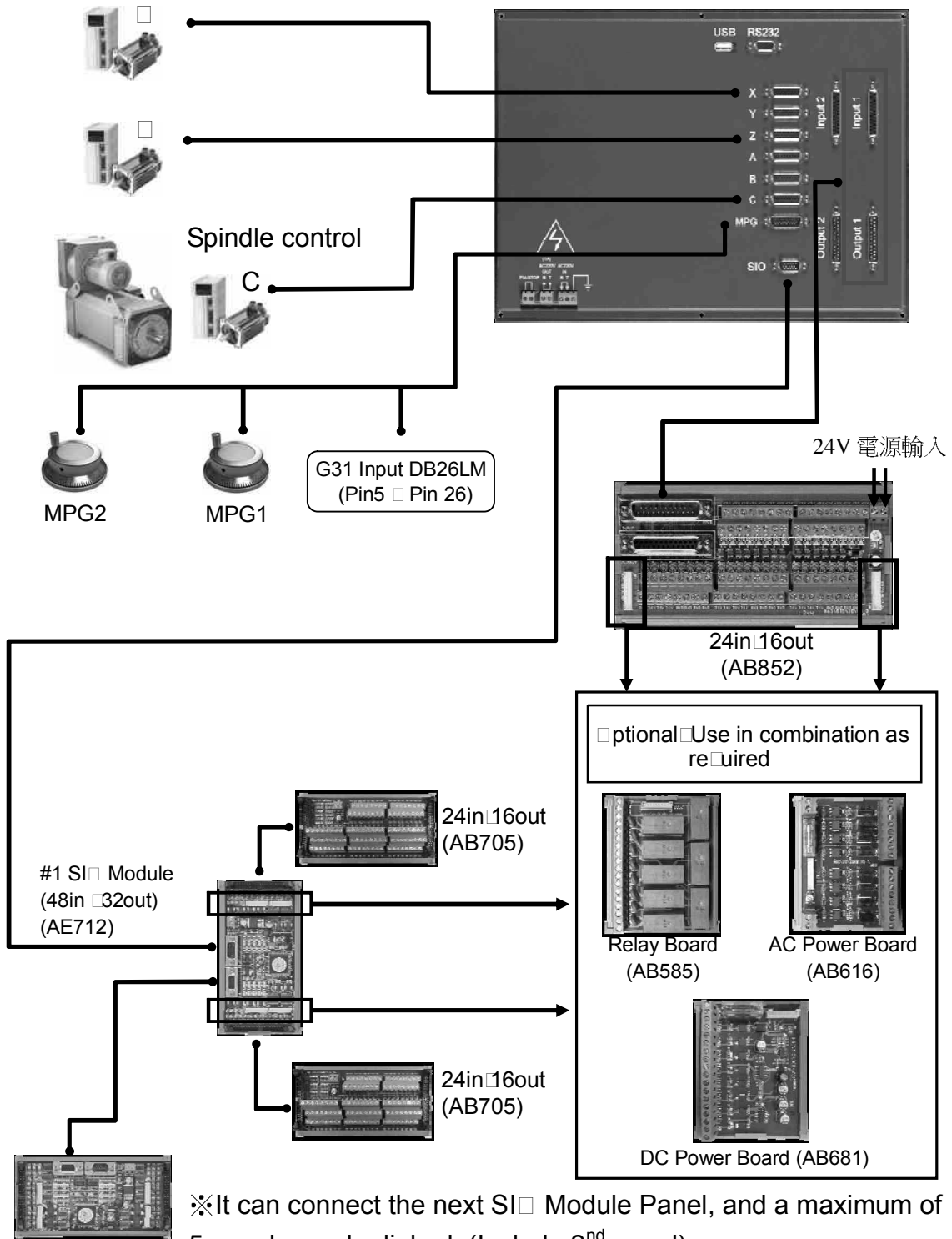

Fig.5-1

5.2 System installation

5.2.1 Operating Environment

H4D-T Serial Controllers must be used in the following surroundings— anomaly may occur if the specified range is exceeded.

- * Temperature of surroundings
 - Operation — 0°C to 45°C.
 - Storage or transfer — -20°C to 55°C.

- * Rate of temperature variation — Max. 1.1°C/min

- * Relative Humidity
 - Normal — 80% RH
 - Short period — Max. 95% RH

- * Vibration limits
 - In operation — 0.075 mm max. at 5 Hz

- * Noise
 - In operation — Max. voltage pulse in 0.01 S
 - 2000 V(0.1-10⁻⁶ S)

- * Other

Please consult our company for operations with a high amount of dust, cutting fluid or organic solvent.

5.2.2 Considerations for the design of control panel

- * The controller and auxiliary panels shall be of a totally enclosed type to prevent dust ingress.
- * The internal temperature shall not exceed the surrounding temperature by more than 10°C.
- * Cable entries shall be sealed.
- * To prevent noise inference, a net clearance of 100mm shall be kept between the cables of each unit, AC power supply and CRT. If magnetic fields exist, a net clearance of 300mm shall be kept.
- * Refer to Servicer Operation Manual for the installation of servo driver.

5.2.3 Internal temperature design

The internal temperature shall not exceed the surrounding temperature by more than 10°C. The main considerations for designing the cabin are the heat source and the heat dissipation area. For the controller, the customer is usually unable to control the heat source, however the heat dissipation area is a key factor to be considered. The internal temperature rise can be estimated using the following equations:

- (1) With a cooling fan, the permissible temperature rise shall be $10^{\circ}\text{C} \sqrt{6\text{W}/\text{m}^2}$.
- (2) Without a cooling fan, the permissible temperature rise shall be $10^{\circ}\text{C} \sqrt{4\text{W}/\text{m}^2}$.

The equations indicate that for a cabinet having a heat dissipation area of 1m² and a 6W heat source and a cooling fan (or 4W heat source without cooling fan), the internal temperature rise shall be 10°C. The heat dissipation area is the total surface area of the cabin minus the area in contact with the ground surface.

Ex.1 (with cooling fan)

heat dissipation area = 2 m²

internal permissible temperature rise = 10°C

therefore the max. permissible heat source in the cabin is = $6\text{W} \times 2 \times 10 =$

120W. If heat source within the cabin exceeds 120W, a cooling fin or other heat dissipation device must be provided.

Ex.2 (without cooling fan)

heat dissipation area = 2 m²

internal permissible temperature rise = 10°C

therefore the max. permissible heat source in the cabin is = $4\text{W} \times 2 \times 10 =$

80W. If heat source within the cabin exceeds 80W, a cooling fin or other heat dissipation device must be provided.

5.2.4 H4D-T External Dimensions

* H4D-T The Controller Panel



Fig.5-2 Panel of H4D-T Dimensions

* H4D-T Cabinet Dimensions and Rear View port

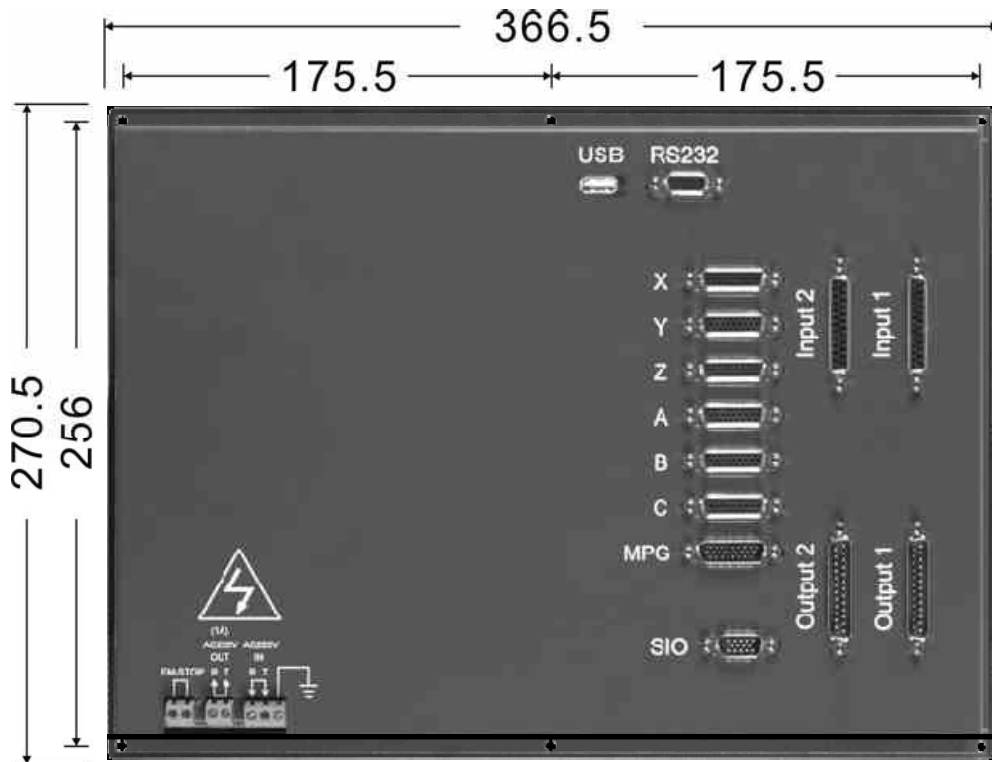

Fig.5-3 H4D-M Cabinet Dimensions and Rear View port

* H4D-T Cutout Dimensions

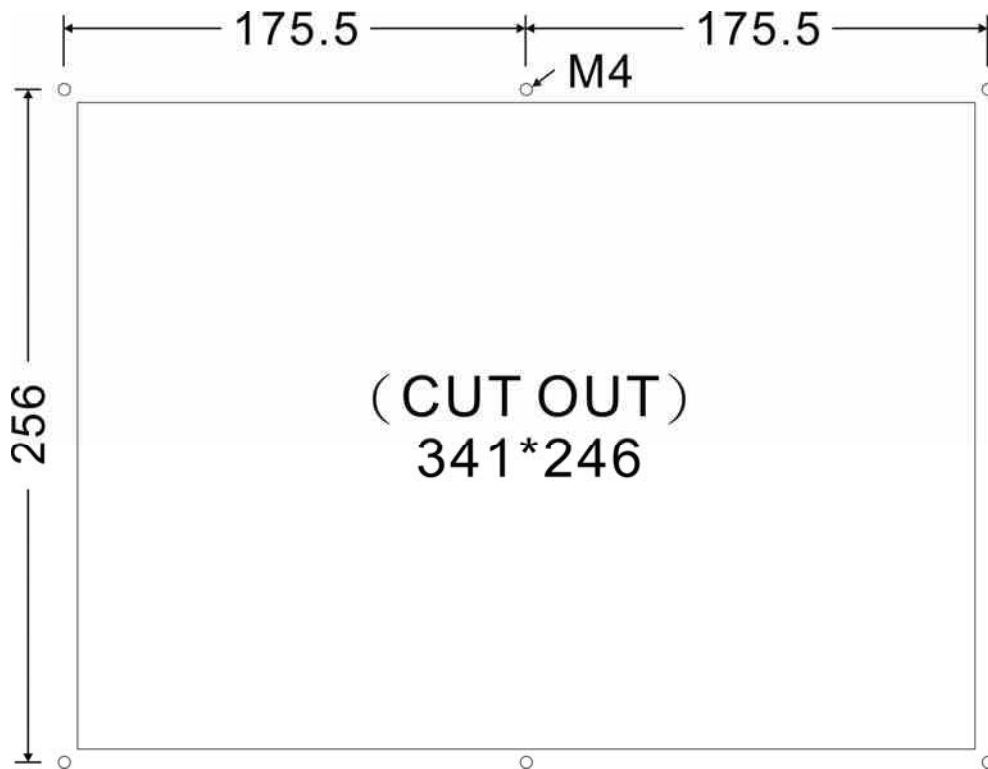

Fig.5-4 H4D-M Cutout Dimensions

5.2.5 H4D-T Accessories Dimensions

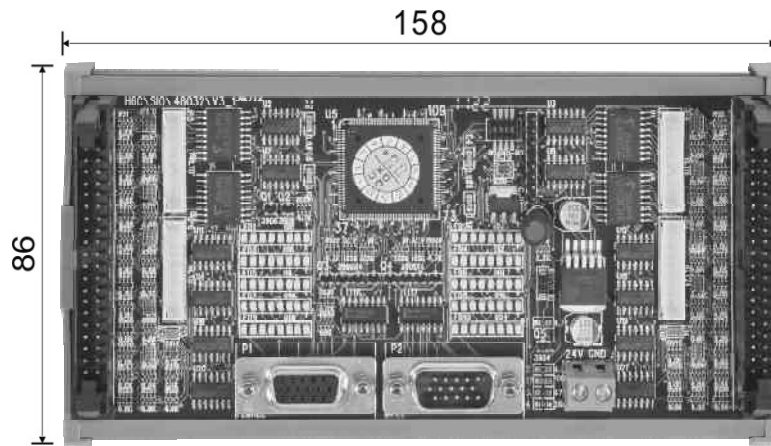

Fig.5-5 SI Module : 48IN32UT

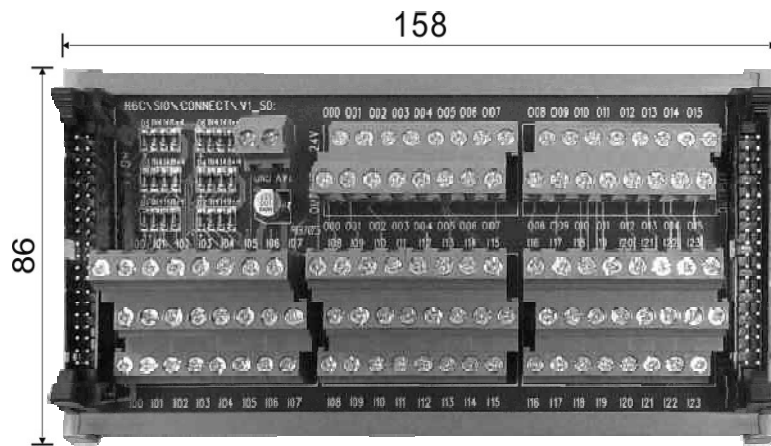

Fig.5-6 I connect board : 24IN16UT

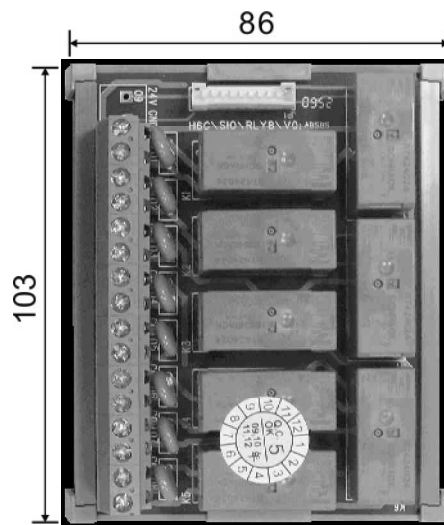

Fig.5-6 NPN output relay board : 8 ut

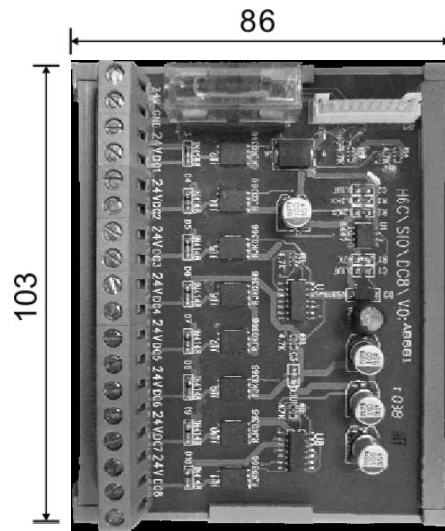

Fig.5-8 DC Power module board : 8 □ ut

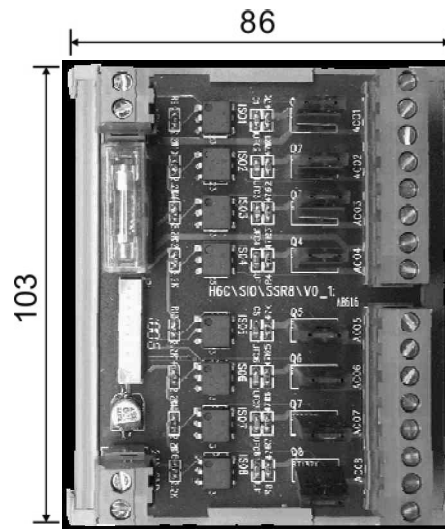

Fig.5-9 AC Power output module board : 8 □ ut

5.3 Connector Type

HUST H4D Series Controller rear panel connectors

- DBxx xx indicates number of pins
- DB26L 26-pin connector
- DB26LF a terminal with a female 26-pin connector
- DB26LM a terminal with a male 26-pin connector

5.4 Connector name

Connector types of the controller are as follows

Table 5-1 Connector Designation and Type

Connector Name	Connector Designation	Type
X-axis servo	X-AIS	DB26LF (F)
Y-axis servo	Y-AIS	DB26LF (F)
Z-axis servo	Z-AIS	DB26LF (F)
A-axis servo	A-AIS	DB26LF (F)
B-axis servo	B-AIS	DB26LF (F)
C-axis servo	C-AIS	DB26LF (F)
MPG Handwheel	MPG	DB26LM (M)
Standard INPUT-1	INPUT-1	DB25LF (F)
Standard OUTPUT-1	OUTPUT-1	DB25LF (M)
Standard INPUT-2	INPUT-2	DB25LF (F)
Standard OUTPUT-2	OUTPUT-2	DB25LF (M)
Communication Interface	RS232	DB9LF (F)
	USB	USB (F)

5.5 Connector Pin-out Definition

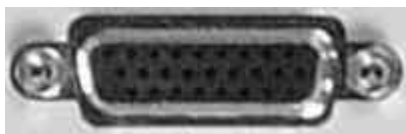

DB26LF (F)

Table 5-2 HUST H4D Axis Connector Pin

Pin No	Definition	Description
1	A	A phase input
2	A	A phase input
3	B	B phase input
4	B	B phase input
5		phase input
6		phase input
7	VCMD	0~10V analog command
8	GND	5V GND (V-command、Torgue ~5V GND)
9	5V	5V Power
10	TG	Torgue input
11	-	-
12	-	-
13	-	-
14	-	-
15	-	-
16	-	-
17	IN-49	Group 2 Input signal ※Note
18	UT-49	Group 2 output signal ※Note
19	Pulse	
20	Pulse-	
21	Sign	Pulse Direction
22	Sign-	Pulse Direction -
23	IN-48	Group 1 Input signal ※Note
24	UT-48	Group 1 output signal ※Note
25	24V	24V Power
26	24VGND	24V GND I ~24V GND

※ Note ~ axis group 1 I address at IN-52(pin23) UT-52(pin24)

~ axis group 2 I address at IN-53(pin17) UT-53(pin18)

※ output current at ~30mA (H6D CPU V6 ~50mA)

* **MPG (H4D)**



DB26LM (M)

Table 5-3 H4D □MPG□ Definition

PinNo	Definition	Description	MPG1	MPG2	DA1	DA2	AD1	AD2	G31
1	A1	A phase output (MPG1)	●						
2	B1	B phase output (MPG1)	●						
3	A2	A phase output (MPG2)		●					
4	B2	B phase output (MPG2)		●					
5	G31 IN	Inputs signal to control high-speed axial stop							●
6	GND	5V GND							
7		MPG、AD、DA □ □5V	●	●	●	●	●	●	
8		GND							
9	5V	□5V Power	●	●					
10	IN-86	Group 18 input signal							
11	IN-87	Group 19 input signal							
12	DA1	0□10V analog command 1			●				
13	DA2	0□10V analog command 2				●			
14	AD1	□10V analog command Input 1					●		
15	AD2	□10V analog command Input 2						●	
16									
17	D□	CAN□pen Signal							
18	D-	CAN□pen Signal							
19	IN-80	Group 12 input signal							
20	IN-81	Group 13 input signal							
21	IN-82	Group 14 input signal							
22	IN-82	Group 15 input signal							
23	IN-84	Group 16 input signal							
24	IN-85	Group 17 input signal							
25	24V	□24V Power							
26	24VGND	24V GND I□□、G31、□24VGND							●

* AD/DA Analog Signal Wiring

Table 5-4

Register	Function	Description
R209	Analog Input □ Torque function enable	Edit by PLC □R209 bit3□1□
R142	AD1, Indicates value of #1 analog voltage input	Pin 14 ∼ Pin 8
R143	AD2, Indicates value of #2 analog voltage input	Pin 15 ∼ Pin 8
R146	AD1, Indicates value of #1 analog voltage output	Pin 12 ∼ Pin 8
R147	AD2, Indicates value of #2 analog voltage output	Pin 13 ∼ Pin 8

※ Note : R209 bit3□1 that analog Input function must enable.

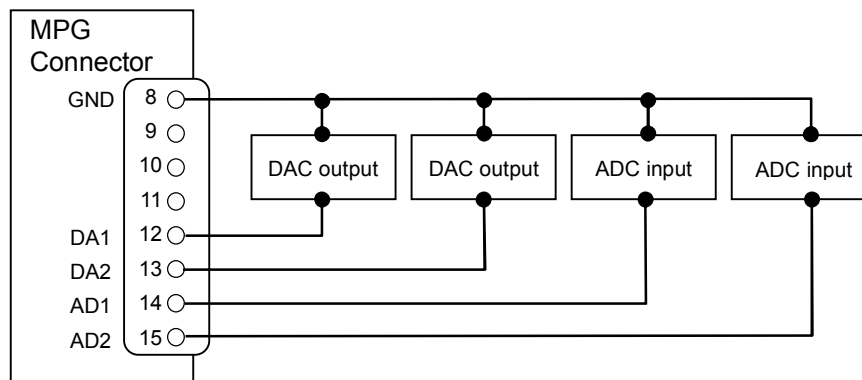

Fig 5-10 AD□DA Analog Signal Wiring

5.5.1 G31 INPUT Control signals

Control High-Speed axial stop, responding in 0.5 μsec.

Table 5-5

Settings for related Parameters and Registers	Description
R250	Setting □ 0, I-bit Input signal is an ascending (0→1) trigger signal
	Setting □ 1, I-bit Input signal is a descending (1→0) trigger signal
	Setting □ 2, I-bit Input signal is a Normal □pen (0) signal
	Setting □ 3, I-bit Input signal is a Normal Close (1) signal

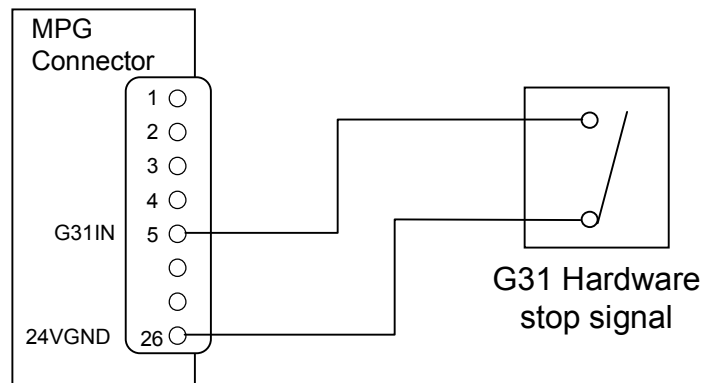

Fig 5-11 G31 INPUT Signal Wiring

5.5.2 Axial Control, pin assignment and wiring

Connect servo driver to axial-control connector as shown in Fig.5-12 (pin assignment identical for all axes).

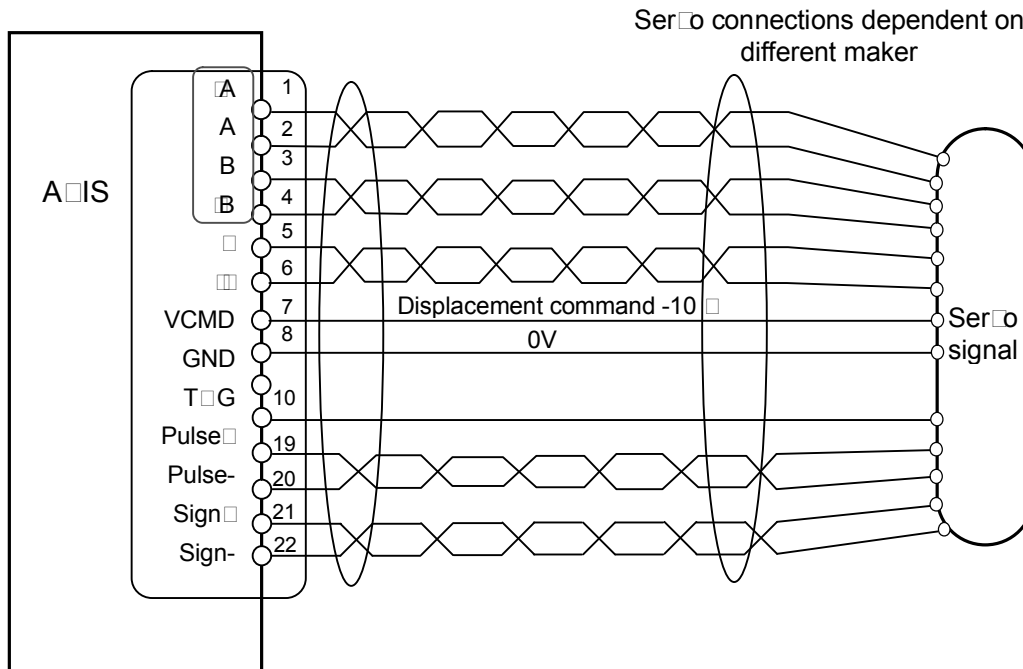

Fig.5-12 Wiring for Axial Control

1. Isolated twist-pair cables shall be used.
2. Pay special attention to Pins 1-4 of the axial connection. In case the motor runs scattering, alter the terminal A with the terminal B at the driver end.
3. HUST miller controller, when voltage-command type servo motor is used, you need to set the Follow Error checking function. (Not applicable to pulse commands.)
 - (a) Parameter 533 \rightarrow 4096 \rightarrow check the value of Follow Error.
 - (b) Parameter 543 \rightarrow 63 \rightarrow check Follow Error of the axis \rightarrow A/B/C simultaneously (set by BIT0 for A-axis, Bit1 for B-axis).
 - (c) When the ERR CNT of the actual feedback of A-axis motor \rightarrow 4096, the system will issue an error message.
4. In H4D-T Controller, connect Spindle 1 to C-axis, Spindle 2 to A-axis and Spindle 3 to B-axis and other axes will be connected according to the wiring method shown.

5.5.3 Wiring of Manual Pulse Generator (MPG)

- HUST H4D series can share 2 units of Manual Pulse Generators simultaneously.
- If the Tool traveling direction is opposite to that indicated for Manual Pulse Generator, then Parameter 518 can be used to change the Hand Wheel direction.(If the machine uses two hand wheels, hand wheels will be changed at the same time.)
- Operation description of Hand Wheel 2
 - In PLC, C237□1. (refer to MPG2 pin)
 - Select the axis to be controller with R243.
 - Adjust the multiple with R245.
- MPG Pin 6、7、8 are 5V GND.

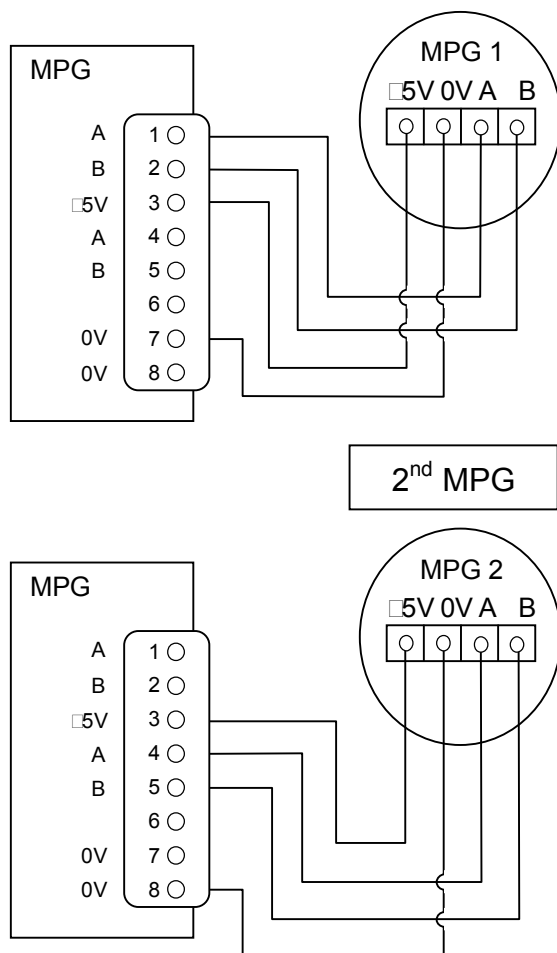

Fig. 5-13 Manual Pulse Generator (MPG) Wiring

5.5.4 Wiring of Spindle Control

There are 2 types of Spindle Control

(b) Pulse Command type

* **Voltage Command type**

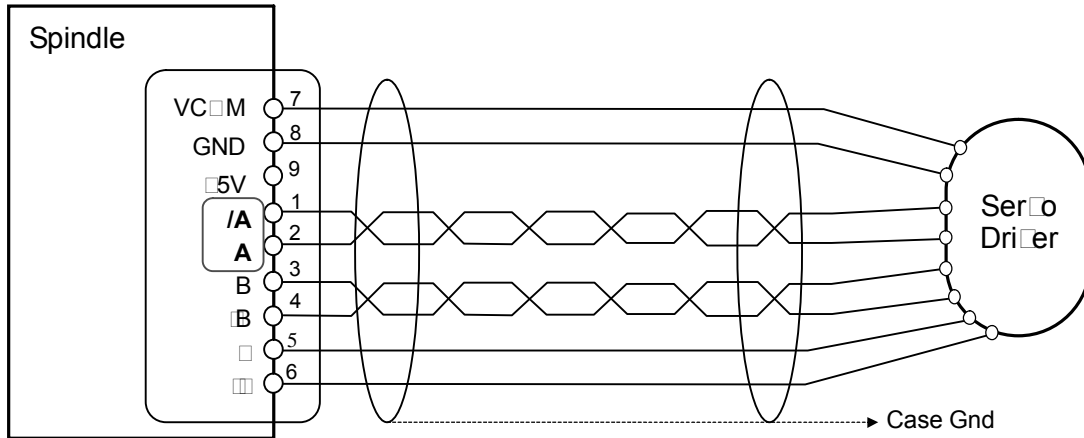

Fig.5-14 Spindle Voltage command control-closed circuit wiring (servo)

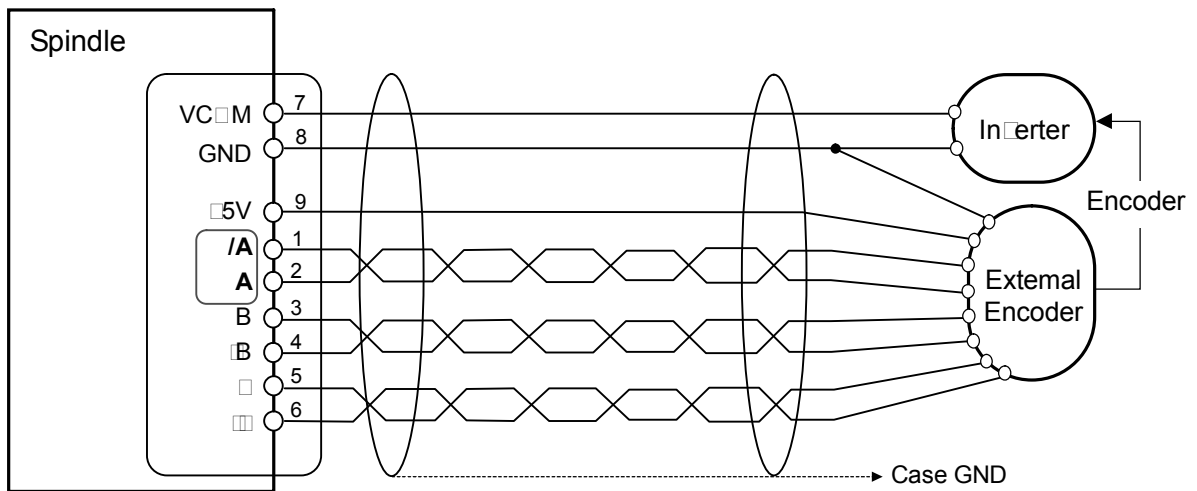

Fig.5-15 Spindle Voltage Command Control- open circuit wiring (Inverter)

* **Pulse Command Type**

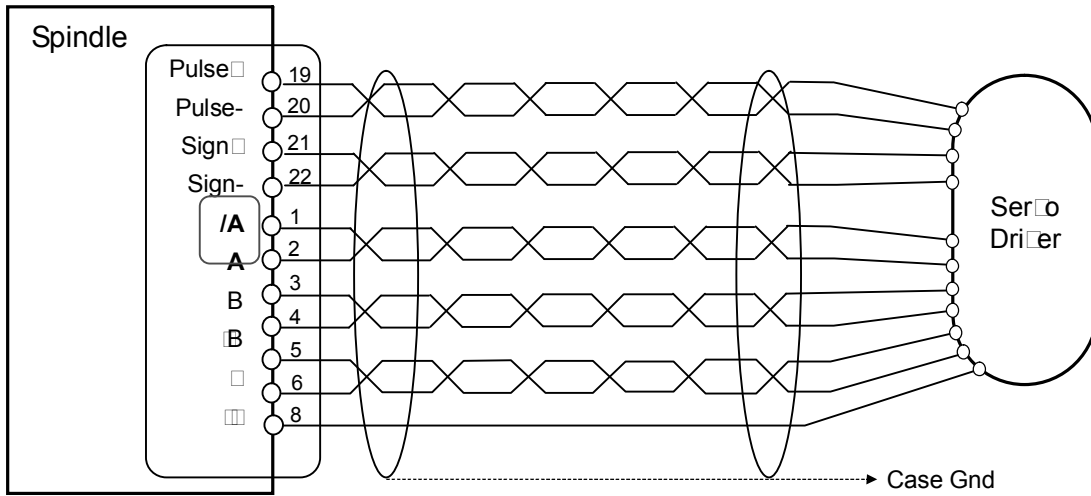

Fig.5-16 Spindle pulse command control- closed circuit wiring (ser□)

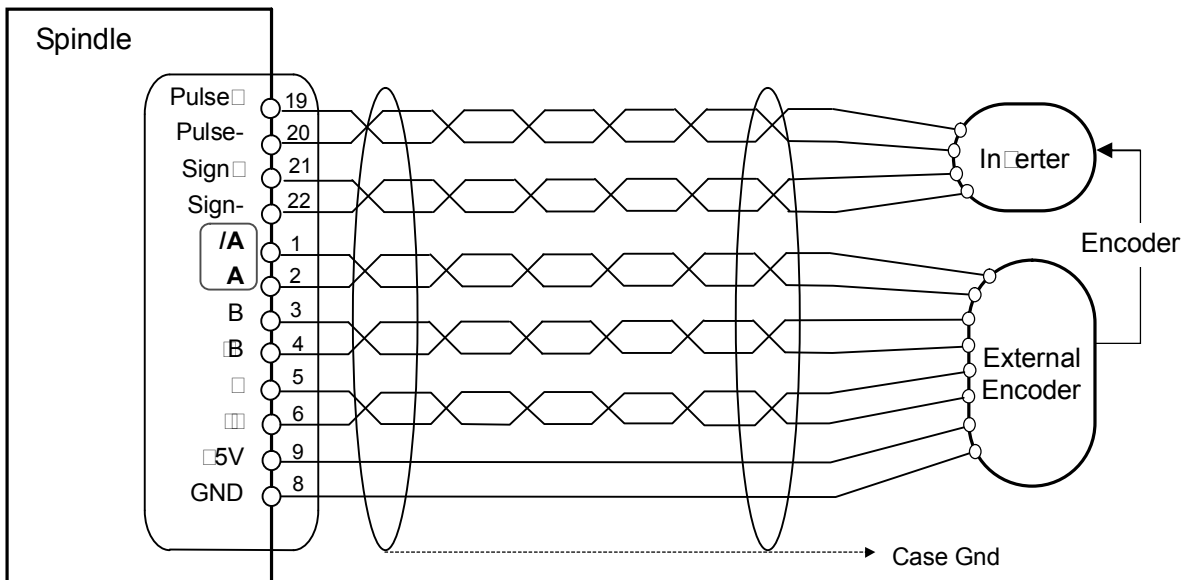

Fig.5-17 Spindle pulse command control- closed circuit wiring (In□erter)

5.5.5 I/O Wiring

* Structure of wiring (1)

All of the SI board must used the same 【DC24V power supply】 except to the AC output board.

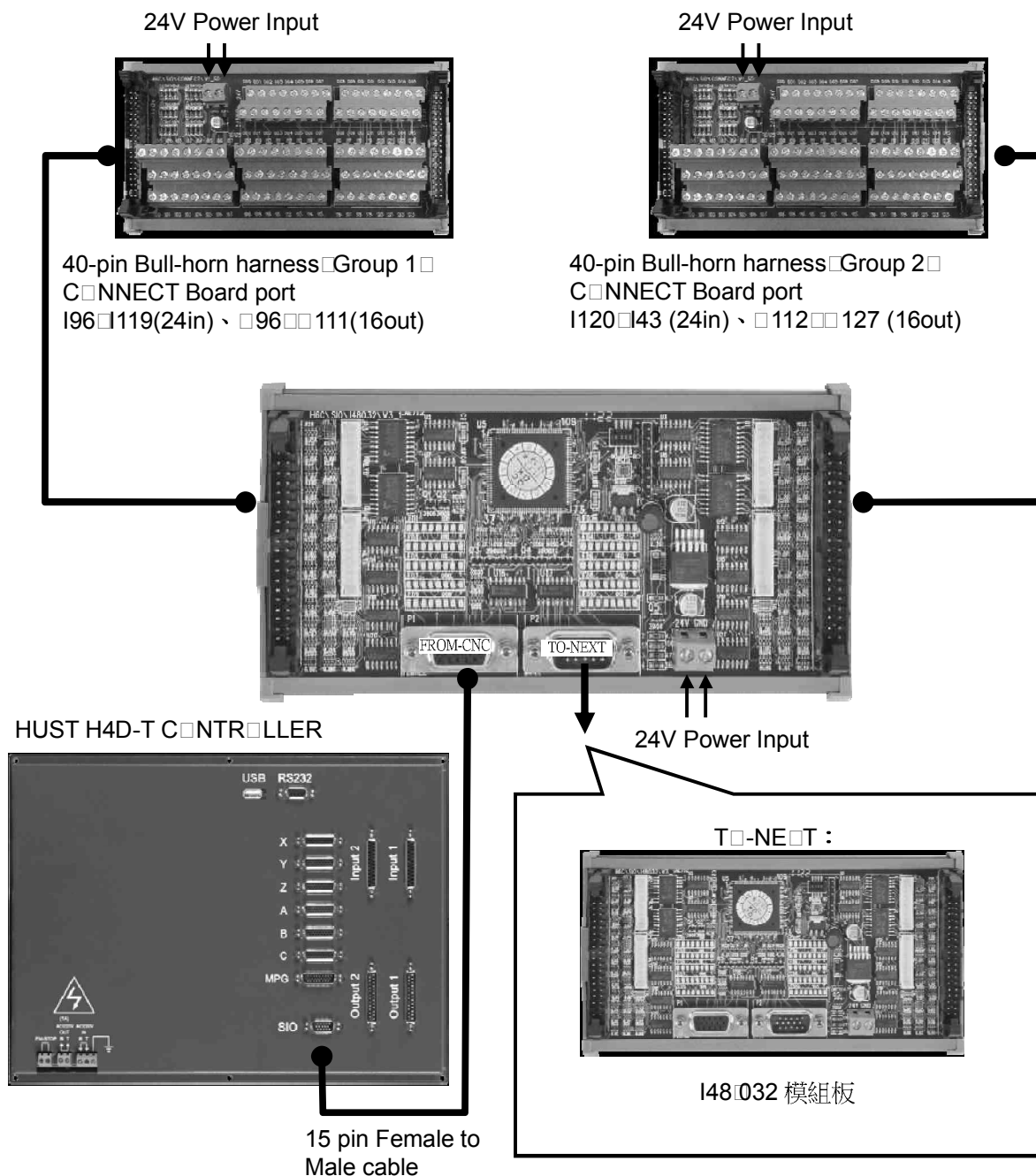
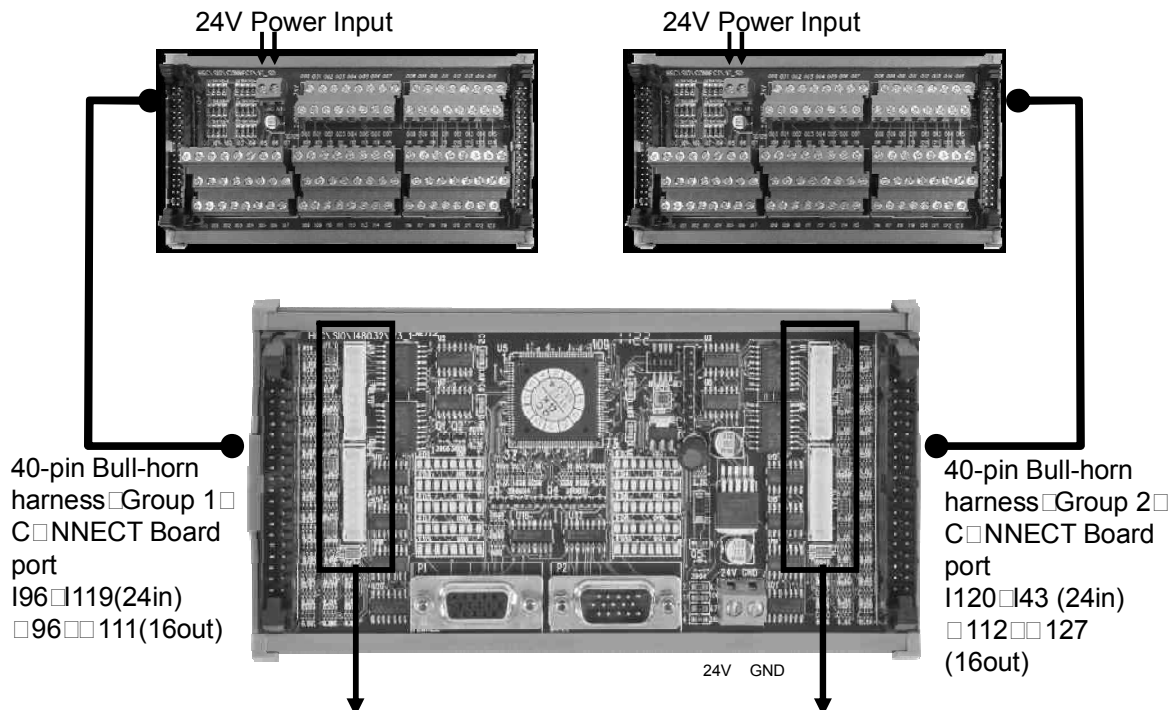

Fig.5-18

*** Structure of wiring (2)**

All of the SI□ board must used the same 【DC24V power supply】 except to the AC output board.



1. Use in combination as required
2. 10 pin white connecto
3. Can be connected to 3 optional boards
4. Can be connect 4 modules maximum .
5. NPN RELAY BOARD : provide 8 dry contacts. Max. current for each output of the PCB is 1A .
6. AC power output module board : provide 8 AC110V outputs. Max. current for each output of the PCB is 1A.
7. DC power module board : provide 8 DC24V outputs. Max. current for each output of the PCB is 1A .

Accessories :

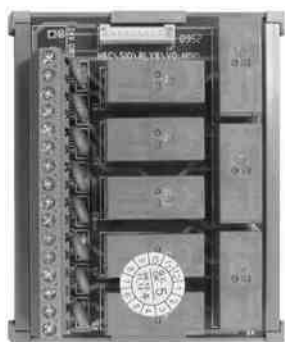

8 OUT RELAY BOARD

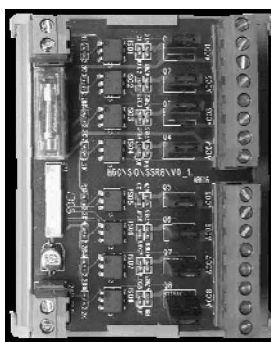

AC POWER OUTPUT MODULE BOARD

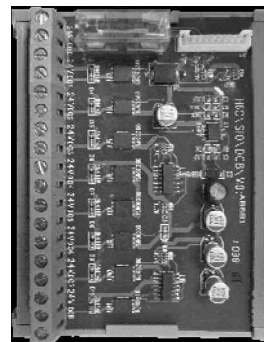

DC POWER OUTPUT MODULE BOARD

Fig.5-19

5.5.6 Input/Output wiring schematic

The input signals are the messages transmitted to the Controller from the external device. These signals can be generated by push button, Limit Switch, Relay Board connection or Proximity Switch, etc.

The output signals are the messages transmitted to external working machine from the Controller, which are used to drive the Relay of the Working Machine and the LED display of the Controller.

Input/Output Interface

The Controller must link with other accessories through Signal Module Board so as to control the actions of external I/O, power output and axis control module.

* I/O Connect Board (PC Board No. : H6D\SIO\IO\V1_2, AB852)

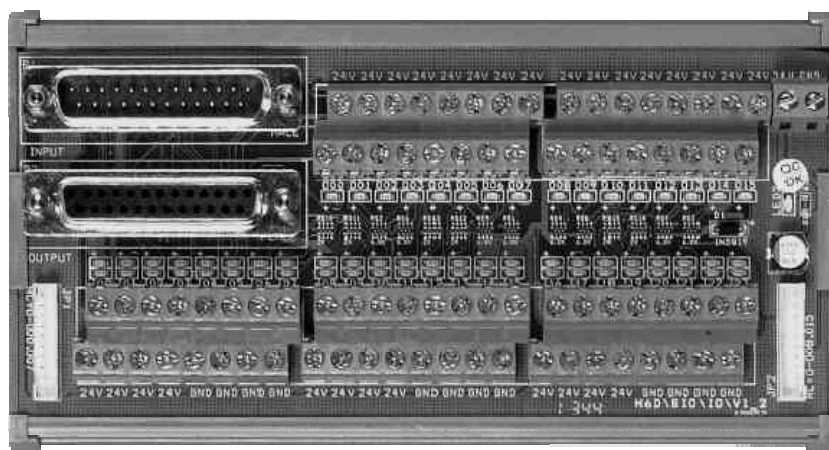

Fig 5-20

1. I/O connect board controls 24 input terminals and 16 output terminals.
2. Output control is by 0V output.
3. An INPUT can be of NPN type or PNP type.
4. When NPN and PNP are in use at the same time,
 - (1) NPN : the input voltage at I is 0V.
 - (2) PNP : the input voltage at I is 24V.
5. Input current at I is 3.6mA
6. Output current at O is 100mA (H6D\CPU\V6\1 is 250mA).

Input Pin Assignment (Female)

Output Pin Assignment (Male)

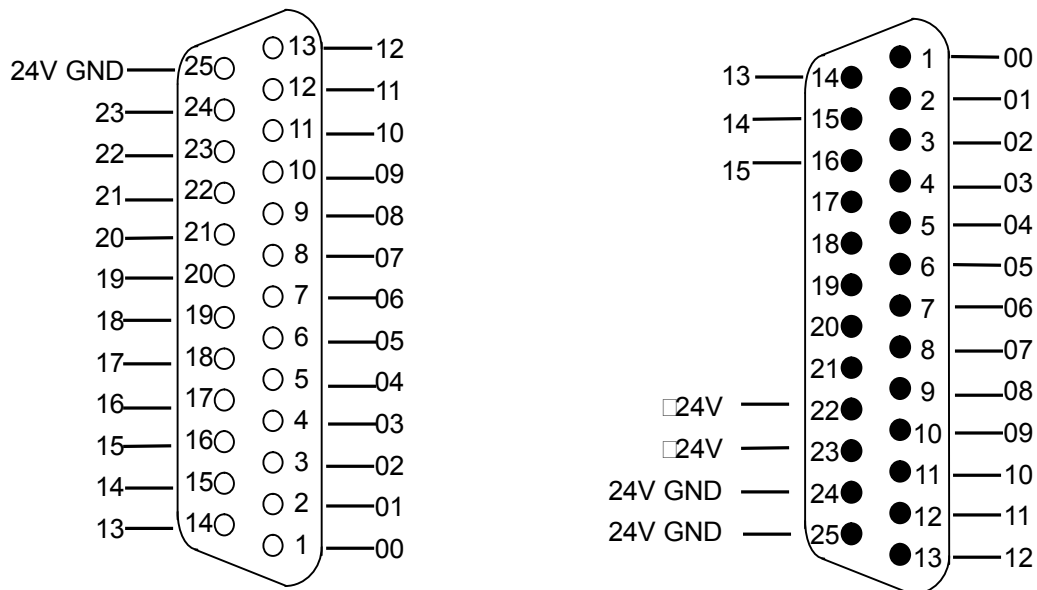

Table 5-21 I/O Connector Pin Assignment (NPN-PNP Type)

* SIO module Board (H6C\SIO\I48032\V3_1, AE712)

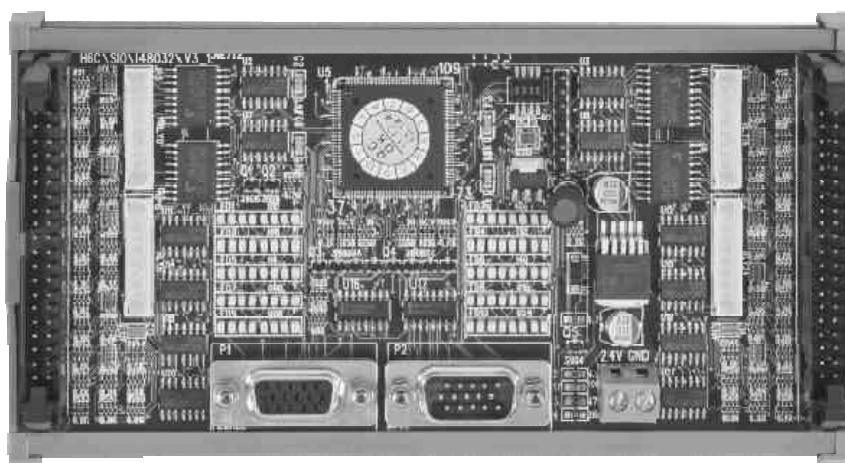

Fig.5-22

Serial Input/Output Module (SIO)

1. The SIO Module Board is provided with 48 input/32 output points respectively.
 - (a) A maximum of 4 boards can be linked in providing maximum 256 input/176 output points respectively.
 - (b) It can be linked with Auxiliary Panel (Panel 2).
2. The module can work with the following external components
 - (a) Standard input/output CONNECT panel (24 Input/16 output).
 - (b) 8 Output Relay boards.

- (c) 8 Out DC power boards.
 - (d) 8 Out AC power boards.
 - (e) 8 Out Axis Control Modules To control the Servo or Step Motor.
3. When using with Universal Auxiliary Panel, it will occupy the I position of Panel 2.
 4. The Dip Switch is used to define the I starting position of SI Module Board.

Explanation of SIO MODULE BOARD :

LED-lamp (Input) : ❶

LED-lamp (Output) : ❷

SWITCH : ❸

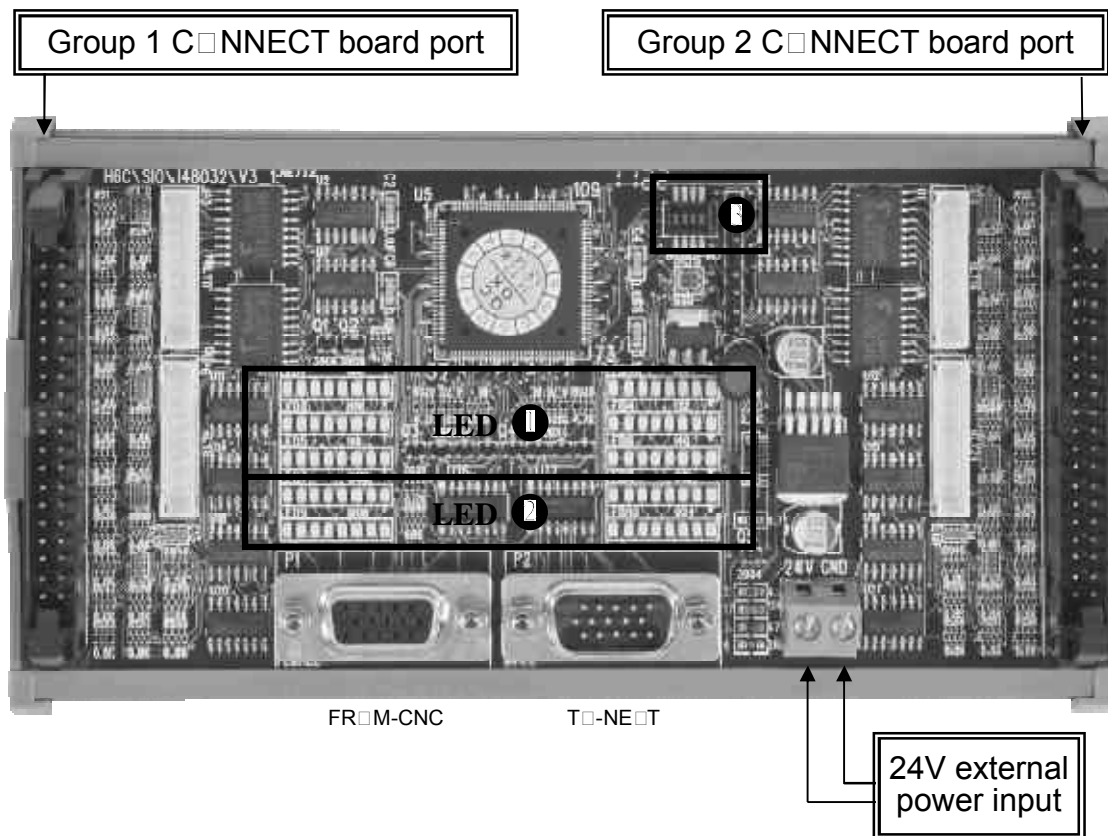

Fig.5-23

1. LED Indicator
 - I-Point Signal LED Indicator (Green) ❶ 3 groups each for upper and lower rows with each group containing 8 lamps, which makes a total of 48 lamps.
 - O-Point Signal LED Indicator (Red) ❷ 2 groups each for upper and lower rows with each group containing 8 lamps, which makes a total of 32 lamps.





















2. Dip Switch  For setting the SI  Module Board and I  starting signal position.





















Table 5-6 Dip Switch  Module Corresponding Positions



M  DULE	Switch 1	Switch 2	Switch 3	Switch 4	IN range	 UT range
1 st	0	0	0	0	I096  I143	 096   127
2 nd	1	1	0	0	I144  I191	 144   175
3 rd	0	1	1	0	I192  I239	 192   223
4 th	1	0	0	1	I240  I255	 240   255

※ **Module Board 4 can control 16 unit of Inputs and 16 units of Outputs.**

I/O related scope when using with Operation Panel 2:

Table 5-7 Stand operator panel I  Corresponding Scope

I  range						
Board	Switch 1	Switch 2	Switch 3	Switch 4	Input range	 output Range
1 st	0	0	0	0	I096  I143	 096   127
2 nd	General Purpose Secondary Control Panel				I144  I191	 144   175
3 rd	0	1	1	0	I192  I239	 192   223
4 th	1	0	0	1	I240  I255	 240   255

※ When use operator panel, that SI  address  occupancy.

*** Connect board (H6D\SIO\IO\V1_2, AB852)**

1. This connect board controls 24 input terminals and 16 output terminals.
2. Output control is by 0V output.
3. An INPUT can be of NPN type or PNP type.
4. When NPN and PNP are in use at the same time,
 - (1) NPN : the input voltage at I is 0V.
 - (2) PNP : the input voltage at I is 24V.
5. Input current at I ≤ 6mA
6. Output current at O ≤ 100mA

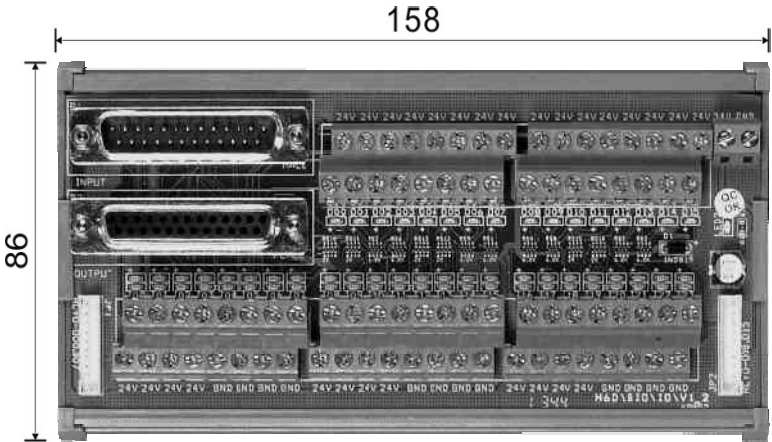

Fig.5-24

*** 8 out relay Board (H6C\SIO\RLY8\V0, AB585)**

1. Max. current for each output of the PCB is 1A
 2. For a max. current ≤ 1A, use other relays.
- Contacts on the RELAY adaptor board are dry contacts

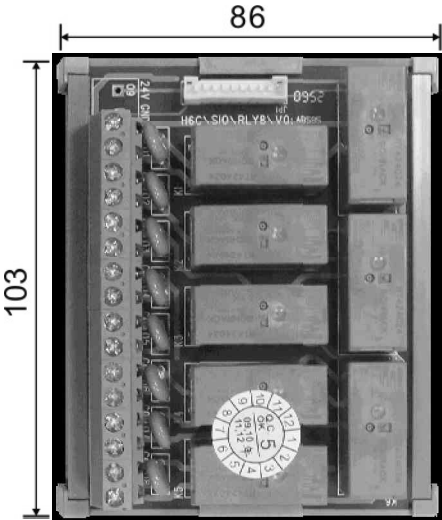

Fig.5-25

*** AC power output module board (H6C\SIO\SSR8\V0, AB616)**

1. AC Power supply adaptor board controls 8 AC110 outputs.
2. Max. current for each output of the PCB is 1A .
3. The 8 □ output terminals can sustain a max. current of 8A, all together.
4. 24V power supply can be used alone.
5. Rating of the factory supplied fuse is 5A.

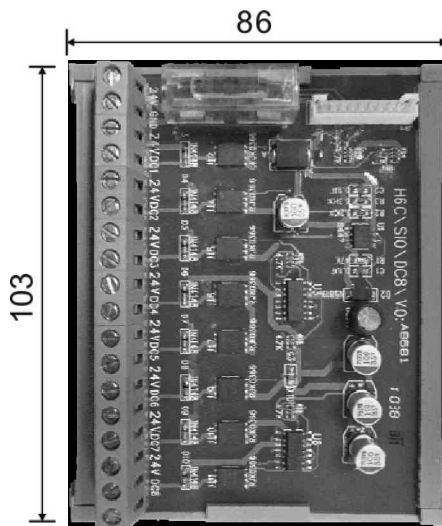

Fig.5-26

*** DC power module board (H6C\SIO\DC8\V0, AB683)**

1. DC power output board controls 8 sets of DC 24V output.
2. Max. current for each output of the PCB is 1A .
3. The 8 □ output terminals can sustain a max. current of 8A, all together.
4. Rating of the factory supplied fuse is 5A

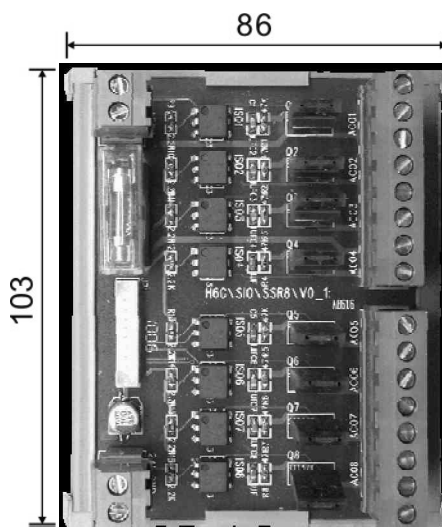

Fig.5-27

5.5.7 Wiring of System AC Power Supply

In order to avoid controller anomalies caused by voltage fluctuations, it is recommended to provide sequential differences for the ON/OFF of the CNC power and Servo power.

1. SERVON signal shall be activated in a slight delay after the activation of system power supply, when the latter is stabilized.
2. Before switching off the system power supply, provide a delay for switching off the SERVON signal first.

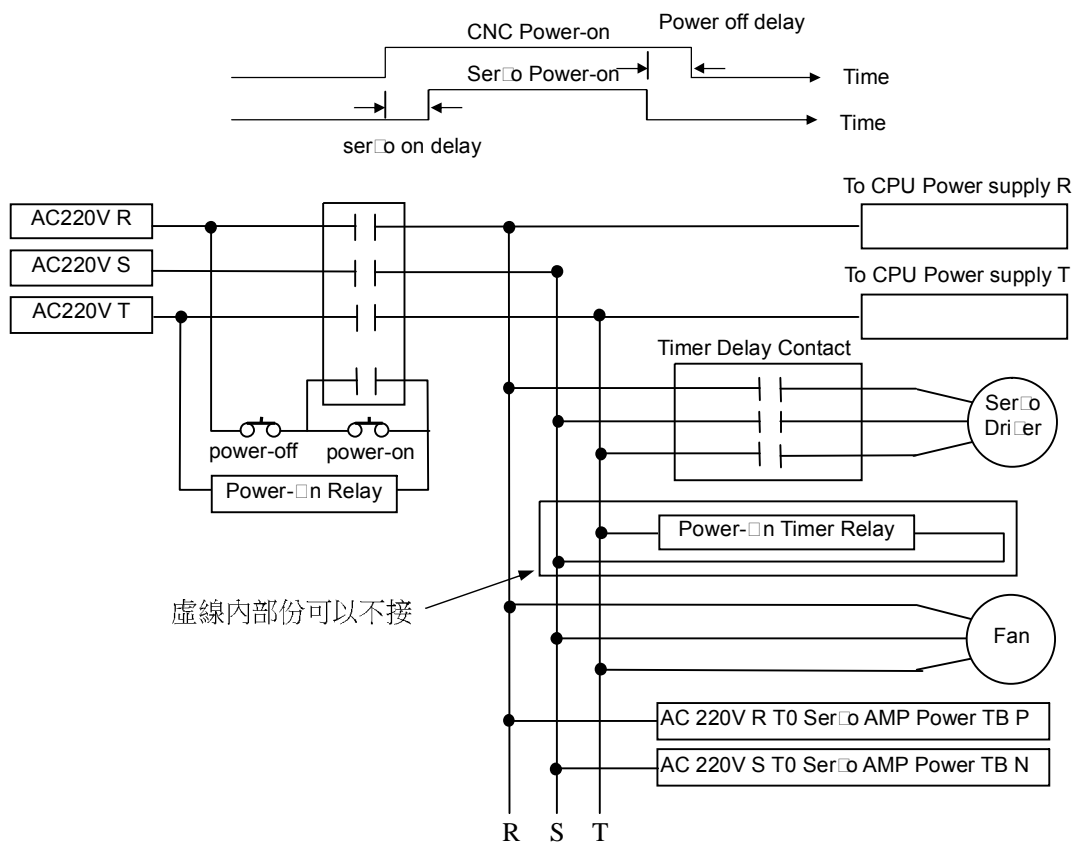

Fig.5-28 Wiring of System AC Power Supply

5.5.8 Servo on Wiring Examples

* Emergency-Stop wiring diagram-1

Recommended wiring diagram. In this connection, the software control and hardware control are connected in a series. When the E-stop button is pressed, the hardware will switch off Servo even if the software fails.

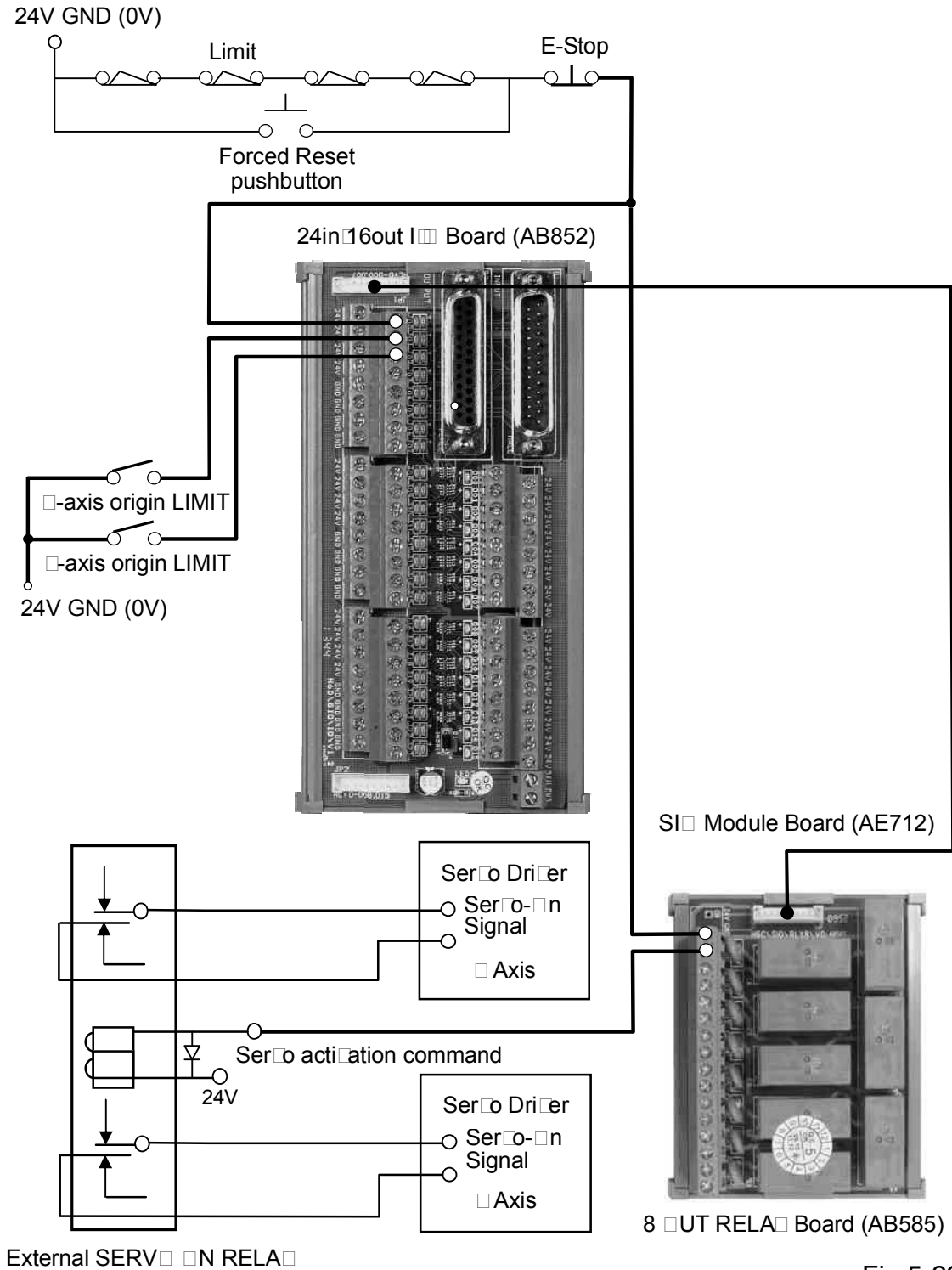

Fig.5-29

* Emergency-Stop wiring diagram-2

Convenient Wiring Diagram.

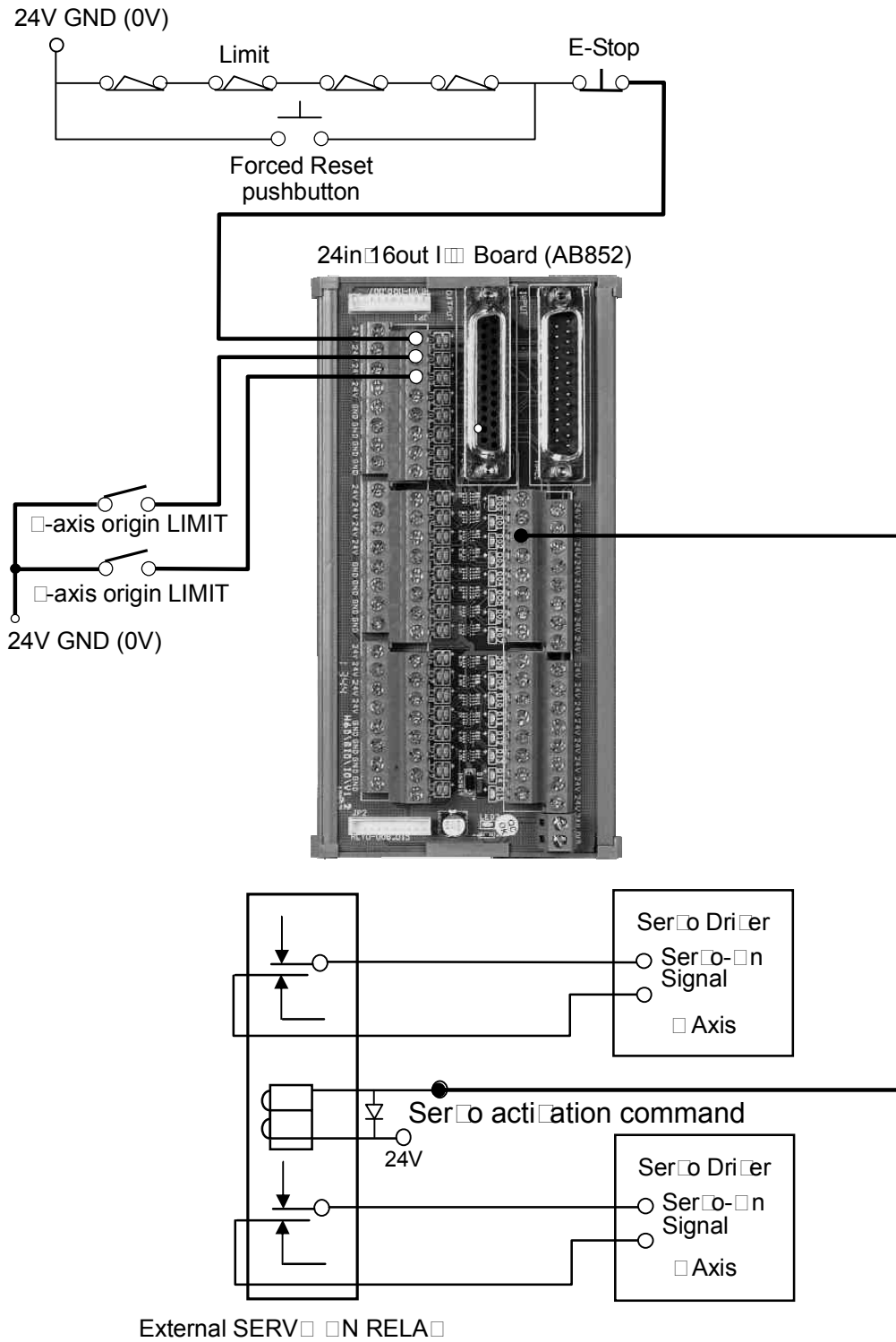

Fig.5-30

*** Emergency-Stop wiring diagram-3**

Convenient Wiring Diagram.

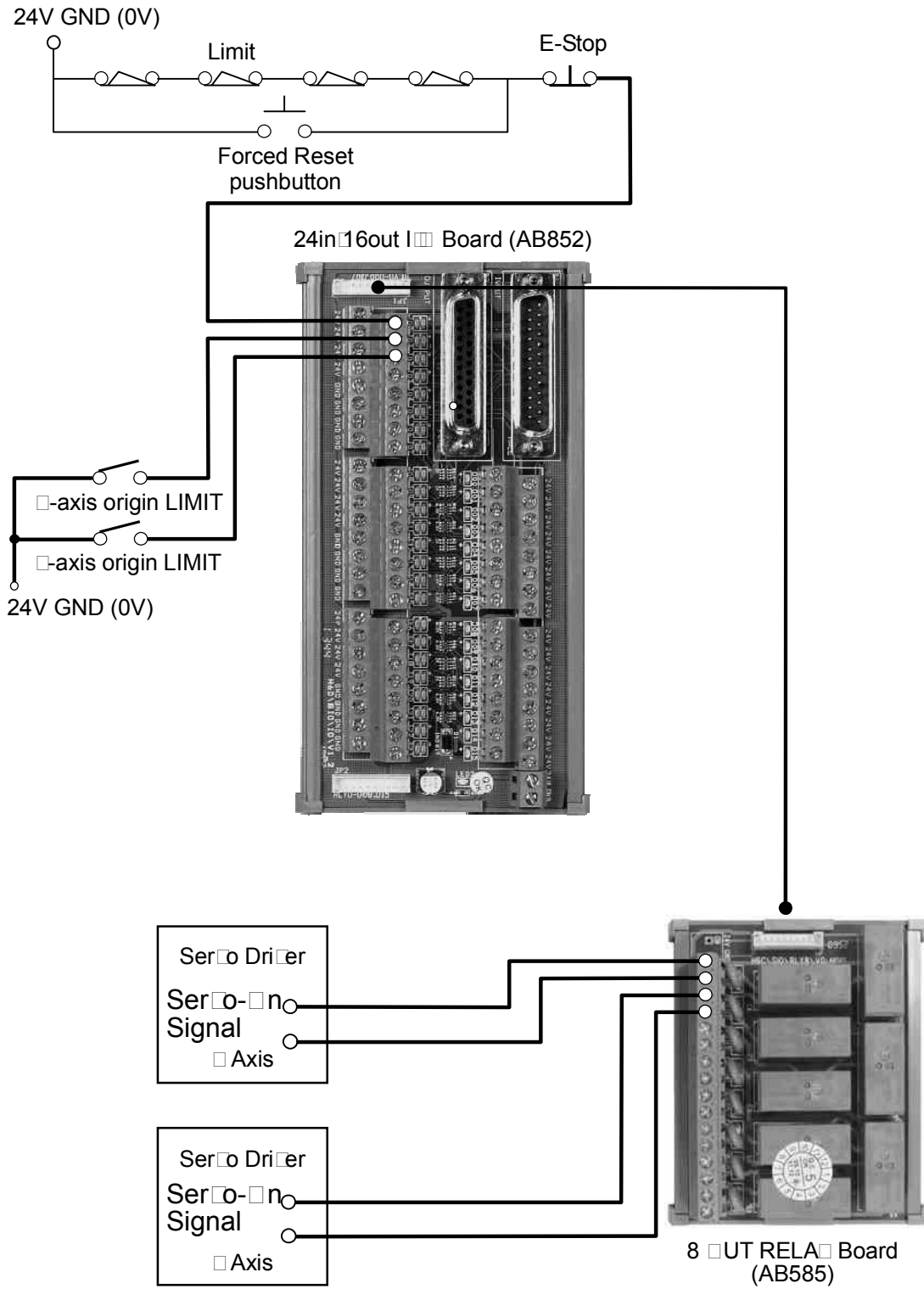

Fig.5-31

* Other Wiring – Example 1

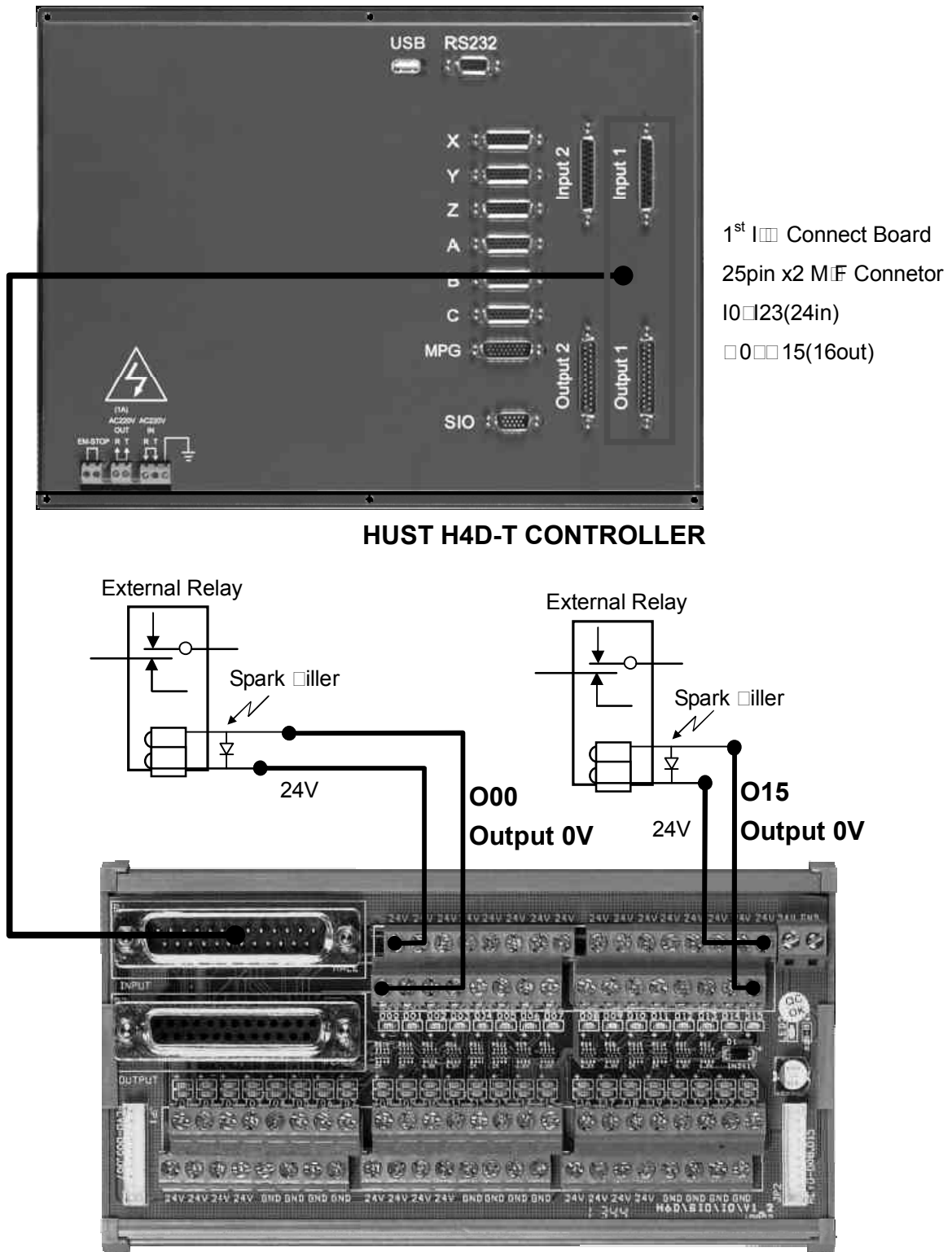

Fig.5-32

*** Other Wiring – Example 2: Dry Contact Output**

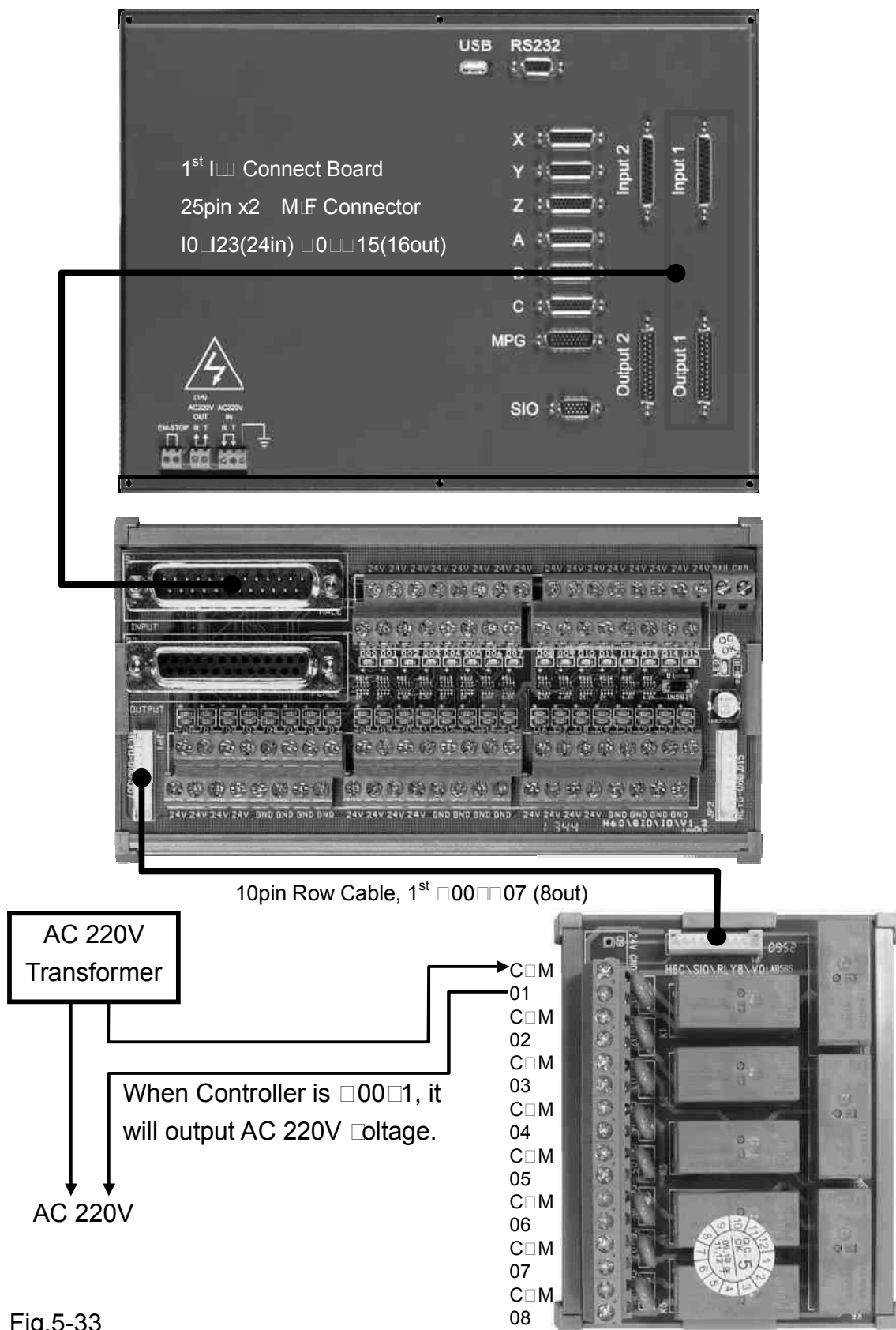

Fig.5-33

- As each COM point is not inter-connected, they should be wired individually when using.
- The external Relay may not be connected that the Relay Board can be used independently.
- As per the figure above, when the Controller is 0001, it outputs 0V and COM will be connected with 01 in the meantime.

* Other Wiring – Example 3: Dry Contact Output

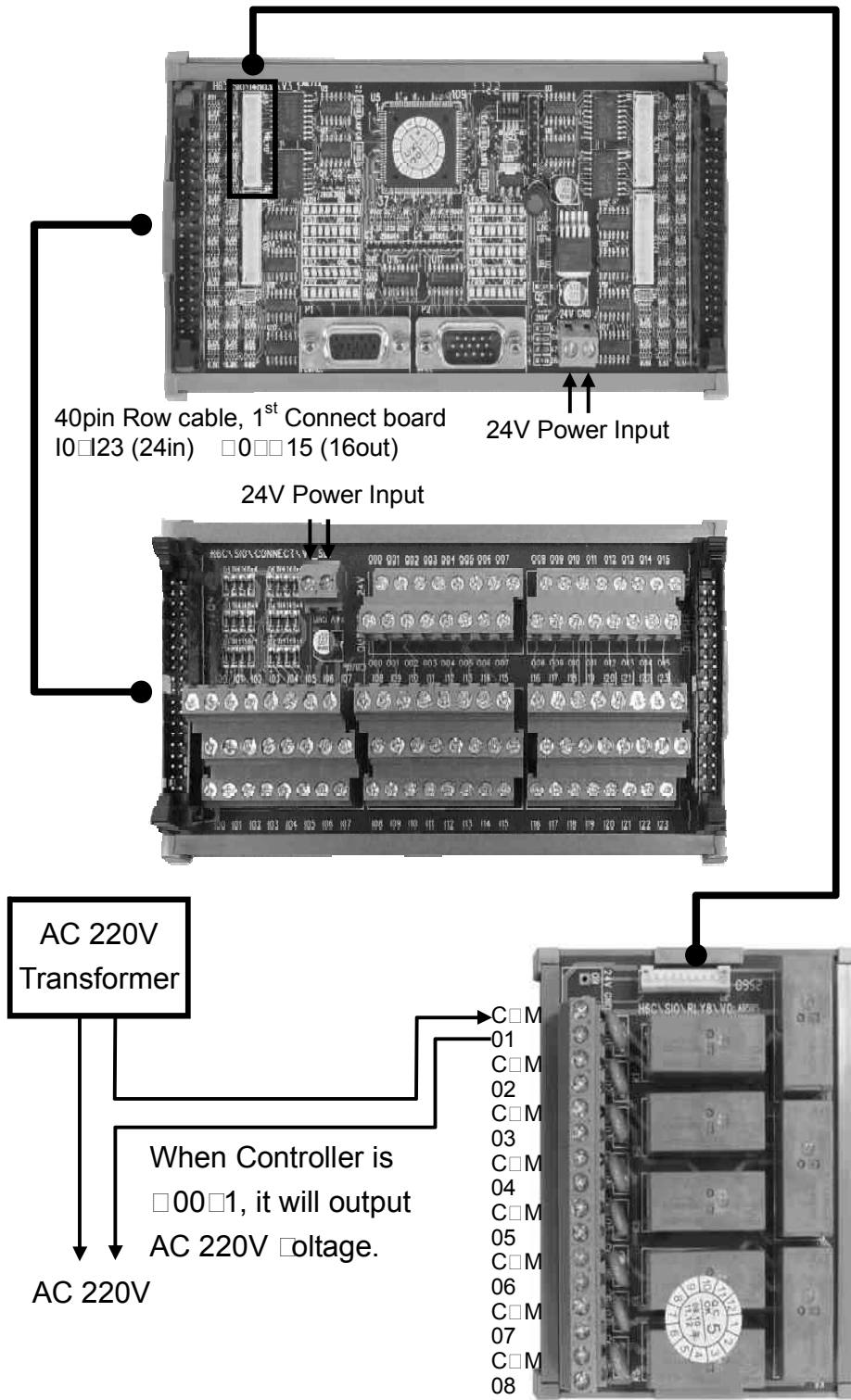

Fig.5-34

* Other Wiring – Example 4: AC Power Output

Single Output Point – The maximum current to be sustained by PC Board will be 1A.

When using 8 output points simultaneously – The maximum current to be sustained by PC Board will be 8A.

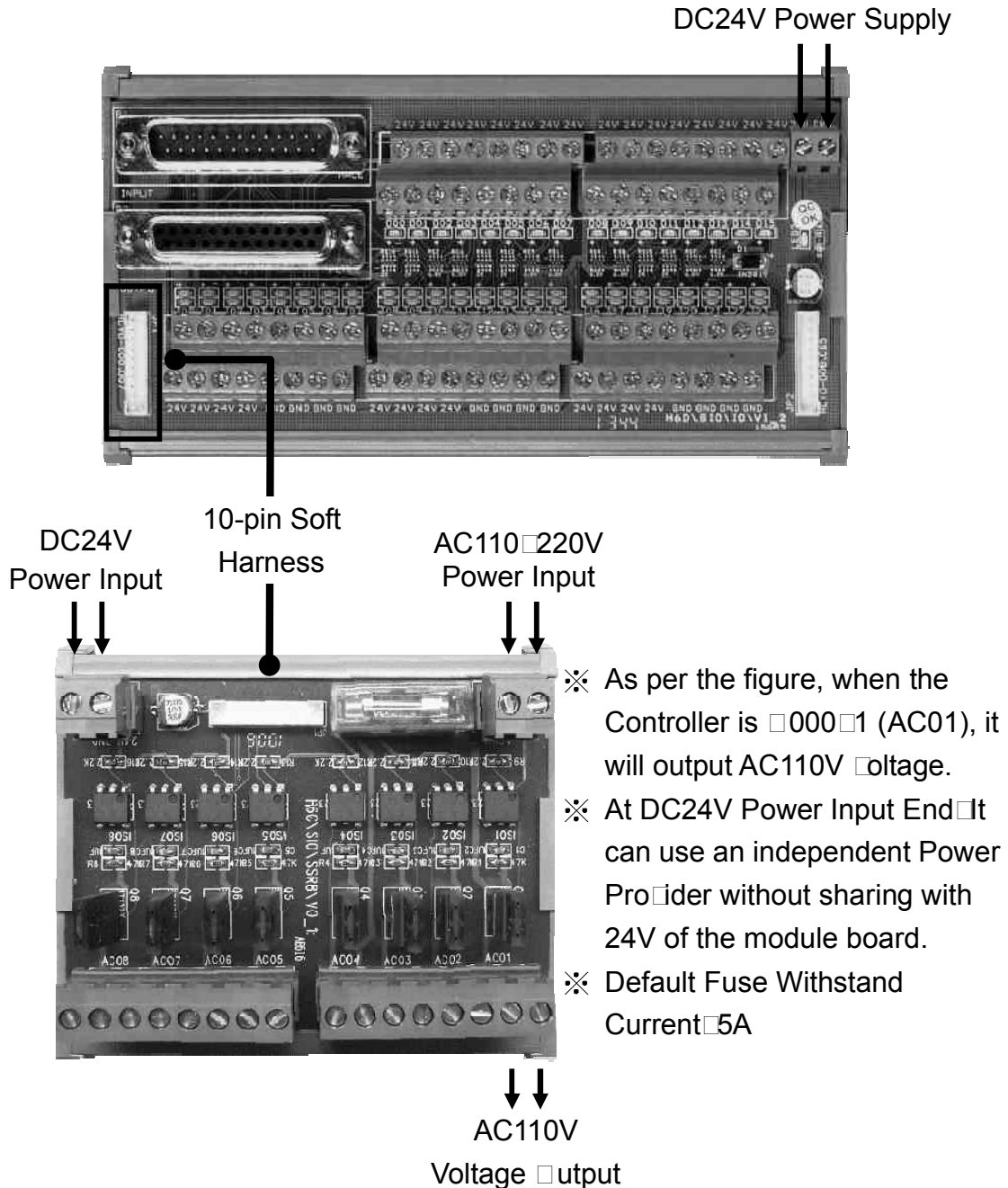
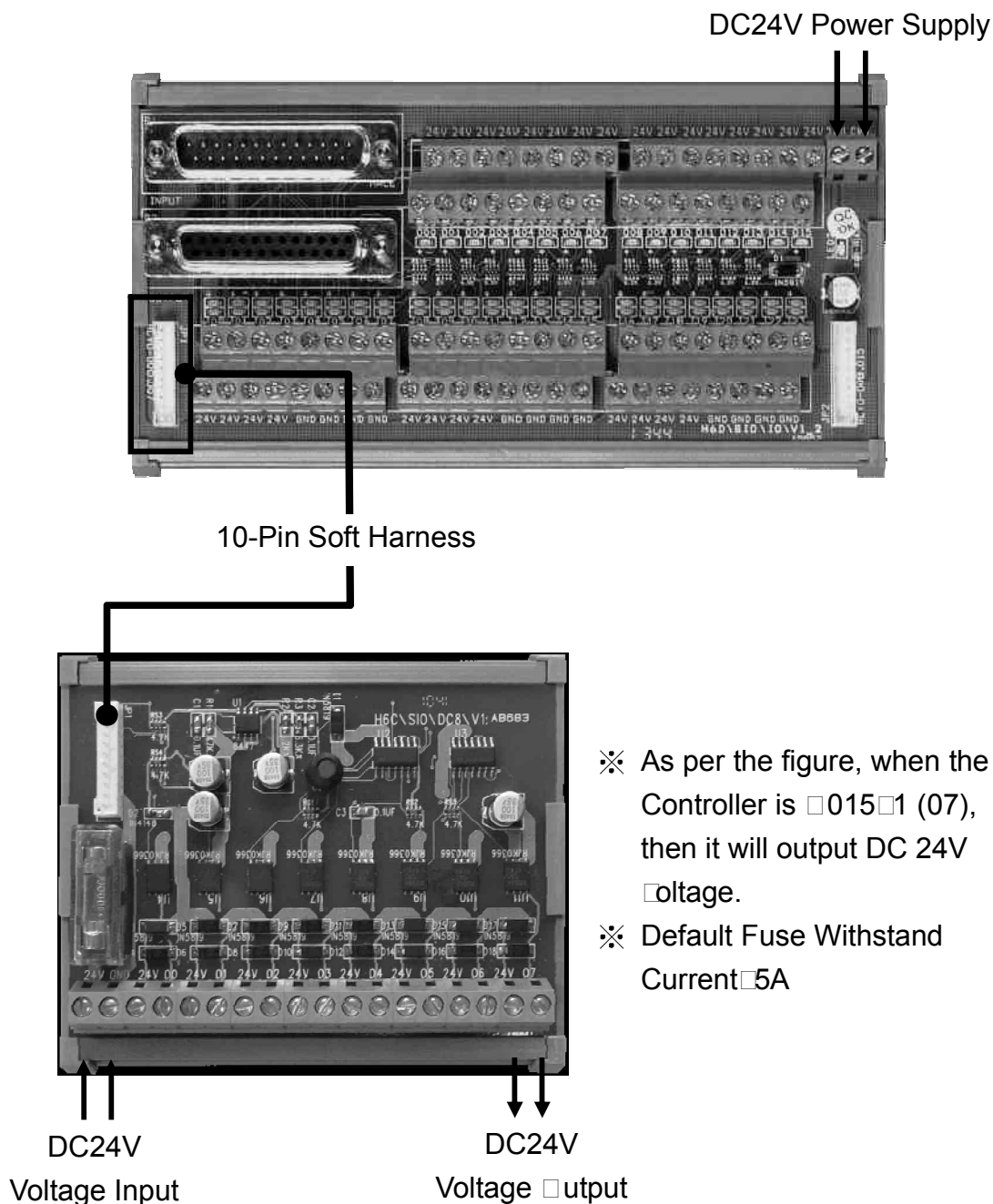

Fig.5-35

*** Other wiring – Example 5: DC Power Output**

Single □ output Point □ The maximum current to be sustained by PC Board will be 1A.

When using 8 output points simultaneously □ The maximum current to be sustained by PC Board will be 8A.



- ※ As per the figure, when the Controller is □015□1 (07), then it will output DC 24V □oltage.
- ※ Default Fuse Withstand Current □5A

Fig.5-36

* Other Wiring – Example 6: NPN 3-wire Sensor

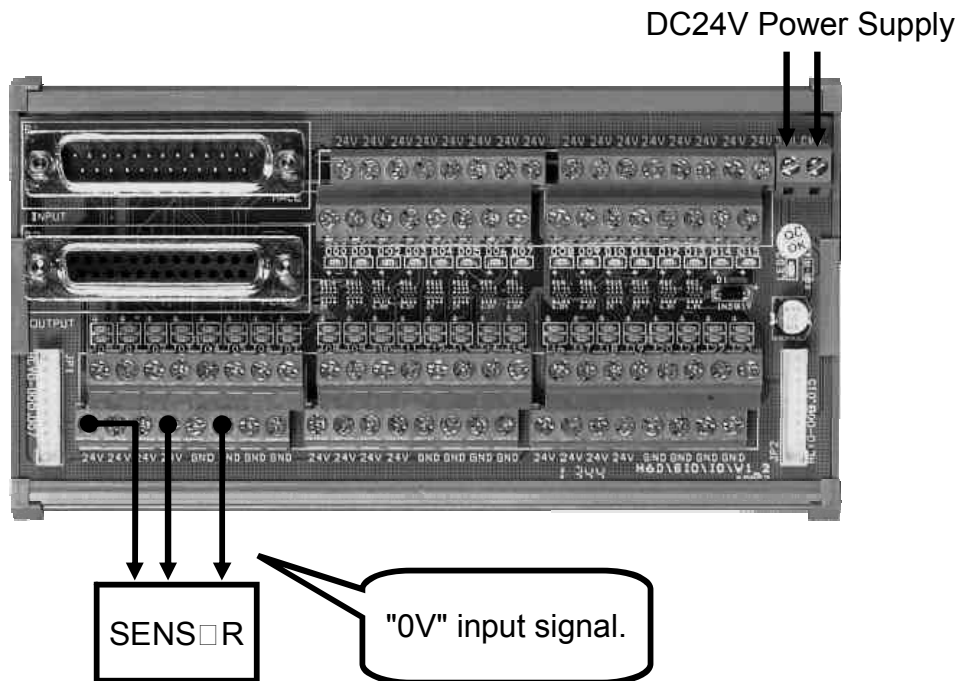

Fig.5-37

* Other Wiring – Example 7: NPN 3-wire Sensor

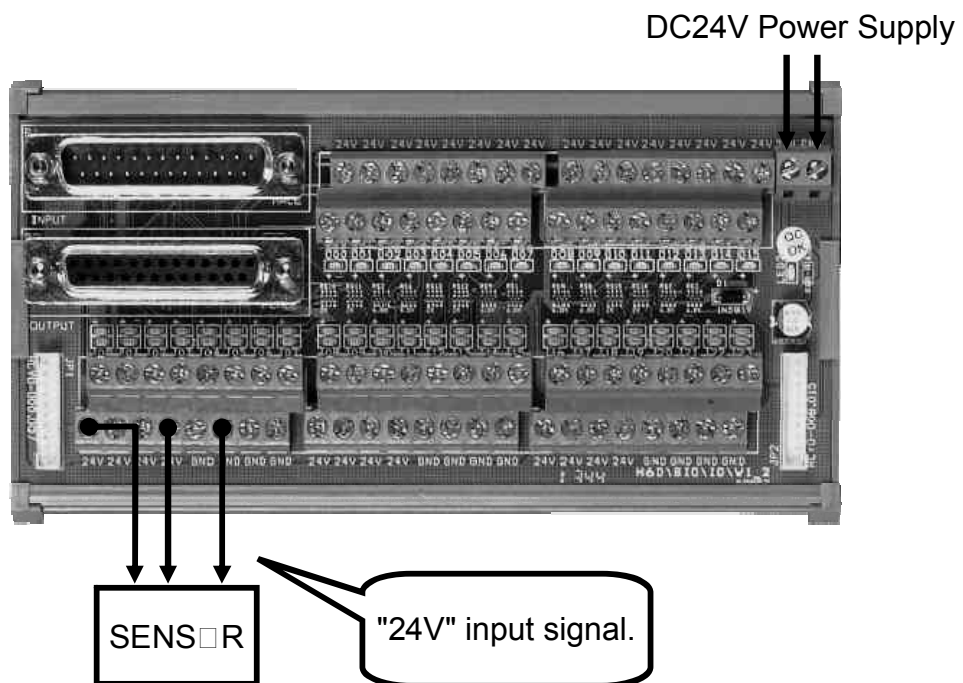
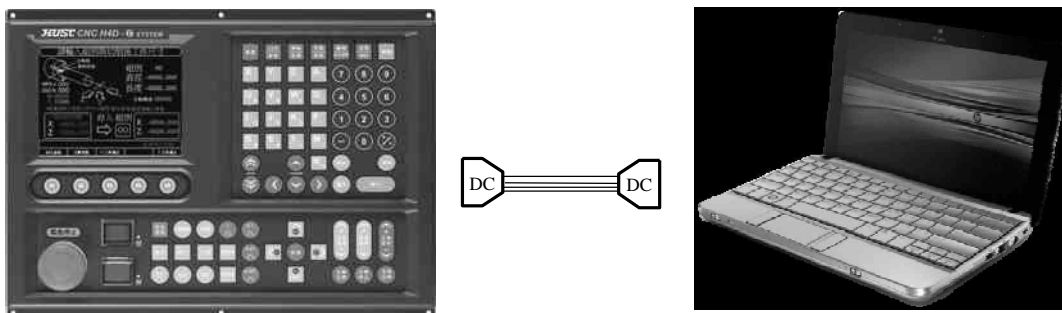

Fig.5-38

*** RS232C Connector, pin-out assignment and wiring**

Fig.5-39 shows the connection between the HUST H6D Serial Controller and the computer (PC). When carrying out the wiring, take the following precautions□

1. The RS232C cable shall not exceed a length of 15m.
2. In case of existence of massive noise generators (e.g., EDM processor, welding machine, etc.) in the vicinity, Twist-pair type cables shall be used, or such an environment shall be avoided. The controller and the PC shall NOT share a common power socket with an EDM or welding machine.
3. Make sure the voltage of the interface at the PC end is within the range of 10□15V.



HUST Controller end

PC end COM

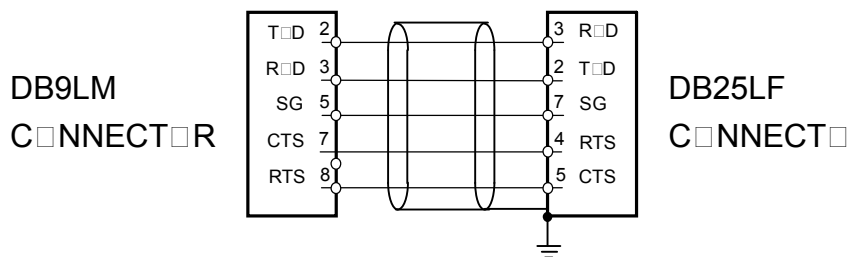

HUST Controller end

PC end COM

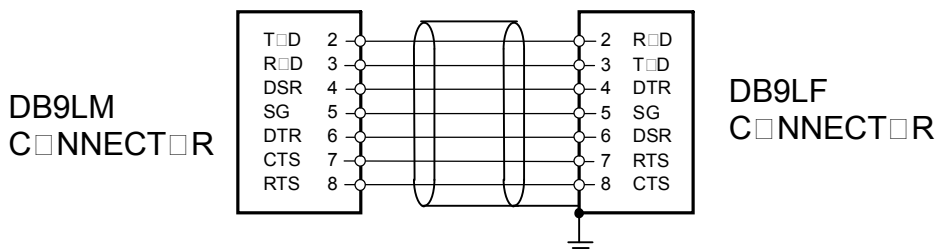

Fig.5-39

6 ERROR MESSAGES

When an error occurs in the execution of an HUST H4D-T series controller, an error message will appear in the LCD screen as shown in Fig.6-1 & Fig.6-2. Possible error messages regarding the HUST H4D-T series controller, together with their remedies, are described as follows.

Code	Causes	Code	Causes	Code	Causes
01	MCM Data Error	13	G/M/T & R Code Error	32	G76/G92 E,P Command Error
02	Follow error > setting value	14	Axis Hardware Over-Travel	36	Transferred Error
04	USB/SDC Error	15	Search Grid Distance Exceed	37	OutSide Device Error
05	System Error	18	End of Program Error	38	Screen Reading time > 3s
07	Flash rom "Write to" Error	20	Axis Software Over-Travel	39	Tool-Life Reaching
08	MDI Command Error	22	EM-Stop	50	User Defined Error(G65)
09	G31 Signal Read Error	25	G02/G03 Command Error	53(1)	Tapping Retract Position Error
10	RS232 Error	28	G71~G73 Command Error	53(2)	Tapping Depth < 0
11	Program Check Sum Error	29	A,R,C of G Code Error	54	Tapping F(Pitch) not Ddined
12	Program Burning Error	31	PLC Error	55	Tapping Depth not Defined
Spindle		Spindle 1 error Spindle 1 unclamp Spindle 3 error Please press SP "cw" or "ccw", before feed-hold cancel		Spindle 2 error Spindle is running Chuck unclamp	
Feeder		Feeder doesn't meet the positioning			
Other		Turret loose EM-stop X-axis motor error Count limit is reached Z-axis motor error Tool change time out Hydraulic pump error Y-axis motor error Security door error Coolant pump error			
				00	99/99
Back Main				ERROR-LIST	

Fig 6-1 Error Message Display 1

Code	Causes	Code	Causes	Code	Causes																																												
01	MCM Data Error	13	G/M/T & R Code Error	32	G76/G92 E,P Command Error																																												
02	Follow error > setting value	14	Axis Hardware Over-Travel	36	Transferred Error																																												
04	USB/SDC Error	15	Search Grid Distance Exceed	37	OutSide Device Error																																												
05	System Error	18	End of Program Error	38	Screen Reading time > 3s																																												
07	Flash rom "Write to" Error	20	Axis Software Over-Travel	39	Tool-Life Reaching																																												
08	MDI Command Error	22	EM-Stop	50	User Defined Error(G65)																																												
09	G31 Signal Read Error	25	G02/G03 Command Error	53(1)	Tapping Retract Position Error																																												
10	RS232 Error	28	G71~G73 Command Error	53(2)	Tapping Depth < 0																																												
11	Program Check Sum Error	29	A,R,C of G Code Error	54	Tapping F(Pitch) not Ddined																																												
12	Program Burning Error	31	PLC Error	55	Tapping Depth not Defined																																												
<table border="1"> <thead> <tr> <th>NO</th> <th>Y / M / D</th> <th>hh : mm</th> <th>Error list</th> </tr> </thead> <tbody> <tr><td>00</td><td>00 / 00 / 00</td><td>00 : 00</td><td>00</td></tr> <tr><td>00</td><td>00 / 00 / 00</td><td>00 : 00</td><td>00</td></tr> <tr><td>00</td><td>00 / 00 / 00</td><td>00 : 00</td><td>00</td></tr> <tr><td>00</td><td>00 / 00 / 00</td><td>00 : 00</td><td>00</td></tr> <tr><td>00</td><td>00 / 00 / 00</td><td>00 : 00</td><td>00</td></tr> <tr><td>00</td><td>00 / 00 / 00</td><td>00 : 00</td><td>00</td></tr> <tr><td>00</td><td>00 / 00 / 00</td><td>00 : 00</td><td>00</td></tr> <tr><td>00</td><td>00 / 00 / 00</td><td>00 : 00</td><td>00</td></tr> <tr><td>00</td><td>00 / 00 / 00</td><td>00 : 00</td><td>00</td></tr> <tr><td>00</td><td>00 / 00 / 00</td><td>00 : 00</td><td>00</td></tr> </tbody> </table>						NO	Y / M / D	hh : mm	Error list	00	00 / 00 / 00	00 : 00	00	00	00 / 00 / 00	00 : 00	00	00	00 / 00 / 00	00 : 00	00	00	00 / 00 / 00	00 : 00	00	00	00 / 00 / 00	00 : 00	00	00	00 / 00 / 00	00 : 00	00	00	00 / 00 / 00	00 : 00	00	00	00 / 00 / 00	00 : 00	00	00	00 / 00 / 00	00 : 00	00	00	00 / 00 / 00	00 : 00	00
NO	Y / M / D	hh : mm	Error list																																														
00	00 / 00 / 00	00 : 00	00																																														
00	00 / 00 / 00	00 : 00	00																																														
00	00 / 00 / 00	00 : 00	00																																														
00	00 / 00 / 00	00 : 00	00																																														
00	00 / 00 / 00	00 : 00	00																																														
00	00 / 00 / 00	00 : 00	00																																														
00	00 / 00 / 00	00 : 00	00																																														
00	00 / 00 / 00	00 : 00	00																																														
00	00 / 00 / 00	00 : 00	00																																														
00	00 / 00 / 00	00 : 00	00																																														
Back Main			Back																																														

Fig 6-2 Error Message Display 2

Error Code	Details	Causes
01		Incorrect MCM parameter setting.
	B	Each axis returned to origin, GRID limit of the servo motor >1024.

Remedy:

1. Check MCM parameter for correct setting or double-press  to enter "MDI" mode, execute command **G10 P1000** to delete parameter, then re-set parameter.
2. If the controller has rested for more than a year without switching on, the internal memory will disappear. The controller will display [BT1] indicating the battery power is low and you need to contact the dealer.

Error Code	Details	Causes
02	X~C	Excessive error in Axial Follow.
	S	Excessive error in Spindle Follow (>3072).

Remedy:

1. Check the program for excessive setting of F value;
2. Check whether the Resolution setting is correct (Check items 241~ 252, MCM parameters);
3. Check if machine or motor is obstructed. Check the wiring.
4. Check Parameter 533; the default value is 4096.

Error Code	Details	Causes
03	L	M99 count exceeds maximum limit (#10922>#10921).

Message:

Setting of the M02, M30, or M99 counter exceeds the limit of system variables, 10921.

Remedy:

1. Double press "0" button in AUTO mode to clear the counting value.
2. Clear the system variable count of 10922 so it returns to 0, then press  to remove the error.

3. Or run G10 P201 command in AUTO or MDI mode, for clearing the system variable (10921) to 0, then press  again to clear the error.

Error Code	Details	Causes
04	A	U USB/SDC error —FR DISK_ERR
	B	USB/SDC error —FR INT_ERR
	C	USB/SDC error —FR NOT_READY
	D	USB/SDC error —FR NO_FILE
	E	USB/SDC error —FR NO_PATH
	F	USB/SDC error —FR_INVALID_NAME
	G	USB/SDC error —FR_DENIED
	H	USB/SDC error —FR_EXIST
	I	USB/SDC error —FR_INVALID_OBJECT
	J	USB/SDC error —FR_WRITE_PROTECTED
	K	USB/SDC error —FR_INVALID_DRIVE
	L	USB/SDC error —FR_NOT_ENABLED
	M	USB/SDC error —FR_NO_FILESYSTEM
	N	USB/SDC error —FR_MKFS_ABORTED
O	USB/SDC error —FR_TIMEOUT	

Remedy:

1. Make sure the USB is of FAT format and the file extension of the transferred program is correct.
2. Consult the dealer or the manufacturer.

Error Code	Details	Causes
08	D	Incorrect Data Address retrieved when executing ZDNC.
	M	MDI command error (command size greater than 128bytes).
	E	Size of current program segment exceeds 128bytes.

Remedy:

Check the program and make sure that each segment is within 128 characters.

Error Code	Details	Causes
10	O	RS232 error —OVERRUN ERROR
	P	RS232 error —PARITY ERROR
	F	RS232 error —FRAME ERROR
	B	RS232 error —BREAK ERROR
	N	RS232 error —OTHER ERROR

Remedy:

1. Check transmission speed of controller communication port, i.e., parameter 520 of MCM is the same value as that of PC or man-machine interface.

2. Check the communication cables between the controller and the PC or the man-machine interface.

Error Code	Details	Causes
11	1	CHECKSUM error of program
	A	SUM error in the Start-up check
	D	Program Memory address error (DOWN MODE)
	F	Program Memory is full
	U	Program Memory address error (UP MODE)

Remedy:

Double-press  button to enter MDI mode. Run **G10 P2001** command to clear all the program data, check the memory battery. If the controller displays battery low (BT1) message, you need to replace the battery (data in the memory will be lost if the controller remains OFF for more than one year).

Error Code	Details	Causes
12		The size of the burn-in program exceeds the limit H4 Series:56k H6 Standard: 56k= 896 lines, 64bytes per line H6 Turning/Milling: 56k +128k (saving capacity for function key) =2944 lines. Since the current limit for burn-in is 128k, therefore the maximum size is 128k (=2048 lines).
	N	The declared command exceeds 20 program lines (G11, G12, G04, M-code).
	L	L error in "G10 P0920 Lxxxx" (L shall not be empty, and 0<=LA<1000)
	P	Program specified by Lxxxx in "G10 P0921 Lxxxx" has not been declared.

Remedy:

1. Check the program for incorrect writing.
2. Check the capacity for the program.

Error Code	Details	Causes
13	G	G error code. During the G87 command, neither of R209 BIT10 and 11 is ON.
	T	T error code.
	M	M error code (MA<0).
	R	An R error in commands G81~G89. (1) R and Z(A) have different symbols. (2) R and [Z(A)-R] have different symbols.

Remedy:

1. Check the program and make sure the G-code setting is correct
2. Check if the PLC is set to support the G-command.

Error Code	Details	Causes
14	X C	X, Y, Z, A, B, or C-axis Hard limit (OT) .

Remedy:

Manually move the axis into its working range.

Error Code	Details	Causes
15	L	Servo motor returns to Origin to find GRID signal, the distance exceeds the setting range of the parameter.

Remedy:

1. Make sure that values set for parameters 401~406 are greater than the distance made by one revolution of the servo motor.
Ex.:
Distance of one revolution of the X-axis servo motor = 5.000mm, then
MCM401 = 5.200
2. Check the CPU for correct wiring.

Error Code	Details	Causes
18		There have some error in programming occurs when executing the program in AUTO mode.
	C	Error of copied segment in the program; cause for the error may be one of the following: 1. Non-existence of the source program. 2. Starting line-no. > Ending line-no. in the source program 3. Starting line-no. > total line-number of the source program 4. Ending line-no. > total line-number of the source program 5. Missing program number in the pasting target. 6. Starting line-no. of the pasting target > total line-number. 7. Memory is full when the pasting content has not been fully pasted. 8. Source program = pasting target program no.; and, starting line of source program <= starting line no. of pasting target <= ending line no. of source program.
	M	Trigger C25 segment data retrieval error: cannot find initial address of specified segment.
	T	Failure in finding initial address of specified program.
	Q	M95Qxxx error (QA is out of 0~127, or QA specified program does not exist).
	L	M99 jump-back program error (G10P301 specified line-no. error).
P	Empty CALL in sub-program. (G60...G63)	

Remedy:

1. Check the ending of the program and add M02 or M03 segment.
2. Check the program for excessive size.
3. Check for any error in the segment content and in serial setting (N) of the specified segment.

Error Code	Details	Causes
20	X C	X, Y, Z, A, B, C- axis software OT limit.
	N	Number of position limits set in the dynamic range of the software exceeds 4000.

Remedy:

Check the program or re-set MCM parameters 581~586 and 601~606, the software travel limits.

Error Code	Details	Causes
22		Emergency Stop (C002=1).

Remedy:

After removal of error, turn off the Emergency Stop pushbutton, followed by pressing the RESET button.

Error Code	Details	Causes
24		Memory Stack error.

Remedy:

Check for repetitive use of CALL subroutine.

Error Code	Details	Causes
25		G02/G03 command error (Radius of starting point unequal to radius of ending point).
	R	Incorrect input format of R in G02/G03 No displacement in both axes of arc interpolation, or (R<0 in lathe mode).
	L	2*[RAR]>[LENGTH].
	G	I, J, R not specified in G02/G03 command.

Remedy:

Check the program. Re-calculate arc intersection and verify its coordinates.

Error Code	Details	Causes
27	X . . . C	For X~C, when C28=1 and R190 ≠ 0, R190 < the deceleration distance of respective axis after the motor receives the INPUT of G31.

Remedy:

1. Check if R190 setting is too short so that it is less than the acceleration distance.
2. Shorten the acceleration/ deceleration time setting (**Motor load to be considered**).

Error Code	Details	Causes
28	N	MISSING G70 WITH G7x COMMAND.
	W	[ZA] DIR. SHOULD BE DIFFERENT FROM [G70WA].
	U	[XA] DIR. SHOULD BE DIFFERENT FROM [G70UA].

Remedy:

Check for any error in the cutting cycle command of the lathe.

Error Code	Details	Causes
29	G	The G code that includes C, R, or A segment is not G00..G04.
	P	Incorrect parameter setting.
	A	Incorrect setting of A_ or its relative parameter.
	R	Incorrect setting of R_ or its relative parameter.
	C	Incorrect setting of C_ or its relative parameter

Remedy:

Check if the relative parameter setting is incorrect.

Error Code	Details	Causes
31		Missing PLC.

Remedy:

1. Upload the PLC.
2. Consult the dealer or the manufacturer.

Error Code	Details	Causes
32	E	E in G92 is not within the (1.0~100.0) range (imperial unit).
	P	P in G76 is not within the (30~90) range.
	L	End of cutting – preset length < max. cutting depth.
	D	G76 (max. cutting depth) < 0.
	C	CANPX-CANPR < CHAMX Threading length < threading tool withdraw length.

Remedy:

Check for any error in the cyclic tapping command of the lathe.

Error Code	Details	Causes
33	4	Kxx=0 in G34.
	5	Kxx=0 in G35.
	6	Kxx=0 in G36.
	7	Pxx<=0 or Kxx=0 in G37.
		Execute G35, G36, or G37 in lathe mode.

Remedy:

Check for any error in K setting in commands G34~37 of the lathe.

Error Code	Details	Causes
36	B	Header of USB/SDC file is not 'O8001'. Header of USB/SDC file is not 'O8002'.
	C	Header of MCM file is not 'O9002'.
	F	Header of function key file is not 'O9140'. Header of variable file is not 'O9004'.
	L	Header of PLC file is not 'O9003'. Size of PLC document exceeds upper limit.
	P	Input program no. exceeds 1000 (Oxxxx).
	R	LENGTH OR SUM ERROR #13245, #13246, #13247, #13248.
	S	Header of SYS file is not 'O9100'. Size of SYS document exceeds upper limit.
	T	Header of TBL file is not 'O9110'.
W	Input hex file is not in XXXX,0DH format.	

Remedy:

Check for incorrect data transfer format.

Error Code	Details	Causes
37		NC ALARM (C007=1).

Remedy:

Check external control device, remove error and RESET.

Error Code	Details	Causes
38		Excessive screen display time (>3000ms).

Remedy:

1. Re-transfer screen data file.
2. Consult dealer or manufacturer.

Error Code	Details	Causes
41		In Tool Offset mode, the command paths between 2 single blocks are 2 parallel lines.
42		OVER CUT
43		Insufficient distance between Start and End (<0.005).
45		C251=0, Between the single block that the radius of circular arc compensation < 0
46		In Tool Offset mode, the system fails to determine the center-of-arc when executing an arc command.
48		Radius of tool offset < 0.
49		Direction of tool tip in the lathe is not of the 0~9 type Number of segment of axial displacement is greater than 10

Remedy:

1. Check for any error in tool offset value.
2. Check the program for any error.

Error Code	Details	Causes
50 . . . 99		Customer-defined error alarm using G65.

Remedy:

Check for any error in the setting of G65, customer-defined error message.

7 MCM (Machine Constant) PARAMETERS

MCM No.	Factory Default Setting	Unit	Description	Setting
1	0	mm	G54 □-axis 1 st Work coordinate (origin)	
2	0	mm	G54 □-axis 1 st Work coordinate (origin)	
3	0	mm	G54 □-axis 1 st Work coordinate (origin)	
4	0	mm	G54 A-axis 1 st Work coordinate (origin)	
5	0	mm	G54 B-axis 1 st Work coordinate (origin)	
6	0	mm	G54 C-axis 1 st Work coordinate (origin)	
7	0	mm	G54 U-axis 1 st Work coordinate (origin)	
8	0	mm	G54 V-axis 1 st Work coordinate (origin)	
9	0	mm	G54 W-axis 1 st Work coordinate (origin)	
10-20			System Reserved !	
21	0	mm	G55 □-axis 2 nd Work coordinate (origin)	
22	0	mm	G55 □-axis 2 nd Work coordinate (origin)	
23	0	mm	G55 □-axis 2 nd Work coordinate (origin)	
24	0	mm	G55 A-axis 2 nd Work coordinate (origin)	
25	0	mm	G55 B-axis 2 nd Work coordinate (origin)	
26	0	mm	G55 C-axis 2 nd Work coordinate (origin)	
27	0	mm	G55 U-axis 2 nd Work coordinate (origin)	
28	0	mm	G55 V-axis 2 nd Work coordinate (origin)	
29	0	mm	G55 W-axis 2 nd Work coordinate (origin)	
30-40			System Reserved !	
41	0	mm	G56 □-axis 3 rd Work coordinate (origin)	
42	0	mm	G56 □-axis 3 rd Work coordinate (origin)	
43	0	mm	G56 □-axis 3 rd Work coordinate (origin)	
44	0	mm	G56 A-axis 3 rd Work coordinate (origin)	
45	0	mm	G56 B-axis 3 rd Work coordinate (origin)	
46	0	mm	G56 C-axis 3 rd Work coordinate (origin)	
47	0	mm	G56 U-axis 3 rd Work coordinate (origin)	
48	0	mm	G56 V-axis 3 rd Work coordinate (origin)	
49	0	mm	G56 W-axis 3 rd Work coordinate (origin)	
50-60			System Reserved !	
61	0	mm	G57 □-axis 4 th Work coordinate (origin)	
62	0	mm	G57 □-axis 4 th Work coordinate (origin)	
63	0	mm	G57 □-axis 4 th Work coordinate (origin)	
64	0	mm	G57 A-axis 4 th Work coordinate (origin)	
65	0	mm	G57 B-axis 4 th Work coordinate (origin)	
66	0	mm	G57 C-axis 4 th Work coordinate (origin)	
67	0	mm	G57 U-axis 4 th Work coordinate (origin)	
68	0	mm	G57 V-axis 4 th Work coordinate (origin)	
69	0	mm	G57 W-axis 4 th Work coordinate (origin)	
70-80			System Reserved !	
81	0	mm	G58 □-axis 5 th Work coordinate (origin)	
82	0	mm	G58 □-axis 5 th Work coordinate (origin)	
83	0	mm	G58 □-axis 5 th Work coordinate (origin)	
84	0	mm	G58 A-axis 5 th Work coordinate (origin)	
85	0	mm	G58 B-axis 5 th Work coordinate (origin)	
86	0	mm	G58 C-axis 5 th Work coordinate (origin)	
87	0	mm	G58 U-axis 5 th Work coordinate (origin)	
88	0	mm	G58 V-axis 5 th Work coordinate (origin)	
89	0	mm	G58 W-axis 5 th Work coordinate (origin)	

MCM No.	Factory Default Setting	Unit	Description	Setting
90-100			System Reserced !	
101	0	mm	G59 X-axis 6 th Work coordinate (origin)	
102	0	mm	G59 Y-axis 6 th Work coordinate (origin)	
103	0	mm	G59 Z-axis 6 th Work coordinate (origin)	
104	0	mm	G59 A-axis 6 th Work coordinate (origin)	
105	0	mm	G59 B-axis 6 th Work coordinate (origin)	
106	0	mm	G59 C-axis 6 th Work coordinate (origin)	
107	0	mm	G59 U-axis 6 th Work coordinate (origin)	
108	0	mm	G59 V-axis 6 th Work coordinate (origin)	
109	0	mm	G59 W-axis 6 th Work coordinate (origin)	
110-120			System Reserced !	
121	0	mm	X-axis, G28 reference point coordinate	
122	0	mm	Y-axis, G28 reference point coordinate	
123	0	mm	Z-axis, G28 reference point coordinate	
124	0	mm	A-axis, G28 reference point coordinate	
125	0	mm	B-axis, G28 reference point coordinate	
126	0	mm	C-axis, G28 reference point coordinate	
127	0	mm	U-axis, G28 reference point coordinate	
128	0	mm	V-axis, G28 reference point coordinate	
129	0	mm	W-axis, G28 reference point coordinate	
130-140			System Reserced !	
141	0	mm	X-axis, G30 reference point coordinate	
142	0	mm	Y-axis, G30 reference point coordinate	
143	0	mm	Z-axis, G30 reference point coordinate	
144	0	mm	A-axis, G30 reference point coordinate	
145	0	mm	B-axis, G30 reference point coordinate	
146	0	mm	C-axis, G30 reference point coordinate	
147	0	mm	U-axis, G30 reference point coordinate	
148	0	mm	V-axis, G30 reference point coordinate	
149	0	mm	W-axis, G30 reference point coordinate	
150-160			System Reserced !	
161	0	mm	X-axis, Backlash compensation (G01), 0-9.999	
162	0	mm	Y-axis, Backlash compensation (G01), 0-9.999	
163	0	mm	Z-axis, Backlash compensation (G01), 0-9.999	
164	0	mm	A-axis, Backlash compensation (G01), 0-9.999	
165	0	mm	B-axis, Backlash compensation (G01), 0-9.999	
166	0	mm	C-axis, Backlash compensation (G01), 0-9.999	
167	0	mm	U-axis, Backlash compensation (G01), 0-9.999	
168	0	mm	V-axis, Backlash compensation (G01), 0-9.999	
169	0	mm	W-axis, Backlash compensation (G01), 0-9.999	
170-180			System Reserced !	
181	0	mm	X-axis, Backlash compensation (G00), 0-9.999	
182	0	mm	Y-axis, Backlash compensation (G00), 0-9.999	
183	0	mm	Z-axis, Backlash compensation (G00), 0-9.999	
184	0	mm	A-axis, Backlash compensation (G00), 0-9.999	
185	0	mm	B-axis, Backlash compensation (G00), 0-9.999	
186	0	mm	C-axis, Backlash compensation (G00), 0-9.999	
187	0	mm	U-axis, Backlash compensation (G00), 0-9.999	
188	0	mm	V-axis, Backlash compensation (G00), 0-9.999	
189	0	mm	W-axis, Backlash compensation (G00), 0-9.999	
190-200			System Reserced !	
201	1000	mm/min	X-axis, G Feed-rate	

MCM No.	Factory Default Setting	Unit	Description	Setting
202	1000	mm/min	X-axis, □□G Feed-rate	
203	1000	mm/min	X-axis, □□G Feed-rate	
204	1000	mm/min	A-axis, □□G Feed-rate	
205	1000	mm/min	B-axis, □□G Feed-rate	
206	1000	mm/min	C-axis, □□G Feed-rate	
207	1000	mm/min	U-axis, □□G Feed-rate	
208	1000	mm/min	V-axis, □□G Feed-rate	
209	1000	mm/min	W-axis, □□G Feed-rate	
210-220			System Reserved !	
221	10000	mm/min	X-axis, G00 Traverse speed limit	
222	10000	mm/min	X-axis, G00 Traverse speed limit	
223	10000	mm/min	X-axis, G00 Traverse speed limit	
224	10000	mm/min	A-axis, G00 Traverse speed limit	
225	10000	mm/min	B-axis, G00 Traverse speed limit	
226	10000	mm/min	C-axis, G00 Traverse speed limit	
227	10000	mm/min	U-axis, G00 Traverse speed limit	
228	10000	mm/min	V-axis, G00 Traverse speed limit	
229	10000	mm/min	W-axis, G00 Traverse speed limit	
230-240			System Reserved !	
241	100	pulse	X-axis, Denominator, resolution calc. (Encoder pulse)	
242	100	μm	X-axis, Numerator, resolution calculation. (Ball-screwpitch)	
243	100	pulse	X-axis, Denominator, resolutioncalc. (Encoder pulse)	
244	100	μm	X-axis, Numerator, resolutioncalc. (Ball-screwpitch)	
245	100	pulse	X-axis, Denominator, resolutioncalc. (Encoder pulse)	
246	100	μm	X-axis, Numerator, resolutioncalc. (Ball-screwpitch)	
247	100	pulse	A-axis, Denominator, resolutioncalc. (Encoder pulse)	
248	100	μm	A-axis, Numerator, resolutioncalc. (Ball-screwpitch)	
249	100	pulse	B-axis, Denominator, resolutioncalc. (Encoder pulse)	
250	100	μm	B-axis, Numerator, resolutioncalc. (Ball-screwpitch)	
251	100	pulse	C-axis, Denominator, resolutioncalc. (Encoder pulse)	
252	100	μm	C-axis, Numerator, resolutioncalc. (Ball-screwpitch)	
253	100	pulse	U-axis, Denominator, resolutioncalc. (Encoder pulse)	
254	100	μm	U-axis, Numerator, resolutioncalc. (Ball-screwpitch)	
255	100	pulse	V-axis, Denominator, resolutioncalc. (Encoder pulse)	
256	100	μm	V-axis, Numerator, resolutioncalc. (Ball-screwpitch)	
257	100	pulse	W-axis, Denominator, resolutioncalc. (Encoder pulse)	
258	100	μm	W-axis, Numerator, resolutioncalc. (Ball-screwpitch)	
259-280			System Reserved !	
281	0		X-axis, H□ME direction, 0□□ dir. 1□-dir	
282	0		X-axis, H□ME direction, 0□□ dir. 1□-dir	
283	0		X-axis, H□ME direction, 0□□ dir. 1□-dir	
284	0		A-axis, H□ME direction, 0□□ dir. 1□-dir	
285	0		B-axis, H□ME direction, 0□□ dir. 1□-dir	
286	0		C-axis, H□ME direction, 0□□ dir. 1□-dir	
287	0		U-axis, H□ME direction, 0□□ dir. 1□-dir	
288	0		V-axis, H□ME direction, 0□□ dir. 1□-dir	
289	0		W-axis, H□ME direction, 0□□ dir. 1□-dir	
287-300			System Reserved !	
301	2500	mm/min	X-axis, H□ME speed 1	
302	2500	mm/min	X-axis, H□ME speed 1	
303	2500	mm/min	X-axis, H□ME speed 1	

MCM No.	Factory Default Setting	Unit	Description	Setting
304	2500	mm/min	A-axis, HOME speed 1	
305	2500	mm/min	B-axis, HOME speed 1	
306	2500	mm/min	C-axis, HOME speed 1	
207	2500	mm/min	U-axis, HOME speed 1	
308	2500	mm/min	V-axis, HOME speed 1	
309	2500	mm/min	W-axis, HOME speed 1	
310-320			System Reserved !	
321	40	mm/min	X-axis, Home grid speed during HOME execution	
322	40	mm/min	Y-axis, Home grid speed during HOME execution	
323	40	mm/min	Z-axis, Home grid speed during HOME execution	
324	40	mm/min	A-axis, Home grid speed during HOME execution	
325	40	mm/min	B-axis, Home grid speed during HOME execution	
326	40	mm/min	C-axis, Home grid speed during HOME execution	
327	40	mm/min	U-axis, Home grid speed during HOME execution	
328	40	mm/min	V-axis, Home grid speed during HOME execution	
329	40	mm/min	W-axis, Home grid speed during HOME execution	
330-340			System Reserved !	
341	0	0/1	X-axis, Home grid direction during HOME execution	
342	0	0/1	Y-axis, Home grid direction during HOME execution	
343	0	0/1	Z-axis, Home grid direction during HOME execution	
344	0	0/1	A-axis, Home grid direction during HOME execution	
345	0	0/1	B-axis, Home grid direction during HOME execution	
346	0	0/1	C-axis, Home grid direction during HOME execution	
347	0	0/1	U-axis, Home grid direction during HOME execution	
348	0	0/1	V-axis, Home grid direction during HOME execution	
349	0	0/1	W-axis, Home grid direction during HOME execution	
350-360			System Reserved !	
361	0	mm	X-axis Home grid setting	
362	0	mm	Y-axis Home grid setting	
363	0	mm	Z-axis Home grid setting	
364	0	mm	A-axis Home grid setting	
365	0	mm	B-axis Home grid setting	
366	0	mm	C-axis Home grid setting	
367	0	mm	U-axis Home grid setting	
368	0	mm	V-axis Home grid setting	
369	0	mm	W-axis Home grid setting	
370-380			System Reserved !	
381	0	mm	X-axis, HOME shift data	
382	0	mm	Y-axis, HOME shift data	
383	0	mm	Z-axis, HOME shift data	
384	0	mm	A-axis, HOME shift data	
385	0	mm	B-axis, HOME shift data	
386	0	mm	C-axis, HOME shift data	
387	0	mm	U-axis, HOME shift data	
388	0	mm	V-axis, HOME shift data	
389	0	mm	W-axis, HOME shift data	
390-400			System Reserved !	
401	10.000	mm	X-axis, Setting the value of search sero grid	
402	10.000	mm	Y-axis, Setting the value of search sero grid	
403	10.000	mm	Z-axis, Setting the value of search sero grid	
404	10.000	mm	A-axis, Setting the value of search sero grid	
405	10.000	mm	B-axis, Setting the value of search sero grid	

MCM No.	Factory Default Setting	Unit	Description	Setting
406	10.000	mm	C-axis,Setting the value of search sero grid	
407	10.000	mm	U-axis,Setting the value of search sero grid	
408	10.000	mm	V-axis,Setting the value of search sero grid	
409	10.000	mm	W-axis,Setting the value of search sero grid	
410-420	0		System Reserved !	
421	0		X-axis origin switch (N. (normallyopen) node-N.C (normally closed) node)	
422	0		X-axis origin switch (N. node-N.C node)	
423	0		X-axis origin switch (N. node-N.C node)	
424	0		A-axis origin switch (N. node-N.C node)	
425	0		B-axis origin switch (N. node-N.C node)	
426	0		C-axis origin switch (N. node-N.C node)	
427	0		U-axis origin switch (N. node-N.C node)	
428	0		V-axis origin switch (N. node-N.C node)	
429	0		W-axis origin switch (N. node-N.C node)	
430-440			System Reserved !	
441	0		X-axis, Direction of motor rotation, 0CW, 1CCW	
442	0		X-axis, Direction of motor rotation, 0CW, 1CCW	
443	0		X-axis, Direction of motor rotation, 0CW, 1CCW	
444	0		A-axis, Direction of motor rotation, 0CW, 1CCW	
445	0		B-axis, Direction of motor rotation, 0CW, 1CCW	
446	0		C-axis, Direction of motor rotation, 0CW, 1CCW	
447	0		U-axis, Direction of motor rotation, 0CW, 1CCW	
448	0		V-axis, Direction of motor rotation, 0CW, 1CCW	
449	0		W-axis, Direction of motor rotation, 0CW, 1CCW	
450-460			System Reserved !	
461	4		X-axis,Encoder pulse multiplicationfactor,1,2,or 4	
462	4		X-axis,Encoder pulse multiplicationfactor,1,2,or 4	
463	4		X-axis,Encoder pulse multiplicationfactor,1,2,or 4	
464	4		A-axis,Encoder pulse multiplicationfactor,1,2,or 4	
465	4		B-axis,Encoder pulse multiplicationfactor,1,2,or 4	
466	4		C-axis,Encoder pulse multiplicationfactor,1,2,or 4	
467	4		U-axis,Encoder pulse multiplicationfactor,1,2,or 4	
468	4		V-axis,Encoder pulse multiplicationfactor,1,2,or 4	
469	4		W-axis,Encoder pulse multiplicationfactor,1,2,or 4	
470-480			System Reserved !	
481	5		X-axis impulse command width adjustment (4625PPS)	
482	5		X-axis impulse command width adjustment (4625PPS)	
483	5		X-axis impulse command width adjustment (4625PPS)	
484	5		A-axis impulse command width adjustment (4625PPS)	
485	5		B-axis impulse command width adjustment (4625PPS)	
486	5		C-axis impulse command width adjustment (4625PPS)	
487	5		U-axis impulse command width adjustment (4625PPS)	
488	5		V-axis impulse command width adjustment (4625PPS)	
489	5		W-axis impulse command width adjustment	

MCM No.	Factory Default Setting	Unit	Description	Setting
			(4□625□PPS)	
490-500	6		System Reser□ed !	
501	0		Master/Slave mode, 0□CNC, 1□□-axis, 2□□-axis 3□□-axis,4□A-axis,5□B-axis,6□C-axis,7□U-axis, 8□V-axis, 9□w-axis, 256□ non-stop mode in a single block	
502	0		Accel□Decel mode,0□exponential,1□linear,2□□S□cur□e	
503	0		Home command mode setting.	
			BIT0 □0 , □ axis find Home grid a□ailable, □1 , no need to find.	
			BIT1 □0 , □ axis find Home grid a□ailable, □1 , no need to find.	
			BIT2 □0 , □ axis find Home grid a□ailable, □1 , no need to find.	
			BIT3 □0 , A axis find Home grid a□ailable, □1 , no need to find.	
			BIT4 □0 , B axis find Home grid a□ailable, □1 , no need to find.	
			BIT5 □0 , C axis find Home grid a□ailable, □1 , no need to find.	
			BIT6 □0 , U axis find Home grid a□ailable, □1 , no need to find.	
			BIT7 □0 , V axis find Home grid a□ailable, □1 , no need to find.	
BIT8 □0 , W axis find Home grid a□ailable, □1 , no need to find.				
504	100	msec	G01 Linear accel.□decel. Time, 10□1024 ms	
505	100	msec	Accel□Decel time when in G99 mode (mm□re□)	
506	100	msec	Time Setting for spindle acceleration	
507	100	msec	System Reser□ed !	
508	0		Spindle encoder resolution (pulse□re□)	
509	4096	pulse	Max. spindle rpm at 10 □olts	
510	3000	rpm	Spindle □oltage command □ero drift correction (open circuit)	
511	0	□	Spindle □oltage command acce□dece slope correction (open circuit)	
512	0		Spindle RPM correction (based on feedback from the encoder)	
513	0	rpm	Start number for program block number generation	
514	0		Increment for program block number generation	
515	0		Denominator of feed-rate when in MPG test mode	
516	1		Numerator of feed-rate when in MPG test mode	
517	1		MPG direction	
518	0		Set Acceleration□Deceleration Time for MPG (4□512)	
519	64	ms	RS232 Baud rate, 38400, 19200 □EVEN □2 Bit	
520	38400		Setting whether R000□R99 data in PLC are stored when power is cut off. 0□N□, 256□□ES	
521	0		Ser□o Error Counter	
522	0	pulse	Radius□Diameter Programming mode	
523	0		0□Metric mode, 25400□inch mode mcm541□0,1	
524	0		Error in Circular Cutting, ideal □alue□1	
525	3		Pulse settings	
			0□pulse □direction 1□□□ pulse 2□A□B phase	

MCM No.	Factory Default Setting	Unit	Description	Setting
526	0		Setting G01 speed value at booting	
527	1000		Setting tool compensation direction <input type="checkbox"/> 1 FAUNC, <input type="checkbox"/> 0 HUST	
528	0		It is used for adjusting the G01's acceleration/deceleration time when the acceleration/deceleration type is set to an <input type="checkbox"/> S curve. When MCM 502=2, the function can then be sustained.G01 Linear accel./decel. Time, for <input type="checkbox"/> S curve	
529	0		G31 input motion stop at hardware	
530	0		Format setting <input type="checkbox"/> 0 standard, <input type="checkbox"/> 1 the system will automatically add a decimal point to even numbers <input type="checkbox"/> variable automatically added with a decimal point, <input type="checkbox"/> 2 line editing, <input type="checkbox"/> 4 automatically added with a decimal point in programming	
531	0		Mill mode ; Setting the backlash of G83	
532	2.000	mm	Setting the following error count for testing	
533	4096	pulse	Testing the function of axial setting of the ser ^o following error (bit0- <input type="checkbox"/> ..)	
534			Controller ID number	
535			Minimum slope setting of the Auto Teach function (with use of C040)	
536			First distance setting of the Auto Teach function (with use of C040)	
537			G41 and G42 processing types	
538	0		System reset	
539			Adjustment of the axis feedback direction.	
540	0		Arc type	
541	0		System Reset !	
541-560			"S" curve accel./decel. profile setting for the <input type="checkbox"/> -axis	
561	0		"S" curve accel./decel. profile setting for the <input type="checkbox"/> -axis	
562	0		"S" curve accel./decel. profile setting for the <input type="checkbox"/> -axis	
563	0		"S" curve accel./decel. profile setting for the A-axis	
564	0		"S" curve accel./decel. profile setting for the B-axis	
565	0		"S" curve accel./decel. profile setting for the C-axis	
566	0		"S" curve accel./decel. profile setting for the U-axis	
567	0		"S" curve accel./decel. profile setting for the V-axis	
568	0		"S" curve accel./decel. profile setting for the W-axis	
569	0		System Reset !	
570-580			<input type="checkbox"/> -axis, Software <input type="checkbox"/> T limit, (<input type="checkbox"/> direction (Group 1)	
581	9999999	mm	<input type="checkbox"/> -axis, Software <input type="checkbox"/> T limit, (<input type="checkbox"/> direction (Group 1)	
582	9999999	mm	<input type="checkbox"/> -axis, Software <input type="checkbox"/> T limit, (<input type="checkbox"/> direction (Group 1)	
583	9999999	mm	A-axis, Software <input type="checkbox"/> T limit, (<input type="checkbox"/> direction (Group 1)	
584	9999999	mm	B-axis, Software <input type="checkbox"/> T limit, (<input type="checkbox"/> direction (Group 1)	
585	9999999	mm	C-axis, Software <input type="checkbox"/> T limit, (<input type="checkbox"/> direction (Group 1)	
586	9999999	mm	U-axis, Software <input type="checkbox"/> T limit, (<input type="checkbox"/> direction (Group 1)	
587	9999999	mm	V-axis, Software <input type="checkbox"/> T limit, (<input type="checkbox"/> direction (Group 1)	
588	9999999	mm	W-axis, Software <input type="checkbox"/> T limit, (<input type="checkbox"/> direction (Group 1)	
589	9999999	mm	System Reset !	
590-600			<input type="checkbox"/> -axis, Software <input type="checkbox"/> T limit, (-) direction (Group 1)	
601	-9999999	mm	<input type="checkbox"/> -axis, Software <input type="checkbox"/> T limit, (-) direction (Group 1)	

MCM No.	Factory Default Setting	Unit	Description	Setting
602	-9999999	mm	<input type="checkbox"/> -axis, Software <input type="checkbox"/> T limit, (-) direction (Group 1)	
603	-9999999	mm	A-axis, Software <input type="checkbox"/> T limit, (-) direction (Group 1)	
604	-9999999	mm	B-axis, Software <input type="checkbox"/> T limit, (-) direction (Group 1)	
605	-9999999	mm	C-axis, Software <input type="checkbox"/> T limit, (-) direction (Group 1)	
606	-9999999	mm	U-axis, Software <input type="checkbox"/> T limit, (-) direction (Group 1)	
607	-9999999	mm	V-axis, Software <input type="checkbox"/> T limit, (-) direction (Group 1)	
608	-9999999	mm	W-axis, Software <input type="checkbox"/> T limit, (-) direction (Group 1)	
609	-9999999	mm	System Reser _{ved} !	
610-620			<input type="checkbox"/> -axis, Software <input type="checkbox"/> T limit, (<input type="checkbox"/>) direction (Group 2)	
621	9999999	mm	<input type="checkbox"/> -axis, Software <input type="checkbox"/> T limit, (<input type="checkbox"/>) direction (Group 2)	
622	9999999	mm	<input type="checkbox"/> -axis, Software <input type="checkbox"/> T limit, (<input type="checkbox"/>) direction (Group 2)	
623	9999999		A-axis, Software <input type="checkbox"/> T limit, (<input type="checkbox"/>) direction (Group 2)	
624	9999999	mm	B-axis, Software <input type="checkbox"/> T limit, (<input type="checkbox"/>) direction (Group 2)	
625	9999999	mm	C-axis, Software <input type="checkbox"/> T limit, (<input type="checkbox"/>) direction (Group 2)	
626	9999999	mm	U-axis, Software <input type="checkbox"/> T limit, (<input type="checkbox"/>) direction (Group 2)	
627	9999999	mm	V-axis, Software <input type="checkbox"/> T limit, (<input type="checkbox"/>) direction (Group 2)	
628	9999999	mm	W-axis, Software <input type="checkbox"/> T limit, (<input type="checkbox"/>) direction (Group 2)	
629	9999999	mm	System Reser _{ved} !	
630-640			<input type="checkbox"/> -axis, Software <input type="checkbox"/> T limit, (-) direction (Group 2)	
641	-9999999	mm	<input type="checkbox"/> -axis, Software <input type="checkbox"/> T limit, (-) direction (Group 2)	
642	-9999999	mm	<input type="checkbox"/> -axis, Software <input type="checkbox"/> T limit, (-) direction (Group 2)	
643	-9999999	mm	A-axis, Software <input type="checkbox"/> T limit, (-) direction (Group 2)	
644	-9999999	mm	B-axis, Software <input type="checkbox"/> T limit, (-) direction (Group 2)	
645	-9999999	mm	C-axis, Software <input type="checkbox"/> T limit, (-) direction (Group 2)	
646	-9999999	mm	U-axis, Software <input type="checkbox"/> T limit, (-) direction (Group 2)	
647	-9999999	mm	V-axis, Software <input type="checkbox"/> T limit, (-) direction (Group 2)	
648	-9999999	mm	W-axis, Software <input type="checkbox"/> T limit, (-) direction (Group 2)	
649	-9999999	mm	System Reser _{ved} !	
650-660			<input type="checkbox"/> -axis, Cycle clearing w _{ith} <input type="checkbox"/> M02, M30, M99	
661	0		<input type="checkbox"/> -axis, Cycle clearing w _{ith} <input type="checkbox"/> M02, M30, M99	
662	0		<input type="checkbox"/> -axis, Cycle clearing w _{ith} <input type="checkbox"/> M02, M30, M99	
663	0		A-axis, Cycle clearing w _{ith} <input type="checkbox"/> M02, M30, M99	
664	0		B-axis, Cycle clearing w _{ith} <input type="checkbox"/> M02, M30, M99	
665	0		C-axis, Cycle clearing w _{ith} <input type="checkbox"/> M02, M30, M99	
666	0		U-axis, Cycle clearing w _{ith} <input type="checkbox"/> M02, M30, M99	
667	0		V-axis, Cycle clearing w _{ith} <input type="checkbox"/> M02, M30, M99	
668	0		W-axis, Cycle clearing w _{ith} <input type="checkbox"/> M02, M30, M99	
669	0		System Reser _{ved} !	
670-680	0		<input type="checkbox"/> -axis, 0 <input type="checkbox"/> incremental coord., 1 <input type="checkbox"/> absolute coordinate	
681	1		<input type="checkbox"/> -axis, 0 <input type="checkbox"/> incremental coord., 1 <input type="checkbox"/> absolute coordinate	
682	1		<input type="checkbox"/> -axis, 0 <input type="checkbox"/> incremental coord., 1 <input type="checkbox"/> absolute coordinate	
683	1		A-axis, 0 <input type="checkbox"/> incremental coord., 1 <input type="checkbox"/> absolute coordinate	
684	1		B-axis, 0 <input type="checkbox"/> incremental coord., 1 <input type="checkbox"/> absolute coordinate	
685	1		C-axis, 0 <input type="checkbox"/> incremental coord., 1 <input type="checkbox"/> absolute coordinate	
686	1		U-axis, 0 <input type="checkbox"/> incremental coord., 1 <input type="checkbox"/> absolute coordinate	
687	1		V-axis, 0 <input type="checkbox"/> incremental coord., 1 <input type="checkbox"/> absolute coordinate	
688	1		W-axis, 0 <input type="checkbox"/> incremental coord., 1 <input type="checkbox"/> absolute coordinate	
689	1		System Reser _{ved} !	
690-700	1		<input type="checkbox"/> -axis, Position gain, standard <input type="checkbox"/> 64	
701	64	pulse	<input type="checkbox"/> -axis, Position gain, standard <input type="checkbox"/> 64	
702	64	pulse	<input type="checkbox"/> -axis, Position gain, standard <input type="checkbox"/> 64	

MCM No.	Factory Default Setting	Unit	Description	Setting
703	64	pulse	A-axis, Position gain, standard□64	
704	64	pulse	B-axis, Position gain, standard□64	
705	64	pulse	C-axis, Position gain, standard□64	
706	64	pulse	U-axis, Position gain, standard□64	
707	64	pulse	V-axis, Position gain, standard□64	
708	64	pulse	W-axis, Position gain, standard□64	
709	64	pulse	System Reser□ed !	
710-720	64	pulse	□-axis,Break-o□er point for position gain, std□10	
721	10	pulse	□-axis,Break-o□er point for position gain, std□10	
722	10	pulse	□-axis,Break-o□er point for position gain, std□10	
723	10	pulse	A-axis,Break-o□er point for position gain, std□10	
724	10	pulse	B-axis,Break-o□er point for position gain, std□10	
725	10	pulse	C-axis,Break-o□er point for position gain, std□10	
726	10	pulse	U-axis,Break-o□er point for position gain, std□10	
727	10	pulse	V-axis,Break-o□er point for position gain, std□10	
728	10	pulse	W-axis,Break-o□er point for position gain, std□10	
729	10	pulse	System Reser□ed !	
727-740	10	pulse	□-axis, Denominator, MPG resolution calc.	
741	100		□-axis, Numerator, MPG resolution calc.	
742	100		□-axis, Denominator, MPG resolution calc.	
743	100		□-axis, Numerator, MPG resolution calc.	
744	100		□-axis, Denominator, MPG resolution calc.	
745	100		□-axis, Numerator, MPG resolution calc.	
746	100		A-axis, Denominator, MPG resolution calc.	
747	100		A-axis, Numerator, MPG resolution calc.	
748	100		B-axis, Denominator, MPG resolution calc.	
749	100		B-axis, Numerator, MPG resolution calc.	
750	100		C-axis, Denominator, MPG resolution calc.	
751	100		C-axis, Numerator, MPG resolution calc.	
752	100		U-axis, Denominator, MPG resolution calc.	
753	100		U-axis, Numerator, MPG resolution calc.	
754	100		V-axis, Denominator, MPG resolution calc.	
755	100		V-axis, Numerator, MPG resolution calc.	
756	100		W-axis, Denominator, MPG resolution calc.	
757	100		W-axis, Numerator, MPG resolution calc.	
758	100		System Reser□ed !	
760-780			Set □-axis as Rotating (1) □Linear axis (0)	
781	0		Set □-axis as Rotating (1) □Linear axis (0)	
782	0		Set □-axis as Rotating (1) □Linear axis (0)	
783	0		Set A-axis as Rotating (1) □Linear axis (0)	
784	0		Set B-axis as Rotating (1) □Linear axis (0)	
785	0		Set C-axis as Rotating (1) □Linear axis (0)	
786	0		Set U-axis as Rotating (1) □Linear axis (0)	
787	0		Set V-axis as Rotating (1) □Linear axis (0)	
788	0		Set W-axis as Rotating (1) □Linear axis (0)	
789	0		System Reser□ed !	
790-800			Distance of S bit sent before the □-axis reaches in position. (S176)	
801	0 - 000	mm	Distance of S bit sent before the □-axis reaches in position. (S177)	
802	0 - 000	mm	Distance of S bit sent before the □-axis reaches in position. (S178)	

MCM No.	Factory Default Setting	Unit	Description	Setting
803	0 - 000	mm	Distance of S bit sent before the A-axis reaches in position. (S179)	
804	0 - 000	mm	Distance of S bit sent before the B-axis reaches in position. (S180)	
805	0 - 000	mm	Distance of S bit sent before the C-axis reaches in position. (S181)	
806	0 - 000	mm	Distance of S bit sent before the U-axis reaches in position. (S182)	
807	0 - 000	mm	Distance of S bit sent before the V-axis reaches in position. (S183)	
808	0 - 000	mm	Distance of S bit sent before the W-axis reaches in position. (S184)	
809	0 - 000	mm	System Reser \square ed !	
810-820			Set Acceleration/Deceleration Time for \square -axis	
821	0	msec	Set Acceleration/Deceleration Time for \square -axis	
822	0	msec	Set Acceleration/Deceleration Time for \square -axis	
823	0	msec	Set Acceleration/Deceleration Time for A-axis	
824	0	msec	Set Acceleration/Deceleration Time for B-axis	
825	0	msec	Set Acceleration/Deceleration Time for C-axis	
826	0	msec	Set Acceleration/Deceleration Time for U-axis	
827	0	msec	Set Acceleration/Deceleration Time for V-axis	
828	0	msec	Set Acceleration/Deceleration Time for W-axis	
829	0	msec	System Reser \square ed !	
830-840			\square -axis allowable compensation of back screw pitch	
841	0		\square -axis allowable compensation of back screw pitch	
842	0		\square -axis allowable compensation of back screw pitch	
843	0		A-axis allowable compensation of back screw pitch	
844	0		B-axis allowable compensation of back screw pitch	
845	0		C-axis allowable compensation of back screw pitch	
846	0		U-axis allowable compensation of back screw pitch	
847	0		V-axis allowable compensation of back screw pitch	
848	0		W-axis allowable compensation of back screw pitch	
849	0		System Reser \square ed !	
847-850	0		\square -axis length compensation of back screw pitch	
851	20000	mm	\square -axis length compensation of back screw pitch	
852	20000	mm	\square -axis length compensation of back screw pitch	
853	20000	mm	A-axis length compensation of back screw pitch	
854	20000	mm	B-axis length compensation of back screw pitch	
855	20000	mm	C-axis length compensation of back screw pitch	
856	20000	mm	System Reser \square ed !	
857-860			\square -axis,Pitch error compensation of each segment.	
861-940	0		\square -axis,Pitch error compensation of each segment.	
941-1020	0		\square -axis,Pitch error compensation of each segment.	
1021-1100	0		A-axis,Pitch error compensation of each segment.	
1101-1180	0		B-axis,Pitch error compensation of each segment.	
1181-1260	0		C-axis,Pitch error compensation of each segment.	
1261-1340	0		Tool #1 radius compensation	
1341	0	mm	\square -axis, Tool #1 offset compensation	
1342	0	mm	\square -axis, Tool #1 offset compensation	

MCM No.	Factory Default Setting	Unit	Description	Setting
1343	0	mm	□-axis, Tool #1 offset compensation	
1344	0	mm	A-axis, Tool #1 offset compensation	
1345	0	mm	B-axis, Tool #1 offset compensation	
1346	0	mm	C-axis, Tool #1 offset compensation	
1347	0	mm	Tool #2 radius compensation	
1348	0	mm	□-axis, Tool #2 offset compensation	
1349	0	mm	□-axis, Tool #2 offset compensation	
1350	0	mm	□-axis, Tool #2 offset compensation	
1351	0	mm	A-axis, Tool #2 offset compensation	
1352	0	mm	B-axis, Tool #2 offset compensation	
1353	0	mm	C-axis, Tool #2 offset compensation	
1354	0	mm	Tool #3 radius compensation	
1355	0	mm	□-axis, Tool #3 offset compensation	
1356	0	mm	□-axis, Tool #3 offset compensation	
1357	0	mm	□-axis, Tool #3 offset compensation	
1358	0	mm	A-axis, Tool #3 offset compensation	
1359	0	mm	B-axis, Tool #3 offset compensation	
1360	0	mm	C-axis, Tool #3 offset compensation	
1361	0	mm	Tool #4 radius compensation	
1362	0	mm	□-axis, Tool #4 offset compensation	
1363	0	mm	□-axis, Tool #4 offset compensation	
1364	0	mm	□-axis, Tool #4 offset compensation	
1365	0	mm	A-axis, Tool #4 offset compensation	
1366	0	mm	B-axis, Tool #4 offset compensation	
1367	0	mm	C-axis, Tool #4 offset compensation	
1368	0	mm	Tool #5 radius compensation	
1369	0	mm	□-axis, Tool #5 offset compensation	
1370	0	mm	□-axis, Tool #5 offset compensation	
1371	0	mm	□-axis, Tool #5 offset compensation	
1372	0	mm	A-axis, Tool #5 offset compensation	
1373	0	mm	B-axis, Tool #5 offset compensation	
1374	0	mm	C-axis, Tool #5 offset compensation	
1375	0	mm	Tool #6 radius compensation	
1376	0	mm	□-axis, Tool #6 offset compensation	
1377	0	mm	□-axis, Tool #6 offset compensation	
1378	0	mm	□-axis, Tool #6 offset compensation	
1379	0	mm	A-axis, Tool #6 offset compensation	
1380	0	mm	B-axis, Tool #6 offset compensation	
1381	0	mm	C-axis, Tool #6 offset compensation	
1382	0	mm	Tool #7 radius compensation	
1383	0	mm	□-axis, Tool #7 offset compensation	
1384	0	mm	□-axis, Tool #7 offset compensation	
1385	0	mm	□-axis, Tool #7 offset compensation	
1386	0	mm	A-axis, Tool #7 offset compensation	
1387	0	mm	B-axis, Tool #7 offset compensation	
1388	0	mm	C-axis, Tool #7 offset compensation	
1389	0	mm	Tool #8 radius compensation	
1390	0	mm	□-axis, Tool #8 offset compensation	
1391	0	mm	□-axis, Tool #8 offset compensation	
1392	0	mm	□-axis, Tool #8 offset compensation	
1393	0	mm	A-axis, Tool #8 offset compensation	
1394	0	mm	B-axis, Tool #8 offset compensation	
1395	0	mm	C-axis, Tool #8 offset compensation	

MCM No.	Factory Default Setting	Unit	Description	Setting
1396	0	mm	Tool #9 radius compensation	
1397	0	mm	<input type="checkbox"/> -axis, Tool #9 offset compensation	
1398	0	mm	<input type="checkbox"/> -axis, Tool #9 offset compensation	
1399	0	mm	<input type="checkbox"/> -axis, Tool #9 offset compensation	
1400	0	mm	A-axis, Tool #9 offset compensation	
1401	0	mm	B-axis, Tool #9 offset compensation	
1402	0	mm	C-axis, Tool #9 offset compensation	
1403	0	mm	Tool #10 radius compensation	
1404	0	mm	<input type="checkbox"/> -axis, Tool #10 offset compensation	
1405	0	mm	<input type="checkbox"/> -axis, Tool #10 offset compensation	
1406	0	mm	<input type="checkbox"/> -axis, Tool #10 offset compensation	
1407	0	mm	A-axis, Tool #10 offset compensation	
1408	0	mm	B-axis, Tool #10 offset compensation	
1409	0	mm	C-axis, Tool #10 offset compensation	
1410	0	mm	Tool #11 radius compensation	
1411	0	mm	<input type="checkbox"/> -axis, Tool #11 offset compensation	
1412	0	mm	<input type="checkbox"/> -axis, Tool #11 offset compensation	
1413	0	mm	<input type="checkbox"/> -axis, Tool #11 offset compensation	
1414	0	mm	A-axis, Tool #11 offset compensation	
1415	0	mm	B-axis, Tool #11 offset compensation	
1416	0	mm	C-axis, Tool #11 offset compensation	
1417	0	mm	Tool #12 radius compensation	
1418	0	mm	<input type="checkbox"/> -axis, Tool #12 offset compensation	
1419	0	mm	<input type="checkbox"/> -axis, Tool #12 offset compensation	
1420	0	mm	<input type="checkbox"/> -axis, Tool #12 offset compensation	
1421	0	mm	A-axis, Tool #12 offset compensation	
1422	0	mm	B-axis, Tool #12 offset compensation	
1423	0	mm	C-axis, Tool #12 offset compensation	
1424	0	mm	Tool #13 radius compensation	
1425	0	mm	<input type="checkbox"/> -axis, Tool #13 offset compensation	
1426	0	mm	<input type="checkbox"/> -axis, Tool #13 offset compensation	
1427	0	mm	<input type="checkbox"/> -axis, Tool #13 offset compensation	
1428	0	mm	A-axis, Tool #13 offset compensation	
1429	0	mm	B-axis, Tool #13 offset compensation	
1430	0	mm	C-axis, Tool #13 offset compensation	
1431	0	mm	Tool #14 radius compensation	
1432	0	mm	<input type="checkbox"/> -axis, Tool #14 offset compensation	
1433	0	mm	<input type="checkbox"/> -axis, Tool #14 offset compensation	
1434	0	mm	<input type="checkbox"/> -axis, Tool #14 offset compensation	
1435	0	mm	A-axis, Tool #14 offset compensation	
1436	0	mm	B-axis, Tool #14 offset compensation	
1437	0	mm	C-axis, Tool #14 offset compensation	
1438	0	mm	Tool # radius compensation	
1439	0	mm	<input type="checkbox"/> -axis, Tool #15 offset compensation	
1440	0	mm	<input type="checkbox"/> -axis, Tool #15 offset compensation	
1441	0	mm	<input type="checkbox"/> -axis, Tool #15 offset compensation	
1442	0	mm	A-axis, Tool #15 offset compensation	
1443	0	mm	B-axis, Tool #15 offset compensation	
1444	0	mm	C-axis, Tool #15 offset compensation	
1445	0	mm	Tool #16 radius compensation	
1446	0	mm	<input type="checkbox"/> -axis, Tool #16 offset compensation	
1447	0	mm	<input type="checkbox"/> -axis, Tool #16 offset compensation	
1448	0	mm	<input type="checkbox"/> -axis, Tool #16 offset compensation	

MCM No.	Factory Default Setting	Unit	Description	Setting
1449	0	mm	A-axis, Tool #16 offset compensation	
1450	0	mm	B-axis, Tool #16 offset compensation	
1451	0	mm	C-axis, Tool #16 offset compensation	
1452	0	mm	Tool #17 radius compensation	
1453	0	mm	□-axis, Tool #17 offset compensation	
1454	0	mm	□-axis, Tool #17 offset compensation	
1455	0	mm	□-axis, Tool #17 offset compensation	
1456	0	mm	A-axis, Tool #17 offset compensation	
1457	0	mm	B-axis, Tool #17 offset compensation	
1458	0	mm	C-axis, Tool #17 offset compensation	
1459	0	mm	Tool #18 radius compensation	
1460	0	mm	□-axis, Tool #18 offset compensation	
1461	0	mm	□-axis, Tool #18 offset compensation	
1462	0	mm	□-axis, Tool #18 offset compensation	
1463	0	mm	A-axis, Tool #18 offset compensation	
1464	0	mm	B-axis, Tool #18 offset compensation	
1465	0	mm	C-axis, Tool #18 offset compensation	
1466	0	mm	Tool #19 radius compensation	
1467	0	mm	□-axis, Tool #19 offset compensation	
1468	0	mm	□-axis, Tool #19 offset compensation	
1469	0	mm	□-axis, Tool #19 offset compensation	
1470	0	mm	A-axis, Tool #19 offset compensation	
1471	0	mm	B-axis, Tool #19 offset compensation	
1472	0	mm	C-axis, Tool #19 offset compensation	
1473	0	mm	Tool #20 radius compensation	
1474	0	mm	□-axis, Tool #20 offset compensation	
1475	0	mm	□-axis, Tool #20 offset compensation	
1476	0	mm	□-axis, Tool #20 offset compensation	
1477	0	mm	A-axis, Tool #20 offset compensation	
1478	0	mm	B-axis, Tool #20 offset compensation	
1479	0	mm	C-axis, Tool #20 offset compensation	
1480	0	mm	Tool #21 radius compensation	
1481	0	mm	□-axis, Tool #21 offset compensation	
1482	0	mm	□-axis, Tool #21 offset compensation	
1483	0	mm	□-axis, Tool #21 offset compensation	
1484	0	mm	A-axis, Tool #21 offset compensation	
1485	0	mm	B-axis, Tool #21 offset compensation	
1486	0	mm	C-axis, Tool #21 offset compensation	
1487	0	mm	Tool #22 radius compensation	
1488	0	mm	□-axis, Tool #22 offset compensation	
1489	0	mm	□-axis, Tool #22 offset compensation	
1490	0	mm	□-axis, Tool #22 offset compensation	
1491	0	mm	A-axis, Tool #22 offset compensation	
1492	0	mm	B-axis, Tool #22 offset compensation	
1493	0	mm	C-axis, Tool #22 offset compensation	
1494	0	mm	Tool #23 radius compensation	
1495	0	mm	□-axis, Tool #23 offset compensation	
1496	0	mm	□-axis, Tool #23 offset compensation	
1497	0	mm	□-axis, Tool #23 offset compensation	
1498	0	mm	A-axis, Tool #23 offset compensation	
1499	0	mm	B-axis, Tool #23 offset compensation	
1500	0	mm	C-axis, Tool #23 offset compensation	
1501	0	mm	Tool #24 radius compensation	

MCM No.	Factory Default Setting	Unit	Description	Setting
1502	0	mm	<input type="checkbox"/> -axis, Tool #24 offset compensation	
1503	0	mm	<input type="checkbox"/> -axis, Tool #24 offset compensation	
1504	0	mm	<input type="checkbox"/> -axis, Tool #24 offset compensation	
1505	0	mm	A-axis, Tool #24 offset compensation	
1506	0	mm	B-axis, Tool #24 offset compensation	
1507	0	mm	C-axis, Tool #24 offset compensation	
1508	0	mm	Tool #25 radius compensation	
1509	0	mm	<input type="checkbox"/> -axis, Tool #25 offset compensation	
1510	0	mm	<input type="checkbox"/> -axis, Tool #25 offset compensation	
1511	0	mm	<input type="checkbox"/> -axis, Tool #25 offset compensation	
1512	0	mm	A-axis, Tool #25 offset compensation	
1513	0	mm	B-axis, Tool #25 offset compensation	
1514	0	mm	C-axis, Tool #25 offset compensation	
1515	0	mm	Tool #26 radius compensation	
1516	0	mm	<input type="checkbox"/> -axis, Tool #26 offset compensation	
1517	0	mm	<input type="checkbox"/> -axis, Tool #26 offset compensation	
1518	0	mm	<input type="checkbox"/> -axis, Tool #26 offset compensation	
1519	0	mm	A-axis, Tool #26 offset compensation	
1520	0	mm	B-axis, Tool #26 offset compensation	
1521	0	mm	C-axis, Tool #26 offset compensation	
1522	0	mm	Tool #27 radius compensation	
1523	0	mm	<input type="checkbox"/> -axis, Tool #27 offset compensation	
1524	0	mm	<input type="checkbox"/> -axis, Tool #27 offset compensation	
1525	0	mm	<input type="checkbox"/> -axis, Tool #27 offset compensation	
1526	0	mm	A-axis, Tool #27 offset compensation	
1527	0	mm	B-axis, Tool #27 offset compensation	
1528	0	mm	C-axis, Tool #27 offset compensation	
1529	0	mm	Tool #28 radius compensation	
1530	0	mm	<input type="checkbox"/> -axis, Tool #28 offset compensation	
1531	0	mm	<input type="checkbox"/> -axis, Tool #28 offset compensation	
1532	0	mm	<input type="checkbox"/> -axis, Tool #28 offset compensation	
1533	0	mm	A-axis, Tool #28 offset compensation	
1534	0	mm	B-axis, Tool #28 offset compensation	
1535	0	mm	C-axis, Tool #28 offset compensation	
1536	0	mm	Tool #29 radius compensation	
1537	0	mm	<input type="checkbox"/> -axis, Tool #29 offset compensation	
1538	0	mm	<input type="checkbox"/> -axis, Tool #29 offset compensation	
1539	0	mm	<input type="checkbox"/> -axis, Tool #29 offset compensation	
1540	0	mm	A-axis, Tool #29 offset compensation	
1541	0	mm	B-axis, Tool #29 offset compensation	
1542	0	mm	C-axis, Tool #29 offset compensation	
1543	0	mm	Tool #30 radius compensation	
1544	0	mm	<input type="checkbox"/> -axis, Tool #30 offset compensation	
1545	0		<input type="checkbox"/> -axis, Tool #30 offset compensation	
1546	0	mm	<input type="checkbox"/> -axis, Tool #30 offset compensation	
1547	0	mm	A-axis, Tool #30 offset compensation	
1548	0	mm	B-axis, Tool #30 offset compensation	
1549	0	mm	C-axis, Tool #30 offset compensation	
1550	0	mm	Tool 31# radius compensation	
1551	0	mm	<input type="checkbox"/> -axis, Tool #31 offset compensation	
1552	0	mm	<input type="checkbox"/> -axis, Tool #31 offset compensation	
1553	0	mm	<input type="checkbox"/> -axis, Tool #31 offset compensation	

MCM No.	Factory Default Setting	Unit	Description	Setting
1554	0	mm	A-axis, Tool #31 offset compensation	
1555	0	mm	B-axis, Tool #31 offset compensation	
1556	0	mm	C-axis, Tool #31 offset compensation	
1557	0	mm	Tool #32 radius compensation	
1558	0	mm	□-axis, Tool #32 offset compensation	
1559	0	mm	□-axis, Tool #32 offset compensation	
1560	0	mm	□-axis, Tool #32 offset compensation	
1561	0	mm	A-axis, Tool #32 offset compensation	
1562	0	mm	B-axis, Tool #32 offset compensation	
1563	0	mm	C-axis, Tool #32 offset compensation	
1564	0	mm	Tool #33 radius compensation	
1565	0	mm	□-axis, Tool #33 offset compensation	
1566	0	mm	□-axis, Tool #33 offset compensation	
1567	0	mm	□-axis, Tool #33 offset compensation	
1568	0	mm	A-axis, Tool #33 offset compensation	
1569	0	mm	B-axis, Tool #33 offset compensation	
1570	0	mm	C-axis, Tool #33 offset compensation	
1571	0	mm	Tool #34 radius compensation	
1572	0	mm	□-axis, Tool #34 offset compensation	
1573	0	mm	□-axis, Tool #34 offset compensation	
1574	0	mm	□-axis, Tool #34 offset compensation	
1575	0	mm	A-axis, Tool #34 offset compensation	
1576	0	mm	B-axis, Tool #34 offset compensation	
1577	0	mm	C-axis, Tool #34 offset compensation	
1578	0	mm	Tool #35 radius compensation	
1579	0	mm	□-axis, Tool #35 offset compensation	
1580	0	mm	□-axis, Tool #35 offset compensation	
1581	0	mm	□-axis, Tool #35 offset compensation	
1582	0	mm	A-axis, Tool #35 offset compensation	
1583	0	mm	B-axis, Tool #35 offset compensation	
1584	0	mm	C-axis, Tool #35 offset compensation	
1585	0	mm	Tool #36 radius compensation	
1586	0	mm	□-axis, Tool #36 offset compensation	
1587	0	mm	□-axis, Tool #36 offset compensation	
1588	0	mm	□-axis, Tool #36 offset compensation	
1589	0	mm	A-axis, Tool #36 offset compensation	
1590	0	mm	B-axis, Tool #36 offset compensation	
1591	0	mm	C-axis, Tool #36 offset compensation	
1592	0	mm	Tool #37 radius compensation	
1593	0	mm	□-axis, Tool #37 offset compensation	
1594	0	mm	□-axis, Tool #37 offset compensation	
1595	0	mm	□-axis, Tool #37 offset compensation	
1596	0	mm	A-axis, Tool #37 offset compensation	
1597	0	mm	B-axis, Tool #37 offset compensation	
1598	0	mm	C-axis, Tool #37 offset compensation	
1599	0	mm	Tool #38 radius compensation	
1600	0	mm	□-axis, Tool #38 offset compensation	
1601	0	mm	□-axis, Tool #38 offset compensation	
1602	0	mm	□-axis, Tool #38 offset compensation	
1603	0	mm	A-axis, Tool #38 offset compensation	
1604	0	mm	B-axis, Tool #38 offset compensation	
1605	0	mm	C-axis, Tool #38 offset compensation	
1606	0	mm	Tool #39 radius compensation	

MCM No.	Factory Default Setting	Unit	Description	Setting
1607	0	mm	□-axis, Tool #39 offset compensation	
1608	0	mm	□-axis, Tool #39 offset compensation	
1609	0	mm	□-axis, Tool #39 offset compensation	
1610	0	mm	A-axis, Tool #39 offset compensation	
1611	0	mm	B-axis, Tool #39 offset compensation	
1612	0	mm	C-axis, Tool #39 offset compensation	
1613	0	mm	Tool #40 radius compensation	
1614	0	mm	□-axis, Tool #40 offset compensation	
1615	0	mm	□-axis, Tool #40 offset compensation	
1616	0	mm	□-axis, Tool #40 offset compensation	
1617	0	mm	A-axis, Tool #40 offset compensation	
1618	0	mm	B-axis, Tool #40 offset compensation	
1619	0	mm	C-axis, Tool #40 offset compensation	
1620	0	mm	Tool #1 radius wear compensation	
1621	0	mm	□-axis, Tool #1 wear compensation	
1622	0	mm	□-axis, Tool #1 wear compensation	
1623	0	mm	□-axis, Tool #1 wear compensation	
1624	0	mm	A-axis, Tool #1 wear compensation	
1625	0	mm	B-axis, Tool #1 wear compensation	
1626	0	mm	C-axis, Tool #1 wear compensation	
1627	0	mm	Tool #2 radius wear compensation	
1628	0	mm	□-axis, Tool #2 wear compensation	
1629	0	mm	□-axis, Tool #2 wear compensation	
1630	0	mm	□-axis, Tool #2 wear compensation	
1631	0	mm	A-axis, Tool #2 wear compensation	
1632	0	mm	B-axis, Tool #2 wear compensation	
1633	0	mm	C-axis, Tool #2 wear compensation	
1634	0	mm	Tool #3 radius wear compensation	
1635	0	mm	□-axis, Tool #3 wear compensation	
1636	0	mm	□-axis, Tool #3 wear compensation	
1637	0	mm	□-axis, Tool #3 wear compensation	
1638	0	mm	A-axis, Tool #3 wear compensation	
1639	0	mm	B-axis, Tool #3 wear compensation	
1640	0	mm	C-axis, Tool #3 wear compensation	
1641	0	mm	Tool #4 radius wear compensation	
1642	0	mm	□-axis, Tool #4 wear compensation	
1643	0	mm	□-axis, Tool #4 wear compensation	
1644	0	mm	□-axis, Tool #4 wear compensation	
1645	0	mm	A-axis, Tool #4 wear compensation	
1646	0	mm	B-axis, Tool #4 wear compensation	
1647	0	mm	C-axis, Tool #4 wear compensation	
1648	0	mm	Tool #5 radius wear compensation	
1649	0	mm	□-axis, Tool #5 wear compensation	
1650	0	mm	□-axis, Tool #5 wear compensation	
1651	0	mm	□-axis, Tool #5 wear compensation	
1652	0	mm	A-axis, Tool #5 wear compensation	
1653	0	mm	B-axis, Tool #5 wear compensation	
1654	0	mm	C-axis, Tool #5 wear compensation	
1655	0	mm	Tool #6 radius wear compensation	
1656	0	mm	□-axis, Tool #6 wear compensation	
1657	0	mm	□-axis, Tool #6 wear compensation	
1658	0	mm	□-axis, Tool #6 wear compensation	
1659	0	mm	A-axis, Tool #6 wear compensation	

MCM No.	Factory Default Setting	Unit	Description	Setting
1660	0	mm	B-axis, Tool #6 wear compensation	
1661	0	mm	C-axis, Tool #6 wear compensation	
1662	0	mm	Tool #7 radius wear compensation	
1663	0	mm	□-axis, Tool #7 wear compensation	
1664	0	mm	□-axis, Tool #7 wear compensation	
1665	0	mm	□-axis, Tool #7 wear compensation	
1666	0	mm	A-axis, Tool #7 wear compensation	
1667	0	mm	B-axis, Tool #7 wear compensation	
1668	0	mm	C-axis, Tool #7 wear compensation	
1669	0	mm	Tool #8 radius wear compensation	
1670	0	mm	□-axis, Tool #8 wear compensation	
1671	0	mm	□-axis, Tool #8 wear compensation	
1672	0	mm	□-axis, Tool #8 wear compensation	
1673	0	mm	A-axis, Tool #8 wear compensation	
1674	0	mm	B-axis, Tool #8 wear compensation	
1675	0	mm	C-axis, Tool #8 wear compensation	
1676	0	mm	Tool #9 radius wear compensation	
1677	0	mm	□-axis, Tool #9 wear compensation	
1678	0	mm	□-axis, Tool #9 wear compensation	
1679	0	mm	□-axis, Tool #9 wear compensation	
1680	0	mm	A-axis, Tool #9 wear compensation	
1681	0	mm	B-axis, Tool #9 wear compensation	
1682	0	mm	C-axis, Tool #9 wear compensation	
1683	0	mm	Tool #10 radius wear compensation	
1684	0	mm	□-axis, Tool #10 wear compensation	
1685	0	mm	□-axis, Tool #10 wear compensation	
1686	0	mm	□-axis, Tool #10 wear compensation	
1687	0	mm	A-axis, Tool #10 wear compensation	
1688	0	mm	B-axis, Tool #10 wear compensation	
1689	0	mm	C-axis, Tool #10 wear compensation	
1690	0	mm	Tool #11 radius wear compensation	
1691	0	mm	□-axis, Tool #11 wear compensation	
1692	0	mm	□-axis, Tool #11 wear compensation	
1693	0	mm	□-axis, Tool #11 wear compensation	
1694	0	mm	A-axis, Tool #11 wear compensation	
1695	0	mm	B-axis, Tool #11 wear compensation	
1696	0	mm	C-axis, Tool #11 wear compensation	
1697	0	mm	Tool #12 radius wear compensation	
1698	0	mm	□-axis, Tool #12 wear compensation	
1699	0	mm	□-axis, Tool #12 wear compensation	
1700	0	mm	□-axis, Tool #12 wear compensation	
1701	0	mm	A-axis, Tool #12 wear compensation	
1702	0	mm	B-axis, Tool #12 wear compensation	
1703	0	mm	C-axis, Tool #12 wear compensation	
1704	0	mm	Tool #13 radius wear compensation	
1705	0	mm	□-axis, Tool #13 wear compensation	
1706	0	mm	□-axis, Tool #13 wear compensation	
1707	0	mm	□-axis, Tool #13 wear compensation	
1708	0	mm	A-axis, Tool #13 wear compensation	
1709	0	mm	B-axis, Tool #13 wear compensation	
1710	0	mm	C-axis, Tool #13 wear compensation	
1711	0	mm	Tool #14 radius wear compensation	
1712	0	mm	□-axis, Tool #14 wear compensation	

MCM No.	Factory Default Setting	Unit	Description	Setting
1713	0	mm	□-axis, Tool #14 wear compensation	
1714	0	mm	□-axis, Tool #14 wear compensation	
1715	0	mm	A-axis, Tool #14 wear compensation	
1716	0	mm	B-axis, Tool #14 wear compensation	
1717	0	mm	C-axis, Tool #14 wear compensation	
1718	0	mm	Tool #15 radius wear compensation	
1719	0	mm	□-axis, Tool #15 wear compensation	
1720	0	mm	□-axis, Tool #15 wear compensation	
1721	0	mm	□-axis, Tool #15 wear compensation	
1722	0	mm	A-axis, Tool #15 wear compensation	
1723	0	mm	B-axis, Tool #15 wear compensation	
1724	0	mm	C-axis, Tool #15 wear compensation	
1725	0	mm	Tool #16 radius wear compensation	
1726	0	mm	□-axis, Tool #16 wear compensation	
1727	0	mm	□-axis, Tool #16 wear compensation	
1728	0	mm	□-axis, Tool #16 wear compensation	
1729	0	mm	A-axis, Tool #16 wear compensation	
1730	0	mm	B-axis, Tool #16 wear compensation	
1731	0	mm	C-axis, Tool #16 wear compensation	
1732	0	mm	Tool #17 radius wear compensation	
1733	0	mm	□-axis, Tool #17 wear compensation	
1734	0	mm	□-axis, Tool #17 wear compensation	
1735	0	mm	□-axis, Tool #17 wear compensation	
1736	0	mm	A-axis, Tool #17 wear compensation	
1737	0	mm	B-axis, Tool #17 wear compensation	
1738	0	mm	C-axis, Tool #17 wear compensation	
1739	0	mm	Tool #18 radius wear compensation	
1740	0	mm	□-axis, Tool #18 wear compensation	
1741	0	mm	□-axis, Tool #18 wear compensation	
1742	0	mm	□-axis, Tool #18 wear compensation	
1743	0	mm	A-axis, Tool #18 wear compensation	
1744	0	mm	B-axis, Tool #18 wear compensation	
1745	0	mm	C-axis, Tool #18 wear compensation	
1746	0	mm	Tool #19 radius wear compensation	
1747	0	mm	□-axis, Tool #19 wear compensation	
1748	0	mm	□-axis, Tool #19 wear compensation	
1749	0	mm	□-axis, Tool #19 wear compensation	
1750	0	mm	A-axis, Tool #19 wear compensation	
1751	0	mm	B-axis, Tool #19 wear compensation	
1752	0	mm	C-axis, Tool #19 wear compensation	
1753	0	mm	Tool #20 radius wear compensation	
1754	0	mm	□-axis, Tool #20 wear compensation	
1755	0	mm	□-axis, Tool #20 wear compensation	
1756	0	mm	□-axis, Tool #20 wear compensation	
1757	0	mm	A-axis, Tool #20 wear compensation	
1758	0	mm	B-axis, Tool #20 wear compensation	
1759	0	mm	C-axis, Tool #20 wear compensation	
1760	0	mm	Tool #21 radius wear compensation	
1761	0	mm	□-axis, Tool #21 wear compensation	
1762	0	mm	□-axis, Tool #21 wear compensation	
1763	0	mm	□-axis, Tool #21 wear compensation	
1764	0	mm	A-axis, Tool #21 wear compensation	
1765	0	mm	B-axis, Tool #21 wear compensation	

MCM No.	Factory Default Setting	Unit	Description	Setting
1766	0	mm	C-axis, Tool #21 wear compensation	
1767	0	mm	Tool #22 radius wear compensation	
1768	0	mm	□-axis, Tool #22 wear compensation	
1769	0	mm	□-axis, Tool #22 wear compensation	
1770	0	mm	□-axis, Tool #22 wear compensation	
1771	0	mm	A-axis, Tool #22 wear compensation	
1772	0	mm	B-axis, Tool #22 wear compensation	
1773	0	mm	C-axis, Tool #22 wear compensation	
1774	0	mm	Tool #23 radius wear compensation	
1775	0	mm	□-axis, Tool #23 wear compensation	
1776	0	mm	□-axis, Tool #23 wear compensation	
1777	0	mm	□-axis, Tool #23 wear compensation	
1778	0	mm	A-axis, Tool #23 wear compensation	
1779	0	mm	B-axis, Tool #23 wear compensation	
1780	0	mm	C-axis, Tool #23 wear compensation	
1781	0	mm	Tool #24 radius wear compensation	
1782	0	mm	□-axis, Tool #24 wear compensation	
1783	0	mm	□-axis, Tool #24 wear compensation	
1784	0	mm	□-axis, Tool #24 wear compensation	
1785	0	mm	A-axis, Tool #24 wear compensation	
1786	0	mm	B-axis, Tool #24 wear compensation	
1787	0	mm	C-axis, Tool #24 wear compensation	
1788	0	mm	Tool #25 radius wear compensation	
1789	0	mm	□-axis, Tool #25 wear compensation	
1790	0	mm	□-axis, Tool #25 wear compensation	
1791	0	mm	□-axis, Tool #25 wear compensation	
1792	0	mm	A-axis, Tool #25 wear compensation	
1793	0	mm	B-axis, Tool #25 wear compensation	
1794	0	mm	C-axis, Tool #25 wear compensation	
1795	0	mm	Tool #26 radius wear compensation	
1796	0	mm	□-axis, Tool #26 wear compensation	
1797	0	mm	□-axis, Tool #26 wear compensation	
1798	0	mm	□-axis, Tool #26 wear compensation	
1799	0	mm	A-axis, Tool #26 wear compensation	
1800	0	mm	B-axis, Tool #26 wear compensation	
1801	0	mm	C-axis, Tool #26 wear compensation	
1802	0	mm	Tool #27 radius wear compensation	
1803	0	mm	□-axis, Tool #27 wear compensation	
1804	0	mm	□-axis, Tool #27 wear compensation	
1805	0	mm	□-axis, Tool #27 wear compensation	
1806	0	mm	A-axis, Tool #27 wear compensation	
1807	0	mm	B-axis, Tool #27 wear compensation	
1808	0	mm	C-axis, Tool #27 wear compensation	
1809	0	mm	Tool #28 radius wear compensation	
1810	0	mm	□-axis, Tool #28 wear compensation	
1811	0	mm	□-axis, Tool #28 wear compensation	
1812	0	mm	□-axis, Tool #28 wear compensation	
1813	0	mm	A-axis, Tool #28 wear compensation	
1814	0	mm	B-axis, Tool #28 wear compensation	
1815	0	mm	C-axis, Tool #28 wear compensation	
1816	0	mm	Tool #29 radius wear compensation	
1817	0	mm	□-axis, Tool #29 wear compensation	
1818	0	mm	□-axis, Tool #29 wear compensation	

MCM No.	Factory Default Setting	Unit	Description	Setting
1819	0	mm	□-axis, Tool #29 wear compensation	
1820	0	mm	A-axis, Tool #29 wear compensation	
1821	0	mm	B-axis, Tool #29 wear compensation	
1822	0	mm	C-axis, Tool #29 wear compensation	
1823	0	mm	Tool #30 radius wear compensation	
1824	0	mm	□-axis, Tool #30 wear compensation	
1825	0	mm	□-axis, Tool #30 wear compensation	
1826	0	mm	□-axis, Tool #30 wear compensation	
1827	0	mm	A-axis, Tool #30 wear compensation	
1828	0	mm	B-axis, Tool #30 wear compensation	
1829	0	mm	C-axis, Tool #30 wear compensation	
1830	0	mm	Tool #31 radius wear compensation	
1831	0	mm	□-axis, Tool #31 wear compensation	
1832	0	mm	□-axis, Tool #31 wear compensation	
1833	0	mm	□-axis, Tool #31 wear compensation	
1834	0	mm	A-axis, Tool #31 wear compensation	
1835	0	mm	B-axis, Tool #31 wear compensation	
1836	0	mm	C-axis, Tool #31 wear compensation	
1837	0	mm	Tool #32 radius wear compensation	
1838	0	mm	□-axis, Tool #32 wear compensation	
1839	0	mm	□-axis, Tool #32 wear compensation	
1840	0	mm	□-axis, Tool #32 wear compensation	
1841	0	mm	A-axis, Tool #32 wear compensation	
1842	0	mm	B-axis, Tool #32 wear compensation	
1843	0	mm	C-axis, Tool #32 wear compensation	
1844	0	mm	Tool #33 radius wear compensation	
1845	0	mm	□-axis, Tool #33 wear compensation	
1846	0	mm	□-axis, Tool #33 wear compensation	
1847	0	mm	□-axis, Tool #33 wear compensation	
1848	0	mm	A-axis, Tool #33 wear compensation	
1849	0	mm	B-axis, Tool #33 wear compensation	
1850	0	mm	C-axis, Tool #33 wear compensation	
1851	0	mm	Tool #34 radius wear compensation	
1852	0	mm	□-axis, Tool #34 wear compensation	
1853	0	mm	□-axis, Tool #34 wear compensation	
1854	0	mm	□-axis, Tool #34 wear compensation	
1855	0	mm	A-axis, Tool #34 wear compensation	
1856	0	mm	B-axis, Tool #34 wear compensation	
1857	0	mm	C-axis, Tool #34 wear compensation	
1858	0	mm	Tool #35 radius wear compensation	
1859	0	mm	□-axis, Tool #35 wear compensation	
1860	0	mm	□-axis, Tool #35 wear compensation	
1861	0	mm	□-axis, Tool #35 wear compensation	
1862	0	mm	A-axis, Tool #35 wear compensation	
1863	0	mm	B-axis, Tool #35 wear compensation	
1864	0	mm	C-axis, Tool #35 wear compensation	
1865	0	mm	Tool #36 radius wear compensation	
1866	0	mm	□-axis, Tool #36 wear compensation	
1867	0	mm	□-axis, Tool #36 wear compensation	
1868	0	mm	□-axis, Tool #36 wear compensation	
1869	0	mm	A-axis, Tool #36 wear compensation	
1870	0	mm	B-axis, Tool #36 wear compensation	
1871	0	mm	C-axis, Tool #36 wear compensation	

MCM No.	Factory Default Setting	Unit	Description	Setting
1872	0	mm	Tool #37 radius wear compensation	
1873	0	mm	X-axis, Tool #37 wear compensation	
1874	0	mm	Y-axis, Tool #37 wear compensation	
1875	0	mm	Z-axis, Tool #37 wear compensation	
1876	0	mm	A-axis, Tool #37 wear compensation	
1877	0	mm	B-axis, Tool #37 wear compensation	
1878	0	mm	C-axis, Tool #37 wear compensation	
1879	0	mm	Tool #38 radius wear compensation	
1880	0	mm	X-axis, Tool #38 wear compensation	
1881	0	mm	Y-axis, Tool #38 wear compensation	
1882	0	mm	Z-axis, Tool #38 wear compensation	
1883	0	mm	A-axis, Tool #38 wear compensation	
1884	0	mm	B-axis, Tool #38 wear compensation	
1885	0	mm	C-axis, Tool #38 wear compensation	
1886	0	mm	Tool #39 radius wear compensation	
1887	0	mm	X-axis, Tool #39 wear compensation	
1888	0	mm	Y-axis, Tool #39 wear compensation	
1889	0	mm	Z-axis, Tool #39 wear compensation	
1890	0	mm	A-axis, Tool #39 wear compensation	
1891	0	mm	B-axis, Tool #39 wear compensation	
1892	0	mm	C-axis, Tool #39 wear compensation	
1893	0	mm	Tool #40 radius wear compensation	
1894	0	mm	X-axis, Tool #40 wear compensation	
1895	0	mm	Y-axis, Tool #40 wear compensation	
1896	0	mm	Z-axis, Tool #40 wear compensation	
1897	0	mm	A-axis, Tool #40 wear compensation	
1898	0	mm	B-axis, Tool #40 wear compensation	
1899	0	mm	C-axis, Tool #40 wear compensation	
1900	0	mm	Tool-tip #1 radius compensation	
1901			Tool-tip #2 radius compensation	
1902			Tool-tip #3 radius compensation	
1903			Tool-tip #4 radius compensation	
1904			Tool-tip #5 radius compensation	
1905			Tool-tip #6 radius compensation	
1906			Tool-tip #7 radius compensation	
1907			Tool-tip #8 radius compensation	
1908			Tool-tip #9 radius compensation	
1909			Tool-tip #10 radius compensation	
1910			Tool-tip #11 radius compensation	
1911			Tool-tip #12 radius compensation	
1912			Tool-tip #13 radius compensation	
1913			Tool-tip #14 radius compensation	
1914			Tool-tip #15 radius compensation	
1915			Tool-tip #16 radius compensation	
1916			Tool-tip #17 radius compensation	
1917			Tool-tip #18 radius compensation	
1918			Tool-tip #19 radius compensation	
1919			Tool-tip #20 radius compensation	
1920			Tool-tip #21 radius compensation	
1921			Tool-tip #22 radius compensation	
1922			Tool-tip #23 radius compensation	
1923			Tool-tip #24 radius compensation	
1924			Tool-tip #25 radius compensation	

MCM No.	Factory Default Setting	Unit	Description	Setting
1925			Tool-tip #26 radius compensation	
1926			Tool-tip #27 radius compensation	
1927			Tool-tip #28 radius compensation	
1928			Tool-tip #29 radius compensation	
1929			Tool-tip #30 radius compensation	
1930			Tool-tip #31 radius compensation	
1931			Tool-tip #32 radius compensation	
1932			Tool-tip #33 radius compensation	
1933			Tool-tip #34 radius compensation	
1934			Tool-tip #35 radius compensation	
1935			Tool-tip #36 radius compensation	
1936			Tool-tip #37 radius compensation	
1937			Tool-tip #38 radius compensation	
1938			Tool-tip #39 radius compensation	
1939			Tool-tip #40 radius compensation	
1940				

PS Press PAGE↑ or PAGE↓ once will change twelve items.

7.1 Description of MCM Machine Constants

The decimal format for MCM data in this section is based on 4.3 format.

MCM #1~#36 are for G54~G59 work coordinates data. The setting value is the distance between the origin of each work coordinate system and the machine HOME position. All input data have the same format and unit as shown below.

1. G54 (1st) Work Coordinate, X-axis.
 2. G54 (1st) Work Coordinate, Y-axis.
 3. G54 (1st) Work Coordinate, Z-axis.
 4. G54 (1st) Work Coordinate, A-axis.
 5. G54 (1st) Work Coordinate, B-axis.
 6. G54 (1st) Work Coordinate, C-axis.
 7. G54 (1st) Work Coordinate, U-axis.
 8. G54 (1st) Work Coordinate, V-axis.
 9. G54 (1st) Work Coordinate, W-axis.
- Format : . , Unit:mm (Default=0.000)

MCM# 10~20 System Reserved !

21. G55 (2nd) Work Coordinate, X-axis.
 22. G55 (2nd) Work Coordinate, Y-axis.
 23. G55 (2nd) Work Coordinate, Z-axis.
 24. G55 (2nd) Work Coordinate, A-axis.
 25. G55 (2nd) Work Coordinate, B-axis.
 26. G55 (2nd) Work Coordinate, C-axis.
 27. G55 (2nd) Work Coordinate, U-axis.
 28. G55 (2nd) Work Coordinate, V-axis.
 29. G55 (2nd) Work Coordinate, W-axis.
- Format : . , Unit:mm (Default=0.000)

MCM# 30~40 System Reserved !

41. G56 (3rd) Work Coordinate, X-axis.
42. G56 (3rd) Work Coordinate, Y-axis.
43. G56 (3rd) Work Coordinate, Z-axis.
44. G56 (3rd) Work Coordinate, A-axis.

- 45. G56 (3rd) Work Coordinate, B-axis.
- 46. G56 (3rd) Work Coordinate, C-axis.
- 47. G56 (3rd) Work Coordinate, U-axis.
- 48. G56 (3rd) Work Coordinate, V-axis.
- 49. G56 (3rd) Work Coordinate, W-axis.

Format : □.□□□□ , Unit□mm (Default□0.000)

MCM# 50□60 System Reser□ed !

MCM# 61□69 G57 (4th) Work Coordinate.

MCM# 70□80 System Reser□ed !

MCM# 81□89 G58 (5th) Work Coordinate.

MCM# 90□100 System Reser□ed !

MCM# 101□109 G59 (6th) Work Coordinate.

MCM# 110□120 System Reser□ed !

MCM Parameters 121□160 are used for setting the coordinates of the reference point. Its □alue is the mechanical coordinates of the reference point relative to the mechanical origin.

- 121. G28 1st Reference Point Data, □-axis.
- 122. G28 1st Reference Point Data, □-axis.
- 123. G28 1st Reference Point Data, □-axis.
- 124. G28 1st Reference Point Data, A-axis.
- 125. G28 1st Reference Point Data, B-axis.
- 126. G28 1st Reference Point Data, C-axis.
- 127. G28 1st Reference Point Data, U-axis.
- 128. G28 1st Reference Point Data, V-axis.
- 129. G28 1st Reference Point Data, W-axis.

Format : □.□□□□ , Unit□mm (Default□0.000)

MCM# 130□140 System Reser□ed !

- 141. G30 2st Reference Point Data, □-axis.
- 142. G30 2st Reference Point Data, □-axis.
- 143. G30 2st Reference Point Data, □-axis.
- 144. G30 2st Reference Point Data, A-axis.

- 145. G30 2st Reference Point Data, B-axis.
 - 146. G30 2st Reference Point Data, C-axis.
 - 147. G30 2st Reference Point Data, U-axis.
 - 148. G30 2st Reference Point Data, V-axis.
 - 149. G30 2st Reference Point Data, W-axis.
- Format : □.□□□□ , Unit□mm (Default□0.000)

MCM# 150□160 System Reser□ed !

- 161. Backlash Compensation (G01), □-axis.
 - 162. Backlash Compensation (G01), □-axis.
 - 163. Backlash Compensation (G01), □-axis.
 - 164. Backlash Compensation (G01), A-axis.
 - 165. Backlash Compensation (G01), B-axis.
 - 166. Backlash Compensation (G01), C-axis.
 - 167. Backlash Compensation (G01), U-axis.
 - 168. Backlash Compensation (G01), V-axis.
 - 169. Backlash Compensation (G01), W-axis.
- Format : □.□□□□ , Unit□pulse (Default□0) Range□0□9.9999

MCM# 170□180 System Reser□ed !

- 181. Backlash Compensation (G00), □-axis.
 - 182. Backlash Compensation (G00), □-axis.
 - 183. Backlash Compensation (G00), □-axis.
 - 184. Backlash Compensation (G00), A-axis.
 - 185. Backlash Compensation (G00), B-axis.
 - 186. Backlash Compensation (G00), C-axis.
 - 187. Backlash Compensation (G00), U-axis.
 - 188. Backlash Compensation (G00), V-axis.
 - 189. Backlash Compensation (G00), W-axis.
- Format : □.□□□□ , Unit□pulse (Default□0) Range□0□9.9999

MCM# 170□200 System Reser□ed !

- 201. □og Speed, □-axis.
- 202. □og Speed, □-axis.
- 203. □og Speed, □-axis.
- 204. □og Speed, A-axis.

205. Jog Speed, B-axis.

206. Jog Speed, C-axis.

207. Jog Speed, U-axis.

208. Jog Speed, V-axis.

209. Jog Speed, W-axis.

Format : $\square.\square\square\square$, Unit $\square\text{mm}\square\text{min}$ (Default $\square 1000$)

MCM# 210-220 System Reser \square ed !

221. Tra \square erse Speed Limit, \square -axis.

222. Tra \square erse Speed Limit, \square -axis.

223. Tra \square erse Speed Limit, \square -axis.

224. Tra \square erse Speed Limit, A-axis.

225. Tra \square erse Speed Limit, B-axis.

226. Tra \square erse Speed Limit, C-axis.

227. Tra \square erse Speed Limit, U-axis.

228. Tra \square erse Speed Limit, V-axis.

229. Tra \square erse Speed Limit, W-axis.

Format : $\square\square\square\square\square$, Unit $\square\text{mm}\square\text{min}$ (Default $\square 10000$)

Note \square The format is only for integer.

The tra \square erse speed limit can be calculated from the following e \square uation \square

$$F_{\text{max}} \square 0.95 * \text{RPM} * \text{Pitch} * \text{GR}$$

RPM \square The ratio. rpm of ser \square o motor

Pitch \square The pitch of the ball-screw

GR \square Gear ratio of ball-screw \square motor

Ex \square Max. rpm \square 3000 rpm for \square -axis, Pitch \square 5 mm \square re \square , Gear Ratio \square 5 \square

$$F_{\text{max}} \square 0.95 * 3000 * 5 \square 5 \square 2850 \text{ mm}\square\text{min}$$

Therefore, it is recommended to set MCM #148 \square 2850.

MCM# 230-240 System Reser \square ed !

241. Denominator of Machine Resolution, \square -axis.

242. Numerator of Machine Resolution, \square -axis.

243. Denominator of Machine Resolution, \square -axis.

244. Numerator of Machine Resolution, \square -axis.

- 245. Denominator of Machine Resolution, X-axis.
- 246. Numerator of Machine Resolution, X-axis
- 247. Denominator of Machine Resolution, A-axis.
- 248. Numerator of Machine Resolution, A-axis
- 249. Denominator of Machine Resolution, B-axis.
- 250. Numerator of Machine Resolution, B-axis
- 251. Denominator of Machine Resolution, C-axis.
- 252. Numerator of Machine Resolution, C-axis
- 253. Denominator of Machine Resolution, U-axis.
- 254. Numerator of Machine Resolution, U-axis
- 255. Denominator of Machine Resolution, V-axis.
- 256. Numerator of Machine Resolution, V-axis
- 257. Denominator of Machine Resolution, W-axis.
- 258. Numerator of Machine Resolution, W-axis

Format : $\square.\square\square\square$, (Default $\square 100$)

Denominator (D) \square pulses/rev for the encoder on motor.

Numerator (N) \square pitch length (mm/rev) of the ball-screw.

Gear Ratio (GR) \square Tooth No. on ball-screw / Tooth No. on motor.

Pulse Multiplication Factor (MF) \square MCM #416 / #469.

$$\text{Machine Resolution} = \frac{(\text{Pitch of Ball - screw})}{(\text{Encoder Pulse}) * (\text{MF})} * \frac{1}{\text{GR}}$$

Ex1 X-axis as linear axis (MCM #781 $\square 0$), pitch $\square 5$ mm $\square 5000$ μm

Encoder $\square 2500$ pulses, MCM #461 $\square 4$, and GR $\square 5$ (motor rotates 5 times while ball-screw rotates once)

Machine resolution $\square 5000 / (2500 \square 4) \square 5 \square 5000 / 50000 \square 1 \square 10 \square 0.1$
 $\mu\text{m/pulse}$

Therefore, the setting value for MCM #118 (D) and #119 (N) can be set as or the same ratio of N/D such as. They are all correct.

(1) D $\square 50000$, N $\square 5000$ (2) D $\square 10$, N $\square 1$ (3) D $\square 100$, N $\square 10$

Ex2 X-axis as rotating axis (MCM #782 $\square 1$), Angle $\square 360.000$ deg/circle

Encoder $\square 2500$ pulses, MCM #161 $\square 4$, and GR $\square 5$ (motor rotates 5 times while ball-screw rotates once)

Machine resolution $\square 360000 \div (2500 \square 4) \square 5 \square 360000 \div 50000 \square 36 \square 5 \square 72 \square 10$

Therefore, the setting value for MCM #120 (D) and #121 (N) can be one of the three combinations. They are all correct.

(1) D $\square 5$, N $\square 36$ (2) D $\square 10$, N $\square 72$ (3) D $\square 50000$, N $\square 360000$

Ex 3 (Position Linear Axis):

The X-axis is an ordinary linear axis (MCM#781 $\square 0$) with the guide screw pitch $\square 5.000$ mm.

When the motor rotates one turn, 10000 pulses will be generated.

Gear ratio is 5:1 (When the servo motor rotates 5 turns, the guide screw rotates 1 turn.)

$$\begin{aligned} \text{Resolution} &= \frac{5000}{10000} \square \frac{1}{5} \\ &= \frac{1}{10} \end{aligned}$$

X-axis resolution \square denominator setting value (MCM#241) $\square 10$

X-axis resolution \square numerator setting value (MCM#242) $\square 1$

Ex 4 (Position type rotational axis):

The X-axis is a rotational axis (MCM#782 $\square 1$). The angle for rotating 1 turn $\square 360.000$ (degree)

One turn of the motor will generate 10000 pulses.

Gear ratio is 5:1 (When the servo motor rotates 5 turns, the X-axis rotates 1 turn.)

$$\begin{aligned} \text{Resolution} &= \frac{360000}{10000} \square \frac{1}{5} \\ &= \frac{36}{5} \end{aligned}$$

X-axis resolution \square denominator setting value (MCM#243) $\square 5$

X-axis resolution \square numerator setting value (MCM#244) $\square 36$

Note 1: When the resolution $< 1/20$, the motor may have the problem of not able to reach its maximum rotation speed.

**Note 2: When the resolution $< 1/100$, the software travel limit should be within the following range:
-9999999 ~ 999999, otherwise an error message may occur which cannot be released.**

Ex: For MCM#241~400 and MCM#242~2, when the \square -axis resolution is smaller than $1/100$, the setting values of the software travel limit for the \square -axis Parameter 581 should be less than 9999999 and Parameter 601 should be greater than -999999.

MCM# 259~280 System Reserved !

- 281. Home Direction for Tool, \square -axis.
- 282. Home Direction for Tool, \square -axis.
- 283. Home Direction for Tool, \square -axis.
- 284. Home Direction for Tool, A-axis.
- 285. Home Direction for Tool, B-axis.
- 286. Home Direction for Tool, C-axis.
- 287. Home Direction for Tool, U-axis.
- 288. Home Direction for Tool, V-axis.
- 289. Home Direction for Tool, W-axis.

Format : \square , (Default 0)

Setting \square 0, Tool returning to HOME in the positive direction.

Setting \square 1, Tool returning to HOME in the negative direction

MCM# 290~300 System Reserved !

- 301. Home Speed When Tool Going to Home, \square -axis.
- 302. Home Speed When Tool Going to Home, \square -axis.
- 303. Home Speed When Tool Going to Home, \square -axis.
- 304. Home Speed When Tool Going to Home, A-axis.
- 305. Home Speed When Tool Going to Home, B-axis.
- 306. Home Speed When Tool Going to Home, C-axis.
- 307. Home Speed When Tool Going to Home, U-axis
- 308. Home Speed When Tool Going to Home, V-axis
- 309. Home Speed When Tool Going to Home, W-axis

Format : □□□□ , Unit□mm□min (Default□2500)

MCM# 310□320 System Reser□ed !

- 321. Home Grid Speed When Tool Going to Home, □-axis.
- 322. Home Grid Speed When Tool Going to Home, □-axis.
- 323. Home Grid Speed When Tool Going to Home, □-axis.
- 324. Home Grid Speed When Tool Going to Home, A-axis.
- 325. Home Grid Speed When Tool Going to Home, B-axis.
- 326. Home Grid Speed When Tool Going to Home, C-axis.
- 327. Home Grid Speed When Tool Going to Home, U-axis.
- 328. Home Grid Speed When Tool Going to Home, V-axis.
- 329. Home Grid Speed When Tool Going to Home, W-axis.

Format : □□□□ , Unit□mm□min (Default□40)

MCM# 330□340 System Reser□ed !

- 341. The direction that ser□o motor search the Grid when □-axis going back to H□ME.
- 342. The direction that ser□o motor search the Grid when □-axis going back to H□ME.
- 343. The direction that ser□o motor search the Grid when □-axis going back to H□ME.
- 344. The direction that ser□o motor search the Grid when A-axis going back to H□ME.
- 345. The direction that ser□o motor search the Grid when B-axis going back to H□ME.
- 346. The direction that ser□o motor search the Grid when C-axis going back to H□ME.
- 347. The direction that ser□o motor search the Grid when U-axis going back to H□ME.
- 348. The direction that ser□o motor search the Grid when V-axis going back to H□ME.
- 349. The direction that ser□o motor search the Grid when W-axis going back to H□ME.

Format : □ , (Default□0)

E□□

When MCM#341□0, the 2nd and 3rd direction is the same with 1st

MCM#341□1, the 2nd is the same with 1st .

MCM#341□128, the 2nd direction is opposite to 1st .

MCM#341□256, the 2nd and 3rd direction is opposite to 1st .

Set the moving speed when the tool, after having touched the HOME limit switch, is searching for the encoder grid signal during HOME execution. HUST H4D□HD□H9D CNC has three (3) different speeds when you execute HOME function as shown by Fig 7.2.

Speed 1□ The motor accelerates to Speed 1 and its maximum speed is determined by the settings of MCM #301 □#309, (□, □, □, A, B, C, U, V, W-axis) and the direction by MCM #281 □#289. When tool touches the home limit switch, it starts deceleration to a stop.

Speed 2□ The motor accelerates again to speed 2 and its maximum speed is equal to 1/4 of Speed 1 and the direction is by MCM #341□#349. When tool starts leaving the home limit switch, it starts deceleration to a stop.

Speed 3□ The motor accelerates to speed 3 and its maximum speed is determined by the settings of MCM #321□#329 and the direction by MCM #341□#349. Once the encoder grid index is found, motor decelerates to a stop. This is the HOME position.

Note that the length of the Home limit switch should be longer than the distance for the deceleration of Speed 1. Otherwise, serious error may result. The equation to calculate the length of the Home limit switch is

$$\text{Length of Home Limit Switch (mm)} \geq \frac{\text{FDCOM} * \text{ACC}}{60000}$$

FDC□M □ Speed 1, in mm□min. (MCM #301□#309)

ACC □ Time for acceleration□deceleration, in ms. (MCM #505)

60000 □ 60 seconds □ 60 * 1000 milliseconds

When the C-bit C063□1 in PLC program, it commands the controller to do homing operation. Do homing operation for □-axis if R232□1, do □-axis if R232□2, do □□axis if R232□4 , do A□axis if R232□8 and do four axes simultaneously if R232□15.

Ex FDC M 3000.00 mm/min, and ACC 100 ms
 Length of Home Limit Switch 3000 * 100 60000 5 mm

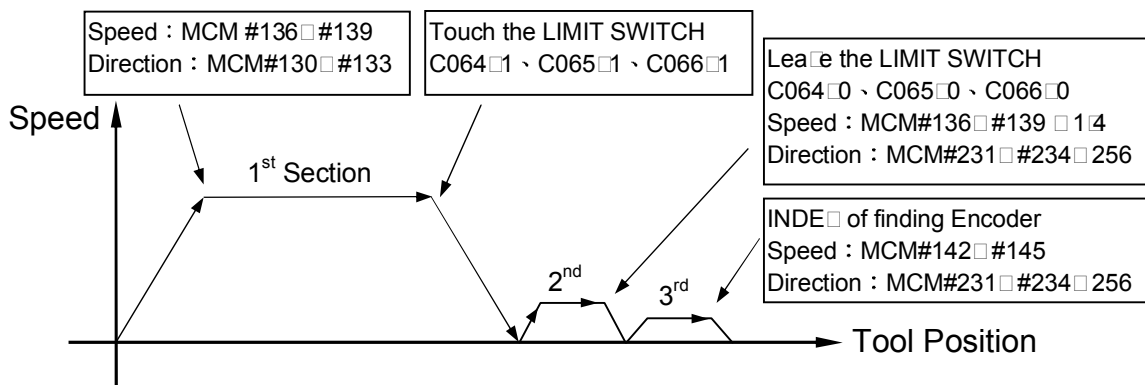

Fig 7.2 (A) Homing Speed and Direction of finding (GRID)

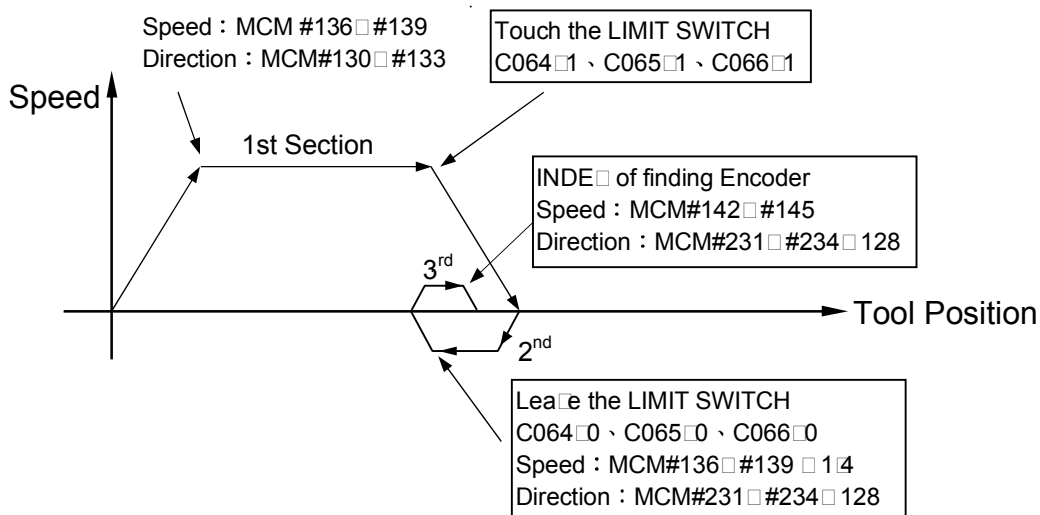

Fig 7.2 (B) Homing Speed and Direction of finding (GRID)

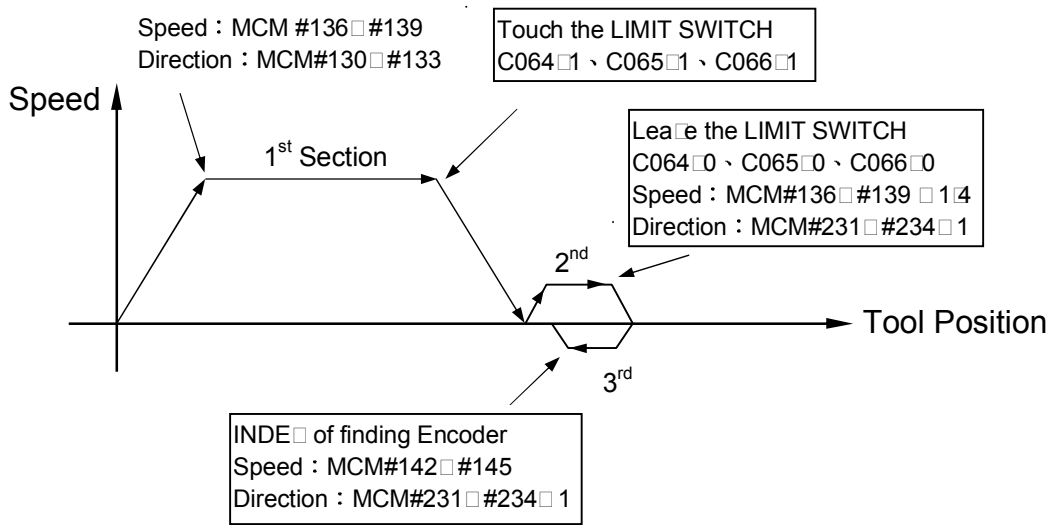

Fig 7-2 (C) Homing Speed and Direction of finding (GRID)

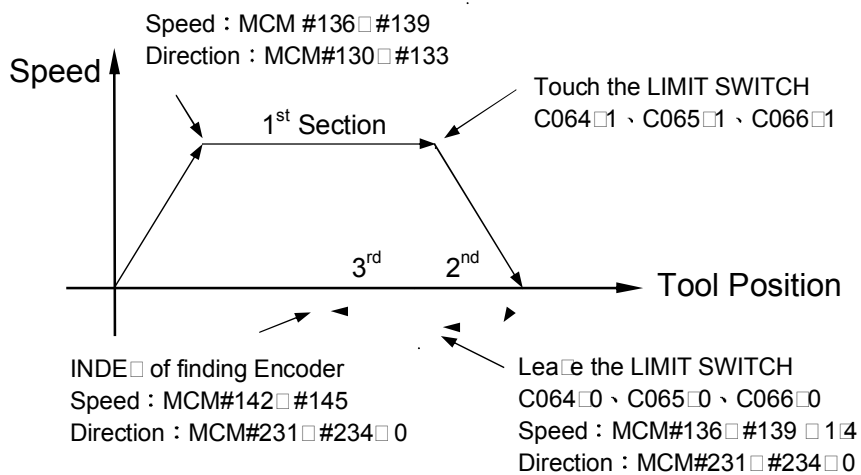

Fig 7-2 (D) Homing Speed and Direction of finding (GRID)

MCM# 350□360 System Reser□ed !

- 361. Setting the □-Home grid setting.
- 362. Setting the □-Home grid setting.
- 363. Setting the □-Home grid setting.
- 364. Setting the A-Home grid setting.
- 365. Setting the B-Home grid setting.
- 366. Setting the C-Home grid setting.
- 367. Setting the U-Home grid setting.
- 368. Setting the V-Home grid setting.
- 369. Setting the W-Home grid setting.

Format□□□□□.□□□ (Default□0.000), unit□mm

Leaving from the origin switch signal, departing from the above set distance, and then you can start to execute the Homing process (third section) to locate the motor Grid signal.

MCM# 370□380 System Reser□ed !

- 381. Home-Shift Data, □-axis.
- 382. Home-Shift Data, □-axis.
- 383. Home-Shift Data, □-axis.
- 384. Home-Shift Data, A-axis.
- 385. Home-Shift Data, B-axis.
- 386. Home-Shift Data, C-axis.
- 387. Home-Shift Data, U-axis.
- 388. Home-Shift Data, V-axis.
- 389. Home-Shift Data, W-axis.

Format : □.□□□ , Unit□mm□min (Default□0.000)

Set the amount of coordinate shift for H□ME location (or machine origin). With these settings, the machine coordinate will be shifted by the same amount when you execute "Home". If home shift data are □ero for all axes, the machine coordinate after "Home" operation will be □ero also. Note that the work coordinate will be shifted by the same amount.

MCM# 390□400 System Reser□ed !

- 401. The distance that ser□o motor search the Grid when □-axis going back to H□ME.
- 402. The distance that ser□o motor search the Grid when □-axis going back to H□ME.
- 403. The distance that ser□o motor search the Grid when □-axis going back to H□ME.
- 404. The distance that ser□o motor search the Grid when A-axis going back to H□ME.
- 405. The distance that ser□o motor search the Grid when B-axis going back to H□ME.
- 406. The distance that ser□o motor search the Grid when C-axis going back to H□ME.

407. The distance that servo motor search the Grid when U-axis going back to HOME.
408. The distance that servo motor search the Grid when V-axis going back to HOME.
409. The distance that servo motor search the Grid when W-axis going back to HOME.
Format□□□□□.□□□□ (Default 10.000)

The distance is maximum when servo motor searching the Grid signal□
E□ :

- The servo motor of □-axis turns 3¼ round □ 5.000 mm, MCM# 401 □ 5.200
- The servo motor of □-axis turns 3¼ round □ 5.000 mm, MCM# 402 □ 5.200
- The servo motor of □-axis turns 3¼ round □ 5.000 mm, MCM# 403 □ 5.200
- The servo motor of A-axis turns 3¼ round □ 5.000 mm, MCM# 404 □ 5.200
- The servo motor of B-axis turns 3¼ round □ 5.000 mm, MCM# 405 □ 5.200
- The servo motor of C-axis turns 3¼ round □ 5.000 mm, MCM# 406 □ 5.200

※ If it exceeds the range and the motor can not find the Grid still. ERR15 will be shown up.

MCM# 410□420 System Reserved !

421. □-axis origin switch (□□N.□ node□-□N.C node)
422. □-axis origin switch (□□N.□ node□-□N.C node)
423. □-axis origin switch (□□N.□ node□-□N.C node)
424. A-axis origin switch (□□N.□ node□-□N.C node)
425. B-axis origin switch (□□N.□ node□-□N.C node)
426. C-axis origin switch (□□N.□ node□-□N.C node)
427. U-axis origin switch (□□N.□ node□-□N.C node)
428. V-axis origin switch (□□N.□ node□-□N.C node)
429. W-axis origin switch (□□N.□ node□-□N.C node)

Example□ MCM 421□5

Set I5 to be the □-axis origin signal with format N□

MCM 425□6

Set I6 to be the A-axis origin signal with format NC

- ※ **Default = 0, Functions are inactive, ≠ 0, Functions are active.**
- ※ **If a homing process with C64-69 is planned in PLC, it shall be based on the activity set by PLC.**

MCM# 430□440 System Reser□ed !

- 441. Direction of Motor Rotation, □-axis.
- 442. Direction of Motor Rotation, □-axis.
- 443. Direction of Motor Rotation, □-axis.
- 444. Direction of Motor Rotation, A-axis.
- 445. Direction of Motor Rotation, B-axis.
- 446. Direction of Motor Rotation, C-axis.
- 447. Direction of Motor Rotation, U-axis.
- 448. Direction of Motor Rotation, V-axis.
- 449. Direction of Motor Rotation, W-axis.

Format : □ , (Default□0)

Setting □ 0, Motor rotates in the posi□e direction. (CW)

Setting □ 1, Motor rotates in the negati□e direction. (CCW)

This MCM can be used to re□erse the direction of motor rotation if desired. So you don't ha□e to worry about the direction of rotation when installing motor. These parameters will affect the direction of H□ME position

IMPORTANT □ Motor Di□ergence

Due to the □ariations in circuit design of the ser□o dri□ers that are a□ailable from the market, the proper electrical connections from ser□o encoder to the dri□er, then to the CNC controller may □ary. If the connections do not match properly, the motor RPM may become di□ergent (Rotate □ HIGH RPM) and damage to the machine may result. For this reason, HUST strongly suggest separate the ser□o motor and the machine before you are 100□ sure the direction of the motor rotation. If a motor di□ergence occurs, please inter-change the connections of (A and B phase) and (A- and B- phase) on the dri□er side.

(This statement has nothing to do with MCM #154□ #157 but it's □ery important when connecting electrical motor.)

If a motor divergence occurs, please inter-change the connections of (A and B phase) and (A- and B- phase) on the driver side.

E□□

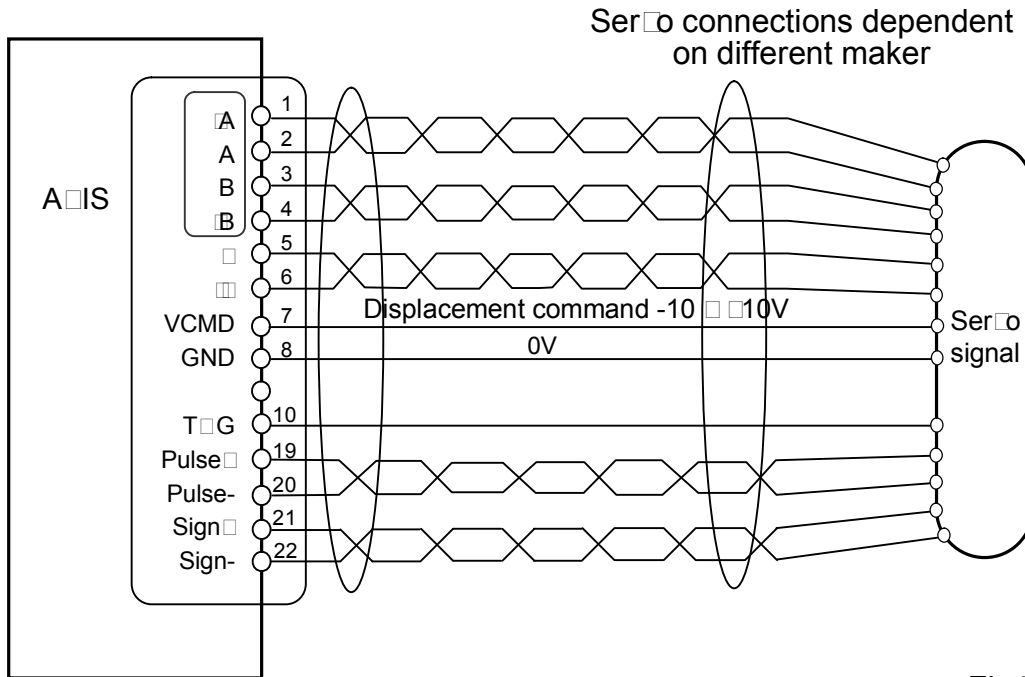

Fig 7.3

MCM# 450□460 System Reser□ed !

- 461. Encoder Multiplication Factor, □-axis.
- 462. Encoder Multiplication Factor, □-axis.
- 463. Encoder Multiplication Factor, □-axis.
- 464. Encoder Multiplication Factor, A-axis.
- 465. Encoder Multiplication Factor, B-axis.
- 466. Encoder Multiplication Factor, C-axis.
- 467. Encoder Multiplication Factor, U-axis.
- 468. Encoder Multiplication Factor, V-axis.
- 469. Encoder Multiplication Factor, W-axis.

Format : □ , (Default□4)

□ only one the following 3 numbers□

- Setting □ 1, Encoder pulse number is multiplied by 1.
- Setting □ 2, Encoder pulse number is multiplied by 2.
- Setting □ 4, Encoder pulse number is multiplied by 4.

Note

The setting of multiplication is highly relative with machine's rigidity. If a motor divergence occurs too heavily, it means that the rigidity is too big. And then it can be improved by lowering the multiplication.

Ex: If factor = 2 for MCM #161 and the encoder resolution is 2000 pulses/rev,
then the feed-back signals = 2000 * 2 = 4000 pulses/rev for X-axis.

MCM# 470-480 System Reserved !

- 481. X-axis impulse command width adjustment.
- 482. Y-axis impulse command width adjustment.
- 483. Z-axis impulse command width adjustment.
- 484. A-axis impulse command width adjustment.
- 485. B-axis impulse command width adjustment.
- 486. C-axis impulse command width adjustment.
- 487. U-axis impulse command width adjustment.
- 488. V-axis impulse command width adjustment.
- 489. W-axis impulse command width adjustment.

Format: [][][] (Default: 4)

Setting range 1-63 °

Used to adjust each axial impulse command width

If the pulse frequency from H4D-H6D-H9D controller is 1Hz, then the cycle time of a pulse is 0.25us. If it is required to extend the pulse cycle time, it can be achieved through adjustment of the impulse width.

For example:

If MCM 486=4, the impulse cycle time in the X-axis direction is 4*0.25=1.5us and the frequency is 625Hz.

MCM# 490-500 System Reserved !

501. Master/Slave Mode Setting

Format : [].[][][] , (Default: 0)

Setting = 0, CNC mode, Master/Slave mode NOT set.

= 1, X-axis as master axis, Y, Z, A, B, C, U, V, W-axis as slave axes.

- 2, □-axis as master axis, □, □, A, B, C, U, V, W -axis as slave axes.
- 3, □-axis as master axis, □, □, A, B, C, U, V, W -axis as slave axes.
- 4, A-axis as master axis, □, □, □, B, C, U, V, W -axis as slave axes.
- 5, B-axis as master axis, □, □, □, A, C, U, V, W -axis as slave axes.
- 6, C-axis as master axis, □, □, □, A, B, U, V, W -axis as slave axes.
- 7, U-axis as master axis, □, □, □, A, B, C, V, W -axis as slave axes.
- 8, V-axis as master axis, □, □, □, A, B, C, U, W -axis as slave axes.
- 9, W-axis as master axis, □, □, □, A, B, C, U, V -axis as slave axes.
- 256, Round Corner Non-stop operation

502. Type of Motor Acceleration/Deceleration

Format : □ , (Default□1)

Setting □ 1, Linear type.

Setting □ 2, "S" curve.

503. Home command mode setting.

BIT0 □ 0 □ axis find Home grid available, □1 □ axis no need to find Home grid.

BIT1 □ 0 □ axis find Home grid available, □1 □ axis no need to find Home grid.

BIT2 □ 0 □ axis find Home grid available, □1 □ axis no need to find Home grid.

BIT3 □ 0 A axis find Home grid available, □1 A axis no need to find Home grid.

BIT4 □ 0 B axis find Home grid available, □1 B axis no need to find Home grid.

BIT5 □ 0 C axis find Home grid available, □1 C axis no need to find Home grid.

BIT6 □ 0 U axis find Home grid available, □1 U axis no need to find Home grid.

BIT7 □ 0 V axis find Home grid available, □1 V axis no need to find Home grid.

BIT8 □ 0 W axis find Home grid available, □1 W axis no need to find Home grid.

504. Servo Motor Acceleration/Deceleration Time, G00.

Format : □□□ , Unit□millisecond (Default□100)

Setting Range□2 □ 3000 millisecond

505. Servo Motor Acceleration/Deceleration Time (T), G01.

Format : □□□ , Unit□millisecond (Default□100)

Setting Range□2 □ 3000 millisecond.

100 milliseconds is the recommended setting for both G00 and G01.

If MCM #502 setting □ 0, type of accel./decel. for G01 □ exponential

If MCM #502 setting □ 1, type of accel./decel. for G01 □ Linear.

If MCM #502 setting □ 2, type of acceleration/deceleration for G01 □ "S"

curve. In this case, the actual acceleration/deceleration time is twice the setting value.

506. Acceleration/Deceleration Time for G99 Mode.

Format : $\square\square\square$, Unit Millisecond (Default 100)

Setting Range 4 ~ 3000 ms.

507. Set the spindle Acceleration/Deceleration time in master mode.

Format : $\square\square\square$, Unit Millisecond (Default 100)

Setting Range 4 ~ 3000 ms.

508. Spindle Encoder Pulse Per Revolution

Format : $\square\square\square\square$, Unit Pulse/rev (Default 4096)

509. Set Spindle Motor RPM When Vcmd = 10 Volt.

Format : $\square\square\square\square$, Unit RPM (Default 3000)

510. Spindle voltage command 0V output balance adjustment (open circuit).

511. Spindle voltage command slope correction (open circuit).

Format : S $\square\square\square\square$, (Default 0), Set the reference value 2047.

512. Spindle RPM correction (based on feedback from the encoder).

513. Starting Number for Auto Generation of Program Block Number.

Format : S $\square\square$, (Default 0)

514. Increment for Auto-generation of Program Block Number.

Format : D $\square\square$, (Default 0)

515. If D = 0, the program block number of a single program block will not be generated automatically.

In the Edit or Teach mode, the block number of a single block can be automatically generated by simply press the INSERT key. If the RESET key is pressed, the block number of a single block will be renumbered according to the setting values in Parameters 514 and 515.

Ex S 0 , D 5

The program block number will be generated in the sequence 5,10,15,20,25

516. Denominator of Feed-rate Multiplication Factor for MPG Test.

517. Numerator of Feed-rate Multiplication Factor for MPG Test.

Format : □□□□□ , (Default □100)

Note □ If the MPG rotation speed is not proper, it can be adjusted by MCM#516, #517. The two items are up to 5 units and it must be integer. They also can not set as zero.

518. Handwheel direction

Format □□ (Default □0).

If it is necessary to change the relation between the current handwheel rotational direction and the axial displacement direction, it can be achieved by setting the value to 0 or 1.

It can be adjusted separately the corresponding axial direction bit 0 □x bit 1 □y....

Example □ BIT 0 □1 The □-axis handwheel command is reverse, but other axes remain at the default.

519. Set Acceleration □Deceleration Time for MPG

Format □□□□□, (Default □64), Unit □milliseconds

Setting Range □4 □512 ms.

The motor acceleration □deceleration time is equal to MCM #519 when MPG hand-wheel is used in □□G mode.

520. RS232C Baud Rate.

Format : □□□□□ , (Default □38400)

Set RS232C communication speed. Choose from, 9600, 19200, 38400, 57600, 115200 Speed rate 38400 stands for 38400 bits per second.

In addition, use the following settings for your PC □

Parity -- Even

Stop Bits -- 2 bits

Data Bits □ 7 bits

521. Flag to Save the Data of R000□R199 in PLC when power-off.

Format : □ , (Default□0)

Setting □ 0, NOT to save.

Setting □ 256, Save R000□R199 data.

522. Servo Error Count

Format : □ , (Default□0)

When executing locating operation, the controller has sent out the voltage command, but the motor maybe fall behind some distance. This parameter is used to set that the controller could execute next operation or not according to the setting range of pulse

Set MCM#522 □ 0 for generating 4096 pulses.

Set MCM#522 ≠ 0 for user defined value.

523. Radius □diameter programming mode

Format□□ (Default □ 0)

0□Radius programming

1□Diameter programming

524. METRIC□INCH Mode Selection (default □ 0)

Format : □□□ , (Default □ 0)

Setting □ 0, Measurement in METRIC unit.

Setting □ 1, Measurement in INCH unit.

525. Error in Circular Cutting

Format : □□□□ , (Default □ 1)

Range□ □ 32

In circular cutting, the ideal cutting path is a circular arc, but the actual motor path is along the arc cord (a straight line). Therefore, there is a cutting error as shown in the figure below.

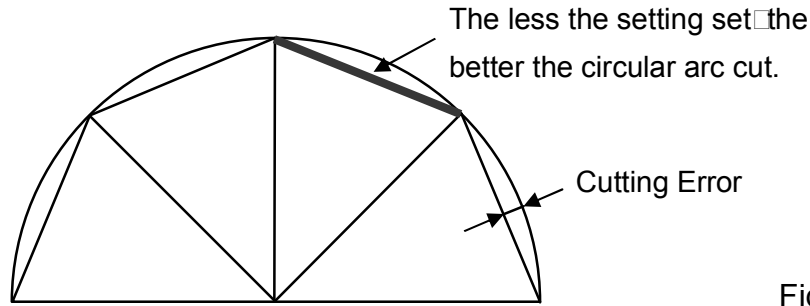

Fig 7.4

This parameter enables the user to adjust acceptable error. The smaller is the setting (01, the best), the better the circular cutting result. However, the setting should not be too small to the point that it's not able to drive the motor.

526. 6-axis parameter settings in pulse type

Format □□□□□, Default□0

Setting =0□ pulse □ direction

Setting =1□ □□ pulse

Setting =2□ in the format of Phase A or B

527. Setting the G01 speed □value at booting

Format□□□□□□□□ (Default□1000)

After booting, in executing the program or MDI command, if you have not used the F command yet, nor the current single block has designated the F □value, then use the MCM 527 □value as the F □value of the current single block.

528. Setting the tool compensation direction

Format□□ (Default□0)

0 : HUST

1 : FANUC

Tool-wear compensation direction - HUST□ same direction□ FANUC□ reverse direction.

529. It is used for adjusting the G01's acceleration□deceleration time when the acceleration□deceleration type is set to an □S□curve.

Format□□□□ (Default□100) in unit of millisecond (msec).
 When MCM 502=2, the function can then be sustained.
 Setting range 10□512 ms.

531. Line editing entry format and numeral decimal□ automatic-generating setting.

Format=□ (default setting 0)

=0 The standard mode.

=1 When setting the parameter □ values in the system master list, the system will automatically add a decimal point to e□en numbers.

Ex : MCM 401 setting

Enter □ ” =1.000

Enter □nter ng=1.999

=2 Line Editing.

Ex : Enter G00 □10.

Standard mode steps :

Step 1	Step 2	Step 3	Step 4
G□□	ENTER	□10.	ENTER

Line editing :

Step 1	Step 2
G□□ □10.	ENTER

=4 At editing, decimal point will be automatically generated for the □variable □alue.

At program editing and also entering e□en numbers, the system will automatically add decimal point to e□en numbers.

532. In the milling mode, set the gap for drill to withdraw.

Format□□. □□□ (Default□2.000) unit□mm

533. Setting the test following count

Format□□□□□□□□ (Default□0)

With use of parameter Item No.534

534. Testing the axial setting of the ser□o following error function

Format□□□□ (Default □0)

Set the testing corresponding to the axis with Bit

Description□

When $MCM534 = 1$ and Bit0 □ 1, test the □-axis.

When $MCM534 = 2$ and Bit1 □ 1, test the □-axis.

When $MCM534 = 4$ and Bit2 □ 1, test the □-axis.

When $MCM534 = 8$ and Bit3 □ 1, test the A-axis.

When $MCM534 = 16$ and Bit4 □ 1, test the B-axis.

When $MCM534 = 32$ and Bit5 □ 1, test the C-axis.

When $MCM534 = 64$ and Bit6 □ 1, test the U-axis.

When $MCM534 = 128$ and Bit7 □ 1, test the V-axis.

When $MCM534 = 256$ and Bit8 □ 1, test the W-axis.

When $MCM534 = 511$, i.e. Bit0 □ Bit8 □ 1, then test □□□□A□B□C□U□V□W-axes at the same time.

Caution: For HUST H4D/H6D/H9D controller, if the servo motor used is a voltage command type, it is necessary to set testing the following error function (not applicable for the impulse command type).

The controller will compare the actual feedback difference of the ser□o motor with the setting of the parameter Item No 533. If the controller detects that the axis has been set beyond the range, the system will display an error message.

Example□When the parameter Item No 533□ 4096, the parameter Item No 534□1, and

The actual motor following error

>

4096 (Parameter Item No 533), it will generate ERROR 02 X

535. Controller ID number

Control connection of multiple units with PC. Currently, the function is reser□ed.

536. Setting the minimum slope of the Auto Teach function

Format $\square\square\square\square\square.\square\square$ (Default $\square 0$)

Setting range $\square\square 360.00 \square -360.00$

537. Setting the first point distance of the Auto Teach function.

Format $\square\square\square\square.\square\square\square$ (Default $\square 0$)

538. G41 and G42 Handling type

Format $\square\square$ (Default 0)

When the setting value $\square 0$, an error is displayed, the interference problem is not handled, and the motion is stopped.

- $\square 1$ Automatically handle the interference problem.
- $\square 2$ The error message is not displayed and the interference problem is not handled.

539. System Reserved

540. Adjustment of the feedback direction for the axes

Format $\square\square\square\square$ (Default 0)

Set the corresponding axes by the bit pattern.

Description \square

If MCM540 = 1, Bit0 $\square 1$, the feedback direction is reverse for the \square -axis.

If MCM540 = 2, Bit1 $\square 1$, the feedback direction is reverse for the \square -axis.

If MCM540 = 4, Bit2 $\square 1$, the feedback direction is reverse for the \square -axis.

If MCM540 = 8, Bit3 $\square 1$, the feedback direction is reverse for the A-axis.

If MCM540 = 16, Bit4 $\square 1$, the feedback direction is reverse for the B-axis.

If MCM540 = 32, Bit5 $\square 1$, the feedback direction is reverse for the C-axis.

If MCM540 = 64, Bit6 $\square 1$, the feedback direction is reverse for the U-axis.

If MCM540 = 128, Bit7 $\square 1$, the feedback direction is reverse for the V-axis.

If MCM540 = 256, Bit8 $\square 1$, the feedback direction is reverse for the W-axis.

541. Arc type

Format $\square\square$ (Default 0)

Setting $\square 0$ arc cord height control.

- 1 arc cord length control.
- 2 system internal automatic control (500 sections□sec).

MCM# 542□560 System Reserved !

- 561. □S□curve accel.□decel. profile setting for the □-axis.
- 562. □S□curve accel.□decel. profile setting for the □-axis.
- 563. □S□curve accel.□decel. profile setting for the □-axis.
- 564. □S□curve accel.□decel. profile setting for the A-axis.
- 565. □S□curve accel.□decel. profile setting for the B-axis.
- 566. □S□curve accel.□decel. profile setting for the C-axis.
- 567. □S□curve accel.□decel. profile setting for the U-axis.
- 568. □S□curve accel.□decel. profile setting for the V-axis.
- 569. □S□curve accel.□decel. profile setting for the W-axis.

When R209 Bit30□1, the “□S□curve accel.□decel. profile settings can be configured independently.

MCM# 570□580 System Reserved !

- 581. Software □T Limit in (□) Direction, □-axis. (Group 1)
 - 582. Software □T Limit in (□) Direction, □-axis. (Group 1)
 - 583. Software □T Limit in (□) Direction, □-axis. (Group 1)
 - 584. Software □T Limit in (□) Direction, A-axis. (Group 1)
 - 585. Software □T Limit in (□) Direction, B-axis. (Group 1)
 - 586. Software □T Limit in (□) Direction, C-axis. (Group 1)
 - 587. Software □T Limit in (□) Direction, U-axis. (Group 1)
 - 588. Software □T Limit in (□) Direction, V-axis. (Group 1)
 - 589. Software □T Limit in (□) Direction, W-axis. (Group 1)
- Format : □□□□□□□□ , Unit□mm□min (Default□9999.999)

Set the software over-travel (□T) limit in the positive (□) direction, the setting value is equal to the distance from positive □T location to the machine origin (H□ME).

MCM# 590□600 System Reserved !

- 601. Software □T Limit in (-) Direction, □-axis. (Group 1)
- 602. Software □T Limit in (-) Direction, □-axis. (Group 1)

646. Software \square T Limit in (-) Direction, C-axis. (Group 2)
 647. Software \square T Limit in (-) Direction, U-axis. (Group 2)
 648. Software \square T Limit in (-) Direction, V-axis. (Group 2)
 649. Software \square T Limit in (-) Direction, W-axis. (Group 2)
 Format : $\square\square\square\square.\square\square\square$, Unit \square mm \square min (Default \square -9999.999)

※In PLC when C10=1, it detects unit 2 software's range limit.

※,Set the software over-travel (\square T) limit in the negative (-) direction, the setting value is equal to the distance from negative \square T location to the machine origin (HOME).

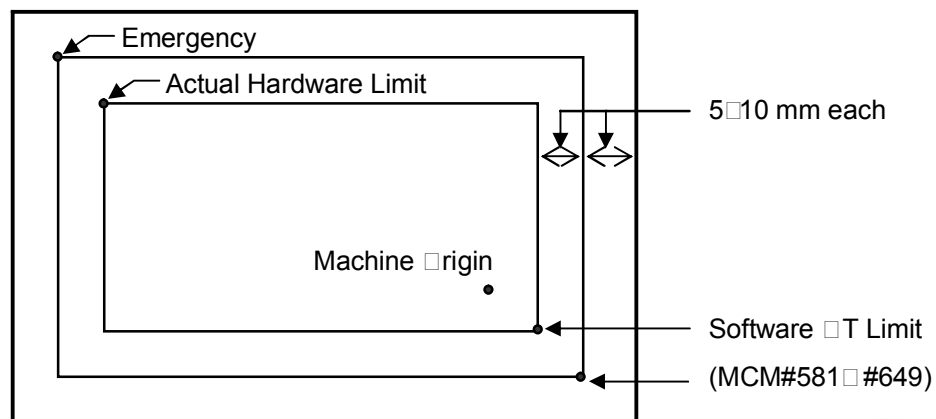

Fig 7.5

MCM# 650-660 System Reserved !

661. Flag to Clear \square -axis Program Coordinate on M02, M30 or M99 Command.
 662. Flag to Clear \square -axis Program Coordinate on M02, M30 or M99 Command.
 663. Flag to Clear \square -axis Program Coordinate on M02, M30, or M99 Command.
 664. Flag to Clear A-axis Program Coordinate on M02, M30, or M99 Command.
 665. Flag to Clear B-axis Program Coordinate on M02, M30, or M99 Command.
 666. Flag to Clear C-axis Program Coordinate on M02, M30, or M99 Command.
 667. Flag to Clear U-axis Program Coordinate on M02, M30, or M99 Command.
 668. Flag to Clear V-axis Program Coordinate on M02, M30, or M99 Command.
 669. Flag to Clear W-axis Program Coordinate on M02, M30, or M99 Command.

Format : \square , (Default \square 0)

Used as flag to clear the coordinate when program execution encounters M02, M30 or M99 function. The following settings are valid for both \square and \square -axis.

Setting 0, Flag is FF, N T to clear.

Setting 1, Flag is N, ES to clear when encountering M02 and M30.

Setting 2, Flag is N, ES to clear when encountering M99.

Setting 3, Flag is N, ES to clear when encountering M02, M30 and M99.

MCM# 670-680 System Reser ed !

681. Set Incremental Absolute Mode, X-axis coordinate.

682. Set Incremental Absolute Mode, Y-axis coordinate.

683. Set Incremental Absolute Mode, Z-axis coordinate.

684. Set Incremental Absolute Mode, A-axis coordinate.

685. Set Incremental Absolute Mode, B-axis coordinate.

686. Set Incremental Absolute Mode, C-axis coordinate.

687. Set Incremental Absolute Mode, U-axis coordinate.

688. Set Incremental Absolute Mode, V-axis coordinate.

689. Set Incremental Absolute Mode, W-axis coordinate.

Format : X , (Default 1) for absolute positioning

Ex Set MCM 681 0, X value represents the incremental position and U value is ineffecti e.

1, X value represents the incremental position and U value is the incremental position.

*Note 1 After the parameters are set, execute the command **G01** X***, Y***, Z*** F***, the program will perform the axial motions according to the configured incremental or absolute positions.

H9D When R209 4, the incremental address codes of X, Y, Z will be U, V, W. However, the A, B, C axes have no incremental address code, they cannot be used in the same way as the X, Y, Z axes which allow the conversion between the incremental positioning and the absolute positioning. It is necessary to use the **G90/G91** modes to use them.

H9D X, Y, Z, A, B, C, U, V, W have no incremental address codes, so they cannot allow the conversion between the incremental positioning and the absolute positioning. It is necessary to use the G90 G91 mode to use them.

not necessary. The axis will move to nowhere.

Until it meeting G90 or recycling the program, then the G91 will be over.

E□2□G91 Set Incremental Coordinate

N1 G91

N2 G1 □20.000 □15.000 P0 to P1

N3 □15.000 □10.000 P1 to P2

N4 □25.000 □5.000 P2 to P3

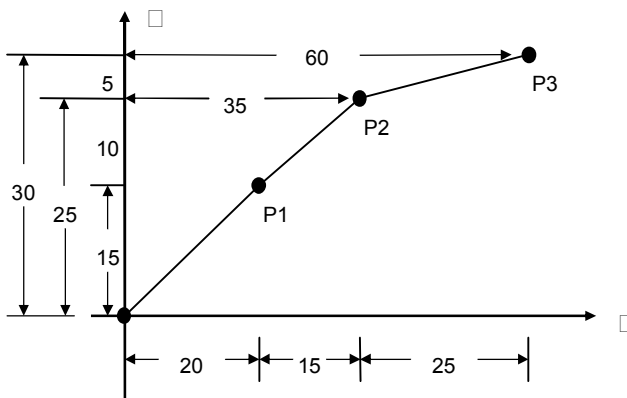

Fig 7.6

MCM# 690□700 System Reser□ed !

701. □-axis, Position gain.

702. □-axis, Position gain.

703. □-axis, Position gain.

704. A-axis, Position gain.

705. B-axis, Position gain.

706. C-axis, Position gain.

707. U-axis, Position gain.

708. V-axis, Position gain.

709. W-axis, Position gain.

Format : □□□ , (Default□64) , Setting Range□8□640 ◦

Parameters 701□709 are used to set the loop gain. The recommended □alue is 64. This setting □alue is essential to the smooth operation of the motor. □nce it is configured, please do not change it arbitrarily.

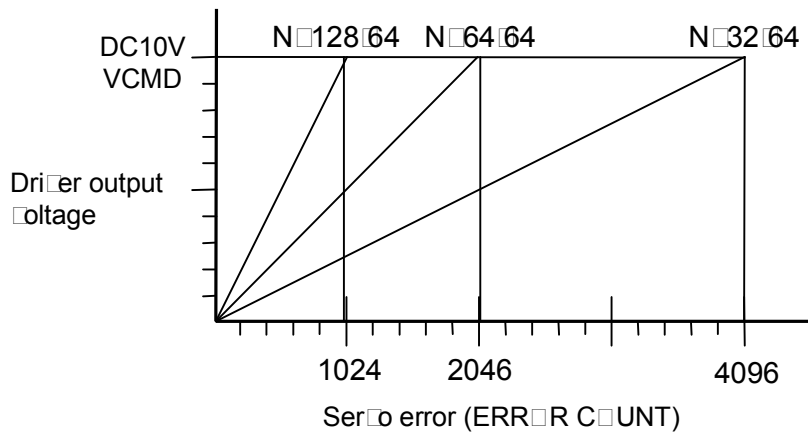

Fig 7-7 Driver output voltage vs. the servo error

The position gain and HUST H4D/H6D/H9D output voltage command can be calculated as follows

$$\text{Position Gain} = \frac{\text{Setting value}}{64}$$

$$\text{NC controller output voltage command} = \text{GAIN} * \text{Servo feedback error} * \left(\frac{10\text{V}}{2048} \right)$$

The controller in HUST is a closed-loop system. The servo error is the difference between the controller position command and the actual feedback value of the servo motor. The controller will adjust the output voltage of the controller properly according to this difference value. The setting value of the position gain is related to the stability and the follow-up of the system servo, so please modify it with care. If

Servo mismatch > 4096, the ERROR 02 will occur.

In this case, please correct the values of MCM Parameters 701~709 and then press the “Reset” key. If the problem still exists, please check if the wire connection of the servo motor is correct.

Adjustment procedure for smooth motor operation (recommended)

- (1) Adjust the servo driver. (Please refer to the operation manual of the driver)
- (2) Adjust the MCM Parameters 461~469 for the multipliers (1,2,4) of the signals from the the speed sensors. In normal condition, if the motor is locked, the Servo Error will be oscillating between 0 and 1 if it is oscillating between 4 and 5, the problem can be solved usually by adjusting the MCM Parameters 461 ~ 469 for the multipliers, i.e., 4 --□ 2, or 2 --□ 1.
- (3) Adjust the values of MCM Parameters 701~709 for the position loop gain.

MCM# 710~720 System Resolved !

- 721. Break-over Point (in Error Count) for Position Gain, X-axis.
 - 722. Break-over Point (in Error Count) for Position Gain, Y-axis.
 - 723. Break-over Point (in Error Count) for Position Gain, Z-axis.
 - 724. Break-over Point (in Error Count) for Position Gain, A-axis.
 - 725. Break-over Point (in Error Count) for Position Gain, B-axis.
 - 726. Break-over Point (in Error Count) for Position Gain, C-axis.
 - 727. Break-over Point (in Error Count) for Position Gain, U-axis.
 - 728. Break-over Point (in Error Count) for Position Gain, V-axis.
 - 729. Break-over Point (in Error Count) for Position Gain, W-axis.
- Format : □□□ , (Default□10)

The proper setting of this parameter will assure smooth start-up of servo motor. When servo error is smaller than the setting value of MCM #721~#729, the position gain is 64. Otherwise, position gain will be calculated based on the setting value of MCM #701~#709 and the setting values depend on the frictional load on the motor. If the frictional load is high, setting value is small and vice versa.

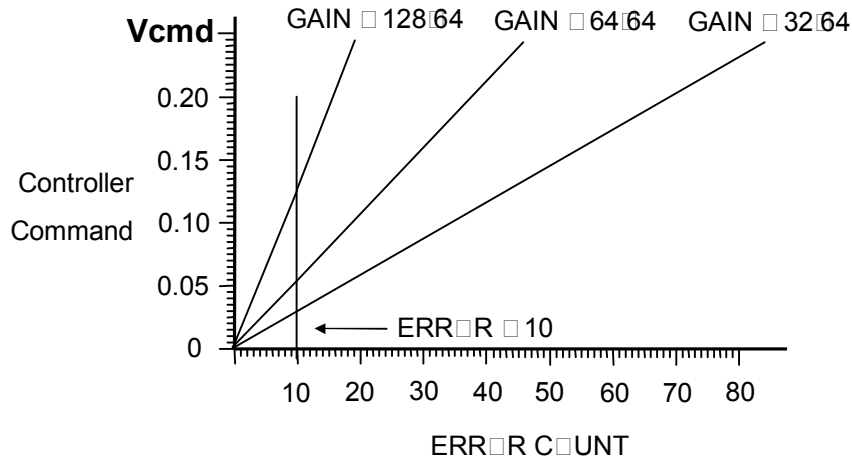

Fig 7.7

MCM# 730-740 System Reser^oed !

741. X-axis Denominator, MPG Hand-wheel Resolution Ad^oustment. (pulse)

742. X-axis Numerator, MPG Hand-wheel Resolution Ad^oustment. (μ m)

743. Y-axis Denominator, MPG Hand-wheel Resolution Ad^oustment. (pulse)

744. Y-axis Numerator, MPG Hand-wheel Resolution Ad^oustment. (μ m)

745. Z-axis Denominator, MPG Hand-wheel Resolution Ad^oustment. (pulse)

746. Z-axis Numerator, MPG Hand-wheel Resolution Ad^oustment. (μ m)

747. A-axis Denominator, MPG Hand-wheel Resolution Ad^oustment. (pulse)

748. A-axis Numerator, MPG Hand-wheel Resolution Ad^oustment. (μ m)

749. B-axis Denominator, MPG Hand-wheel Resolution Ad^oustment. (pulse)

750. B-axis Numerator, MPG Hand-wheel Resolution Ad^oustment. (μ m)

751. C-axis Denominator, MPG Hand-wheel Resolution Ad^oustment. (pulse)

752. C-axis Numerator, MPG Hand-wheel Resolution Ad^oustment. (μ m)

753. U-axis Denominator, MPG Hand-wheel Resolution Ad^oustment. (pulse)

754. U-axis Numerator, MPG Hand-wheel Resolution Ad^oustment. (μ m)

755. V-axis Denominator, MPG Hand-wheel Resolution Ad^oustment. (pulse)

756. V-axis Numerator, MPG Hand-wheel Resolution Ad^oustment. (μ m)

757. W-axis Denominator, MPG Hand-wheel Resolution Ad^oustment. (pulse)

758. W-axis Numerator, MPG Hand-wheel Resolution Adjustment. (μm)

Format : $\square\square\square\square$, (Default $\square 100$)

Unit \square Denominator \square pulses, Numerator $\square \mu\text{m}$

Ex1 \square For \square -axis, MCM #741 $\square 100$ pulses, MCM #742 $\square 100 \mu\text{m}$.

The resolution for \square -axis $\square 100 \square 100 \square 1 \mu\text{m} \square \text{pulse}$.

If MPG hand-wheel moves 1 notch ($\square 100$ pulses), the feed length in \square -axis $\square 100 \times (100 \square 100) \square 100 \mu\text{m} \square 0.1 \text{ mm}$.

Ex2 \square For \square -axis, MCM #743 $\square 200$ pulses, MCM #744 $\square 500 \mu\text{m}$.

The resolution for \square -axis $\square 500 \square 200 \square 2.5 \mu\text{m} \square \text{pulse}$.

If MPG hand-wheel moves 1 notch ($\square 100$ pulses), the feed length in \square -axis $\square 100 \times (500 \square 200) \square 250 \mu\text{m} \square 0.25 \text{ mm}$.

MCM# 759 \square 780 System Reserved !

781. Set if \square -axis is rotational axis.

782. Set if \square -axis is rotational axis.

783. Set if \square -axis is rotational axis.

784. Set if A-axis is rotational axis.

785. Set if B-axis is rotational axis.

786. Set if C-axis is rotational axis.

787. Set if U-axis is rotational axis.

788. Set if V-axis is rotational axis.

789. Set if W-axis is rotational axis.

Format $\square\square$ (Default 0)

Setting $\square 0$ Linear Axis

Setting $\square 1$ Rotational Axis

MCM# 787 \square 800 System Reserved !

801. The distance of S bit sent before the \square -axis reaches in position. (S176)

802. The distance of S bit sent before the \square -axis reaches in position. (S177)

803. The distance of S bit sent before the \square -axis reaches in position. (S178)

804. The distance of S bit sent before the A-axis reaches in position. (S179)

805. The distance of S bit sent before the B-axis reaches in position. (S180)

806. The distance of S bit sent before the C-axis reaches in position. (S181)

807. The distance of S bit sent before the U-axis reaches in position. (S182)

808. The distance of S bit sent before the V-axis reaches in position. (S183)

809. The distance of S bit sent before the W-axis reaches in position. (S184)

Format□□□□□.□□□ (Default□ 0.000)

Unit□mm

For example□MCM 801 □10.00mm

Gi□ing the command□When G01 U30.000 F1000, when the □-axis mo□e 20.000mm and 10.000mm away from the final □alue, the system will send S176□□N ◦

MCM# 807□820 System Reser□ed !

821. The accelerate□decelerate time of □-axis.

822. The accelerate□decelerate time of □-axis.

823. The accelerate□decelerate time of □-axis.

824. The accelerate□decelerate time of A-axis.

825. The accelerate□decelerate time of B-axis.

826. The accelerate□decelerate time of C-axis.

827. The accelerate□decelerate time of U-axis.

828. The accelerate□decelerate time of V-axis.

829. The accelerate□decelerate time of W-axis.

Format□□□□□ (Default 0), Unit (msec)

Acceleration□Deceleration Time (2□3000)

When R209 Bit30=1, the acceleration□deceleration speed can be programmed independently.

MCM# 830□840 System Reser□ed !

The pitch error compensation of the guide screw in HUST H4D□H6D□H9D is relative to the **mechanical origin as the base point**.

841. Pitch Error Compensation Mode Setting, □-axis.

842. Pitch Error Compensation Mode Setting, □-axis.

843. Pitch Error Compensation Mode Setting, □-axis.

844. Pitch Error Compensation Mode Setting, A-axis.

845. Pitch Error Compensation Mode Setting, B-axis.

846. Pitch Error Compensation Mode Setting, C-axis.

847. Pitch Error Compensation Mode Setting, U-axis.

- 848. Pitch Error Compensation Mode Setting, V-axis.
 - 849. Pitch Error Compensation Mode Setting, W-axis.
- Format [] , Default [0]

Setting [0], Compensation canceled.

Setting [-1], Negative side of compensation.

Setting [1], Positive side of compensation.

[]-axis	[]-axis	[]-axis	A-axis	B-axis	C-axis	U-axis	V-axis	W-axis	Explanation
0	0	0	0	0	0	0	0	0	Compensation cancel
-1	-1	-1	-1	-1	-1	-1	-1	-1	Do compensation when tool is on the (-) side of the reference point
1	1	1	1	1	1	1	1	1	Do compensation when tool is on the (+) side of the reference point.

Ex []

MCM # 841 [-1

The pitch error in the []-axis will not be compensated when the tool travels to the positive side of the []-H []ME location. It will be compensated when the tool travels to the negative side of machine origin.

MCM # 841 [1

The pitch error in the []-axis will be compensated when the tool travels to the positive side of []-H []ME location. No compensation will be done when it travels to the negative side of machine origin.

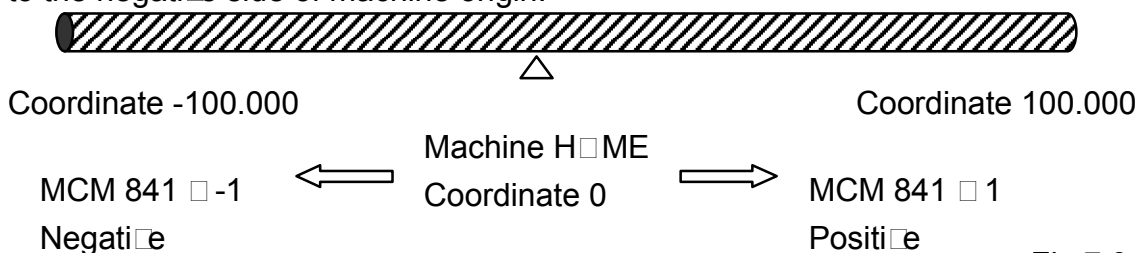

Fig 7.9

MCM#850 System Reserved !

- 851. Segment Length for Pitch Error Compensation, []-axis.
- 852. Segment Length for Pitch Error Compensation, []-axis.
- 853. Segment Length for Pitch Error Compensation, []-axis.
- 854. Segment Length for Pitch Error Compensation, A-axis.
- 855. Segment Length for Pitch Error Compensation, B-axis.
- 856. Segment Length for Pitch Error Compensation, C-axis.

Format□□.□□□□, Default□0, Unit□mm

Axis	Corresponding MCM# for Segment Length	Segment Length	Max. Number of Segment
□	MCM# 861 □ 940	20 □ 480 mm	80
□	MCM# 941 □ 1020	20 □ 480 mm	80
□	MCM# 1021 □ 1100	20 □ 480 mm	80
A	MCM# 1101 □ 1180	20 □ 480 mm	80
B	MCM# 1181 □ 1260	20 □ 480 mm	80
C	MCM# 1261 □ 1340	20 □ 480 mm	80

1. Segment length is the total length of ball-screw divided by the number of segment.

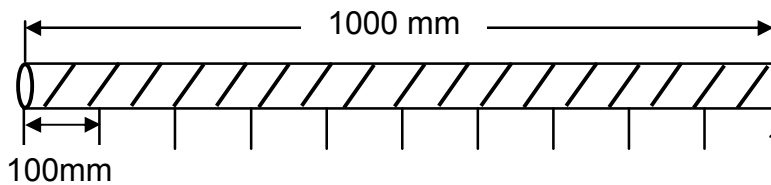

Fig7.10

Ex□

If you want to divide the ball-screw on □-axis, which is 1 meter in length, into 10 segments, the segment length is $1000.00 \div 10 = 100.00$ mm. This 100.00 mm will be stored in MCM# 851.(Each compensation of them is set by MCM#861 □ #940)

2. If the average segment length is less than 20 mm, use 20 mm.
3. When doing compensation, HUST H4D □ H6D □ H9D controller will further divide each segment into 8 sections. The amount of compensation for each section is equal to the whole number, in μ m, of $1/8$ of the amount in MCM #861 □ #940. The remainder will be added to the next section.

Ex□

Segment length □100.00mm and the amount of compensation is 0.026mm as set in MCM#861. Then, the compensation for each section is $0.026 \div 8 = 0.00325$ mm. The compensation for this segment will be done in a manner as tabulated below□

Section	Tool Position	Avg. comp. For each section	Actual comp. At each section	Accumulated compensation
1	12.5	0.00325	0.003	0.003
2	25	0.00325	0.003	0.006

3	37.5	0.00325	0.003	0.009
4	50	0.00325	0.004	0.013
5	62.5	0.00325	0.003	0.016
6	75	0.00325	0.003	0.019
7	87.5	0.00325	0.003	0.022
8	100	0.00325	0.004	0.026

MCM# 857-860 System Reserved !

861-1340. Amount of Compensation for each segment (X-Y-Z-A-B-C-axis) is 80.

The Compensation value is in incremental mode. If the number of segment is less than 80, please fill the uncompensated segments with zero to avoid any potential errors.

Example

If the segment of compensation is 10, the amount of the compensation from Seg.11 to 40 (X-axis MCM#861-940, Y-axis MCM#941-1020, Z-axis MCM#1021-1100, A-axis MCM #1101-1180, B-axis MCM#1181-1260, C-axis MCM#1261-1340) must be set as zero.

- MCM#861-940 Pitch error compensation of each segment, X-axis.
- MCM#941-1020 Pitch error compensation of each segment, Y-axis.
- MCM#1021-1100 Pitch error compensation of each segment, Z-axis.
- MCM#1101-1180 Pitch error compensation of each segment, A-axis.
- MCM#1181-1260 Pitch error compensation of each segment, B-axis.
- MCM#1261-1340 Pitch error compensation of each segment, C-axis.

Format : X.XXX, Unit:mm (Default=0.000)

- 1341. Tool#1, Radius offset Data.
- 1342. X-axis offset Data, Tool#1.
- 1343. Y-axis offset Data, Tool#1.
- 1344. Z-axis offset Data, Tool#1.
- 1345. A-axis offset Data, Tool#1.
- 1346. B-axis offset Data, Tool#1.
- 1347. C-axis offset Data, Tool#1.

Format : X.XXX, Unit:mm (Default=0.000)

- 1348. Tool#2, Radius offset data.
- 1349. X-axis offset data, Tool#2.

1350. X-axis offset data, Tool#2.

1351. Y-axis offset data, Tool#2.

1352. A-axis offset data, Tool#2.

1353. B-axis offset data, Tool#2.

1354. C-axis offset data, Tool#2.

Format : X.YZZ , Unit:mm (Default=0.000)

MCM#1355-1620 : Tool#3-40, Radius offset data and X.Y.Z-A-B-C-axis offset data ◦

1621. Tool #1 radius wear compensation.

1622. X-axis, Tool #1 wear compensation.

1623. Y-axis, Tool #1 wear compensation.

1624. Z-axis, Tool #1 wear compensation.

1625. A-axis, Tool #1 wear compensation.

1626. B-axis, Tool #1 wear compensation.

1627. C-axis, Tool #1 wear compensation.

Format : X.YZZ , Unit:mm (Default=0.000)

1628. Tool #2 radius wear compensation.

1629. X-axis, Tool #2 wear compensation.

1630. Y-axis, Tool #2 wear compensation.

1631. Z-axis, Tool #2 wear compensation.

1632. A-axis, Tool #2 wear compensation.

1633. B-axis, Tool #2 wear compensation.

1634. C-axis, Tool #2 wear compensation.

Format : X.YZZ , Unit:mm (Default=0.000)

MCM#1635-1900 : Tool#3-40, Radius wear compensation and X.Y.Z-A-B-C-axis wear compensation ◦

1901-1940 : Tool-tip radius compensation (Tool-tip#1-40)

8 APPENDIX

● Input Arrangement

Input	Description	Note
I00	EM-STOP	Normally Close
I01	X-axis Home Limit	Normally Close
I02	Z-axis Home Limit	Normally Close
I03	Foot-Switch	Talk Switch (PTT)
I04	Option Skip	Auto/ Semi-Auto Switch
I05	Spindle Speed Arrival	(Reserved)
I06		
I07		
I08	CYCST (Key)	Reserved for the External Panel
I09	Feed Hold (Key)	Reserved for the External Panel
I10	Reset (Key)	Reserved for the External Panel
I11	Tool Changer (Key)	Reserved for the External Panel
I12	No.1 Tool Positioning Signal	
I13	No.2 Tool Positioning Signal	
I14	No.3 Tool Positioning Signal	
I15	No.4 Tool Positioning Signal	
I16	No.5 Tool Positioning Signal	
I17	No.6 Tool Positioning Signal	
I18	No.7 Tool Positioning Signal	
I19	No.8 Tool Positioning Signal	
I20	Turret Clamp	
I21	Bar Feeder Ready	
I22		
I23		

● **Output Arrangement**

Output	Description	Note
O00	Spindle CW	
O01	Spindle CCW	
O02	Coolant	
O03	Alarm Light	
O04	Spindle Unclamp	
O05	Lubrication	
O06	Unclamp Light	
O07		
O08	Tool CW	
O09	Tool CCW	
O10		
O11	Bar Feeder	
O12		
O13	Work-piece No. on	
O14	Servo-on X	
O15	Servo-on Z	

● **M-code Versus I/O**

M code	Description	I/O	Note
M03	Spindle CW	000=1	
M04	Spindle CCW	001=1	
M05	Spindle stop	000=0,001=0	
M08	Coolant On	002=1	
M09	Coolant Off	002=0	
M10	Chuck On	004=1	
M11	Chuck Off	004=0	
M15	Counter+1 #9501+1		
M16	Clear Counter		

- PLC Parameters

Arc comp. function 1:cancel	0	Tool change time(10ms)	00000
Tool positioning delay(10ms)	0000	Max value of WEAR	00.000
Wear direction	0	Lubricate time(10ms)	000000
Lubricate interval(sec)	000000	Tool carrier 0:Back 1:Front	0
Turret Mode	0	Tool number(1~10)	00
Bar Feeder Timer_1	0000	Bar Feeder Timer_2	0000
Bar Feeder Timer_3	0000	Bar Feeder Timer_4	0000
Pulse type 0:P+D 1:CW/CCW 2:AB	0	BaudRate	000000
Power on default 0:G99 1:G98	0	G84 Tapping type 0:G98 1:G99	0
Chuck type 0:hydraulic 1:general	0	Sp Stop after process 1:Yes	0
Sp rpm of chuck unclamp	00000	Sp filter constant at G02/G03	0000
Spindle --> standard servo axis			
Resolution-Den.(pulse)	0000000	Traverse speed	0000000
Resolution-Num.(pitch)	0000000	Acc/Dec time	0000
Back Main	Change Password		MCM Modify

Fig.8-1

Time- 1~4:

Steps for automatic feeder:

When there is an automatic bar feeder (Cylinder, Hydrometer), I04=0

M10 includes 2 procedures:

- Chuck loosen-delay (Time-1) unit /10ms, which is set by machine manufacturers.
- Feed cylinder executes the process.

M11 includes 2 procedures:

- Chuck tighten- (Time-2) unit/10ms, which is set by machine manufacturers.
- Feed cylinder returned. Process is complete.

Time-3: feed time. The setting is based on the length of the material.

Time-4: Tool clamp delay time.

Tool numbers:

Steps for Lathe tool changer:

1. Tool changer Clockwise O08=1
2. Turn to tool number selection INPUT, manual tool changer is the next.
3. O08=0
4. Pause $50 \times 5 = 250$ ms (Timer =79)
5. Tool changer counter clockwise O09=1
6. Wait for the signal of tool lock I20=1
7. Counter Clockwise Continue (Time-4) ms (timer=78)

8. O09=0, Tool changer stops.

Tool numbers ≤ 1 & > 8 Tool changer remains

> 1 or < 8 Tool changes

Two – six tool numbers can be assigned.

Example: Tool numbers =5

Manual tool changer 1,2,3,4, 1, 2,3... cycle.

TCODE→ tool changes.

T202 → changes to the next tool and select the second set of tool

compensation.

T603→ Tool number remains. Because 6 is bigger than 5, it will select the third set of tool compensation instead.