

VTWIN

Hardware Manual

ESA elettronica S.P.A. reserves the right to change the information contained in this document without notice. The information represents no obligation on the part of the company.

All products referred to are covered by the appropriate trademark and/or copyright legislation.

Quality Assurance

ESA elettronica's quality control system has been certified by the CSQ, EQNet and ITQS (certification N° 9115.ESAE) as complying with UNI EN ISO 9001:2000 standards.

These represent the most comprehensive set of standards within the international framework of ISO and cover every aspect of the life-cycle of the product (planning, development, production, installation and customer care).



All the products described in this manual comply with the following standards:

electromagnetic compatibility (EMC):

- emissions EN 61000-6-4 (2001)
- immunity EN 61000-6-2 (2001)

and thus are in line with:

Council Directives
89/336/EEC 92/31/EEC 93/68/EEC

Products bearing the mark cULus have been certified in compliance with UL 508 and CSA C22.2 N°14-M95 safety standards.

Video terminals VT50 and VT60 have also obtained:

RINA Approval
Registro Navale Italiano
No. ELE/797/1

DNV certification
Det Norske Veritas
Certificate No. A-9044

Table 0.1: Tests carried out for CE-mark.

Immunity	Disturbance characteristics	Standard
To disturbances	Electrostatic discharge: Contact Air	EN61000-4-2 4kV 8kV
	Radio-Frequency	ENV50140/ENV50141 10 V/m
	Rapid transitories: Power supply I/O serial	EN61000-4-4 2 kV 1 kV
	Impulsive transitories Common and Differential mode	EN61000-4-5
To radio disturbances	Emission	EN55011 Level of radio disturbance B

Tests carried out for RINA approval

- Publication IEC 68-2-6 (1982) Fc. test (Vibration)
- Publication IEC 68-2-30 (1980) Db. test (Hot wet cycle)
- Publication IEC 68-2-1/IEC 68-2-1A (1976) + A1 (1983) Ad-Amendment n°1 test (1983) (Cold)

⚠ Any modification made to the product in its original form as sold by ESA or any installation not envisaged in this manual automatically implies a cancellation of the product's marks of approval. ESA declines all responsibility in relation to its products where these have undergone modification or been installed in ways not envisaged in this manual.

⚠ The simple application of an adhesive on any part of the terminal is considered to be a "variation of the original product" and thus implies the annulment of the marks of approval.

General Safety Precautions

System Design

- The System should be designed to prevent equipment malfunction due to communication faults between the VT and its host controller. This will assure the protection of both personnel and equipment.
- Do not use the VT as a warning device for critical alarms that can cause operator injury, production stoppage or machine damage. Every critical alarm indicator or control, must be designed using appropriate stand alone hardware devices.
- Redundant failsafe system design should be used in order to ensure proper safety when the VT is used in special applications such as safety equipment, non-life support medical devices, disaster prevention devices, transportation vehicles, etc.
- The VT is not suitable for applications such as medical life support equipment, hazardous areas or any potentially explosive environments, aerospace equipment, nuclear power control devices or aircraft control devices. These kinds of applications require a higher level of safety and reliability.

Installation and wiring

- Strictly follow the wiring diagram and grounding recommendations contained in this document, in order to prevent any damage to the VT or to the connected devices.
- Do not use any voltage beyond the VT's specified range in order to prevent damage or electrical shock.
- Make sure power to the unit is off before opening the VT for the calibration procedure described in this document.
- Do not modify the VT for any reason. Doing this may result in electrical shock or fire, in addition to loss of Certifications like CE or UL.
- Use the proper torque shown on the label to tighten the terminal screws. Excess tightening may cause short circuit, fire or device malfunction.
- Do not install the VT in an ambient temperature exceeding the allowed range. This may result in malfunction or shortened life of the unit.
- Do not limit the VT's rear-face ventilation, in order to avoid component overheating.

Usage

- Do not strike the touch panel with a hard or pointed object, or press on the touch screen with excessive force. The actuating force is 50 grams (1.8 oz.).
- Do not allow liquids to enter the VT case. This can cause malfunction or electrical shock.
- Do not use the VT in excessively dirty or dusty environmental conditions, and do not place it under direct sunlight.
- Do not use the VT where strong jolting or excessive vibration can occur.
- Do not use the VT where abrasive chemicals can evaporate or are present in the air.
- Use only allowed chemical substances to clean the VT (see User's Manual chapter on cleaning).
- Ensure that no metal debris falls into the VT. This can cause fire, malfunction or incorrect device operation.
- After turning the VT OFF, please wait at least 5 seconds before turning it ON again, otherwise it may not start up correctly.
- Be sure to perform regular back-ups of the VT's data to avoid loss due to unexpected accidents to your system.

Contents

Foreword	The manual	F-1
	Its purpose	F-1
	Conventions	F-1
Introduction	What is a Video Terminal	I-1
Essential information	Graphic terminals.....	E-1
	Graphic terminals - STN	E-3
	Graphic terminals - TFT	E-3
	Graphic terminals Touch Screen	E-3
General information on electromagnetic compatibility (EMC)	Contents.....	1-1
	Laying cables	1-2
	Shielding of cables	1-2
	Earthing of shielding and electronic circuits	1-2
	Switching of capacitive loads	1-2
	Switching off inductive loads	1-2
	Disturbance suppression circuit - RC and DIODE	1-3
Power Supply	Contents.....	2-1
	Connection pins	2-2
	Wiring.....	2-2
	Connections to be avoided	2-2
	Recommended connection	2-3
Video terminal VT50	Contents.....	3-1
	Technical characteristics.....	3-2
	Functions	3-4
	Front face.....	3-8
	Standard series rear view	3-9
	CAN series rear view	3-10
	Dimensions and Cut-out.....	3-11
	Accessories	3-12
	Termination of CAN line.....	3-12
	Transfer PC -> VT.....	3-12
	Preparation for reception	3-13
	Information relating to driver	3-14
	Adjusting the contrast on the display	3-14
Video terminal VT60	Contents.....	4-1
	Technical characteristics.....	4-2
	Functions	4-4
	Front view	4-8
	Standard series rear view	4-9
	CAN series rear view	4-10
	Dimensions and Cut-out.....	4-11

	Accessories	4-12
	Termination of CAN line	4-12
	Transfer PC -> VT	4-12
	Preparation for reception.....	4-13
	Information relating to driver.....	4-14
	Adjusting the contrast on the display.....	4-15
Video terminal		
VT150W	Contents.....	5-1
	Technical characteristics.....	5-2
	Functions.....	5-4
	Front view.....	5-8
	Customizing label.....	5-10
	Standard series rear view	5-11
	CAN series rear view	5-12
	Dimensions and Cut-out.....	5-13
	Accessories	5-14
	Termination of CAN line	5-14
	Transfer PC -> VT	5-15
	Preparation for reception.....	5-15
	Information relating to driver.....	5-17
	Adjusting the contrast on the display.....	5-18
Video terminal		
VT160W	Contents.....	6-1
	Technical characteristics.....	6-2
	Functions.....	6-4
	Front view.....	6-8
	Customizing label.....	6-10
	Rear view	6-11
	Dimensions and Cut-out.....	6-12
	Accessories	6-13
	Transfer PC -> VT	6-13
	Preparation for reception.....	6-14
	Information relating to driver.....	6-15
	Adjusting the contrast on the display.....	6-16
Video terminal		
VT170W	Contents.....	7-1
	Technical characteristics.....	7-2
	Functions.....	7-4
	Front view.....	7-8
	Customizing label.....	7-10
	Rear view	7-11
	Dimensions and Cut-out.....	7-13
	Accessories	7-14
	Transfer PC -> VT	7-14
	Preparation for reception.....	7-15
	Information relating to driver.....	7-16
	Adjusting the contrast on the display.....	7-17
Video terminal		
VT190W	Contents.....	8-1
	Technical characteristics.....	8-2

	Functions	8-4
	Front view	8-8
	Customizing label	8-10
	Rear view	8-11
	Dimensions and Cut-out.....	8-13
	Accessories	8-14
	Transfer PC -> VT.....	8-14
	Preparation for reception	8-15
	Information relating to driver.....	8-16
	Adjusting the contrast on the display	8-17
Video terminal		
VT300W	Contents.....	9-1
	Technical characteristics.....	9-2
	Functions	9-4
	Front view	9-8
	Customizing label	9-10
	Standard series rear view	9-11
	CAN series rear view	9-12
	Dimensions and Cut-out.....	9-13
	Accessories	9-14
	Termination of CAN line.....	9-14
	Transfer PC -> VT.....	9-15
	Preparation for reception	9-15
	Information relating to driver.....	9-17
	Adjusting the contrast on the display	9-20
Video terminal		
VT310W	Contents.....	10-1
	Technical characteristics.....	10-2
	Functions	10-4
	Front view	10-8
	Customizing label	10-10
	Rear view	10-11
	Dimensions and Cut-out.....	10-13
	Accessories	10-14
	Transfer PC -> VT.....	10-14
	Preparation for reception	10-15
	Information relating to driver.....	10-16
	Adjusting the contrast on the display	10-20
Video terminal		
VT320W	Contents.....	11-1
	Technical characteristics.....	11-2
	Functions	11-4
	Front view	11-8
	Customizing label	11-10
	Rear view	11-11
	Dimensions and Cut-out.....	11-12
	Accessories	11-13
	Transfer PC -> VT.....	11-13
	Preparation for reception	11-14
	Information relating to driver.....	11-16

	Improving display color quality	11-19
	Adjusting the contrast on the display.....	11-20
Video terminal VT155W	Contents.....	12-1
	Technical characteristics.....	12-2
	Functions.....	12-4
	Front view.....	12-8
	Standard series rear view	12-9
	Profibus-DP series rear view.....	12-10
	CAN series rear view	12-11
	Ethernet series rear view	12-12
	Dimensions and Cut-out.....	12-13
	Accessories	12-14
	Methods of mounting.....	12-14
	Calibration of Touch Screen.....	12-15
	Termination of CAN line	12-17
	Introducing the MAC address.....	12-18
	Transfer PC -> VT	12-20
	Preparation for reception.....	12-20
	Information relating to driver	12-22
	Adjusting the contrast on the display.....	12-25
Video terminal VT330W	Contents.....	13-1
	Technical characteristics.....	13-2
	Functions.....	13-4
	Front view.....	13-8
	Customizing label.....	13-10
	Rear view	13-11
	Dimensions and Cut-out.....	13-12
	Accessories	13-13
	Transfer PC -> VT	13-13
	Preparation for reception.....	13-14
	Information relating to driver.....	13-16
	Improving display color quality	13-20
	Adjusting the contrast on the display.....	13-20
Video terminal VT185W	Contents.....	14-1
	Technical characteristics.....	14-2
	Functions.....	14-4
	Front view.....	14-8
	Standard series rear view	14-9
	Ethernet series rear view	14-10
	Dimensions and Cut-out.....	14-11
	Accessories	14-12
	Methods of mounting.....	14-12
	Calibration of Touch Screen.....	14-13
	Introducing the MAC address.....	14-15
	Transfer PC -> VT	14-17
	Preparation for reception.....	14-18
	Information relating to driver	14-19

Video terminal VT505H	Contents	15-1
	Technical characteristics.....	15-2
	Functions	15-5
	Front view	15-9
	Rear view	15-10
	Dimensions and Cut-out.....	15-11
	Accessories	15-12
	Connection cable.....	15-12
	Adjusting holding strap for grip.....	15-12
	Calibration of Touch Screen	15-12
	Transfer PC -> VT.....	15-15
	Preparation for reception	15-15
	Information relating to driver	15-17
	Adjusting the contrast on the display	15-22
Video terminal VT505W	Contents	16-1
	Technical characteristics.....	16-2
	Functions	16-4
	Front view	16-8
	Standard series rear view	16-9
	CAN series rear view	16-10
	Ethernet series rear view	16-11
	Dimensions and Cut-out.....	16-12
	Accessories	16-13
	Calibration of Touch Screen	16-13
	Termination of CAN line.....	16-16
	Introducing the MAC address	16-17
	Transfer PC -> VT.....	16-20
	Preparation for reception	16-20
	Information relating to driver	16-22
	Adjusting the contrast on the display	16-25
Video terminal VT515W	Contents	17-1
	Technical characteristics.....	17-2
	Functions	17-4
	Front view	17-8
	Standard series rear view	17-9
	CAN series rear view	17-10
	Ethernet series rear view	17-11
	Dimensions and Cut-out.....	17-12
	Accessories	17-13
	Calibration of Touch Screen	17-13
	Termination of CAN line.....	17-16
	Introducing the MAC address	17-17
	Transfer PC -> VT.....	17-20
	Preparation for reception	17-20
	Information relating to driver	17-22
	Adjusting the contrast on the display	17-25
Video terminal VT525H	Contents	18-1

	Technical characteristics.....	18-2
	Functions.....	18-5
	Front view.....	18-9
	Rear view	18-10
	Dimensions and Cut-out.....	18-11
	Accessories	18-12
	Connection cable.....	18-12
	Adjusting holding strap for grip.....	18-12
	Calibration of Touch Screen.....	18-12
	Transfer PC -> VT	18-15
	Preparation for reception.....	18-15
	Information relating to driver	18-18
	Improving display color quality	18-23
	Adjusting the contrast on the display.....	18-23
Video terminal	Contents.....	19-1
VT525W	Technical characteristics.....	19-2
	Functions.....	19-4
	Front view.....	19-8
	Standard series rear view	19-9
	Profibus-DP series rear view.....	19-10
	CAN series rear view	19-11
	Ethernet series rear view	19-12
	Dimensions and Cut-out.....	19-13
	Accessories	19-14
	Calibration of Touch Screen.....	19-14
	Termination of CAN line	19-17
	Introducing the MAC address.....	19-18
	Transfer PC -> VT	19-21
	Preparation for reception.....	19-21
	Information relating to driver	19-23
	Improving display color quality	19-27
	Adjusting the contrast on the display.....	19-27
Video terminal	Contents.....	20-1
VT555W	Technical characteristics.....	20-2
	Functions.....	20-4
	Front view.....	20-8
	Standard series rear view	20-9
	CAN series rear view	20-10
	Dimensions and Cut-out.....	20-11
	Accessories	20-12
	Termination of CAN line	20-12
	Transfer PC -> VT	20-13
	Preparation for reception.....	20-13
	Information relating to driver.....	20-16
	Adjusting the contrast on the display.....	20-19
Video terminal	Contents.....	21-1
VT560W	Technical characteristics.....	21-2

	Functions	21-4
	Front view	21-8
	Rear view	21-9
	Dimensions and Cut-out.....	21-10
	Accessories	21-11
	Transfer PC -> VT.....	21-11
	Preparation for reception	21-12
	Information relating to driver	21-13
	Improving display color quality.....	21-18
	Adjusting the contrast on the display	21-18
Video terminal		
VT565W	Contents.....	22-1
	Technical characteristics.....	22-2
	Functions	22-4
	Front view	22-8
	Rear view	22-9
	Dimensions and Cut-out.....	22-10
	Accessories	22-11
	Transfer PC -> VT.....	22-11
	Preparation for reception	22-12
	Information relating to driver	22-15
	Improving display color quality.....	22-19
	Adjusting the contrast on the display	22-19
Video terminal		
VT575W	Contents.....	23-1
	Technical characteristics.....	23-2
	Functions	23-4
	Front view	23-8
	Standard series rear view	23-9
	Profibus-DP series rear view.....	23-10
	CAN series rear view	23-11
	Ethernet series rear view	23-12
	Dimensions and Cut-out.....	23-13
	Accessories	23-14
	Calibration of Touch Screen	23-14
	Termination of CAN line.....	23-17
	Introducing the MAC address	23-18
	Transfer PC -> VT.....	23-21
	Preparation for reception	23-21
	Information relating to driver	23-23
	Improving display color quality.....	23-29
	Adjusting the contrast on the display	23-29
Video terminal		
VT580W	Contents.....	24-1
	Technical characteristics.....	24-2
	Functions	24-4
	Front view	24-8
	Standard series rear view	24-9
	Profibus-DP series rear view.....	24-10
	CAN series rear view	24-11

	Ethernet series rear view	24-12
	Dimensions and Cut-out.....	24-13
	Accessories	24-14
	Calibration of Touch Screen.....	24-14
	Termination of CAN line	24-17
	Introducing the MAC address.....	24-18
	Transfer PC -> VT	24-21
	Preparation for reception.....	24-21
	Information relating to driver.....	24-23
	Improving display color quality	24-29
	Adjusting the contrast on the display.....	24-29
Video terminal		
VT585W	Contents.....	25-1
	Technical characteristics.....	25-2
	Functions.....	25-4
	Front view.....	25-8
	Customizing label.....	25-9
	Standard series rear view	25-10
	CAN series rear view	25-11
	Dimensions and Cut-out.....	25-12
	Accessories	25-13
	Calibration of Touch Screen.....	25-13
	Termination of CAN line	25-18
	Transfer PC -> VT	25-19
	Preparation for reception.....	25-19
	Information relating to driver.....	25-22
	Improving display color quality	25-28
	Adjusting the contrast on the display.....	25-28
Video terminal		
VT585WB	Contents.....	26-1
	Technical characteristics.....	26-2
	Functions.....	26-4
	Front view.....	26-8
	Standard series rear view	26-9
	Profibus-DP series rear view.....	26-10
	CAN series rear view	26-11
	Ethernet series rear view	26-12
	Dimensions and Cut-out.....	26-13
	Accessories	26-14
	Calibration of Touch Screen.....	26-14
	Termination of CAN line	26-17
	Introducing the MAC address.....	26-18
	Transfer PC -> VT	26-21
	Preparation for reception.....	26-21
	Information relating to driver.....	26-23
	Improving display color quality	26-29
	Adjusting the contrast on the display.....	26-29
Video terminal		
VT595W	Contents.....	27-1
	Technical characteristics.....	27-2

	Functions	27-4
	Front view	27-8
	Standard series rear view	27-9
	Profibus-DP series rear view.....	27-10
	CAN series rear view	27-11
	Ethernet series rear view	27-12
	Dimensions and Cut-out.....	27-13
	Accessories	27-14
	Calibration of Touch Screen	27-14
	Termination of CAN line.....	27-17
	Introducing the MAC address	27-18
	Transfer PC -> VT.....	27-21
	Preparation for reception	27-21
	Information relating to driver	27-23
	Improving display color quality.....	27-29
	Adjusting the contrast on the display	27-29
Inserting customized labels	Contents.....	28-1
	Label	28-2
	Warnings.....	28-2
	Notes	28-4
Mounting the terminal within the container	Contents.....	29-1
	Using nuts	29-2
	Using hooks	29-3
	Fixing using external support.....	29-6
	Tightening the fixing screws	29-10
Communication ports	Contents.....	30-1
	General notes	30-2
	Necessary steps	30-2
	MSP serial port	30-3
	ASP serial port	30-4
	ASP-15L serial port.....	30-5
	ASP-9 serial port.....	30-6
	ASP-8 serial port.....	30-6
	LPT parallel port.....	30-7
	Ethernet port	30-8
	Interbus-S port	30-9
	Profibus-DP port	30-10
	CAN port	30-10
	RS485 serial port	30-11
	PC/VT serial port.....	30-11
	PC <-> VT connection.....	30-12
Settings for the Modem	Contents.....	31-1
	AT commands to be sent	31-2
	Sending commands	31-3

Connection cable for H Series terminals	Contents.....	32-1
	Standard series connection cable	32-2
	Standard series connections without VTHCB	32-3
	Standard series connections with VTHCB	32-6
	CAN series connection cable	32-7
	CAN series connections	32-7
	Lay-out of button functions	32-8
Video terminal accessories	Contents.....	33-1
	1/2AA Battery	33-4
	Cell battery	33-4
	Flash module.....	33-5
	Fixing hook for Hand Held.....	33-8
	Interface for connecting Hand Held with MSP/ASP-15L	33-9
	Memory card	33-13
	Memory module.....	33-18
	Integrated Interbus-S module.....	33-19
	Integrated Profibus-DP module	33-21
	RS485 Serial module	33-21
	Profilm4/6/6H/10/12.....	33-22
	Interbus-S and Profibus-DP card	33-27
	Connection card for PC-NET.....	33-34
	Adapter for external CAN network.....	33-37
	20 key serial keyboard	33-42
	Blank keyboard.....	33-46
Network connection	Contents.....	34-1
	Profibus-DP	34-3
	Profibus-DP (ESA profile): VT operation	34-4
	Profibus-DP (ESA profile): Configuration software.....	34-4
	Profibus-DP (ESA profile): Logical diagram	34-5
	Profibus-DP (ESA profile): Physical diagram	34-6
	Profibus-DP (Standard): VT operation	34-6
	Profibus-DP (Standard): Configuration software.....	34-6
	Profibus-DP (Standard): Logical diagram.....	34-7
	Profibus-DP (Standard): Physical diagram.....	34-7
	Profibus-DP: Connection.....	34-8
	Interbus-S.....	34-10
	Interbus-S: VT operation	34-10
	Interbus-S: Configuration software.....	34-10
	Interbus-S: Logical diagram	34-11
	Interbus-S: Physical diagram	34-12
	Interbus-S: Connection.....	34-12
	ESA-Net	34-14
	ESA-Net: VT operation.....	34-14
	ESA-Net: Connecting the terminals.....	34-16
	ESA-Net: Configuration software	34-20
	ETHERNET	34-21
	ETHERNET: VT operation	34-21
	ETHERNET: Configuration software	34-21

**Operation of terminal
with keyboard**

ETHERNET: Connections 34-22
 ETHERNET: Checking the connection 34-23
 CAN 34-24
 CAN: VT functioning in CAN network 34-24
 CAN: Configuration software 34-25
 CAN: Connection 34-25

Contents 35-1
 Changing value of variable field 35-2
 Total change 35-3
 Partial change 35-3
 Examples of varying fields 35-3
 Displaying messages 35-8
 Information messages 35-8
 VT50 info-messages 35-8
 VT60 info-messages 35-9
 VT150W - VT160W info-messages 35-10
 VT170W info-messages 35-10
 VT190W info-messages 35-11
 VT300W - VT310W - VT320W info-messages 35-12
 VT330W info-messages 35-14
 ISA-1A alarms 35-16
 VT170W alarms 35-17
 VT190W alarms 35-19
 VT300W - VT310W - VT320W alarms 35-20
 VT330W alarms 35-23
 ISA-1A alarm history buffer 35-24
 VT170W history buffer 35-25
 VT190W history buffer 35-26
 VT300W - VT310W - VT320W history buffer 35-26
 VT330W history buffer 35-28
 Help messages 35-29

**Operation of terminal
with touch screen**

Contents 36-1
 Changing value of variable field 36-2
 Total change 36-3
 Partial change 36-3
 Examples of varying fields 36-3
 Displaying messages 36-19
 Information messages 36-19
 VT5xxH - VT1x5/505/515/525/555/56xW info-msgs 36-20
 Vertical VT1x5W info-messages 36-21
 VT575W - VT580W- VT585W - VT585WB info-messages . 36-22
 VT595W info-messages 36-24
 ISA-1A alarms 36-24
 VT525H - VT1x5/515/525/555/56xW alarms 36-25
 Vertical VT1x5W alarms 36-27
 VT575W - VT580W - VT585W - VT585WB alarms 36-29
 VT595W alarms 36-30
 ISA-1A alarm history buffer 36-31
 VT525H - VT1x5/515/525/555/56xW history buffer 36-32

	Vertical VT1x5W history buffer.....	36-32
	VT575W - VT580W - VT585W - VT585WB history buffer....	36-33
	VT595W history buffer.....	36-33
	Help messages.....	36-33
	Help and information messages relating to alarms	36-34
	Help messages relating to project pages	36-35
Data exchange area	Contents.....	37-1
	Status area for the terminal.....	37-3
	Status area for internal LEDs	37-8
	Status area for external LEDs	37-12
	Status area for recipes	37-14
	Status area for internal keys.....	37-15
	Status area for external keys.....	37-23
	Status area for internal keys (Real Time).....	37-25
	Status area for external keys (Real Time).....	37-25
	Status area for printer.....	37-26
	Status area for trends.....	37-28
	Command response area.....	37-29
	Command area external LEDs (fixed light)	37-30
	Command area external LEDs (blinking light).....	37-31
	Command area internal red LEDs (fixed light)	37-32
	Command area internal red LEDs (blinking light).....	37-33
	Command area internal green LEDs (fixed light)	37-34
	Command area internal green LEDs (blinking light).....	37-35
	Command area.....	37-36
Communication protocols	Contents.....	38-1
	List of protocols	38-2
Free terminal protocol	Contents.....	39-1
	Free terminal protocol	39-2
	Editing parameters for VT50	39-3
	Editing parameters for VT60	39-4
	Editing parameters for VT150/160W	39-5
	Free terminal control characters.....	39-6
	Key codes for VT50.....	39-9
	Key codes for VT60.....	39-9
	Key codes for VT150/160W	39-10
	Code of External keys for MT1000 and VT160W	39-13
	Free terminal in Network	39-14
	Example of handling.....	39-16
Connection cables	Contents.....	40-1
	General notes.....	40-4
	Connecting the cable shield	40-5
	MSP<->ASP conversion	40-7
	ELECTREX NETWORK ANALYZER.....	40-8
	ABB DRIVE	40-8
	ALLEN-BRADLEY DRIVE.....	40-9

ATLAS COPCO DRIVE.....	40-10
BERGER-LAHR DRIVE	40-11
CONTROL TECHNIQUES DRIVE	40-11
DANFOSS DRIVE.....	40-12
ELAU DRIVE.....	40-13
EUROTHERM DRIVE	40-14
EVER DRIVE	40-15
FANUC ROBOTICS DRIVE	40-15
FAGOR DRIVE	40-16
GALIL DRIVE.....	40-17
GE DRIVE	40-17
HITACHI DRIVE.....	40-17
KEB DRIVE	40-18
INDRAMAT DRIVE	40-19
LENZE DRIVE	40-19
LUST DRIVE.....	40-20
OMRON DRIVE	40-21
OSAI DRIVE	40-21
PANASONIC DRIVE.....	40-21
PARKER AUTOMATION DRIVE	40-22
ROBOX DRIVE	40-23
S.B.C. DRIVE.....	40-24
SEW-EURODRIVE DRIVE	40-25
SIEI DRIVE	40-26
SIEMENS DRIVE	40-26
STÖBER DRIVE	40-27
TDE MACNO DRIVE.....	40-27
TELEMECANIQUE DRIVE	40-28
TRIO MOTION DRIVE	40-28
DATALOGIC BARCODE READER.....	40-29
ABB PLC	40-30
AEG MODICON PLC	40-33
ALLEN-BRADLEY PLC.....	40-34
ALTUS PLC	40-38
ATOS PLC	40-39
BECKHOFF PLC.....	40-40
BOSCH PLC	40-42
B&R AUTOMATION PLC.....	40-42
CROUZET RPX PLC	40-42
FOXBORO PLC	40-43
FUJI PLC	40-43
GE FANUC PLC.....	40-44
GEFRAN PLC	40-45
HITACHI PLC.....	40-46
IDEC IZUMI PLC.....	40-48
KLÖCKNER MOELLER PLC	40-49
KEYENCE PLC	40-50
KOYO PLC.....	40-50
KUHNKE PLC	40-52
LG PLC	40-52
MATSUSHITA-NAIS PLC	40-54

MICROLINK PLC	40-56
MITSUBISHI PLC	40-56
OMRON PLC	40-58
SAIA PLC	40-60
SATT CONTROL PLC	40-64
SCHLEICHER PLC	40-65
SIEMENS PLC	40-66
SPRECHER+SCHUH PLC	40-69
SQUARE-D PLC	40-69
TELEMECANIQUE PLC	40-70
TEXAS INSTRUMENTS PLC	40-74
TOSHIBA PLC	40-76
HBM BALANCE SCALES	40-77
ASCON THERMOREGULATOR	40-78
GEFRAN THERMOREGULATOR	40-78
HENGSTLER THERMOREGULATOR	40-79
WEST THERMOREGULATOR	40-80
Cable information summary	40-81
Resistance to chemical substances	
Contents	41-1
Chemical substances	41-2
Cleaning the VT	41-7
Case for terminals VT, H Series	41-7
Technical support	
Contents	42-1
International Customer Care	42-2
International Product Returns	42-2

Foreword

The hardware installation manual is valid for all types of Video Terminal.

The manual The installation manual contains information on securing and connecting both VTs and optional accessories, on the functions offered by the terminals as well as on the cables connecting them to a device.

Its purpose The manual contains all the notions, concepts and examples necessary to be able to install quickly and easily.

Conventions Below are listed the symbols and styles found in the manual together with their respective meanings:

PLC Programmable logic control or other intelligent device equipped with a serial connection.

Device Intelligent device or PLC equipped with a serial connection.

[] The contents of the bracket appears on the screen.

 Identifies a key or touch button.

 Indicates that the VT specified lacks this key.

 Indicates an important point that requires attention.

 There is a danger that the equipment will be damaged.

Introduction

What is a Video Terminal

A VIDEO TERMINAL (VT) is a device that allows the user to control or simply monitor a productive process. It can send commands using configured by the user; it can send data determining the process on hand and can display information deriving from the productive process. The information can be in the form of an Alarm, an Information (Info-) Message or in binary data format.

The VTs can be divided into two groups: those with a keyboard and those without but equipped with a Touch Screen.

All VTs can be supplemented with accessories to boost and broaden their performance.

VTs are connected to the device by means of a serial connection.

For the VT to function a project must be created and loaded into it. See Software Manual.

For detailed information on individual VTs see the relevant chapters below.

Essential information

The VT is a device composed of a series of components which, given their structure **MUST** be used in a particular way; in addition, these very structural characteristics may cause the VT to behave in ways that could be interpreted as a malfunctioning of product and/or evidence of a constructional defect.



The VT in such cases is NOT to be considered faulty and so neither repair nor substitution are appropriate.

The component that generally creates this impression is the display. The displays used on the VTs are of two distinct types, one with a passive matrix called STN (Super Twist Nematic) and the other with an active matrix called TFT (Thin Film Transistor). Some of their working features are the same, others depend on the different constructional technology.

One component that requires particular care when being used is the Touch Screen.

Below we set out a series of points relating to possible behaviors and the correct use of the VT.



Failure to put some of these notions into practice may damage the VT.

Graphic terminals

The category graphic terminals covers both touch screen and keyboard terminals and includes both those with STN display and those with TFT display.

- With CCFL backlit displays the brightness may be slightly uneven, the areas where the CCFL lamps are may be lighter.

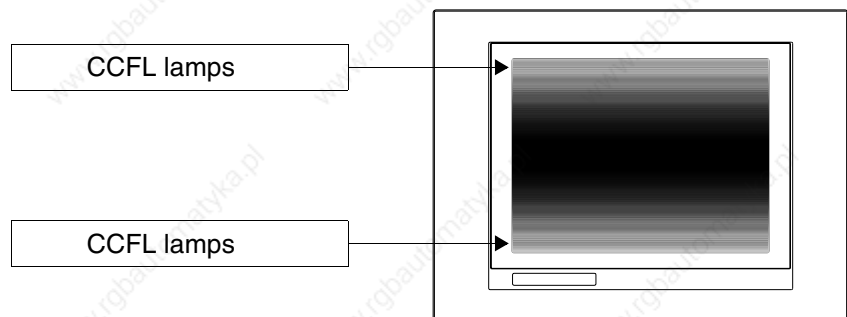

- All displays possess a certain viewing angle within which the images can be seen properly. If the viewer is outside the specified angle the images may be seen with their colors inverted or with different tones from the original ones, or it may be that no colors are seen, etc. The viewing angle can be slightly adjusted by regulating the contrast on the display.

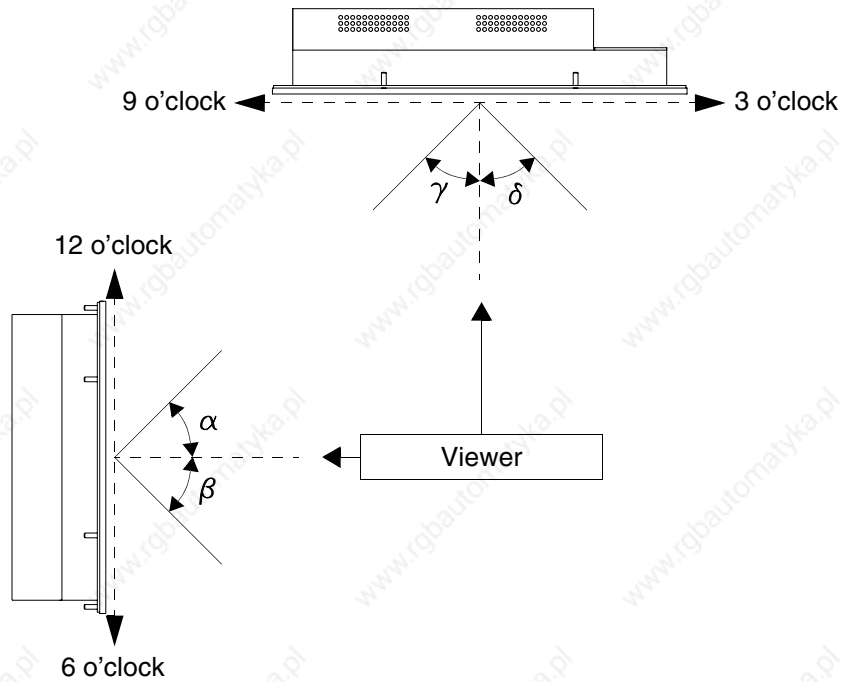

The figure above shows the direction of the angles in relation to the viewing point. The table gives the value of the viewing angles depending on the type of display.

Type of display	Direction (Hour)			
	12 - α	6 - β	9 - γ	3 - δ
STN	30 degrees	60 degrees	60 degrees	60 degrees
TFT	80 degrees	80 degrees	70 degrees	70 degrees

This feature means a difference in viewing (albeit with the same contrast and temperature levels) when:

- The viewer is taller than the person setting the contrast.
- Viewers find themselves at different distances from the VT.
- Two identical displays may have slightly different brightness levels and color tones.

Graphic terminals - STN

- Temperature influences the contrast of the display. At higher temperatures the display is lighter while at lower temperatures it is darker, consequently a few minutes are required after switching on before the display offers normal viewing. This effect may be more or less marked depending on the ambient temperature. For terminals with temperature probes the contrast is automatically regulated so the effect is almost imperceptible .
- It is possible for images having a strong chromatic contrast with the background to create color streaks. This effect can be slightly corrected using the display's contrast control.

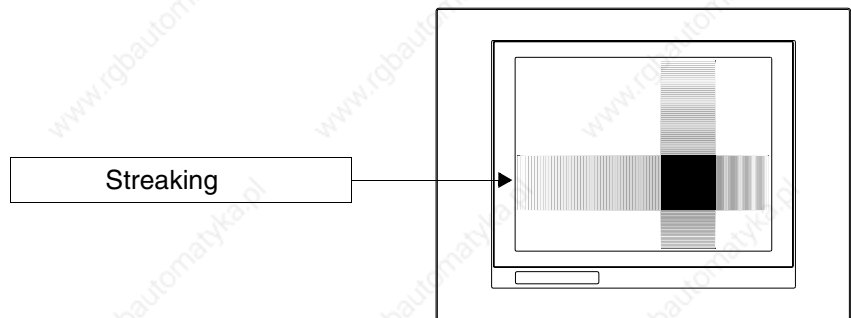

- Brightness may present a slight tremble or irregularity leading to a slight darkening which extends over the entire display.

Graphic terminals - TFT

- In some cases the display may have some pixels that are white (always ON) or black (always OFF). This phenomenon may be visible or invisible to the user on account of the color showing on the display. This phenomenon is considered normal.

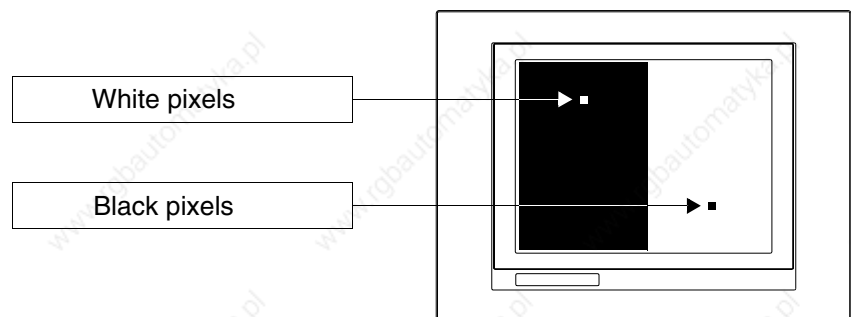

Graphic terminals Touch Screen

- The touch screen is activated by applying pressure equal to 200g – which may be done using a pen or a finger.
- The touch screen also has a peripheral area that should never be subjected to stress above all using pointed objects (pens, etc.). On account

of how the glass is put together this area is very sensitive to pressure and is fragile.

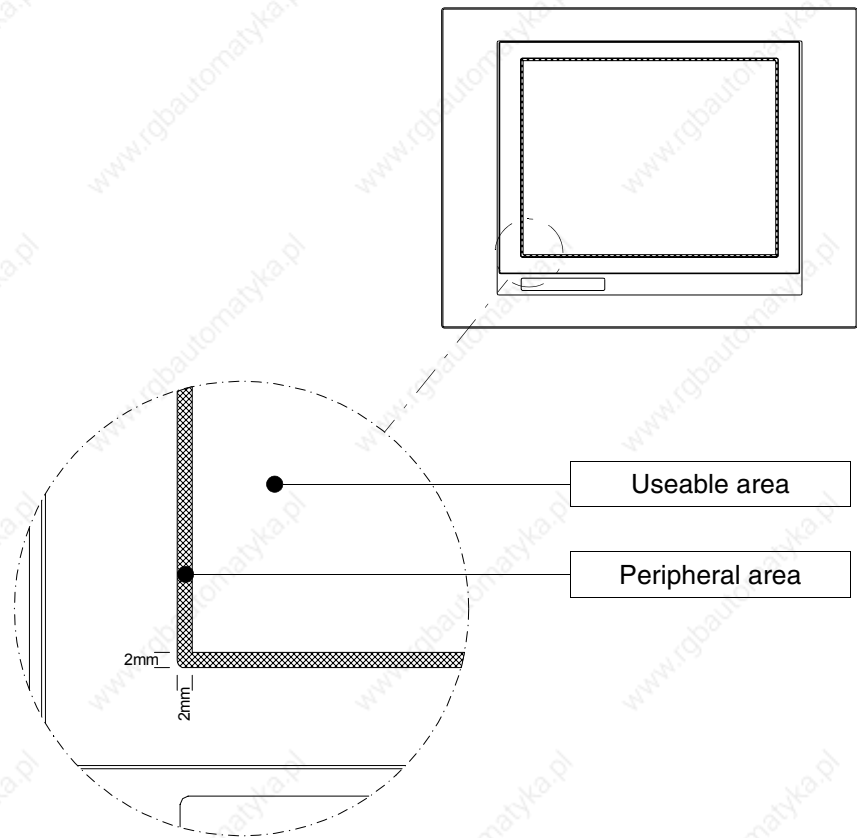

The peripheral area is about 2mm on each side and is outside the touch sensitive area.



Subject this area to stress may damage the VT.

Chapter 1

General information on electromagnetic compatibility (EMC)

Contents	Page
Laying cables	1-2
Shielding of cables	1-2
Earthing of shielding and electronic circuits	1-2
Switching of capacitive loads	1-2
Switching off inductive loads	1-2
Disturbance suppression circuit - RC and DIODE	1-3

This chapter consists of 4 pages.

Electronic devices are being increasingly used in automated systems. programmable controllers (like the PLC) belong to this category, as do Man-machine-interface systems (e.g. the Video Terminal), control systems (e.g. diagnostic terminals), interface elements (e.g. interface boards) and AC-DC drives. Together with this type of electronic apparatus, you find installed classical electro-mechanical devices like contactors, electro-valves, motors etc.

Electrical disturbances caused by the operation of these devices can compromise the smooth functioning and the length of the working life of the electronic devices present on the same switchboard or the same plant. To get the best out of both the electrical and the electronic devices it is necessary to reduce electrical disturbance.

Laying cables

Remember to lay measurement, monitoring and communication cables so that they are kept apart from power cables. Power cables laid close and parallel to communication cables can cause coupling voltages that are strong enough to disturb or destroy electronic components.

Shielding of cables

It is essential to use suitably shielded cables for communication signal connections (total shielding is recommended). The shielding must be connected to the zero potential.

Earthing of shielding and electronic circuits

With many devices the "0V" is connected to the earth. The signal ground must be earthed but it is best to separate the ground of the shields and circuits from that of the power circuits. Note that the earth can only perform its function if the "Resistance of the earth circuit" is within the max. limits prescribed.

Switching of capacitive loads

The current peaks which occur when capacitive loads are switched on can damage or destroy control devices. Furthermore, the high-frequency component of the current peak can cause serious disturbance in electronic circuits as a result of inductive coupling between the connection cables.

Switching off inductive loads

When an inductive load is switched off, the magnetic energy stored tends to oppose this, discharging a voltage peak down the line which can damage or destroy the control device. Furthermore, the high-frequency component of the voltage peak can cause disturbance caused by capacitive coupling between the connection cables.

The physical structure and characteristics of an inductive load make it impossible to carry out switching without disturbance unless suitable measures are taken. The disturbance can be at least partially suppressed by fitting a suitable disturbance-suppression module in parallel with the inductive load. The disturbance-suppression module must not constitute an additional load during the work phase. Electrical disturbance is propagated both through the connection cables and electromagnetic transmission. If the disturbance is propagated by cable or electromagnetic transmission, it is much more difficult to suppress at the inputs to the units in the danger zone than it is to suppress the disturbance at its source. If the disturbance is cre-

ated by connection cables or by electronic transmission, it is much more difficult to suppress it at the inputs of the devices in dangerous areas than at source,

⚠ If possible, disturbance should be suppressed at source.

Disturbance suppression circuit - RC and DIODE

In the following tables there are the specifications of the disturbance suppression filter circuits.

Table 1.1: Disturbance suppression circuit RC

Circuit	Advantages	Disadvantages
	The residual component has a very low harmonic wave form component.	The best results are obtained by sizing the R/C suitably.
	The residual overvoltage can be limited to the very low values by optimizing the sizing.	Volume directly proportional to the inductance and power of the load.
	Switch-off time delay very low.	Optimal suppression is obtained as a direct consequence of a significant de-energizing delay.
	The effectiveness of the disturbance suppression is not affected by the voltage value. No switch-on delay.	The presence of the capacitor causes a high load current peak when switching on (and can cause pinging of the contact if undersized).
	Suitable for both AC and DC; no problem with reversed polarity.	The RC circuit constitutes an additional load when used with AC.
	No arc (low energy) on switching contact.	--

Table 1.2: Disturbance suppression circuit DIODE

Circuit	Advantages	Disadvantages
	Very compact.	High switch-off delay time.
	No residual voltage (total damping of disturbance impulse).	For direct current (DC) applications only.
	Easy to size.	Polarity must be respected.
	--	Switch-off delay can lead to the formation of a strong electric arc.
	--	Sensitive to disturbance voltage pulses in power supply circuit.

Chapter 2 Power Supply

Contents	Page
Connection pins	2-2
Wiring	2-2
Connections to be avoided	2-2
Recommended connection	2-3

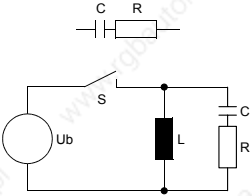
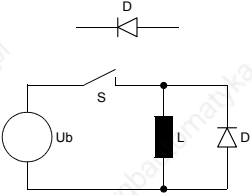
This chapter consists of 4 pages.

Use a 24VDC (18..32Vdc) power supply unit to power the VT.

Connection pins

Table 2.1: 4 pin Power Supply Connector

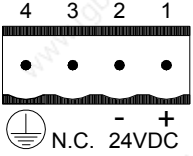
Connector	Pin	Meaning
	1	Input power +24Vdc
	2	Input power 0Vdc
	3	Not connected
	4	Earth protection



Check all connections before switching on.

Wiring

The power supply connector will take conductors with a cross-section of between 0.05 and 2.5mm² (30-12AWG) for rigid conductors or from 0.05 to 1.5mm² (30-12AWG) in the case of flexible conductors. The length of the stripped wire must be between 6 and 7.5mm (0.24-0.30in). The recommended screw grip pressure is 0.79Nm (7 lb in).



These values represent the maximum values certificated. The screw grip pressure is related to the norms applicable to the product and to the type of use.

Connections to be avoided

The connections illustrated below **must not** be made as they may cause the VT to be damaged.

Table 2.2: Connections to be avoided

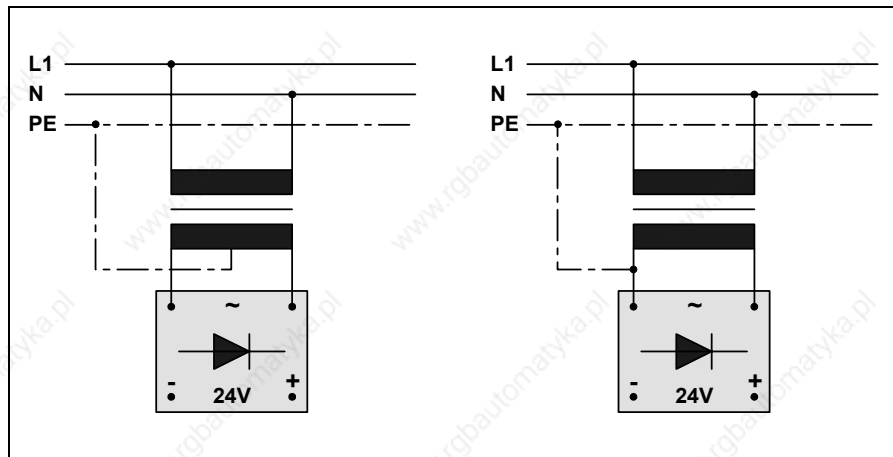

The above configurations will seriously damage certain components of the VT.

⚠ Beware of appliances with the POSITIVE connected to PE.

⚠ It is vital that the earth of the devices connected to the serial and/or parallel communication ports have the same voltage as the 0V supply of the VT. The circulation of current between the 0V supply and the earth of the communication ports could damage certain components of the VT or of the devices connected it.

Recommended connection

We recommend a wiring scheme as set out below in the interests of avoiding damaging the VT.

Table 2.3: Power supply with 0Vdc connected to PE

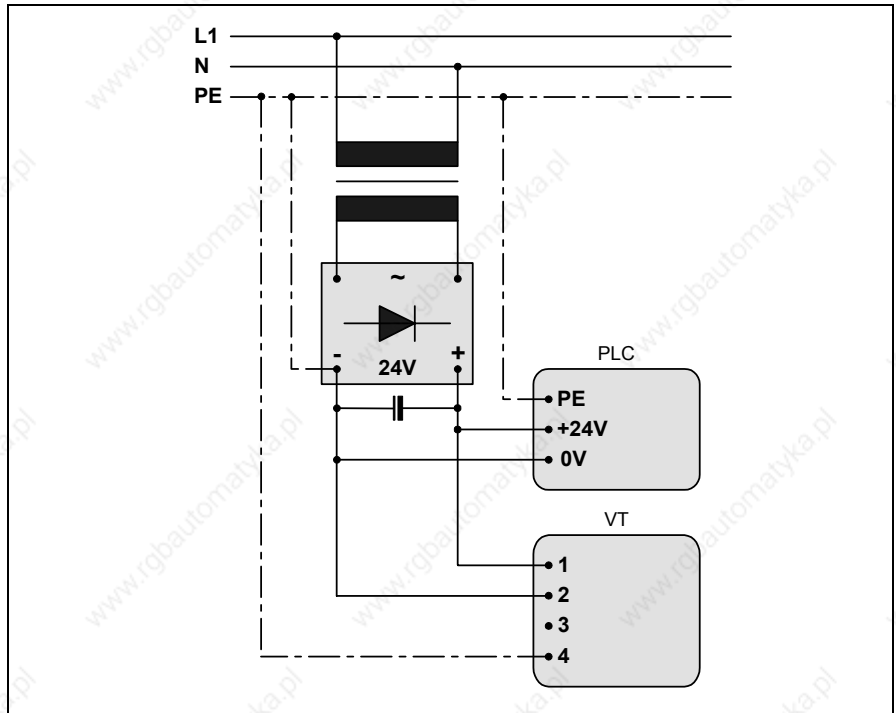

⚠ Correct earthing is essential.

Chapter 3

Video terminal VT50

Contents	Page
Technical characteristics	3-4
Functions	3-8
Front face	3-8
Standard series rear view	3-9
CAN series rear view	3-10
Dimensions and Cut-out	3-11
Accessories	3-12
Termination of CAN line	3-12
Transfer PC -> VT	3-12
Preparation for reception	3-13
Information relating to driver	3-14
Adjusting the contrast on the display	3-14

This chapter consists of 14 pages.

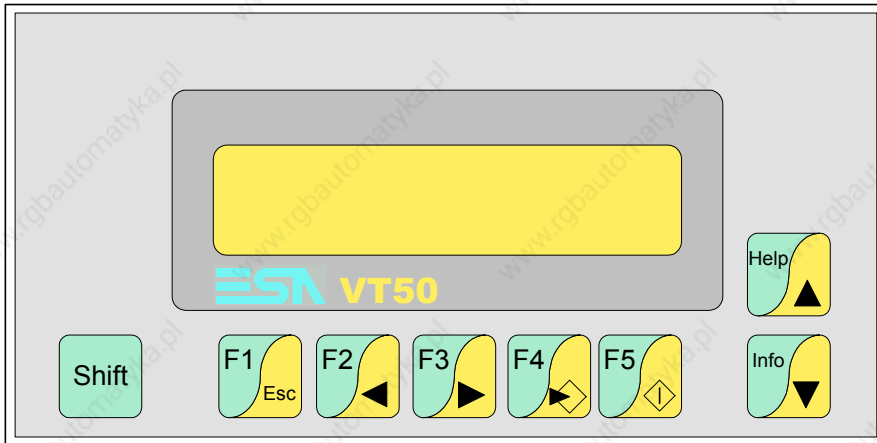

Technical characteristics The following table lists the principal technical characteristics of the product in question.

Code of terminal	Characteristics of the terminal	
VT050 00000		
VT050 000CN		
Display		▼ ▼
Type	LCD	● ●
Representational format	Text	● ●
Rows by characters	2 x 20	● ●
Display area size [mm]	73,5 x 11,5	● ●
Character matrix in text mode [pixels]	5 x 7	● ●
Character size [mm]	3,2 x 5,5	● ●
Contrast adjustment	Trimmer Automatic compensation with temperature	● ●
Character sets	Ascii, Katakana	● ●
Backlighting		
Type	LED CCFL lamp	● ●
Minimum lamp-life at 25°C [hours]	--	
Keyboard		
Non-customizable function keys	5	● ●
Customizable function keys	--	
Function key LEDs	--	
Alphanumeric keys	--	
Operational keys	8	● ●
Operational key LEDs	--	
Diagnostic LEDs	--	
User memory		
Project [Bytes]	256K	● ●
Data memory [Bytes]	--	
Memory for Windows® -based fonts [Byte]	--	
Memory Card for backup	--	
Memory Card for expansion	--	

Code of terminal	Characteristics of the terminal	
VT050 00000		
VT050 000CN		
Interfaces		
MSP (Multi-serial port)	RS232/RS422/RS485/TTY-20mA	●
ASP (Auxiliary serial port)	RS232/RS485	
ASP-15L (Auxiliary serial port)	RS232/RS485	
ASP-8 (Auxiliary serial port)	RS232	●
ASP-9 (Auxiliary serial port)	RS232	
LPT parallel port	Centronics	
Auxiliary port	Connection for accessory devices	
Accessories		
Connectable accessories	See table "Chapter 33"	●
Clock		
Clock		
Networks		
Integrated	Profibus-DP	
	CAN Open (Optoisolated interface)	●
	Ethernet 10/100Mbit RJ45	
Universal Bus Connector	--	
Optional	See table "Chapter 33"	●
Proprietary networks		
ESA-Net	Network server	
	Network client	●
Technical data		
Power supply	24Vdc (18..32Vdc)	
Power absorbed at 24Vdc	5W	
Protection fuse	Ø5x20mm - 315mA Quick Blow F	
Protection level	IP65 (front-end)	
Operating temperature	0..50°C	
Storage and transportation temperature	-20..+60°C	
Humidity (non-condensing)	<85%	
Weight	500gr	
Dimensions		
External W x H x D [mm]	166 x 86 x 41	
Cut-out W x H [mm]	157 x 77	
Certification		
Certifications and approvals	CE, RINA, DNV, cULus, NEMA12	

Functions

The following table lists in alphabetical order all the functions of the VT in question.

Table 3.1: Functions and objects realizable with this VT (Part 1 of 4)

Code of terminal		
VT050 *****	Objects/Functions	Quantity ▼
Alarm field		
Alarm help		
Alarm history buffer		
Alarm statistics		
Alarms (Total/active simultaneously)		
Arc		
Automatic operations	20	●
Backup/Restore		●
Bar data		
Bit-wise password	8bits	●
Buttons		
Circles		
Command: Change language		●
Command: Clear trend buffer		
Command: Delete recipe		
Command: Hardcopy		
Command: Load recipe from data memory		
Command: Modify password		
Command: Next page		
Command: Page help		
Command: Password login		
Command: Password logout		
Command: Previous page		
Command: Print alarm history		
Command: Printer form feed		
Command: Quit project		●
Command: Report		
Command: Restarts reading time-sampled trend		
Command: Run pipeline		
Command: Save alarms history and trend buffers in flash		
Command: Save recipe in data memory		
Command: Save recipe received from device in buffer		
Command: Save recipe received from device in data memory		
Command: Send recipe from video buffer to device		
Command: Send recipe to device		
Command: Service page		

Unless otherwise stated, there is no limit to the number of includable elements, only the size of project memory sets a limit.
*) indicative value determined by the dimensions of the project

Table 3.1: Functions and objects realizable with this VT (Part 2 of 4)

Code of terminal		
VT050 *****		
Objects/Functions	Quantity	▼
Command: Show alarms history		
Command: Show page directory		
Command: Show project information		●
Command: Show recipe directory		
Command: Show sequence directory		●
Command: Shows driver status page		
Command: Shows page help		
Command: Shows page with function: PG		
Command: Stops reading time sampled trend		
Command: Trend reading saved in device		
Command: Zero number of general pages		
Date field		
Day-of-the-week field		
Dynamic texts: Bit-group-structured dynamic texts		●
Dynamic texts: Single-bit dynamic texts	1024*	●
Dynamic texts: Value-structured dynamic texts		●
E-keys		
Equations	32	●
F-keys		●
Free terminal		●
Function: Disables key		●
Function: Go to page		
Function: Internal command		●
Function: Invert bit value		●
Function: Macro		
Function: None		●
Function: Reset bit permanently		
Function: Reset real-time bit		
Function: Sequences		●
Function: Sets bit permanently		
Function: Sets real-time bit		●
Function: Value-structure direct command		●
Global configuration of E-keys		
Global configuration of F-keys		●
Headers and footers (Total/Number of fields per H-F)		
Info-messages (Total/active simultaneously)	128/128	●
Internal registers	512bytes	●
Labels		●
LEDs assigned to sequence		

Unless otherwise stated, there is no limit to the number of includable elements, only the size of project memory sets a limit.
*) indicative value determined by the dimensions of the project

Table 3.1: Functions and objects realizable with this VT (Part 3 of 4)

Code of terminal		
VT050 *****	Objects/Functions	Quantity
Lines		
Lists of bitmap images		
Lists of texts		●
Local configuration of E-keys		
Local configuration of F-keys		●
Macro field	4 x pages	
Macros (Total/Commands x macro)		
Message field		
Message help	128	●
Multilanguage texts	4 Langs.	●
Object - Indicator		
Object - Potentiometer knob		
Object - Selector knob		
Object - Sliding potentiometer		
Object - Sliding selector		
Page	127	●
Page help	127	●
Password		
Pipelines (Number/Tot bytes)		
Print		
Print page (Total/Number of fields per page)		
Programmable fonts		
Project images		
Public variables of ESANET network (Number/Total bytes)		
Recipe field for recipe structure		
Recipes (Number of variables per recipe)		
Rectangles		
Redefinable characters	7	●
Reports		
Sequences - Random	64	●
Sequences - Start/stop		●
Static bitmaps		
Symbolic field: Bit-group-structured dynamic bitmaps		
Symbolic field: Single-bit-structured dynamic bitmaps		
Symbolic field: Value-structured dynamic bitmaps		
System messages		
System variables assigned to recipe structure		
Time long field		
Time short field		

Unless otherwise stated, there is no limit to the number of includable elements, only the size of project memory sets a limit.
*) indicative value determined by the dimensions of the project

Table 3.1: Functions and objects realizable with this VT (Part 4 of 4)

Code of terminal		
VT050 *****	Objects/Functions	Quantity ▼
Timer		20 ●
Touch Area		
Trend buffers		
Trends (Trends x page/Channels x trend)		
Trends sampled automatically (Memory/Trends/Readings)		
Trends sampled on command (Memory/Trends/Readings)		
Value direct command: ADD		
Value direct command: AND		
Value direct command: OR		
Value direct command: SET		●
Value direct command: SUBTRACT		
Value direct command: XOR		
Variables: Limit values and linear scaling variables	12 x pages	
Variables: Movement variable (Mobile symbolic field)		
Variables: Threshold variables		
Variables: Floating Point numerical variables		●
Variables: Numerical variables (DEC, HEX, BIN, BCD)		●
Variables: String variables (ASCII)		●

Unless otherwise stated, there is no limit to the number of includable elements, only the size of project memory sets a limit.
 *) indicative value determined by the dimensions of the project

Front face

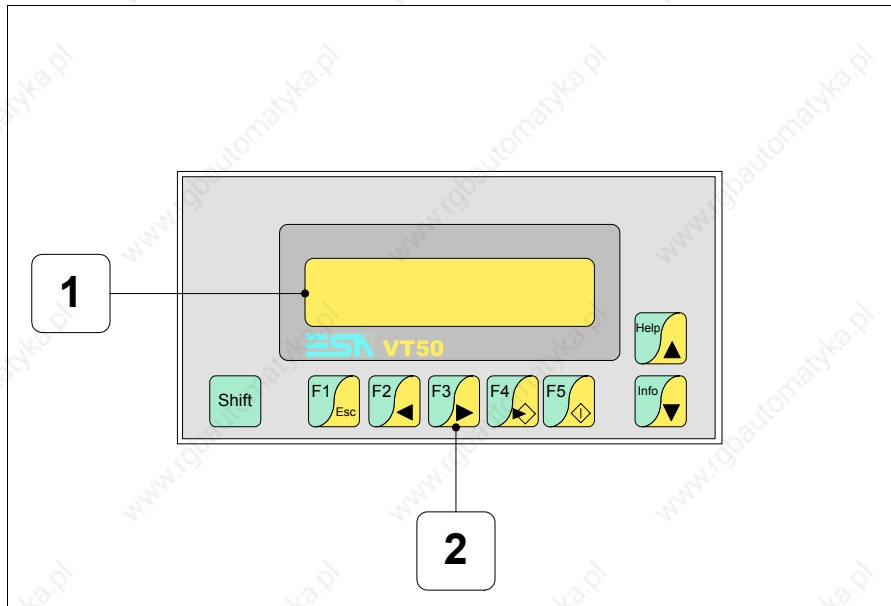

Key	Function
1	Display
Shift + 2	F-keys
	Confirms setting
	Next page
	Previous page
	Start in-putting
	Moving cursor between fields
	Moving cursor between fields
	Quits: setting of data, info-messages, directory of sequences, communication driver
Shift + 	Displays information messages
Shift + 	Displays according to context: info-message help or page help

Standard series rear view

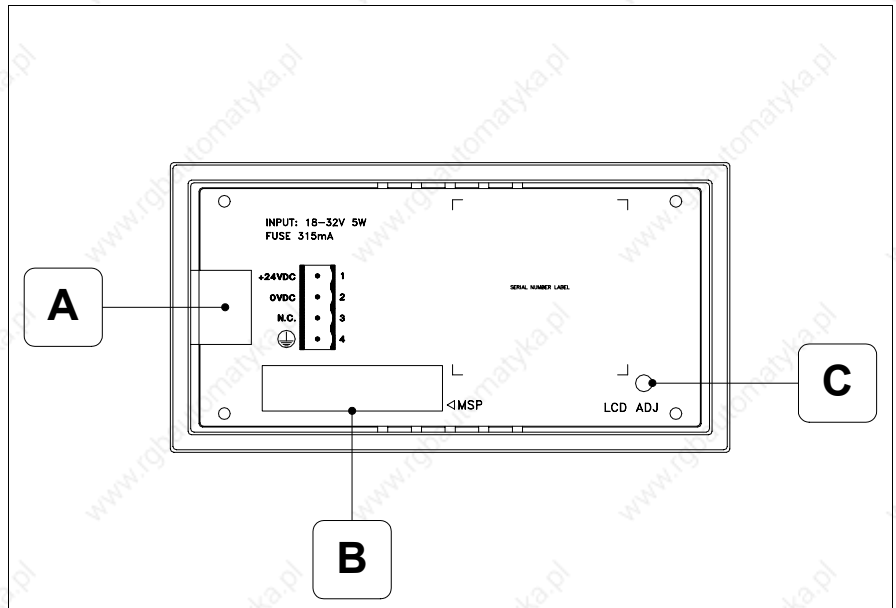

Position	Function
A	Power supply connector
B	MSP serial port
C	Trimmer for adjusting display contrast

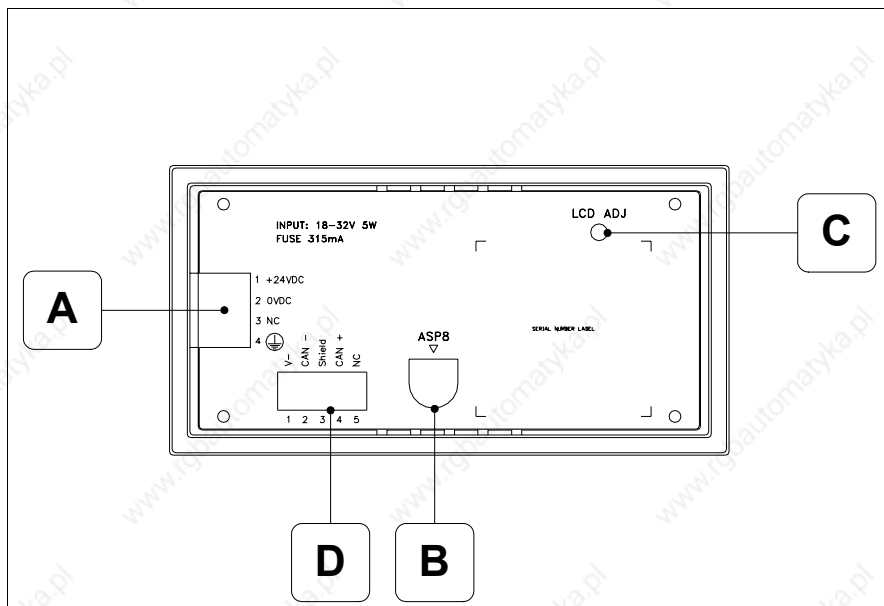
**CAN series
rear view**

Position	Function
A	Power supply connector
B	ASP-8 serial port
C	Trimmer for adjusting display contrast
D	CAN serial port

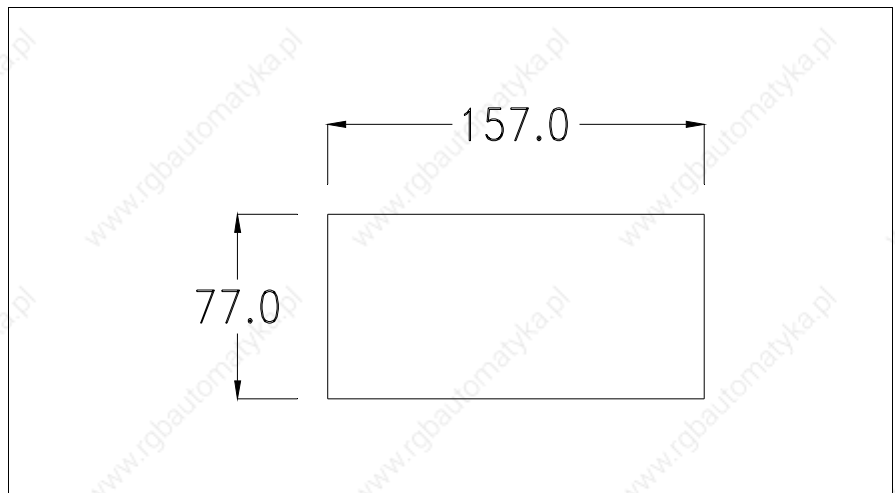
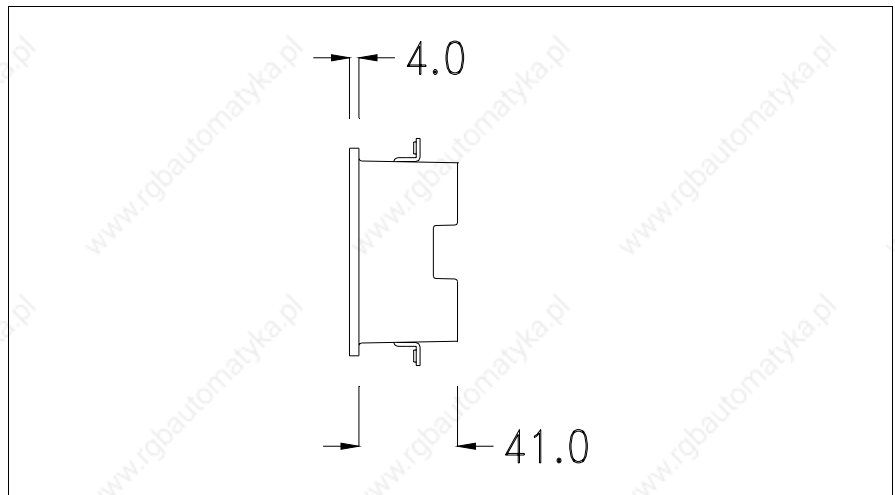
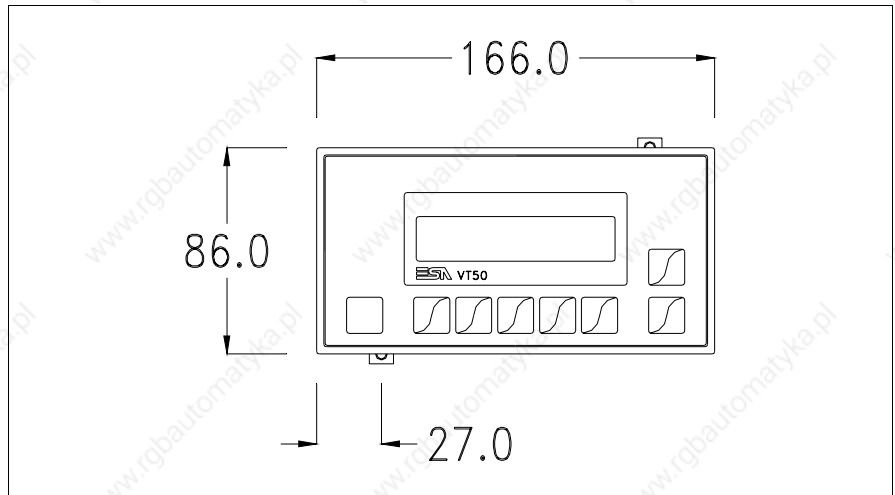
**Dimensions
and Cut-out**

To fix the sealing gasket and secure the VT to the container see “Chapter 29 -> Mounting the terminal within the container“.

! Where accessories need to be fixed in or onto the VT terminal, you are advised to do this before securing the VT to its container.

Accessories

Any accessories should be mounted in accordance with the instructions in the relevant chapter (see “Chapter 33 -> Video terminal accessories“).

Termination of CAN line

This paragraph applies only to the CAN series. The VT in question integrates the termination resistances of the serial line (typically 120 ohms) which can be inserted by means of a jumper (preset on 1-2, line not terminated). To activate the termination:

- Make sure the device is not connected to the power supply.
- Remove the cover.
- Identify the jumper unit J2.

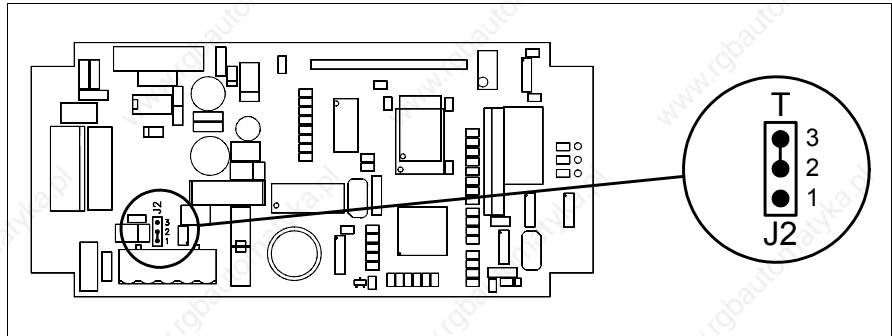

- Position the jumper between pins 2 and 3 (line terminated).
- Replace the back cover.
- Reconnect the power supply.

Transfer PC -> VT

For everything to function properly, the first time the VT operator terminal is switched on it needs to be correctly loaded, that is it needs to have transferred to it:

- Firmware
- Communication driver
- Project

(Given that the transfer of the three files in practice occurs with a single operation, it will be defined as “Project transfer” for the sake of simplicity)

or:

- Free terminal protocol

For this it is essential that the VT be prepared to receive the transfer. (See also “Chapter 37 -> Command area”).

Preparation for reception

The program VTWIN (see Software Manual) must be used for the transfer, but the terminal must be set up to receive. This means carrying out the following steps:

- Check that the VT is off
- Check that there is a serial connection between the PC and the VT
- Switch on the VT with  held down and wait a moment

VT terminal with no Modem function:

- The following mask appears. The VT is now ready to receive (refer to Software Manual for transfer procedure)

VT50 Service page

VT terminal with Modem function:

- The following mask appears

F1=MODEM - F2= PC

- Choose the required transfer mode: MODEM if you intend to use a modem or PC if you intend to use a serial port; press the corresponding function

If the choose made is PC, the VT is ready to receive (see Software Manual for transfer), if, on the other hand, you choose MODEM, the following mask will appear

F1=FAST - F2=SLOW

The choice should be according to the speed you intend to use for the transfer (Slow=9600bit/sec or Fast=38400bit/sec), press the corresponding function . The VT is now ready to receive (see Software Manual for the transfer).

Information relating to driver

After the project has been transferred, the VT can make available information relating to what has been loaded. The information regards:

- The name of the driver loaded
- The version of the driver loaded
- Network address of the VT
- Last error to have occurred

To acquire this information carry out the following operations:

- Be situated in any page of the project
- Press  twice; you will see

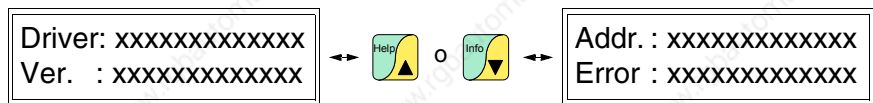

The possible error messages are:

• PROT ERROR

Problem-> Errors have been detected in the data exchange between the VT and the Device.

Solution-> Check the cable; there may be disturbance.

• COM BROK

Problem-> Communication between VT and Device interrupted.

Solution-> Check the serial connection cable.

An error message followed by [*] indicates that the error is not currently present but was and has since disappeared.

Example: COM BROK*

Adjusting the contrast on the display

To improve the quality of the representation on the display it may be necessary to adjust its contrast. This can be done by rotating the trimmer (C) at the back of the VT (see Page 3-9 or Page 3-10); turn it (using a small screwdriver or a trimmer tool) in one direction and, if the display quality worsens, turn it the other way.

Chapter 4

Video terminal VT60

Contents	Page
Technical characteristics	4-4
Functions	4-4
Front view	4-8
Standard series rear view	4-9
CAN series rear view	4-10
Dimensions and Cut-out	4-11
Accessories	4-12
Termination of CAN line	4-12
Transfer PC -> VT	4-12
Preparation for reception	4-13
Information relating to driver	4-14
Adjusting the contrast on the display	4-15

This chapter consists of 16 pages.

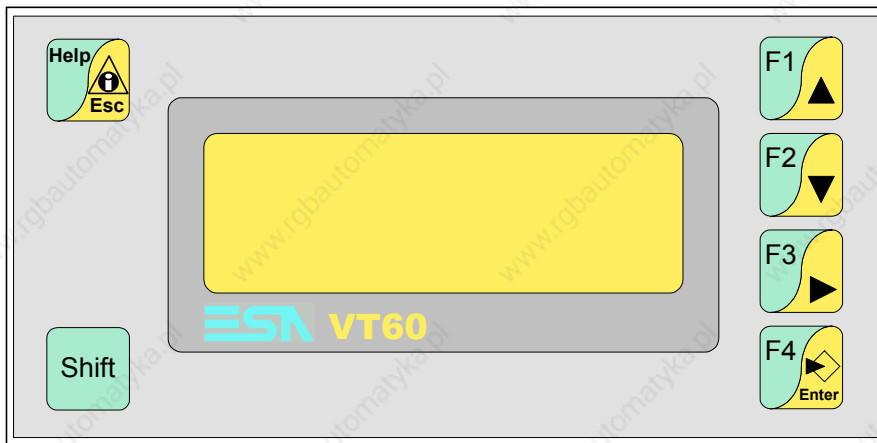

Technical characteristics The following table lists the principal technical characteristics of the product in question.

Code of terminal		Characteristics of the terminal	
VT060 00000			
VT060 000CN			
Display			
Type	LCD	●	●
Representational format	Text	●	●
Rows by characters	4 x 20	●	●
Display area size [mm]	70,4 x 20,8	●	●
Character matrix in text mode [pixels]	5 x 7	●	●
Character size [mm]	2,95 x 4,75	●	●
Contrast adjustment	Trimmer	●	●
	Automatic compensation with temperature		
Character sets	Ascii, Katakana	●	●
Backlighting			
Type	LED	●	●
	CCFL lamp		
Minimum lamp-life at 25°C [hours]	--		
Keyboard			
Non-customizable function keys	4	●	●
Customizable function keys	--		
Function key LEDs	--		
Alphanumeric keys	--		
Operational keys	6	●	●
Operational key LEDs	--		
Diagnostic LEDs	--		
User memory			
Project [Bytes]	256K	●	●
Data memory [Bytes]	--		
Memory for Windows® -based fonts [Byte]	--		
Memory Card for backup	--		
Memory Card for expansion	--		

Code of terminal	Characteristics of the terminal	
VT060 00000		
VT060 000CN		
Interfaces		
MSP (Multi-serial port)	RS232/RS422/RS485/TTY-20mA	●
ASP (Auxiliary serial port)	RS232/RS485	
ASP-15L (Auxiliary serial port)	RS232/RS485	
ASP-8 (Auxiliary serial port)	RS232	●
ASP-9 (Auxiliary serial port)	RS232	
LPT parallel port	Centronics	
Auxiliary port	Connection for accessory devices	
Accessories		
Connectable accessories	See table "Chapter 33"	●
Clock		
Clock		
Networks		
Integrated	Profibus-DP	
	CAN Open (Optoisolated interface)	●
	Ethernet 10/100Mbit RJ45	
Universal Bus Connector	--	
Optional	See table "Chapter 33"	●
Proprietary networks		
ESA-Net	Network server	
	Network client	●
Technical data		
Power supply	24Vdc (18..32Vdc)	
Power absorbed at 24Vdc	5W	
Protection fuse	Ø5x20mm - 315mA Quick Blow F	
Protection level	IP65 (front-end)	
Operating temperature	0..50°C	
Storage and transportation temperature	-20..+60°C	
Humidity (non-condensing)	<85%	
Weight	500gr	
Dimensions		
External W x H x D [mm]	166 x 86 x 41	
Cut-out W x H [mm]	157 x 77	
Certification		
Certifications and approvals	CE, RINA, DNV, cULus, NEMA12	

Functions

The following table lists in alphabetical order all the functions of the VT in question.

Table 4.1: Functions and objects realizable with this VT (Part 1 of 4)

Code of terminal		
VT060 *****		
Objects/Functions	Quantity	▼
Alarm field		
Alarm help		
Alarm history buffer		
Alarm statistics		
Alarms (Total/active simultaneously)		
Arc		
Automatic operations	20	●
Backup/Restore		●
Bar data		
Bit-wise password	8bits	●
Buttons		
Circles		
Command: Change language		●
Command: Clear trend buffer		
Command: Delete recipe		
Command: Hardcopy		
Command: Load recipe from data memory		
Command: Modify password		
Command: Next page		
Command: Page help		
Command: Password login		
Command: Password logout		
Command: Previous page		
Command: Print alarm history		
Command: Printer form feed		
Command: Quit project		●
Command: Report		
Command: Restarts reading time-sampled trend		
Command: Run pipeline		
Command: Save alarms history and trend buffers in flash		
Command: Save recipe in data memory		
Command: Save recipe received from device in buffer		
Command: Save recipe received from device in data memory		
Command: Send recipe from video buffer to device		
Command: Send recipe to device		
Command: Service page		

Unless otherwise stated, there is no limit to the number of includable elements, only the size of project memory sets a limit.
*) indicative value determined by the dimensions of the project

Table 4.1: Functions and objects realizable with this VT (Part 2 of 4)

Code of terminal		
VT060 *****		
Objects/Functions	Quantity	▼
Command: Show alarms history		
Command: Show page directory		
Command: Show project information		●
Command: Show recipe directory		
Command: Show sequence directory		●
Command: Shows driver status page		
Command: Shows page help		
Command: Shows page with function: PG		
Command: Stops reading time sampled trend		
Command: Trend reading saved in device		
Command: Zero number of general pages		
Date field		
Day-of-the-week field		
Dynamic texts: Bit-group-structured dynamic texts		●
Dynamic texts: Single-bit dynamic texts	1024*	●
Dynamic texts: Value-structured dynamic texts		●
E-keys		
Equations	32	●
F-keys		●
Free terminal		●
Function: Disables key		●
Function: Go to page		
Function: Internal command		●
Function: Invert bit value		●
Function: Macro		
Function: None		●
Function: Reset bit permanently		
Function: Reset real-time bit		
Function: Sequences		●
Function: Sets bit permanently		
Function: Sets real-time bit		●
Function: Value-structure direct command		●
Global configuration of E-keys		
Global configuration of F-keys		●
Headers and footers (Total/Number of fields per H-F)		
Info-messages (Total/active simultaneously)	128/128	●
Internal registers	512bytes	●
Labels		●
LEDs assigned to sequence		

Unless otherwise stated, there is no limit to the number of includable elements, only the size of project memory sets a limit.
*) indicative value determined by the dimensions of the project

Table 4.1: Functions and objects realizable with this VT (Part 3 of 4)

Code of terminal		
VT060 *****	Objects/Functions	Quantity
Lines		
Lists of bitmap images		
Lists of texts		●
Local configuration of E-keys		
Local configuration of F-keys		●
Macro field	4 x pages	
Macros (Total/Commands x macro)		
Message field		
Message help	128	●
Multilanguage texts	4 Langs.	●
Object - Indicator		
Object - Potentiometer knob		
Object - Selector knob		
Object - Sliding potentiometer		
Object - Sliding selector		
Page	127	●
Page help	127	●
Password		
Pipelines (Number/Tot bytes)		
Print		
Print page (Total/Number of fields per page)		
Programmable fonts		
Project images		
Public variables of ESANET network (Number/Total bytes)		
Recipe field for recipe structure		
Recipes (Number of variables per recipe)		
Rectangles		
Redefinable characters	7	●
Reports		
Sequences - Random	64	●
Sequences - Start/stop		●
Static bitmaps		
Symbolic field: Bit-group-structured dynamic bitmaps		
Symbolic field: Single-bit-structured dynamic bitmaps		
Symbolic field: Value-structured dynamic bitmaps		
System messages		
System variables assigned to recipe structure		
Time long field		
Time short field		

Unless otherwise stated, there is no limit to the number of includable elements, only the size of project memory sets a limit.
*) indicative value determined by the dimensions of the project





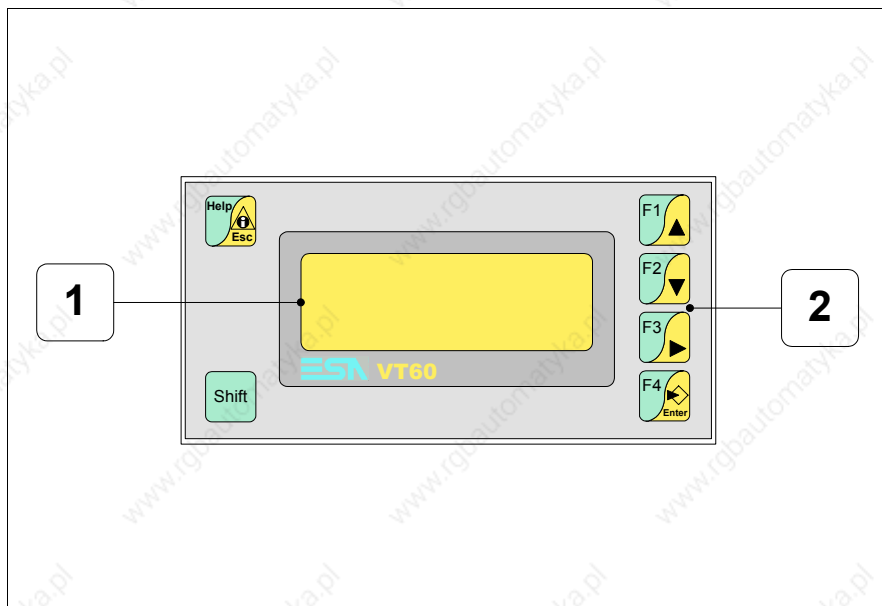

Table 4.1: Functions and objects realizable with this VT (Part 4 of 4)

Code of terminal		
VT060 *****		
Objects/Functions	Quantity	▼
Timer	20	●
Touch Area		
Trend buffers		
Trends (Trends x page/Channels x trend)		
Trends sampled automatically (Memory/Trends/Readings)		
Trends sampled on command (Memory/Trends/Readings)		
Value direct command: ADD		
Value direct command: AND		
Value direct command: OR		
Value direct command: SET		●
Value direct command: SUBTRACT		
Value direct command: XOR		
Variables: Limit values and linear scaling variables	12 x pages	
Variables: Movement variable (Mobile symbolic field)		
Variables: Threshold variables		
Variables: Floating Point numerical variables		●
Variables: Numerical variables (DEC, HEX, BIN, BCD)		●
Variables: String variables (ASCII)		●

Unless otherwise stated, there is no limit to the number of includable elements, only the size of project memory sets a limit.
 *) indicative value determined by the dimensions of the project

Front view



Key	Function
1	Display
Shift + 2	F-keys
	Opens and confirms setting
	Page up
	Page down
	Move cursor between fields
	Quits: setting of data, information messages, sequence directory, communication driver
	Displays information messages
Shift + 	Displays according to context: info-message help or page help

Standard series rear view

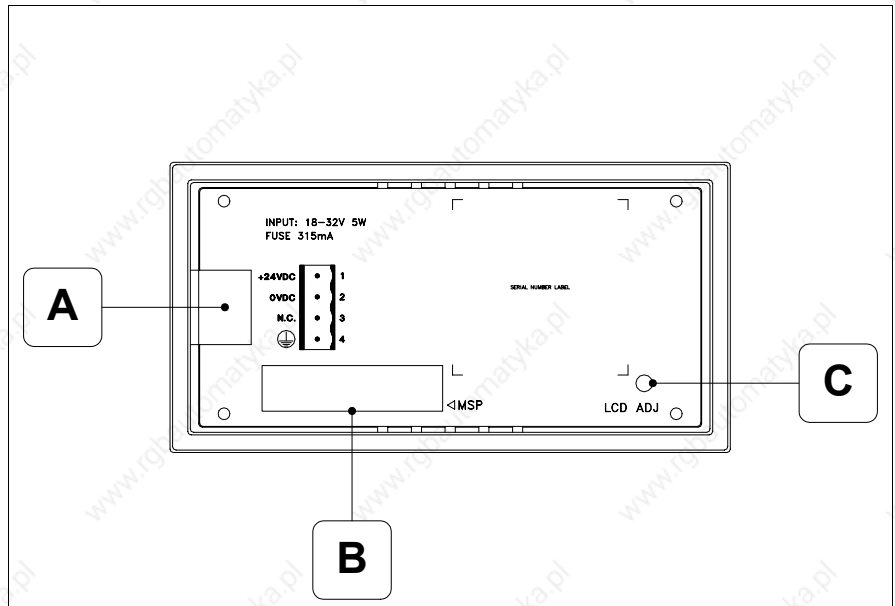

Position	Function
A	Power supply connector
B	MSP serial port
C	Trimmer for adjusting display contrast

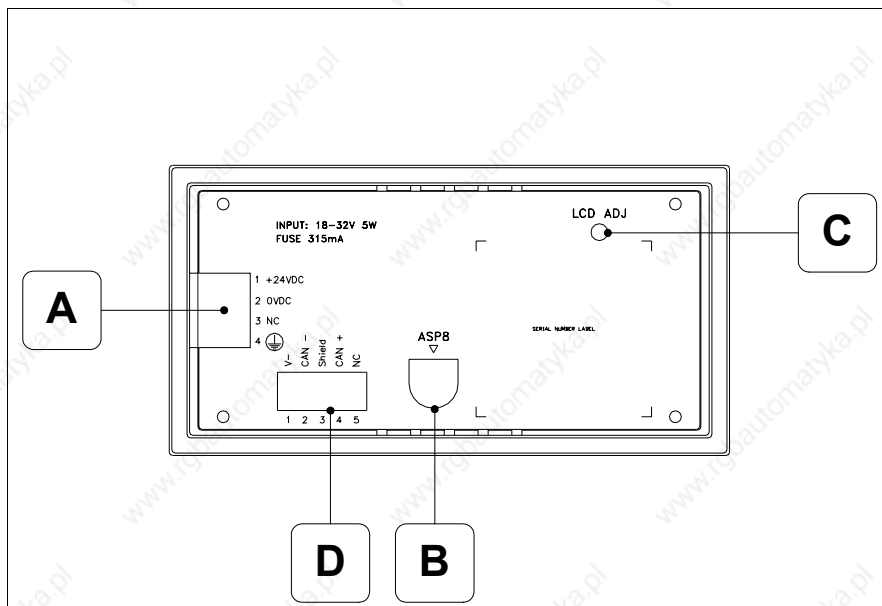
**CAN series
rear view**

Position	Function
A	Power supply connector
B	ASP-8 serial port
C	Trimmer for adjusting display contrast
D	CAN serial port

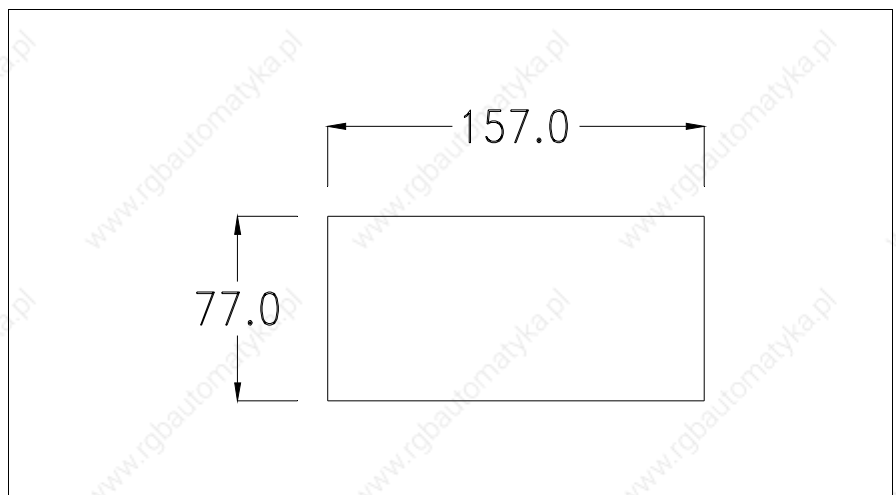
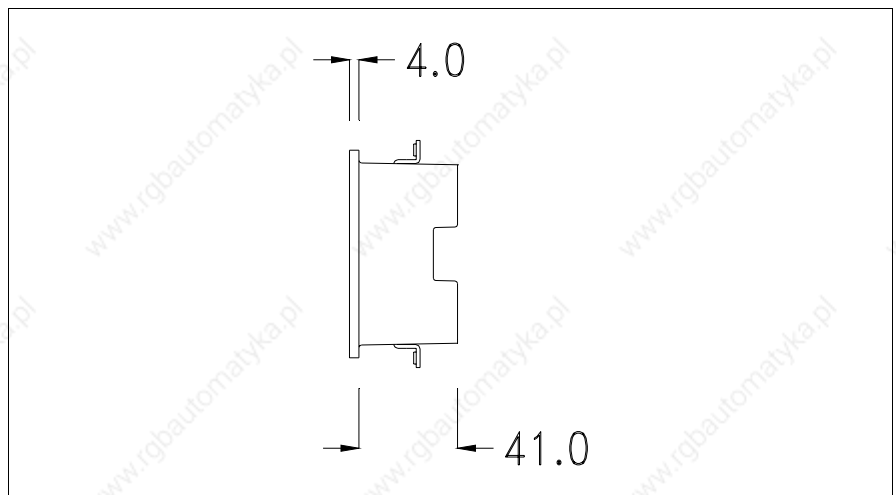
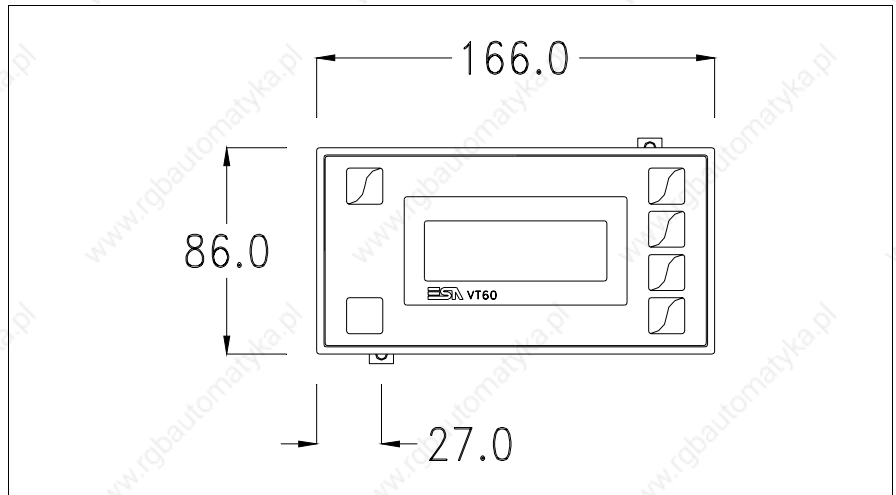
**Dimensions
and Cut-out**

To fix the sealing gasket and secure the VT to the container see “Chapter 29 -> Mounting the terminal within the container“.

! Where accessories need to be fixed in or onto the VT terminal, you are advised to do this before securing the VT to its container.

Accessories

Any accessories should be mounted in accordance with the instructions in the relevant chapter (see “Chapter 33 -> Video terminal accessories“).

Termination of CAN line

This paragraph applies only to the CAN series. The VT in question integrates the termination resistances of the serial line (typically 120 ohms) which can be inserted by means of a jumper (preset on 1-2, line not terminated). To activate the termination:

- Make sure the device is not connected to the power supply.
- Remove the cover.
- Identify the jumper unit J2.

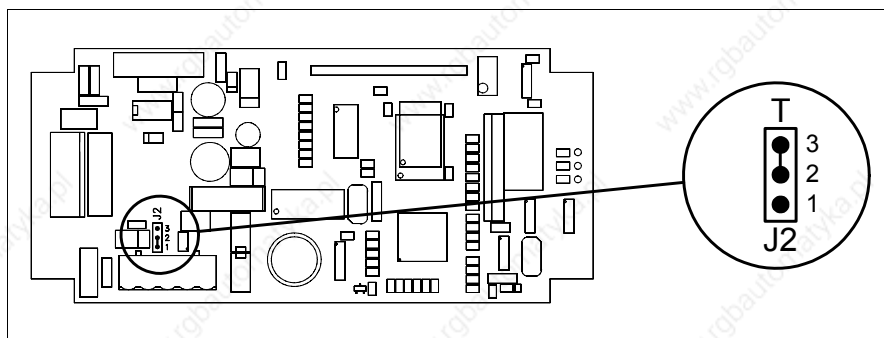

- Position the jumper between pins 2 and 3 (line terminated).
- Replace the back cover.
- Reconnect the power supply.

Transfer PC -> VT

For everything to function properly, the first time the VT operator terminal is switched on it needs to be correctly loaded, that is it needs to have transferred to it:

- Firmware
- Communication driver
- Project

(Given that the transfer of the three files in practice occurs with a single operation, it will be defined as “Project transfer” for the sake of simplicity.)

or:

- Free terminal protocol

For this it is essential that the VT be prepared to receive the transfer. (See also "Chapter 37 -> Command area").

Preparation for reception

The program VTWIN (see Software Manual) must be used for the transfer, but the terminal must be set up to receive. This means carrying out the following steps:

- Check that the VT is off
- Check that there is a serial connection between the PC and the VT
- Switch on the VT with  pressed down and wait a moment

VT terminal with no Modem function:

- The following mask appears. The VT is now ready to receive (refer to Software Manual for transfer procedure)



VT60 Service page

VT terminal with Modem function:

- The following mask appears



F1=MODEM - F2= PC

- Choose the required transfer mode: MODEM if you intend to use a modem or PC if you intend to use a serial port; press the corresponding function

If the choose made is PC, the VT is ready to receive (see Software Manual for transfer), if, on the other hand, you choose MODEM, the following mask will appear

F1=FAST - F2=SLOW

The choice should be according to the speed you intend to use for the transfer (Slow=9600bit/sec or Fast=38400bit/sec), press the corresponding function . The VT is now ready to receive (see Software Manual for the transfer).

Information relating to driver

After the project has been transferred, the VT can make available information relating to what has been loaded. The information regards:

- The name of the driver loaded
- The version of the driver loaded
- Network address of the VT
- Last error to have occurred

To acquire this information carry out the following operations:

- Be situated in any page of the project
- Press  twice; you now see

Driver: xxxxxxxxxxxxxx
Ver. : xxxxxxxxxxxxxx
Addr. : xxxxxxxxxxxxxx
Error : xxxxxxxxxxxxxx

The possible error messages are:

• PROT ERROR

Problem-> Errors have been detected in the data exchange between the VT and the Device.

Solution-> Check the cable; there may be disturbance.

• COM BROK

Problem-> Communication between VT and Device interrupted.

Solution-> Check the serial connection cable.

An error message followed by [*] indicates that the error is not currently present but was and has since disappeared.

Example: COM BROK*

Adjusting the contrast on the display

To improve the quality of the representation on the display it may be necessary to adjust its contrast. This can be done by rotating the trimmer (C) at the back of the VT (see Page 4-9 or Page 4-10); turn it (using a small screwdriver or a trimmer tool) in one direction and, if the display quality worsens, turn it the other way.

Chapter 5

Video terminal VT150W

Contents	Page
Technical characteristics	5-2
Functions	5-4
Front view	5-8
Customizing label	5-10
Standard series rear view	5-11
CAN series rear view	5-12
Dimensions and Cut-out	5-13
Accessories	5-14
Termination of CAN line	5-14
Transfer PC -> VT	5-15
Preparation for reception	5-15
Information relating to driver	5-17
Adjusting the contrast on the display	5-18

This chapter consists of 18 pages.



Technical characteristics

The following table lists the principal technical characteristics of the product in question.

Code of terminal	Characteristics of the terminal		
VT150W 00000			
VT150W 000DP			
VT150W A00CN			
Display		▼	▼
Type	LCD	●	●
Representational format	Text	●	●
Rows by characters	4 x 20	●	●
Display area size [mm]	70,4 x 20,8	●	●
Character matrix in text mode [pixels]	5 x 7	●	●
Character size [mm]	2,95 x 4,75	●	●
Contrast adjustment	Trimmer	●	●
	Automatic compensation with temperature		
Character sets	Ascii, Katakana	●	●
Backlighting			
Type	LED	●	●
	CCFL lamp		
Minimum lamp-life at 25°C [hours]	--		
Keyboard			
Non-customizable function keys	--		
Customizable function keys	5	●	●
Function key LEDs	5	●	●
Alphanumeric keys	11	●	●
Operational keys	9	●	●
Operational key LEDs	2	●	●
Diagnostic LEDs			

Code of terminal	Characteristics of the terminal		
VT150W 0000			
VT150W 000DP			
VT150W A00CN			
User memory			
Project [Bytes]	256K	●	● ●
Data memory [Bytes]	--		
Memory for Windows ® -based fonts [Byte]	--		
Memory Card for backup	--		
Memory Card for expansion	--		
Interfaces			
MSP (Multi-serial port)	RS232/RS422/RS485/TTY-20mA		● ●
ASP (Auxiliary serial port)	RS232/RS485		
ASP-15L (Auxiliary serial port)	RS232/RS485		
ASP-8 (Auxiliary serial port)	RS232	●	
ASP-9 (Auxiliary serial port)	RS232		
LPT parallel port	Centronics		
Auxiliary port	Connection for accessory devices		● ●
Accessories			
Connectable accessories	See table "Chapter 33"		● ●
Clock			
Clock			
Networks			
Integrated	Profibus-DP		●
	CAN Open (Optoisolated interface)	●	
	Ethernet 10/100Mbit RJ45		
Universal Bus Connector	--		
Optional	See table "Chapter 33"		● ●
Proprietary networks			
ESA-Net	Network server		
	Network client		● ●
Technical data			
Power supply	24Vdc (18..32Vdc)		
Power absorbed at 24Vdc	15W		
Protection fuse	Ø5x20mm - 800mA Quick Blow F		
Protection level	IP65 (front-end)		
Operating temperature	0..50°C		
Storage and transportation temperature	-20..+60°C		
Humidity (non-condensing)	<85%		
Weight	700gr		
Dimensions			
External W x H x D [mm]	148 x 188 x 41		
Cut-out W x H [mm]	123 x 175		
Certification			
Certifications and approvals	CE, cULus, NEMA12		

Functions

The following table lists in alphabetical order all the functions of the VT in question.

Table 5.1: Functions and objects realizable with this VT (Part 1 of 4)

Code of terminal		
VT150W *****	Objects/Functions	Quantity ▼
Alarm field		
Alarm help		
Alarm history buffer		
Alarm statistics		
Alarms (Total/active simultaneously)		
Arc		
Automatic operations	32	●
Backup/Restore		●
Bar data		
Bit-wise password	8bits	●
Buttons		
Circles		
Command: Change language		●
Command: Clear trend buffer		
Command: Delete recipe		
Command: Hardcopy		
Command: Load recipe from data memory		
Command: Modify password		●
Command: Next page		
Command: Page help		
Command: Password login		●
Command: Password logout		●
Command: Previous page		
Command: Print alarm history		
Command: Printer form feed		
Command: Quit project		●
Command: Report		
Command: Restarts reading time-sampled trend		
Command: Run pipeline		
Command: Save alarms history and trend buffers in flash		
Command: Save recipe in data memory		
Command: Save recipe received from device in buffer		
Command: Save recipe received from device in data memory		
Command: Send recipe from video buffer to device		
Command: Send recipe to device		
Command: Service page		

Unless otherwise stated, there is no limit to the number of includable elements, only the size of project memory sets a limit.
*) indicative value determined by the dimensions of the project

Table 5.1: Functions and objects realizable with this VT (Part 2 of 4)

Code of terminal		
VT150W *****		
Objects/Functions	Quantity	▼
Command: Show alarms history		
Command: Show page directory		
Command: Show project information		●
Command: Show recipe directory		
Command: Show sequence directory		●
Command: Shows driver status page		
Command: Shows page help		
Command: Shows page with function: PG		
Command: Stops reading time sampled trend		
Command: Trend reading saved in device		
Command: Zero number of general pages		
Date field		
Day-of-the-week field		
Dynamic texts: Bit-group-structured dynamic texts		●
Dynamic texts: Single-bit dynamic texts	1024*	●
Dynamic texts: Value-structured dynamic texts		●
E-keys		●
Equations	32	●
F-keys		●
Free terminal		●
Function: Disables key		●
Function: Go to page		
Function: Internal command		●
Function: Invert bit value		●
Function: Macro		●
Function: None		●
Function: Reset bit permanently		●
Function: Reset real-time bit		●
Function: Sequences		●
Function: Sets bit permanently		●
Function: Sets real-time bit		●
Function: Value-structure direct command		●
Global configuration of E-keys		●
Global configuration of F-keys		●
Headers and footers (Total/Number of fields per H-F)		
Info-messages (Total/active simultaneously)	1024/128	●
Internal registers	2048bytes	●
Labels		●
LEDs assigned to sequence		●

Unless otherwise stated, there is no limit to the number of includable elements, only the size of project memory sets a limit.
*) indicative value determined by the dimensions of the project

Table 5.1: Functions and objects realizable with this VT (Part 3 of 4)

Code of terminal		
VT150W *****		
Objects/Functions	Quantity	
Lines		
Lists of bitmap images		
Lists of texts		●
Local configuration of E-keys		●
Local configuration of F-keys		●
Macro field	8 x pages	
Macros (Total/Commands x macro)	1024/16	●
Message field		●
Message help	1024	●
Multilanguage texts	6 Langs.	●
Object - Indicator		
Object - Potentiometer knob		
Object - Selector knob		
Object - Sliding potentiometer		
Object - Sliding selector		
Page	1024	●
Page help	1024	●
Password	10	●
Pipelines (Number/Tot bytes)		
Print		
Print page (Total/Number of fields per page)		
Programmable fonts		
Project images		
Public variables of ESANET network (Number/Total bytes)	128/1024	●
Recipe field for recipe structure		
Recipes (Number of variables per recipe)		
Rectangles		
Redefinable characters	7	●
Reports		
Sequences - Random	64	●
Sequences - Start/stop		●
Static bitmaps		
Symbolic field: Bit-group-structured dynamic bitmaps		
Symbolic field: Single-bit-structured dynamic bitmaps		
Symbolic field: Value-structured dynamic bitmaps		
System messages		●
System variables assigned to recipe structure		
Time long field		
Time short field		

Unless otherwise stated, there is no limit to the number of includable elements, only the size of project memory sets a limit.
*) indicative value determined by the dimensions of the project





Table 5.1: Functions and objects realizable with this VT (Part 4 of 4)



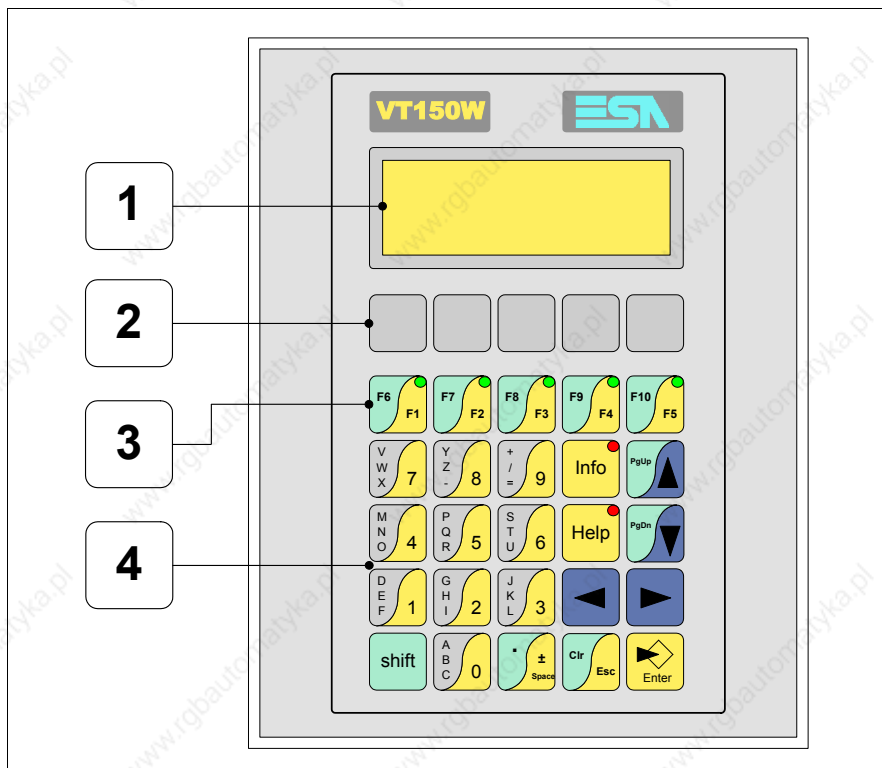

Code of terminal		
VT150W ****		
Objects/Functions	Quantity	▼
Timer	32	●
Touch Area		
Trend buffers		
Trends (Trends x page/Channels x trend)		
Trends sampled automatically (Memory/Trends/Readings)		
Trends sampled on command (Memory/Trends/Readings)		
Value direct command: ADD		●
Value direct command: AND		●
Value direct command: OR		●
Value direct command: SET		●
Value direct command: SUBTRACT		●
Value direct command: XOR		●
Variables: Limit values and linear scaling variables	32 x pages	●
Variables: Movement variable (Mobile symbolic field)		
Variables: Threshold variables		
Variables: Floating Point numerical variables		●
Variables: Numerical variables (DEC, HEX, BIN, BCD)		●
Variables: String variables (ASCII)		●

Unless otherwise stated, there is no limit to the number of includable elements, only the size of project memory sets a limit.
*) indicative value determined by the dimensions of the project

Front view



Key	Function
1	Display
2	F-key customizing label
3	F-keys
4	Alphanumeric and operative keys
	Opens and confirms input
	Page up When in setting phase, edits dynamic text
	Page down When in setting phase, edits dynamic
	Moves the cursor between settable fields When in setting phase, moves cursor to the left of the field
	Moves the cursor between settable fields When in setting phase, moves cursor to the right of the field

Key	Function
	Quits: setting of data, info-messages, sequence directory, communication driver
	Displays info-messages
	Displays according to context: information message help or page help
 + 	In setting phase restores the initial value of the field

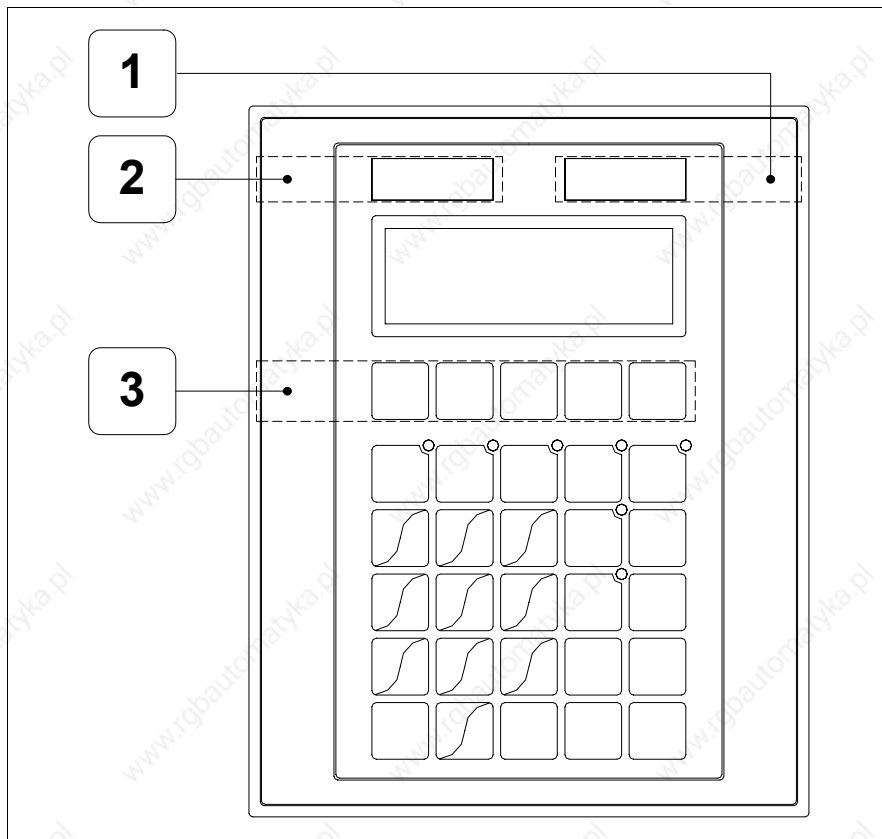
**Customizing
label**

Position	Function - Dimensions L x H (mm)
1	ESA Logo - 65 x 12
2	VT Model - 65 x 12
3	F-key customization F - 116 x 16



The total thickness of the label must not exceed 125µm (micrometers). Do not use either stiff materials or glues.



Before starting to insert the customized label, see “Chapter 28 -> Inserting customized labels”.

Standard series rear view

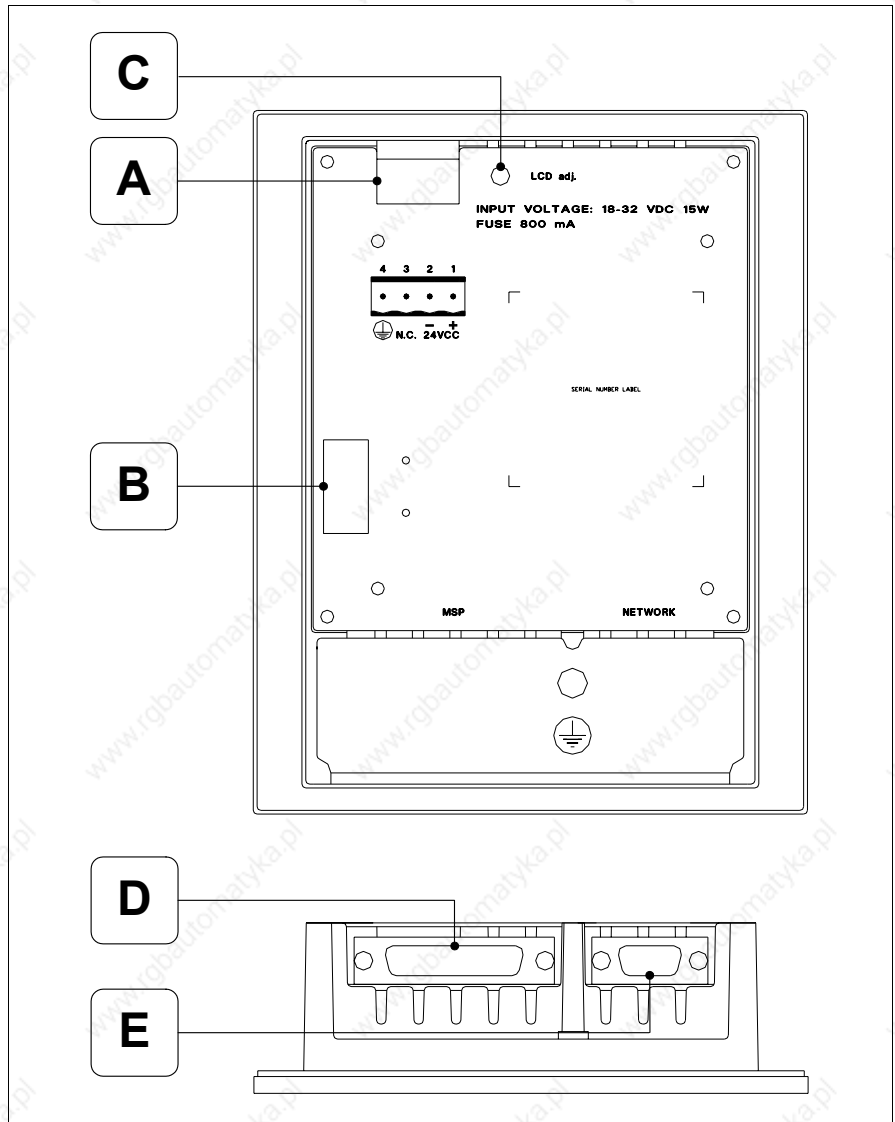

Position	Function
A	Power supply connector
B	Auxiliary port for connecting optional accessories
C	Trimmer for adjusting contrast of the display
D	MSP serial port
E	NETWORK serial port for network communication (Option)

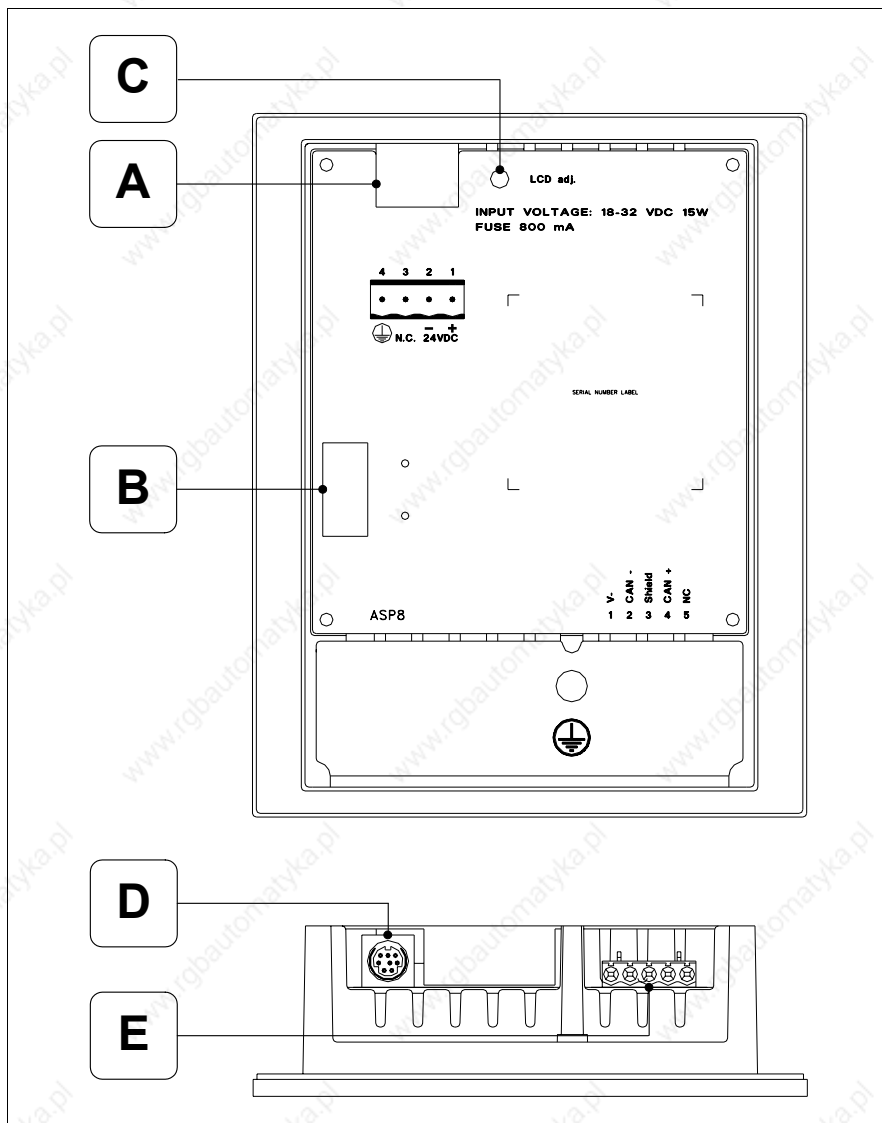
**CAN series
rear view**

Position	Function
A	Power supply connector
B	Auxiliary port for connecting optional accessories
C	Trimmer for adjusting contrast of the display
D	ASP-8 serial port
E	CAN serial port

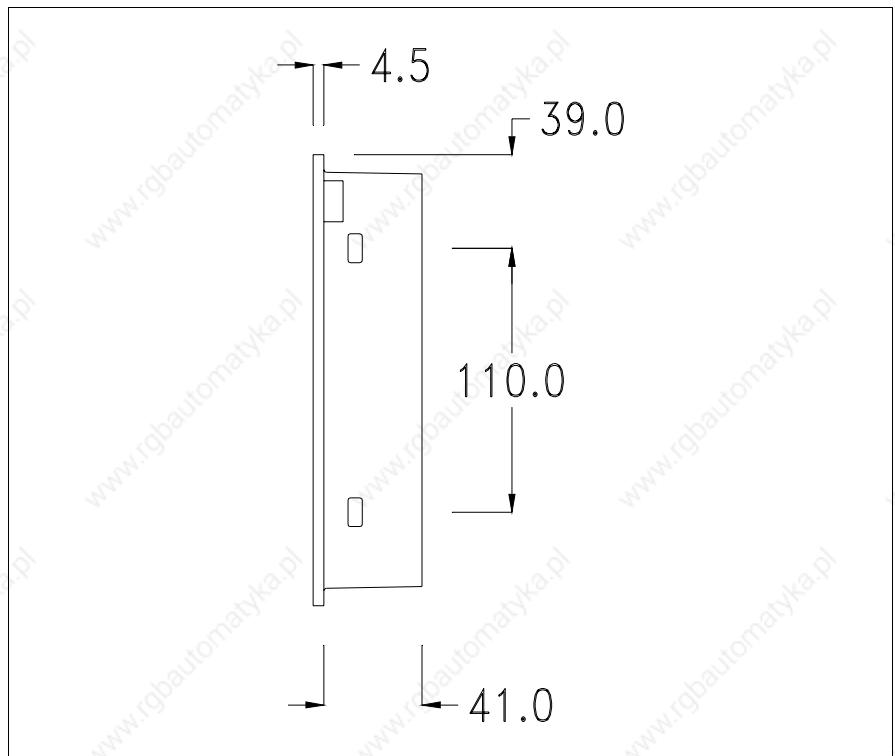
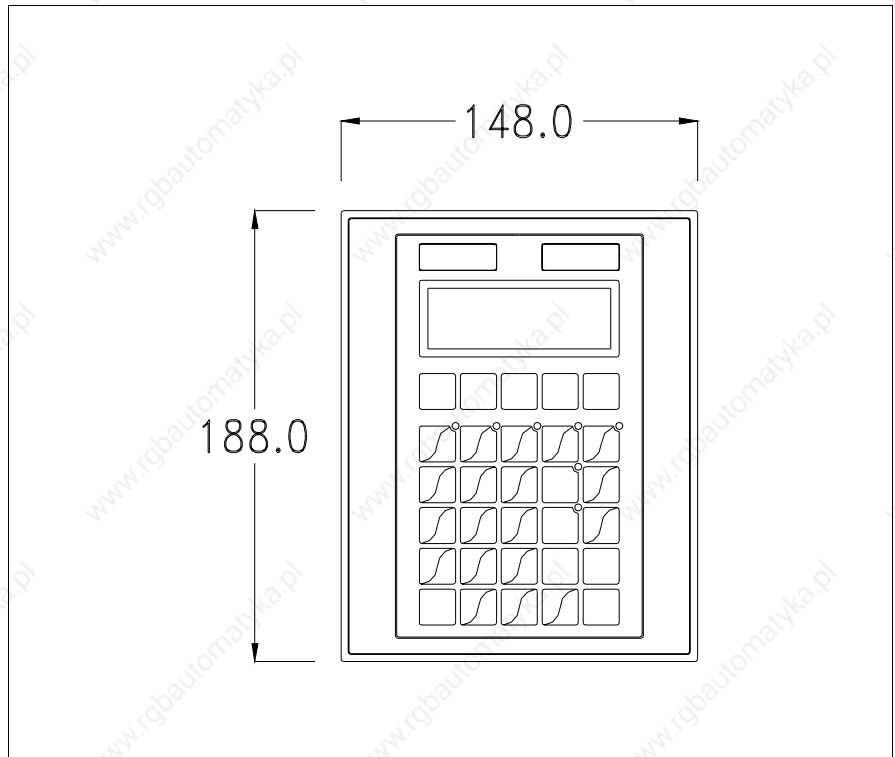
**Dimensions
and Cut-out**

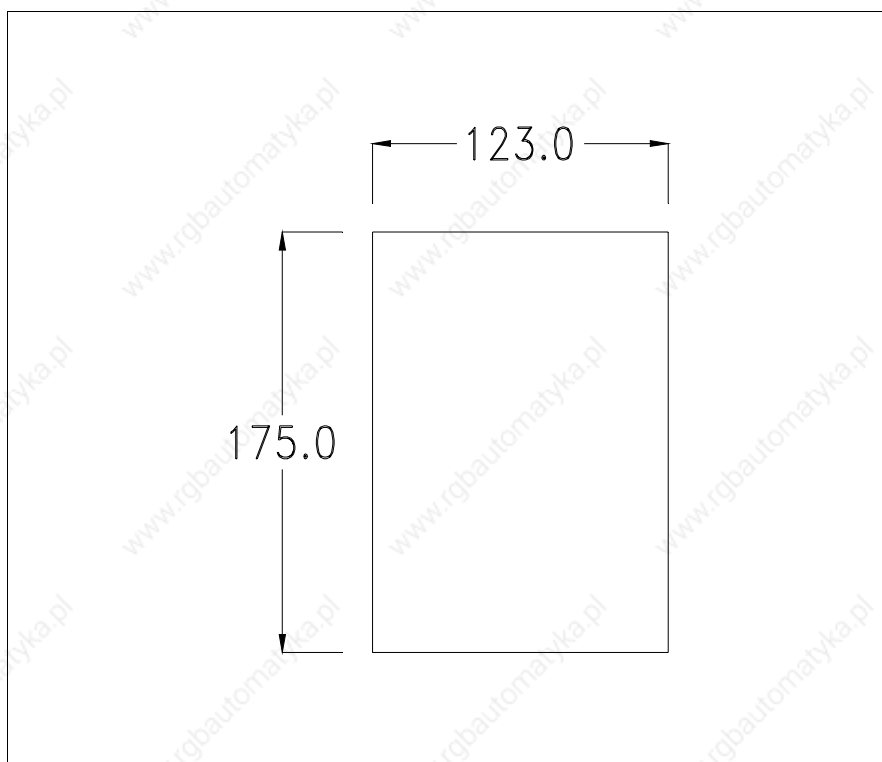

To fix the sealing gasket and secure the VT to the container see “Chapter 29 -> Mounting the terminal within the container“.

⚠ Where accessories need to be fixed in or onto the VT terminal, you are advised to do this before securing the VT to its container.

Accessories

Any accessories should be mounted in accordance with the instructions in the relevant chapter (see “Chapter 33 -> Video terminal accessories“).

Termination of CAN line

This paragraph applies only to the CAN series. The VT in question integrates the termination resistances of the serial line (typically 120 ohms) which can be inserted by means of a jumper (preset on 1-2, line not terminated). To activate the termination:

- Make sure the device is not connected to the power supply.
- Remove the cover.
- Identify the jumper unit J7.

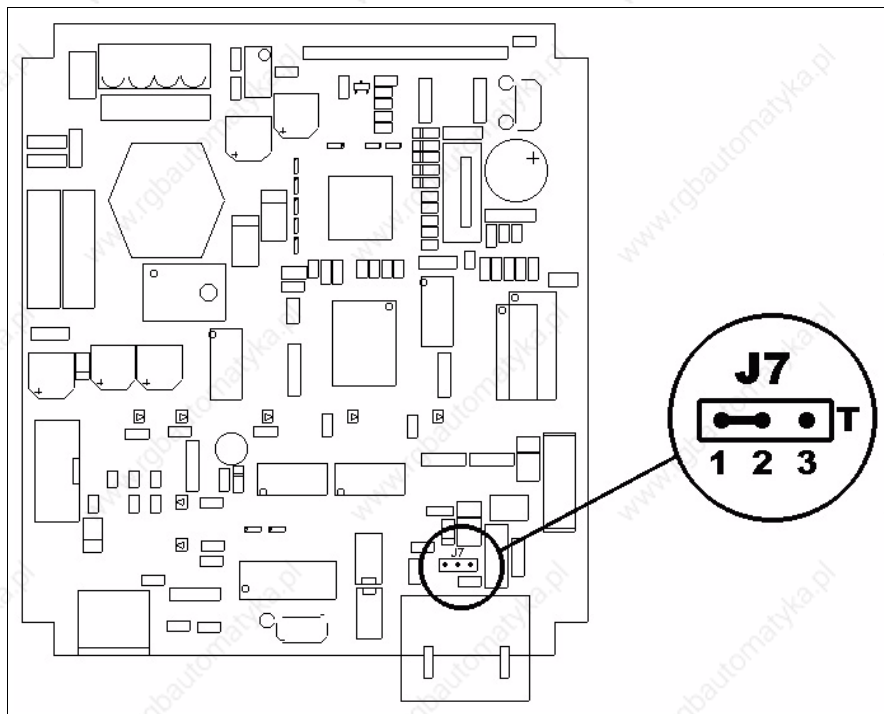

- Position the jumper between pins 2 and 3 (line terminated).
- Replace the back cover.
- Reconnect the power supply.

Transfer PC -> VT

For everything to function properly, the first time the VT operator terminal is switched on it needs to be correctly loaded, that is it needs to have transferred to it:

- Firmware
- Communication driver
- Project



(Given that the transfer of the three files in practice occurs with a single operation, it will be defined as “Project transfer” for the sake of simplicity.)

For this it is essential that the VT be prepared to receive the transfer. (See also “Chapter 37 -> Command area”).

Preparation for reception

The program VTWIN (see Software Manual) must be used for the transfer, but the terminal must be set up to receive. This means carrying out the following steps:

- Check that the VT is off
- Check that there is a serial connection between the PC and the VT

- Switch on the VT with  pressed down or with the VT on press together  + ; in either case wait a moment

VT terminal with no Modem function:

- The following mask appears. The VT is now ready to receive (refer to Software Manual for transfer procedure)

Boot forced

VT terminal with Modem function:

- The following mask appears

F1=MODEM - F2= PC

- Choose the required transfer mode: MODEM if you intend to use a modem or PC if you intend to use a serial port; press the corresponding function

If the choose made is PC, the VT is ready to receive (see Software Manual for transfer), if, on the other hand, you choose MODEM, the following mask will appear

F1=FAST - F2=SLOW

The choice should be according to the speed you intend to use for the transfer (Slow=9600bit/sec or Fast=38400bit/sec), press the corresponding function . The VT is now ready to receive (see Software Manual for the transfer).

Information relating to driver



After the project has been transferred, the VT can make available information relating to what has been loaded. The information regards:

- The name of the driver loaded
- The version of the driver loaded
- Network address of the VT
- Last error to have occurred

To acquire this information carry out the following operations:

- Be situated in any page of the project
- Press  twice; you will see

```
VT150W
Serial: xxxxxxxxxxxxxx
Driver: xxxxxxxxxxxxxx
Ver. : xxxxxxxxxxxxxx
```

- Press  or  to display

```
Addr. : xxxxxxxxxxxxxx
Error : xxxxxxxxxxxxxx
Up/Down: next page
```

Possible error messages are:

- **PROT ERROR**

Problem-> Errors have been detected in the data exchange between the VT and the Device.

Solution-> Check the cable; there may be disturbance.

- **COM BROKEN**

Problem-> Communication between VT and Device interrupted.

Solution-> Check the serial connection cable.

An error message followed by [*] indicates that the error is not currently present but was and has since disappeared.

Example: COM BROKEN*

Adjusting the contrast on the display

To improve the quality of the representation on the display it may be necessary to adjust its contrast. This can be done by rotating the trimmer (C) at the back of the VT (see Page 5-11 or Page 5-12); turn it (using a small screwdriver or a trimmer tool) in one direction and, if the display quality worsens, turn it the other way.

Chapter 6

Video terminal VT160W

Contents	Page
Technical characteristics	6-2
Functions	6-4
Front view	6-8
Customizing label	6-10
Rear view	6-11
Dimensions and Cut-out	6-12
Accessories	6-13
Transfer PC -> VT	6-13
Preparation for reception	6-14
Information relating to driver	6-15
Adjusting the contrast on the display	6-16

This chapter consists of 16 pages.

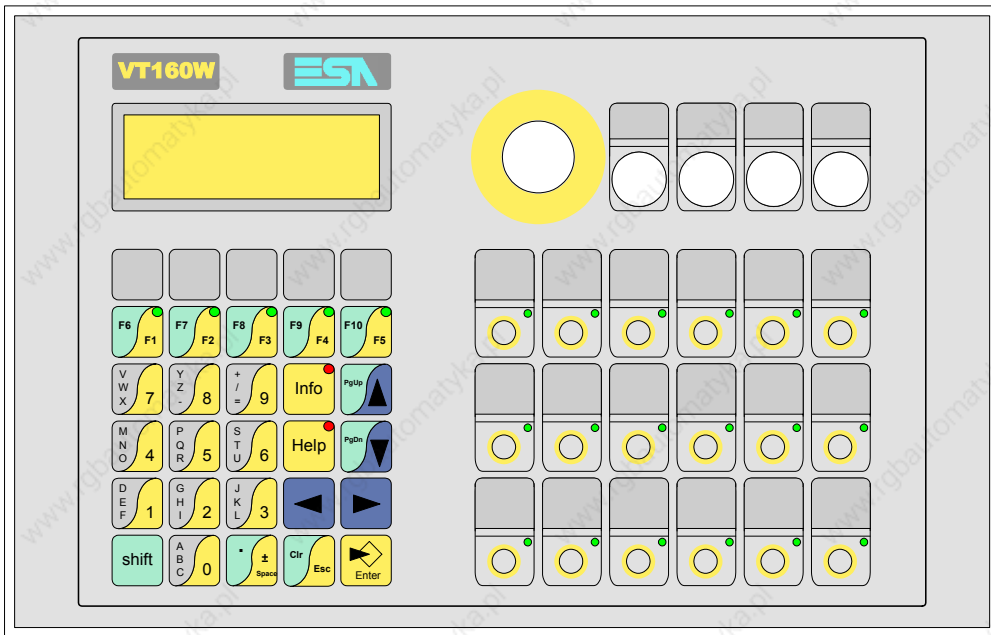

Technical characteristics

The following table lists the principal technical characteristics of the product in question.

Code of terminal	Characteristics of the terminal	
VT160W 00000		
VT160W 000DP		
Display		
Type	LCD	● ●
Representational format	Text	● ●
Rows by characters	4 x 20	● ●
Display area size [mm]	70,4 x 20,8	● ●
Character matrix in text mode [pixels]	5 x 7	● ●
Character size [mm]	2,95 x 4,75	● ●
Contrast adjustment	Trimmer	● ●
	Automatic compensation with temperature	
Character sets	Ascii, Katakana	● ●
Backlighting		
Type	LED	● ●
	CCFL lamp	
Minimum lamp-life at 25°C [hours]	--	
Keyboard		
Non-customizable function keys	--	
Customizable function keys	23	● ●
Function key LEDs	23	● ●
Alphanumeric keys	11	● ●
Operational keys	9	● ●
Operational key LEDs	2	● ●
Diagnostic LEDs	--	

Code of terminal	Characteristics of the terminal	
VT160W 0000		
VT160W 000DP		
User memory		
Project [Bytes]	256K	● ●
Data memory [Bytes]	--	
Memory for Windows ® -based fonts [Byte]	--	
Memory Card for backup	--	
Memory Card for expansion	--	
Interfaces		
MSP (Multi-serial port)	RS232/RS422/RS485/TTY-20mA	● ●
ASP (Auxiliary serial port)	RS232/RS485	
ASP-15L (Auxiliary serial port)	RS232/RS485	
ASP-8 (Auxiliary serial port)	RS232	
ASP-9 (Auxiliary serial port)	RS232	
LPT parallel port	Centronics	
Auxiliary port	Connection for accessory devices	
Accessories		
Connectable accessories	See table "Chapter 33"	● ●
Clock		
Clock		
Networks		
Integrated	Profibus-DP	●
	CAN Open (Optoisolated interface)	
	Ethernet 10/100Mbit RJ45	
Universal Bus Connector	--	
Optional	See table "Chapter 33"	● ●
Proprietary		
ESA-Net	Network server	
	Network client	● ●
Technical data		
Power supply	24Vdc (18..32Vdc)	
Power absorbed at 24Vdc	15W	
Protection fuse	Ø5x20mm - 800mA Quick Blow F	
Protection level	IP65 (front-end)	
Operating temperature	0..50°C	
Storage and transportation temperature	-20..+60°C	
Humidity (non-condensing)	<85%	
Weight	880gr	
Dimensions		
External W x H x D [mm]	296 x 188 x 42	
Cut-out W x H [mm]	See diagram	
Certification		
Certifications and approvals	CE, cULus, NEMA12	

Functions

The following table lists in alphabetical order all the functions of the VT in question.

Table 6.1: Functions and objects realizable with this VT (Part 1 of 4)

Code of terminal		
VT160W *****		
Objects/Functions	Quantity	
Alarm field		
Alarm help		
Alarm history buffer		
Alarm statistics		
Alarms (Total/active simultaneously)		
Arc		
Automatic operations	32	●
Backup/Restore		●
Bar data		
Bit-wise password	8bits	●
Buttons		
Circles		
Command: Change language		●
Command: Clear trend buffer		
Command: Delete recipe		
Command: Hardcopy		
Command: Load recipe from data memory		
Command: Modify password		●
Command: Next page		
Command: Page help		
Command: Password login		●
Command: Password logout		●
Command: Previous page		
Command: Print alarm history		
Command: Printer form feed		
Command: Quit project		●
Command: Report		
Command: Restarts reading time-sampled trend		
Command: Run pipeline		
Command: Save alarms history and trend buffers in flash		
Command: Save recipe in data memory		
Command: Save recipe received from device in buffer		
Command: Save recipe received from device in data memory		
Command: Send recipe from video buffer to device		
Command: Send recipe to device		
Command: Service page		

Unless otherwise stated, there is no limit to the number of includable elements, only the size of project memory sets a limit.
*) indicative value determined by the dimensions of the project, **) not present with VT160/O driver

Table 6.1: Functions and objects realizable with this VT (Part 2 of 4)

Code of terminal		
VT160W *****		
Objects/Functions	Quantity	▼
Command: Show alarms history		
Command: Show page directory		
Command: Show project information		●
Command: Show recipe directory		
Command: Show sequence directory		●
Command: Shows driver status page		
Command: Shows page help		
Command: Shows page with function: PG		
Command: Stops reading time sampled trend		
Command: Trend reading saved in device		
Command: Zero number of general pages		
Date field		
Day-of-the-week field		
Dynamic texts: Bit-group-structured dynamic texts		●
Dynamic texts: Single-bit dynamic texts	1024*	●
Dynamic texts: Value-structured dynamic texts		●
E-keys		●
Equations	32	●
F-keys		●
Free terminal		●
Function: Disables key		●
Function: Go to page		
Function: Internal command		●
Function: Invert bit value		●
Function: Macro		●
Function: None		●
Function: Reset bit permanently		●
Function: Reset real-time bit		●
Function: Sequences		●
Function: Sets bit permanently		●
Function: Sets real-time bit		●
Function: Value-structure direct command		●
Global configuration of E-keys	**	●
Global configuration of F-keys		●
Headers and footers (Total/Number of fields per H-F)		
Info-messages (Total/active simultaneously)	1024/128	●
Internal registers	2048bytes	●
Labels		●
LEDs assigned to sequence		●

Unless otherwise stated, there is no limit to the number of includable elements, only the size of project memory sets a limit.
 *) indicative value determined by the dimensions of the project, **) not present with VT160I/O driver

Table 6.1: Functions and objects realizable with this VT (Part 3 of 4)

Code of terminal		
VT160W *****		
Objects/Functions	Quantity	
Lines		
Lists of bitmap images		
Lists of texts		●
Local configuration of E-keys	**	●
Local configuration of F-keys		●
Macro field		
Macros (Total/Commands x macro)	1024/16	●
Message field		●
Message help	1024	●
Multilanguage texts	6 Langs.	●
Object - Indicator		
Object - Potentiometer knob		
Object - Selector knob		
Object - Sliding potentiometer		
Object - Sliding selector		
Page	1024	●
Page help	1024	●
Password	10	●
Pipelines (Number/Tot bytes)		
Print		
Print page (Total/Number of fields per page)		
Programmable fonts		
Project images		
Public variables of ESANET network (Number/Total bytes)	128/1024	●
Recipe field for recipe structure		
Recipes (Number of variables per recipe)		
Rectangles		
Redefinable characters	7	●
Reports		
Sequences - Random	64	●
Sequences - Start/stop		●
Static bitmaps		
Symbolic field: Bit-group-structured dynamic bitmaps		
Symbolic field: Single-bit-structured dynamic bitmaps		
Symbolic field: Value-structured dynamic bitmaps		
System messages		●
System variables assigned to recipe structure		
Time long field		
Time short field		

Unless otherwise stated, there is no limit to the number of includable elements, only the size of project memory sets a limit.
*) indicative value determined by the dimensions of the project, **) not present with VT160/O driver



Table 6.1: Functions and objects realizable with this VT (Part 4 of 4)





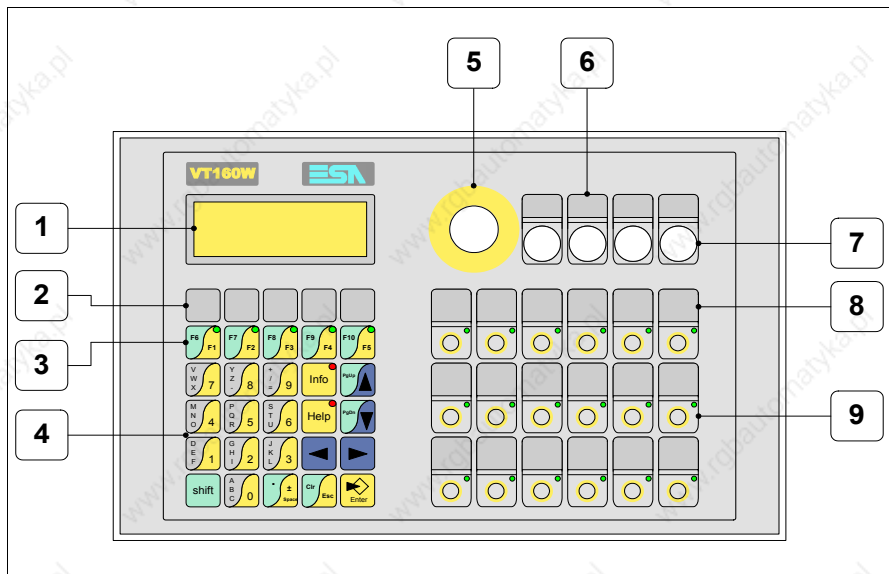

Code of terminal		
VT160W ****		
Objects/Functions	Quantity	▼
Timer	32	●
Touch Area		
Trend buffers		
Trends (Trends x page/Channels x trend)		
Trends sampled automatically (Memory/Trends/Readings)		
Trends sampled on command (Memory/Trends/Readings)		
Value direct command: ADD		●
Value direct command: AND		●
Value direct command: OR		●
Value direct command: SET		●
Value direct command: SUBTRACT		●
Value direct command: XOR		●
Variables: Limit values and linear scaling variables	32 x pages	●
Variables: Movement variable (Mobile symbolic field)		
Variables: Threshold variables		
Variables: Floating Point numerical variables		●
Variables: Numerical variables (DEC, HEX, BIN, BCD)		●
Variables: String variables (ASCII)		●

Unless otherwise stated, there is no limit to the number of includable elements, only the size of project memory sets a limit.
 *) indicative value determined by the dimensions of the project, **) not present with VT160/O driver

Front view

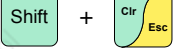

Key	Function
1	Display
2	F-key customizing label
3	F-keys
4	Alphanumeric and operative keys
5	22mm diameter pre-cut for mounting emergency stop button
6	Customizing label for command and/or signal elements
7	16mm diameter pre-cuts for mounting command and/or signal elements
8	E-key customizing label
9	E-keys
	Opens and confirms input
	Page up When in setting phase, edits dynamic text

Key	Function
	Page down When in setting phase, edits dynamic
	Moves the cursor between settable fields When in setting phase, moves cursor to the left of the field
	Moves the cursor between settable fields When in setting phase, moves cursor to the right of the field
	Quits: setting of data, info-messages, sequence directory, communication driver
	Displays info-messages
	Displays according to context: information message help or page help
	In setting phase restores the initial value of the field

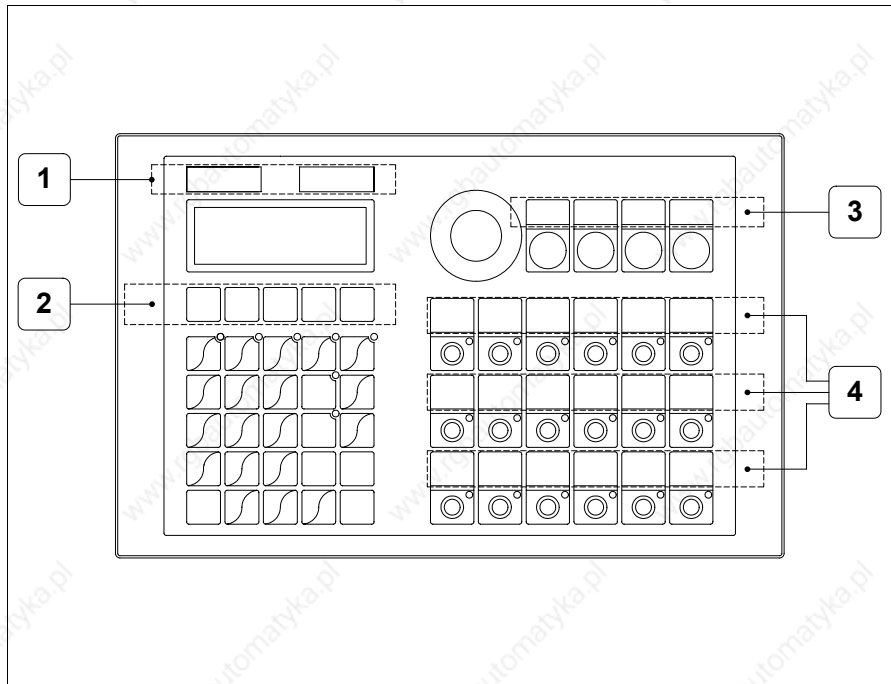
**Customizing
label**

Position	Function - Dimensions L x H (mm)
1	ESA Logo, VT Model - 101 x 13
2	F-key customization F - 118 x 18
3	Customizing label for command and/or signal elements - 112 x 8
4	F-key customization E - 149 x 16



The total thickness of the label must not exceed 125µm (micrometers). Do not use either stiff materials or glues.



Before starting to insert the customized label, see “Chapter 28 -> Inserting customized labels“.

Rear view

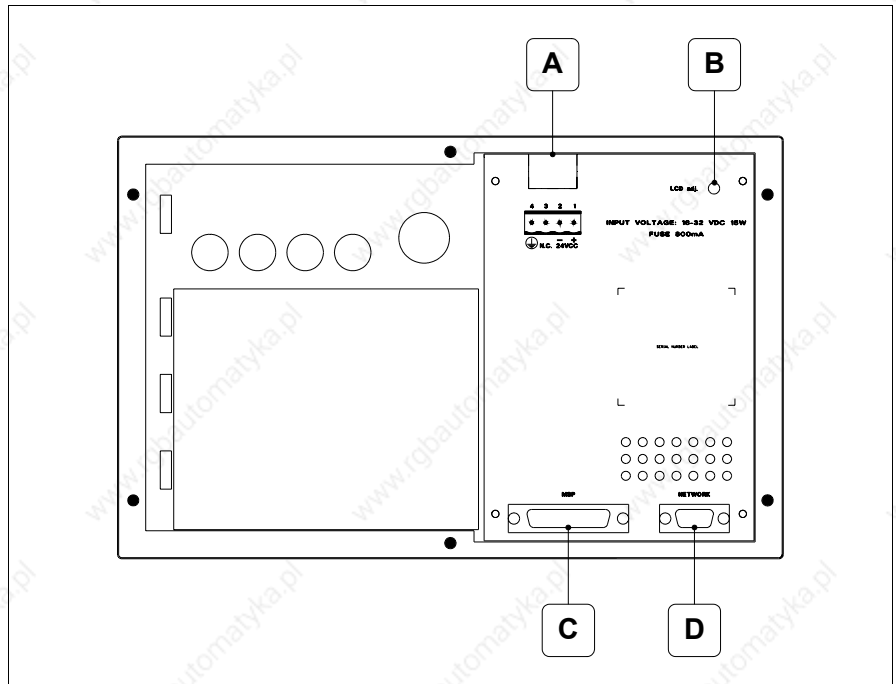

Position	Function
A	Power supply connector
B	Trimmer for adjusting contrast of the display
C	MSP serial port
D	NETWORK serial port for network communication (Optional)

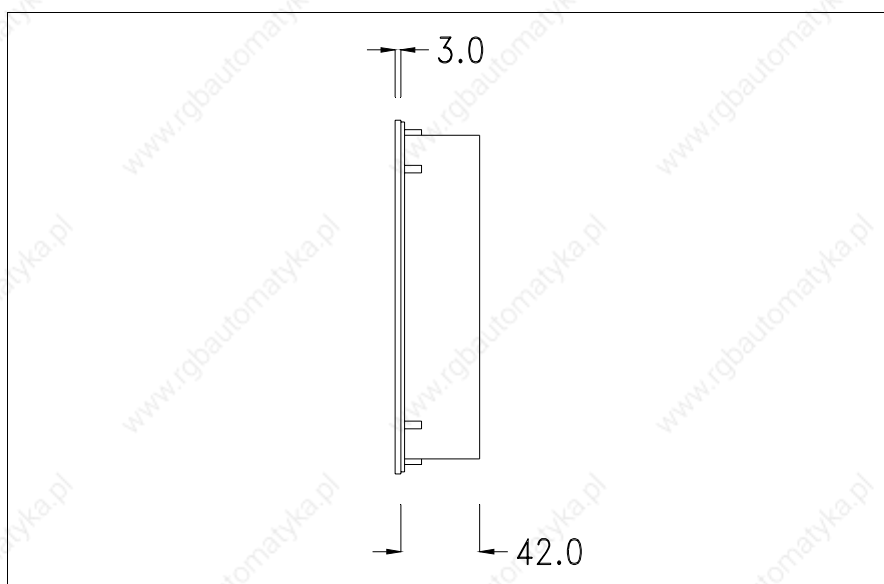
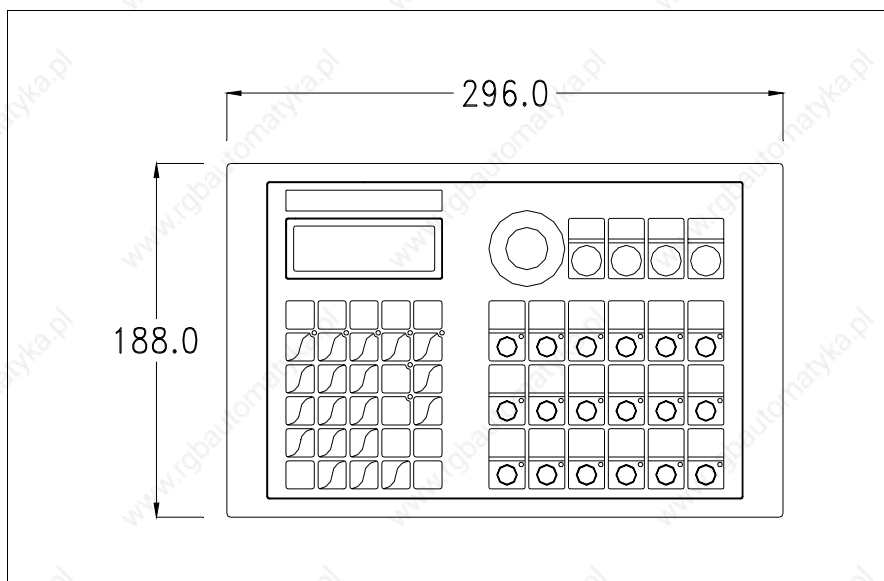
**Dimensions
and Cut-out**

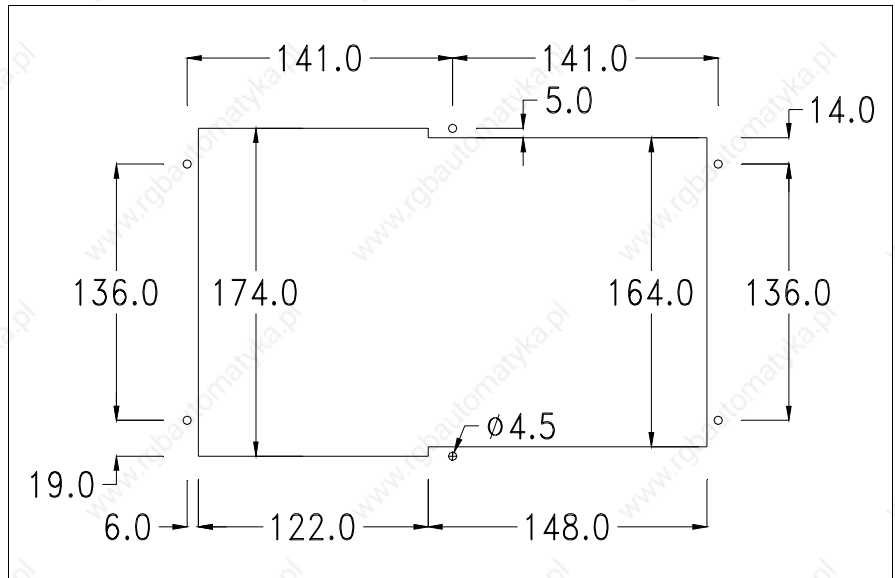

To fix the sealing gasket and secure the VT to the container see “Chapter 29 -> Mounting the terminal within the container”.

⚠ Where accessories need to be fixed in or onto the VT terminal, you are advised to do this before securing the VT to its container.

Accessories

Any accessories should be mounted in accordance with the instructions in the relevant chapter (see “Chapter 33 -> Video terminal accessories”).

Transfer PC -> VT

For everything to function properly, the first time the VT operator terminal is switched on it needs to be correctly loaded, that is, it needs to have transferred to it:



- Firmware
- Communication driver
- Project

(Given that the transfer of the three files in practice occurs with a single operation, it will be defined as “Project transfer” for the sake of simplicity.)

For this it is essential that the VT be prepared to receive the transfer. (See also “Chapter 37 -> Command area”).

Preparation for reception

The program VTWIN (see Software Manual) must be used for the transfer, but the terminal must be set up to receive. This means carrying out the following steps:

- Check that the VT is off
- Check that there is a serial connection between the PC and the VT
- Switch on the VT with  pressed down or with the VT on press together  + ; in either case wait a moment

VT terminal with no Modem function:

- The following mask appears. The VT is now ready to receive (refer to Software Manual for transfer procedure)



Boot forced

VT terminal with Modem function:

- The following mask appears



F1=MODEM - F2= PC

- Choose the required transfer mode: MODEM if you intend to use a modem or PC if you intend to use a serial port; press the corresponding function

If the choose made is PC, the VT is ready to receive (see Software Manual for transfer), if, on the other hand, you choose MODEM, the following mask will appear

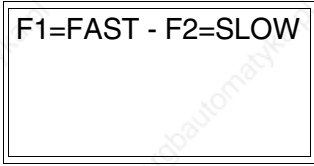

F1=FAST - F2=SLOW

The choice should be according to the speed you intend to use for the transfer (Slow=9600bit/sec or Fast=38400bit/sec), press the corresponding function . The VT is now ready to receive (see Software Manual for the transfer).

Information relating to driver



After the project has been transferred, the VT can make available information relating to what has been loaded. The information regards:

- The name of the driver loaded
- The version of the driver loaded
- Network address of the VT
- Last error to have occurred

To acquire this information carry out the following operations:

- Be situated in any page of the project
- Press  twice; you will see

```
VT160W
Serial: xxxxxxxxxxxxxx
Driver: xxxxxxxxxxxxxx
Ver. : xxxxxxxxxxxxxx
```

- Press  or  to display

```
Addr. : xxxxxxxxxxxxxx
Error : xxxxxxxxxxxxxx
Up/Down: next page
```

Possible error messages are:

- PR ERROR

Problem-> Errors have been detected in the data exchange between the VT and the Device.

Solution-> Check the cable; there may be disturbance.

- COM BROKEN

Problem-> Communication between VT and Device interrupted.

Solution-> Check the serial connection cable.

An error message followed by [*] indicates that the error is not currently present but was and has since disappeared.

Example: COM BROKEN*

Adjusting the contrast on the display

To improve the quality of the representation on the display it may be necessary to adjust its contrast. This can be done by rotating the trimmer (C) at the back of the VT (see Page 6-11); turn it (using a small screwdriver or a trimmer tool) in one direction and, if the display quality worsens, turn it the other way.

Chapter 7

Video terminal VT170W

Contents	Page
Technical characteristics	7-2
Functions	7-4
Front view	7-8
Customizing label	7-10
Rear view	7-11
Dimensions and Cut-out	7-13
Accessories	7-14
Transfer PC -> VT	7-14
Preparation for reception	7-15
Information relating to driver	7-16
Adjusting the contrast on the display	7-17

This chapter consists of 18 pages.

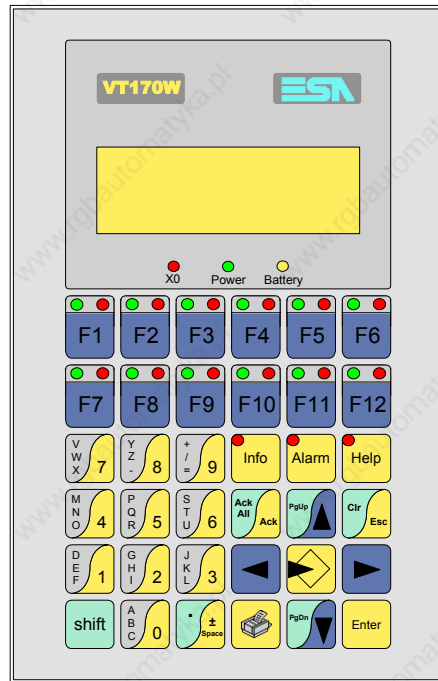

Technical characteristics

The following table lists the principal technical characteristics of the product in question.

Code of terminal	Characteristics of the terminal	
VT170W A0000		
Display		
Type	LCD	●
Representational format	Text	●
Rows by characters	4 x 20	●
Display area size [mm]	70,4 x 20,8	●
Character matrix in text mode [pixels]	5 x 7	●
Character size [mm]	2,95 x 4,75	●
Contrast adjustment	Trimmer	●
	Automatic compensation with temperature	
Character sets	Ascii, Katakana	●
Backlighting		
Type	LED	●
	CCFL lamp	
Minimum lamp-life at 25°C [hours]	--	
Keyboard		
Non-customizable function keys	--	
Customizable function keys	12	●
Function key LEDs	24	●
Alphanumeric keys	11	●
Operational keys	13	●
Operational key LEDs	3	●
Diagnostic LEDs	3	●

Code of terminal	Characteristics of the terminal	
VT170W A0000		
User memory		
Project [Bytes]	320K	●
Data memory [Bytes]	32K (With back-up battery)	●
Memory for Windows ® -based fonts [Byte]	--	
Memory Card for backup	--	
Memory Card for expansion	--	
Interfaces		
MSP (Multi-serial port)	RS232/RS422/RS485/TTY-20mA	●
ASP (Auxiliary serial port)	RS232/RS485	
ASP-15L (Auxiliary serial port)	RS232/RS485	
ASP-8 (Auxiliary serial port)	RS232	
ASP-9 (Auxiliary serial port)	RS232	●
LPT parallel port	Centronics	
Auxiliary port	Connection for accessory devices	
Accessories		
Connectable accessories	See table "Chapter 33"	●
Clock		
Clock	Hardware (With back-up battery)	●
Networks		
Integrated	Profibus-DP	
	CAN Open (Optoisolated interface)	
	Ethernet 10/100Mbit RJ45	
Universal Bus Connector	--	
Optional	See table "Chapter 33"	●
Proprietary networks		
ESA-Net	Network server	●
	Network client	●
Technical data		
Power supply	24Vdc (18..32Vdc)	
Power absorbed at 24Vdc	9W	
Protection fuse	Ø5x20mm - 500mA Quick Blow F	
Protection level	IP65 (front-end)	
Operating temperature	0..50°C	
Storage and transportation temperature	-20..+60°C	
Humidity (non-condensing)	<85%	
Weight	900gr	
Dimensions		
External W x H x D [mm]	126 x 196 x 60	
Cut-out W x H [mm]	107 x 178	
Certification		
Certifications and approvals	CE, cULus, NEMA12	

Functions

The following table lists in alphabetical order all the functions of the VT in question.

Table 7.1: Functions and objects realizable with this VT (Part 1 of 4)

Code of terminal		
VT170W *****	Objects/Functions	Quantity
Alarm field		●
Alarm help	1024	●
Alarm history buffer	256	●
Alarm statistics		
Alarms (Total/active simultaneously)	1024/128	●
Arc		
Automatic operations		
Backup/Restore		●
Bar data		
Bit-wise password	8bits	●
Buttons		
Circles		
Command: Change language		●
Command: Clear trend buffer		
Command: Delete recipe		●
Command: Hardcopy		●
Command: Load recipe from data memory		●
Command: Modify password		●
Command: Next page		
Command: Page help		●
Command: Password login		●
Command: Password logout		●
Command: Previous page		
Command: Print alarm history		●
Command: Printer form feed		●
Command: Quit project		●
Command: Report		●
Command: Restarts reading time-sampled trend		
Command: Run pipeline		
Command: Save alarms history and trend buffers in flash		
Command: Save recipe in data memory		●
Command: Save recipe received from device in buffer		●
Command: Save recipe received from device in data memory		●
Command: Send recipe from video buffer to device		●
Command: Send recipe to device		●
Command: Service page		●

Unless otherwise stated, there is no limit to the number of includable elements, only the size of project memory sets a limit.
*) indicative value determined by the dimensions of the project

Table 7.1: Functions and objects realizable with this VT (Part 2 of 4)

Code of terminal		
VT170W *****		
Objects/Functions	Quantity	▼
Command: Show alarms history		
Command: Show page directory		
Command: Show project information		●
Command: Show recipe directory		●
Command: Show sequence directory		●
Command: Shows driver status page		
Command: Shows page help		
Command: Shows page with function: PG		
Command: Stops reading time sampled trend		
Command: Trend reading saved in device		
Command: Zero number of general pages		●
Date field		●
Day-of-the-week field		●
Dynamic texts: Bit-group-structured dynamic texts	1024*	●
Dynamic texts: Single-bit dynamic texts		●
Dynamic texts: Value-structured dynamic texts		●
E-keys		
Equations		
F-keys		●
Free terminal		
Function: Disables key		●
Function: Go to page		
Function: Internal command		●
Function: Invert bit value		●
Function: Macro		●
Function: None		●
Function: Reset bit permanently		●
Function: Reset real-time bit		●
Function: Sequences		●
Function: Sets bit permanently		●
Function: Sets real-time bit		●
Function: Value-structure direct command		●
Global configuration of E-keys		
Global configuration of F-keys		●
Headers and footers (Total/Number of fields per H-F)	128/128	●
Info-messages (Total/active simultaneously)	1024/128	●
Internal registers		
Labels		●
LEDs assigned to sequence		●

Unless otherwise stated, there is no limit to the number of includable elements, only the size of project memory sets a limit.
*) indicative value determined by the dimensions of the project

Table 7.1: Functions and objects realizable with this VT (Part 3 of 4)

Code of terminal		
VT170W *****		
Objects/Functions	Quantity	
Lines		
Lists of bitmap images		
Lists of texts		●
Local configuration of E-keys		
Local configuration of F-keys		●
Macro field		
Macros (Total/Commands x macro)	1024/16	●
Message field		●
Message help	1024	●
Multilanguage texts	8 Langs.	●
Object - Indicator		
Object - Potentiometer knob		
Object - Selector knob		
Object - Sliding potentiometer		
Object - Sliding selector		
Page	1024	●
Page help	1024	●
Password	10	●
Pipelines (Number/Tot bytes)		
Print		●
Print page (Total/Number of fields per page)	1024/64	●
Programmable fonts		
Project images		
Public variables of ESANET network (Number/Total bytes)	128/1024	●
Recipe field for recipe structure		●
Recipes (Number of variables per recipe)	1024/256	●
Rectangles		
Redefinable characters	7	●
Reports	128	●
Sequences - Random	128	●
Sequences - Start/stop		●
Static bitmaps		
Symbolic field: Bit-group-structured dynamic bitmaps		
Symbolic field: Single-bit-structured dynamic bitmaps		
Symbolic field: Value-structured dynamic bitmaps		
System messages		●
System variables assigned to recipe structure		●
Time long field		●
Time short field		●

Unless otherwise stated, there is no limit to the number of includable elements, only the size of project memory sets a limit.
*) indicative value determined by the dimensions of the project

Table 7.1: Functions and objects realizable with this VT (Part 4 of 4)



Code of terminal		
VT170W ****		
Objects/Functions	Quantity ▼	
Timer		
Touch Area		
Trend buffers		
Trends (Trends x page/Channels x trend)		
Trends sampled automatically (Memory/Trends/Readings)		
Trends sampled on command (Memory/Trends/Readings)		
Value direct command: ADD	●	
Value direct command: AND	●	
Value direct command: OR	●	
Value direct command: SET	●	
Value direct command: SUBTRACT	●	
Value direct command: XOR	●	
Variables: Limit values and linear scaling variables	16 x pages	
Variables: Movement variable (Mobile symbolic field)		
Variables: Threshold variables		
Variables: Floating Point numerical variables		●
Variables: Numerical variables (DEC, HEX, BIN, BCD)		●
Variables: String variables (ASCII)		●





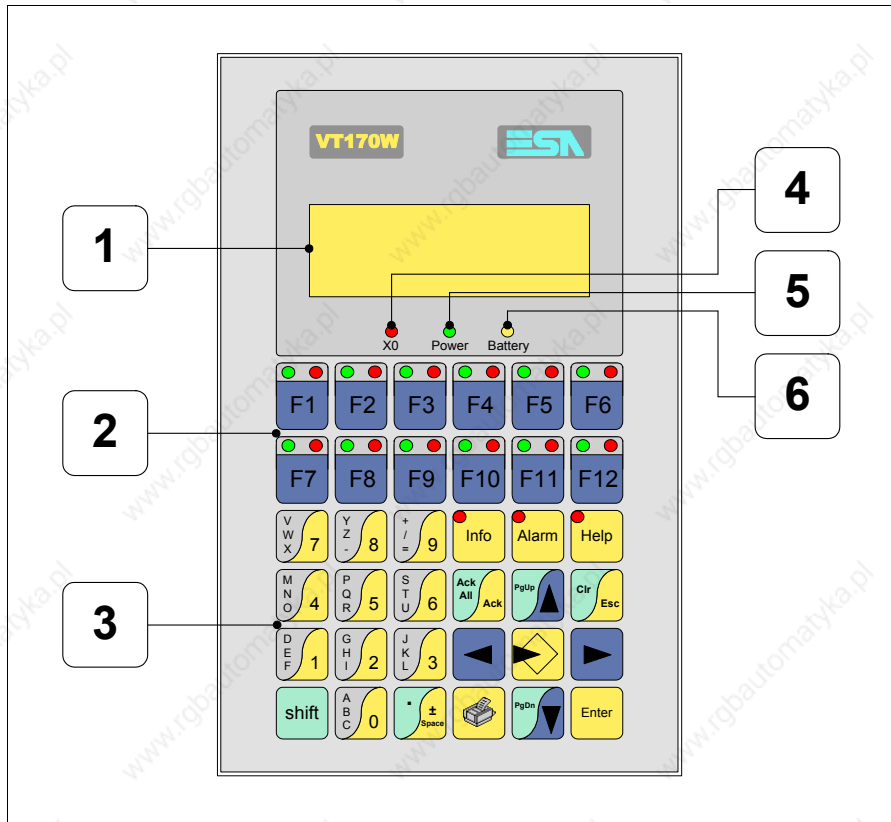







Unless otherwise stated, there is no limit to the number of includable elements, only the size of project memory sets a limit.

*) indicative value determined by the dimensions of the project

Front view



Key	Function
1	Display
2	F-keys
3	Alphanumeric and operative keys
4	X0 LED. Blinks when communication error is detected
5	Power LED. Lights up when power in ON
6	Battery LED. Lights up when the battery has nearly run out
	Start input
	Confirms setting of data

Key	Function
	Page up When in setting phase, edits dynamic text
	Page down When in setting phase, edits dynamic
	Moves the cursor between settable fields When in setting phase, moves cursor to the left of the field
	Moves the cursor between settable fields When in setting phase, moves cursor to the right of the field
	Quits: setting of data, info-messages, sequence directory, communication driver
	Displays info-messages
	Displays ISA alarms
	Displays according to context: information message help, alarm help or page help
	Acknowledgment of ISA alarms on display
	Print the entire display area
	In setting phase restores the initial value of the field
	Acknowledges all ISA alarms

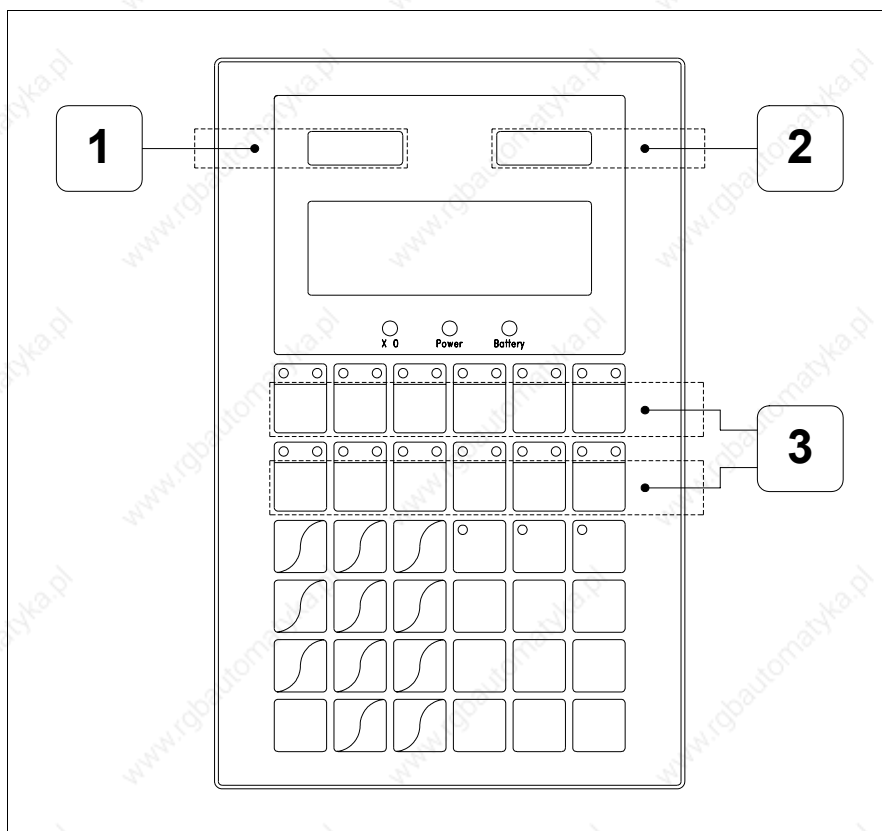
**Customizing
label**

Position	Function - Dimensions L x H (mm)
1	ESA Logo - 57 x 10
2	VT Model - 57 x 10
3	F-key customization F - 116 x 14



The total thickness of the label must not exceed 125µm (micrometers). Do not use either stiff materials or glues.



Before starting to insert the customized label, see “Chapter 28 -> Inserting customized labels”.

Rear view

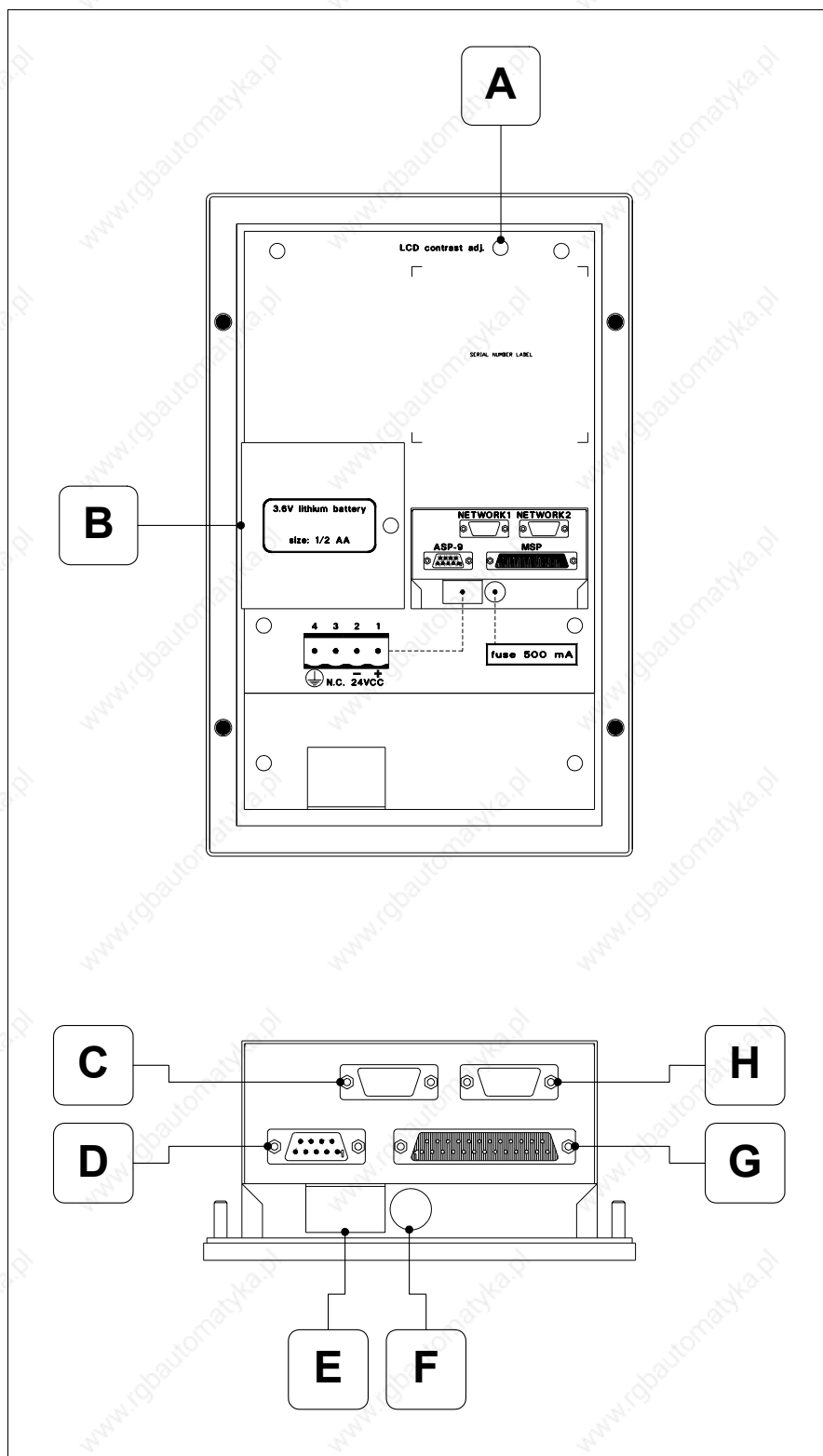

Position	Function
A	Trimmer for adjusting display contrast
B	Battery compartment
C	NETWORK1 serial port for network communication (Optional)
D	ASP-9 serial port for communicating with PC or other devices
E	Power supply connector
F	Fuse holder
G	MSP serial port for communicating with PLC/PC
H	NETWORK2 serial port for network communication (Optional)

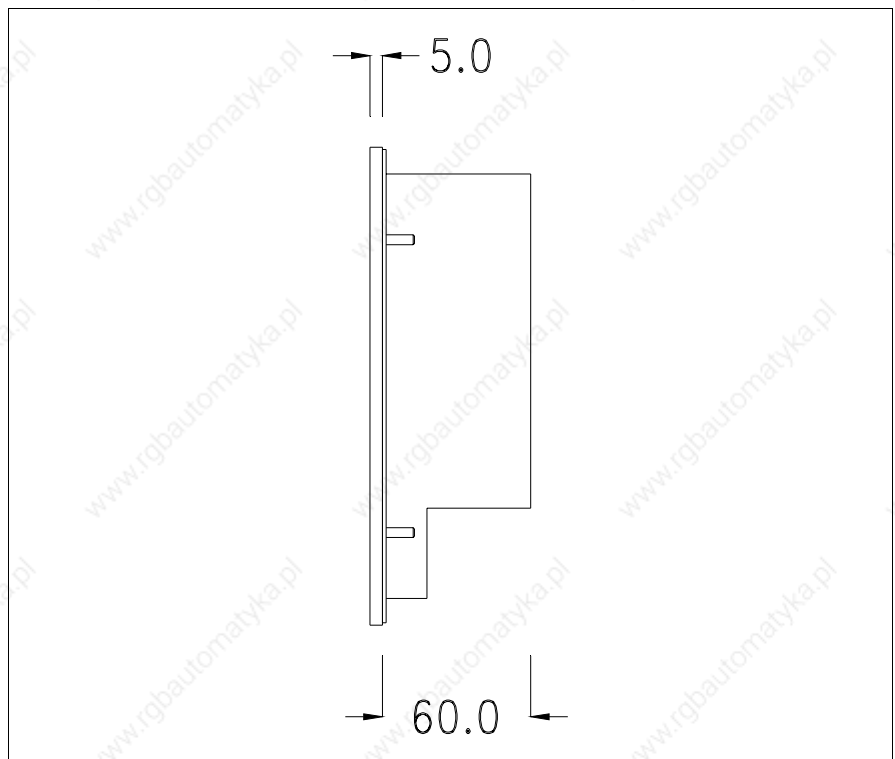
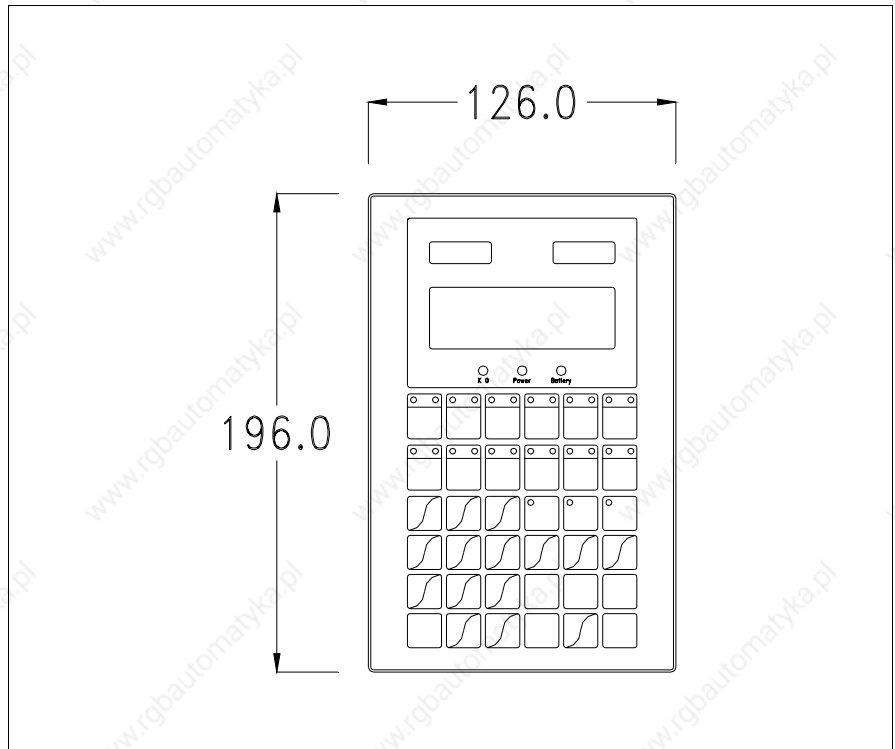
**Dimensions
and Cut-out**

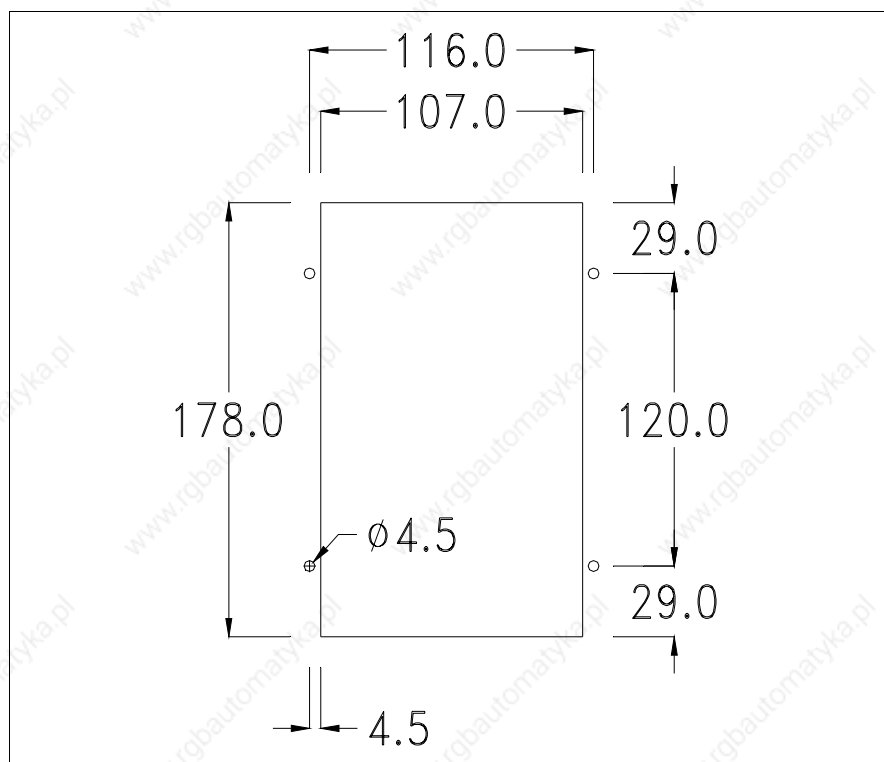

To fix the sealing gasket and secure the VT to the container see “Chapter 29 -> Mounting the terminal within the container“.

⚠ Where accessories need to be fixed in or onto the VT terminal, you are advised to do this before securing the VT to its container.

Accessories

Any accessories should be mounted in accordance with the instructions in the relevant chapter (see “Chapter 33 -> Video terminal accessories“).

Transfer PC -> VT

For everything to function properly, the first time the VT operator terminal is switched on it needs to be correctly loaded, that is it needs to have transferred to it:



- Firmware
- Communication driver
- Project

(Given that the transfer of the three files in practice occurs with a single operation, it will be defined as “Project transfer” for the sake of simplicity.)

For this it is essential that the VT be prepared to receive the transfer. (See also “Chapter 37 -> Command area“).

Preparation for reception

The program VTWIN (see Software Manual) must be used for the transfer, but the terminal must be set up to receive. This means carrying out the following steps:

- Check that the VT is off
- Check that there is a serial connection between the PC and the VT
- Switch on the VT with  pressed down or with the VT on press together  + ; in either case wait a moment

VT terminal with no Modem function:

- The following mask appears. Press the function corresponding to the port to be used. The VT is now ready to receive (refer to Software Manual for transfer procedure)

Boot sequence forced F1=ASP down/up load F2=MSP down/up load ENTER=run project

VT terminal with Modem function:

- Proceed from the preceding mask; the following mask appears

Boot sequence forced F1=MODEM dn/up load F2=PC dn/up load ENTER= run project

- Choose the required transfer mode: MODEM if you intend to use a modem or PC if you intend to use a serial port; press the corresponding function

If the choose made is PC, the VT is ready to receive (see Software Manual for transfer), if, on the other hand, you choose MODEM, the following mask will appear

Boot sequence forced F1=SLOW dn/up load F2=FAST dn/up load
--

The choice should be according to the speed you intend to use for the transfer (Slow=9600bit/sec or Fast=38400bit/sec), press the corresponding function . The VT is now ready to receive (see Software Manual for the transfer).

Information relating to driver

After the project has been transferred, the VT can make available information relating to what has been loaded. The information regards:

- The name of the driver loaded
- The version of the driver loaded
- Network address of the VT
- Last error to have occurred

To acquire this information carry out the following operations:

- Be situated in any page of the project
- Press  twice; you will see

```
VT170W
Serial: xxxxxxxxxxxxxx
Driver: xxxxxxxxxxxxxx
Ver. : xxxxxxxxxxxxxx
```







- Press  or ; you will see

```
Addr. : xxxxxxxxxxxxxx
Error : xxxxxxxxxxxxxx
Up/Down = next page
Enter = set clock
```

While displaying this page, press  to access the clock setting page

 **For the clock to be used properly, a special battery has to be inserted in the terminal (see “Chapter 33 -> Video terminal accessories”).**

Time	Date
hh:mm:ss	dd/mm/yy
Lf/Rt/Up/Dw = change	
Esc=Prj Enter=Memo	

Lf is the equivalent of , Rt is the equivalent of , Up of , Dw of ; using  you quit the display, while with  the settings are confirmed and you return to the project page.

Possible error messages that can be displayed on the appropriate line are:

- PR ERR

Problem-> Errors have been detected in the data exchange between the VT and the Device.

Solution-> Check the cable; there may be disturbance.

- COM BROKEN

Problem-> Communication between VT and Device interrupted.

Solution-> Check the serial connection cable.

An error message followed by [*] indicates that the error is not currently present but was and has since disappeared.

Example: COM BROKEN*

By pressing  you pass back to the project page.

Adjusting the contrast on the display

To improve the quality of the representation on the display it may be necessary to adjust its contrast. This can be done by rotating the trimmer (C) at the back of the VT (see Page 7-11); turn it (using a small screwdriver or a trimmer tool) in one direction and, if the display quality worsens, turn it the other way.

Chapter 8

Video terminal VT190W

Contents	Page
Technical characteristics	8-2
Functions	8-4
Front view	8-8
Customizing label	8-10
Rear view	8-11
Dimensions and Cut-out	8-13
Accessories	8-14
Transfer PC -> VT	8-14
Preparation for reception	8-15
Information relating to driver	8-16
Adjusting the contrast on the display	8-17

This chapter consists of 18 pages.

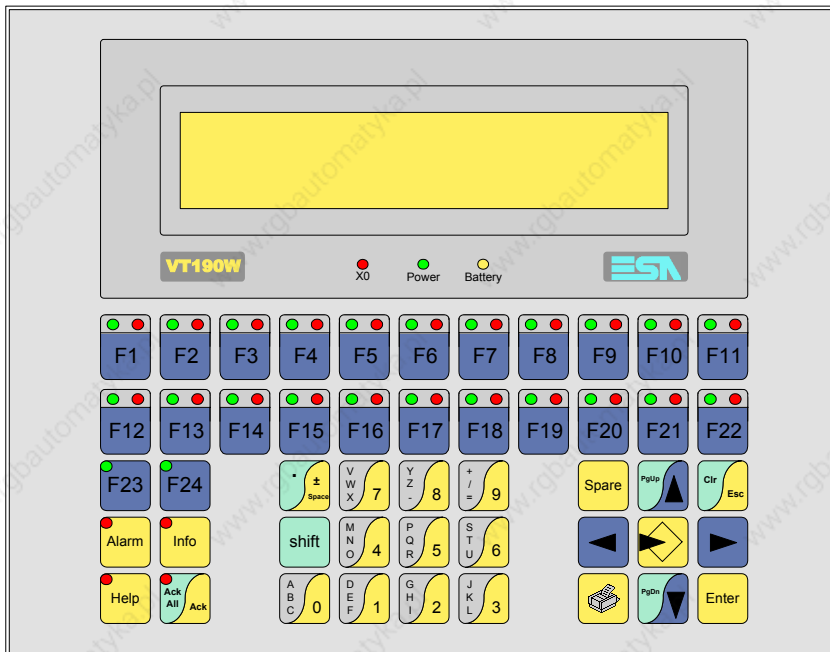

Technical characteristics

The following table lists the principal technical characteristics of the product in question.

Code of terminal	Characteristics of the terminal	
VT190W A0000		
VT190W AP000		
Display		▼ ▼
Type	LCD	● ●
Representational format	Text	● ●
Rows by characters	4 x 40	● ●
Display area size [mm]	140,5 x 23,2	● ●
Character matrix in text mode [pixels]	5 x 7	● ●
Character size [mm]	2,8 x 4,9	● ●
Contrast adjustment	Software Automatic compensation with temperature	● ●
Character sets	Ascii, Katakana	● ●
Backlighting		
Type	LED CCFL lamp	● ●
Minimum lamp-life at 25°C [hours]	--	
Keyboard		
Non-customizable function keys	2	● ●
Customizable function keys	22	● ●
Function key LEDs	46	● ●
Alphanumeric keys	11	● ●
Operational keys	14	● ●
Operational key LEDs	4	● ●
Diagnostic LEDs	3	● ●

Code of terminal	Characteristics of the terminal	
VT190W A000		
VT190W AP000		
User memory		
Project [Bytes]	256K	● ●
Data memory [Bytes]	105K (With back-up battery)	● ●
Memory for Windows ® -based fonts [Byte]	--	
Memory Card for backup	--	
Memory Card for expansion	--	
Interfaces		
MSP (Multi-serial port)	RS232/RS422/RS485/TTY-20mA	● ●
ASP (Auxiliary serial port)	RS232/RS485	
ASP-15L (Auxiliary serial port)	RS232/RS485	
ASP-8 (Auxiliary serial port)	RS232	
ASP-9 (Auxiliary serial port)	RS232	● ●
LPT parallel port	Centronics	●
Auxiliary port	Connection for accessory devices	
Accessories		
Connectable accessories	See table "Chapter 33"	● ●
Clock		
Clock	Hardware (With back-up battery)	● ●
Networks		
Integrated	Profibus-DP	
	CAN Open (Optoisolated interface)	
	Ethernet 10/100Mbit RJ45	
Universal Bus Connector	--	
Optional	See table "Chapter 33"	● ●
Proprietary networks		
ESA-Net	Network server	● ●
	Network client	● ●
Technical data		
Power supply	24Vdc (18..32Vdc)	
Power absorbed at 24Vdc	9W	
Protection fuse	Ø5x20mm - 800mA Quick Blow F	
Protection level	IP65 (front-end)	
Operating temperature	0..50°C	
Storage and transportation temperature	-20..+60°C	
Humidity (non-condensing)	<85%	
Weight	1500gr	
Dimensions		
External W x H x D [mm]	252 x 196 x 60	
Cut-out W x H [mm]	232 x 178	
Certification		
Certifications and approvals	CE, cULus, NEMA12	

Functions

The following table lists in alphabetical order all the functions of the VT in question.

Table 8.1: Functions and objects realizable with this VT (Part 1 of 4)

Code of terminal		
VT190W *****	Objects/Functions	Quantity
Alarm field		●
Alarm help	1024	●
Alarm history buffer	256	●
Alarm statistics		
Alarms (Total/active simultaneously)	1024/128	●
Arc		
Automatic operations		
Backup/Restore		●
Bar data		
Bit-wise password	8bits	●
Buttons		
Circles		
Command: Change language		●
Command: Clear trend buffer		
Command: Delete recipe		●
Command: Hardcopy		●
Command: Load recipe from data memory		●
Command: Modify password		●
Command: Next page		
Command: Page help		●
Command: Password login		●
Command: Password logout		●
Command: Previous page		
Command: Print alarm history		●
Command: Printer form feed		●
Command: Quit project		●
Command: Report		●
Command: Restarts reading time-sampled trend		
Command: Run pipeline		●
Command: Save alarms history and trend buffers in flash		
Command: Save recipe in data memory		●
Command: Save recipe received from device in buffer		●
Command: Save recipe received from device in data memory		●
Command: Send recipe from video buffer to device		●
Command: Send recipe to device		●
Command: Service page		●

Unless otherwise stated, there is no limit to the number of includable elements, only the size of project memory sets a limit.
*) indicative value determined by the dimensions of the project

Table 8.1: Functions and objects realizable with this VT (Part 2 of 4)

Code of terminal		
VT190W *****		
Objects/Functions	Quantity	▼
Command: Show alarms history		
Command: Show page directory		
Command: Show project information		●
Command: Show recipe directory		●
Command: Show sequence directory		●
Command: Shows driver status page		
Command: Shows page help		
Command: Shows page with function: PG		
Command: Stops reading time sampled trend		
Command: Trend reading saved in device		
Command: Zero number of general pages		●
Date field		●
Day-of-the-week field		●
Dynamic texts: Bit-group-structured dynamic texts	1024*	●
Dynamic texts: Single-bit dynamic texts		●
Dynamic texts: Value-structured dynamic texts		●
E-keys		
Equations		
F-keys		●
Free terminal		
Function: Disables key		●
Function: Go to page		
Function: Internal command		●
Function: Invert bit value		●
Function: Macro		●
Function: None		●
Function: Reset bit permanently		●
Function: Reset real-time bit		●
Function: Sequences		●
Function: Sets bit permanently		●
Function: Sets real-time bit		●
Function: Value-structure direct command		●
Global configuration of E-keys		
Global configuration of F-keys		●
Headers and footers (Total/Number of fields per H-F)	128/128	●
Info-messages (Total/active simultaneously)	1024/128	●
Internal registers		
Labels		●
LEDs assigned to sequence		●

Unless otherwise stated, there is no limit to the number of includable elements, only the size of project memory sets a limit.
*) indicative value determined by the dimensions of the project

Table 8.1: Functions and objects realizable with this VT (Part 3 of 4)

Code of terminal		
VT190W *****		
Objects/Functions	Quantity	
Lines		
Lists of bitmap images		
Lists of texts		●
Local configuration of E-keys		
Local configuration of F-keys		●
Macro field		
Macros (Total/Commands x macro)	1024/16	●
Message field		●
Message help	1024	●
Multilanguage texts	8 Langs.	●
Object - Indicator		
Object - Potentiometer knob		
Object - Selector knob		
Object - Sliding potentiometer		
Object - Sliding selector		
Page	1024	●
Page help	1024	●
Password	10	●
Pipelines (Number/Tot bytes)	64/512	●
Print		●
Print page (Total/Number of fields per page)	1024/128	●
Programmable fonts		
Project images		
Public variables of ESANET network (Number/Total bytes)	128/1024	●
Recipe field for recipe structure		●
Recipes (Number of variables per recipe)	1024/256	●
Rectangles		
Redefinable characters	7	●
Reports	128	●
Sequences - Random		●
Sequences - Start/stop	128	●
Static bitmaps		
Symbolic field: Bit-group-structured dynamic bitmaps		
Symbolic field: Single-bit-structured dynamic bitmaps		
Symbolic field: Value-structured dynamic bitmaps		
System messages		●
System variables assigned to recipe structure		●
Time long field		●
Time short field		●

Unless otherwise stated, there is no limit to the number of includable elements, only the size of project memory sets a limit.
*) indicative value determined by the dimensions of the project

Table 8.1: Functions and objects realizable with this VT (Part 4 of 4)



Code of terminal		
VT190W ****		
Objects/Functions	Quantity ▼	
Timer		
Touch Area		
Trend buffers		
Trends (Trends x page/Channels x trend)		
Trends sampled automatically (Memory/Trends/Readings)		
Trends sampled on command (Memory/Trends/Readings)		
Value direct command: ADD	●	
Value direct command: AND	●	
Value direct command: OR	●	
Value direct command: SET	●	
Value direct command: SUBTRACT	●	
Value direct command: XOR	●	
Variables: Limit values and linear scaling variables	32 x pages	
Variables: Movement variable (Mobile symbolic field)		
Variables: Threshold variables		
Variables: Floating Point numerical variables		●
Variables: Numerical variables (DEC, HEX, BIN, BCD)		●
Variables: String variables (ASCII)		●





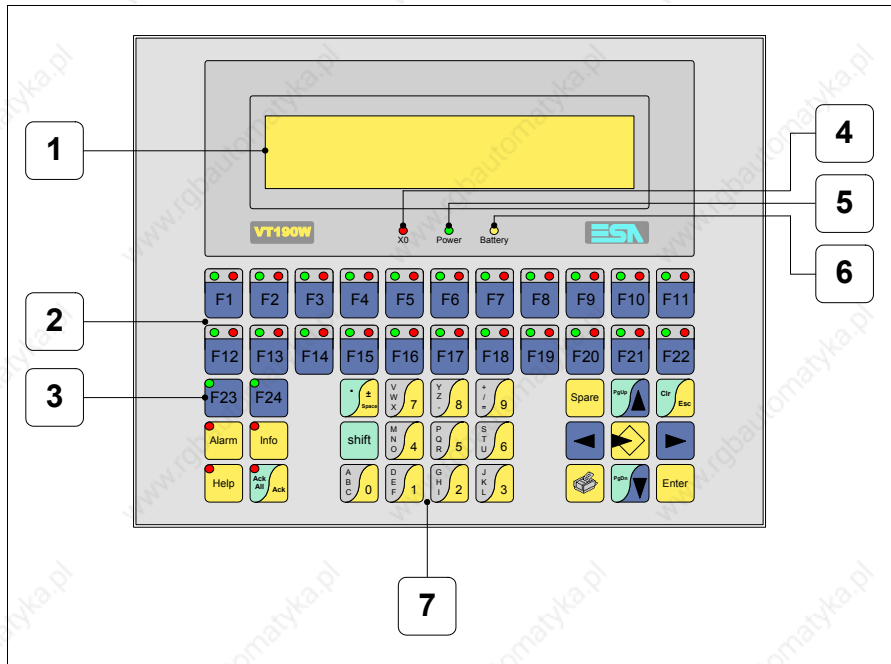







Unless otherwise stated, there is no limit to the number of includable elements, only the size of project memory sets a limit.

*) indicative value determined by the dimensions of the project

Front view



Key	Function
1	Display
2	F-keys with two LEDs
3	F-keys with one LED
4	X0 LED. Blinks when communication error is detected
5	Power LED. Lights up when power in ON
6	Battery LED. Lights up when the battery has nearly run out
7	Alphanumeric keys
	Starts input
	Confirms setting of data
	Page up When in setting phase, edits dynamic text

Key	Function
	Page down When in setting phase, edits dynamic text
	Moves the cursor between settable fields When in setting phase, moves cursor to the left of the field
	Moves the cursor between settable fields When in setting phase, moves cursor to the right of the field
	Quits: setting of data, info-messages, sequence directory, communication driver
	Displays info-messages
	Displays ISA alarms
	Displays according to context: information message help, alarm help or page help
	Acknowledgment of ISA alarms on display
	Print the entire display area
	No predefined function
shift + 	In setting phase restores the initial value of the field
shift + 	Acknowledges all ISA alarms

Customizing label

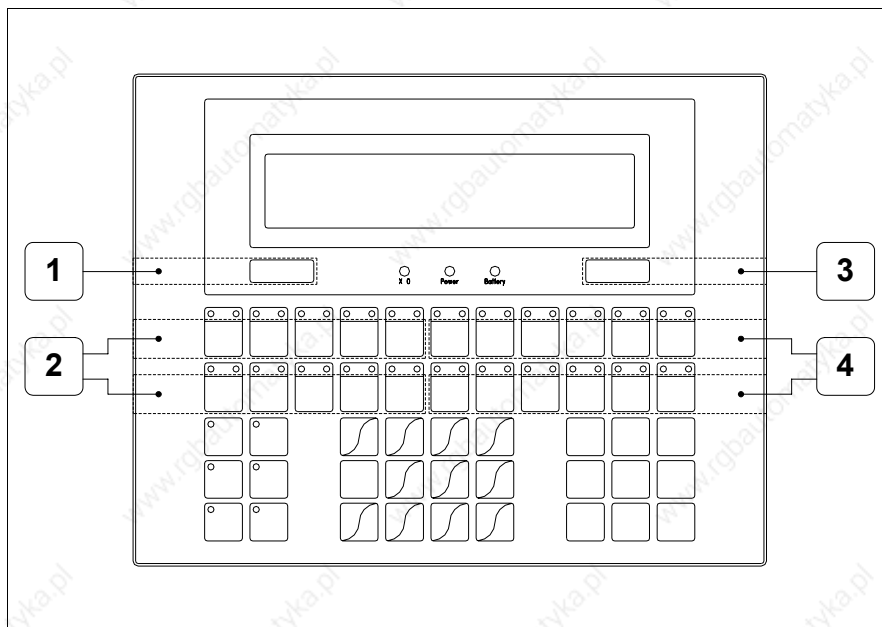

Position	Function - Dimensions L x H (mm)
1	ESA Logo - 73 x 10
2	F-key customization F1... F5, F12... F16 - 116 x 15
3	VT Model - 73 x 10
4	F-key customization F6... F11, F17... F22 - 134 x 15



The total thickness of the label must not exceed 125µm (micrometers). Do not use either stiff materials or glues.



Before starting to insert the customized label, see “Chapter 28 -> Inserting customized labels“.

Rear view

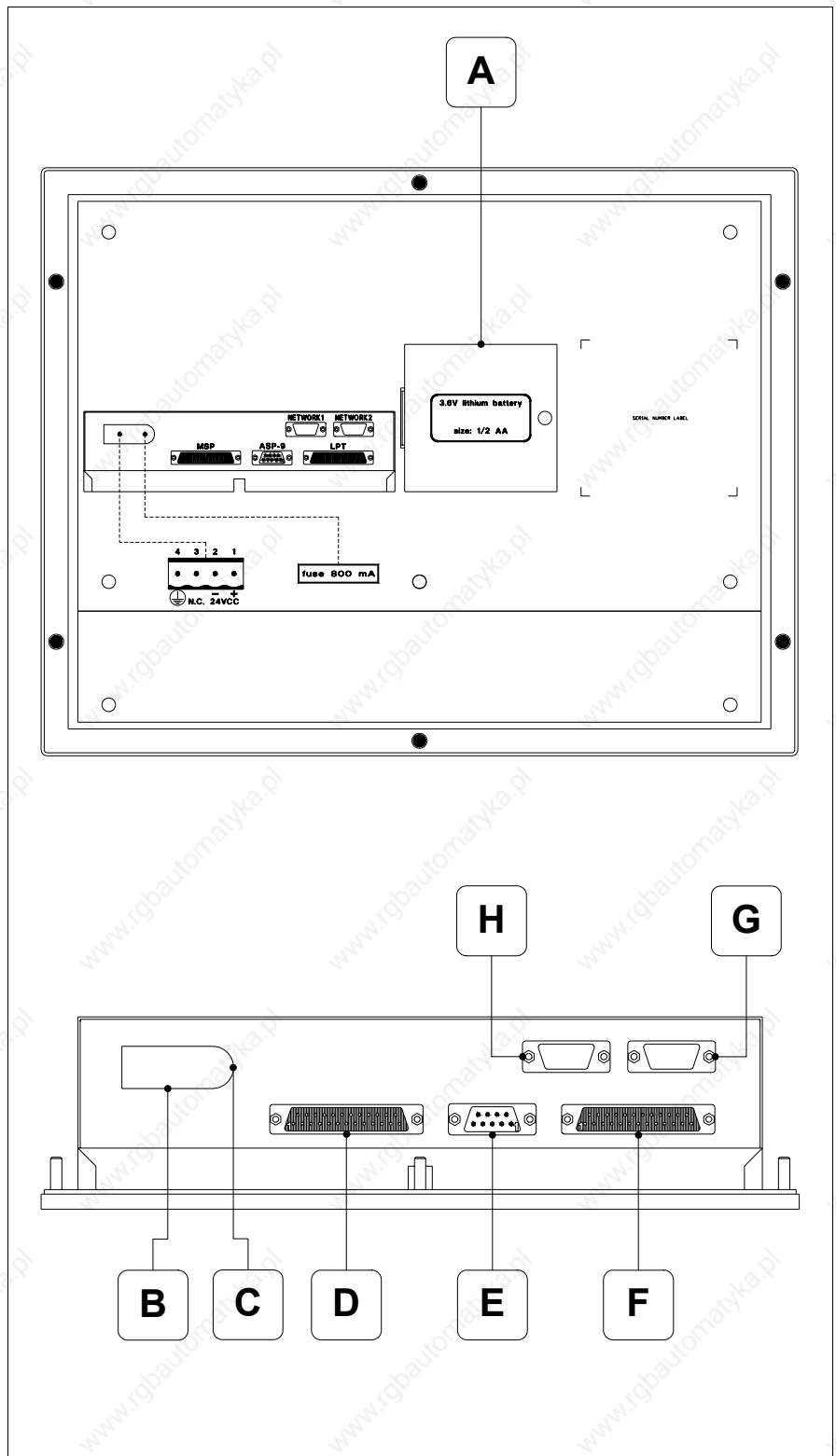

Position	Function
A	Battery compartment
B	Power supply connector
C	Fuse holder
D	MSP serial port for communicating with PLC/PC
E	ASP-9 serial port for communicating with PC or other devices
F	LPT port for connecting printer (Optional)
G	NETWORK2 serial port for network communication (Optional)
H	NETWORK1 serial port for network communication (Optional)

Dimensions and Cut-out

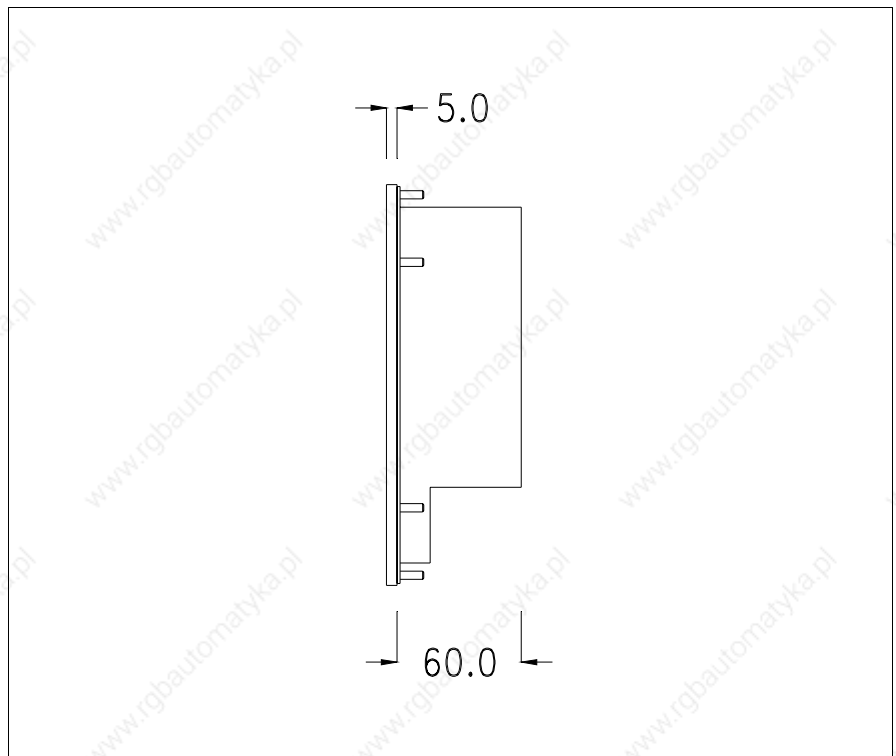
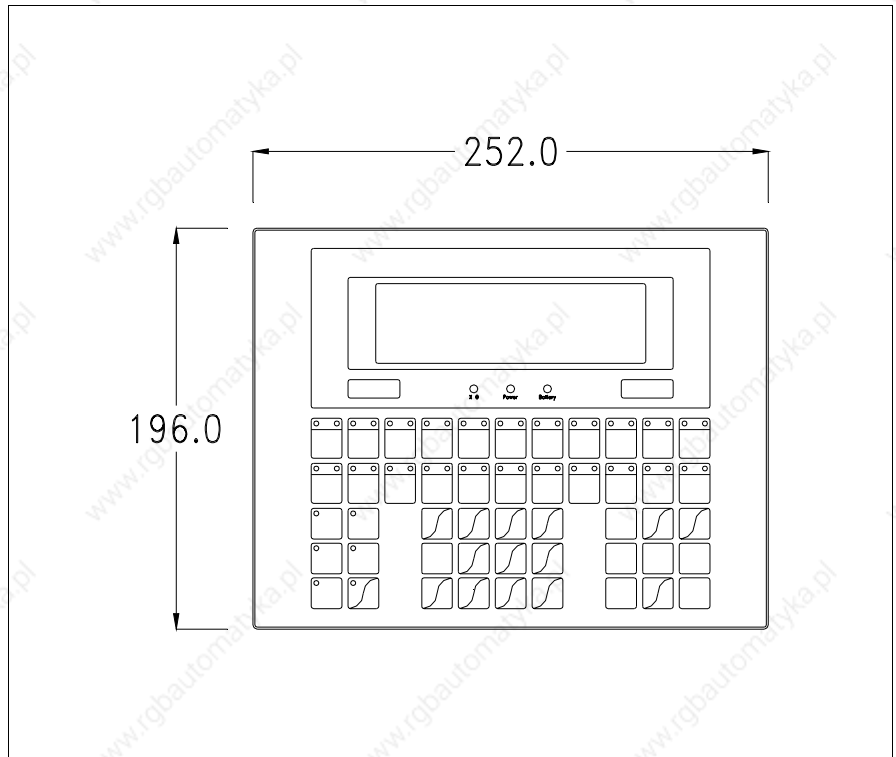

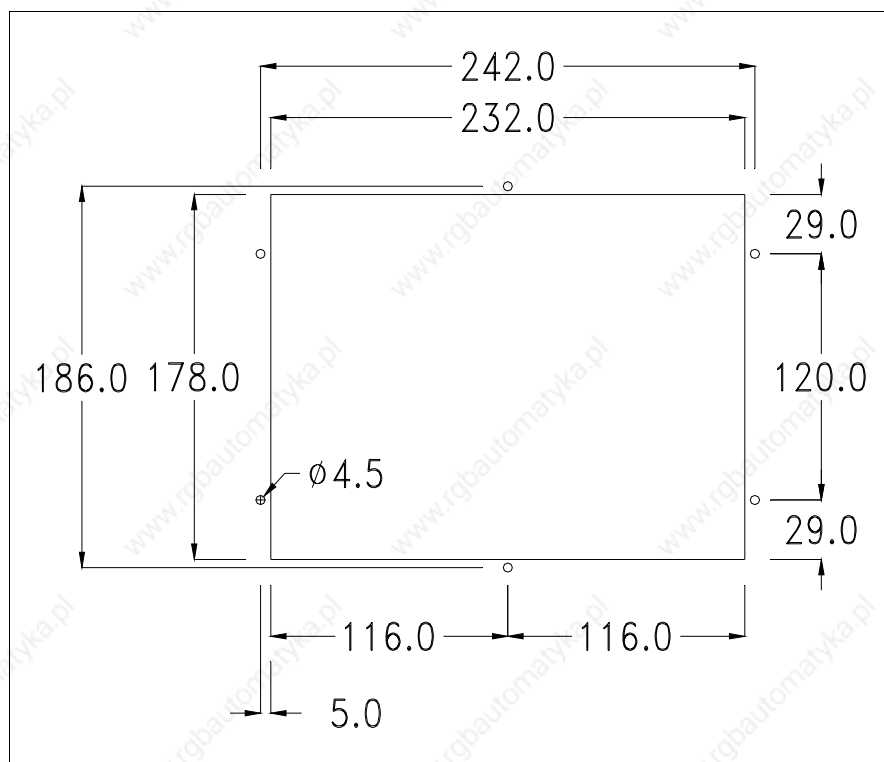

To fix the sealing gasket and secure the VT to the container see “Chapter 29 -> Mounting the terminal within the container“.

⚠ Where accessories need to be fixed in or onto the VT terminal, you are advised to do this before securing the VT to its container.

Accessories

Any accessories should be mounted in accordance with the instructions in the relevant chapter (see “Chapter 33 -> Video terminal accessories“).

Transfer PC -> VT

For everything to function properly, the first time the VT operator terminal is switched on it needs to be correctly loaded, that is it needs to have transferred to it:



- Firmware
- Communication driver
- Project

(Given that the transfer of the three files in practice occurs with a single operation, it will be defined as “Project transfer” for the sake of simplicity.)

For this it is essential that the VT be prepared to receive the transfer. (See also “Chapter 37 -> Command area“).

Preparation for reception

The program VTWIN (see Software Manual) must be used for the transfer, but the terminal must be set up to receive. This means carrying out the following steps:

- Check that the VT is off
- Check that there is a serial connection between the PC and the VT
- Switch on the VT with  pressed down or with the VT on press together  + ; in either case wait a moment

VT terminal with no Modem function:

- The following mask appears. Press the function  corresponding to the port to be used. The VT is now ready to receive (refer to Software Manual for transfer procedure)

```

Boot sequence forced
F1=   ASP down/up load
F2=   MSP down/up load
ENTER=run project

```

VT terminal with Modem function:

- Proceed from the preceding mask; the following mask appears

```

Boot sequence forced
F1=   MODEM dn/up load
F2=   PC dn/up load
ENTER=run project

```

- Choose the required transfer mode: MODEM if you intend to use a modem or PC if you intend to use a serial port; press the corresponding function 

If the choose made is PC, the VT is ready to receive (see Software Manual for transfer), if, on the other hand, you choose MODEM, the following mask will appear

```

Boot sequence forced
F1=    SLOW dn/up load
F2=    FAST dn/up load

```

The choice should be according to the speed you intend to use for the transfer (Slow=9600bit/sec or Fast=38400bit/sec), press the corresponding function . The VT is now ready to receive (see Software Manual for the transfer).

Information relating to driver

After the project has been transferred, the VT can make available information relating to what has been loaded. The information regards:

- The name of the driver loaded
- The version of the driver loaded
- Network address of the VT
- Last error to have occurred

To acquire this information carry out the following operations:

- Be situated in any page of the project
- Press  twice; you will see

```

VT190W
Serial: xxxxxxxxxxxxxx
Driver: xxxxxxxxxxxxxx
Ver.  : xxxxxxxxxxxxxx

```

- Press  or ; you will see

```







Addr. : xxxxxxxxxxxxxx
Error : xxxxxxxxxxxxxx
Up/Down = next page
Enter = settings page

```

If while displaying this page you press  you will access the page for setting the clock and the contrast

 **For the clock to be used properly, a special battery has to be inserted in the terminal (see “Chapter 33 -> Video terminal accessories“).**

CONTRAST:±####
 TIME: hh:mm:ss DATE: dd:mm:yy
 Left/Right = select. Up/Down = change
 ESC = project ENTER = memo

Left/Right is equivalent to  , Up/Down to  ; using  you quit display, while with  the settings are confirmed and you pass back to the project page.

Possible error messages are:

- PR ERR

Problem-> Errors have been detected in the data exchange between the VT and the Device.

Solution-> Check the cable; there may be disturbance.

- COM BROKEN

Problem-> Communication between VT and Device interrupted.

Solution-> Check the serial connection cable.

An error message followed by [*] indicates that the error is not currently present but was and has since disappeared.

Example: COM BROKEN*

By pressing  you pass back to the project page.

Adjusting the contrast on the display

To improve the quality of the representation on the display it may be necessary to adjust its contrast. This can be done by going to the page proposed (see Page 8-11) and changing the value (from +31 to -32) in evidence at that moment. Increase the value to darken the display; to lighten it decrease the value.

Chapter 9

Video terminal VT300W

Contents	Page
Technical characteristics	9-2
Functions	9-4
Front view	9-8
Customizing label	9-10
Standard series rear view	9-11
CAN series rear view	9-12
Dimensions and Cut-out	9-13
Accessories	9-14
Termination of CAN line	9-14
Transfer PC -> VT	9-15
Preparation for reception	9-15
Information relating to driver	9-17
Adjusting the contrast on the display	9-20

This chapter consists of 20 pages.

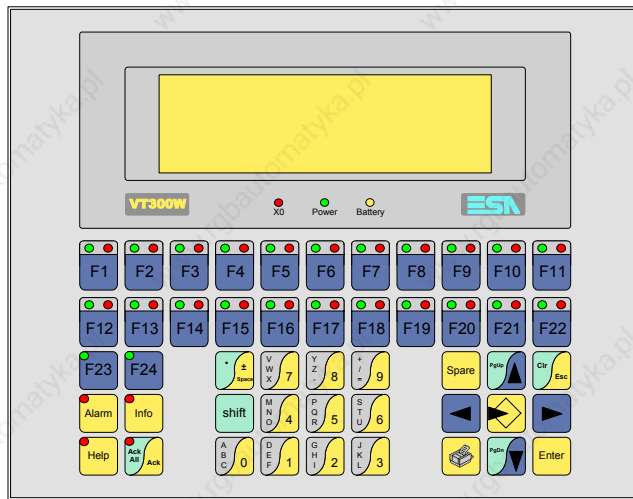

Technical characteristics

The following table lists the principal technical characteristics of the product in question.

Code of terminal	Characteristics of the terminal		
VT300W A000			
VT300W AP00			
VT300W 000CN			
Display		▼	▼
Type	LCD monochromatic STN	●	●
	LCD 16 Colors STN		
	LCD 16 Colors TFT		
Representational format	Graphic	●	●
Resolution [pixels]	240 x 64	●	●
Rows by characters	8 x 40 / 4 x 20 / 2 x 10	●	●
Display area size [mm]	132 x 39	●	●
Character matrix in text mode [pixels]	6 x 8 / 12 x 16 / 24 x 32	●	●
Character size [mm] x 1 / x 2 / x 4	3,2 x 4,2 / 6,5 x 8,5 / 12,7 x 17	●	●
Contrast adjustment	Software	●	●
	Automatic compensation with temperature		
Character sets	Programmable fonts/TTF Windows ®	●	●
Backlighting			
Type	LED	●	●
	CCFL lamp		
Minimum lamp-life at 25°C [hours]	--		
Keyboard			
Non-customizable function keys	2	●	●
Customizable function keys	22	●	●
Function key LEDs	46	●	●
Alphanumeric keys	11	●	●
Operational keys	14	●	●
Operational key LEDs	4	●	●
Diagnostic LEDs	3	●	●

Code of terminal	Characteristics of the terminal		
VT300W A000			
VT300W AP000			
VT300W 000CN			
User memory			
Project [Bytes]	192K + 384K (Text+ Graphics)	●	● ●
Data memory [Bytes]	128K (With back-up battery)	●	● ●
Memory for Windows ® -based fonts [Byte]	64K	●	● ●
Memory Card for backup	4Mb	●	● ●
Memory Card for expansion	--		
Interfaces			
MSP (Multi-serial port)	RS232/RS422/RS485/TTY-20mA	●	● ●
ASP (Auxiliary serial port)	RS232/RS485		● ●
ASP-15L (Auxiliary serial port)	RS232/RS485		● ●
ASP-8 (Auxiliary serial port)	RS232		
ASP-9 (Auxiliary serial port)	RS232		
LPT parallel port	Centronics		●
Auxiliary port	Connection for accessory devices	●	● ●
Accessories			
Connectable accessories	See table "Chapter 33"	●	● ●
Clock			
Clock	Hardware (With back-up battery)	●	● ●
Networks			
Integrated	Profibus-DP		
	CAN Open (Optoisolated interface)	●	
	Ethernet 10/100Mbit RJ45		
Universal Bus Connector	--		
Optional	See table "Chapter 33"	●	● ●
Proprietary networks			
ESA-Net	Network server	●	● ●
	Network client	●	● ●
Technical data			
Power supply	24Vdc (18..32Vdc)		
Power absorbed at 24Vdc	11W		
Protection fuse	Ø5x20mm - 800mA Quick Blow F		
Protection level	IP65 (front-end)		
Operating temperature	0..50°C		
Storage and transportation temperature	-20..+60°C		
Humidity (non-condensing)	<85%		
Weight	1500gr		
Dimensions			
External W x H x D [mm]	252 x 196 x 60		
Cut-out W x H [mm]	232 x 178		
Certification			
Certifications and approvals	CE, cULus, NEMA12		

Functions

The following table lists in alphabetical order all the functions of the VT in question.

Table 9.1: Functions and objects realizable with this VT (Part 1 of 4)

Code of terminal		
VT300W *****		
Objects/Functions	Quantity	▼
Alarm field		●
Alarm help	1024	●
Alarm history buffer	256	●
Alarm statistics		
Alarms (Total/active simultaneously)	1024/256	●
Arc		●
Automatic operations	32	●
Backup/Restore		●
Bar data		●
Bit-wise password	8bits	●
Buttons		
Circles		●
Command: Change language		●
Command: Clear trend buffer		●
Command: Delete recipe		●
Command: Hardcopy		●
Command: Load recipe from data memory		●
Command: Modify password		●
Command: Next page		
Command: Page help		●
Command: Password login		●
Command: Password logout		●
Command: Previous page		
Command: Print alarm history		●
Command: Printer form feed		●
Command: Quit project		●
Command: Report		●
Command: Restarts reading time-sampled trend		●
Command: Run pipeline		●
Command: Save alarms history and trend buffers in flash		
Command: Save recipe in data memory		●
Command: Save recipe received from device in buffer		●
Command: Save recipe received from device in data memory		●
Command: Send recipe from video buffer to device		●
Command: Send recipe to device		●
Command: Service page		●

Unless otherwise stated, there is no limit to the number of includable elements, only the size of project memory sets a limit.
*) indicative value determined by the dimensions of the project, **) depends on memory available

Table 9.1: Functions and objects realizable with this VT (Part 2 of 4)

Code of terminal		
VT300W *****		
Objects/Functions	Quantity	▼
Command: Show alarms history		●
Command: Show page directory		
Command: Show project information		●
Command: Show recipe directory		●
Command: Show sequence directory		●
Command: Shows driver status page		
Command: Shows page help		
Command: Shows page with function: PG		
Command: Stops reading time sampled trend		●
Command: Trend reading saved in device		●
Command: Zero number of general pages		●
Date field		●
Day-of-the-week field		●
Dynamic texts: Bit-group-structured dynamic texts	1024*	●
Dynamic texts: Single-bit dynamic texts		●
Dynamic texts: Value-structured dynamic texts		●
E-keys		●
Equations	32	●
F-keys		●
Free terminal		
Function: Disables key		●
Function: Go to page		
Function: Internal command		●
Function: Invert bit value		●
Function: Macro		●
Function: None		●
Function: Reset bit permanently		●
Function: Reset real-time bit		●
Function: Sequences		●
Function: Sets bit permanently		●
Function: Sets real-time bit		●
Function: Value-structure direct command		●
Global configuration of E-keys		●
Global configuration of F-keys		●
Headers and footers (Total/Number of fields per H-F)	128/128	●
Info-messages (Total/active simultaneously)	1024/256	●
Internal registers	4096bytes	●
Labels		●
LEDs assigned to sequence		●

Unless otherwise stated, there is no limit to the number of includable elements, only the size of project memory sets a limit.
 *) indicative value determined by the dimensions of the project, **) depends on memory available

Table 9.1: Functions and objects realizable with this VT (Part 3 of 4)

Code of terminal		
VT300W *****		
Objects/Functions	Quantity	▼
Lines		●
Lists of bitmap images		●
Lists of texts		●
Local configuration of E-keys		●
Local configuration of F-keys		●
Macro field	16 x pages	
Macros (Total/Commands x macro)	1024/16	●
Message field		●
Message help	1024	●
Multilanguage texts	8 Langs.	●
Object - Indicator		
Object - Potentiometer knob		
Object - Selector knob		
Object - Sliding potentiometer		
Object - Sliding selector		
Page	1024	●
Page help	1024	●
Password	10	●
Pipelines (Numero/Tot bytes)	64/512	●
Print		●
Print page (Total/Number of fields per page)	1024/128	●
Programmable fonts		●
Project images		●
Public variables of ESANET network (Number/Tolat bytes)	256/1024	●
Recipe field for recipe structure		●
Recipes (Number of variables per recipe)	1024/256	●
Rectangles		●
Redefinable characters		
Reports	128	●
Sequences - Random		●
Sequences - Start/stop	128	●
Static bitmaps		●
Symbolic field: Bit-group-structured dynamic bitmaps		●
Symbolic field: Single-bit-structured dynamic bitmaps	1024*	●
Symbolic field: Value-structured dynamic bitmaps		●
System messages		●
System variables assigned to recipe structure		●
Time long field		●
Time short field		●

Unless otherwise stated, there is no limit to the number of includable elements, only the size of project memory sets a limit.
 *) indicative value determined by the dimensions of the project, **) depends on memory available



Table 9.1: Functions and objects realizable with this VT (Part 4 of 4)





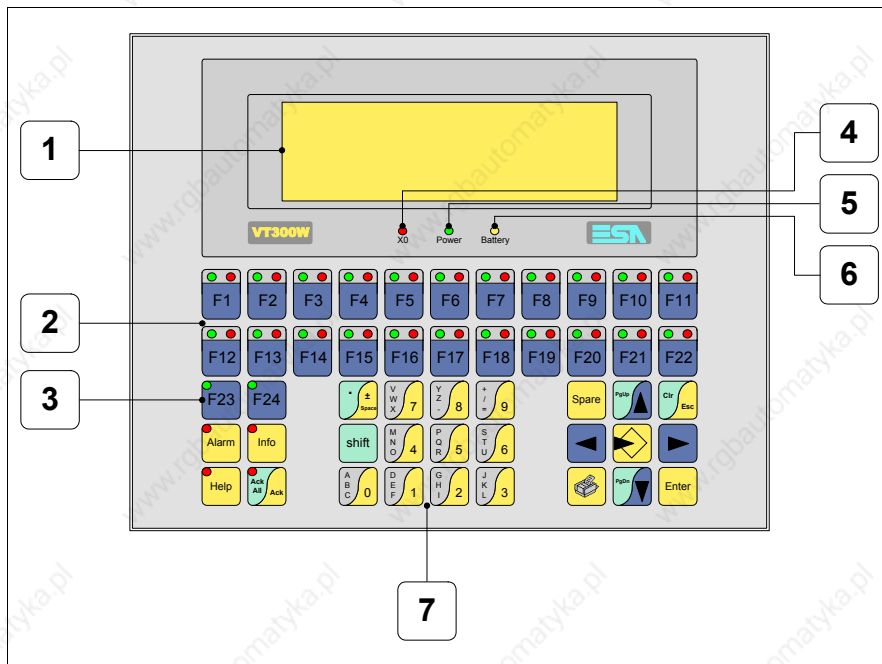





Code of terminal		
VT300W ****		
Objects/Functions	Quantity	▼
Timer	16	●
Touch Area		
Trend buffers	128	●
Trends (Trends x page/Channels x trend)	2/2	●
Trends sampled automatically (Memory/Trends/Readings)	512bytes	●
Trends sampled on command (Memory/Trends/Readings)	/**/240	●
Value direct command: ADD		●
Value direct command: AND		●
Value direct command: OR		●
Value direct command: SET		●
Value direct command: SUBTRACT		●
Value direct command: XOR		●
Variables: Limit values and linear scaling variables	80 x pages	●
Variables: Movement variable (Mobile symbolic field)		●
Variables: Threshold variables		●
Variables: Floating Point numerical variables		●
Variables: Numerical variables (DEC, HEX, BIN, BCD)		●
Variables: String variables (ASCII)		●
		●

Unless otherwise stated, there is no limit to the number of includable elements, only the size of project memory sets a limit.
 *) indicative value determined by the dimensions of the project, **) depends on memory available

Front view

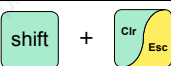
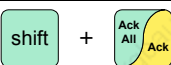

Key	Function
1	Display
2	F-keys with two LEDs
3	F-keys with one LED
4	X0 LED. Blinks when communication error is detected
5	Power LED. Lights up when power in ON
6	Battery LED. Lights up when the battery has nearly run out
7	Alphanumeric keys
	Starts input
	Confirms setting of data
	Page up When in setting phase, edits dynamic text

Key	Function
	Page down When in setting phase, edits dynamic text
	Moves the cursor between settable fields When in setting phase, moves cursor to the left of the field
	Moves the cursor between settable fields When in setting phase, moves cursor to the right of the field
	Quits: setting of data, info-messages, sequence directory, communication driver
	Displays info-messages
	Displays ISA alarms
	Displays according to context: information message help, alarm help or page help
	Acknowledgment of ISA alarms on display
	Print the entire display area
	No predefined function
	In setting phase restores the initial value of the field
	Acknowledges all ISA alarms

Customizing label

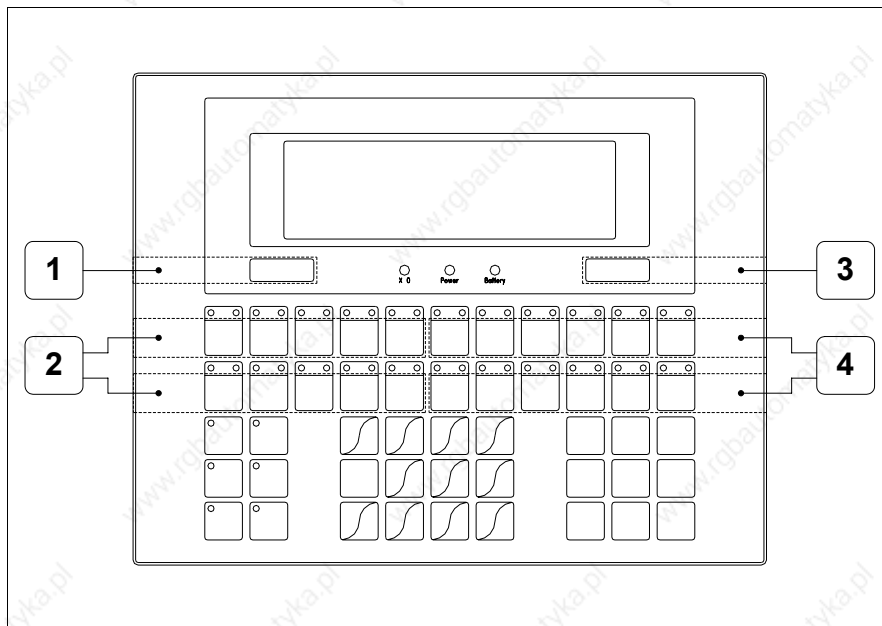

Position	Function - Dimensions L x H (mm)
1	ESA Logo - 73 x 10
2	F-key customization F1... F5, F12... F16 - 116 x 15
3	VT Model - 73 x 10
4	F-key customization F6... F11, F17... F22 - 134 x 15



The total thickness of the label must not exceed 125µm (micrometers). Do not use either stiff materials or glues.



Before starting to insert the customized label, see “Chapter 28 -> Inserting customized labels“.

Standard series rear view

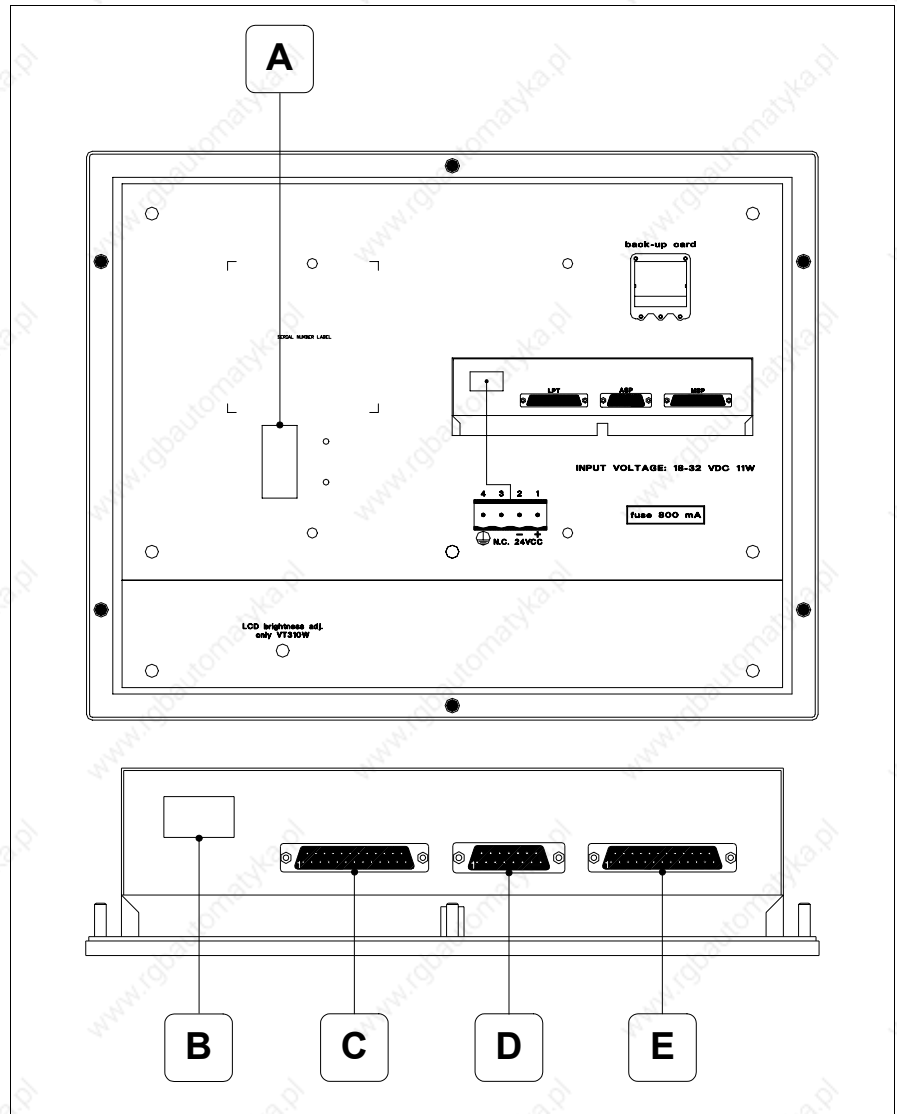

Position	Function
A	Auxiliary port for connecting optional accessories
B	Power supply connector
C	LPT port for connecting printer (Optional)
D	ASP serial port for communicating with PC or other devices
E	MSP serial port for communicating with PLC/PC

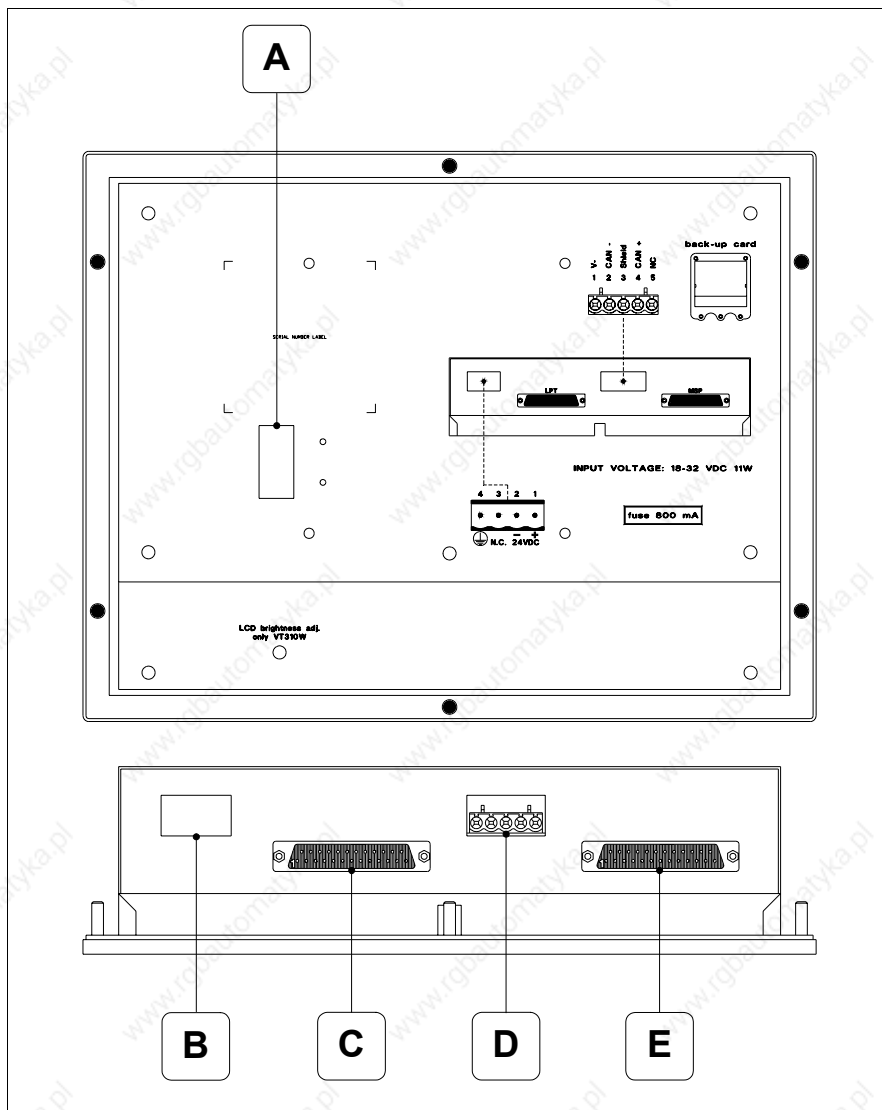
**CAN series
rear view**

Position	Function
A	Auxiliary port for connecting optional accessories
B	Power supply connector
C	LPT port for connecting printer (Optional)
D	CAN serial port
E	MSP serial port for communicating with PLC/PC

Dimensions and Cut-out

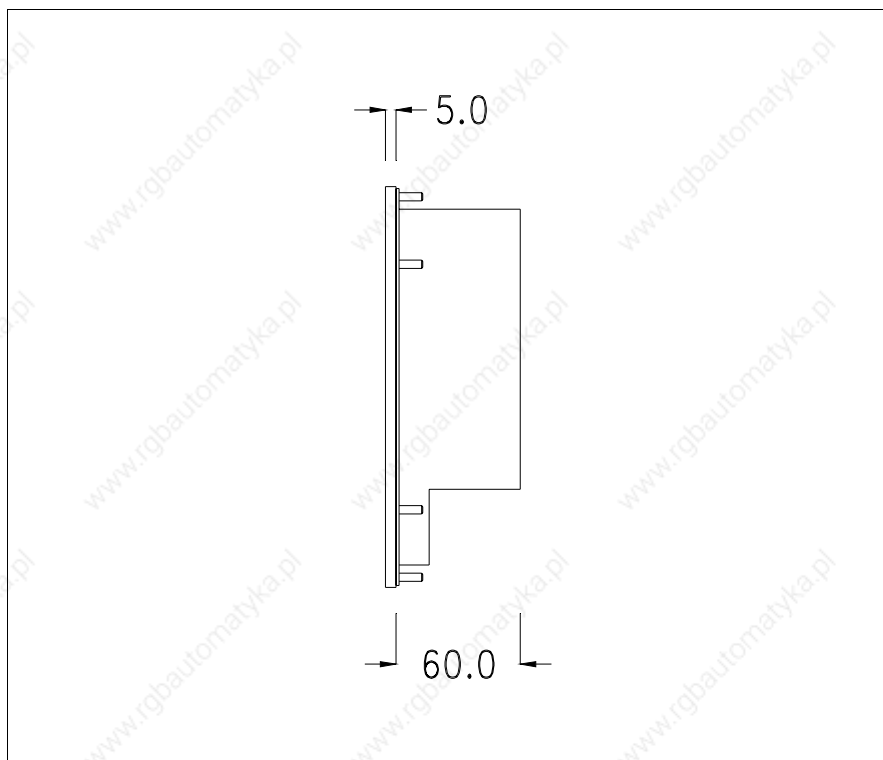
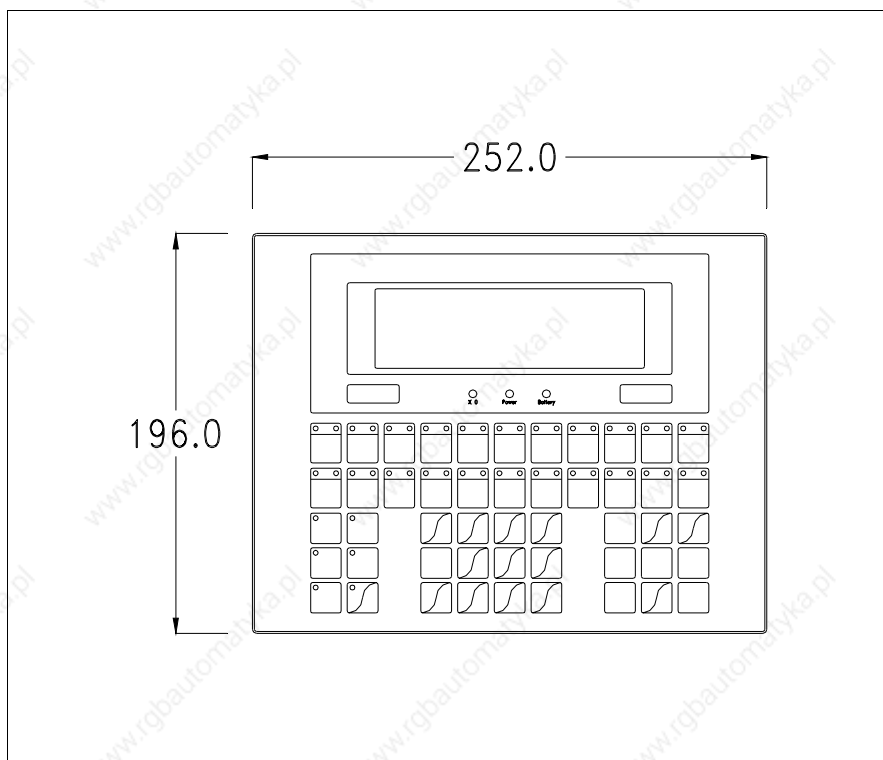

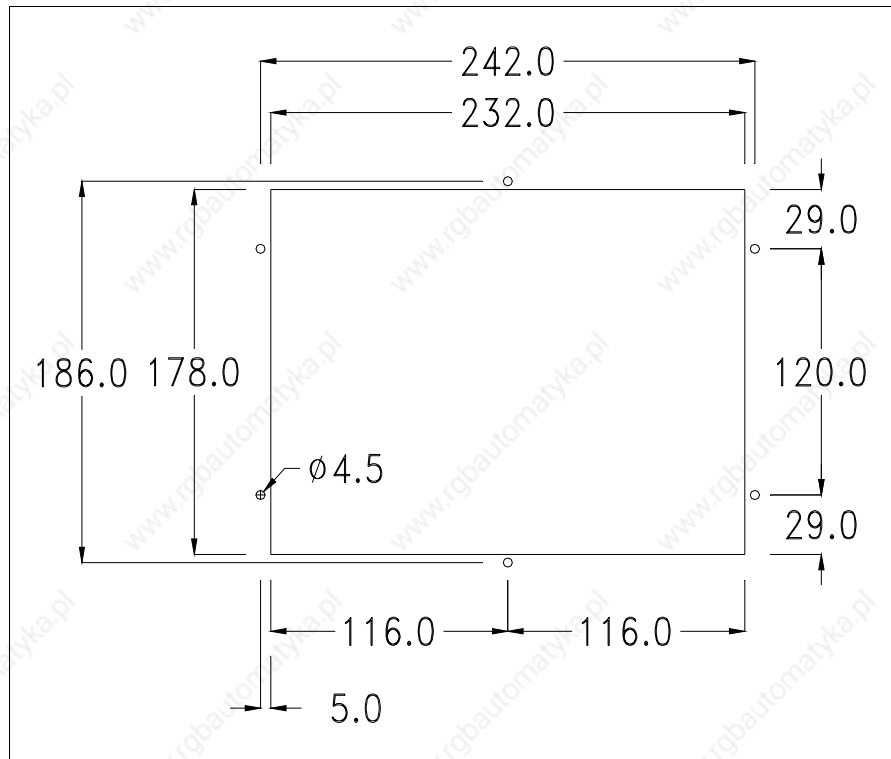

To fix the sealing gasket and secure the VT to the container see “Chapter 29 -> Mounting the terminal within the container“.



Where accessories need to be fixed in or onto the VT terminal, you are advised to do this before securing the VT to its container.

Accessories

Any accessories should be mounted in accordance with the instructions in the relevant chapter (see “Chapter 33 -> Video terminal accessories“).

Termination of CAN line

This paragraph applies only to the CAN series. The VT in question integrates the termination resistances of the serial line (typically 120 ohms) which can be inserted by means of a jumper (preset on 1-2, line not terminated). To activate the termination:

- Make sure the device is not connected to the power supply.
- Remove the cover.
- Identify the jumper unit J6.

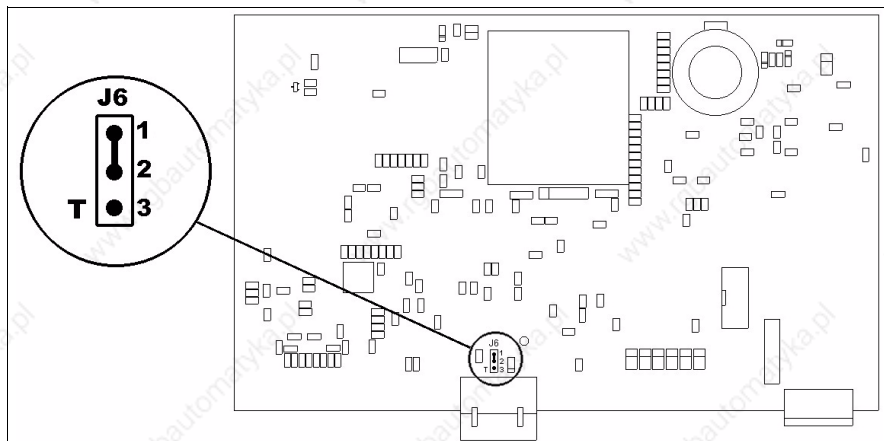

- Position the jumper between pins 2 and 3 (line terminated).
- Replace the back cover.
- Reconnect the power supply.

Transfer PC -> VT

For everything to function properly, the first time the VT operator terminal is switched on it needs to be correctly loaded, that is it needs to have transferred to it:



- Firmware
- Communication driver
- Project

(Given that the transfer of the three files in practice occurs with a single operation, it will be defined as “Project transfer” for the sake of simplicity.)

For this it is essential that the VT be prepared to receive the transfer. (See also “Chapter 37 -> Command area”).

Preparation for reception

The program VTWIN (see Software Manual) must be used for the transfer, but the terminal must be set up to receive. This means carrying out the following steps:

- Check that the VT is off
- Check that there is a serial connection between the PC and the VT
- Switch on the VT with  pressed down or with the VT on press together  + ; in either case wait a moment

VT terminal with no Modem function:

- The following mask appears.  F3=MemoCARD is only enabled when a

Memory Card has been inserted in the VT terminal (see Page 9-18). The function to press depends on which port you intend to use (MSP or ASP). The VT is now ready to receive (refer to Software Manual for transfer procedure)

VT300 TRANSFER PAGE

Graphic controller BOOT check : OK
Graphic controller RAM check : OK

F1=ASP F2=MSP F3=MemoCARD ENTER=Prj

VT terminal with Modem function:

- Proceed from the preceding mask; the following mask appears

VT300 TRANSFER PAGE

Graphic controller BOOT check : OK
Graphic controller RAM check : OK

F1=MODEM F2=PC ENTER=Prj

- Choose the required transfer mode: **MODEM** if you intend to use a modem or **PC** if you intend to use a serial port; press the corresponding function

If the choice made is **PC**, the VT is ready to receive (see Software Manual for transfer), if, on the other hand, you choose **MODEM**, the following mask will appear

VT300 TRANSFER PAGE

Graphic controller BOOT check : OK
Graphic controller RAM check : OK

F1=SLOW F2=FAST

The choice should be according to the speed you intend to use for the transfer (Slow=9600bit/sec or Fast=38400bit/sec), press the corresponding function . The VT is now ready to receive (see Software Manual for the transfer).

Information relating to driver

After the project has been transferred, the VT can make available information relating to what has been loaded. The information regards:

- Serial ports present
- The name of the driver loaded
- The version of the driver loaded
- Network address of the VT
- Last error to have occurred

To acquire this information carry out the following operations:

- Be situated in any page of the project
- Press  twice; you will see

```

Port      : xxxxxxxxxxxxxxxxxxxxxxxx
Driver    : xxxxxxxxxxxxxxxxxxxxxxxx
Ver       : xxxxxxxxxxxxxxxxxxxxxxxx
Addr VT   : xxxxxxxxxxxxxxxxxxxxxxxx
Error     : xxxxxxxxxxxxxxxxxxxxxxxx

Right=next page  Enter=settings page
  
```



There is one of these pages for each communication port; you can move between the various pages by pressing .

If you press  while displaying this page you can access the page for setting the clock and the contrast.



```



  ──▶  SET CONTRAST : ±##
       SET CLOCK :
       ddd,dd/mm/yy
       hh:mm:ss

Right=next page  Enter=set
  
```

In order to access the contrast setting, use  or  to select the SET CONTRAST option that is displayed in reverse colors and press ; the following mask will appear:









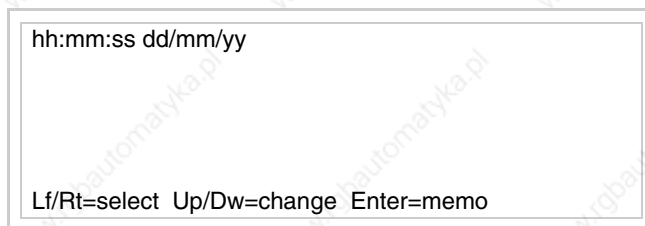

Use  and/or  to effect any variation and  for the confirmation.

To be able to set the clock use  or  to select the SET CLOCK option that is displayed in reverse colors and press ; the following mask will appear:

 **For the clock to be used properly, a special battery has to be inserted in the terminal (see "Chapter 33 -> Video terminal accessories").**



Use  and/or  to select the field and  and/or  to effect any variation; use  to confirm.

To use the Memory Card either switch on the VT with  held down or, if the VT is already on, press  +  together; in both cases it will be necessary to wait a moment before the following mask appears on the VT:

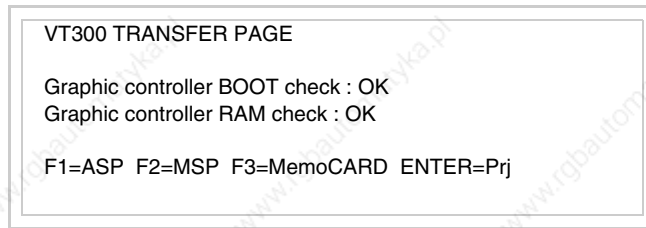

Press  F3=MemoCARD (if the key is not on screen, see Page 9-15) and the following mask will appear:

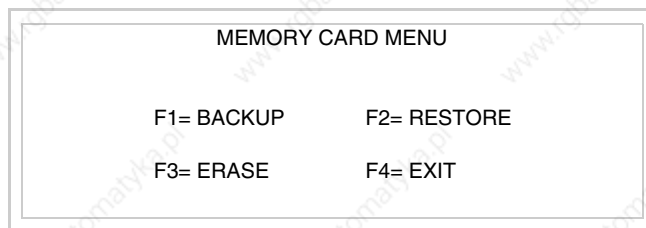

For the meaning and function of the keys see “Chapter 33 -> Memory card”.

Possible error messages are:

- PR ERR

Problem-> Errors have been detected in the data exchange between the VT and the Device.

Solution-> Check the cable; there may be disturbance.

- COM BROKEN

Problem-> Communication between VT and Device interrupted.

Solution-> Check the serial connection cable.

An error message followed by [*] indicates that the error is not currently present but was and has since disappeared.

Example: COM BROKEN*

When  is pressed you quit the display of information regarding the driver.

Adjusting the contrast on the display

To improve the quality of the representation on the display it may be necessary to adjust its contrast. This can be done by going to the page proposed (see Page 9-17) and changing the value (from +31 to -32) in evidence at that moment. Increase the value to darken the display; to lighten it decrease the value.

Chapter 10 Video terminal VT310W

Contents	Page
Technical characteristics	10-2
Functions	10-4
Front view	10-8
Customizing label	10-10
Rear view	10-11
Dimensions and Cut-out	10-13
Accessories	10-14
Transfer PC -> VT	10-14
Preparation for reception	10-15
Information relating to driver	10-16
Adjusting the contrast on the display	10-20

This chapter consists of 20 pages.

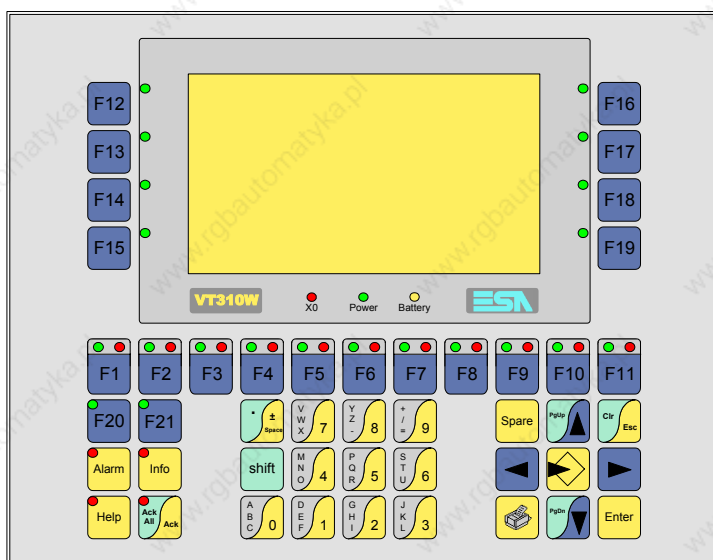

Technical characteristics

The following table lists the principal technical characteristics of the product in question.

Code of terminal	Characteristics of the terminal	
VT310W A000		
VT310W AP00		
Display		
Type	LCD monochromatic STN	● ●
	LCD 16 Colors STN	
	LCD 16 Colors TFT	
Representational format	Graphic	● ●
Resolution [pixels]	240 x 128 (5,5")	● ●
Rows by characters	16 x 40 / 8 x 20 / 4 x 10	● ●
Display area size [mm]	123 x 68	● ●
Character matrix in text mode [pixels]	6 x 8 / 12 x 16 / 24 x 32	● ●
Character size [mm] x 1 / x 2 / x 4	3 x 4 / 6 x 8 / 12 x 16	● ●
Contrast adjustment	Software	● ●
	Automatic compensation with temperature	
Character sets	Programmable fonts/TTF Windows ®	● ●
Backlighting		
Type	LED	
	CCFL lamp	● ●
Minimum lamp-life at 25°C [hours]	10000	● ●
Keyboard		
Non-customizable function keys	10	● ●
Customizable function keys	11	● ●
Function key LEDs	32	● ●
Alphanumeric keys	11	● ●
Operational keys	14	● ●
Operational key LEDs	4	● ●
Diagnostic LEDs	3	● ●

Code of terminal	Characteristics of the terminal	
VT310W A000		
VT310W AP000		
User memory		
Project [Bytes]	192K + 384K (Text + Graphics)	● ●
Data memory [Bytes]	128K (With back-up battery)	● ●
Memory for Windows ® -based fonts [Byte]	64K	● ●
Memory Card for backup	4Mb	● ●
Memory Card for expansion	--	
Interfaces		
MSP (Multi-serial port)	RS232/RS422/RS485/TTY-20mA	● ●
ASP (Auxiliary serial port)	RS232/RS485	● ●
ASP-15L (Auxiliary serial port)	RS232/RS485	
ASP-8 (Auxiliary serial port)	RS232	
ASP-9 (Auxiliary serial port)	RS232	
LPT parallel port	Centronics	●
Auxiliary port	Connection for accessories	● ●
Accessories		
Connectable accessories	See table "Chapter 33"	● ●
Clock		
Clock	Hardware (With back-up battery)	● ●
Networks		
Integrated	Profibus-DP	
	CAN Open (Optoisolated interface)	
	Ethernet 10/100Mbit RJ45	
Universal Bus Connector	--	
Optional	See table "Chapter 33"	● ●
Proprietary networks		
ESA-Net	Network server	● ●
	Network client	● ●
Technical data		
Power supply	24Vdc (18..32Vdc)	
Power absorbed at 24Vdc	11W	
Protection fuse	Ø5x20mm - 800mA Quick Blow F	
Protection level	IP65 (front-end)	
Operating temperature	0..50°C	
Storage and transportation temperature	-20..+60°C	
Humidity (non-condensing)	<85%	
Weight	1500gr	
Dimensions		
External W x H x D [mm]	252 x 196 x 60	
Cut-out W x H [mm]	232 x 178	
Certification		
Certifications and approvals	CE, cULus, NEMA12	

Functions

The following table lists in alphabetical order all the functions of the VT in question.

Table 10.1: Functions and objects realizable with this VT (Part 1 of 4)

Code of terminal		
VT310W *****	Objects/Functions	Quantity
Alarm field		●
Alarm help	1024	●
Alarm history buffer	256	●
Alarm statistics		
Alarms (Total/active simultaneously)	1024/256	●
Arc		●
Automatic operations	32	●
Backup/Restore		●
Bar data		●
Bit-wise password	8bits	●
Buttons		
Circles		●
Command: Change language		●
Command: Clear trend buffer		●
Command: Delete recipe		●
Command: Hardcopy		●
Command: Load recipe from data memory		●
Command: Modify password		●
Command: Next page		
Command: Page help		●
Command: Password login		●
Command: Password logout		●
Command: Previous page		
Command: Print alarm history		●
Command: Printer form feed		●
Command: Quit project		●
Command: Report		●
Command: Restarts reading time-sampled trend		●
Command: Run pipeline		●
Command: Save alarms history and trend buffers in flash		
Command: Save recipe in data memory		●
Command: Save recipe received from device in buffer		●
Command: Save recipe received from device in data memory		●
Command: Send recipe from video buffer to device		●
Command: Send recipe to device		●
Command: Service page		●

Unless otherwise stated, there is no limit to the number of includable elements, only the size of project memory sets a limit.
*) indicative value determined by the dimensions of the project, **) depends on memory available

Table 10.1: Functions and objects realizable with this VT (Part 2 of 4)

Code of terminal		
VT310W *****		
Objects/Functions	Quantity	▼
Command: Show alarms history		●
Command: Show page directory		
Command: Show project information		●
Command: Show recipe directory		●
Command: Show sequence directory		●
Command: Shows driver status page		
Command: Shows page help		
Command: Shows page with function: PG		
Command: Stops reading time sampled trend		●
Command: Trend reading saved in device		●
Command: Zero number of general pages		●
Date field		●
Day-of-the-week field		●
Dynamic texts: Bit-group-structured dynamic texts		●
Dynamic texts: Single-bit dynamic texts	1024*	●
Dynamic texts: Value-structured dynamic texts		●
E-keys		●
Equations	32	●
F-keys		●
Free terminal		
Function: Disables key		●
Function: Go to page		
Function: Internal command		●
Function: Invert bit value		●
Function: Macro		●
Function: None		●
Function: Reset bit permanently		●
Function: Reset real-time bit		●
Function: Sequences		●
Function: Sets bit permanently		●
Function: Sets real-time bit		●
Function: Value-structure direct command		●
Global configuration of E-keys		●
Global configuration of F-keys		●
Headers and footers (Total/Number of fields per H-F)	128/128	●
Info-messages (Total/active simultaneously)	1024/256	●
Internal registers	4096bytes	●
Labels		●
LEDs assigned to sequence		●

Unless otherwise stated, there is no limit to the number of includable elements, only the size of project memory sets a limit.
 *) indicative value determined by the dimensions of the project, **) depends on memory available

Table 10.1: Functions and objects realizable with this VT (Part 3 of 4)

Code of terminal		
VT310W *****		
Objects/Functions	Quantity	
Lines		●
Lists of bitmap images		●
Lists of texts		●
Local configuration of E-keys		●
Local configuration of F-keys		●
Macro field		
Macros (Total/Commands x macro)	1024/16	●
Message field		●
Message help	1024	●
Multilanguage texts	8 Langs.	●
Object - Indicator		
Object - Potentiometer knob		
Object - Selector knob		
Object - Sliding potentiometer		
Object - Sliding selector		
Page	1024	●
Page help	1024	●
Password	10	●
Pipelines (Numero/Tot bytes)	64/512	●
Print		●
Print page (Total/Number of fields per page)	1024/128	●
Programmable fonts		●
Project images		●
Public variables of ESANET network (Number/Tolat bytes)	256/1024	●
Recipe field for recipe structure		●
Recipes (Number of variables per recipe)	1024/256	●
Rectangles		●
Redefinable characters		
Reports	128	●
Sequences - Random	128	●
Sequences - Start/stop		●
Static bitmaps		●
Symbolic field: Bit-group-structured dynamic bitmaps	1024*	●
Symbolic field: Single-bit-structured dynamic bitmaps		●
Symbolic field: Value-structured dynamic bitmaps		●
System messages		●
System variables assigned to recipe structure		●
Time long field		●
Time short field		●

Unless otherwise stated, there is no limit to the number of includable elements, only the size of project memory sets a limit.
*) indicative value determined by the dimensions of the project, **) depends on memory available

Table 10.1: Functions and objects realizable with this VT (Part 4 of 4)







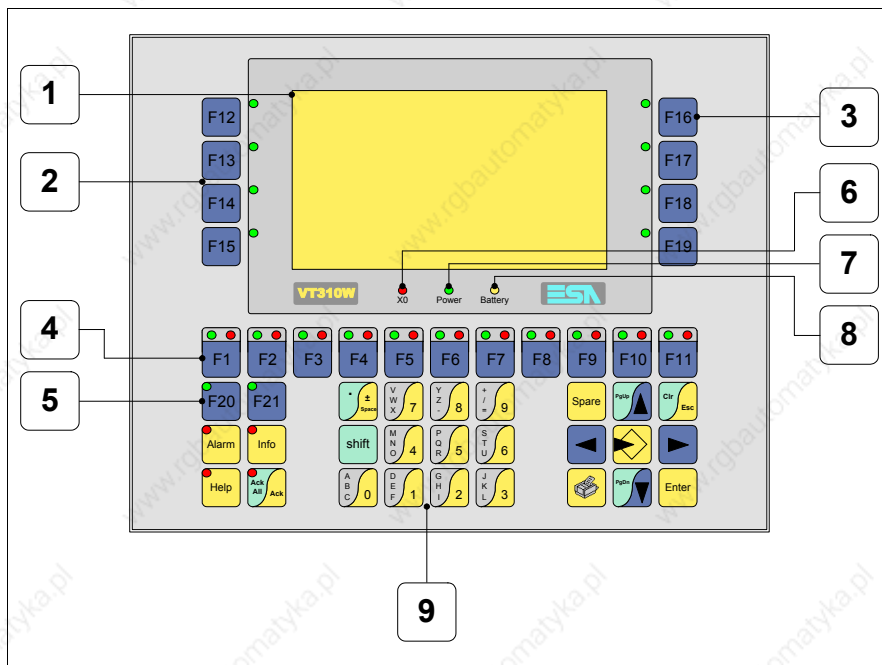







Code of terminal		
VT310W ****		
Objects/Functions	Quantity	▼
Timer	16	●
Touch Area		
Trend buffers	128	●
Trends (Trends x page/Channels x trend)	4/4	●
Trends sampled automatically (Memory/Trends/Readings)	512bytes	●
Trends sampled on command (Memory/Trends/Readings)	/**/240	●
Value direct command: ADD		●
Value direct command: AND		●
Value direct command: OR		●
Value direct command: SET		●
Value direct command: SUBTRACT		●
Value direct command: XOR		●
Variables: Limit values and linear scaling variables	96 x pages	●
Variables: Movement variable (Mobile symbolic field)		●
Variables: Threshold variables		●
Variables: Floating Point numerical variables		●
Variables: Numerical variables (DEC, HEX, BIN, BCD)		●
Variables: String variables (ASCII)		●
		●

Unless otherwise stated, there is no limit to the number of includable elements, only the size of project memory sets a limit.
 *) indicative value determined by the dimensions of the project, **) depends on memory available

Front view



Key	Function
1	Display
2	F-keys with one LED
3	F-keys with one LED
4	F-keys with two LEDs
5	F-keys with one LED
6	X0 LED. Blinks when communication error is detected
7	Power LED. Lights up when power in ON
8	Battery LED. Lights up when the battery has nearly run out
9	Alphanumeric keys
	Starts input

Key	Function
	Confirms setting of data
	Page up When in setting phase, edits dynamic text
	Page down When in setting phase, edits dynamic text
	Moves the cursor between settable fields When in setting phase, moves cursor to the left of the field
	Moves the cursor between settable fields When in setting phase, moves cursor to the right of the field
	Quits: setting of data, info-messages, sequence directory, communication driver
	Displays info-messages
	Displays ISA alarms
	Displays according to context: information message help, alarm help or page help
	Acknowledgment of ISA alarms on display
	Print the entire display area
	No predefined function
shift + 	In setting phase restores the initial value of the field
shift + 	Acknowledges all ISA alarms

Customizing label

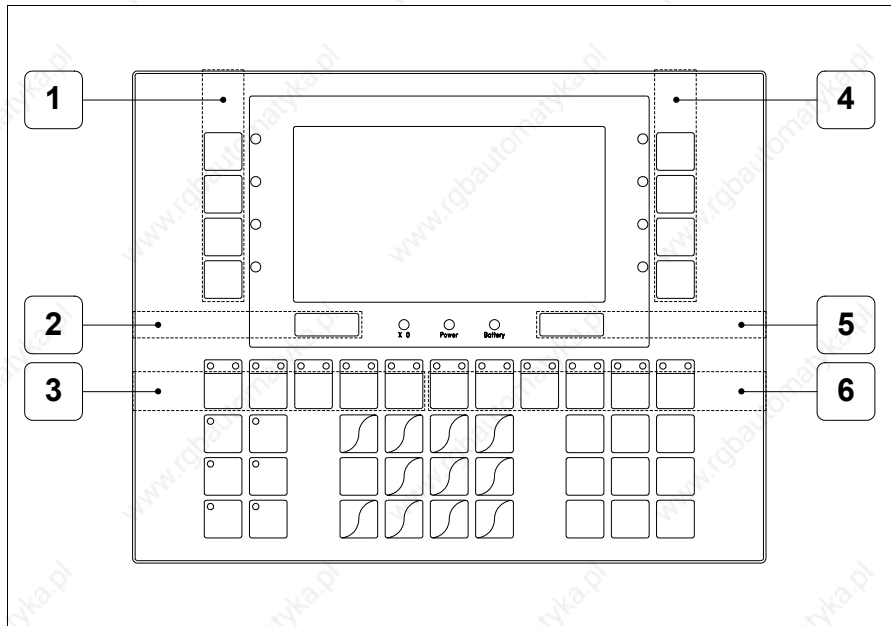

Position	Function - Dimensions L x H (mm)
1	F-key customization F - 16 x 92
2	ESA Logo - 91 x 10
3	F-key customization F1... F5 - 116 x 15
4	F-key customization F - 16 x 92
5	VT Model - 91 x 10
6	F-key customization F6... F11 - 134 x 15



The total thickness of the label must not exceed 125µm (micrometers). Do not use either stiff materials or glues.



Before starting to insert the customized label, see “Chapter 28 -> Inserting customized labels”.

Rear view

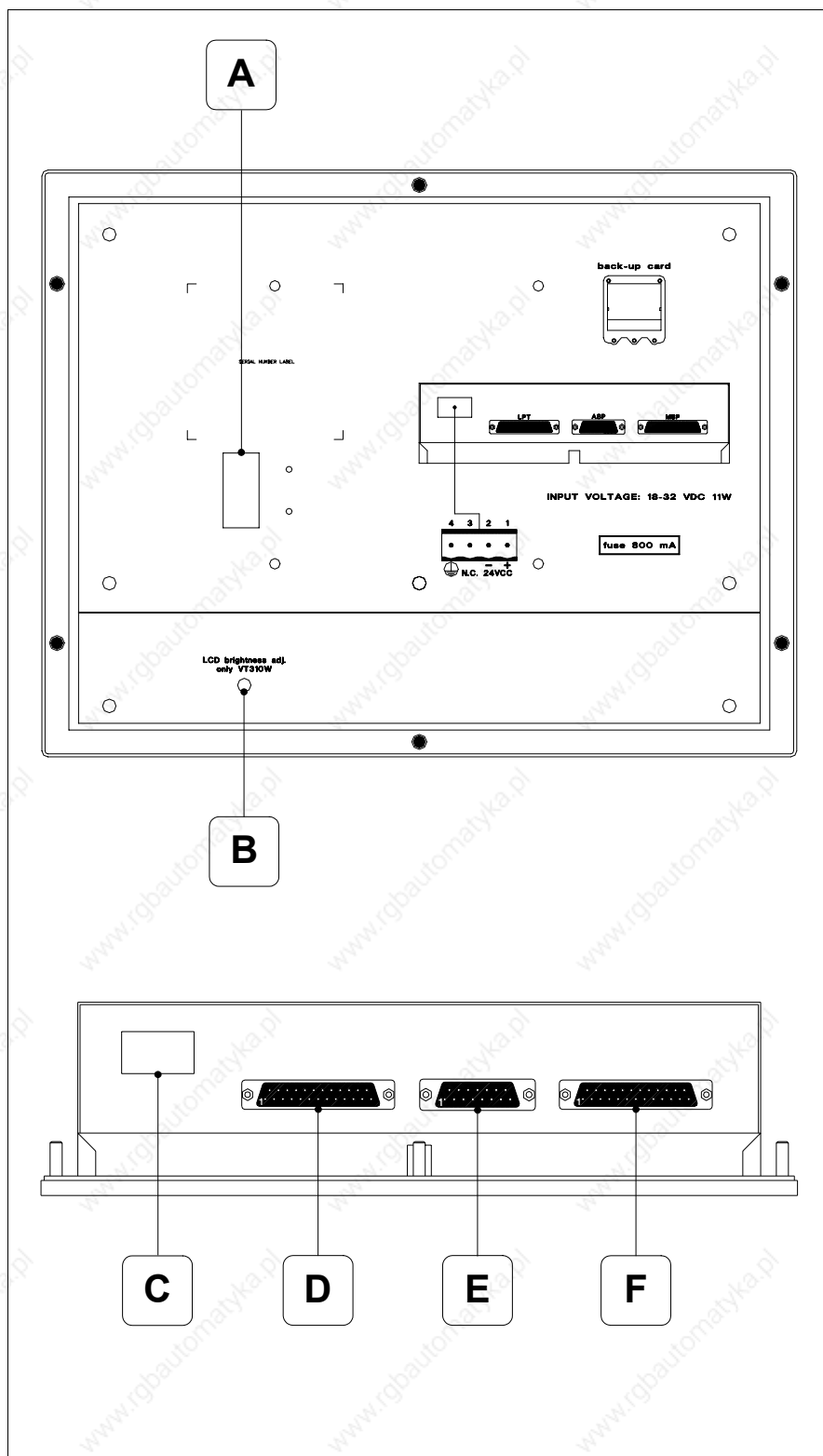

Position	Function
A	Auxiliary port for connecting optional accessories
B	Trimmer for brightness control
C	Power supply connector
D	LPT port for connecting printer (Optional)
E	ASP serial port for communicating with PC or other devices
F	MSP serial port for communicating with PLC/PC

Dimensions and Cut-out

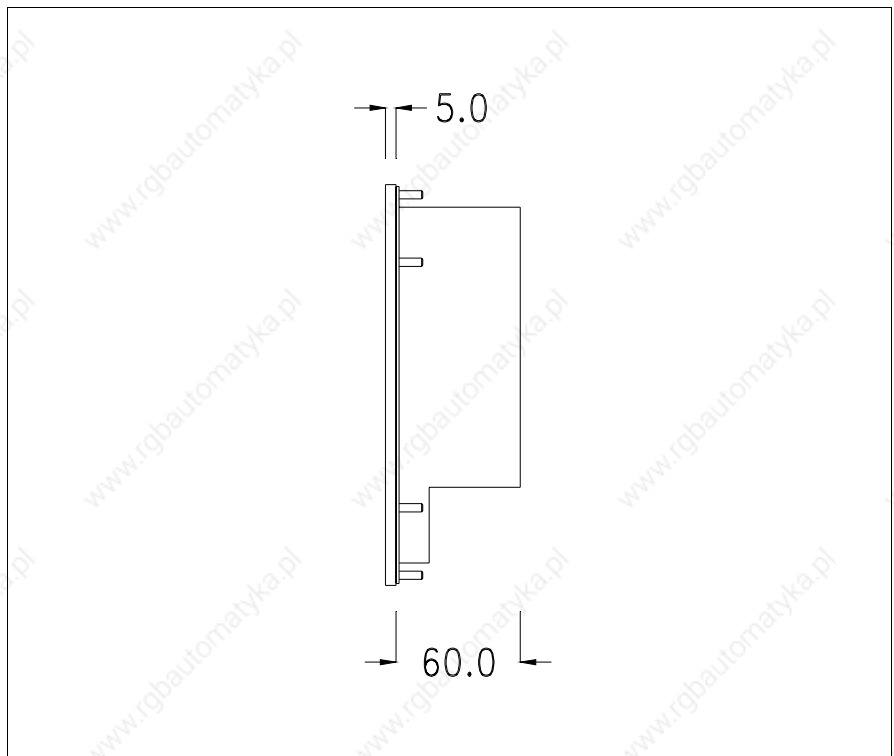
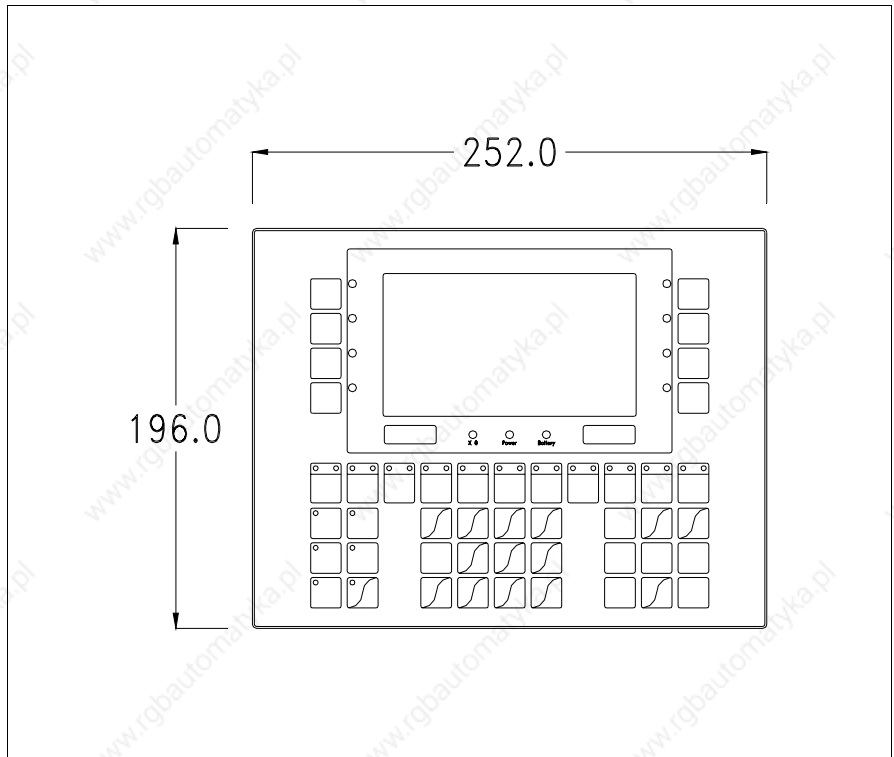

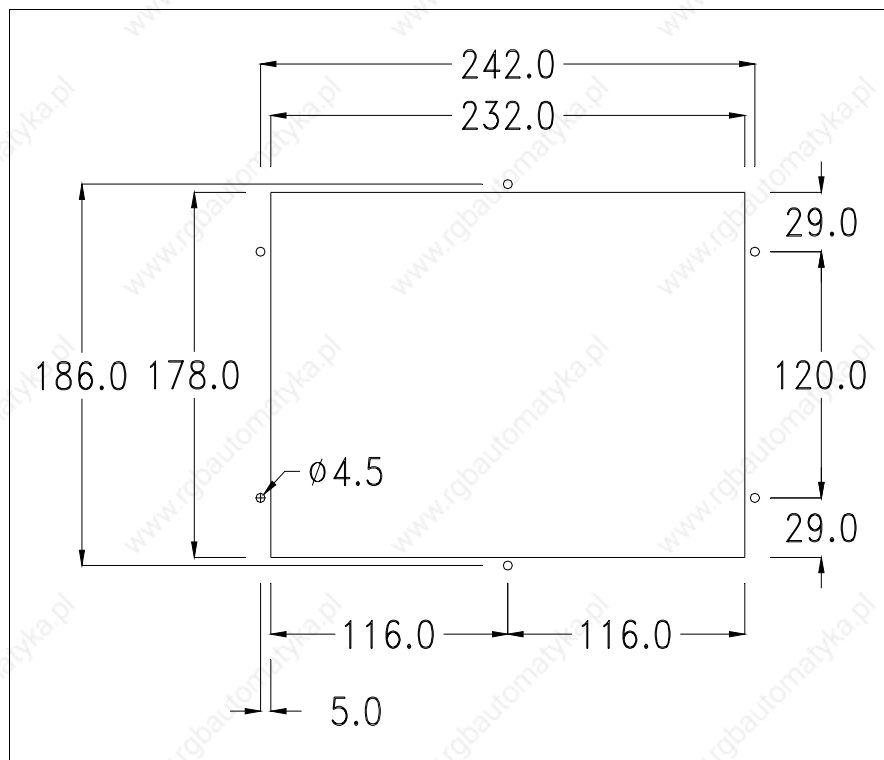

To fix the sealing gasket and secure the VT to the container see “Chapter 29 -> Mounting the terminal within the container“.

⚠ Where accessories need to be fixed in or onto the VT terminal, you are advised to do this before securing the VT to its container.

Accessories

Any accessories should be mounted in accordance with the instructions in the relevant chapter (see “Chapter 33 -> Video terminal accessories“).

Transfer PC -> VT

For everything to function properly, the first time the VT operator terminal is switched on it needs to be correctly loaded, that is it needs to have transferred to it:



- Firmware
- Communication driver
- Project

(Given that the transfer of the three files in practice occurs with a single operation, it will be defined as “Project transfer” for the sake of simplicity.)



For this it is essential that the VT be prepared to receive the transfer. (See also “Chapter 37 -> Command area“).

Preparation for reception

The program VTWIN (see Software Manual) must be used for the transfer, but the terminal must be set up to receive. This means carrying out the following steps:

- Check that the VT is off
- Check that there is a serial connection between the PC and the VT
- Switch on the VT with  pressed down or with the VT on press together  + ; in either case wait a moment

VT terminal with no Modem function:

- The following mask appears.  F3=MemoCARD is only enabled when a Memory Card has been inserted in the VT terminal (see Page 10-18). The function  to press depends on which port you intend to use (MSP or ASP). The VT is now ready to receive (refer to Software Manual for transfer procedure)

```

VT310 TRANSFER PAGE

Graphic controller BOOT check : OK
Graphic controller RAM check : OK

Graphic controller synchronization : OK

Main FIRMWARE check : NOT PRESENT
Graphic controller FIRMWARE : ERROR

F1=ASP F2=MSP F3=MemoCARD ENTER=Prj

```

VT terminal with Modem function:

- Proceed from the preceding mask; the following mask appears

```

VT310 TRANSFER PAGE

Graphic controller BOOT check : OK
Graphic controller RAM check : OK

Graphic controller synchronization : OK

Main FIRMWARE check : NOT PRESENT
Graphic controller FIRMWARE : ERROR

F1=MODEM F2=PC ENTER=Prj

```

- Choose the required transfer mode: MODEM if you intend to use a modem or PC if you intend to use a serial port; press the corresponding function

If the choose made is PC, the VT is ready to receive (see Software Manual for transfer), if, on the other hand, you choose MODEM, the following mask will appear

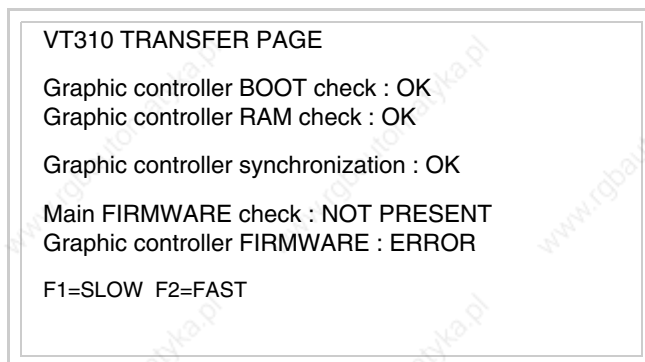

The choice should be according to the speed you intend to use for the transfer (Slow=9600bit/sec or Fast=38400bit/sec), press the corresponding function . The VT is now ready to receive (see Software Manual for the transfer).

Information relating to driver

After the project has been transferred, the VT can make available information relating to what has been loaded. The information regards:

- Serial ports present
- The name of the driver loaded
- The version of the driver loaded
- Network address of the VT
- Last error to have occurred

To acquire this information carry out the following operations:



- Be situated in any page of the project
- Press twice; you will see

Port	:	xxxxxxxxxxxxxxxxxxxxxx
Driver	:	xxxxxxxxxxxxxxxxxxxxxx
Ver	:	xxxxxxxxxxxxxxxxxxxxxx
Addr VT	:	xxxxxxxxxxxxxxxxxxxxxx
Error	:	xxxxxxxxxxxxxxxxxxxxxx
Right = next page Enter = settings page		



There is one of these pages for each communication port; you can move between the various pages by pressing .

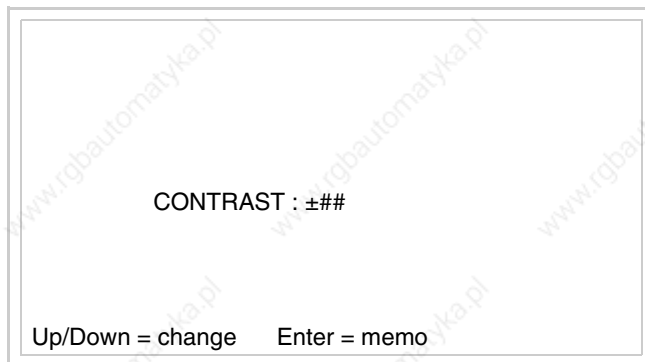

If you press  while displaying this page you can access the page for setting the clock and the contrast.

	SET CONTRAST : ±##
	SET CLOCK : ddd,dd/mm/yy hh:mm:ss
Up/Down = select Enter = set	

In order to access the contrast setting, use  or  to select the SET CONTRAST option that is displayed in reverse colors and press ; the following mask will appear:











Use  and/or  to effect any variation and  for the confirmation.

To be able to set the clock use  or  to select the SET CLOCK option that is displayed in reverse colors and press ; the following mask will appear:

 **For the clock to be used properly, a special battery has to be inserted in the terminal (see “Chapter 33 -> Video terminal accessories”).**



Use  and/or  to select the field and  and/or  to effect any variation; use  to confirm.

To use the Memory Card either switch on the VT with  held down or, if the VT is already on, press  +  together; in both cases it will be

necessary to wait a moment before the following mask appears on the VT:

```
VT310 TRANSFER PAGE
Graphic controller BOOT check : OK
Graphic controller RAM check : OK

Graphic controller synchronization : OK

Main FIRMWARE check : NOT PRESENT
Graphic controller FIRMWARE : ERROR

F1=ASP F2=MSP F3=MemoCARD ENTER=Prj
```

Press F3=MemoCARD (if the key is not on the screen, see Page 10-15) and the following mask will appear:

```
MEMORY CARD MENU

F1= BACKUP      F2= RESTORE
F3= ERASE       F4= EXIT
```

For the meaning and function of the keys see "Chapter 33 -> Memory card".

Possible error messages are:

- PR ERR

Problem-> Errors have been detected in the data exchange between the VT and the Device.

Solution-> Check the cable; there may be disturbance.

- COM BROKEN

Problem-> Communication between VT and Device interrupted.

Solution-> Check the serial connection cable.

An error message followed by [*] indicates that the error is not currently present but was and has since disappeared.

Example: COM BROKEN*

When  is pressed you quit the display of information regarding the driver.

Adjusting the contrast on the display

To improve the quality of the representation on the display it may be necessary to adjust its contrast. This can be done by going to the page proposed (see Page 10-17) and changing the value (from +31 to -32) in evidence at that moment. Increase the value to darken the display; to lighten it decrease the value.

Chapter 11 Video terminal VT320W

Contents	Page
Technical characteristics	11-2
Functions	11-4
Front view	11-8
Customizing label	11-10
Rear view	11-11
Dimensions and Cut-out	11-12
Accessories	11-13
Transfer PC -> VT	11-13
Preparation for reception	11-14
Information relating to driver	11-16
Improving display color quality	11-19
Adjusting the contrast on the display	11-20

This chapter consists of 20 pages.

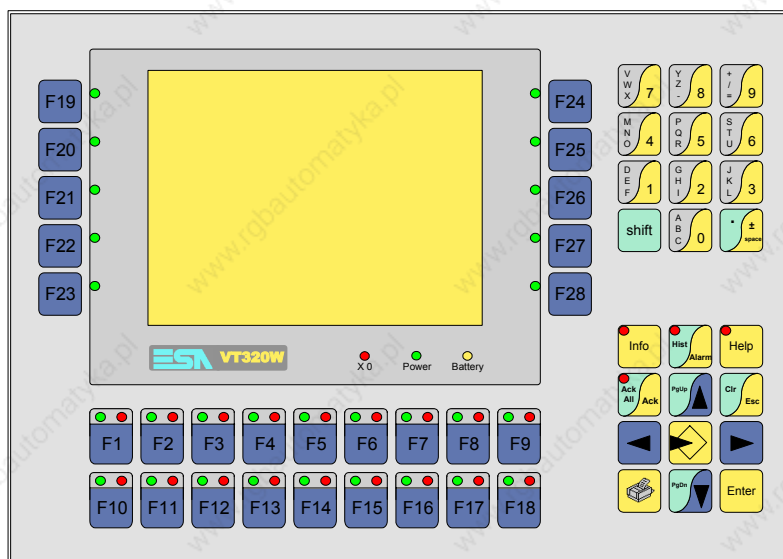

Technical characteristics

The following table lists the principal technical characteristics of the product in question.

Code of terminal	Characteristics of the terminal	
VT320W A0000		
VT320W AP000		
Display		
Type	LCD monochromatic STN	
	LCD 16 Colors STN	● ●
	LCD 16 Colors TFT	
Representational format	Graphic	● ●
Resolution [pixels]	320 x 240 (5,7")	● ●
Rows by characters	16 x 40 / 8 x 20 / 4 x 10	● ●
Display area size [mm]	115,6 x 87	● ●
Character matrix in text mode [pixels]	8 x 15 / 16 x 30 / 32 x 60	● ●
Character size [mm] x 1 / x 2 / x 4	2,8 x 5,2 / 5,6 x 10,4 / 11,2 x 20,8	● ●
Contrast adjustment	Software	● ●
	Automatic compensation with temperature	● ●
Character sets	Programmable fonts/TTF Windows ®	● ●
Backlighting		
Type	LED	
	CCFL lamp	● ●
Minimum lamp-life at 25°C [hours]	15000	● ●
Keyboard		
Non-customizable function keys	10	● ●
Customizable function keys	18	● ●
Function key LEDs	46	● ●
Alphanumeric keys	11	● ●
Operational keys	13	● ●
Operational key LEDs	4	● ●
Diagnostic LEDs	3	● ●

Code of terminal	Characteristics of the terminal	
VT320W A000		
VT320W AP000		
User memory		
Project [Bytes]	192K + 832K (Text+ Graphics)	● ●
Data memory [Bytes]	256K (With back-up battery)	● ●
Memory for Windows ® -based fonts [Byte]	128K	● ●
Memory Card for backup	4Mb	● ●
Memory Card for expansion	--	
Interfaces		
MSP (Multi-serial port)	RS232/RS422/RS485/TTY-20mA	● ●
ASP (Auxiliary serial port)	RS232/RS485	● ●
ASP-15L (Auxiliary serial port)	RS232/RS485	● ●
ASP-8 (Auxiliary serial port)	RS232	
ASP-9 (Auxiliary serial port)	RS232	
LPT parallel port	Centronics	●
Auxiliary port	Connection of accessories	● ●
Accessories		
Connectable accessories	See table "Chapter 33"	● ●
Clock		
Clock	Hardware (With back-up battery)	● ●
Networks		
Integrated	Profibus-DP	
	CAN Open (Optoisolated interface)	
	Ethernet 10/100Mbit RJ45	
Universal Bus Connector	--	
Optional	See table "Chapter 33"	● ●
Proprietary networks		
ESA-Net	Network server	● ●
	Network client	● ●
Technical data		
Power supply	24Vdc (18..32Vdc)	
Power absorbed at 24Vdc	15W	
Protection fuse	Ø5x20mm - 800mA Quick Blow F	
Protection level	IP65 (front-end)	
Operating temperature	0..50°C	
Storage and transportation temperature	-20..+60°C	
Humidity (non-condensing)	<85%	
Weight	2000gr	
Dimensions		
External W x H x D [mm]	305 x 196 x 60	
Cut-out W x H [mm]	275 x 176	
Certification		
Certifications and approvals	CE, cULus, NEMA12	

Functions

The following table lists in alphabetical order all the functions of the VT in question.

Table 11.1: Functions and objects realizable with this VT (Part 1 of 4)

Code of terminal		
VT320W *****		
Objects/Functions	Quantity	▼
Alarm field		●
Alarm help	1024	●
Alarm history buffer	256	●
Alarm statistics		
Alarms (Total/active simultaneously)		●
Arc		●
Automatic operations	32	●
Backup/Restore		●
Bar data		●
Bit-wise password	8bits	●
Buttons		
Circles		●
Command: Change language		●
Command: Clear trend buffer		●
Command: Delete recipe		●
Command: Hardcopy		●
Command: Load recipe from data memory		●
Command: Modify password		●
Command: Next page		
Command: Page help		●
Command: Password login		●
Command: Password logout		●
Command: Previous page		
Command: Print alarm history		●
Command: Printer form feed		●
Command: Quit project		●
Command: Report		●
Command: Restarts reading time-sampled trend		●
Command: Run pipeline		●
Command: Save alarms history and trend buffers in flash		
Command: Save recipe in data memory		●
Command: Save recipe received from device in buffer		●
Command: Save recipe received from device in data memory		●
Command: Send recipe from video buffer to device		●
Command: Send recipe to device		●
Command: Service page		●

Unless otherwise stated, there is no limit to the number of includable elements, only the size of project memory sets a limit.
*) indicative value determined by the dimensions of the project, **) depends on memory available

Table 11.1: Functions and objects realizable with this VT (Part 2 of 4)

Code of terminal		
VT320W *****		
Objects/Functions	Quantity	▼
Command: Show alarms history		●
Command: Show page directory		
Command: Show project information		●
Command: Show recipe directory		●
Command: Show sequence directory		●
Command: Shows driver status page		
Command: Shows page help		
Command: Shows page with function: PG		
Command: Stops reading time sampled trend		●
Command: Trend reading saved in device		●
Command: Zero number of general pages		●
Date field		●
Day-of-the-week field		●
Dynamic texts: Bit-group-structured dynamic texts	1024*	●
Dynamic texts: Single-bit dynamic texts		●
Dynamic texts: Value-structured dynamic texts		●
E-keys		●
Equations	32	●
F-keys		●
Free terminal		
Function: Disables key		●
Function: Go to page		
Function: Internal command		●
Function: Invert bit value		●
Function: Macro		●
Function: None		●
Function: Reset bit permanently		●
Function: Reset real-time bit		●
Function: Sequences		●
Function: Sets bit permanently		●
Function: Sets real-time bit		●
Function: Value-structure direct command		●
Global configuration of E-keys		●
Global configuration of F-keys		●
Headers and footers (Total/Number of fields per H-F)	128/128	●
Info-messages (Total/active simultaneously)	1024/256	●
Internal registers	4096bytes	●
Labels		●
LEDs assigned to sequence		●

Unless otherwise stated, there is no limit to the number of includable elements, only the size of project memory sets a limit.
 *) indicative value determined by the dimensions of the project, **) depends on memory available

Table 11.1: Functions and objects realizable with this VT (Part 3 of 4)

Code of terminal		
VT320W *****		
Objects/Functions	Quantity	
Lines		●
Lists of bitmap images		●
Lists of texts		●
Local configuration of E-keys		●
Local configuration of F-keys		●
Macro field		
Macros (Total/Commands x macro)	1024/16	●
Message field		●
Message help	1024	●
Multilanguage texts	8 Langs.	●
Object - Indicator		
Object - Potentiometer knob		
Object - Selector knob		
Object - Sliding potentiometer		
Object - Sliding selector		
Page	1024	●
Page help	1024	●
Password	10	●
Pipelines (Number/Tot bytes)	64/512	●
Print		●
Print page (Total/Number of fields per page)	1024/128	●
Programmable fonts		●
Project images		●
Public variables of ESANET network (Number/Total bytes)	256/1024	●
Recipe field for recipe structure		●
Recipes (Number of variables per recipe)	2048/512	●
Rectangles		●
Redefinable characters		
Reports	128	●
Sequences - Random	128	●
Sequences - Start/stop		●
Static bitmaps		●
Symbolic field: Bit-group-structured dynamic bitmaps	1024*	●
Symbolic field: Single-bit-structured dynamic bitmaps		●
Symbolic field: Value-structured dynamic bitmaps		●
System messages		●
System variables assigned to recipe structure		●
Time long field		●
Time short field		●

Unless otherwise stated, there is no limit to the number of includable elements, only the size of project memory sets a limit.
*) indicative value determined by the dimensions of the project, **) depends on memory available

Table 11.1: Functions and objects realizable with this VT (Part 4 of 4)







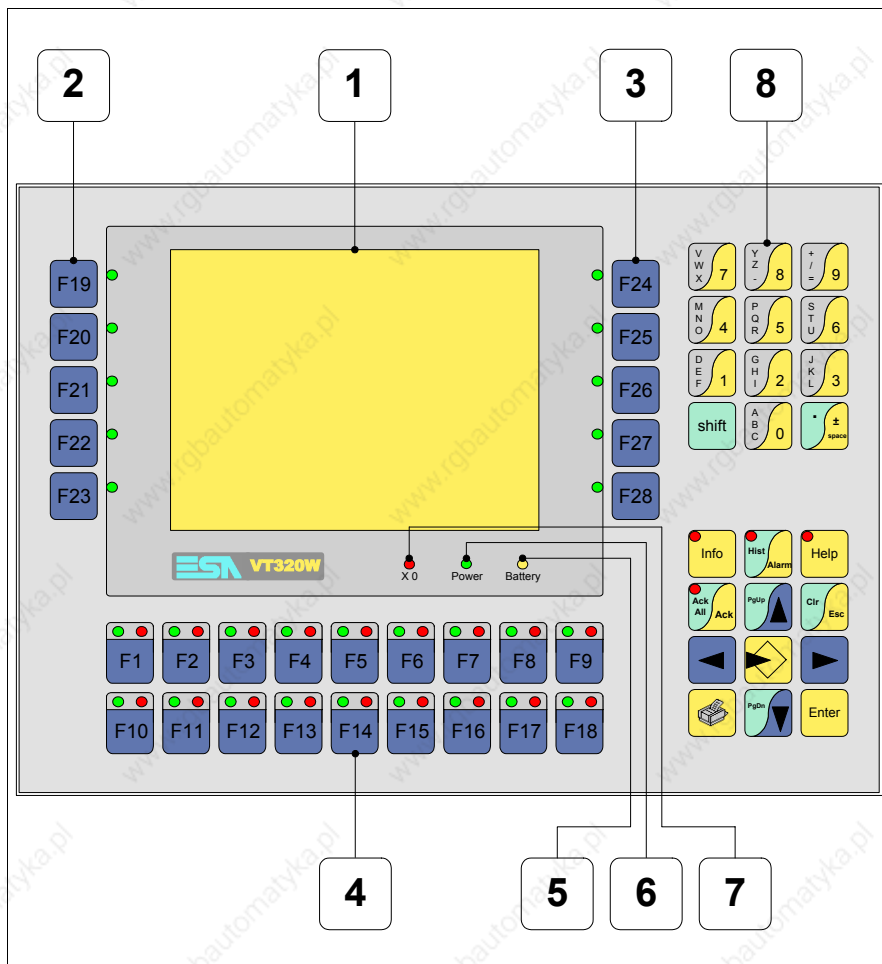









Code of terminal		
VT320W ****		
Objects/Functions	Quantity	▼
Timer	16	●
Touch Area		
Trend buffers	128	●
Trends (Trends x page/Channels x trend)	4/4	●
Trends sampled automatically (Memory/Trends/Readings)	4096bytes	●
Trends sampled on command (Memory/Trends/Readings)	/**/320	●
Value direct command: ADD		●
Value direct command: AND		●
Value direct command: OR		●
Value direct command: SET		●
Value direct command: SUBTRACT		●
Value direct command: XOR		●
Variables: Limit values and linear scaling variables	112xpages	●
Variables: Movement variable (Mobile symbolic field)		●
Variables: Threshold variables		●
Variables: Floating Point numerical variables		●
Variables: Numerical variables (DEC, HEX, BIN, BCD)		●
Variables: String variables (ASCII)		●

Unless otherwise stated, there is no limit to the number of includable elements, only the size of project memory sets a limit.
 *) indicative value determined by the dimensions of the project, **) depends on memory available

Front view



Key	Function
1	Display
2	F-keys with one LED
3	F-keys with one LED
4	F-keys with two LEDs
5	X0 LED. Blinks when communication error is detected
6	Power LED. Lights up when power in ON
7	Battery LED. Lights up when the battery has nearly run out

Key	Function
8	Alphanumeric keys
	Starts input
	Confirms setting of data
	Page up When in setting phase, edits dynamic text
	Page down When in setting phase, edits dynamic text
	Moves the cursor between settable fields When in setting phase, moves cursor to the left of the field
	Moves the cursor between settable fields When in setting phase, moves cursor to the right of the field
	Quits: setting of data, info-messages, sequence directory, communication driver
	Displays info-messages
	Displays ISA alarms
	Displays according to context: information message help, alarm help or page help
	Acknowledgment of ISA alarms on display
	Print the entire display area
	No predefined function
 + 	In setting phase restores the initial value of the field
 + 	Acknowledges all ISA alarms

Customizing label

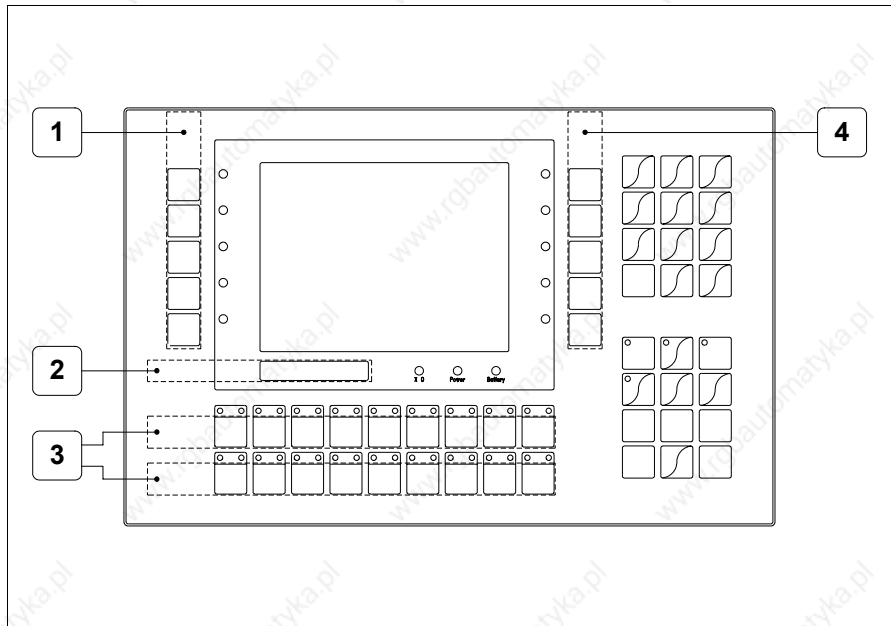

Position	Function - Dimensions L x H (mm)
1	F-key customization F - 16 x 111
2	ESA Logo, VT Model - 115 x 10
3	F-key customization F - 191 x 15
4	F-key customization F - 16 x 111



The total thickness of the label must not exceed 125µm (micrometers). Do not use either stiff materials or glues.



Before starting to insert the customized label, see “Chapter 28 -> Inserting customized labels“.

Rear view

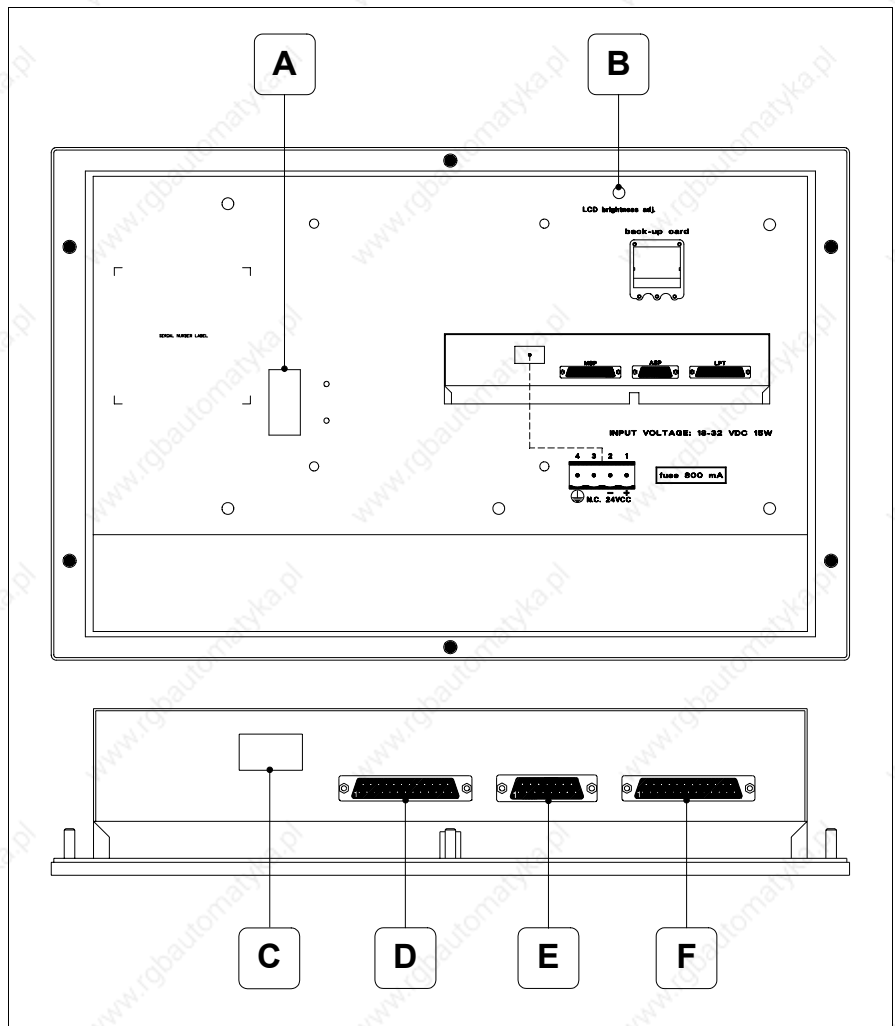

Position	Function
A	Auxiliary port for connecting optional accessories
B	Trimmer for brightness control
C	Power supply connector
D	MSP serial port for communicating with PLC/PC
E	ASP serial port for communicating with PC or other devices
F	LPT port for connecting printer (Optional)

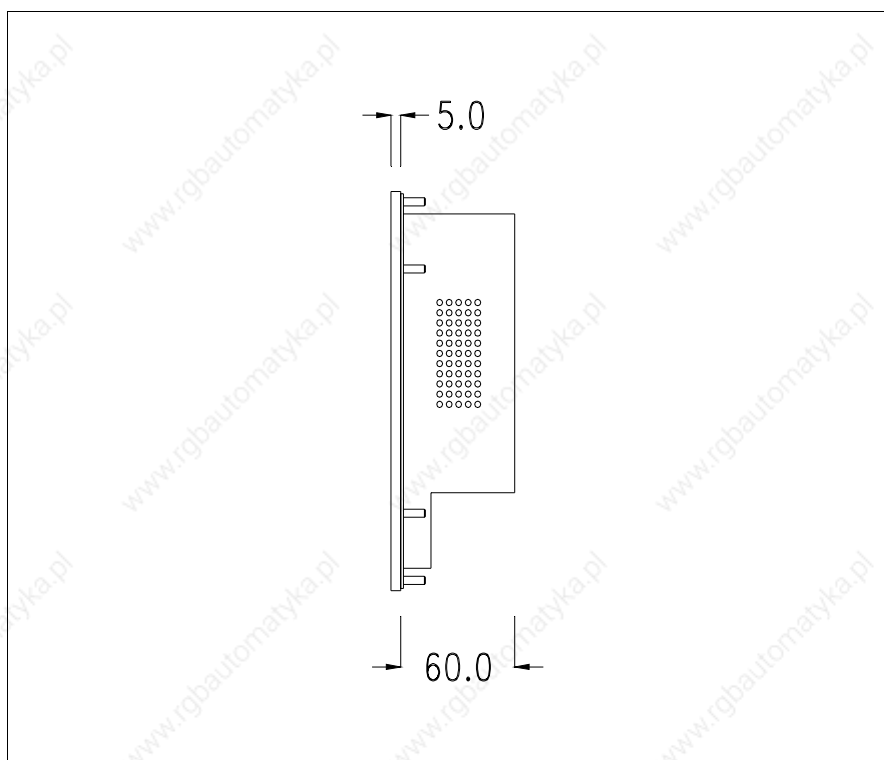
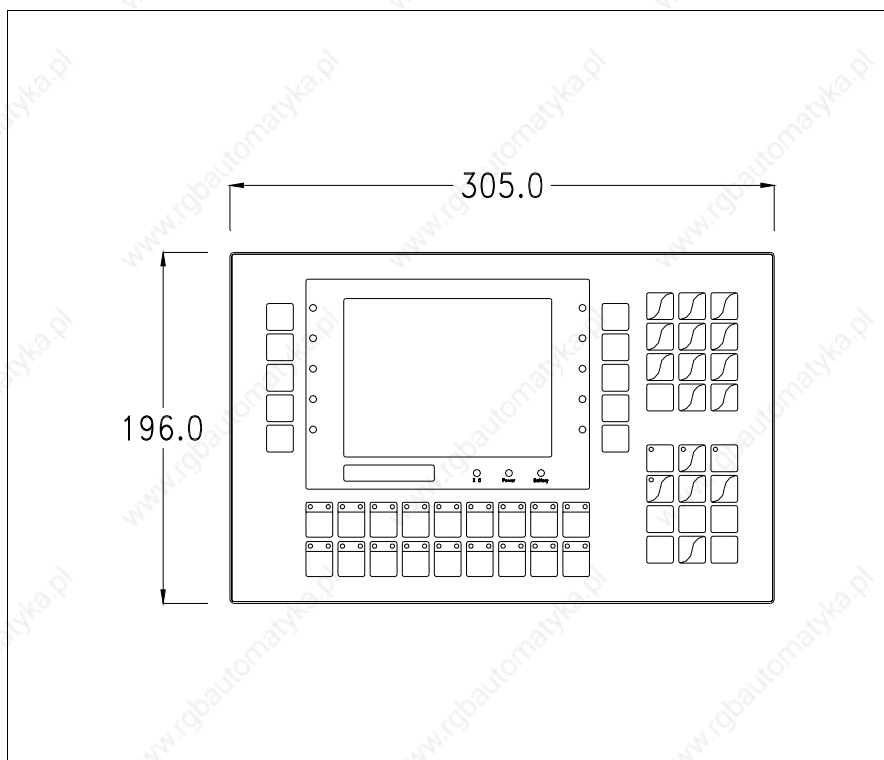
**Dimensions
and Cut-out**

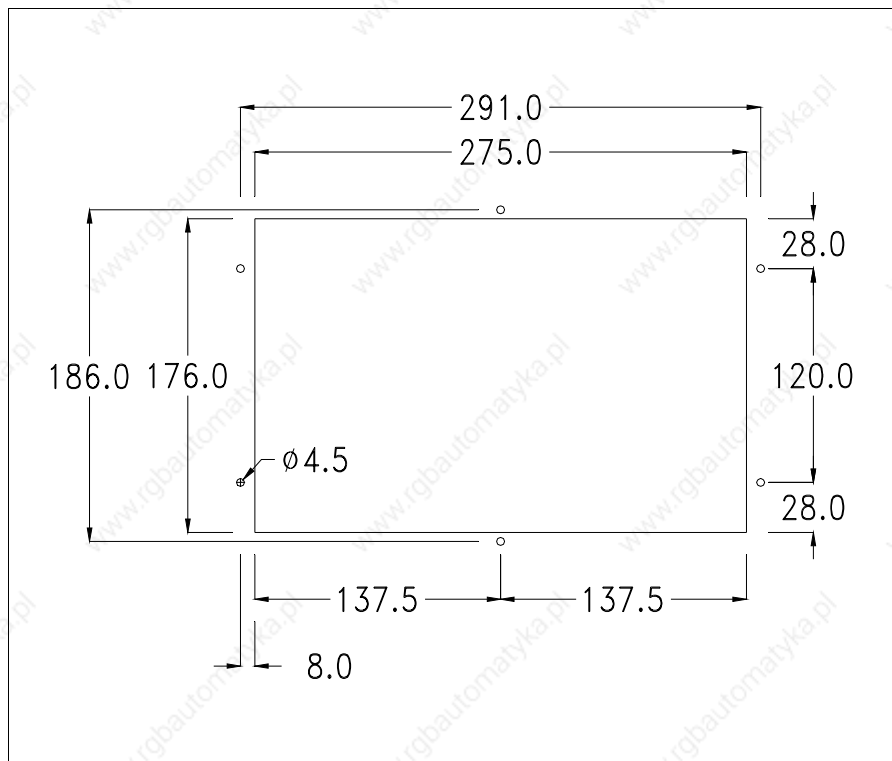

To fix the sealing gasket and secure the VT to the container see “Chapter 29 -> Mounting the terminal within the container”.

⚠ Where accessories need to be fixed in or onto the VT terminal, you are advised to do this before securing the VT to its container.

Accessories

Any accessories should be mounted in accordance with the instructions in the relevant chapter (see “Chapter 33 -> Video terminal accessories”).

Transfer PC -> VT

For everything to function properly, the first time the VT operator terminal is switched on it needs to be correctly loaded, that is it needs to have transferred to it:

- Firmware
- Communication driver
- Project



(Given that the transfer of the three files in practice occurs with a single operation, it will be defined as “Project transfer” for the sake of simplicity.)

For this it is essential that the VT be prepared to receive the transfer. (See also “Chapter 37 -> Command area”).

**Preparation
for reception**

The program VTWIN (see Software Manual) must be used for the transfer, but the terminal must be set up to receive. This means carrying out the following steps:

- Check that the VT is off
- Check that there is a serial connection between the PC and the VT
- Switch on the VT; when the message [WAIT FOR BOOT FORCED] is

displayed, press  or with the VT on press together  + ; in either case wait a moment

VT terminal with no Modem function:

- The following mask appears. F3=MemoCARD is only enabled when a Memory Card has been inserted in the VT terminal (see Page 11-18). The function to press depends on which port you intend to use (MSP or ASP). The VT is now ready to receive (refer to Software Manual for transfer procedure)

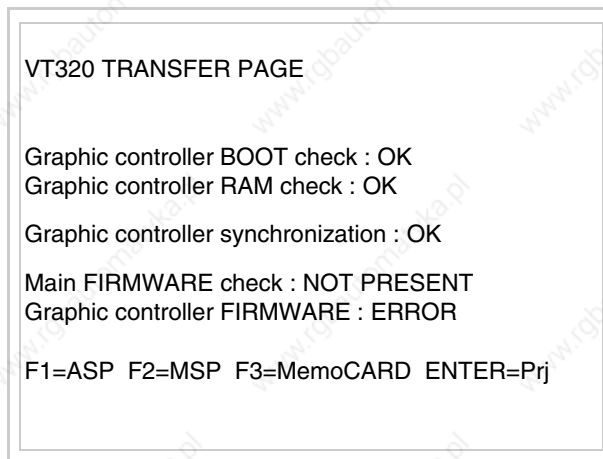
**VT terminal with Modem function:**

- Proceed from the preceding mask; the following mask appears

VT320 TRANSFER PAGE

Graphic controller BOOT check : OK

Graphic controller RAM check : OK

Graphic controller synchronization : OK

Main FIRMWARE check : NOT PRESENT

Graphic controller FIRMWARE : ERROR

F1=MODEM F2=PC ENTER=Prj

- Choose the required transfer mode: MODEM if you intend to use a modem or PC if you intend to use a serial port; press the corresponding function

If the choose made is PC, the VT is ready to receive (see Software Manual for transfer), if, on the other hand, you choose MODEM, the following mask will appear

VT320 TRANSFER PAGE

Graphic controller BOOT check : OK

Graphic controller RAM check : OK

Graphic controller synchronization : OK

Main FIRMWARE check : NOT PRESENT

Graphic controller FIRMWARE : ERROR

F1=SLOW F2=FAST

The choice should be according to the speed you intend to use for the transfer (Slow=9600bit/sec or Fast=38400bit/sec), press the corresponding function . The VT is now ready to receive (see Software Manual for the transfer).

**Information
relating to
driver**

After the project has been transferred, the VT can make available information relating to what has been loaded. The information regards:

- Serial ports present
- The name of the driver loaded
- The version of the driver loaded
- Network address of the VT
- Last error to have occurred

To acquire this information carry out the following operations:

- Be situated in any page of the project
- Press  twice; you will see



```
Port      : xxxxxxxxxxxxxxxxxxxxxxxx
Driver    : xxxxxxxxxxxxxxxxxxxxxxxx
Ver       : xxxxxxxxxxxxxxxxxxxxxxxx
Addr VT   : xxxxxxxxxxxxxxxxxxxxxxxx
Error     : xxxxxxxxxxxxxxxxxxxxxxxx

Right = next page   Enter = settings page
```

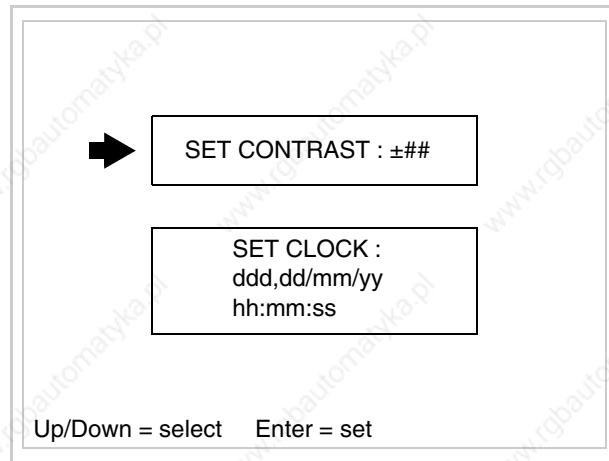

There is one of these pages for each communication port; you can move between the various pages by pressing .



If you press  while displaying this page you can access the page for setting the clock and the contrast.

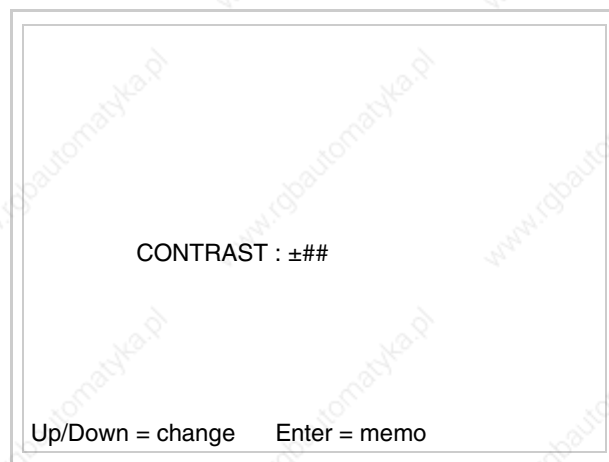

In order to access the contrast setting, use  or  to select the SET CONTRAST option that is displayed in reverse colors and press ; the following mask will appear:







Use  and/or  to effect any variation and  for the confirmation.



To be able to set the clock use  or  to select the SET CLOCK option that is displayed in reverse colors and press ; the following mask will appear:

! For the clock to be used properly, a special battery has to be inserted in the terminal (see “Chapter 33 -> Video terminal accessories”).

hh:mm:ss dd/mm/yy

Lf/Rt=select Up/Down=change Enter=memo

Use  and/or  to select the field and  and/or  to effect any variation; use  to confirm.

To use the Memory Card either switch on the VT with  held down or, if the VT is already on, press  +  together; in both cases it will be necessary to wait a moment before the following mask appears on the VT:

VT320 TRANSFER PAGE

Graphic controller BOOT check : OK
 Graphic controller RAM check : OK
 Graphic controller synchronization : OK
 Main FIRMWARE check : NOT PRESENT
 Graphic controller FIRMWARE : ERROR

F1=ASP F2=MSP F3=MemoCARD ENTER=Prj

Press  F3=MemoCARD (if the key is not on screen, see Page 11-14); and

the following mask will appear:

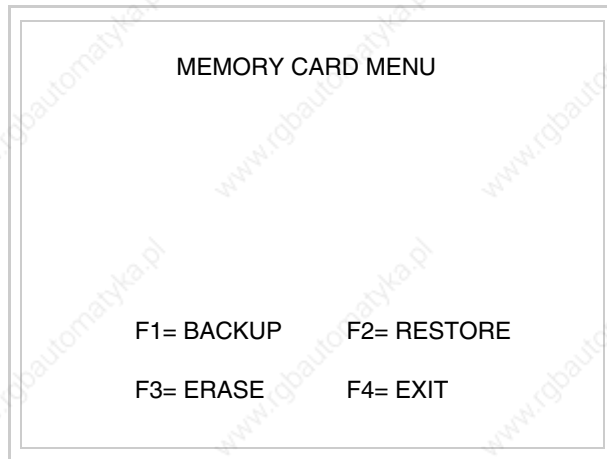

For the meaning and function of the keys see “Chapter 33 -> Memory card”.

Possible error messages are:

- PR ERR

Problem-> Errors have been detected in the data exchange between the VT and the Device.

Solution-> Check the cable; there may be disturbance.

- COM BROKEN

Problem-> Communication between VT and Device interrupted.

Solution-> Check the serial connection cable.

An error message followed by [*] indicates that the error is not currently present but was and has since disappeared.

Example: COM BROKEN*

When  is pressed you quit the display of information regarding the driver.

Improving display color quality

To improve the color quality, adjust the contrast of the display: if the colors are too dark increase the contrast; if, on the other hand, the colors are too light, decrease the contrast.

Adjusting the contrast on the display

To improve the quality of the representation on the display it may be necessary to adjust its contrast. This can be done by going to the page proposed (see Page 11-17) and changing the value (from +63 to -64) in evidence at that moment. Increase the value to darken the display; to lighten it decrease the value.

We advise this to be done at typical room temperature and with the terminal at operating temperature (about 30 minutes after switching on and with the screen saver disabled - see Software Manual).

Chapter 12 Video terminal VT155W

Contents	Page
Technical characteristics	12-2
Functions	12-4
Front view	12-8
Standard series rear view	12-9
Profibus-DP series rear view	12-10
CAN series rear view	12-11
Ethernet series rear view	12-12
Dimensions and Cut-out	12-13
Accessories	12-14
Methods of mounting	12-14
Calibration of Touch Screen	12-15
Termination of CAN line	12-17
Introducing the MAC address	12-18
Transfer PC -> VT	12-20
Preparation for reception	12-20
Information relating to driver	12-22
Adjusting the contrast on the display	12-25

This chapter consists of 26 pages.

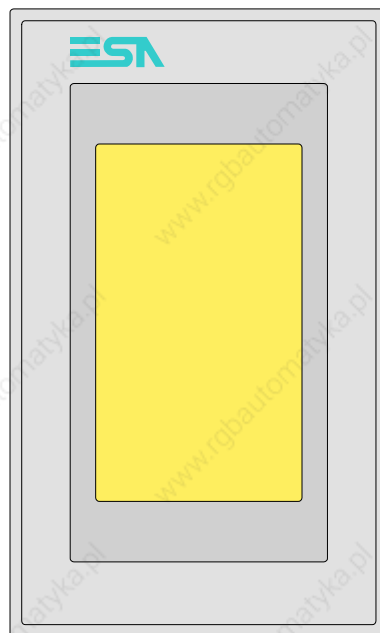
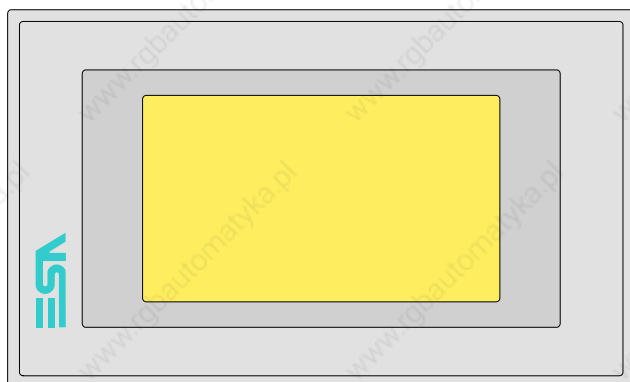

Technical characteristics

The following table lists the principal technical characteristics of the product in question.

Code of terminal		Characteristics of the terminal			
VT155W 00000					
VT155W 000DP					
VT155W 000CN					
VT155W 000ET					
Display					
Type	LCD 4 tones of grey STN	●	●	●	●
	LCD 16 Colors STN				
	LCD 16 Colors TFT				
Touch screen	Matrix 20 x 8 (Cell: 12x16 pixels)	●	●	●	●
Representational format	Graphic	●	●	●	●
Resolution [pixels]	240 x 128 (4")	●	●	●	●
Rows x characters	16 x 40 / 8 x 20 / 4 x 10 - 21 x 30* / 10 x 15* / 5 x 7*	●	●	●	●
Display area size [mm]	94,5 x 54,5	●	●	●	●
Character matrix in text mode [pixels]	6 x 8 / 12 x 16 / 24 x 32	●	●	●	●
Character size [mm] x 1 / x 2 / x 4	2,3 x 5,2 / 4,6 x 5,8 / 9,1 x 11,7	●	●	●	●
Contrast adjustment	Software	●	●	●	●
	Automatic compensation with temperature	●	●	●	●
Character sets	Programmable fonts/TTF Windows ®	●	●	●	●
Backlighting					
Type	LED	●	●	●	●
	CCFL lamp				
Minimum lamp-life at 25°C [hours]	--				

*) vertical mounting

Code of terminal	Characteristics of the terminal			
VT155W 0000				
VT155W 000DP				
VT155W 000CN				
VT155W 000ET				
User memory				
Project [Bytes]	640K (Text + Graphics)	●	●	●
Data memory [Bytes]	16K (Flash EPROM)	●	●	●
Memory for Windows ® -based fonts [Byte]	--			
Memory Card for backup	--			
Memory Card for expansion	--			
Interfaces				
MSP (Multi-serial port)	RS232/RS422/RS485/TTY-20mA			●
ASP (Auxiliary serial port)	RS232/RS485			
ASP-15L (Auxiliary serial port)	RS232/RS485			
ASP-8 (Auxiliary serial port)	RS232	●	●	●
ASP-9 (Auxiliary serial port)	RS232			
LPT parallel port	Centronics			
Auxiliary port	Connections for accessories			
Accessories				
Connectable accessories	See table "Chapter 33"	●	●	●
Clock				
Clock	Hardware (with Supercapacitor - Min.72h	●	●	●
Networks				
Integrated	Profibus-DP			●
	CAN Open (Optoisolated interface)		●	
	Ethernet 10/100Mbit RJ45	●		
Universal Bus Connector	--			
Optional	See table "Chapter 33"	●	●	●
Proprietary networks				
ESA-Net	Network server			
	Network client	●	●	●
Technical data				
Power supply	24Vdc (18..32Vdc)			
Power absorbed at 24Vdc	10W			
Protection fuse	Ø5x20mm - 800mA Quick Blow F			
Protection level	IP65 (front-end)			
Operating temperature	0..50°C			
Storage and transportation temperature	-20..+60°C			
Humidity (non-condensing)	<85%			
Weight	500gr			
Dimensions				
External W x H x D [mm]	166 x 100 x 39,6			
Cut-out W x H [mm]	157 x 91			
Certification				
Certifications and approvals	CE, cULus			

*) vertical mounting

Functions

The following table lists in alphabetical order all the functions of the VT in question.

Table 12.1: Functions and objects realizable with this VT (Part 1 of 4)

Code of terminal		
VT155W *****		
Objects/Functions	Quantity	▼
Alarm field		●
Alarm help	256	●
Alarm history buffer	220	●
Alarm statistics		
Alarms (Total/active simultaneously)	256/256	●
Arc		●
Automatic operations	32	●
Backup/Restore		●
Bar data		●
Bit-wise password	8bits	●
Buttons	160 x page	●
Circles		●
Command: Change language		●
Command: Clear trend buffer		
Command: Delete recipe		●
Command: Hardcopy		●
Command: Load recipe from data memory		●
Command: Modify password		●
Command: Next page		●
Command: Page help		●
Command: Password login		●
Command: Password logout		●
Command: Previous page		●
Command: Print alarm history		●
Command: Printer form feed		●
Command: Quit project		●
Command: Report		●
Command: Restarts reading time-sampled trend		
Command: Run pipeline		
Command: Save alarms history and trend buffers in flash		●
Command: Save recipe in data memory		●
Command: Save recipe received from device in buffer		●
Command: Save recipe received from device in data memory		●
Command: Send recipe from video buffer to device		●
Command: Send recipe to device		●
Command: Service page		●

Unless otherwise stated, there is no limit to the number of includable elements, only the size of project memory sets a limit.
*) indicative value determined by the dimensions of the project, **) depends on memory available

Table 12.1: Functions and objects realizable with this VT (Part 2 of 4)

Code of terminal		
VT155W *****		
Objects/Functions	Quantity	▼
Command: Show alarms history		●
Command: Show page directory		●
Command: Show project information		●
Command: Show recipe directory		●
Command: Show sequence directory		
Command: Shows driver status page		●
Command: Shows page help		●
Command: Shows page with function: PG		
Command: Stops reading time sampled trend		
Command: Trend reading saved in device		
Command: Zero number of general pages		●
Date field		●
Day-of-the-week field		●
Dynamic texts: Bit-group-structured dynamic texts	1024*	●
Dynamic texts: Single-bit dynamic texts		●
Dynamic texts: Value-structured dynamic texts		●
E-keys		
Equations	32	●
F-keys		
Free terminal		
Function: Disables key		
Function: Go to page		●
Function: Internal command		●
Function: Invert bit value		●
Function: Macro		●
Function: None		
Function: Reset bit permanently		●
Function: Reset real-time bit		●
Function: Sequences		
Function: Sets bit permanently		●
Function: Sets real-time bit		●
Function: Value-structure direct command		●
Global configuration of E-keys		
Global configuration of F-keys		
Headers and footers (Total/Number of fields per H-F)	32/128	●
Info-messages (Total/active simultaneously)	256/256	●
Internal registers	4096bytes	●
Labels		●
LEDs assigned to sequence		

Unless otherwise stated, there is no limit to the number of includable elements, only the size of project memory sets a limit.
 *) indicative value determined by the dimensions of the project, **) depends on memory available

Table 12.1: Functions and objects realizable with this VT (Part 3 of 4)

Code of terminal		
VT155W *****		
Objects/Functions	Quantity	
Lines		●
Lists of bitmap images		●
Lists of texts		●
Local configuration of E-keys		
Local configuration of F-keys		
Macro field		
Macros (Total/Commands x macro)	1024/16	●
Message field		●
Message help	256	●
Multilanguage texts	4 Langs.	●
Object - Indicator		
Object - Potentiometer knob		
Object - Selector knob		
Object - Sliding potentiometer		
Object - Sliding selector		
Page	64	●
Page help	64	●
Password	10	●
Pipelines (Number/Tot bytes)		
Print		●
Print page (Total/Number of fields per page)	64/128	●
Programmable fonts		●
Project images		●
Public variables of ESANET network (Number/Total bytes)		
Recipe field for recipe structure		●
Recipes (Number of variables per recipe)	128/256	●
Rectangles		●
Redefinable characters		
Reports	32	●
Sequences - Random		
Sequences - Start/stop		
Static bitmaps		●
Symbolic field: Bit-group-structured dynamic bitmaps	1024*	●
Symbolic field: Single-bit-structured dynamic bitmaps		●
Symbolic field: Value-structured dynamic bitmaps		●
System messages		●
System variables assigned to recipe structure		●
Time long field		●
Time short field		●

Unless otherwise stated, there is no limit to the number of includable elements, only the size of project memory sets a limit.
*) indicative value determined by the dimensions of the project, **) depends on memory available

Table 12.1: Functions and objects realizable with this VT (Part 4 of 4)

Code of terminal		
VT155W ****		
Objects/Functions	Quantity	▼
Timer	32	●
Touch Area	24	●
Trend buffers		
Trends (Trends x page/Channels x trend)		
Trends sampled automatically (Memory/Trends/Readings)		
Trends sampled on command (Memory/Trends/Readings)		
Value direct command: ADD		●
Value direct command: AND		●
Value direct command: OR		●
Value direct command: SET		●
Value direct command: SUBTRACT		●
Value direct command: XOR		●
Variables: Limit values and linear scaling variables	32 x pages	●
Variables: Movement variable (Mobile symbolic field)		●
Variables: Threshold variables		●
Variables: Floating Point numerical variables		●
Variables: Numerical variables (DEC, HEX, BIN, BCD)		●
Variables: String variables (ASCII)		●

Unless otherwise stated, there is no limit to the number of includable elements, only the size of project memory sets a limit.
 *) indicative value determined by the dimensions of the project, **) depends on memory available

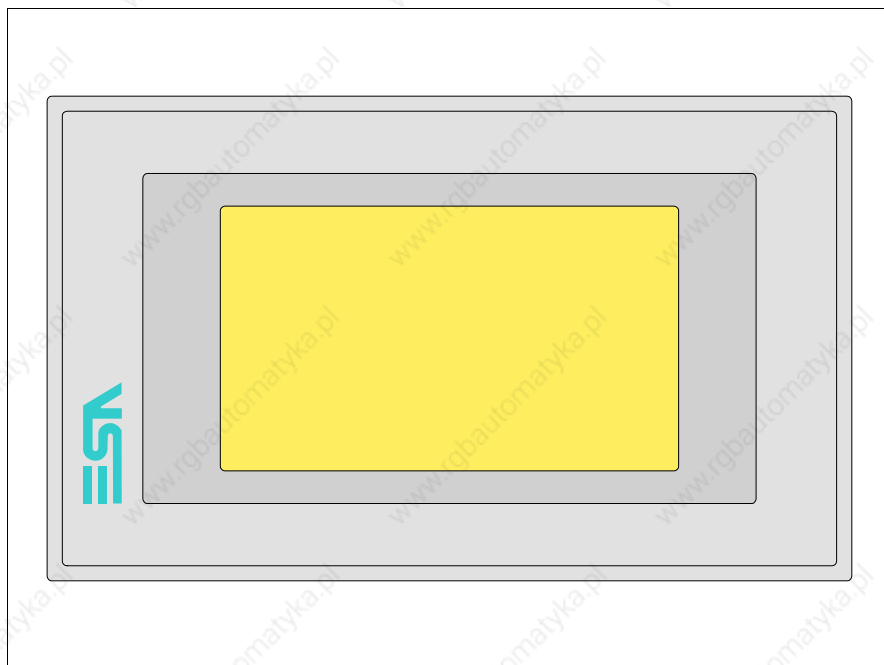
Front view

All buttons and signals are defined using the programming software (see Software Manual).

Standard series rear view

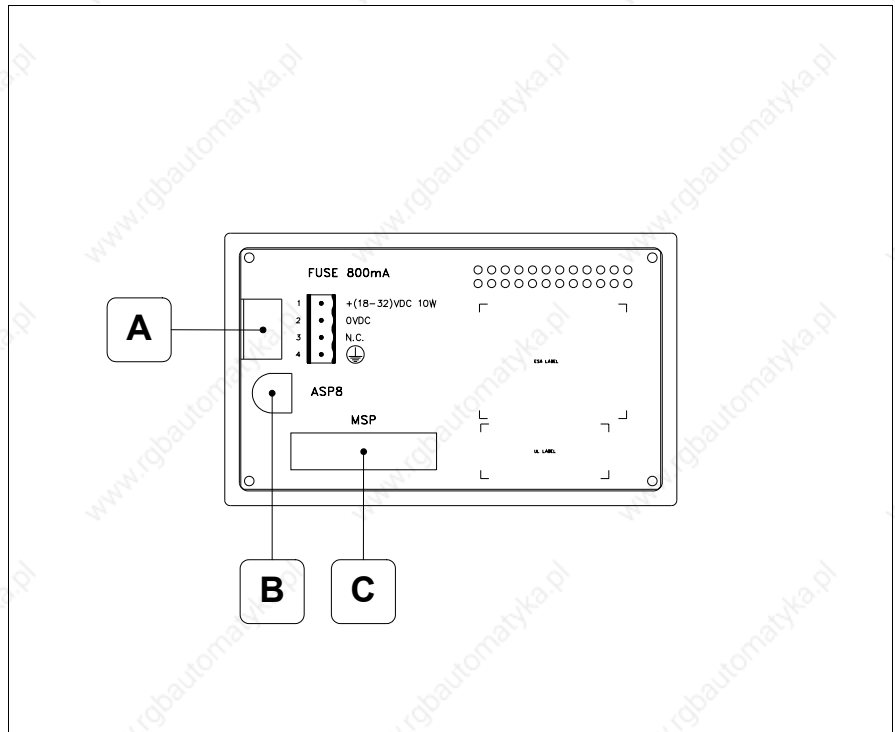

Position	Function
A	Power supply connector
B	ASP serial port for communicating with PC or other devices
C	MSP serial port for communicating with PLC/PC

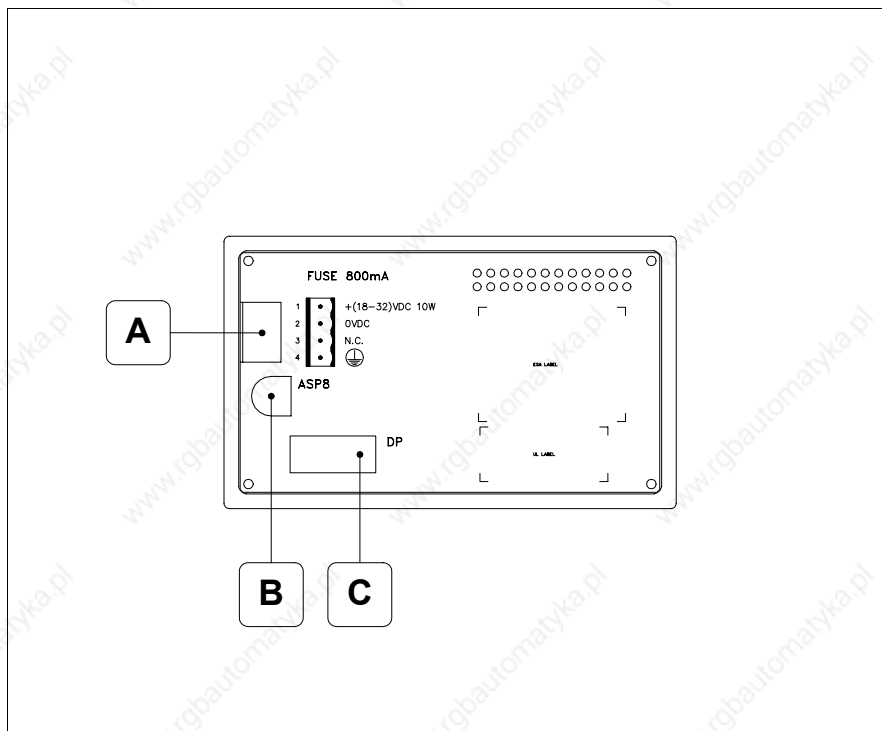
**Profibus-DP
series rear
view**

Position	Function
A	Power supply connector
B	ASP serial port for communicating with PC or other devices
C	Serial port for network communication

CAN series rear view

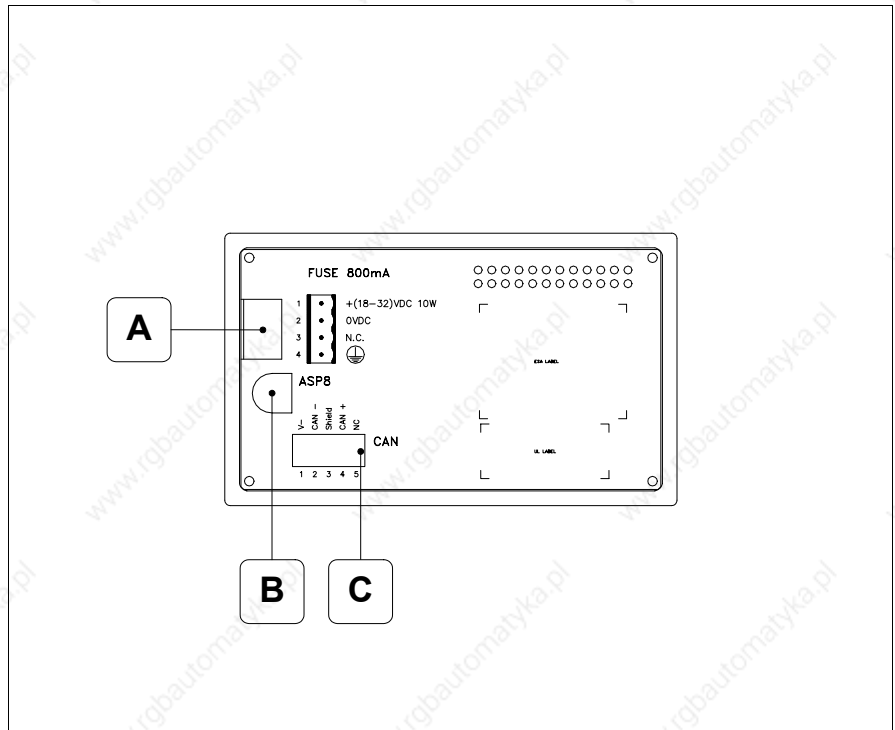

Position	Function
A	Power supply connector
B	ASP serial port for communicating with PC or other devices
C	CAN serial port

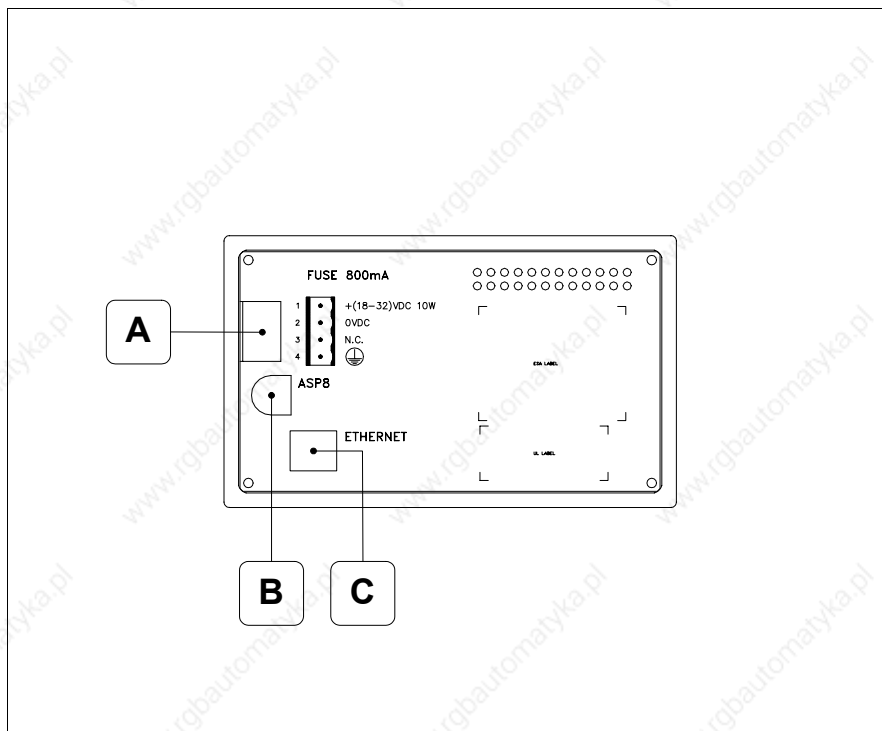
**Ethernet
series rear
view**

Position	Function
A	Power supply connector
B	ASP serial port for communicating with PC or other devices
C	Ethernet network 10/100Mbit RJ45 (For the diagnostic mode of the LEDs see "Chapter 30 -> Ethernet port")

Dimensions and Cut-out

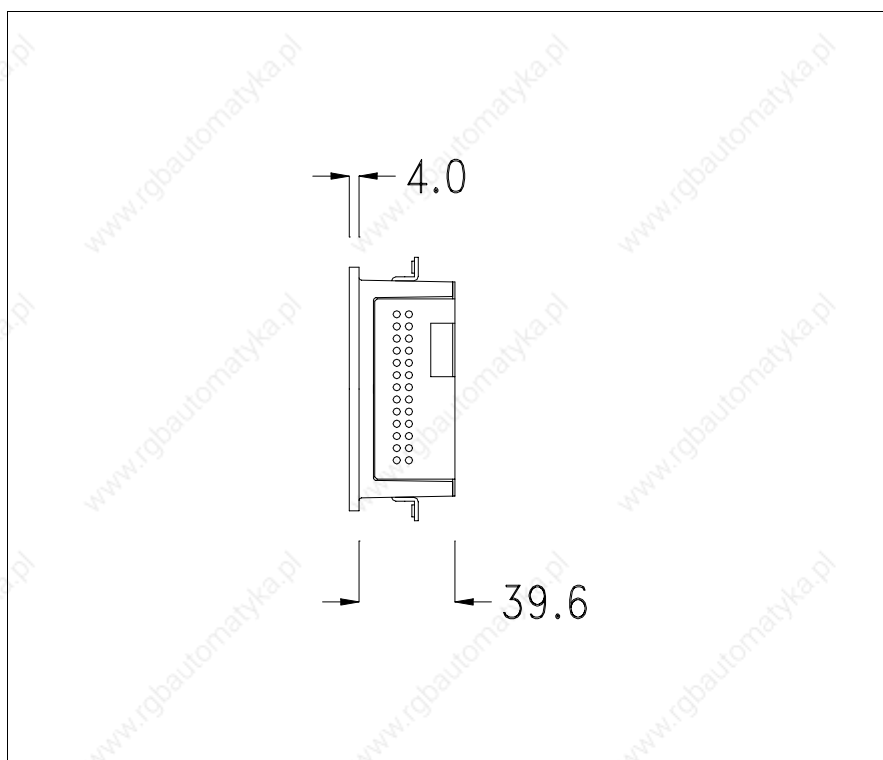
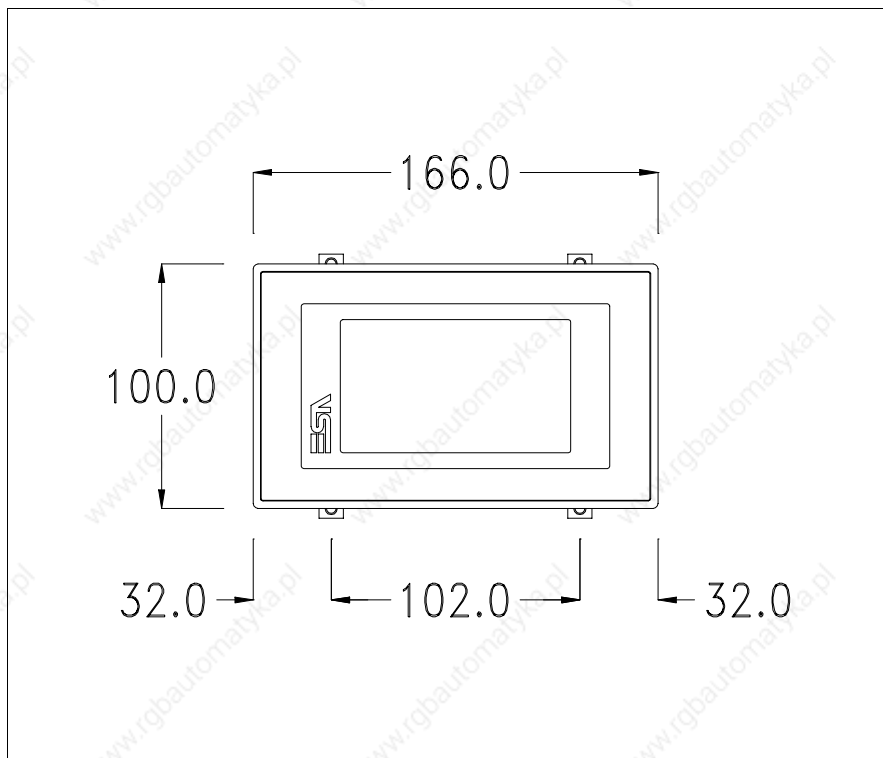

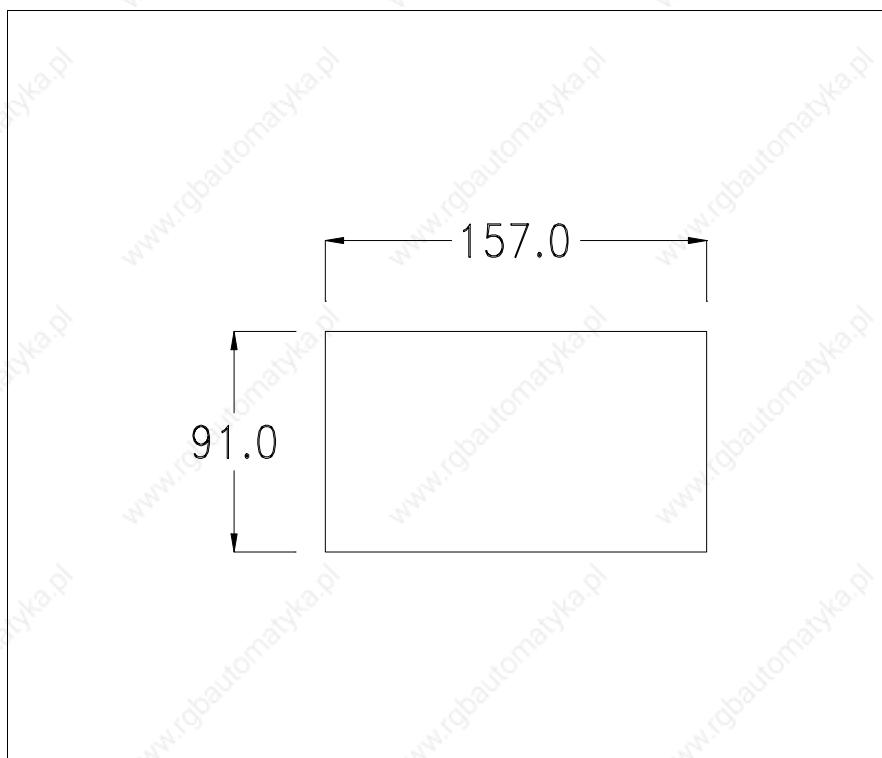

To fix the sealing gasket and secure the VT to the container see “Chapter 29 -> Mounting the terminal within the container“.

⚠ Where accessories need to be fixed in or onto the VT terminal, you are advised to do this before securing the VT to its container.

Accessories

Any accessories should be mounted in accordance with the instructions in the relevant chapter (see “Chapter 33 -> Video terminal accessories“).

Methods of mounting

There are two ways of mounting the VT155 on the container, horizontally or vertically. Once you have chosen the direction that means you can see the project properly and you are in the project creation phase, choose the terminal with the same orientation (see Software Manual “Chapter 5 -> New...“).

⚠ Once the orientation has been defined, you are recommended not to change it, as the project created could then become unusable.

⚠ To orientate the terminal correctly use the logo on the front fascia as a reference.

Below are listed the terminals with their respective correct orientations.

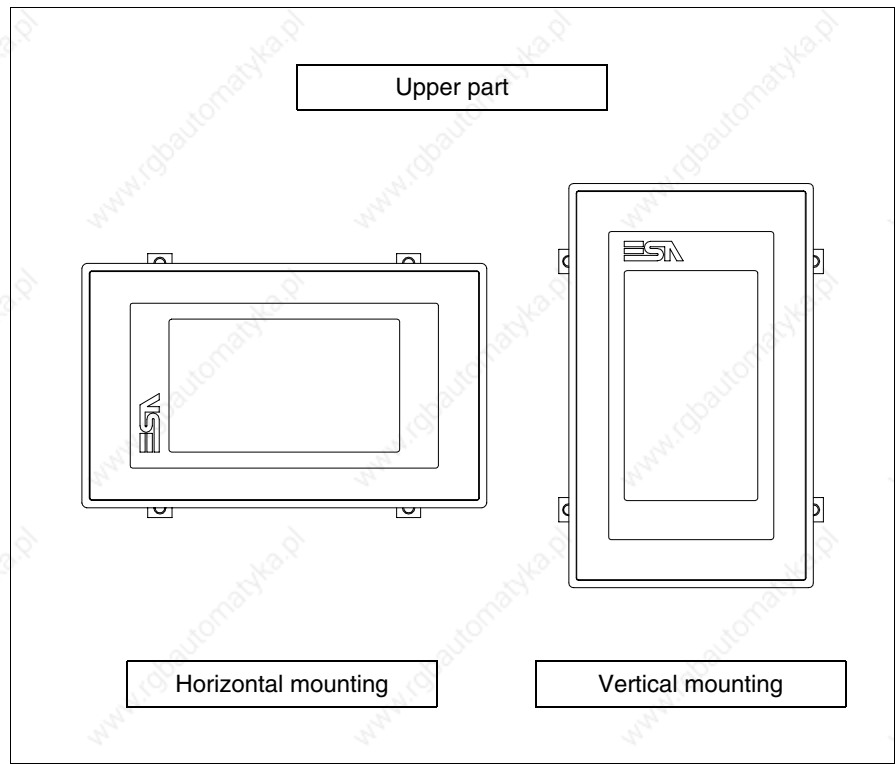

Calibration of Touch Screen

The screen of VT155W is made of resistive, sensitive glass; for this type of glass to work properly it requires a calibration procedure (**the terminal is already calibrated when supplied**), that is, the resistive area of the glass has to be adjusted to the visible are of the display.

Should it be thought necessary to repeat the calibration procedure this can be done by following the instructions set out below.

⚠ The procedure must be carried out with great care as the precision of the keys area depends on the calibration.

How to perform the calibration procedure:

- Make sure the VT is not connected to the power supply
- Remove the back cover
- Identify jumper J1

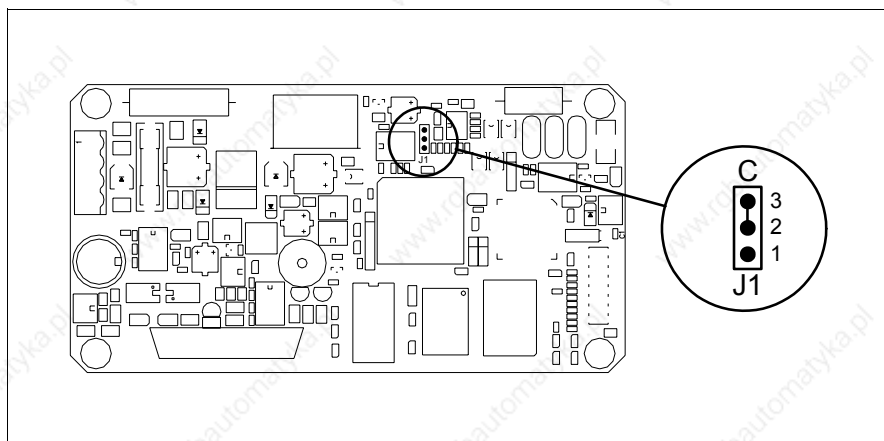

- Position J1 on pins 2-3 (C)
- Reconnect the power supply and switch on the terminal; the following mask appears

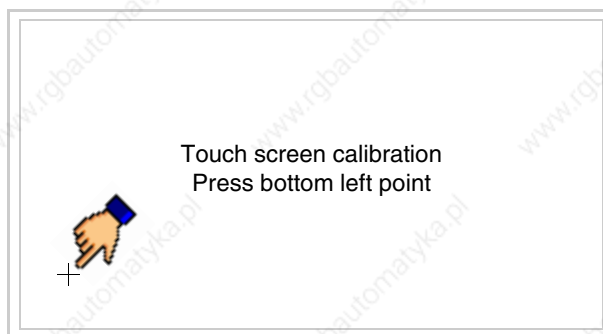

- Touch the corner indicated in the figure; then the following page appears on screen

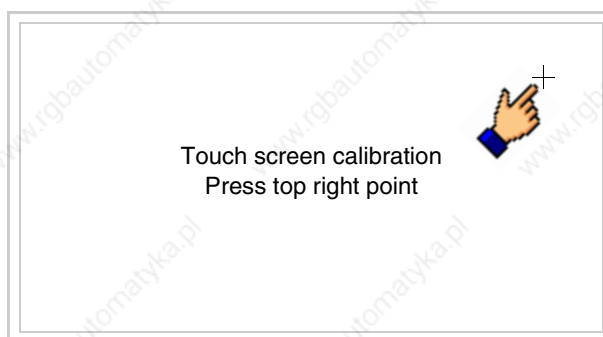

- Touch the corner indicated in the figure to complete the calibration procedure; the following page now appears



- Wait a few moments until the VT displays either the following mask or the project page (the page may be slightly different in its wording depending on which series the terminal belongs to)

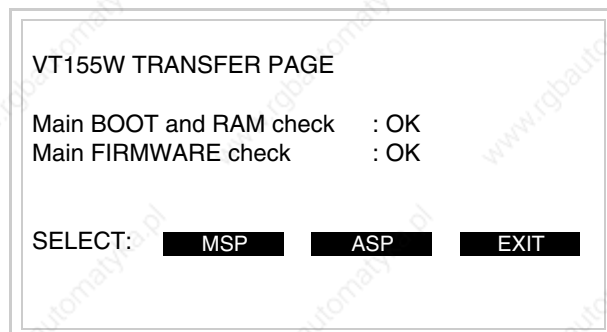

- Switch off the terminal
- Reposition J1 on pins 1-2
- Replace the back cover
- Switch on the terminal again

The calibration procedure has finished; if the calibration has been carried out wrongly or imprecisely, repeat the procedure.

Termination of CAN line

This paragraph applies only to the CAN series. The VT in question integrates the termination resistances of the serial line (typically 120 ohms) which can be inserted by means of a jumper (preset on 1-2, line not terminated). To activate the termination:

- Make sure the device is not connected to the power supply.
- Remove the cover.
- Identify the jumper unit J5.

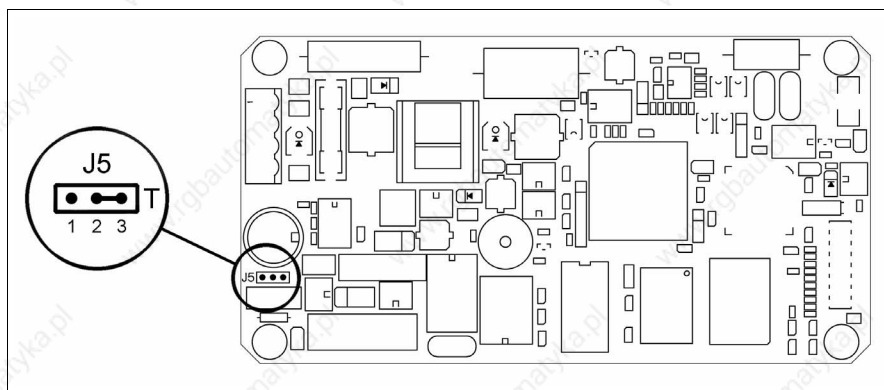

- Position the jumper between pins 2 and 3 (line terminated).
- Replace the back cover.
- Reconnect the power supply.

Introducing the MAC address

This paragraph relates only to the Ethernet series. The Media Access Control (MAC) address unambiguously identifies each terminal connected in the Ethernet network. The terminal is acquired with the address already programmed and is shown on the display of the terminal in the transfer page.

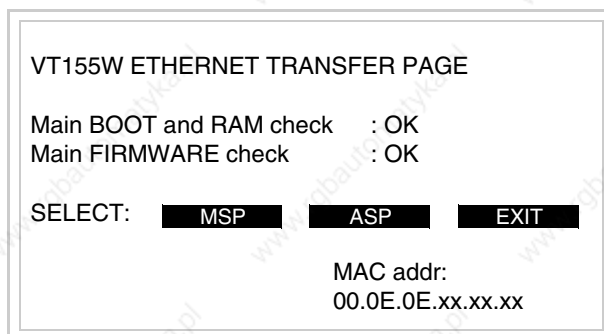

The MAC address is permanently memorized in the terminal, but should it be necessary to execute an “aided” BOOT update (see Software Manual “Chapter 14 -> BOOT update”) the address is lost.

⚠ This operation must be carried out only with the advice of the ESA Customer Care Department.

Terminals with no valid MAC address when switched present a mask for its insertion. If no MAC address belonging to the terminal is available, proceed as follows:

- Check that the VT is not connected to the power supply.
- Remove the back cover

- Locate the label carrying the MAC address

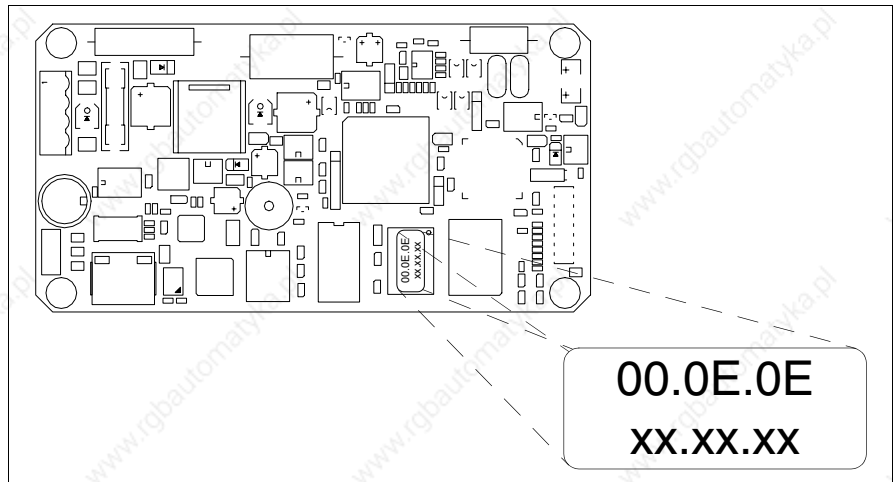

- Make a note of the number on the label (e.g. 00.0E.0E.00.00.01)

00.0E.0E -> fixed part that identifying as an ESA product
 XX.XX.XX -> variable part different for each terminal

- Reconnect the power supply to the terminal and, if necessary, calibrate the touch screen (see Page 12-15)
- Replace the back cover
- Switch on the terminal again
- The following mask appears; introduce the address previously noted down (e.g. 00.0E.0E.00.00.01)

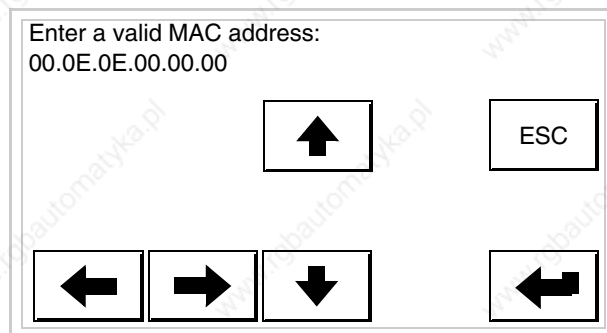

- Use the arrow  to make the setting. Once the address has been confirmed the following page is displayed

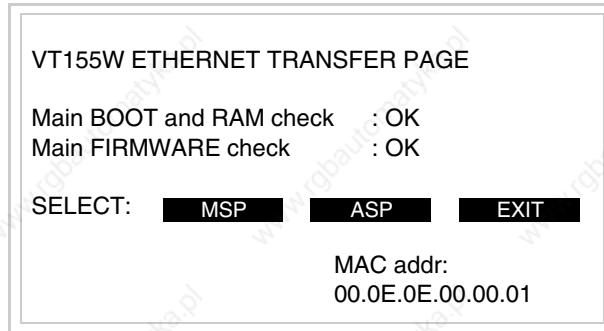

The procedure is now terminated.

! Should a wrong MAC address have been inserted contact the ESA Customer Care Department.

! A wrong address could give rise to an error of conflict between VT terminals in the Ethernet network.

Transfer PC -> VT

For everything to function properly, the first time the VT operator terminal is switched on it needs to be correctly loaded, that is it needs to have transferred to it:

- Firmware
- Communication driver
- Project

(Given that the transfer of the three files in practice occurs with a single operation, it will be defined as “Project transfer” for the sake of simplicity.)

For this it is essential that the VT be prepared to receive the transfer. (See also “Chapter 37 -> Command area”).

Preparation for reception

The program VTWIN (see Software Manual) must be used for the transfer, but the terminal must be set up to receive. This means carrying out the following steps:

- Check that the VT is off
- Check that there is a serial connection between the PC and the VT
- Switch on the VT and wait for the following mask to appear
- Press one after the other the diagonally opposite corners free of settable objects or buttons (at least one corner needs to be free)



and wait a moment, or, using the appropriate button (see Page 12-24), till the VT displays the following mask

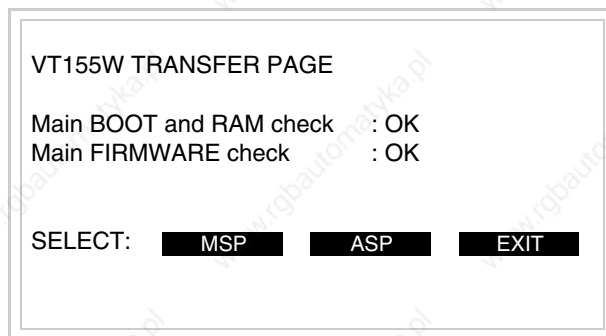

- Choose the port you intend to use for the transfer (MSP or ASP); touch the relevant  on the display. The following mask will appear

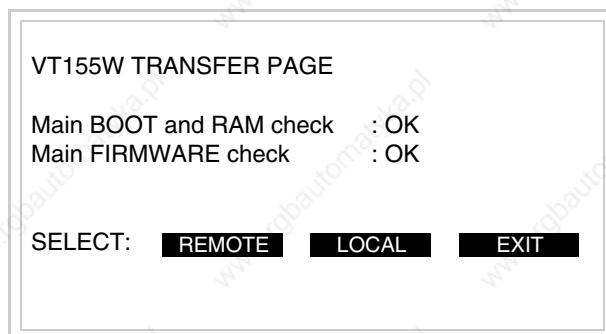

- Choose the required transfer mode: MODEM if you intend to use a modem or PC if you intend to use a serial port; touch the relevant  on the display

If the choose made is PC, the VT is ready to receive (see Software Manual for transfer), if, on the other hand, you choose MODEM, the following

mask will appear

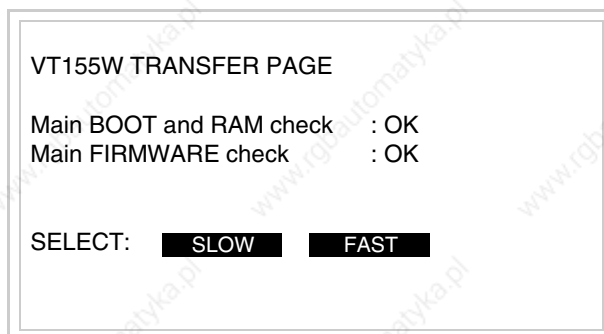

The choice should be according to the speed you intend to use for the transfer (Slow=9600bit/sec or Fast=38400bit/sec), touch the relevant  on the display. The VT is now ready to receive (see Software Manual for the transfer).

Information relating to driver

After the project has been transferred, the VT can make available information relating to what has been loaded. The information regards:

- Serial ports present
- The name of the driver loaded
- The version of the driver loaded
- Network address of the VT
- Last error to have occurred

To acquire this information carry out the following operations:

- Be situated in any page of the project
- Press two diagonally opposed angles that are free of any settable objects or buttons (at least one angle must be free)



and you will see

Port	:	xxxxxxxxxxxxxxxxxxxxxx	PROG
Driver	:	xxxxxxxxxxxxxxxxxxxxxx	TRAN
Ver	:	xxxxxxxxxxxxxxxxxxxxxx	PAGE
Addr VT	:	xxxxxxxxxxxxxxxxxxxxxx	➔
Error	:	xxxxxxxxxxxxxxxxxxxxxx	ESC

There is one of these pages for each communication port; movement between the various pages is effected by pressing .

From this page you can:

- Set the clock and the contrast
- Prepare the VT to receive the program

Setting the clock and the contrast:

To set the clock and the contrast, while displaying the above illustrated page, press ; the following mask appears

SET CONTRAST : ±##
SET CLOCK : ddd,dd/mm/yy hh:mm:ss
ESC

To set the contrast touch the words SET CONTRAST on the display; you will see the following mask



Use the arrow  for any variation (see “Chapter 36 -> Operation of terminal with touch screen”).

To set the clock touch the words SET CLOCK on the display; the following mask appears

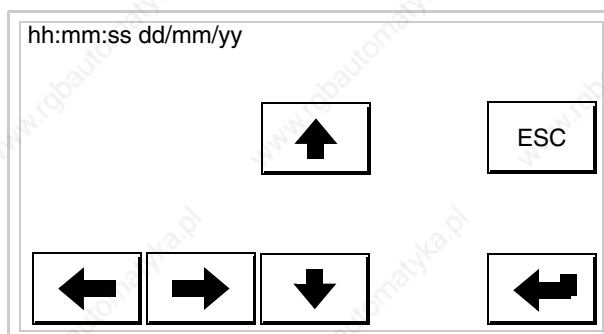

Use the arrow  for any variation (see “Chapter 36 -> Operation of terminal with touch screen”).

Prepare the VT to receive the program:

To prepare the VT to receive the program, while displaying the driver information page (see Page 12-22), press , and you will see the following mask

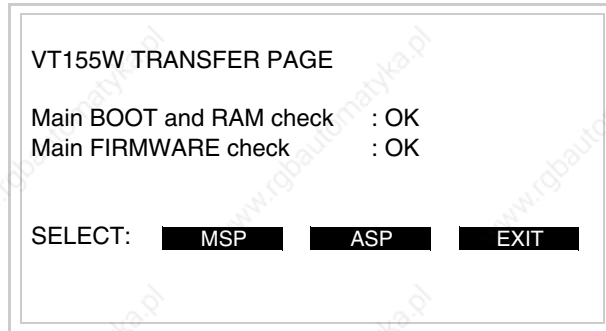

To proceed see Page 12-20.

Possible error messages that may be encountered in the driver information page are:

- PR ERR

Problem-> Errors have been detected in the data exchange between the VT and the Device.

Solution-> Check the cable; there may be disturbance.

- COM BROKEN

Problem-> Communication between VT and Device interrupted.

Solution-> Check the serial connection cable.

An error message followed by [*] indicates that the error is not currently present but was and has since disappeared.

Example: COM BROKEN*

When  is pressed you quit the display of information regarding the driver.

Adjusting the contrast on the display

To improve the quality of the representation on the display it may be necessary to adjust its contrast. This can be done by going to the page proposed (see Page 12-23) and changing the value (from +31 to -32) in evidence at that moment. Increase the value to darken the display; to lighten it, decrease the value.

We advise this to be done at typical room temperature and with the terminal at operating temperature (about 30 minutes after switching on).

Chapter 13 Video terminal VT330W

Contents	Page
Technical characteristics	13-2
Functions	13-4
Front view	13-8
Customizing label	13-10
Rear view	13-11
Dimensions and Cut-out	13-12
Accessories	13-13
Transfer PC -> VT	13-13
Preparation for reception	13-14
Information relating to driver	13-16
Improving display color quality	13-20
Adjusting the contrast on the display	13-20

This chapter consists of a total of 20 pages.

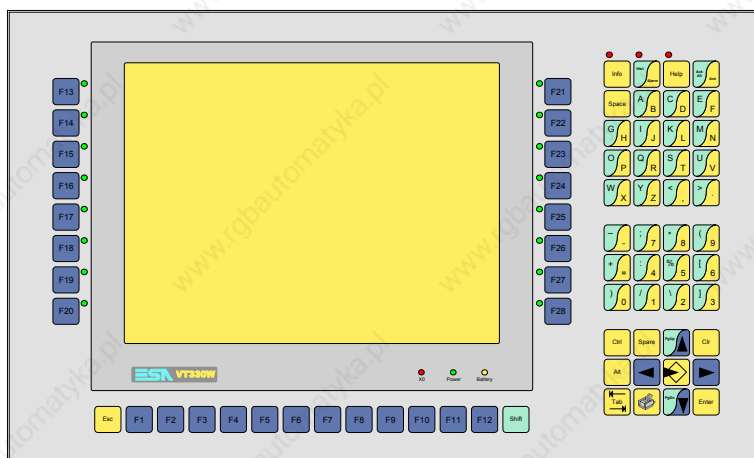

Technical characteristics

The following table lists the principal technical characteristics of the product in question.

Code of terminal		Characteristics of the terminal		
VT330W APM00				
VT330W APS00				
VT330W APT00				
Display				
Type	LCD Monochromatic STN			●
	LCD 256 Colors STN		●	
	LCD 256 Colors TFT	●		
Representational format	Graphic	●	●	●
Resolution [pixels]	640 x 480 (10,4")	●	●	●
Rows by characters	30 x 80 / 15 x 40 / 7 x 20	●	●	●
Display area size [mm]	196 x 148			●
	211,2 x 158		●	
	211,2 x 158,4	●		
Character matrix in text mode [pixels]	8 x 16 / 16 x 32 / 32 x 64	●	●	●
Character size [mm] x 1 / x 2 / x 4	2,7 x 5,4 / 5,4 x 10,7 / 10,7 x 21,4	●	●	●
Contrast adjustment	Software	●	●	●
	Automatic compensation with temperature		●	●
Character sets	Programmable fonts/TTF Windows ®	●	●	●
Backlighting				
Type	Led			
	Lamp CCFL	●	●	●
Minimum lamp-life at 25°C [hours]	15000	●	●	●
Keyboard				
Non-customizable function keys	12	●	●	●
Customizable function keys	16	●	●	●
Function key LEDs	16	●	●	●
Alphanumeric keys	27	●	●	●
Operational keys	19	●	●	●
Operational key LEDs	3	●	●	●
Diagnostic LEDs	3	●	●	●

Code of terminal	Characteristics of the terminal		
VT330W APM00			
VT330W APS00			
VT330W APT00			
User memory			
Project [Bytes]	640K + 1792K (Text + Graphics)	●	● ●
Data memory [Bytes]	256K (With back-up battery)	●	● ●
Memory for Windows ® -based fonts [Byte]	512K	●	● ●
Memory Card for backup	8Mb	●	● ●
Memory Card for expansion	4Mb (Only for Graphics)	●	● ●
Interfaces			
MSP (Multi-serial port)	RS232/RS422/RS485/TTY-20mA	●	● ●
ASP (Auxiliary serial port)	RS232/RS485	●	● ●
ASP-15L (Auxiliary serial port)	RS232/RS485		
ASP-8 (Auxiliary serial port)	RS232		
ASP-9 (Auxiliary serial port)	RS232		
LPT parallel port	Centronics	●	● ●
Auxiliary port	Connection of accessories		
Accessories			
Connectable accessories	See table "Chapter 33"	●	● ●
Clock			
Clock	Hardware (With back-up battery)	●	● ●
Networks			
Integrated	Profibus-DP		
	CAN Open (Optoisolated interface)		
	Ethernet 10/100Mbit RJ45		
Universal Bus Connector	--		
Optional	See table "Chapter 33"	●	● ●
Proprietary networks			
ESA-Net	Network server	●	● ●
	Network client	●	● ●
Technical data			
Power supply	24Vdc (18..32Vdc)		
Power absorbed at 24Vdc	15W		
Protection fuse	Ø5x20mm - 1,25A Quick Blow F		
Protection level	IP65 (front-end)		
Operating temperature	0..50°C		
Storage and transportation temperature	-20..+60°C		
Humidity (non-condensing)	<85%		
Weight	4000gr		
Dimensions			
External W x H x D [mm]	435 x 260 x 74		
Cut-out W x H [mm]	403 x 240		
Certification			
Certifications and approvals	CE, cULus, NEMA12		

Functions

The following table lists in alphabetical order all the functions of the VT in question.

Table 13.1: Functions and objects realizable with this VT (Part 1 of 4)

Code of terminal		
VT330W *****	Objects/Functions	Quantity
Alarm field		●
Alarm help	1024	●
Alarm history buffer	256	●
Alarm statistics		
Alarms (Total/active simultaneously)	1024/256	●
Arc		●
Automatic operations	32	●
Backup/Restore		●
Bar data		●
Bit-wise password	8bits	●
Buttons		
Circles		●
Command: Change language		●
Command: Clear trend buffer		●
Command: Delete recipe		●
Command: Hardcopy		●
Command: Load recipe from data memory		●
Command: Modify password		●
Command: Next page		
Command: Page help		●
Command: Password login		●
Command: Password logout		●
Command: Previous page		
Command: Print alarm history		●
Command: Printer form feed		●
Command: Quit project		●
Command: Report		●
Command: Restarts reading time-sampled trend		●
Command: Run pipeline		●
Command: Save alarms history and trend buffers in flash		
Command: Save recipe in data memory		●
Command: Save recipe received from device in buffer		●
Command: Save recipe received from device in data memory		●
Command: Send recipe from video buffer to device		●
Command: Send recipe to device		●
Command: Service page		●

Unless otherwise stated, there is no limit to the number of includable elements, only the size of project memory sets a limit. *) indicative value determined by the dimensions of the project, **) depends on memory available

Table 13.1: Functions and objects realizable with this VT (Part 2 of 4)

Code of terminal		
VT330W *****		
Objects/Functions	Quantity	▼
Command: Show alarms history		●
Command: Show page directory		
Command: Show project information		●
Command: Show recipe directory		●
Command: Show sequence directory		●
Command: Shows driver status page		
Command: Shows page help		
Command: Shows page with function: PG		
Command: Stops reading time sampled trend		●
Command: Trend reading saved in device		●
Command: Zero number of general pages		●
Date field		●
Day-of-the-week field		●
Dynamic texts: Bit-group-structured dynamic texts		●
Dynamic texts: Single-bit dynamic texts	1024*	●
Dynamic texts: Value-structured dynamic texts		●
E-keys		●
Equations	32	●
F-keys		●
Free terminal		
Function: Disables key		●
Function: Go to page		
Function: Internal command		●
Function: Invert bit value		●
Function: Macro		●
Function: None		●
Function: Reset bit permanently		●
Function: Reset real-time bit		●
Function: Sequences		●
Function: Sets bit permanently		●
Function: Sets real-time bit		●
Function: Value-structure direct command		●
Global configuration of E-keys		●
Global configuration of F-keys		●
Headers and footers (Total/Number of fields per H-F)	128/128	●
Info-messages (Total/active simultaneously)	1024/256	●
Internal registers	4096bytes	●
Labels		●
LEDs assigned to sequence		●

Unless otherwise stated, there is no limit to the number of includable elements, only the size of project memory sets a limit.
 *) indicative value determined by the dimensions of the project, **) depends on memory available

Table 13.1: Functions and objects realizable with this VT (Part 3 of 4)

Code of terminal		
VT330W *****		
Objects/Functions	Quantity	
Lines		●
Lists of bitmap images		●
Lists of texts		●
Local configuration of E-keys		●
Local configuration of F-keys		●
Macro field		
Macros (Total/Commands x macro)	1024/16	●
Message field		●
Message help	1024	●
Multilanguage texts	8 Langs.	●
Object - Indicator	256	●
Object - Potentiometer knob	256	●
Object - Selector knob	256	●
Object - Sliding potentiometer	256	●
Object - Sliding selector	256	●
Page	1024	●
Page help	1024	●
Password	10	●
Pipelines (Number/Tot bytes)	64/512	●
Print		●
Print page (Total/Number of fields per page)	1024/128	●
Programmable fonts		●
Project images		●
Public variables of ESANET network (Number/Total bytes)	256/1024	●
Recipe field for recipe structure		●
Recipes (Number of variables per recipe)	1024/512	●
Rectangles		●
Redefinable characters		
Reports	128	●
Sequences - Random	128	●
Sequences - Start/stop		●
Static bitmaps		●
Symbolic field: Bit-group-structured dynamic bitmaps	1024*	●
Symbolic field: Single-bit-structured dynamic bitmaps		●
Symbolic field: Value-structured dynamic bitmaps		●
System messages		●
System variables assigned to recipe structure		●
Time long field		●
Time short field		●

Unless otherwise stated, there is no limit to the number of includable elements, only the size of project memory sets a limit.
*) indicative value determined by the dimensions of the project, **) depends on memory available



Table 13.1: Functions and objects realizable with this VT (Part 4 of 4)





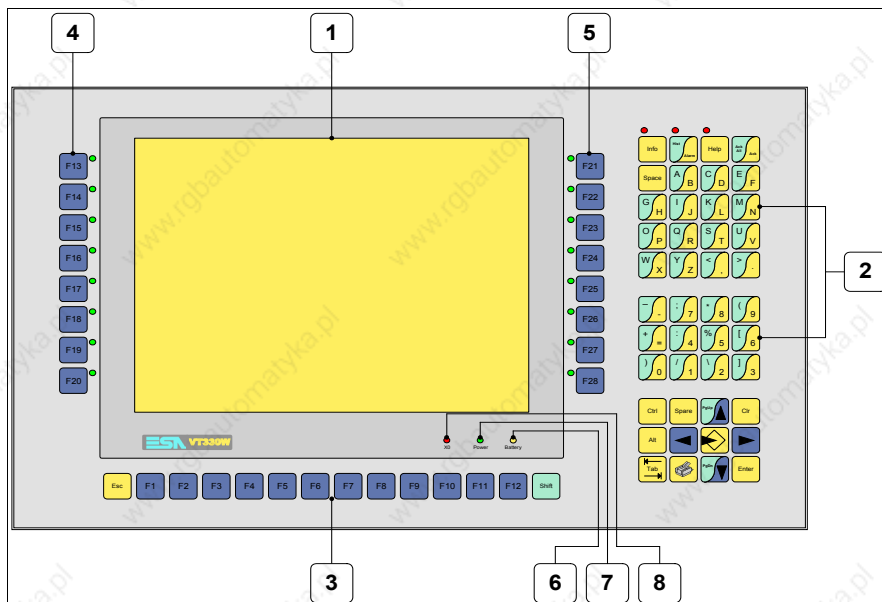









Code of terminal		
VT330W ****		
Objects/Functions	Quantity	▼
Timer	32	●
Touch Area		
Trend buffers	128	●
Trends (Trends x page/Channels x trend)	8/8	●
Trends sampled automatically (Memory/Trends/Readings)	8192bytes	●
Trends sampled on command (Memory/Trends/Readings)	/**/640	●
Value direct command: ADD		●
Value direct command: AND		●
Value direct command: OR		●
Value direct command: SET		●
Value direct command: SUBTRACT		●
Value direct command: XOR		●
Variables: Limit values and linear scaling variables	304 x pages	●
Variables: Movement variable (Mobile symbolic field)		●
Variables: Threshold variables		●
Variables: Floating Point numerical variables		●
Variables: Numerical variables (DEC, HEX, BIN, BCD)		●
Variables: String variables (ASCII)		●

Unless otherwise stated, there is no limit to the number of includable elements, only the size of project memory sets a limit.
 *) indicative value determined by the dimensions of the project, **) depends on memory available

Front view

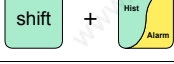

Key	Function
1	Display
2	Alphanumeric + operative keys
3	F-keys with no LED
4	F-keys with one LED
5	F-keys with one LED
6	X0 LED. Blinks when communication error is detected
7	Power LED. Lights up when power in ON
8	Battery LED. Lights up when the battery has nearly run out
	Starts input
	Confirms setting of data
	Page up When in setting phase, edits dynamic text

Key	Function
	Page down When in setting phase, edits dynamic text
	Moves the cursor between settable fields When in setting phase, moves cursor to the left of the field
	Moves the cursor between settable fields When in setting phase, moves cursor to the right of the field
	Quits: setting of data, info-messages, sequence directory, communication driver
	Displays info-messages
	Displays ISA alarms
	Displays according to context: information message help, alarm help or page help
	Acknowledgment of ISA alarms on display
	Print the entire display area
	No predefined function
	No predefined function
	No predefined function
	No predefined function
	In setting phase restores the initial value of the field
	Acknowledges all ISA alarms
	Displays the contents of the alarm buffer

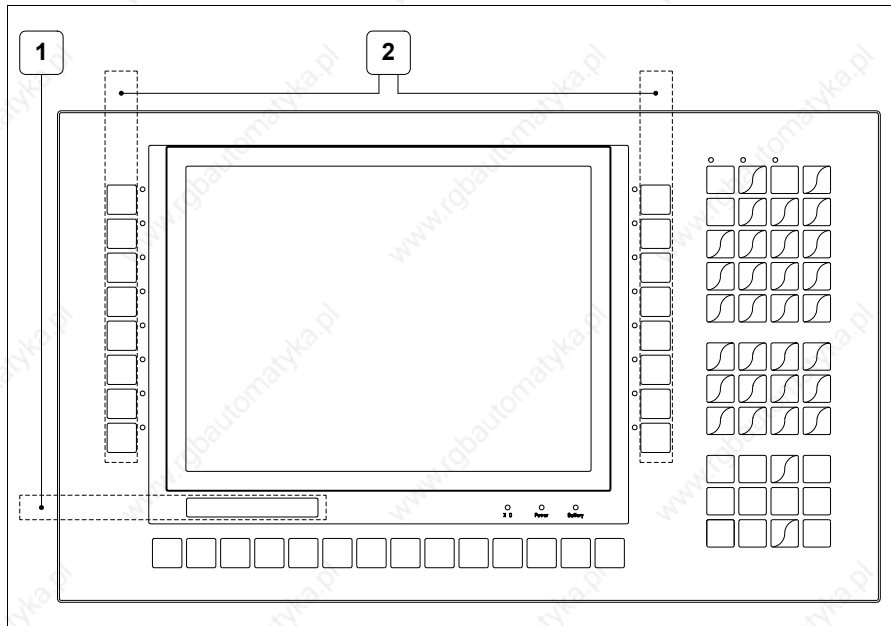
**Customizing
label**

Position	Function - Dimensions L x H (mm)
1	ESA Logo, VT Model - 162 x 13
2	F-key customization F - 17 x 207



The total thickness of the label must not exceed 125µm (micrometers). Do not use either stiff materials or glues.



Before starting to insert the customized label, see “Chapter 28 -> Inserting customized labels“.

Rear view

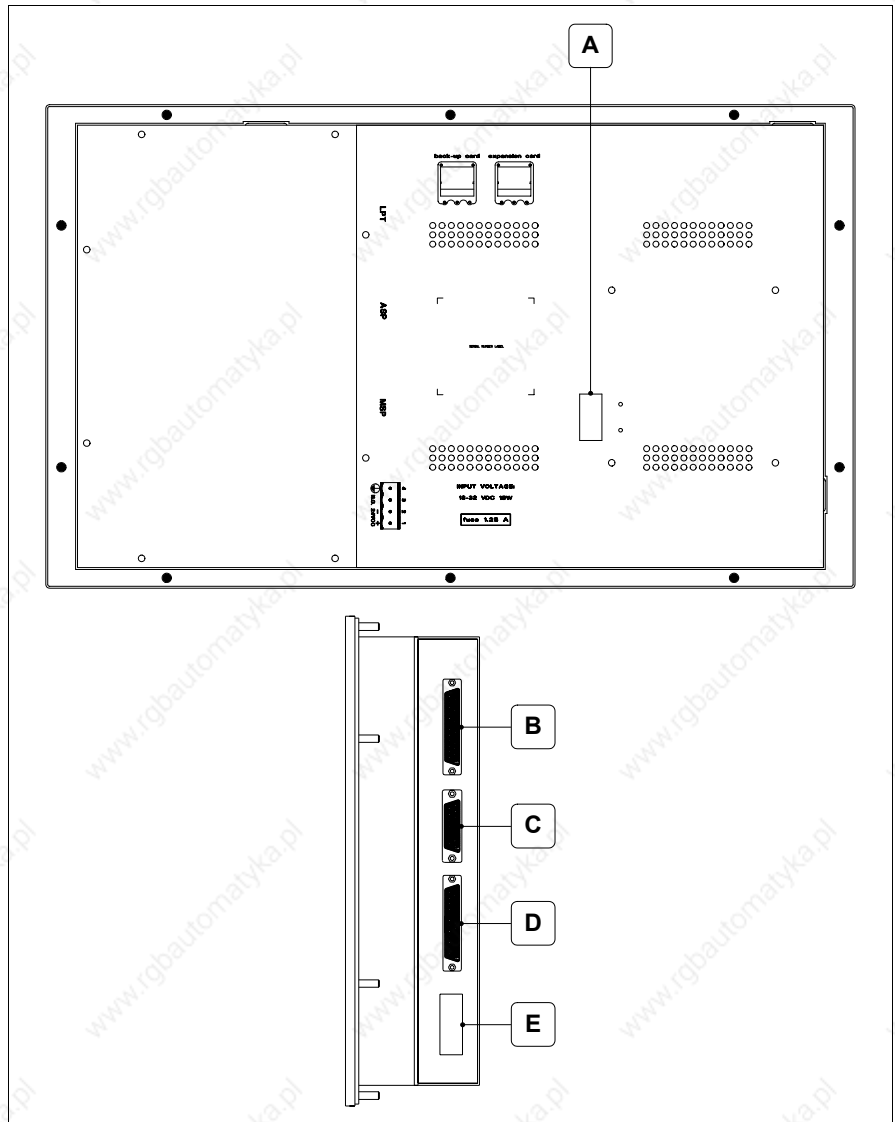

Position	Function
A	Auxiliary port for connecting optional accessories
B	LPT port for connecting printer
C	ASP serial port for communicating with PC or other devices
D	MSP serial port for communicating with PLC/PC
E	Power supply connector

**Dimensions
and Cut-out**

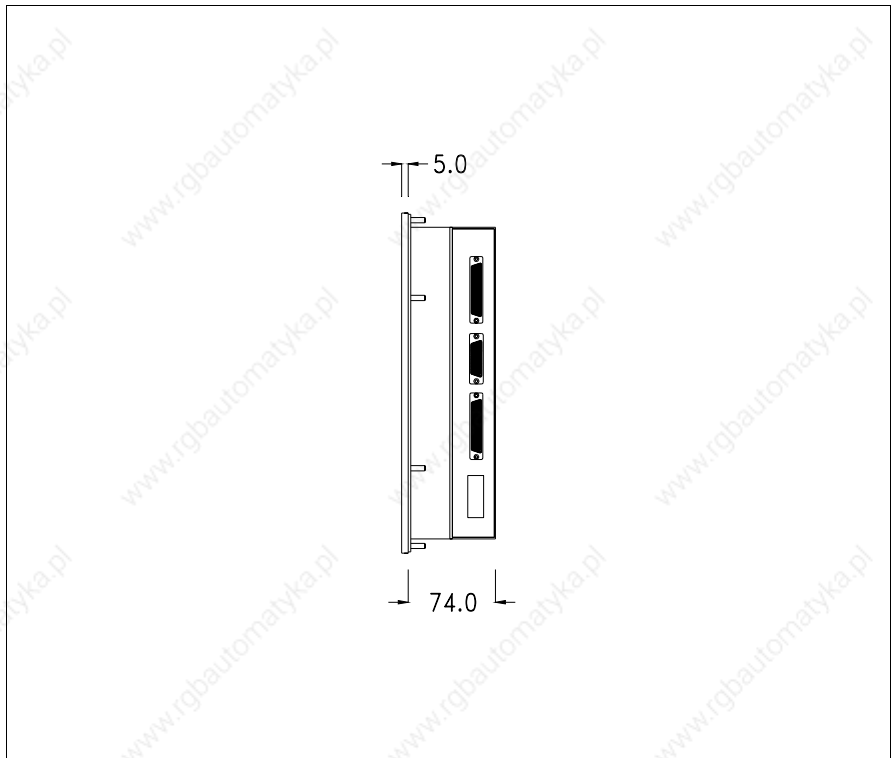
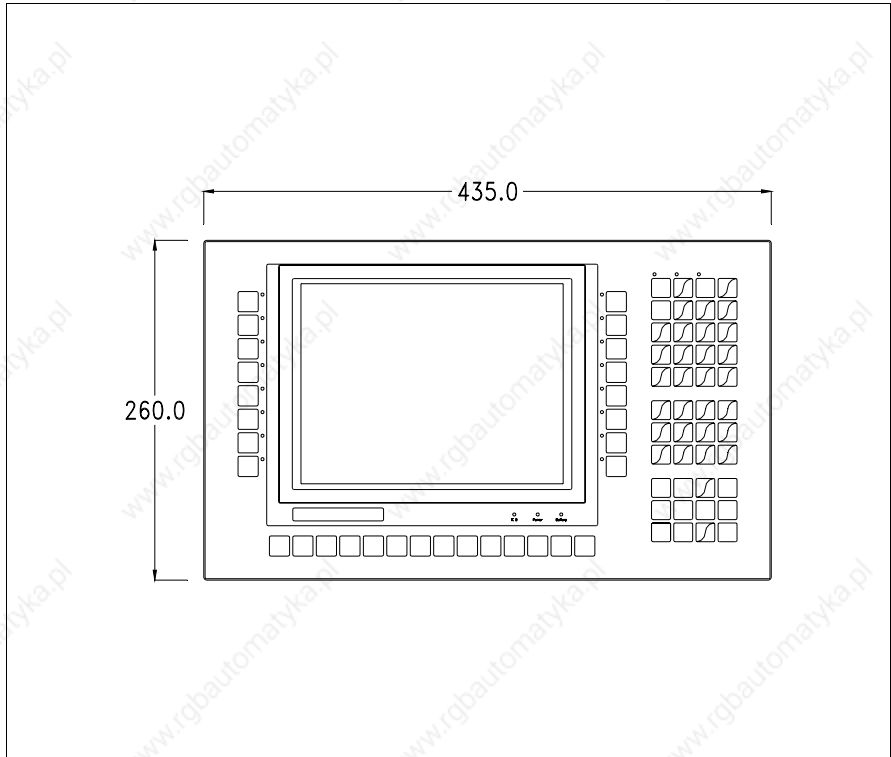

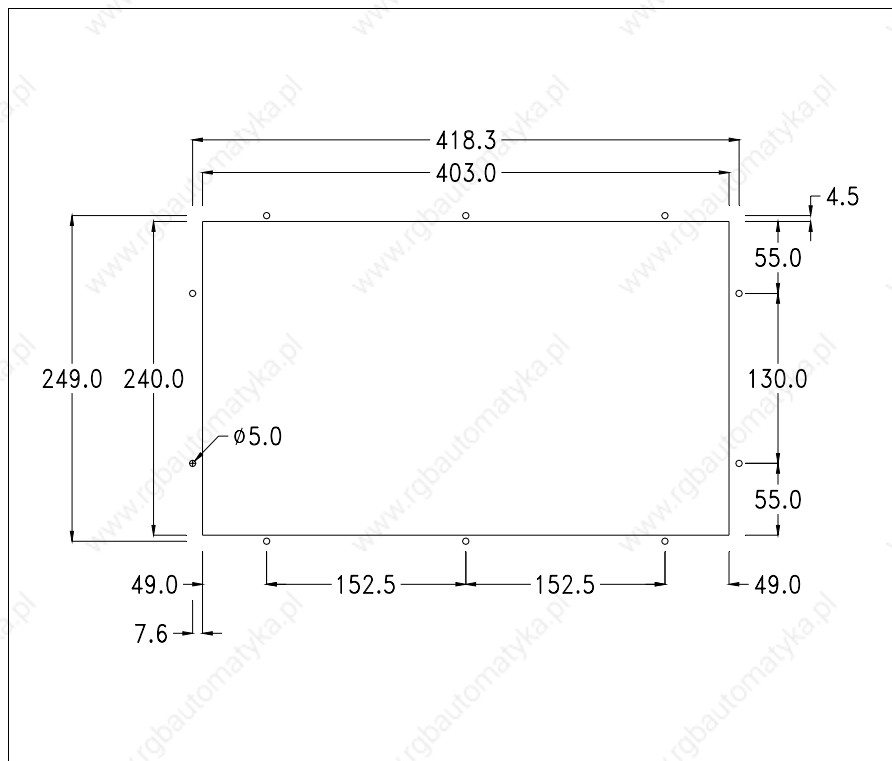

To fix the sealing gasket and secure the VT to the container see “Chapter 29 -> Mounting the terminal within the container”.

⚠ Where accessories need to be fixed in or onto the VT terminal, you are advised to do this before securing the VT to its container.

Accessories

Any accessories should be mounted in accordance with the instructions in the relevant chapter (see “Chapter 33 -> Video terminal accessories”).

Transfer PC -> VT

For everything to function properly, the first time the VT operator terminal is switched on it needs to be correctly loaded, that is it needs to have transferred to it:

- Firmware
- Communication driver
- Project



(Given that the transfer of the three files in practice occurs with a single operation, it will be defined as “Project transfer” for the sake of simplicity.)

For this it is essential that the VT be prepared to receive the transfer. (See also “Chapter 37 -> Command area”).

Preparation for reception

The program VTWIN (see Software Manual) must be used for the transfer, but the terminal must be set up to receive. This means carrying out the following steps:

- Check that the VT is off
- Check that there is a serial connection between the PC and the VT
- Switch on the VT; when the message [WAIT FOR BOOT FORCED] is

displayed, press , or with the VT on press together  + ; in either case wait a moment

VT terminal with no Modem function:

- The following mask appears. F3=MemoCARD is only enabled when a Memory Card has been inserted in the VT terminal (see Page 13-18). The function to press depends on which port you intend to use (MSP or ASP). The VT is now ready to receive (refer to Software Manual for transfer procedure)

```
VT330W TRANSFER PAGE
Graphic controller BOOT check :   OK
Graphic controller RAM check :   OK
Main BOOT and RAM check :       OK
Graphic controller synchronization : OK
Main FIRMWARE check :           NOT PRESENT
Graphic controller FIRMWARE :   ERROR

F1=MSP F2=ASP F3=MemoCARD ENTER=Prj
```

VT terminal with Modem function:

Proceed from the preceding mask; the following mask appears

VT330W TRANSFER PAGE

Graphic controller BOOT check : OK
Graphic controller RAM check : OK
Main BOOT and RAM check : OK
Graphic controller synchronization : OK
Main FIRMWARE check : NOT PRESENT
Graphic controller FIRMWARE : ERROR

F1=MODEM F2=PC ENTER=Prj

- Choose the required transfer mode: MODEM if you intend to use a modem or PC if you intend to use a serial port; press the corresponding function

If the choose made is PC, the VT is ready to receive (see Software Manual for transfer), if, on the other hand, you choose MODEM, the following mask will appear

VT330W TRANSFER PAGE

Graphic controller BOOT check : OK
Graphic controller RAM check : OK
Main BOOT and RAM check : OK
Graphic controller synchronization : OK
Main FIRMWARE check : NOT PRESENT
Graphic controller FIRMWARE : ERROR

F1=SLOW F2=FAST

The choice should be according to the speed you intend to use for the transfer (Slow=9600bit/sec or Fast=38400bit/sec), press the corresponding function . The VT is now ready to receive (see Software Manual for the transfer).

Information relating to driver

After the project has been transferred, the VT can make available information relating to what has been loaded. The information regards:

- Serial ports present
- The name of the driver loaded
- The version of the driver loaded
- Network address of the VT
- Last error to have occurred

To acquire this information carry out the following operations:



- Be situated in any page of the project
- Press  twice; you will see





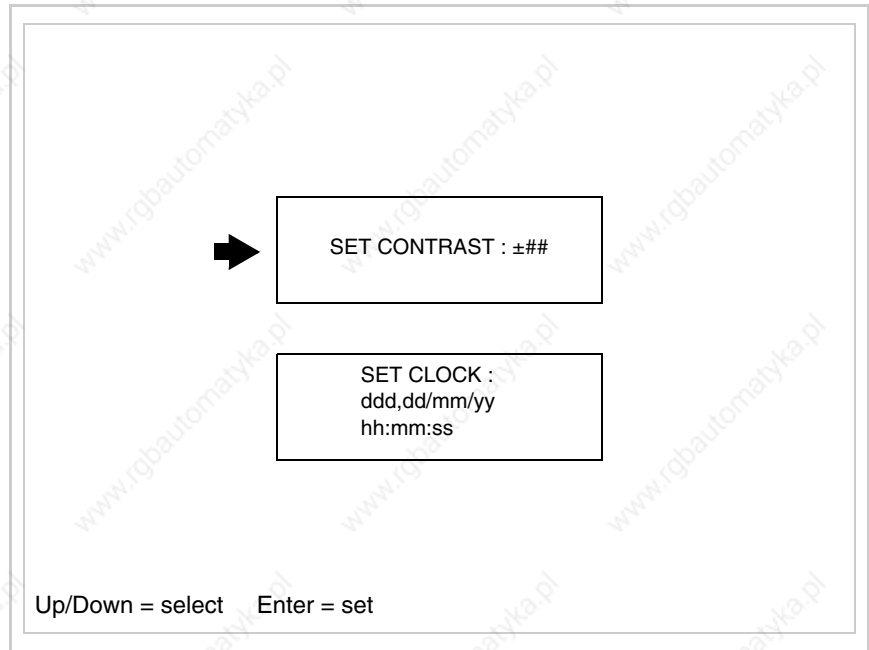

There is one of these pages for each communication port; you can move between the various pages by pressing .

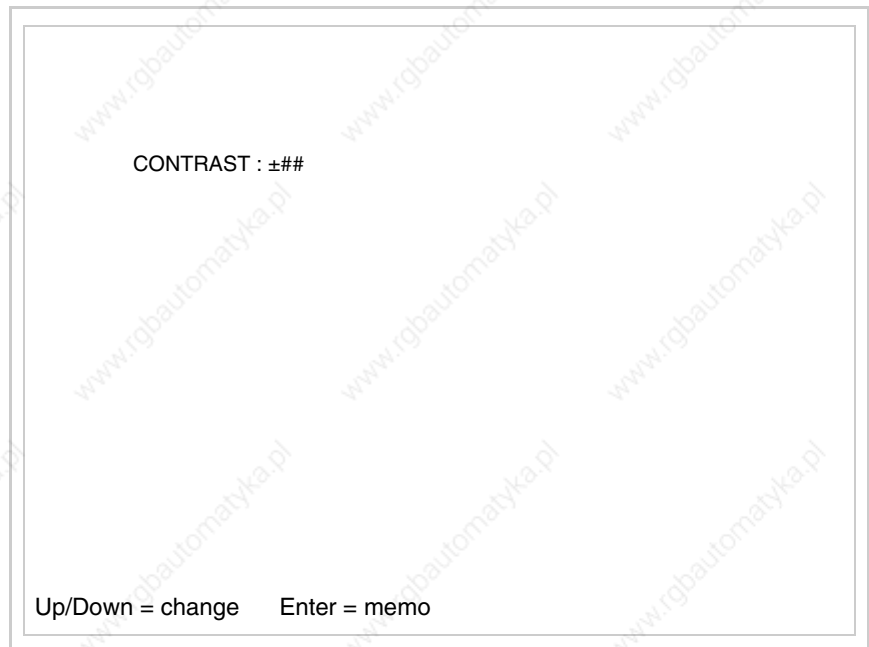

If you press  while displaying this page you can access the page for setting the clock and the contrast.



In order to access the contrast setting, use  or  to select the SET CONTRAST option that is displayed in reverse colors and press ; the following mask will appear:







Use  and/or  to effect any variation; use  for the confirmation.



To be able to set the clock use  or  to select the SET CLOCK option that is displayed in reverse colors and press ; the following mask will appear:

 For the clock to be used properly, a special battery has to be inserted in the terminal (see “Chapter 33 -> Video terminal accessories”).

hh:mm:ss dd/mm/yy

Left/Right = select Up/Down = change Enter = memo

Use  and/or  to select the field and  and/or  to effect any variation; use  to confirm.

To use the Memory Card either switch on the VT with  held down or, if the VT is already on, press  +  together; in both cases it will be necessary to wait a moment before the following mask appears on the VT:

VT330W TRANSFER PAGE

Graphic controller BOOT check : OK
Graphic controller RAM check : OK
Main BOOT and RAM check : OK
Graphic controller synchronization : OK
Main FIRMWARE check : NOT PRESENT
Graphic controller FIRMWARE : ERROR

F1=MSP F2=ASP F3=MemoCARD ENTER=Prj

Press F3=MemoCARD (if the key is not on screen, see Page 13-14); the following mask will appear:

MEMORY CARD MENU

F1= Backup ALL	F5= Restore ALL
F2= Backup FW/PRJ	F6= Restore FW/PRJ
F3= Backup RECIPES	F7= Restore RECIPE
F4= Backup ALARMS	F8= Restore ALARMS
F9= EXIT	

For the meaning and function of the keys see "Chapter 33 -> Memory card".

Possible error messages are:

- PR ERR

Problem-> Errors have been detected in the data exchange between the VT and the Device.

Solution-> Check the cable; there may be disturbance.

- COM BROKEN

Problem-> Communication between VT and Device interrupted.

Solution-> Check the serial connection cable.

An error message followed by [*] indicates that the error is not currently present but was and has since disappeared.

Example: COM BROKEN*

When  is pressed you quit the display of information regarding the driver.

Improving display color quality

To improve the color quality, adjust the contrast of the display: if the colors are too dark increase the contrast; if, on the other hand, the colors are too light, decrease the contrast.

Adjusting the contrast on the display

To improve the quality of the representation on the display it may be necessary to adjust its contrast. This can be done by going to the page proposed (see Page 13-17) and changing the value (from +63 to -64) in evidence at that moment. Increase the value to darken the display; to lighten it decrease the value.

We advise this to be done at typical room temperature and with the terminal at operating temperature (about 30 minutes after switching on and with the screen saver disabled - see Software Manual).

 **This parameter has no effect when a TFT display is used. This kind of technology does not need adjustment.**

Chapter 14 Video terminal VT185W

Contents	Page
Technical characteristics	14-2
Functions	14-4
Front view	14-8
Standard series rear view	14-9
Ethernet series rear view	14-10
Dimensions and Cut-out	14-11
Accessories	14-12
Methods of mounting	14-12
Calibration of Touch Screen	14-13
Introducing the MAC address	14-15
Transfer PC -> VT	14-17
Preparation for reception	14-18
Information relating to driver	14-19

This chapter consists of 22 pages.

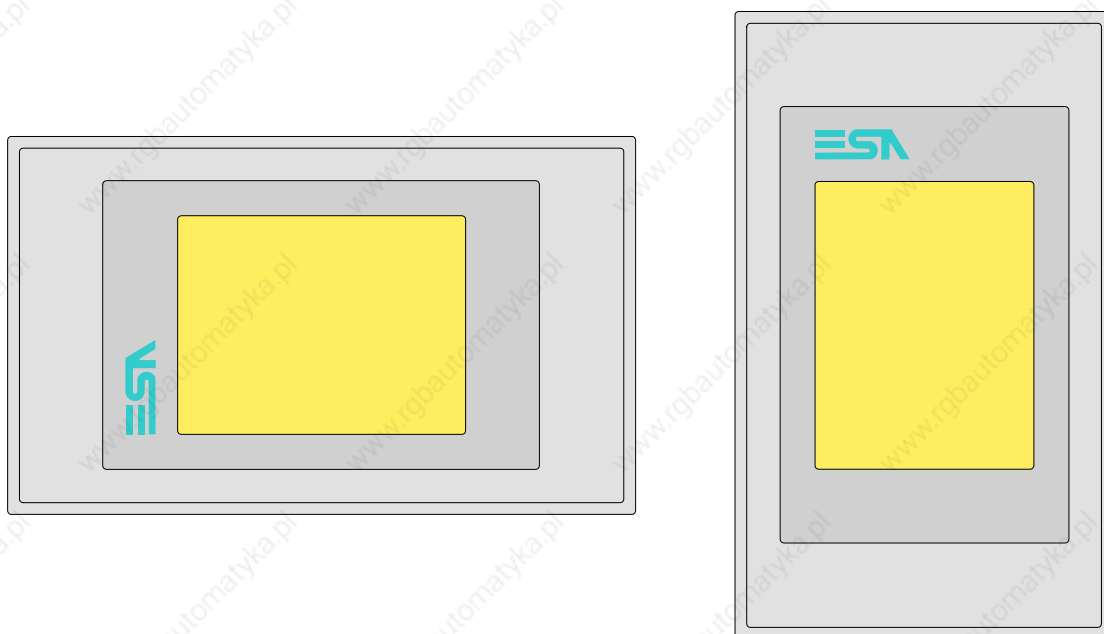
**Technical characteristics**

The following table lists the principal technical characteristics of the product in question.

Code of terminal		Characteristics of the terminal	
VT185W 00000			
VT185W 000ET			
Display			
Type	LCD 4 tones of grey STN		
	LCD 16 Colors STN		
	LCD 16 Colors TFT	●	●
Touch screen	Matrix 20 x 16 (Cell:16 x15 pixels)	●	●
Representational format	Graphic	●	●
Resolution [pixels]	320 x 240 (3,6")	●	●
Rows x characters	16 x 40 / 8 x 20 / 4 x 10 - 21 x 30* / 10 x 15* / 5 x 7*	●	●
Display area size [mm]	75,5 x 57,3	●	●
Character matrix in text mode [pixels]	8 x 15 / 16 x 30 / 32 x 60	●	●
Character size [mm] x 1 / x 2 / x 4	1,82 x 3,42 / 3,65 x 6,84 / 7,30 x 13,68	●	●
Contrast adjustment	Software		
	Automatic compensation with temperature		
Character sets	Programmable fonts/TTF Windows ®	●	●
Backlighting			
Type	LED	●	●
	CCFL lamp		
Minimum lamp-life at 25°C [hours]	--		

*) vertical mounting

Code of terminal	Characteristics of the terminal	
VT185W 0000		
VT185W 000ET		
User memory		
Project [Bytes]	960K (Text + Graphics)	● ●
Data memory [Bytes]	16K (Flash EPROM)	● ●
Memory for Windows ® -based fonts [Byte]	256K	● ●
Memory Card for backup	--	
Memory Card for expansion	--	
Interfaces		
MSP (Multi-serial port)	RS232/RS422/RS485/TTY-20mA	●
ASP (Auxiliary serial port)	RS232/RS485	
ASP-15L (Auxiliary serial port)	RS232/RS485	
ASP-8 (Auxiliary serial port)	RS232	● ●
ASP-9 (Auxiliary serial port)	RS232	
LPT parallel port	Centronics	
Auxiliary port	Connections for accessories	
Accessories		
Connectable accessories	See table "Chapter 33"	● ●
Clock		
Clock	Hardware (with Supercapacitor - Min..72h Typically130h)	● ●
Networks		
Integrated	Profibus-DP	
	CAN Open (Optoisolated interface)	
	Ethernet 10/100Mbit RJ45	●
Universal Bus Connector	--	
Optional	See table "Chapter 33"	● ●
Proprietary networks		
ESA-Net	Network server	
	Network client	● ●
Technical data		
Power supply	24Vdc (18..32Vdc)	
Power absorbed at 24Vdc	10W	
Protection fuse	Self-resetting	
Protection level	IP65 (front-end)	
Operating temperature	0..50°C	
Storage and transportation temperature	-20..+60°C	
Humidity (non-condensing)	<85%	
Weight	500gr	
Dimensions		
External W x H x D [mm]	166 x 100 x 39,6	
Cut-out W x H [mm]	157 x 91	
Certification		
Certifications and approvals	CE, cULus	

*) vertical mounting

Functions

The following table lists in alphabetical order all the functions of the VT in question.

Table 14.1: Functions and objects realizable with this VT (Part 1 of 4)

Code of terminal		
VT185W *****		
Objects/Functions	Quantity	▼
Alarm field		●
Alarm help	256	●
Alarm history buffer	256	●
Alarm statistics		
Alarms (Total/active simultaneously)	256/256	●
Arc		●
Automatic operations	32	●
Backup/Restore		●
Bar data		●
Bit-wise password	8bits	●
Buttons	320 x page	●
Circles		●
Command: Change language		●
Command: Clear trend buffer		
Command: Delete recipe		●
Command: Hardcopy		●
Command: Load recipe from data memory		●
Command: Modify password		●
Command: Next page		●
Command: Page help		●
Command: Password login		●
Command: Password logout		●
Command: Previous page		●
Command: Print alarm history		●
Command: Printer form feed		●
Command: Quit project		●
Command: Report		●
Command: Restarts reading time-sampled trend		
Command: Run pipeline		
Command: Save alarms history and trend buffers in flash		●
Command: Save recipe in data memory		●
Command: Save recipe received from device in buffer		●
Command: Save recipe received from device in data memory		●
Command: Send recipe from video buffer to device		●
Command: Send recipe to device		●
Command: Service page		●

Unless otherwise stated, there is no limit to the number of includable elements, only the size of project memory sets a limit.
*) indicative value determined by the dimensions of the project, **) depends on memory available

Table 14.1: Functions and objects realizable with this VT (Part 2 of 4)

Code of terminal		
VT185W *****		
Objects/Functions	Quantity	▼
Command: Show alarms history		●
Command: Show page directory		●
Command: Show project information		●
Command: Show recipe directory		●
Command: Show sequence directory		
Command: Shows driver status page		●
Command: Shows page help		●
Command: Shows page with function: PG		
Command: Stops reading time sampled trend		
Command: Trend reading saved in device		
Command: Zero number of general pages		●
Date field		●
Day-of-the-week field		●
Dynamic texts: Bit-group-structured dynamic texts		●
Dynamic texts: Single-bit dynamic texts	1024*	●
Dynamic texts: Value-structured dynamic texts		●
E-keys		
Equations	32	●
F-keys		
Free terminal		
Function: Disables key		
Function: Go to page		●
Function: Internal command		●
Function: Invert bit value		●
Function: Macro		●
Function: None		
Function: Reset bit permanently		●
Function: Reset real-time bit		●
Function: Sequences		
Function: Sets bit permanently		●
Function: Sets real-time bit		●
Function: Value-structure direct command		●
Global configuration of E-keys		
Global configuration of F-keys		
Headers and footers (Total/Number of fields per H-F)	32/128	●
Info-messages (Total/active simultaneously)	256/256	●
Internal registers	4096bytes	●
Labels		●
LEDs assigned to sequence		

Unless otherwise stated, there is no limit to the number of includable elements, only the size of project memory sets a limit.
 *) indicative value determined by the dimensions of the project, **) depends on memory available

Table 14.1: Functions and objects realizable with this VT (Part 3 of 4)

Code of terminal		
VT185W *****		
Objects/Functions	Quantity	▼
Lines		●
Lists of bitmap images		●
Lists of texts		●
Local configuration of E-keys		
Local configuration of F-keys		
Macro field		
Macros (Total/Commands x macro)	1024/16	●
Message field		●
Message help	256	●
Multilanguage texts	6 Langs.	●
Object - Indicator	256	●
Object - Potentiometer knob	256	●
Object - Selector knob	256	●
Object - Sliding potentiometer	256	●
Object - Sliding selector	256	●
Page	150	●
Page help	150	●
Password	10	●
Pipelines (Number/Tot bytes)		
Print		●
Print page (Total/Number of fields per page)	64/128	●
Programmable fonts		●
Project images		●
Public variables of ESANET network (Number/Total bytes)		
Recipe field for recipe structure		●
Recipes (Number of variables per recipe)	128/256	●
Rectangles		●
Redefinable characters		
Reports	32	●
Sequences - Random		
Sequences - Start/stop		
Static bitmaps		●
Symbolic field: Bit-group-structured dynamic bitmaps		●
Symbolic field: Single-bit-structured dynamic bitmaps	1024*	●
Symbolic field: Value-structured dynamic bitmaps		●
System messages		●
System variables assigned to recipe structure		●
Time long field		●
Time short field		●

Unless otherwise stated, there is no limit to the number of includable elements, only the size of project memory sets a limit.
*) indicative value determined by the dimensions of the project, **) depends on memory available

Table 14.1: Functions and objects realizable with this VT (Part 4 of 4)

Code of terminal		
VT185W ****		
Objects/Functions	Quantity	▼
Timer	32	●
Touch Area	24	●
Trend buffers	128	●
Trends (Trends x page/Channels x trend)	32/8	●
Trends sampled automatically (Memory/Trends/Readings)	6144bytes	●
Trends sampled on command (Memory/Trends/Readings)	/**/320	●
Value direct command: ADD		●
Value direct command: AND		●
Value direct command: OR		●
Value direct command: SET		●
Value direct command: SUBTRACT		●
Value direct command: XOR		●
Variables: Limit values and linear scaling variables	48 x pages	●
Variables: Movement variable (Mobile symbolic field)		●
Variables: Threshold variables		●
Variables: Floating Point numerical variables		●
Variables: Numerical variables (DEC, HEX, BIN, BCD)		●
Variables: String variables (ASCII)		●

Unless otherwise stated, there is no limit to the number of includable elements, only the size of project memory sets a limit.
 *) indicative value determined by the dimensions of the project, **) depends on memory available

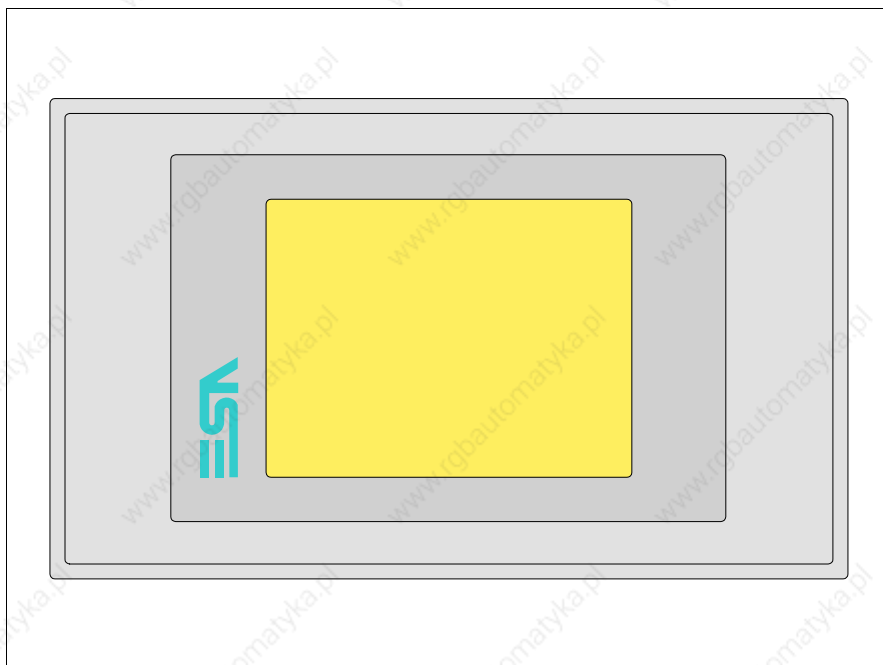
Front view

All buttons and signals are defined using the programming software (see Software Manual).

Standard series rear view

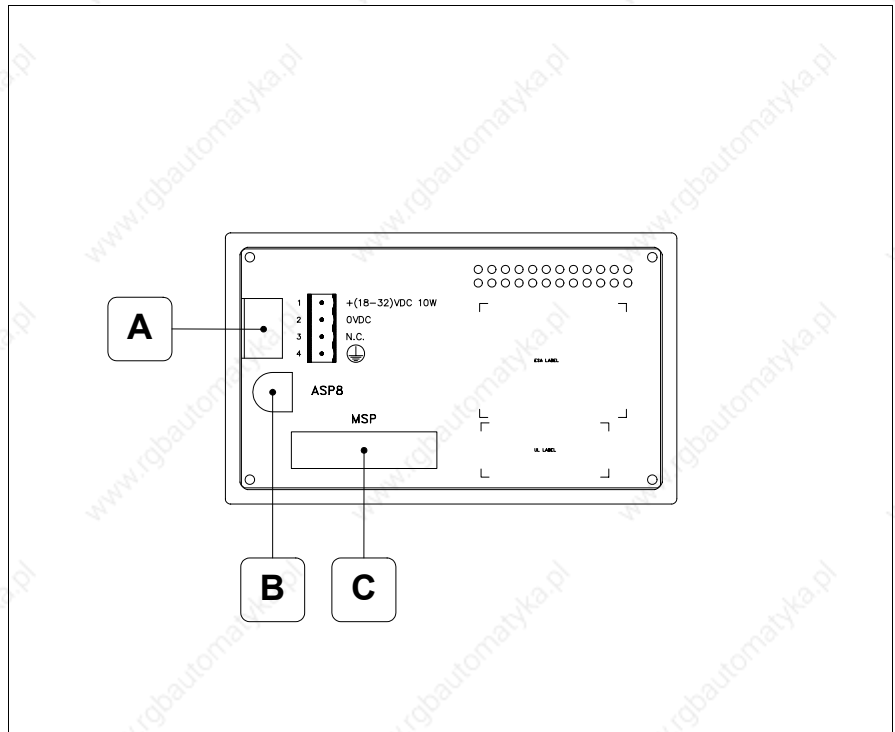

Position	Function
A	Power supply connector
B	ASP serial port for communicating with PC or other devices
C	MSP serial port for communicating with PLC/PC

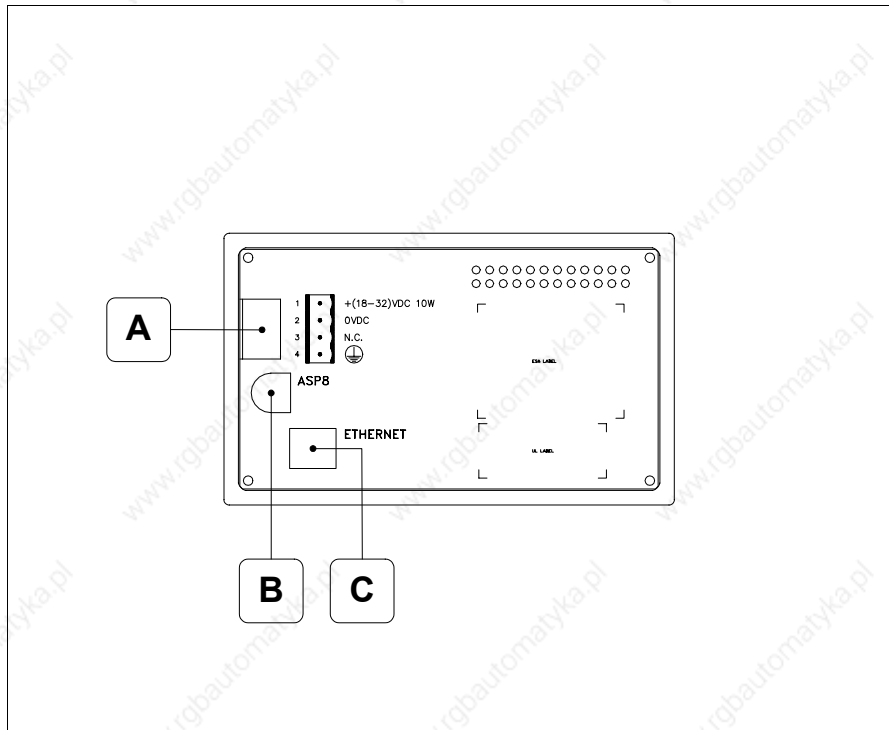
**Ethernet
series rear
view**

Position	Function
A	Power supply connector
B	ASP serial port for communicating with PC or other devices
C	Ethernet network 10/100Mbit RJ45 (For the diagnostic mode of the LEDs see "Chapter 30 -> Ethernet port")

Dimensions and Cut-out

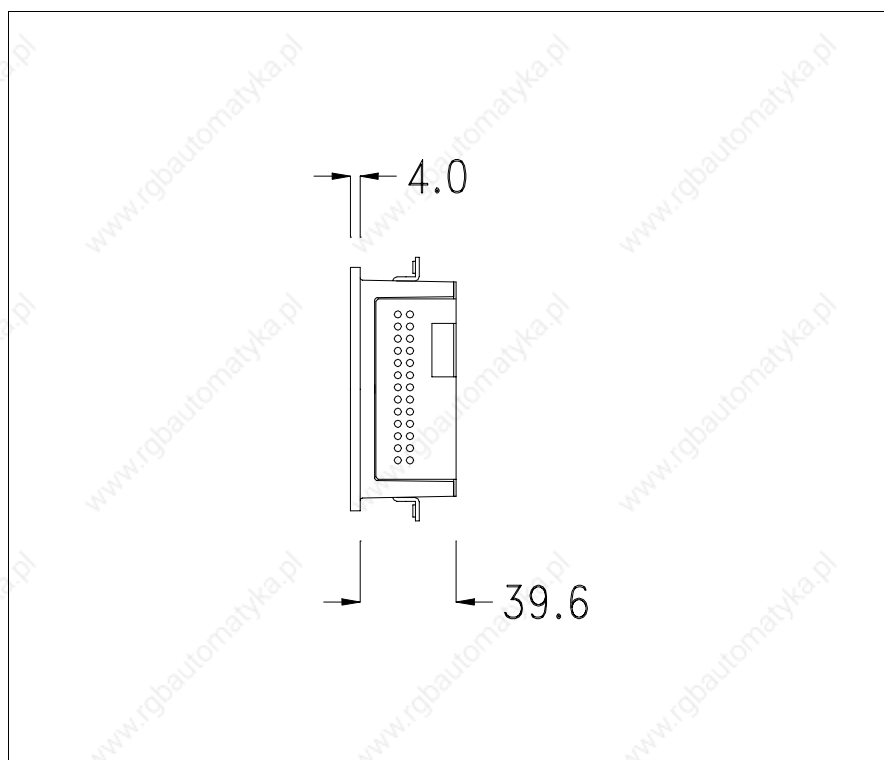
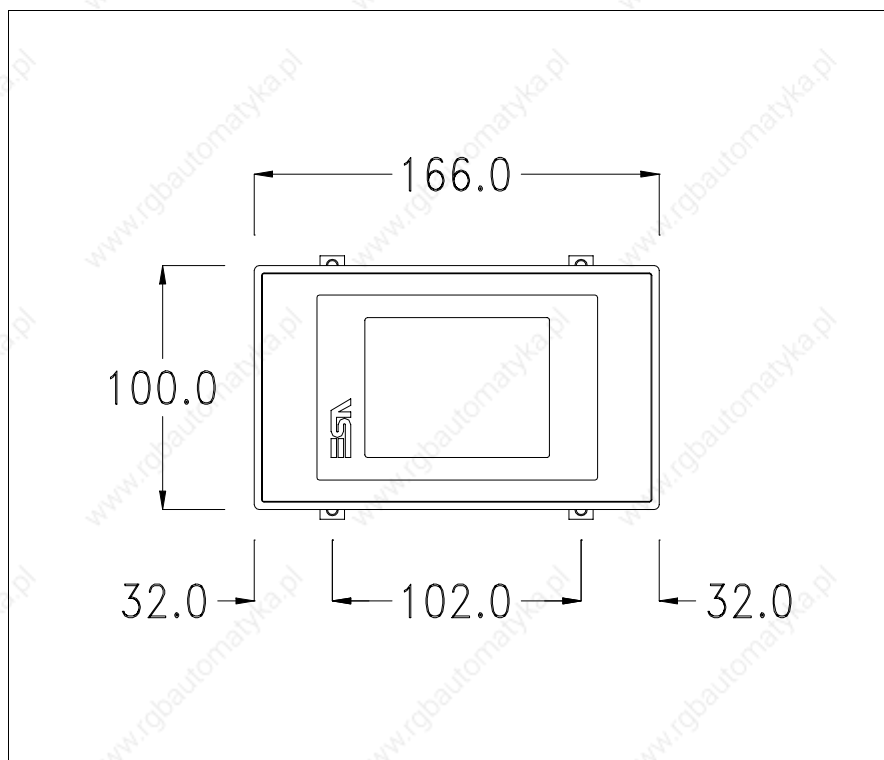

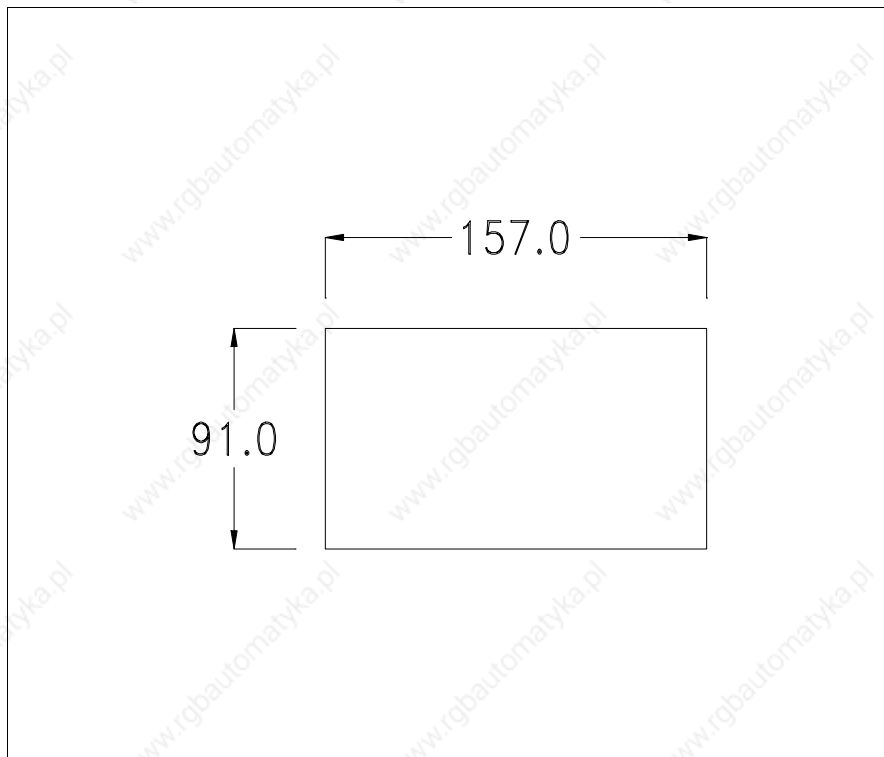

To fix the sealing gasket and secure the VT to the container see “Chapter 29 -> Mounting the terminal within the container“.

⚠ Where accessories need to be fixed in or onto the VT terminal, you are advised to do this before securing the VT to its container.

Accessories

Any accessories should be mounted in accordance with the instructions in the relevant chapter (see “Chapter 33 -> Video terminal accessories“).

Methods of mounting

There are two ways of mounting the VT185W on the container, horizontally or vertically. Once you have chosen the direction that means you can see the project properly and you are in the project creation phase, choose the terminal with the same orientation (see Software Manual “Chapter 5 -> New...“).

⚠ Once the orientation has been defined, you are recommended not to change it, as the project created could then become unusable.

⚠ To orientate the terminal correctly use the logo on the front fascia as a reference.

Below are listed the terminals with their respective correct orientations.

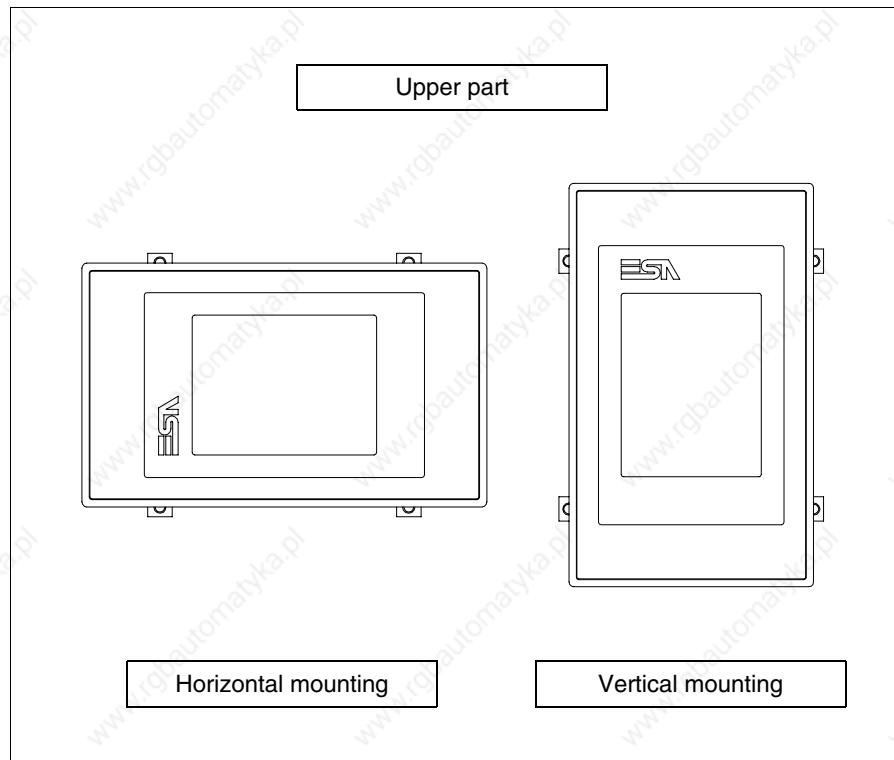

Calibration of Touch Screen

The screen of VT185W is made of resistive, sensitive glass; for this type of glass to work properly it requires a calibration procedure (**the terminal is already calibrated when supplied**), that is, the resistive area of the glass has to be adjusted to the visible are of the display.

Should it be thought necessary to repeat the calibration procedure this can be done by following the instructions set out below.

⚠ The procedure must be carried out with great care as the precision of the keys area depends on the calibration.

How to perform the calibration procedure:

- Make sure the VT is not connected to the power supply
- Remove the back cover
- Identify jumper J1

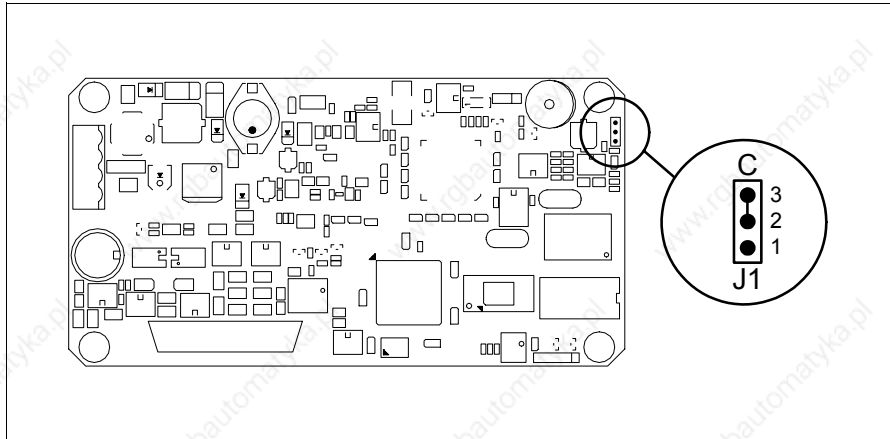

- Position J1 on pins 2-3 (C)
- Reconnect the power supply and switch on the terminal; the following mask appears

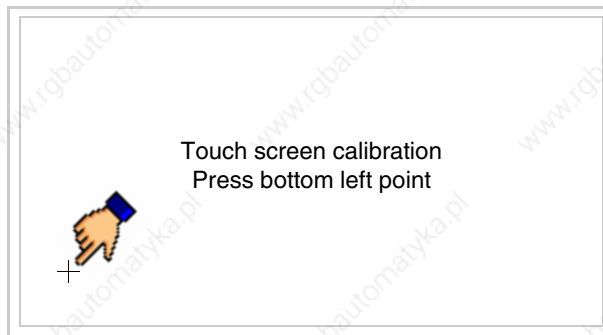

- Touch the corner indicated in the figure; then the following page appears on screen



- Touch the corner indicated in the figure to complete the calibration procedure; the following page now appears

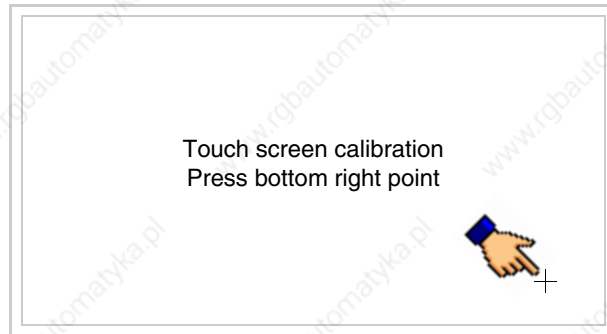

- Wait a few moments until the VT displays either the following mask or the project page (the page may be slightly different in its wording depending on which series the terminal belongs to)

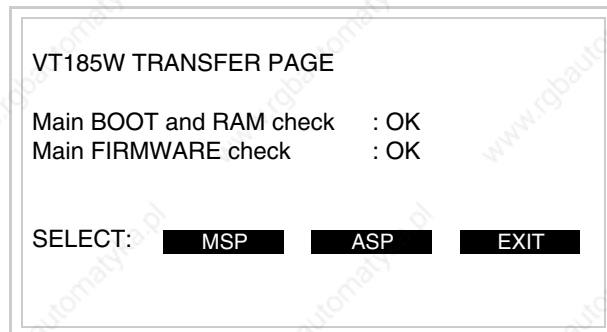

- Switch off the terminal
- Reposition J1 on pins 1-2
- Replace the back cover
- Switch on the terminal again

The calibration procedure has finished; if the calibration has been carried out wrongly or imprecisely, repeat the procedure.

Introducing the MAC address

This paragraph relates only to the Ethernet series. The Media Access Control (MAC) address unambiguously identifies each terminal connected in the Ethernet network. The terminal is acquired with the address already programmed and is shown on the display of the terminal in the transfer page.

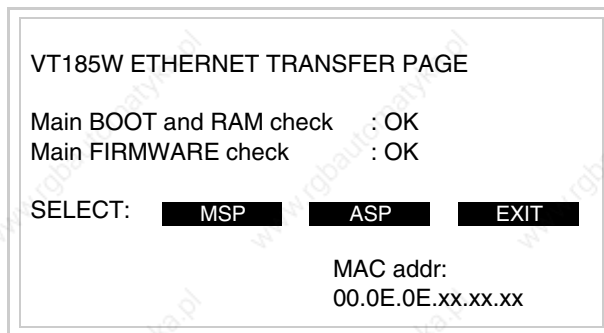

The MAC address is permanently memorized in the terminal, but should it be necessary to execute an “aided” BOOT update (see Software Manual “Chapter 14 -> BOOT update”) the address is lost.

⚠ This operation must be carried out only with the advice of the ESA Customer Care Department.

Terminals with no valid MAC address when switched present a mask for its insertion. If no MAC address belonging to the terminal is available, proceed as follows:

- Check that the VT is not connected to the power supply.
- Remove the back cover
- Locate the label carrying the MAC address

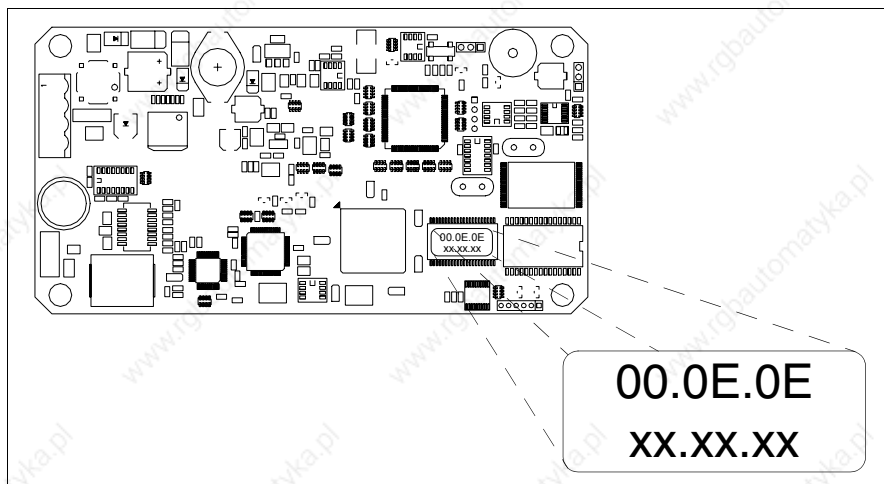

- Make a note of the number on the label (e.g. 00.0E.0E.00.00.01)

00.0E.0E -> fixed part that identifying as an ESA product
xx.xx.xx -> variable part different for each terminal

- Reconnect the power supply to the terminal and, if necessary, calibrate the touch screen (see Page 14-13)
- Replace the back cover
- Switch on the terminal again
- The following mask appears; introduce the address previously noted down (e.g. 00.0E.0E.00.00.01)

Enter a valid MAC address:
00.0E.0E.00.00.00

Navigation buttons: Up, Down, Left, Right, and ESC.

- Use the arrow  to make the setting. Once the address has been confirmed the following page is displayed

VT185W ETHERNET TRANSFER PAGE

Main BOOT and RAM check : OK
Main FIRMWARE check : OK

SELECT: **MSP** **ASP** **EXIT**

MAC addr:
00.0E.0E.00.00.01

The procedure is now terminated.

 **Should a wrong MAC address have been inserted contact the ESA Customer Care Department.**

 **A wrong address could give rise to an error of conflict between VT terminals in the Ethernet network.**

Transfer PC -> VT

For everything to function properly, the first time the VT operator terminal is switched on it needs to be correctly loaded, that is it needs to have transferred to it:

- Firmware
- Communication driver
- Project

(Given that the transfer of the three files in practice occurs with a single operation, it will be defined as “Project transfer” for the sake of simplicity.)

For this it is essential that the VT be prepared to receive the transfer. (See also “Chapter 37 -> Command area“).

Preparation for reception

The program VTWIN (see Software Manual) must be used for the transfer, but the terminal must be set up to receive. This means carrying out the following steps:

- Check that the VT is off
- Check that there is a serial connection between the PC and the VT
- Switch on the VT and wait for the following mask to appear
- Press one after the other the diagonally opposite corners free of settable objects or buttons (at least one corner needs to be free)



and wait a moment, or, using the appropriate button (see Page 14-21), till the VT displays the following mask

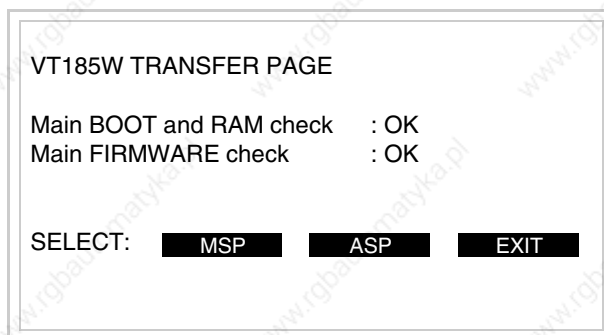

- Choose the port you intend to use for the transfer (MSP or ASP); touch the relevant on the display. The following mask will appear

VT185W TRANSFER PAGE

Main BOOT and RAM check : OK
Main FIRMWARE check : OK

SELECT: REMOTE LOCAL EXIT

- Choose the required transfer mode: MODEM if you intend to use a modem or PC if you intend to use a serial port; touch the relevant on the display

If the choose made is PC, the VT is ready to receive (see Software Manual for transfer), if, on the other hand, you choose MODEM, the following mask will appear

VT185W TRANSFER PAGE

Main BOOT and RAM check : OK
Main FIRMWARE check : OK

SELECT: SLOW FAST

The choice should be according to the speed you intend to use for the transfer (Slow=9600bit/sec or Fast=38400bit/sec), touch the relevant on the display. The VT is now ready to receive (see Software Manual for the transfer).

Information relating to driver

After the project has been transferred, the VT can make available information relating to what has been loaded. The information regards:

- Serial ports present
- The name of the driver loaded
- The version of the driver loaded
- Network address of the VT
- Last error to have occurred

To acquire this information carry out the following operations:

- Be situated in any page of the project
- Press two diagonally opposed angles that are free of any settable objects or buttons (at least one angle must be free)



and you will see



There is one of these pages for each communication port; movement between the various pages is effected by pressing .

From this page you can:

- Set the clock
- Prepare the VT to receive the program

Setting the clock:

To set the clock, while displaying the above illustrated page, press



; the following mask appears

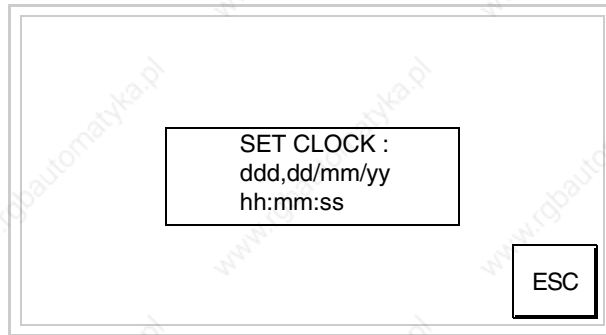

To set the clock touch the words SET CLOCK on the display; the following mask appears

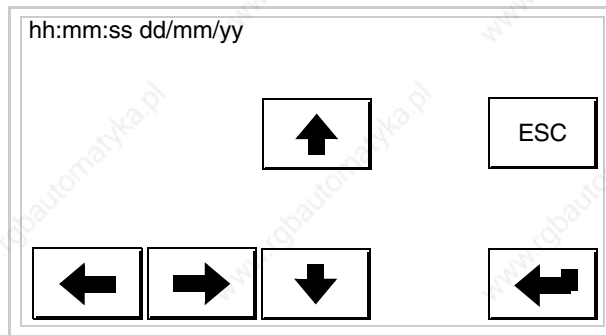

Use the arrow  for any variation (see “Chapter 36 -> Operation of terminal with touch screen”).

Prepare the VT to receive the program:

To prepare the VT to receive the program, while displaying the driver information page (see Page 14-19), press , and you will see the following mask

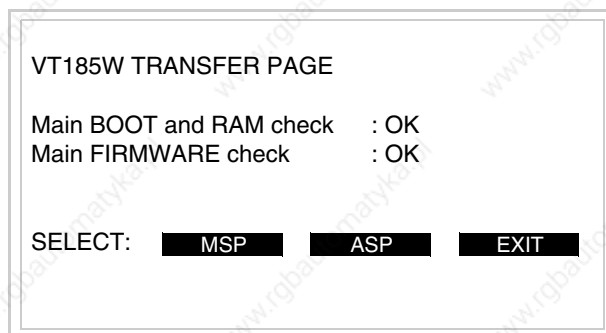

To proceed see Page 14-18.

Possible error messages that may be encountered in the driver information page are:

- PR ERR

Problem-> Errors have been detected in the data exchange between the VT and the Device.

Solution-> Check the cable; there may be disturbance.

- COM BROKEN

Problem-> Communication between VT and Device interrupted.

Solution-> Check the serial connection cable.

An error message followed by [*] indicates that the error is not currently present but was and has since disappeared.

Example: COM BROKEN*

When  is pressed you quit the display of information regarding the driver.

Chapter 15 Video terminal VT505H

Contents	Page
Technical characteristics	15-2
Functions	15-5
Front view	15-9
Rear view	15-10
Dimensions and Cut-out	15-11
Accessories	15-12
Connection cable	15-12
Adjusting holding strap for grip	15-12
Calibration of Touch Screen	15-12
Transfer PC -> VT	15-15
Preparation for reception	15-15
Information relating to driver	15-17
Adjusting the contrast on the display	15-22

This chapter consists of 22 pages.



Technical characteristics

The following table lists the principal technical characteristics of the product in question.

Code of terminal	Characteristics of the terminal	
VT505H 00000		
VT505H 000CN		
Display		
Type	LCD 4 tones of blue STN	● ●
	LCD 16 Colors STN	
	LCD 16 Colors TFT	
Touch screen	Matrix 20 x 16 (Cell:16x15 pixels)	● ●
Representational format	Graphic	● ●
Resolution [pixels]	320 x 240 (5,7")	● ●
Rows x characters	16 x 40 / 8 x 20 / 4 x 10	● ●
Display area size [mm]	115,2 x 86,4	● ●
Character matrix in text mode [pixels]	8 x15 / 16 x 30 / 32 x 60	● ●
Character size [mm] x 1 / x 2 / x 4	2,8 x 5,2 / 5,6 x 10,4 / 11,2 x 20,8	● ●
Contrast adjustment	Software	● ●
	Automatic compensation with temperature	● ●
Character sets	Programmable fonts/TTF Windows ®	● ●
Backlighting		
Type	LED	
	CCFL lamp	● ●
Minimum lamp-life at 25°C [hours]	15000	● ●

1 - Using the VTHCB card (see "Chapter 33 -> Page 9")

2 - RS232 only

Code of terminal	Characteristics of the terminal	
VT505H 00000		
VT505H 000CN		
Keyboard		
Non-customizable function keys	10	● ●
User memory		
Project [Bytes]	640K	● ●
Data memory [Bytes]	16K (Flash EPROM)	● ●
Memory for Windows ® -based fonts [Byte]	32K	● ●
Memory Card for backup	--	
Memory Card for expansion	--	
Interfaces		
MSP (Multi-serial port)	RS232/RS422/RS485/TTY-20mA	● ² ● ¹
ASP (Auxiliary serial port)	RS232/RS485	
ASP-15L (Auxiliary serial port)	RS232/RS485	
ASP-8 (Auxiliary serial port)	RS232	
ASP-9 (Auxiliary serial port)	RS232	
LPT parallel port	Centronics	
Auxiliary port	Connections for accessories	
Accessories		
Connectable accessories	See table "Chapter 33"	● ●
Clock		
Clock	Software (no back-up battery)	● ●
Networks		
Integrated	Profibus-DP	
	CAN Open (Optoisolated interface)	●
	Ethernet 10/100Mbit RJ45	
Universal Bus Connector	--	
Optional	See table "Chapter 33"	● ●
Proprietary networks		
ESA-Net	Network server	
	Network client	●

1 - Using the VTHCB card (see "Chapter 33 -> Page 9")

2 - RS232 only

Wrapping	
Type	Antiflame PC/ABS halogen-free (UL94 5VA at 2.5mm)
Drop test	1 m.
Connection cable	
Type	Antiflame shielded cable halogen and silicone-free
Radius of curve (moving/fixed)	120mm/60mm
Conductors (number/section)	25x0,25mmq (AWG24)
System shut-down button	
Positions	2 (Normal - Pushed)
Contacts	1 NC + 1 NC (NC1/NC2 + NC3/NC4)
Maximum tension	30Vdc
Maximum/minimum current	500mA/5mA
Conforms to the following standard(s)	EN 60947-5-1, UL-508, CSA 22.2. No. 14)
Enabling button	
Positions	3 (Normal - Pushed - Panic)
Contacts	1 NC/NO + 1 NC/NO (NC1/NO1/C1 + NC2/NO2/C2)

Maximum tension	30Vdc
Maximum/minimum current	500mA/5mA
Conforms to the following standard(s)	IEC 60947-5-1, EN 60947-5-1, JIS C8201-5-1, UL-508, CSA 22.2. No. 14
Approval(s)	ISO12100/EN292, IEC60204-1/EN60204-1, ISO11161/prEN11161, ISO10218/EN775, ANSI/RIA R15.06
Technical data	
Power supply	24Vdc (18..32Vdc)
Power absorbed at 24Vdc	10W
Protection fuse	Self-resetting
Protection level (Certificated)	IP65
Operating temperature	0..50°C
Storage and transportation temperature	-20..+60°C
Humidity (non-condensing)	<85%
Weight (with cable length 10m)	3000gr
Dimensions	
External W x H x D [mm]	See on Page 33-8
Cut-out W x H [mm]	--
Certification	
Certifications and approvals	CE

Functions

The following table lists in alphabetical order all the functions of the VT in question.

Table 15.1: Functions and objects realizable with this VT (Part 1 of 4)

Code of terminal		
VT505H *****		
Objects/Functions	Quantity	▼
Alarm field		
Alarm help		
Alarm history buffer		
Alarm statistics		
Alarms (Total/active simultaneously)		
Arc		●
Automatic operations	32	●
Backup/Restore		●
Bar data		●
Bit-wise password	8bits	●
Buttons	320 x page	●
Circles		●
Command: Change language		●
Command: Clear trend buffer		
Command: Delete recipe		●
Command: Hardcopy		
Command: Load recipe from data memory		●
Command: Modify password		●
Command: Next page		●
Command: Page help		●
Command: Password login		●
Command: Password logout		●
Command: Previous page		●
Command: Print alarm history		
Command: Printer form feed		
Command: Quit project		●
Command: Report		
Command: Restarts reading time-sampled trend		
Command: Run pipeline		
Command: Save alarms history and trend buffers in flash		
Command: Save recipe in data memory		●
Command: Save recipe received from device in buffer		●
Command: Save recipe received from device in data memory		●
Command: Send recipe from video buffer to device		●
Command: Send recipe to device		●
Command: Service page		●

Unless otherwise stated, there is no limit to the number of includable elements, only the size of project memory sets a limit.
*) indicative value determined by the dimensions of the project, **) depends on memory available

Table 15.1: Functions and objects realizable with this VT (Part 2 of 4)

Code of terminal		
VT505H *****		
Objects/Functions	Quantity	▼
Command: Show alarms history		
Command: Show page directory		●
Command: Show project information		●
Command: Show recipe directory		●
Command: Show sequence directory		
Command: Shows driver status page		●
Command: Shows page help		●
Command: Shows page with function: PG		
Command: Stops reading time sampled trend		
Command: Trend reading saved in device		
Command: Zero number of general pages		
Date field		●
Day-of-the-week field		●
Dynamic texts: Bit-group-structured dynamic texts	1024*	●
Dynamic texts: Single-bit dynamic texts		●
Dynamic texts: Value-structured dynamic texts		●
E-keys		
Equations	32	●
F-keys		●
Free terminal		
Function: Disables key		●
Function: Go to page		●
Function: Internal command		●
Function: Invert bit value		●
Function: Macro		●
Function: None		●
Function: Reset bit permanently		●
Function: Reset real-time bit		●
Function: Sequences		
Function: Sets bit permanently		●
Function: Sets real-time bit		●
Function: Value-structure direct command		●
Global configuration of E-keys		
Global configuration of F-keys		●
Headers and footers (Total/Number of fields per H-F)		
Info-messages (Total/active simultaneously)	256/256	●
Internal registers	4096bytes	●
Labels		●
LEDs assigned to sequence		

Unless otherwise stated, there is no limit to the number of includable elements, only the size of project memory sets a limit.
*) indicative value determined by the dimensions of the project, **) depends on memory available

Table 15.1: Functions and objects realizable with this VT (Part 3 of 4)

Code of terminal		
VT505H *****		
Objects/Functions	Quantity	▼
Lines		●
Lists of bitmap images		●
Lists of texts		●
Local configuration of E-keys		
Local configuration of F-keys		●
Macro field		
Macros (Total/Commands x macro)	1024/16	●
Message field		●
Message help	256	●
Multilanguage texts	4 Langs.	●
Object - Indicator		
Object - Potentiometer knob		
Object - Selector knob		
Object - Sliding potentiometer		
Object - Sliding selector		
Page	128	●
Page help	128	●
Password	10	●
Pipelines (Number/Tot bytes)		
Print		
Print page (Total/Number of fields per page)		
Programmable fonts		●
Project images		●
Public variables of ESANET network (Number/Total bytes)		
Recipe field for recipe structure		●
Recipes (Number of variables per recipe)	128/256	●
Rectangles		●
Redefinable characters		
Reports		
Sequences - Random		
Sequences - Start/stop		
Static bitmaps		●
Symbolic field: Bit-group-structured dynamic bitmaps	1024*	●
Symbolic field: Single-bit-structured dynamic bitmaps		●
Symbolic field: Value-structured dynamic bitmaps		●
System messages		●
System variables assigned to recipe structure		●
Time long field		●
Time short field		●

Unless otherwise stated, there is no limit to the number of includable elements, only the size of project memory sets a limit.
 *) indicative value determined by the dimensions of the project, **) depends on memory available

Table 15.1: Functions and objects realizable with this VT (Part 4 of 4)

Code of terminal		
VT505H *****		
Objects/Functions	Quantity	▼
Timer	32	●
Touch Area	24	●
Trend buffers		
Trends (Trends x page/Channels x trend)		
Trends sampled automatically (Memory/Trends/Readings)		
Trends sampled on command (Memory/Trends/Readings)		
Value direct command: ADD		●
Value direct command: AND		●
Value direct command: OR		●
Value direct command: SET		●
Value direct command: SUBTRACT		●
Value direct command: XOR		●
Variables: Limit values and linear scaling variables	34 x pages	●
Variables: Movement variable (Mobile symbolic field)		●
Variables: Threshold variables		●
Variables: Floating Point numerical variables		●
Variables: Numerical variables (DEC, HEX, BIN, BCD)		●
Variables: String variables (ASCII)		●

Unless otherwise stated, there is no limit to the number of includable elements, only the size of project memory sets a limit.
*) indicative value determined by the dimensions of the project, **) depends on memory available

Front view



Key	Function
1	Command and/or signal unit
2	System shut-down button (Conforms to the following standard(s): EN 60947-5-1, UL-508, CSA 22.2. No. 14)
3	Command and/or signal unit
4	F-keys
5	F-keys
6	Adjustable gripper belt

Other buttons and signals are defined using the programming software (see Software Manual).

⚠ The system shut-down button and the enabling button do NOT guarantee the operator's complete personal safety. Be sure to design your system so that it ensures the operator's complete personal safety.

Rear view

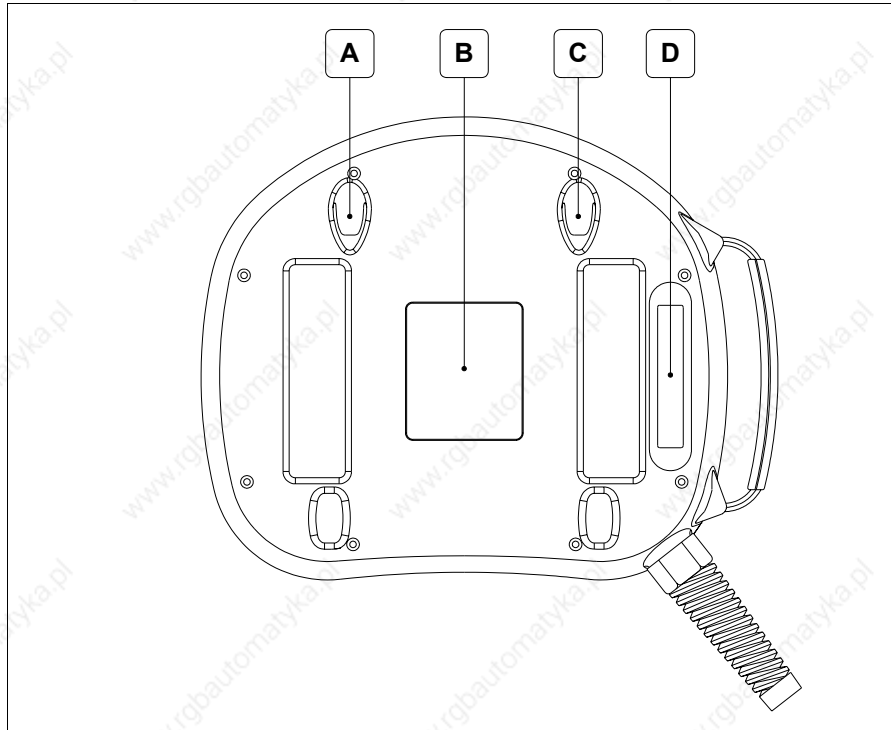

Position	Function
A	Housing for wall-fixing hook
B	Identification label
C	Housing for wall-fixing hook
D	Enabling button (Conforms to the following standard(s): IEC 60947-5-1, EN 60947-5-1, JIS C8201-5-1, UL-508, CSA 22.2. No. 14) (Approval(s): ISO12100/EN292, IEC60204-1/EN60204-1, ISO11161/prEN11161, ISO10218/EN775, ANSI/RIA R15.06)

⚠ The system shut-down button and the enabling button do NOT guarantee the operator's complete personal safety. Be sure to design your system so that it ensures the operator's complete personal safety.

Dimensions and Cut-out

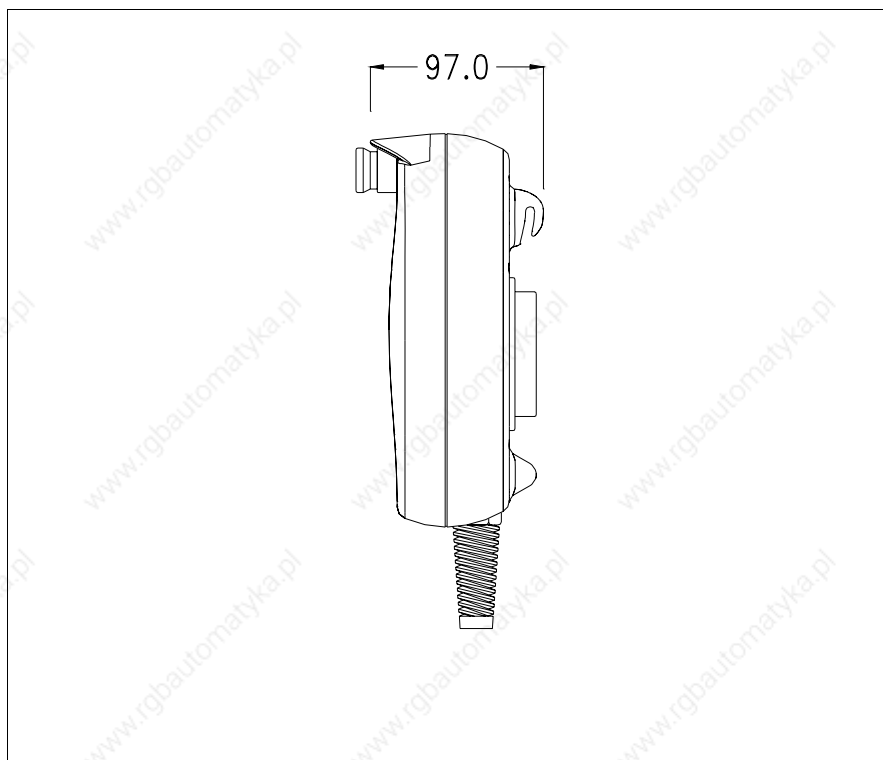
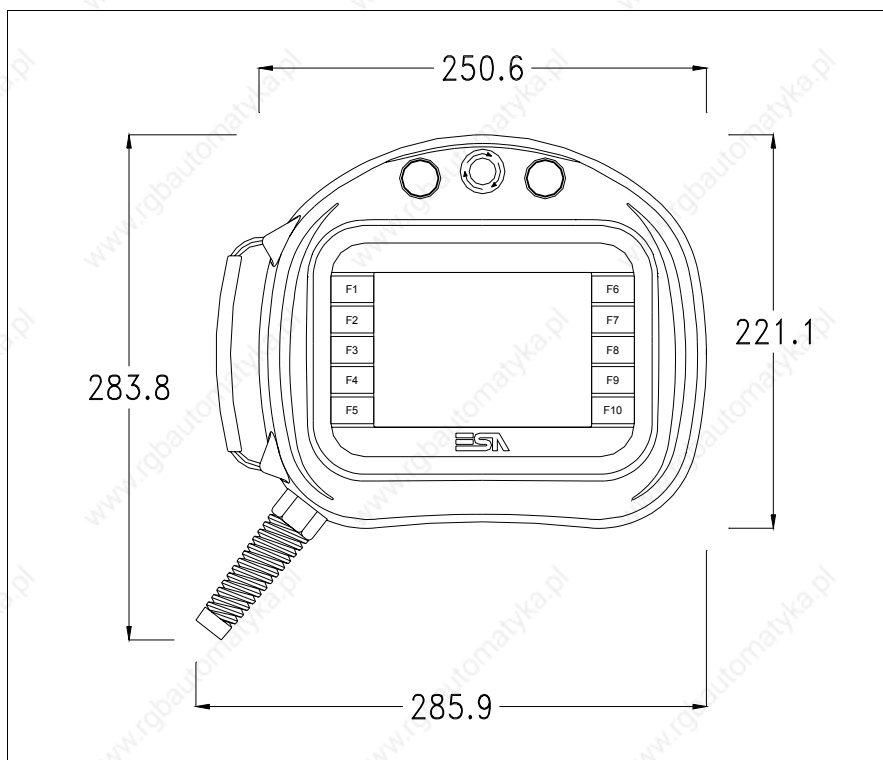

For VT mounting instructions see “Chapter 29 -> Mounting the terminal within the container“.



Where accessories need to be fixed in or onto the VT terminal, you are advised to do this before securing the VT to its container.

Accessories

Any accessories should be mounted in accordance with the instructions in the relevant chapter (see “Chapter 33 -> Video terminal accessories“).

Connection cable

The terminal is provided with a 10m long (AWG24) 25x0.25mmq shielded cable already attached (see “Chapter 32 -> Connection cable for H Series terminals“).

Adjusting holding strap for grip

The strap can be altered to adjust the grip for different hand sizes. To alter strap:

- Open the leather cover
- Detach the strap ends
- Adjust the holding strap length
- Secure strap ends again
- Close leather cover

Calibration of Touch Screen

The screen of VT505H is made of resistive, sensitive glass; for this type of glass to work properly it requires a calibration procedure (**the terminal is already calibrated when supplied**), that is, the resistive area of the glass has to be adjusted to the visible area of the display.

Should it be thought necessary to repeat the calibration procedure this can be done by following the instructions set out below.



The procedure must be carried out with great care as the precision of the keys area depends on the calibration.

How to perform the calibration procedure:

- Switch on the terminal; the following mask appears



- To access the calibration page, touch the message *****WAITING FOR BOOT FORCED***** three to six times in quick succession



- Touch the corner indicated in the figure; then the following page appears on screen



- Touch the corner indicated in the figure to complete the calibration procedure; the following page now appears



- Wait a few moments until the VT displays either the following mask or the project page (the page may be slightly different in its wording depending on which series the terminal belongs to)

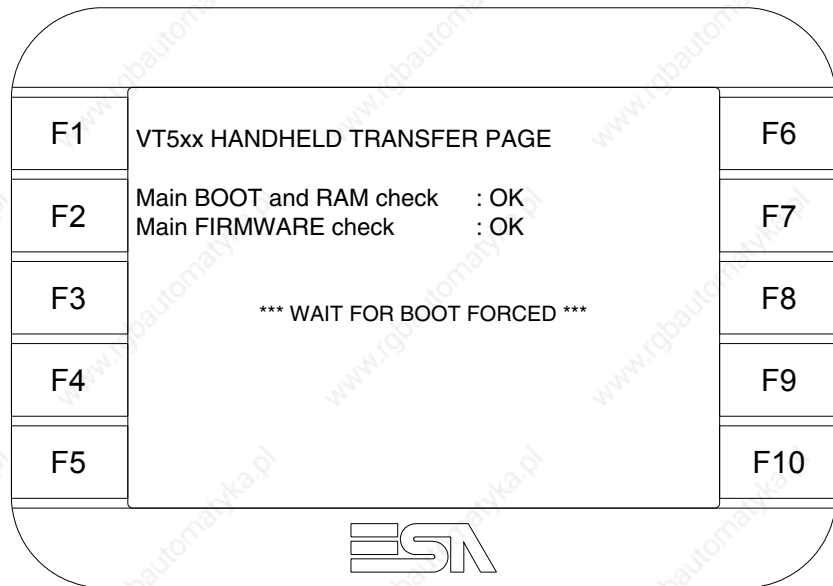

- Wait for the start-up of the VT to be completed

The calibration procedure has finished; if the calibration has been carried out wrongly or imprecisely, repeat the procedure.

Transfer PC -> VT

For everything to function properly, the first time the VT operator terminal is switched on it needs to be correctly loaded, that is it needs to have transferred to it:

- Firmware
- Communication driver
- Project

(Given that the transfer of the three files in practice occurs with a single operation, it will be defined as “Project transfer” for the sake of simplicity.)

For this it is essential that the VT be prepared to receive the transfer. (See also “Chapter 37 -> Command area”).

Preparation for reception

The program VTWIN (see Software Manual) must be used for the transfer, but the terminal must be set up to receive. This means carrying out the following steps:

- Check that the VT is off
- Check that there is a serial connection between the PC and the VT
- Switch on the VT and wait for the following mask to appear
- Press one after the other the diagonally opposite corners free of settable objects or buttons (at least one corner needs to be free)

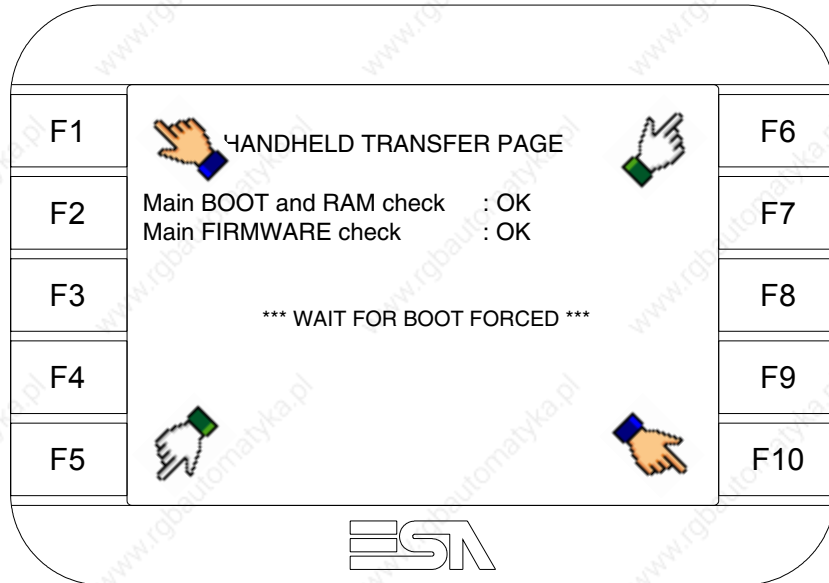

and wait a moment, or, using the appropriate button (see Page 15-20), till the VT displays the following mask

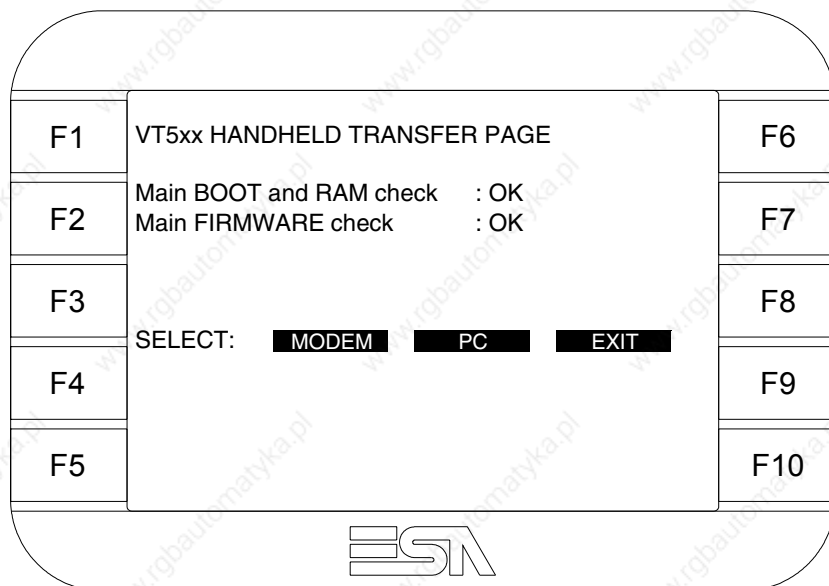

- Choose the required transfer mode: MODEM if you intend to use a modem or PC if you intend to use a serial port; touch the relevant on the display

If the choose made is PC, the VT is ready to receive (see Software Manual for transfer), if, on the other hand, you choose MODEM, the following mask will appear

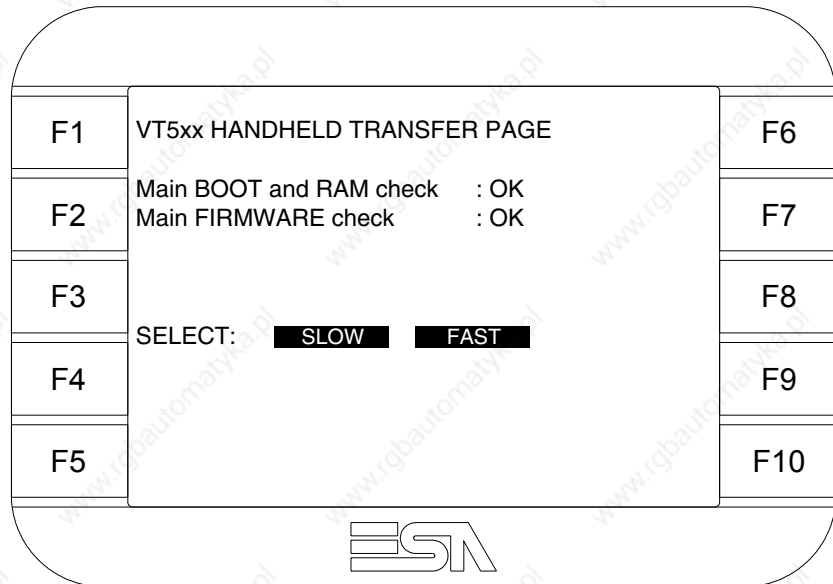

The choice should be according to the speed you intend to use for the transfer (Slow=9600bit/sec or Fast=38400bit/sec), touch the relevant on the display. The VT is now ready to receive (see Software Manual for the transfer).

Information relating to driver

After the project has been transferred, the VT can make available information relating to what has been loaded. The information regards:

- Serial ports present
- The name of the driver loaded
- The version of the driver loaded
- Network address of the VT
- Last error to have occurred

To acquire this information carry out the following operations:

- Be situated in any page of the project
- Press two diagonally opposed angles that are free of any settable objects or buttons (at least one angle must be free)

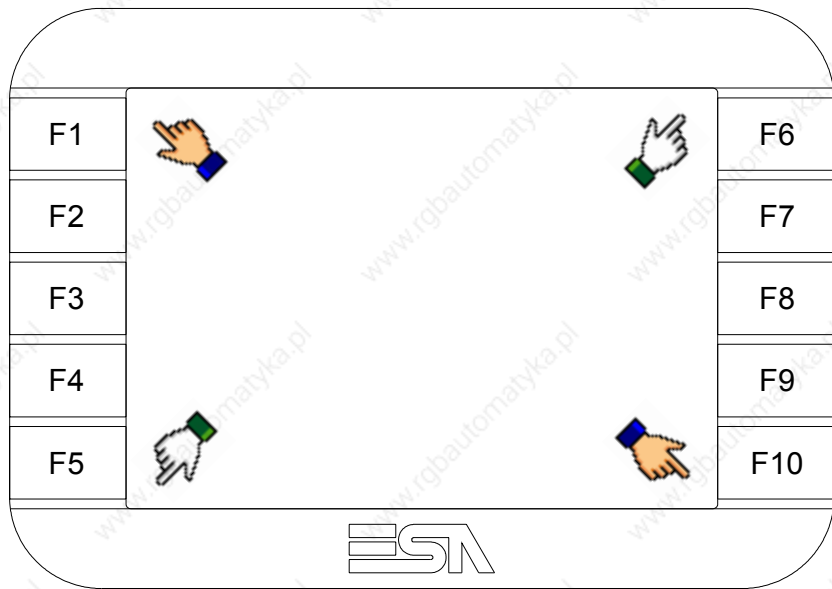

and you will see

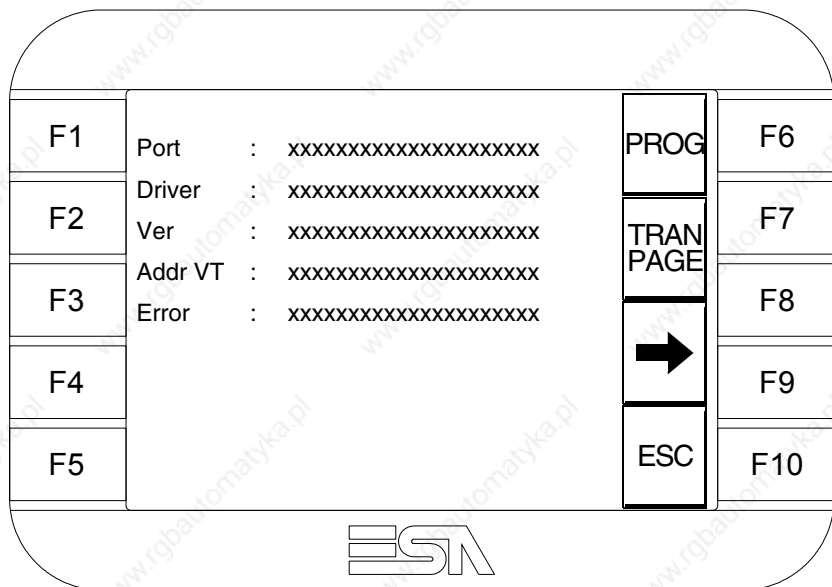

There is one of these pages for each communication port; movement between the various pages is effected by pressing .

From this page you can:

- Set the clock and the contrast
- Prepare the VT to receive the program

Setting the clock and the contrast:

To set the clock and the contrast, while displaying the above illustrated page, press ; the following mask appears

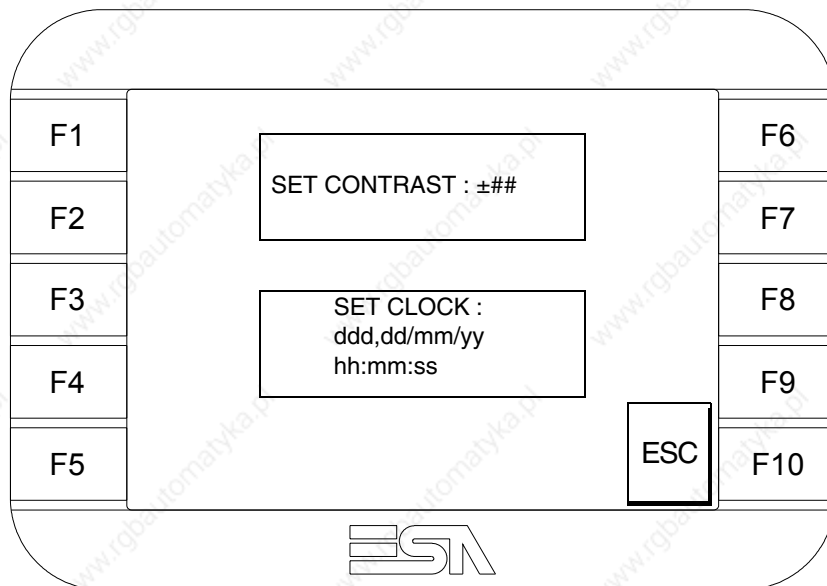

To set the contrast touch the words SET CONTRAST on the display; you will see the following mask

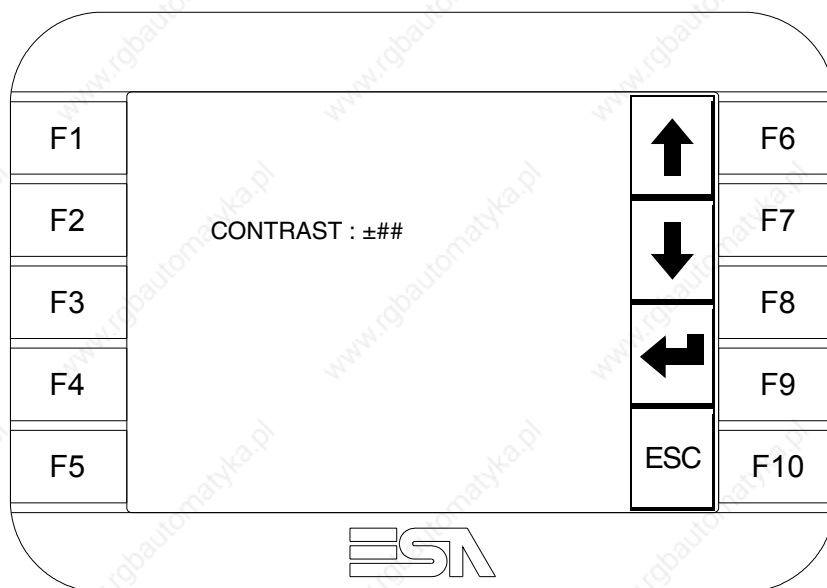

Use the arrow  for any variation (see “Chapter 36 -> Operation of

terminal with touch screen“).

To set the clock touch the words SET CLOCK on the display; the following mask appears

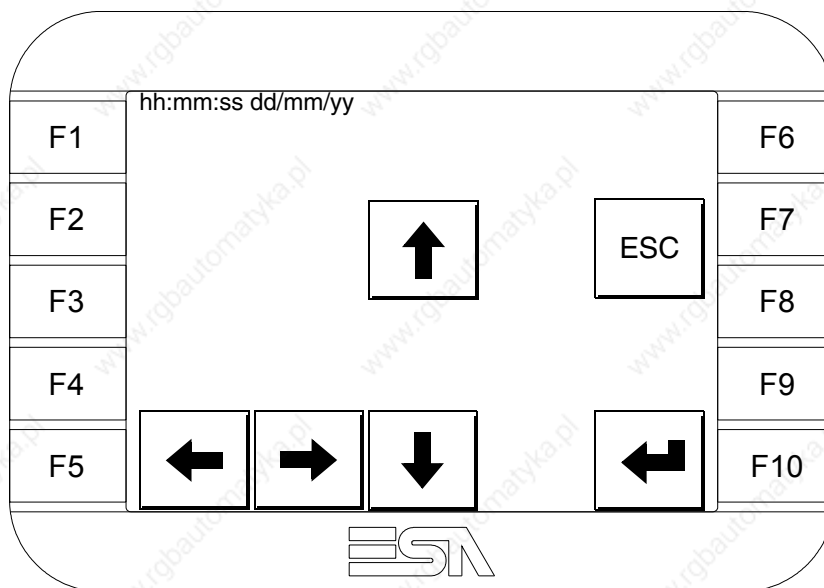

Use the arrow  for any variation (see “Chapter 36 -> Operation of terminal with touch screen“).

Prepare the VT to receive the program:

To prepare the VT to receive the program, while displaying the driver information page (see Page 15-17), press , and you will see the following mask



The VT terminal is now ready to receive (consult Software Manual for information on the transmission procedure).

Possible error messages that may be encountered in the driver information page are:

- PR ERR

Problem-> Errors have been detected in the data exchange between the VT and the Device.

Solution-> Check the cable; there may be disturbance.

- COM BROKEN

Problem-> Communication between VT and Device interrupted.

Solution-> Check the serial connection cable.

An error message followed by [*] indicates that the error is not currently present but was and has since disappeared.

Example: COM BROKEN*

When  is pressed you quit the display of information regarding the driver.

Adjusting the contrast on the display

To improve the quality of the representation on the display it may be necessary to adjust its contrast. This can be done by going to the page proposed (see Page 15-19) and changing the value (from +31 to -32) in evidence at that moment. Increase the value to darken the display; to lighten it, decrease the value.

We advise this to be done at typical room temperature and with the terminal at operating temperature (about 30 minutes after switching on and with the screen saver disabled - see Software Manual).

Chapter 16 Video terminal VT505W

Contents	Page
Technical characteristics	16-2
Functions	16-4
Front view	16-8
Standard series rear view	16-9
CAN series rear view	16-10
Ethernet series rear view	16-11
Dimensions and Cut-out	16-12
Accessories	16-13
Calibration of Touch Screen	16-13
Termination of CAN line	16-16
Introducing the MAC address	16-17
Transfer PC -> VT	16-20
Preparation for reception	16-20
Information relating to driver	16-22
Adjusting the contrast on the display	16-25

This chapter consists of 26 pages.



Technical characteristics

The following table lists the principal technical characteristics of the product in question.

Code of terminal	Characteristics of the terminal			
VT505W 00000				
VT505W 000DP				
VT505W 000CN				
VT505W 000ET				
Display				
Type	LCD 4 tones of blue STN	●	●	●
	LCD 16 Colors STN			
	LCD 16 Colors TFT			
Touch screen	Matrix 20 x 16 (Cell:16x15 pixels)	●	●	●
Representational format	Graphic	●	●	●
Resolution [pixels]	320 x 240 (5,7")	●	●	●
Rows x characters	16 x 40 / 8 x 20 / 4 x 10	●	●	●
Display area size [mm]	115,2 x 86,4	●	●	●
Character matrix in text mode [pixels]	8 x15 / 16 x 30 / 32 x 60	●	●	●
Character size [mm] x 1 / x 2 / x 4	2,8 x 5,2 / 5,6 x 10,4 / 11,2 x 20,8	●	●	●
Contrast adjustment	Software	●	●	●
	Automatic compensation with temperature	●	●	●
Character sets	Programmable fonts/TTF Windows ®	●	●	●
Backlighting				
Type	LED			
	CCFL lamp	●	●	●
Minimum lamp-life at 25°C [hours]	15000	●	●	●

Code of terminal	Characteristics of the terminal			
VT505W 00000				
VT505W 000DP				
VT505W 000CN				
VT505W 000ET				
User memory				
Project [Bytes]	640K	●	●	●
Data memory [Bytes]	16K (Flash EPROM)	●	●	●
Memory for Windows ® -based fonts [Byte]	32K	●	●	●
Memory Card for backup	--			
Memory Card for expansion	--			
Interfaces				
MSP (Multi-serial port)	RS232/RS422/RS485/TTY-20mA		●	●
ASP (Auxiliary serial port)	RS232/RS485			
ASP-15L (Auxiliary serial port)	RS232/RS485			
ASP-8 (Auxiliary serial port)	RS232	●		
ASP-9 (Auxiliary serial port)	RS232			
LPT parallel port	Centronics			
Auxiliary port	Connections for accessories			
Accessories				
Connectable accessories	See table "Chapter 33"	●	●	●
Clock				
Clock	Software (no back-up battery)	●	●	●
Networks				
Integrated	Profibus-DP			●
	CAN Open (Optoisolated interface)		●	
	Ethernet 10/100Mbit RJ45	●		
Universal Bus Connector	--			
Optional	See table "Chapter 33"	●	●	●
Proprietary networks				
ESA-Net	Network server			
	Network client			●
Technical data				
Power supply	24Vdc (18..32Vdc)			
Power absorbed at 24Vdc	10W			
Protection fuse	Ø5x20mm - 800mA Quick Blow F			
Protection level	IP65 (front-end)			
Operating temperature	0..50°C			
Storage and transportation temperature	-20..+60°C			
Humidity (non-condensing)	<85%			
Weight	1400gr			
Dimensions				
External W x H x D [mm]	210 x 158 x 54			
Cut-out W x H [mm]	198 x 148			
Certification				
Certifications and approvals	CE, cULus, NEMA12			

Functions

The following table lists in alphabetical order all the functions of the VT in question.

Table 16.1: Functions and objects realizable with this VT (Part 1 of 4)

Code of terminal		
VT505W *****		
Objects/Functions	Quantity	▼
Alarm field		
Alarm help		
Alarm history buffer		
Alarm statistics		
Alarms (Total/active simultaneously)		
Arc		●
Automatic operations	32	●
Backup/Restore		●
Bar data		●
Bit-wise password	8bits	●
Buttons	320 x page	●
Circles		●
Command: Change language		●
Command: Clear trend buffer		
Command: Delete recipe		●
Command: Hardcopy		
Command: Load recipe from data memory		●
Command: Modify password		●
Command: Next page		●
Command: Page help		●
Command: Password login		●
Command: Password logout		●
Command: Previous page		●
Command: Print alarm history		
Command: Printer form feed		
Command: Quit project		●
Command: Report		
Command: Restarts reading time-sampled trend		
Command: Run pipeline		
Command: Save alarms history and trend buffers in flash		
Command: Save recipe in data memory		●
Command: Save recipe received from device in buffer		●
Command: Save recipe received from device in data memory		●
Command: Send recipe from video buffer to device		●
Command: Send recipe to device		●
Command: Service page		●

Unless otherwise stated, there is no limit to the number of includable elements, only the size of project memory sets a limit.
*) indicative value determined by the dimensions of the project, **) depends on memory available

Table 16.1: Functions and objects realizable with this VT (Part 2 of 4)

Code of terminal		
VT505W *****		
Objects/Functions	Quantity	▼
Command: Show alarms history		
Command: Show page directory		●
Command: Show project information		●
Command: Show recipe directory		●
Command: Show sequence directory		
Command: Shows driver status page		●
Command: Shows page help		●
Command: Shows page with function: PG		
Command: Stops reading time sampled trend		
Command: Trend reading saved in device		
Command: Zero number of general pages		
Date field		●
Day-of-the-week field		●
Dynamic texts: Bit-group-structured dynamic texts		●
Dynamic texts: Single-bit dynamic texts	1024*	●
Dynamic texts: Value-structured dynamic texts		●
E-keys		
Equations	32	●
F-keys		
Free terminal		
Function: Disables key		
Function: Go to page		●
Function: Internal command		●
Function: Invert bit value		●
Function: Macro		●
Function: None		
Function: Reset bit permanently		●
Function: Reset real-time bit		●
Function: Sequences		
Function: Sets bit permanently		●
Function: Sets real-time bit		●
Function: Value-structure direct command		●
Global configuration of E-keys		
Global configuration of F-keys		
Headers and footers (Total/Number of fields per H-F)		
Info-messages (Total/active simultaneously)	256/256	●
Internal registers	4096bytes	●
Labels		●
LEDs assigned to sequence		

Unless otherwise stated, there is no limit to the number of includable elements, only the size of project memory sets a limit.
 *) indicative value determined by the dimensions of the project, **) depends on memory available

Table 16.1: Functions and objects realizable with this VT (Part 3 of 4)

Code of terminal		
VT505W *****		
Objects/Functions	Quantity	▼
Lines		●
Lists of bitmap images		●
Lists of texts		●
Local configuration of E-keys		
Local configuration of F-keys		
Macro field		
Macros (Total/Commands x macro)	1024/16	●
Message field		●
Message help	256	●
Multilanguage texts	4 Langs.	●
Object - Indicator		
Object - Potentiometer knob		
Object - Selector knob		
Object - Sliding potentiometer		
Object - Sliding selector		
Page	128	●
Page help	128	●
Password	10	●
Pipelines (Number/Tot bytes)		
Print		
Print page (Total/Number of fields per page)		
Programmable fonts		●
Project images		●
Public variables of ESANET network (Number/Total bytes)		
Recipe field for recipe structure		●
Recipes (Number of variables per recipe)	128/256	●
Rectangles		●
Redefinable characters		
Reports		
Sequences - Random		
Sequences - Start/stop		
Static bitmaps		●
Symbolic field: Bit-group-structured dynamic bitmaps	1024*	●
Symbolic field: Single-bit-structured dynamic bitmaps		●
Symbolic field: Value-structured dynamic bitmaps		●
System messages		●
System variables assigned to recipe structure		●
Time long field		●
Time short field		●

Unless otherwise stated, there is no limit to the number of includable elements, only the size of project memory sets a limit.
*) indicative value determined by the dimensions of the project, **) depends on memory available

Table 16.1: Functions and objects realizable with this VT (Part 4 of 4)

Code of terminal		
VT505W ****		
Objects/Functions	Quantity	▼
Timer	32	●
Touch Area	24	●
Trend buffers		
Trends (Trends x page/Channels x trend)		
Trends sampled automatically (Memory/Trends/Readings)		
Trends sampled on command (Memory/Trends/Readings)		
Value direct command: ADD		●
Value direct command: AND		●
Value direct command: OR		●
Value direct command: SET		●
Value direct command: SUBTRACT		●
Value direct command: XOR		●
Variables: Limit values and linear scaling variables	34 x pages	●
Variables: Movement variable (Mobile symbolic field)		●
Variables: Threshold variables		●
Variables: Floating Point numerical variables		●
Variables: Numerical variables (DEC, HEX, BIN, BCD)		●
Variables: String variables (ASCII)		●
		●

Unless otherwise stated, there is no limit to the number of includable elements, only the size of project memory sets a limit.
 *) indicative value determined by the dimensions of the project, **) depends on memory available

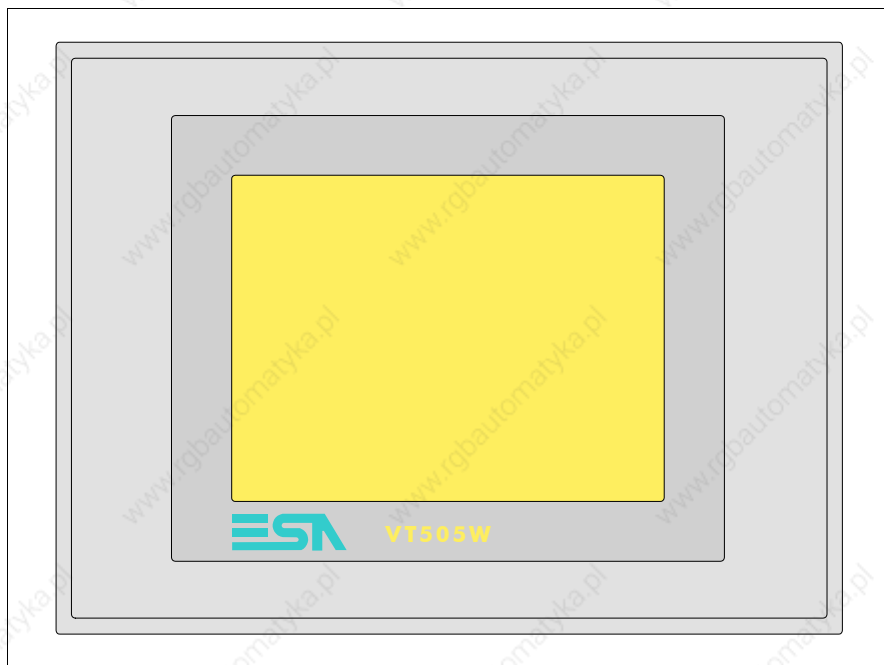
Front view

All buttons and signals are defined using the programming software (see Software Manual).

Standard series rear view

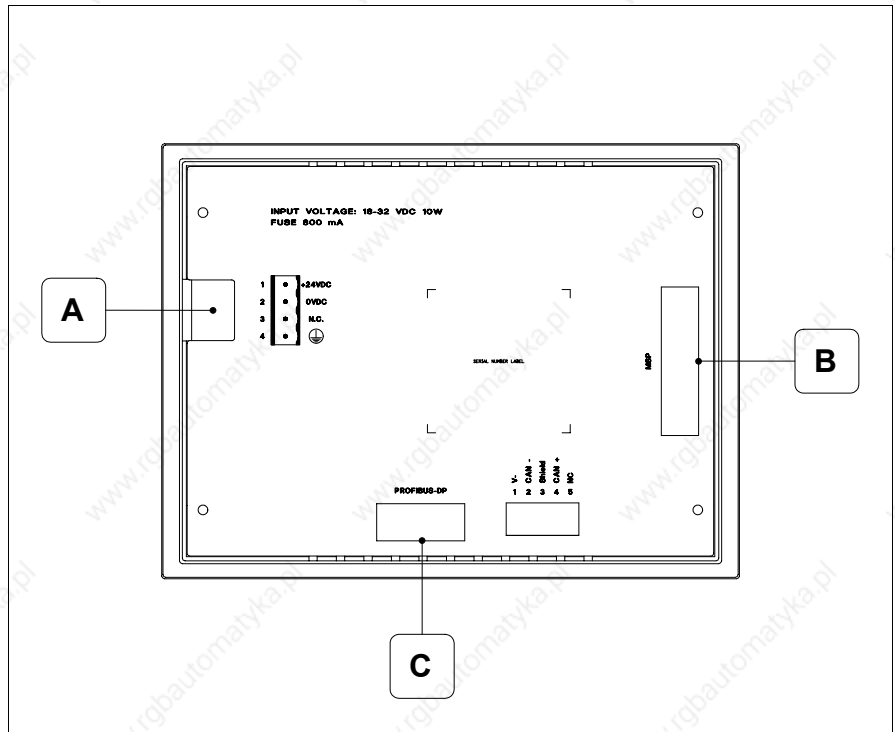

Position	Function
A	Power supply connector
B	MSP serial port for communicating with PLC/PC
C	PROFIBUS-DP serial port for network communication (Option)

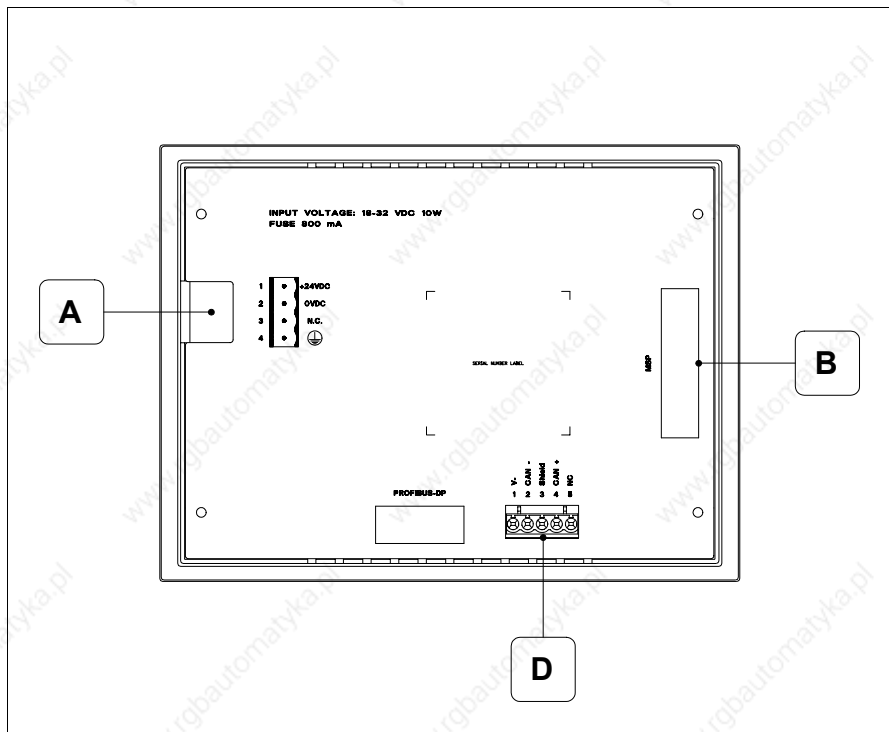
**CAN series
rear view**

Position	Function
A	Power supply connector
B	MSP serial port for communicating with PLC/PC
D	CAN serial port

Ethernet series rear view

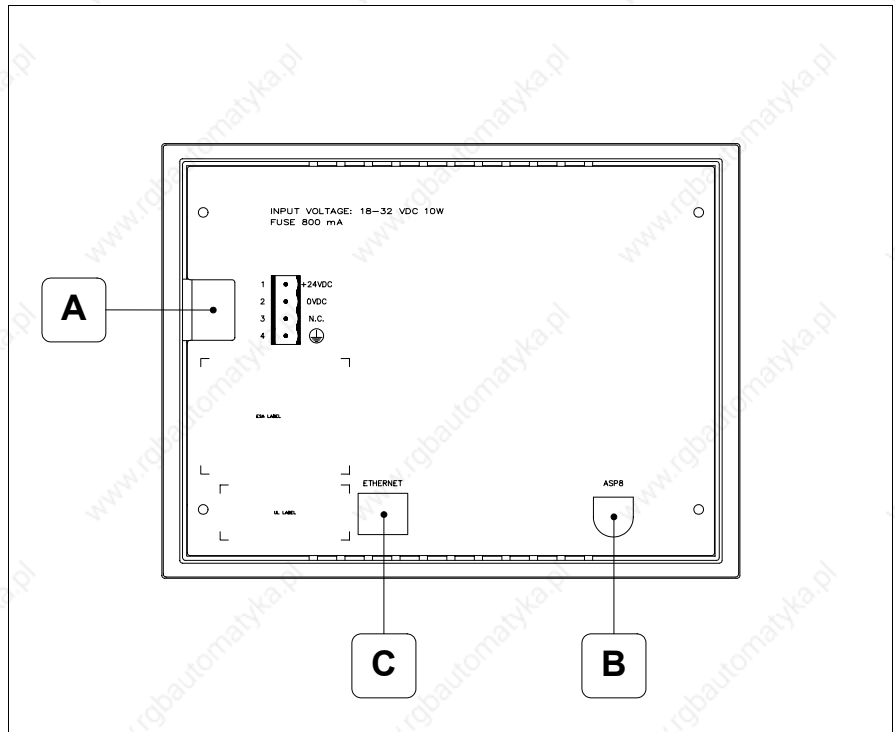

Position	Function
A	Power supply connector
B	ASP serial port for communicating with PC or other devices
C	Ethernet network 10/100Mbit RJ45 (For the diagnostic mode of the LEDs see "Chapter 30 -> Ethernet port")

**Dimensions
and Cut-out**

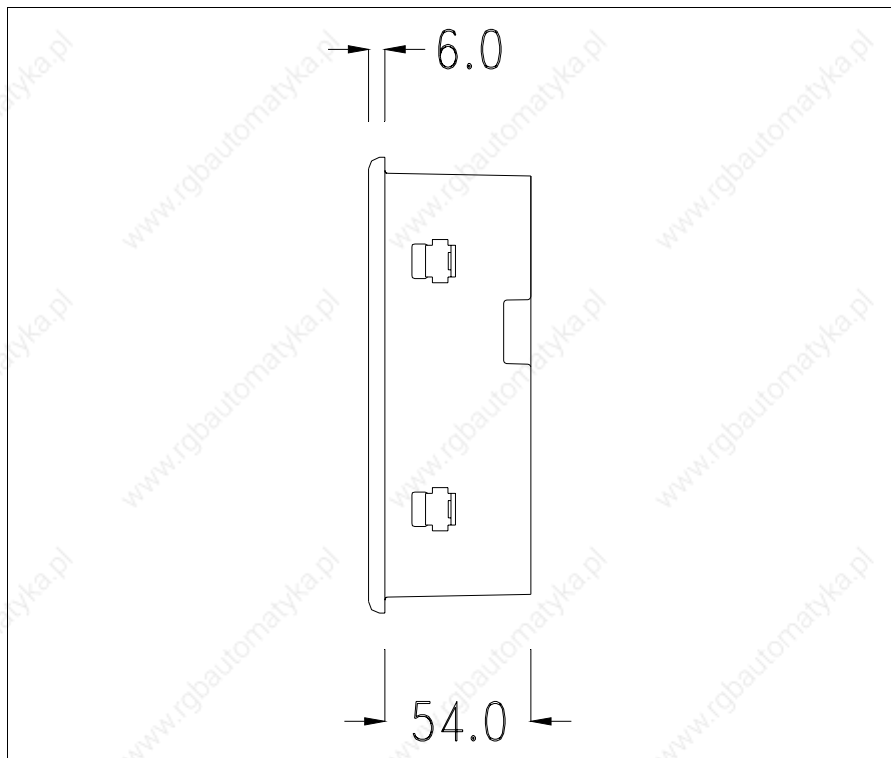
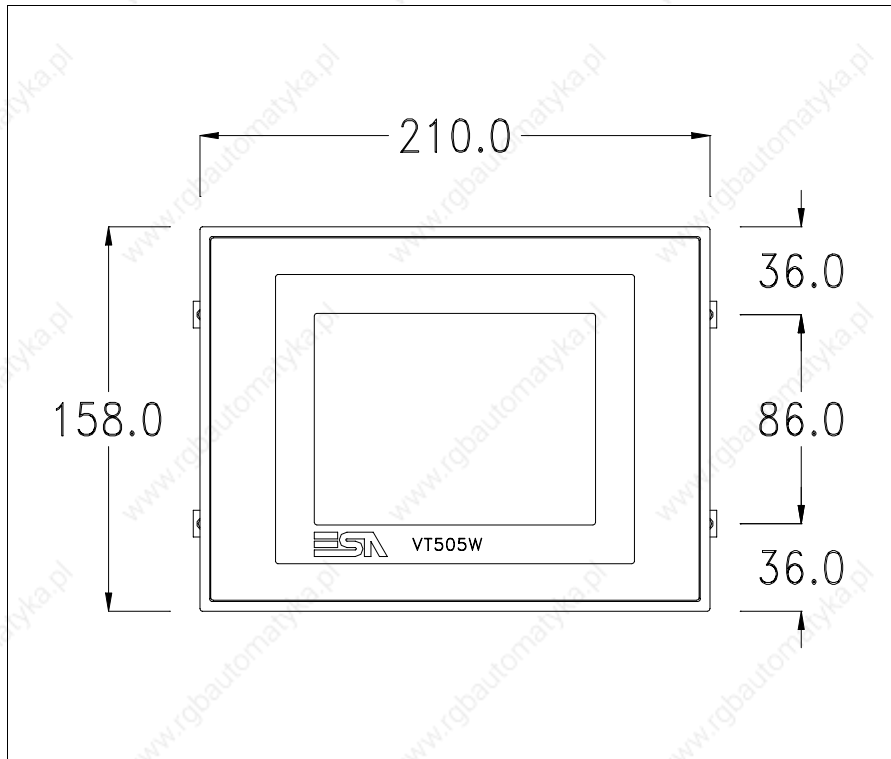

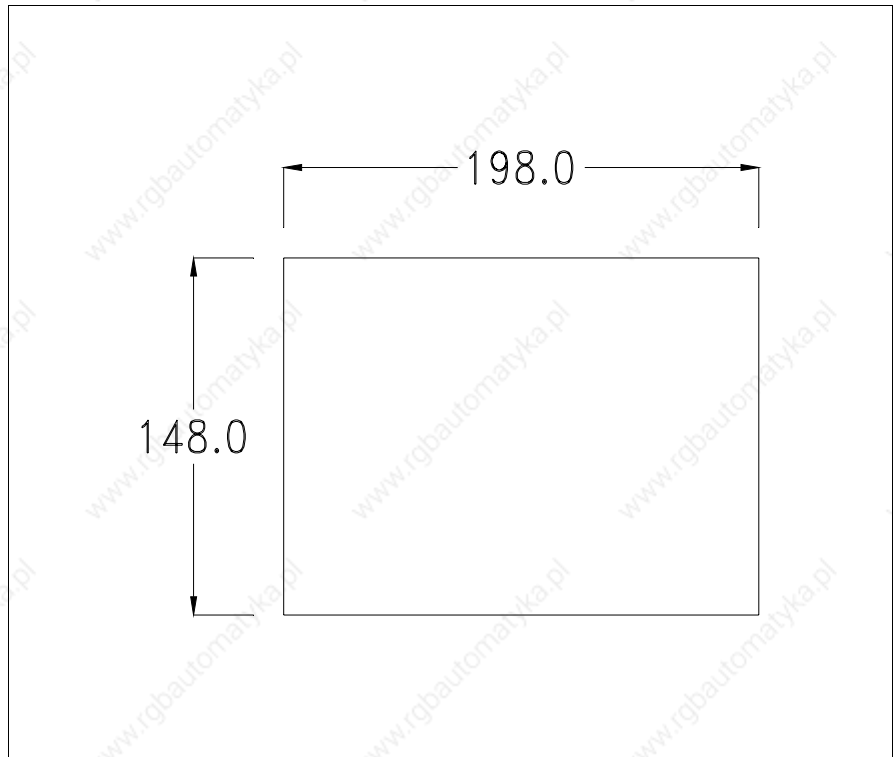

To fix the sealing gasket and secure the VT to the container see “Chapter 29 -> Mounting the terminal within the container“.

⚠ Where accessories need to be fixed in or onto the VT terminal, you are advised to do this before securing the VT to its container.

Accessories

Any accessories should be mounted in accordance with the instructions in the relevant chapter (see “Chapter 33 -> Video terminal accessories“).

Calibration of Touch Screen

The screen of VT505W is made of resistive, sensitive glass; for this type of glass to work properly it requires a calibration procedure (**the terminal is already calibrated when supplied**), that is, the resistive area of the glass has to be adjusted to the visible area of the display.

Should it be thought necessary to repeat the calibration procedure this can be done (terminal Rev. 2 or above) by following the instructions set out below.

⚠ The procedure must be carried out with great care as the precision of the keys area depends on the calibration.

How to perform the calibration procedure:

- Make sure the VT is not connected to the power supply
- Remove the back cover
- Identify jumper J1

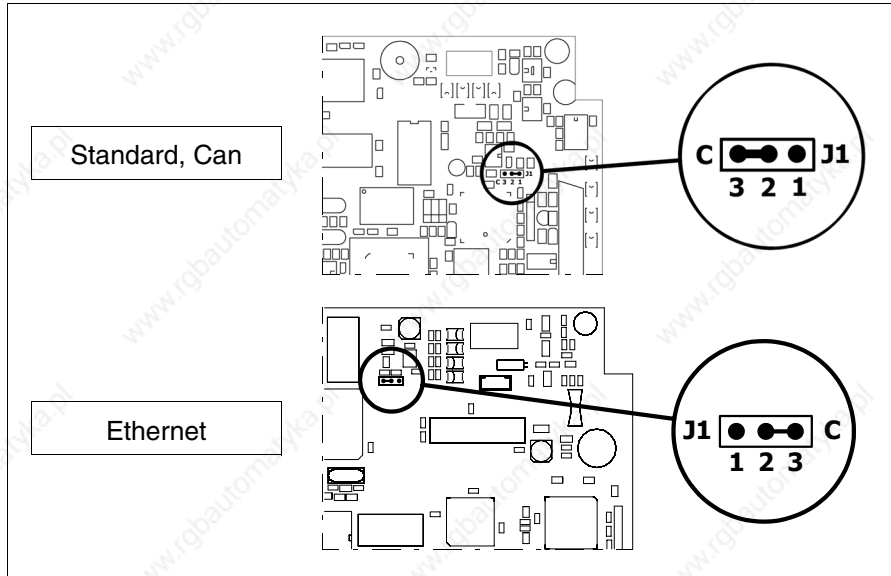

- Position J1 on pins 2-3 (C)
- Reconnect the power supply and switch on the terminal; the following mask appears

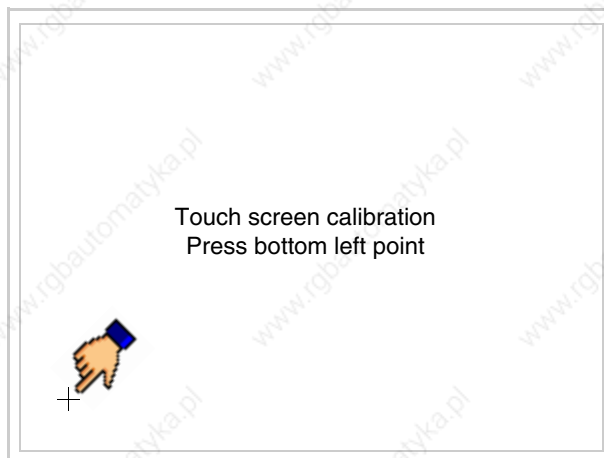

- Touch the corner indicated in the figure; then the following page appears on screen

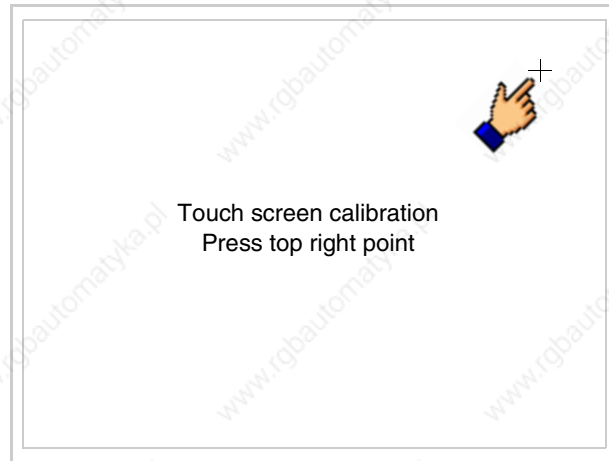

- Touch the corner indicated in the figure to complete the calibration procedure; the following page now appears

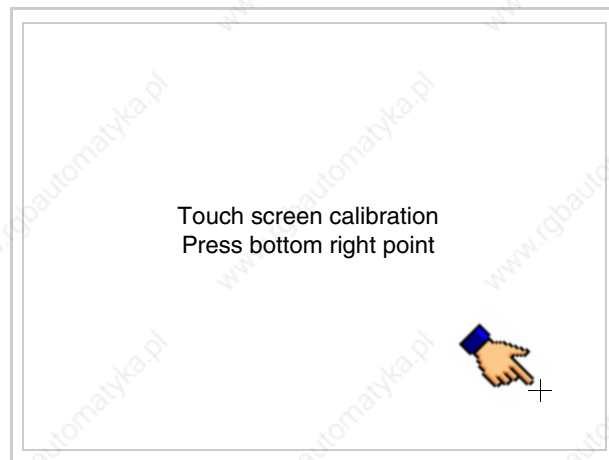

- Wait a few moments until the VT displays either the following mask or the project page (the page may be slightly different in its wording depending on which series the terminal belongs to)

```
VT505 TRANSFER PAGE

Main BOOT and RAM check   : OK
Main FIRMWARE check      : OK

*** WAIT FOR BOOT FORCED ***
```

- Switch off the terminal
- Reposition J1 on pins 1-2
- Replace the back cover
- Switch on the terminal again

The calibration procedure has finished; if the calibration has been carried out wrongly or imprecisely, repeat the procedure.

Termination of CAN line

This paragraph applies only to the CAN series. The VT in question integrates the termination resistances of the serial line (typically 120 ohms) which can be inserted by means of a jumper (preset on 1-2, line not terminated). To activate the termination:

- Make sure the device is not connected to the power supply.
- Remove the cover.
- Identify the jumper unit J4.

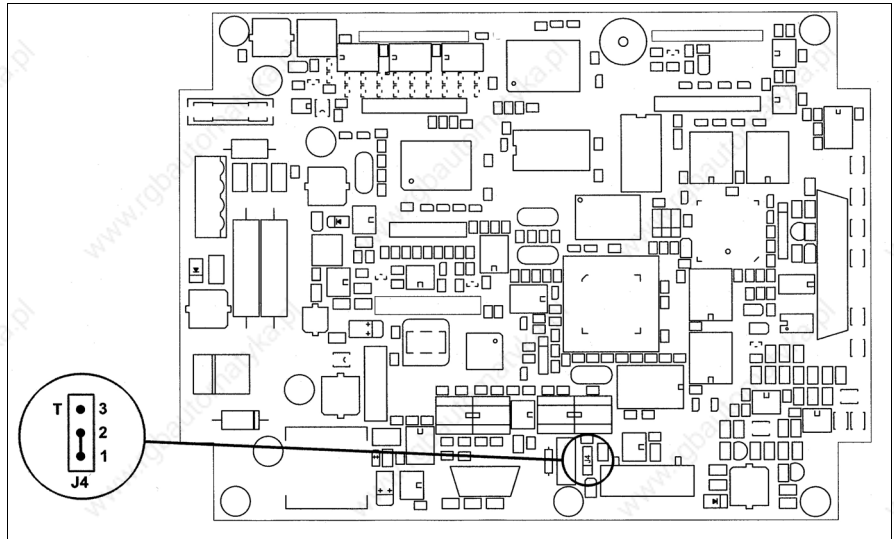

- Position the jumper between pins 2 and 3 (line terminated).
- Replace the back cover.
- Reconnect the power supply.

Introducing the MAC address

This paragraph relates only to the Ethernet series. The Media Access Control (MAC) address unambiguously identifies each terminal connected in the Ethernet network. The terminal is acquired with the address already programmed and is shown on the display of the terminal in the transfer page.

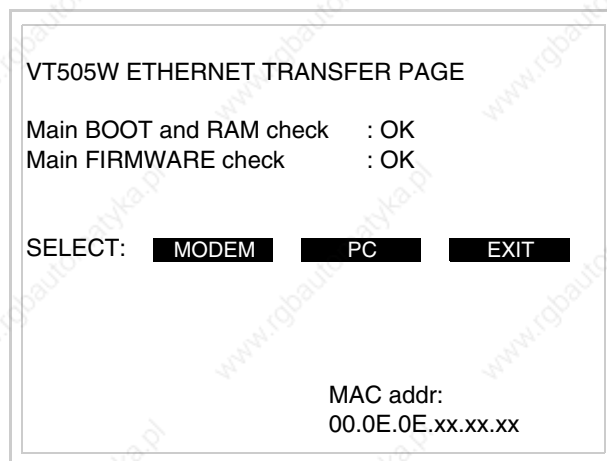

The MAC address is permanently memorized in the terminal, but should it be necessary to execute an “aided” BOOT update (see Software Manual “Chapter 14 -> BOOT update”) the address is lost.



This operation must be carried out only with the advice of the

ESA Customer Care Department.

Terminals with no valid MAC address when switched present a mask for its insertion. If no MAC address belonging to the terminal is available, proceed as follows:

- Check that the VT is not connected to the power supply.
- Remove the back cover
- Locate the label carrying the MAC address

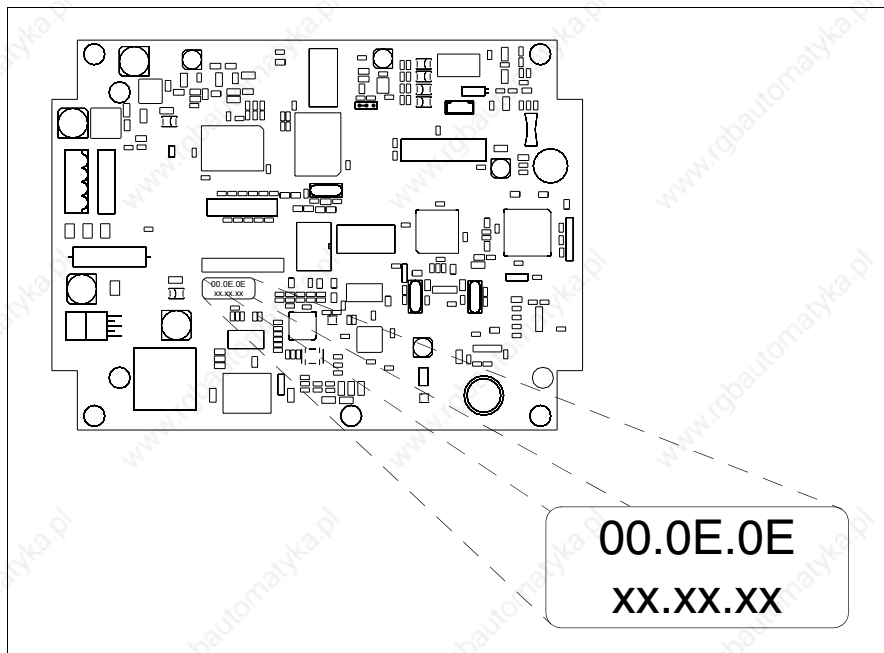

- Make a note of the number on the label (e.g. 00.0E.0E.00.00.01)

00.0E.0E -> fixed part that identifying as an ESA product
XX.XX.XX -> variable part different for each terminal

- Reconnect the power supply to the terminal and, if necessary, calibrate the touch screen (see Page 16-13)
- Replace the back cover
- Switch on the terminal again
- The following mask appears; introduce the address previously noted down (e.g. 00.0E.0E.00.00.01)

Enter a valid MAC address:
00.0E.0E.00.00.00

↑

← → ↓ ↶

Detailed description: This is a terminal window showing a prompt to enter a valid MAC address. The address '00.0E.0E.00.00.00' is displayed. Below the prompt is a large upward-pointing arrow button. At the bottom, there are four smaller navigation buttons: left arrow, right arrow, down arrow, and a left arrow with a small square at its tip.

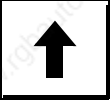
- Use the arrow  to make the setting. Once the address has been confirmed the following page is displayed

VT505W ETHERNET TRANSFER PAGE

Main BOOT and RAM check : OK
Main FIRMWARE check : OK

SELECT: **MODEM** **PC** **EXIT**

MAC addr:
00.0E.0E.00.00.01

Detailed description: This is the 'VT505W ETHERNET TRANSFER PAGE'. It shows the results of 'Main BOOT and RAM check' and 'Main FIRMWARE check', both of which are 'OK'. Below this, there is a 'SELECT:' prompt followed by three highlighted options: 'MODEM', 'PC', and 'EXIT'. At the bottom right, the 'MAC addr:' is shown as '00.0E.0E.00.00.01'.

The procedure is now terminated.

 **Should a wrong MAC address have been inserted contact the ESA Customer Care Department.**

 **A wrong address could give rise to an error of conflict between VT terminals in the Ethernet network.**

**Transfer PC ->
VT**

For everything to function properly, the first time the VT operator terminal is switched on it needs to be correctly loaded, that is it needs to have transferred to it:

- Firmware
- Communication driver
- Project

(Given that the transfer of the three files in practice occurs with a single operation, it will be defined as “Project transfer” for the sake of simplicity.)

For this it is essential that the VT be prepared to receive the transfer. (See also “Chapter 37 -> Command area“).

**Preparation
for reception**

The program VTWIN (see Software Manual) must be used for the transfer, but the terminal must be set up to receive. This means carrying out the following steps:

- Check that the VT is off
- Check that there is a serial connection between the PC and the VT
- Switch on the VT and wait for the following mask to appear
- Press one after the other the diagonally opposite corners free of settable objects or buttons (at least one corner needs to be free)

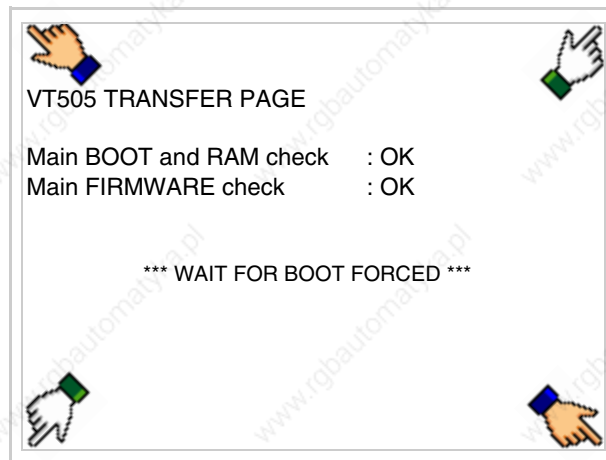

and wait a moment, or, using the appropriate button (see Page 16-24), till the VT displays the following mask

VT terminal with no Modem function:

The VT is now ready to receive (see Software Manual for information on the transmission procedure)

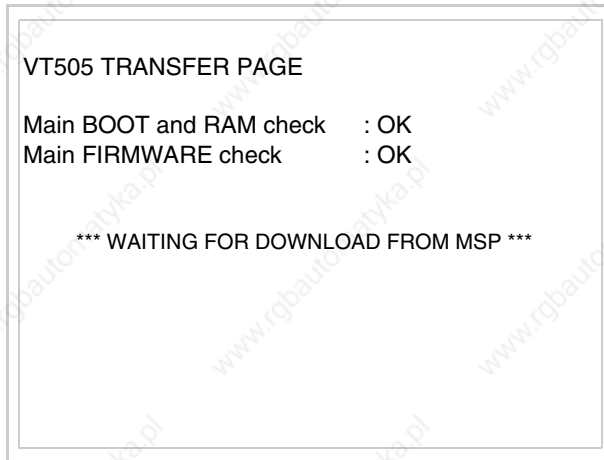

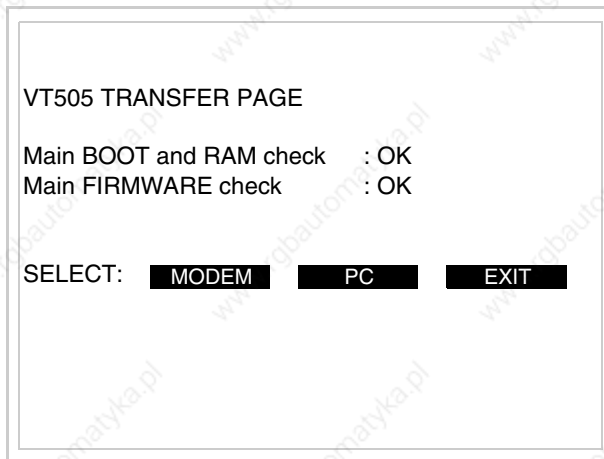

VT terminal with Modem function:

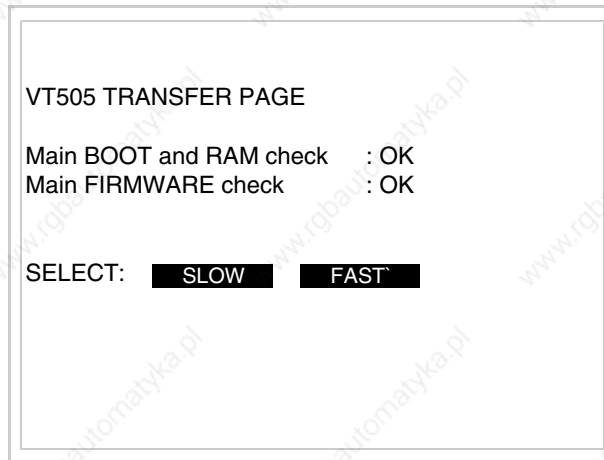

- Choose the required transfer mode: MODEM if you intend to use a modem or PC if you intend to use a serial port; touch the relevant on the display

If the choose made is PC, the VT is ready to receive (see Software Manual for transfer), if, on the other hand, you choose MODEM, the following mask will appear



The choice should be according to the speed you intend to use for the transfer (Slow=9600bit/sec or Fast=38400bit/sec), touch the relevant  on the display. The VT is now ready to receive (see Software Manual for the transfer).

Information relating to driver

After the project has been transferred, the VT can make available information relating to what has been loaded. The information regards:

- Serial ports present
- The name of the driver loaded
- The version of the driver loaded
- Network address of the VT
- Last error to have occurred

To acquire this information carry out the following operations:

- Be situated in any page of the project
- Press two diagonally opposed angles that are free of any settable objects or buttons (at least one angle must be free)



and you will see

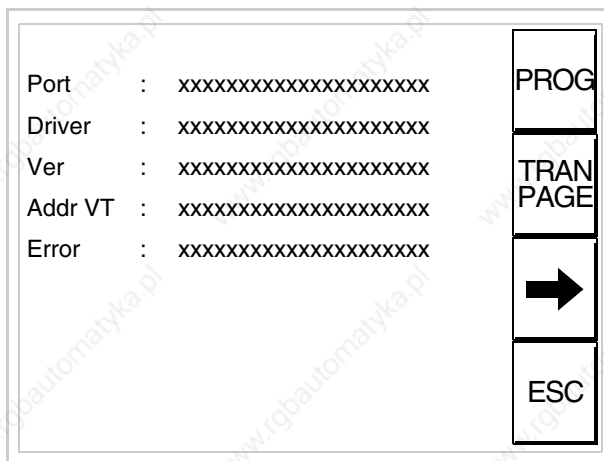

There is one of these pages for each communication port; movement between the various pages is effected by pressing .

From this page you can:

- Set the clock and the contrast
- Prepare the VT to receive the program

Setting the clock and the contrast:

To set the clock and the contrast, while displaying the above illustrated page, press ; the following mask appears

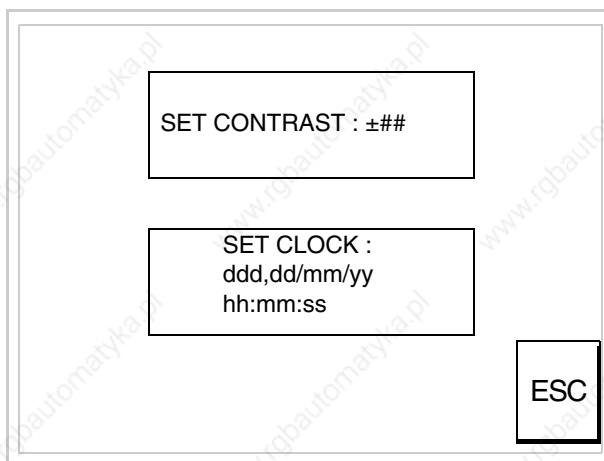

To set the contrast touch the words SET CONTRAST on the display;

you will see the following mask

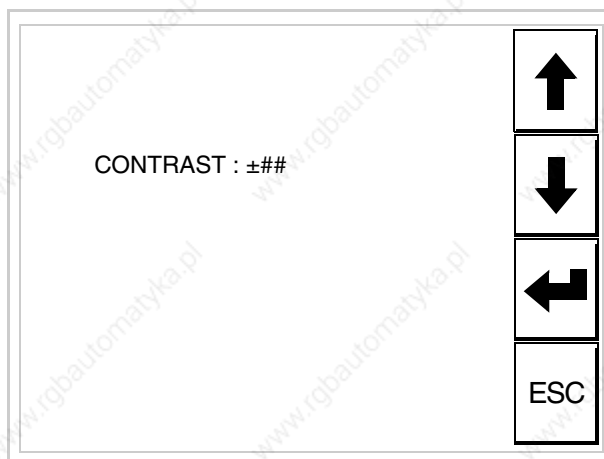

Use the arrow  for any variation (see “Chapter 36 -> Operation of terminal with touch screen”).

To set the clock touch the words SET CLOCK on the display; the following mask appears

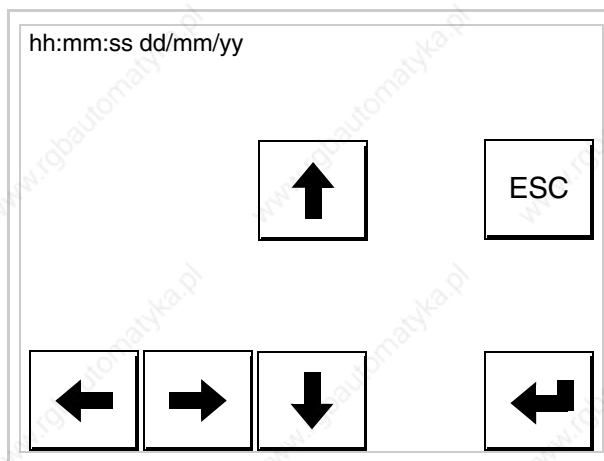

Use the arrow  for any variation (see “Chapter 36 -> Operation of terminal with touch screen”).

Prepare the VT to receive the program:

To prepare the VT to receive the program, while displaying the driver information page (see Page 16-22), press , and you will

see the following mask

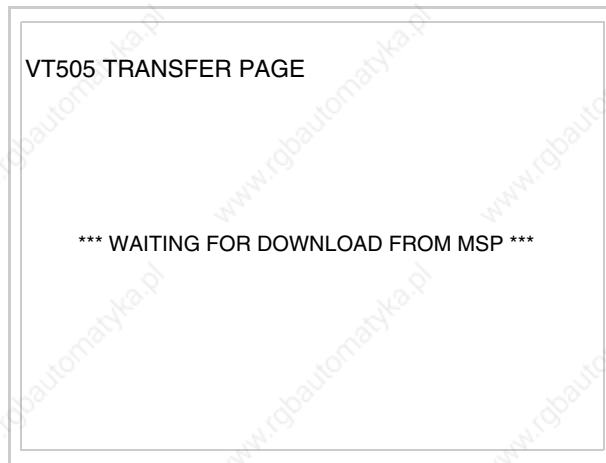

The VT terminal is now ready to receive (consult Software Manual for information on the transmission procedure).

Possible error messages that may be encountered in the driver information page are:

- PR ERR

Problem-> Errors have been detected in the data exchange between the VT and the Device.

Solution-> Check the cable; there may be disturbance.

- COM BROKEN

Problem-> Communication between VT and Device interrupted.

Solution-> Check the serial connection cable.

An error message followed by [*] indicates that the error is not currently present but was and has since disappeared.

Example: COM BROKEN*

When  is pressed you quit the display of information regarding the driver.

Adjusting the contrast on the display

To improve the quality of the representation on the display it may be necessary to adjust its contrast. This can be done by going to the page proposed (see Page 16-23) and changing the value (from +31 to -32) in evidence at that moment. Increase the value to darken the display; to lighten it, decrease the value.

We advise this to be done at typical room temperature and with the terminal at operating temperature (about 30 minutes after switching on and with the screen saver disabled - see Software Manual).

Chapter 17 Video terminal VT515W

Contents	Page
Technical characteristics	17-2
Functions	17-4
Front view	17-8
Standard series rear view	17-9
CAN series rear view	17-10
Ethernet series rear view	17-11
Dimensions and Cut-out	17-12
Accessories	17-13
Calibration of Touch Screen	17-13
Termination of CAN line	17-16
Introducing the MAC address	17-17
Transfer PC -> VT	17-20
Preparation for reception	17-20
Information relating to driver	17-22
Adjusting the contrast on the display	17-25

This chapter consists of 26 pages.

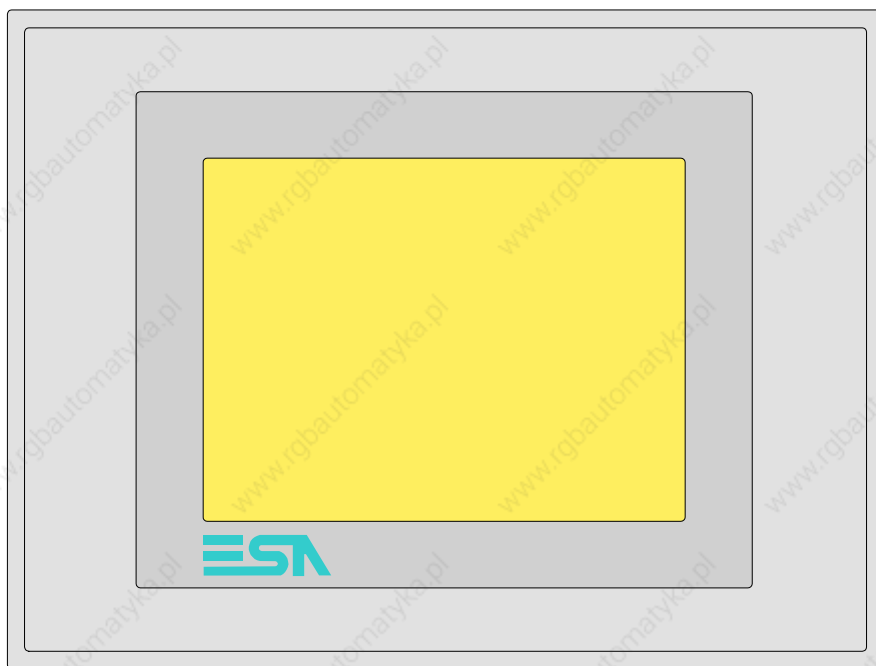

Technical characteristics

The following table lists the principal technical characteristics of the product in question.

Code of terminal	Characteristics of the terminal			
VT515W 00000				
VT515W 000DP				
VT515W 000CN				
VT515W 000ET				
Display		▼	▼	▼
Type	LCD 4 tones of blue STN	●	●	●
	LCD 16 Colors STN			
	LCD 16 Colors TFT			
Touch screen	Matrix 20 x 16 (Cell:16x15 pixels)	●	●	●
Representational format	Graphic	●	●	●
Resolution [pixels]	320 x 240 (5,7")	●	●	●
Rows x characters	16 x 40 / 8 x 20 / 4 x 10	●	●	●
Display area size [mm]	115,2 x 86,4	●	●	●
Character matrix in text mode [pixels]	8 x15 / 16 x 30 / 32 x 60	●	●	●
Character size [mm] x 1 / x 2 / x 4	2,8 x 5,2 / 5,6 x 10,4 / 11,2 x 20,8	●	●	●
Contrast adjustment	Software	●	●	●
	Automatic compensation with temperature	●	●	●
Character sets	Programmable fonts/TTF Windows ®	●	●	●
Backlighting				
Type	LED			
	CCFL lamp	●	●	●
Minimum lamp-life at 25°C [hours]	15000	●	●	●

Code of terminal	Characteristics of the terminal			
VT515W 0000				
VT515W 000DP				
VT515W 000CN				
VT515W 000ET				
User memory				
Project [Bytes]	640K	●	●	●
Data memory [Bytes]	16K (Flash EPROM)	●	●	●
Memory for Windows ® -based fonts [Byte]	32K	●	●	●
Memory Card for backup	--			
Memory Card for expansion	--			
Interfaces				
MSP (Multi-serial port)	RS232/RS422/RS485/TTY-20mA		●	●
ASP (Auxiliary serial port)	RS232/RS485			
ASP-15L (Auxiliary serial port)	RS232/RS485			
ASP-8 (Auxiliary serial port)	RS232	●		
ASP-9 (Auxiliary serial port)	RS232			
LPT parallel port	Centronics			
Auxiliary port	Connections for accessories			
Accessories				
Connectable accessories	See table "Chapter 33"	●	●	●
Clock				
Clock	Hardware (with Supercapacitor - Min.72h Typically130h)	●	●	●
Networks				
Integrated	Profibus-DP			●
	CAN Open (Optoisolated interface)		●	
	Ethernet 10/100Mbit RJ45	●		
Universal Bus Connector	--			
Optional	See table "Chapter 33"	●	●	●
Proprietary networks				
ESA-Net	Network server			
	Network client			●
Technical data				
Power supply	24Vdc (18..32Vdc)			
Power absorbed at 24Vdc	10W			
Protection fuse	Ø5x20mm - 800mA Quick Blow F			
Protection level	IP65 (front-end)			
Operating temperature	0..50°C			
Storage and transportation temperature	-20..+60°C			
Humidity (non-condensing)	<85%			
Weight	1400gr			
Dimensions				
External W x H x D [mm]	210 x 158 x 54			
Cut-out W x H [mm]	198 x 148			
Certification				
Certifications and approvals	CE, cULus, NEMA12			

Functions

The following table lists in alphabetical order all the functions of the VT in question.

Table 17.1: Functions and objects realizable with this VT (Part 1 of 4)

Code of terminal		
VT515W *****	Objects/Functions	Quantity
Alarm field		●
Alarm help	256	●
Alarm history buffer	220	●
Alarm statistics		
Alarms (Total/active simultaneously)	256/256	●
Arc		●
Automatic operations	32	●
Backup/Restore		●
Bar data		●
Bit-wise password	8bits	●
Buttons	320 x page	●
Circles		●
Command: Change language		●
Command: Clear trend buffer		
Command: Delete recipe		●
Command: Hardcopy		
Command: Load recipe from data memory		●
Command: Modify password		●
Command: Next page		●
Command: Page help		●
Command: Password login		●
Command: Password logout		●
Command: Previous page		●
Command: Print alarm history		
Command: Printer form feed		
Command: Quit project		●
Command: Report		
Command: Restarts reading time-sampled trend		
Command: Run pipeline		
Command: Save alarms history and trend buffers in flash		●
Command: Save recipe in data memory		●
Command: Save recipe received from device in buffer		●
Command: Save recipe received from device in data memory		●
Command: Send recipe from video buffer to device		●
Command: Send recipe to device		●
Command: Service page		●

Unless otherwise stated, there is no limit to the number of includable elements, only the size of project memory sets a limit. *) indicative value determined by the dimensions of the project, **) depends on memory available

Table 17.1: Functions and objects realizable with this VT (Part 2 of 4)

Code of terminal		
VT515W *****		
Objects/Functions	Quantity	▼
Command: Show alarms history		●
Command: Show page directory		●
Command: Show project information		●
Command: Show recipe directory		●
Command: Show sequence directory		
Command: Shows driver status page		●
Command: Shows page help		●
Command: Shows page with function: PG		
Command: Stops reading time sampled trend		
Command: Trend reading saved in device		
Command: Zero number of general pages		
Date field		●
Day-of-the-week field		●
Dynamic texts: Bit-group-structured dynamic texts		●
Dynamic texts: Single-bit dynamic texts	1024*	●
Dynamic texts: Value-structured dynamic texts		●
E-keys		
Equations	32	●
F-keys		
Free terminal		
Function: Disables key		
Function: Go to page		●
Function: Internal command		●
Function: Invert bit value		●
Function: Macro		●
Function: None		
Function: Reset bit permanently		●
Function: Reset real-time bit		●
Function: Sequences		
Function: Sets bit permanently		●
Function: Sets real-time bit		●
Function: Value-structure direct command		●
Global configuration of E-keys		
Global configuration of F-keys		
Headers and footers (Total/Number of fields per H-F)		
Info-messages (Total/active simultaneously)	256/256	●
Internal registers	4096bytes	●
Labels		●
LEDs assigned to sequence		

Unless otherwise stated, there is no limit to the number of includable elements, only the size of project memory sets a limit.
 *) indicative value determined by the dimensions of the project, **) depends on memory available

Table 17.1: Functions and objects realizable with this VT (Part 3 of 4)

Code of terminal		
VT515W *****		
Objects/Functions	Quantity	▼
Lines		●
Lists of bitmap images		●
Lists of texts		●
Local configuration of E-keys		
Local configuration of F-keys		
Macro field		
Macros (Total/Commands x macro)	1024/16	●
Message field		●
Message help	256	●
Multilanguage texts	4 Langs.	●
Object - Indicator		
Object - Potentiometer knob		
Object - Selector knob		
Object - Sliding potentiometer		
Object - Sliding selector		
Page	128	●
Page help	128	●
Password	10	●
Pipelines (Number/Tot bytes)		
Print		
Print page (Total/Number of fields per page)		
Programmable fonts		●
Project images		●
Public variables of ESANET network (Number/Total bytes)		
Recipe field for recipe structure		●
Recipes (Number of variables per recipe)	128/256	●
Rectangles		●
Redefinable characters		
Reports		
Sequences - Random		
Sequences - Start/stop		
Static bitmaps		●
Symbolic field: Bit-group-structured dynamic bitmaps	1024*	●
Symbolic field: Single-bit-structured dynamic bitmaps		●
Symbolic field: Value-structured dynamic bitmaps		●
System messages		●
System variables assigned to recipe structure		●
Time long field		●
Time short field		●

Unless otherwise stated, there is no limit to the number of includable elements, only the size of project memory sets a limit.
*) indicative value determined by the dimensions of the project, **) depends on memory available

Table 17.1: Functions and objects realizable with this VT (Part 4 of 4)

Code of terminal		
VT515W ****		
Objects/Functions	Quantity	▼
Timer	32	●
Touch Area	24	●
Trend buffers		
Trends (Trends x page/Channels x trend)		
Trends sampled automatically (Memory/Trends/Readings)		
Trends sampled on command (Memory/Trends/Readings)		
Value direct command: ADD		●
Value direct command: AND		●
Value direct command: OR		●
Value direct command: SET		●
Value direct command: SUBTRACT		●
Value direct command: XOR		●
Variables: Limit values and linear scaling variables	34 x pages	●
Variables: Movement variable (Mobile symbolic field)		●
Variables: Threshold variables		●
Variables: Floating Point numerical variables		●
Variables: Numerical variables (DEC, HEX, BIN, BCD)		●
Variables: String variables (ASCII)		●
		●

Unless otherwise stated, there is no limit to the number of includable elements, only the size of project memory sets a limit.
 *) indicative value determined by the dimensions of the project, **) depends on memory available

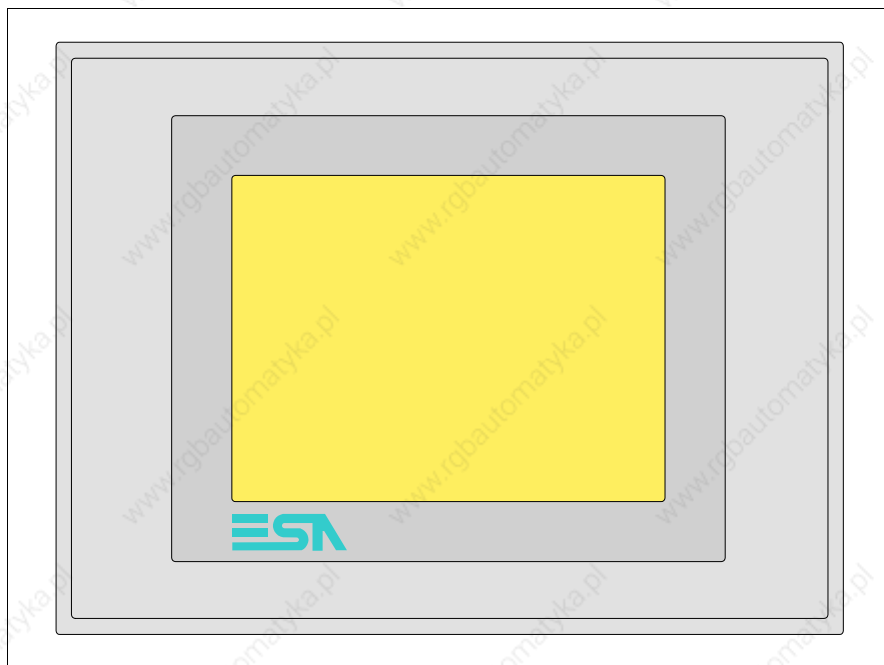
Front view

All buttons and signals are defined using the programming software (see Software Manual).

Standard series rear view

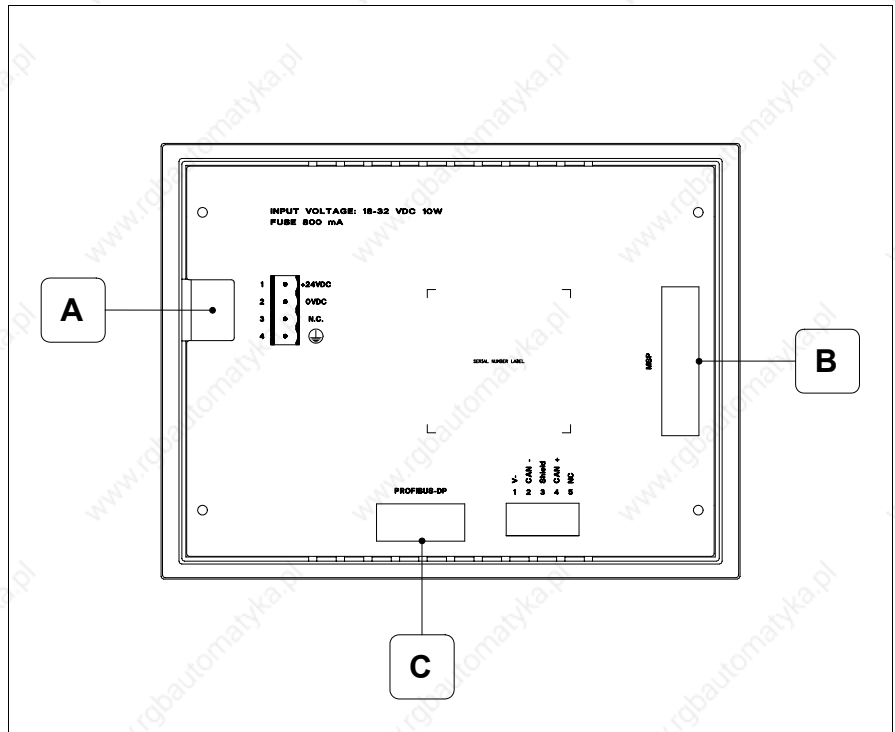

Position	Function
A	Power supply connector
B	MSP serial port for communicating with PLC/PC
C	PROFIBUS-DP serial port for network communication (Option)

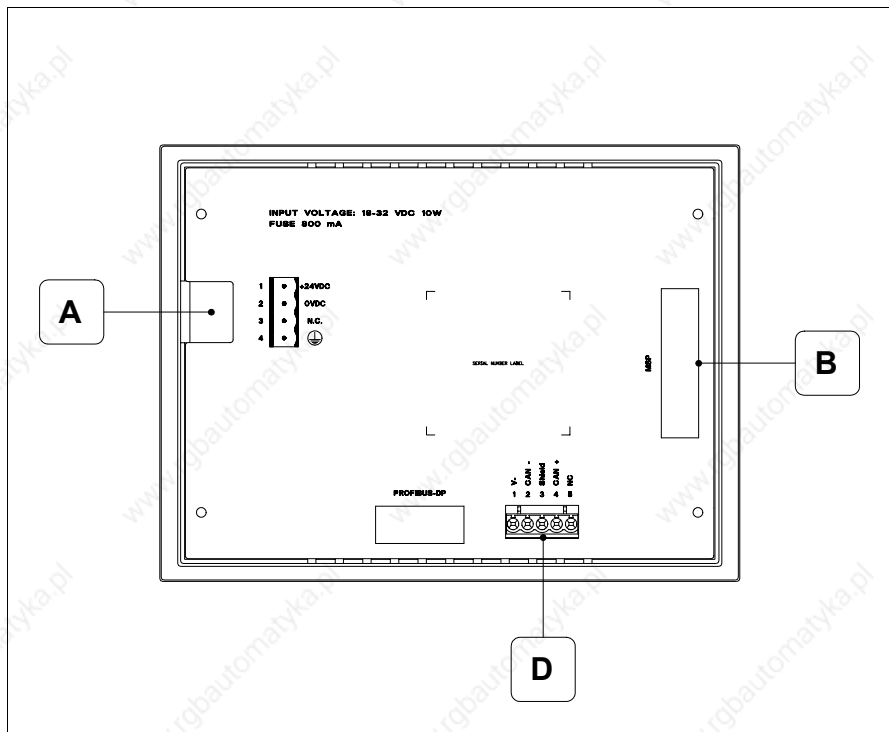
**CAN series
rear view**

Position	Function
A	Power supply connector
B	MSP serial port for communicating with PLC/PC
D	CAN serial port

Ethernet series rear view

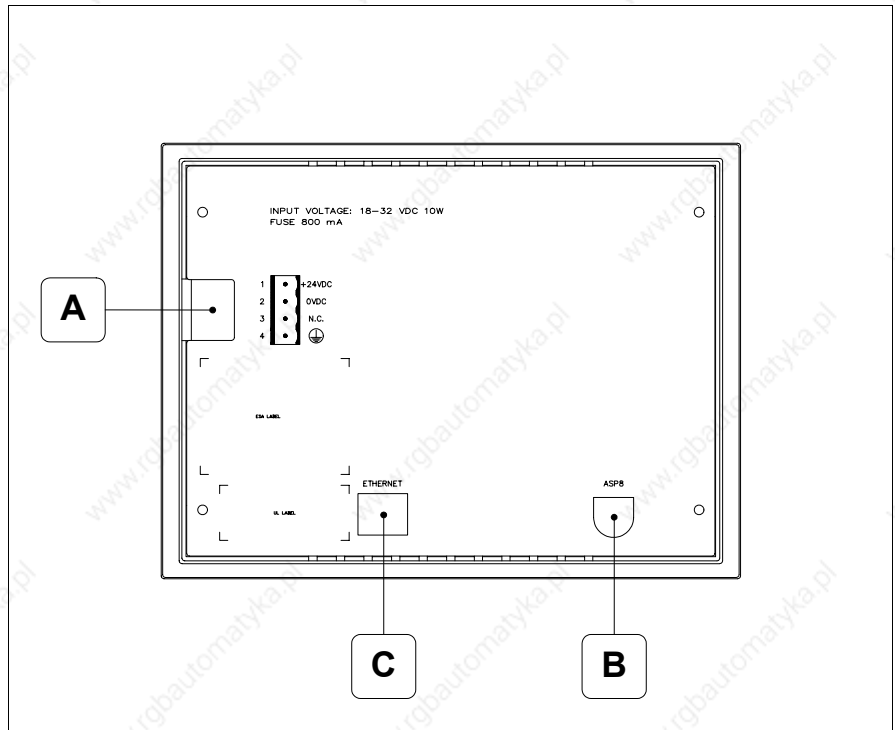

Position	Function
A	Power supply connector
B	ASP serial port for communicating with PC or other devices
C	Ethernet network 10/100Mbit RJ45 (For the diagnostic mode of the LEDs see "Chapter 30 -> Ethernet port")

**Dimensions
and Cut-out**

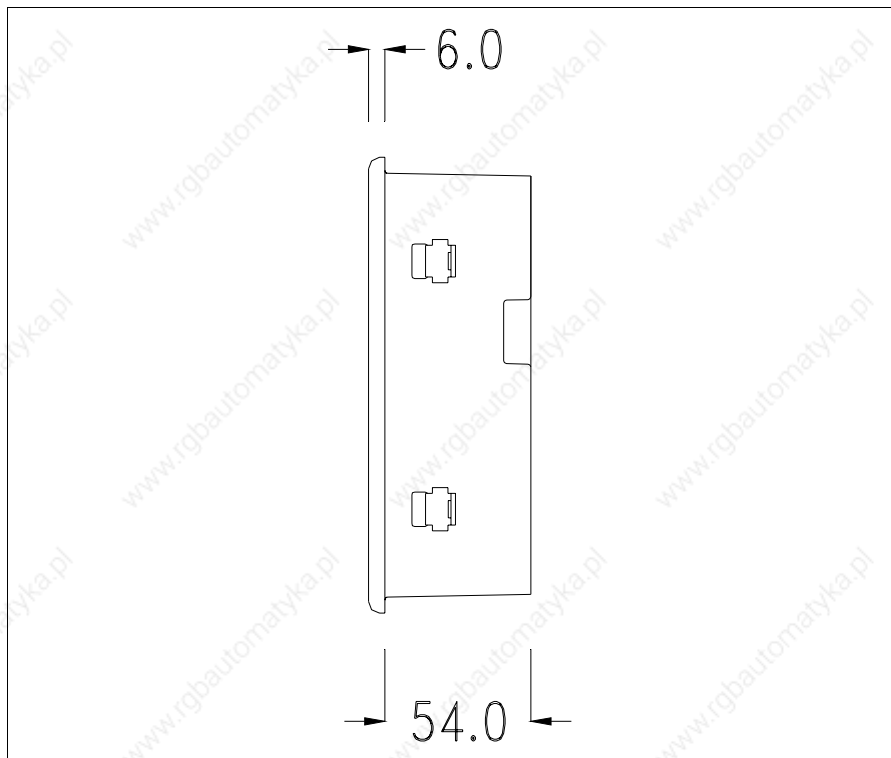
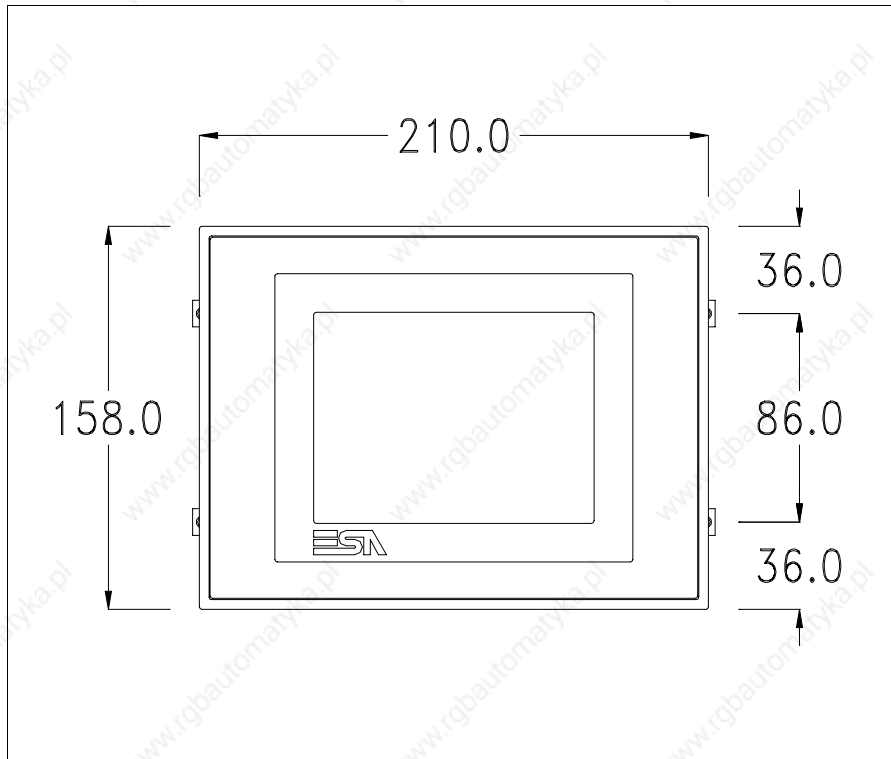

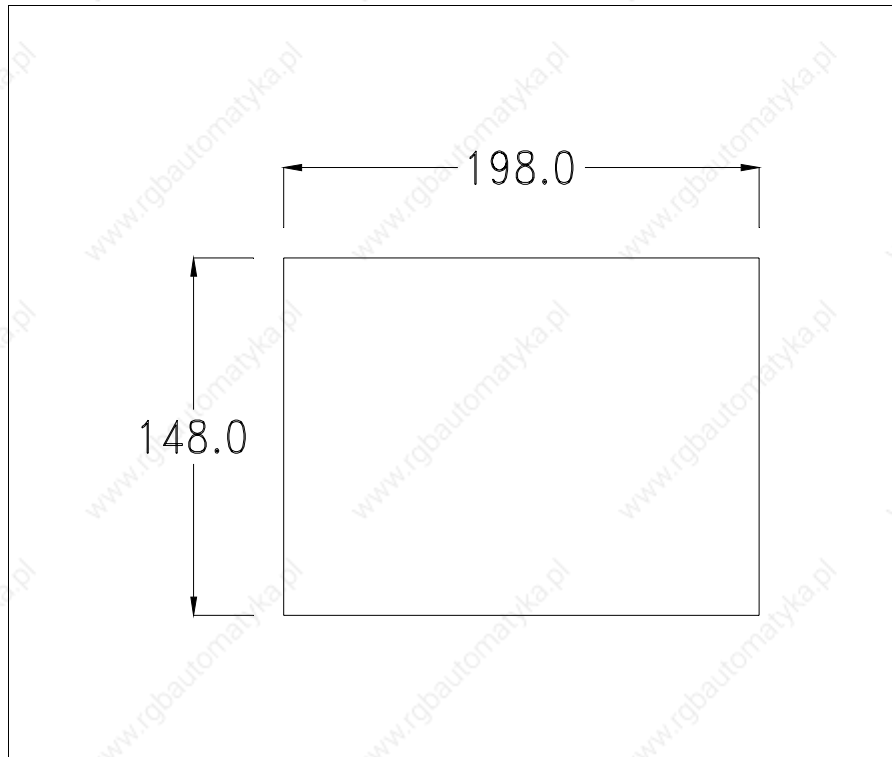

To fix the sealing gasket and secure the VT to the container see “Chapter 29 -> Mounting the terminal within the container“.

⚠ Where accessories need to be fixed in or onto the VT terminal, you are advised to do this before securing the VT to its container.

Accessories

Any accessories should be mounted in accordance with the instructions in the relevant chapter (see “Chapter 33 -> Video terminal accessories“).

Calibration of Touch Screen

The screen of VT515W is made of resistive, sensitive glass; for this type of glass to work properly it requires a calibration procedure (**the terminal is already calibrated when supplied**), that is, the resistive area of the glass has to be adjusted to the visible area of the display.

Should it be thought necessary to repeat the calibration procedure this can be done by following the instructions set out below.

⚠ The procedure must be carried out with great care as the precision of the keys area depends on the calibration.

How to perform the calibration procedure:

- Make sure the VT is not connected to the power supply
- Remove the back cover
- Identify jumper J1

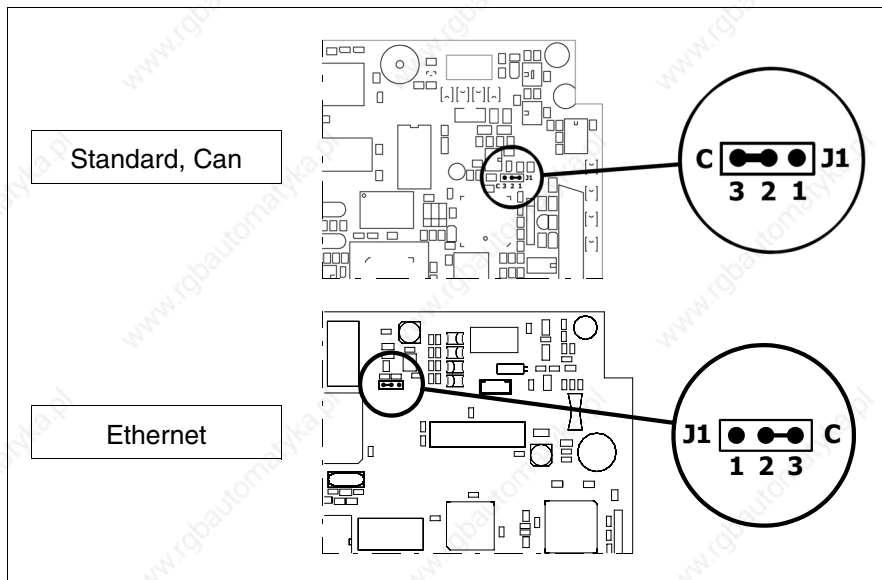

- Position J1 on pins 2-3 (C)
- Reconnect the power supply and switch on the terminal; the following mask appears

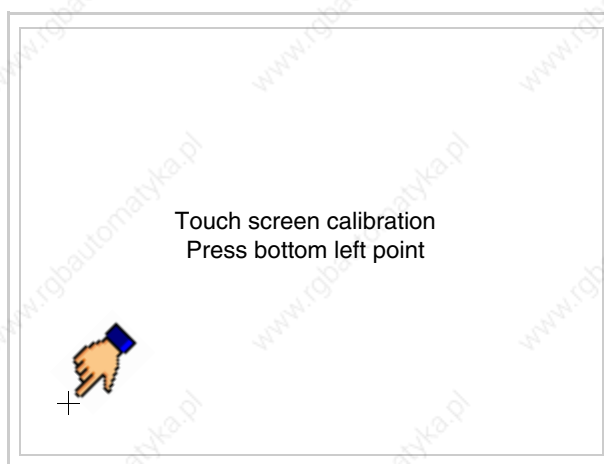

- Touch the corner indicated in the figure; then the following page appears on screen

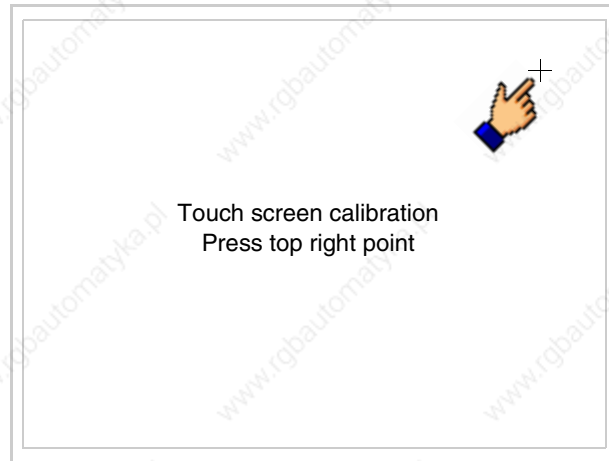

- Touch the corner indicated in the figure to complete the calibration procedure; the following page now appears

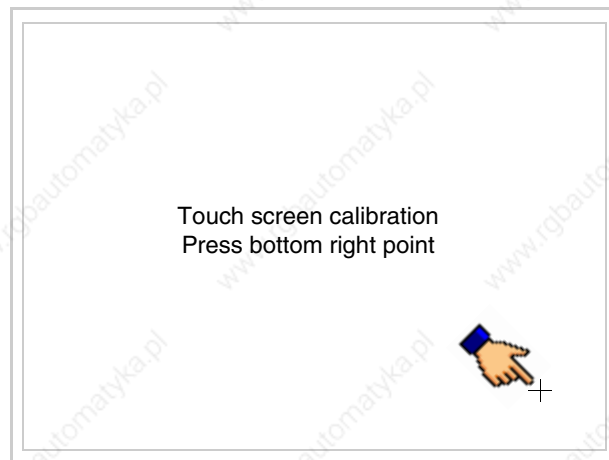

- Wait a few moments until the VT displays either the following mask or the project page (the page may be slightly different in its wording depending on which series the terminal belongs to)

```
VT515 TRANSFER PAGE

Main BOOT and RAM check   : OK
Main FIRMWARE check      : OK

*** WAIT FOR BOOT FORCED ***
```

- Switch off the terminal
- Reposition J1 on pins 1-2
- Replace the back cover
- Switch on the terminal again

The calibration procedure has finished; if the calibration has been carried out wrongly or imprecisely, repeat the procedure.

Termination of CAN line

This paragraph applies only to the CAN series. The VT in question integrates the termination resistances of the serial line (typically 120 ohms) which can be inserted by means of a jumper (preset on 1-2, line not terminated). To activate the termination:

- Make sure the device is not connected to the power supply.
- Remove the cover.
- Identify the jumper unit J4.

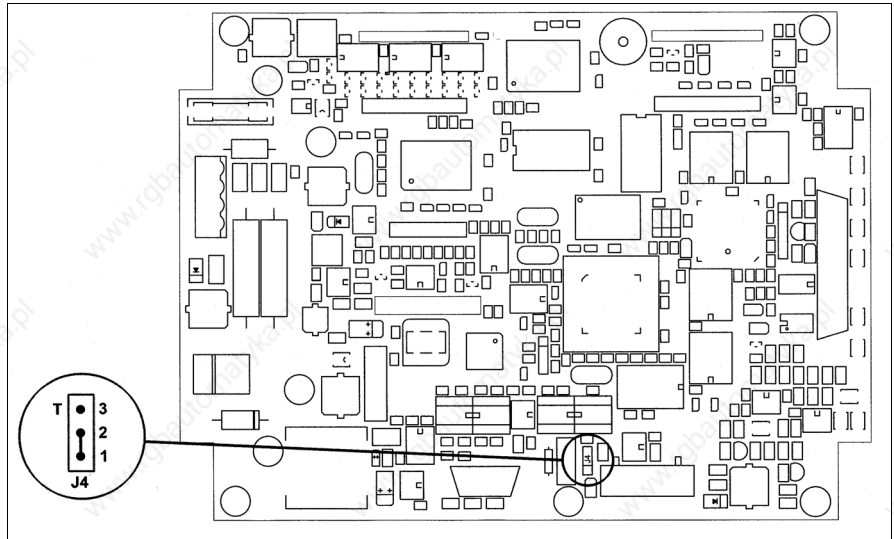

- Position the jumper between pins 2 and 3 (line terminated).
- Replace the back cover.
- Reconnect the power supply.

Introducing the MAC address

This paragraph relates only to the Ethernet series. The Media Access Control (MAC) address unambiguously identifies each terminal connected in the Ethernet network. The terminal is acquired with the address already programmed and is shown on the display of the terminal in the transfer page.

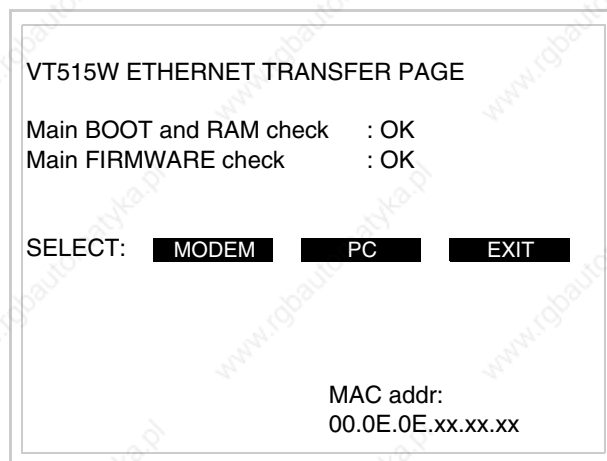

The MAC address is permanently memorized in the terminal, but should it be necessary to execute an “aided” BOOT update (see Software Manual “Chapter 14 -> BOOT update”) the address is lost.



This operation must be carried out only with the advice of the

ESA Customer Care Department.

Terminals with no valid MAC address when switched present a mask for its insertion. If no MAC address belonging to the terminal is available, proceed as follows:

- Check that the VT is not connected to the power supply.
- Remove the back cover
- Locate the label carrying the MAC address

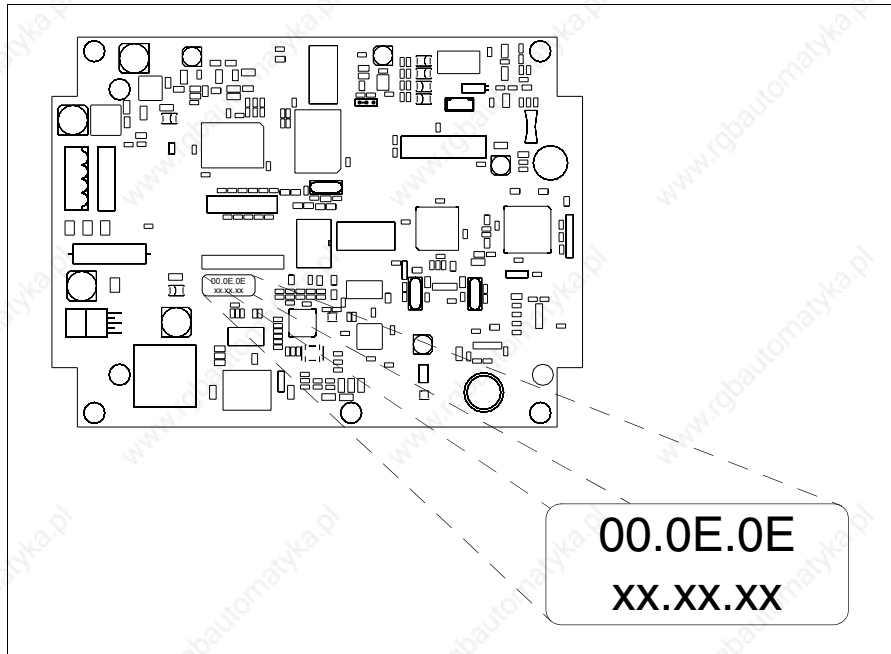

- Make a note of the number on the label (e.g. 00.0E.0E.00.00.01)

00.0E.0E -> fixed part that identifying as an ESA product
XX.XX.XX -> variable part different for each terminal

- Reconnect the power supply to the terminal and, if necessary, calibrate the touch screen (see Page 17-13)
- Replace the back cover
- Switch on the terminal again
- The following mask appears; introduce the address previously noted down (e.g. 00.0E.0E.00.00.01)

Enter a valid MAC address:
00.0E.0E.00.00.00

↑

← → ↓ ↶

This screenshot shows a terminal window with a prompt to enter a valid MAC address. The address 00.0E.0E.00.00.00 is displayed. Below the prompt are five arrow keys: an up arrow, a left arrow, a right arrow, a down arrow, and a left arrow with a small square icon.

- Use the arrow  to make the setting. Once the address has been confirmed the following page is displayed

VT515W ETHERNET TRANSFER PAGE

Main BOOT and RAM check : OK
Main FIRMWARE check : OK

SELECT: **MODEM** **PC** **EXIT**

MAC addr:
00.0E.0E.00.00.01

This screenshot shows the 'VT515W ETHERNET TRANSFER PAGE'. It displays the results of 'Main BOOT and RAM check' and 'Main FIRMWARE check', both of which are 'OK'. Below this, there is a 'SELECT:' prompt with three options: 'MODEM', 'PC', and 'EXIT', each in a black box. At the bottom, the 'MAC addr:' is shown as '00.0E.0E.00.00.01'.

The procedure is now terminated.

 **Should a wrong MAC address have been inserted contact the ESA Customer Care Department.**

 **A wrong address could give rise to an error of conflict between VT terminals in the Ethernet network.**

**Transfer PC ->
VT**

For everything to function properly, the first time the VT operator terminal is switched on it needs to be correctly loaded, that is it needs to have transferred to it:

- Firmware
- Communication driver
- Project

(Given that the transfer of the three files in practice occurs with a single operation, it will be defined as “Project transfer” for the sake of simplicity.)

For this it is essential that the VT be prepared to receive the transfer. (See also “Chapter 37 -> Command area“).

**Preparation
for reception**

The program VTWIN (see Software Manual) must be used for the transfer, but the terminal must be set up to receive. This means carrying out the following steps:

- Check that the VT is off
- Check that there is a serial connection between the PC and the VT
- Switch on the VT and wait for the following mask to appear
- Press one after the other the diagonally opposite corners free of settable objects or buttons (at least one corner needs to be free)

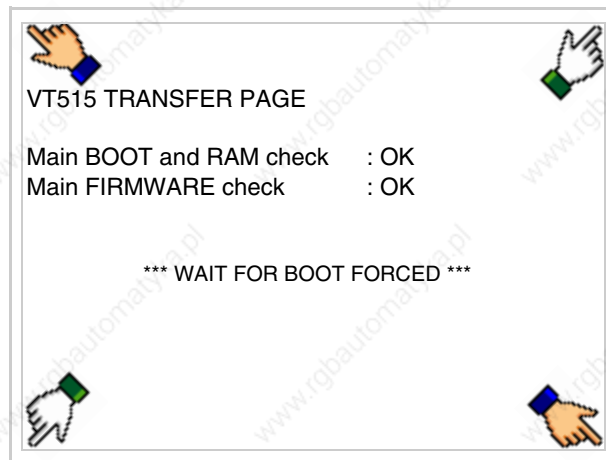

and wait a moment, or, using the appropriate button (see Page 17-24), till the VT displays the following mask

VT terminal with no Modem function:

The VT is now ready to receive (see Software Manual for information on the transmission procedure)

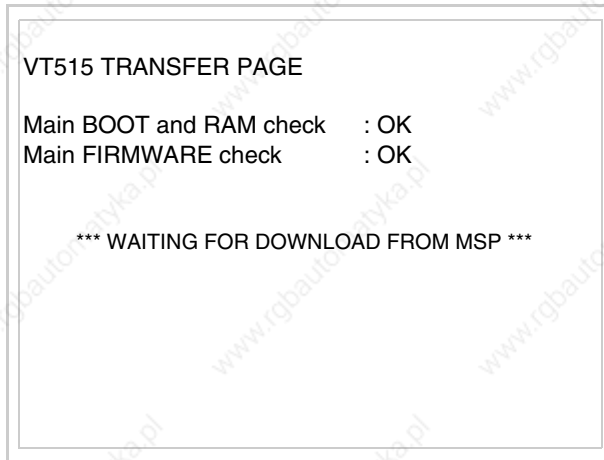
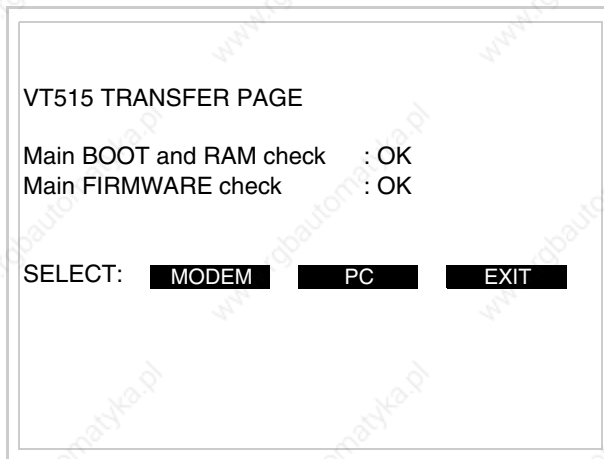
**VT terminal with Modem function:**

- Choose the required transfer mode: MODEM if you intend to use a modem or PC if you intend to use a serial port; touch the relevant on the display

If the choose made is PC, the VT is ready to receive (see Software Manual for transfer), if, on the other hand, you choose MODEM, the following mask will appear

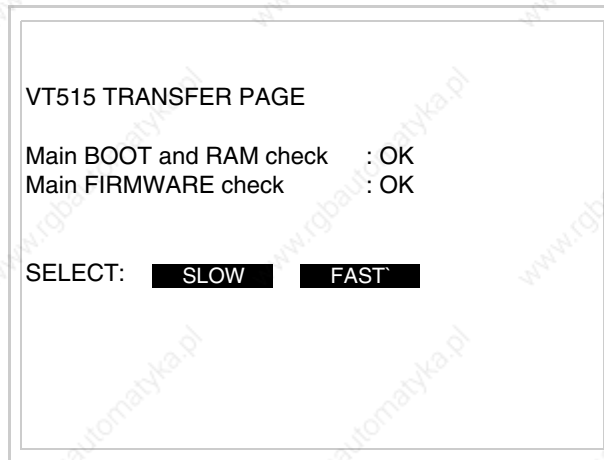

The choice should be according to the speed you intend to use for the transfer (Slow=9600bit/sec or Fast=38400bit/sec), touch the relevant  on the display. The VT is now ready to receive (see Software Manual for the transfer).

Information relating to driver

After the project has been transferred, the VT can make available information relating to what has been loaded. The information regards:

- Serial ports present
- The name of the driver loaded
- The version of the driver loaded
- Network address of the VT
- Last error to have occurred

To acquire this information carry out the following operations:

- Be situated in any page of the project
- Press two diagonally opposed angles that are free of any settable objects or buttons (at least one angle must be free)



and you will see

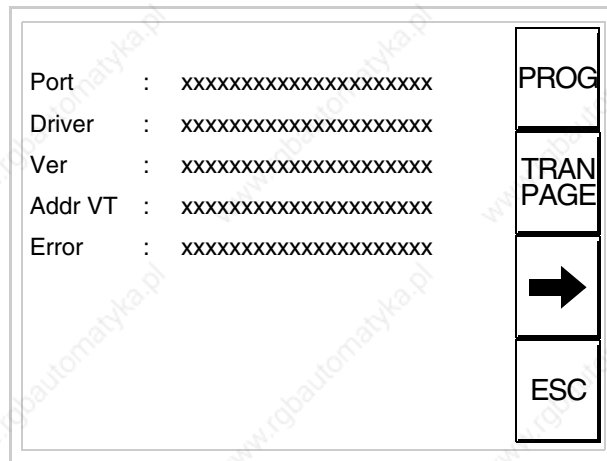

There is one of these pages for each communication port; movement between the various pages is effected by pressing .

From this page you can:

- Set the clock and the contrast
- Prepare the VT to receive the program

Setting the clock and the contrast:

To set the clock and the contrast, while displaying the above illustrated page, press ; the following mask appears

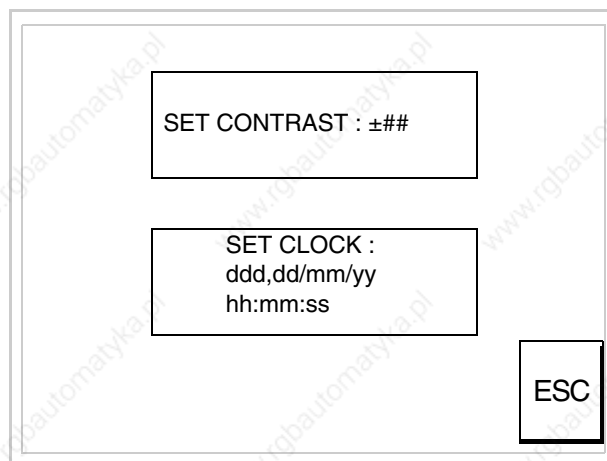

To set the contrast touch the words SET CONTRAST on the display;

you will see the following mask

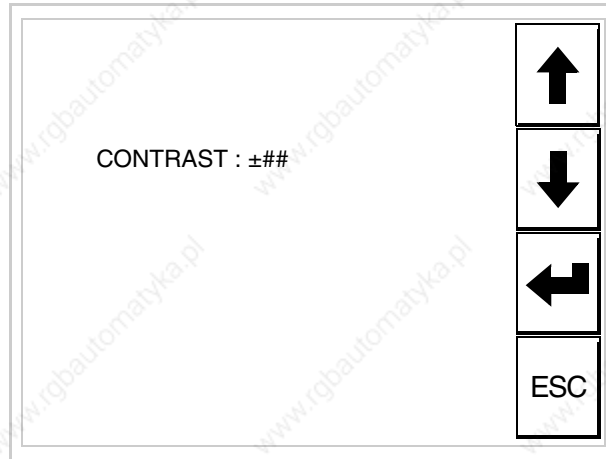

Use the arrow  for any variation (see “Chapter 36 -> Operation of terminal with touch screen”).

To set the clock touch the words SET CLOCK on the display; the following mask appears

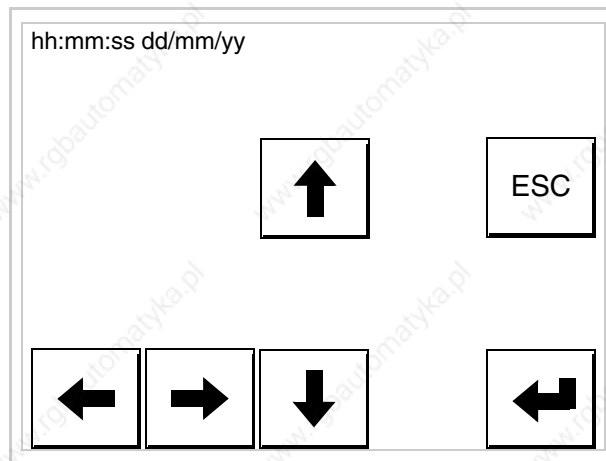

Use the arrow  for any variation (see “Chapter 36 -> Operation of terminal with touch screen”).

Prepare the VT to receive the program:

To prepare the VT to receive the program, while displaying the driver information page (see Page 17-22), press , and you will

see the following mask

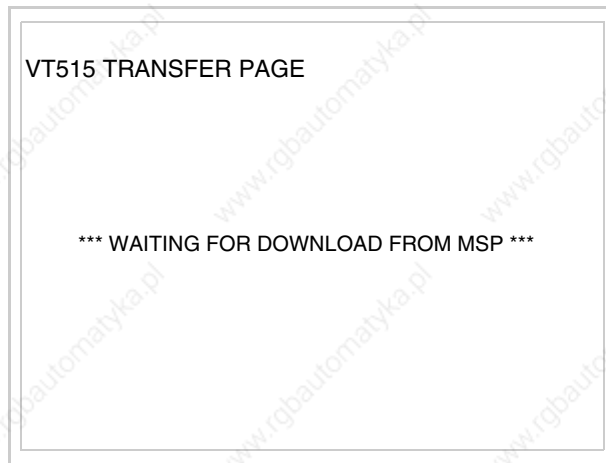

The VT terminal is now ready to receive (consult Software Manual for information on the transmission procedure).

Possible error messages that may be encountered in the driver information page are:

- PR ERR

Problem-> Errors have been detected in the data exchange between the VT and the Device.

Solution-> Check the cable; there may be disturbance.

- COM BROKEN

Problem-> Communication between VT and Device interrupted.

Solution-> Check the serial connection cable.

An error message followed by [*] indicates that the error is not currently present but was and has since disappeared.

Example: COM BROKEN*

When  is pressed you quit the display of information regarding the driver.

Adjusting the contrast on the display

To improve the quality of the representation on the display it may be necessary to adjust its contrast. This can be done by going to the page proposed (see Page 17-23) and changing the value (from +31 to -32) in evidence at that moment. Increase the value to darken the display; to lighten it, decrease the value.

We advise this to be done at typical room temperature and with the terminal at operating temperature (about 30 minutes after switching on and with the screen saver disabled - see Software Manual).

Chapter 18 Video terminal VT525H

Contents	Page
Technical characteristics	18-2
Functions	18-5
Front view	18-9
Rear view	18-10
Dimensions and Cut-out	18-11
Accessories	18-12
Connection cable	18-12
Adjusting holding strap for grip	18-12
Calibration of Touch Screen	18-12
Transfer PC -> VT	18-15
Preparation for reception	18-15
Information relating to driver	18-18
Improving display color quality	18-23
Adjusting the contrast on the display	18-23

This chapter consists of 24 pages.



Technical characteristics

The following table lists the principal technical characteristics of the product in question.

Code of terminal	Characteristics of the terminal	
VT525H 00000		
VT525H 000CN		
Display		
Type	LCD 4 tones of blue STN	
	LCD 16 Colors STN	● ●
	LCD 16 Colors TFT	
Touch screen	Matrix 20 x 16 (Cell:16x15 pixels)	● ●
Representational format	Graphic	● ●
Resolution [pixels]	320 x 240 (5,7")	● ●
Rows x characters	16 x 40 / 8 x 20 / 4 x 10	● ●
Display area size [mm]	115,2 x 86,4	● ●
Character matrix in text mode [pixels]	8 x15 / 16 x 30 / 32 x 60	● ●
Character size [mm] x 1 / x 2 / x 4	2,9 x 5,4 / 5,8 x 10,8 / 11,6 x 21,6	● ●
Contrast adjustment	Software	● ●
	Automatic compensation with temperature	● ●
Character sets	Programmable fonts/TTF Windows ®	● ●
Backlighting		
Type	LED	
	CCFL lamp	● ●
Minimum lamp-life at 25°C [hours]	15000	● ●

1 - Using the VTHCB card (see "Chapter 33 -> Page 9")
2 - RS232 only

Code of terminal		Characteristics of the terminal	
VT525H 00000			
VT525H 000CN			
Keyboard			
Non-customizable function keys	10	●	●
User memory			
Project [Bytes]	960K	●	●
Data memory [Bytes]	32K (Flash EPROM)	●	●
Memory for Windows ® -based fonts [Byte]	256K	●	●
Memory Card for backup	--		
Memory Card for expansion	--		
Interfaces			
MSP (Multi-serial port)	RS232/RS422/RS485/TTY-20mA	● ²	● ¹
ASP (Auxiliary serial port)	RS232/RS485		
ASP-15L (Auxiliary serial port)	RS232/RS485		● ²
ASP-8 (Auxiliary serial port)	RS232		
ASP-9 (Auxiliary serial port)	RS232		
LPT parallel port	Centronics		
Auxiliary port	Connections for accessories		
Accessories			
Connectable accessories	See table "Chapter 33"	●	●
Clock			
Clock	Hardware (with Supercapacitor - Min.72h Typically130h)	●	●
Networks			
Integrated	Profibus-DP		
	CAN Open (Optoisolated interface)	●	
	Ethernet 10/100Mbit RJ45		
Universal Bus Connector	--		
Optional	See table "Chapter 33"	●	●
Proprietary networks			
ESA-Net	Network server		
	Network client		●

1 - Using the VTHCB card (see "Chapter 33 -> Page 9")

2 - RS232 only

Wrapping	
Type	Antiflame PC/ABS halogen-free (UL94 5VA at 2.5mm)
Drop test	1 m.
Connection cable	
Type	Antiflame shielded cable halogen and silicone-free
Radius of curve (moving/fixe)	120mm/60mm
Conductors (number/section)	25x0,25mmq (AWG24)
System shut-down button	
Positions	2 (Normal - Pushed)
Contacts	1 NC + 1 NC (NC1/NC2 + NC3/NC4)
Maximum tension	30Vdc
Maximum/minimum current	500mA/5mA
Conforms to the following standard(s)	EN 60947-5-1, UL-508, CSA 22.2. No. 14)
Enabling button	
Positions	3 (Normal - Pushed - Panic)
Contacts	1 NC/NO + 1 NC/NO (NC1/NO1/C1 + NC2/NO2/C2)

Maximum tension	30Vdc
Maximum/minimum current	500mA/5mA
Conforms to the following standard(s)	IEC 60947-5-1, EN 60947-5-1, JIS C8201-5-1, UL-508, CSA 22.2. No. 14
Approval(s)	ISO12100/EN292, IEC60204-1/EN60204-1, ISO11161/prEN11161, ISO10218/EN775, ANSI/RIA R15.06
Technical data	
Power supply	24Vdc (18..32Vdc)
Power absorbed at 24Vdc	10W
Protection fuse	Self-resetting
Protection level (Certificated)	IP65
Operating temperature	0..50°C
Storage and transportation temperature	-20..+60°C
Humidity (non-condensing)	<85%
Weight (with cable length 10m)	3000gr
Dimensions	
External W x H x D [mm]	See on Page 33-8
Cut-out W x H [mm]	--
Certification	
Certifications and approvals	CE

Functions

The following table lists in alphabetical order all the functions of the VT in question.

Table 18.1: Functions and objects realizable with this VT (Part 1 of 4)

Code of terminal		
VT525H *****		
Objects/Functions	Quantity	▼
Alarm field		●
Alarm help	256	●
Alarm history buffer	256	●
Alarm statistics		
Alarms (Total/active simultaneously)	256/256	●
Arc		●
Automatic operations	32	●
Backup/Restore		●
Bar data		●
Bit-wise password	8bits	●
Buttons	320 x page	●
Circles		●
Command: Change language		●
Command: Clear trend buffer		
Command: Delete recipe		●
Command: Hardcopy		●
Command: Load recipe from data memory		●
Command: Modify password		●
Command: Next page		●
Command: Page help		●
Command: Password login		●
Command: Password logout		●
Command: Previous page		●
Command: Print alarm history		●
Command: Printer form feed		●
Command: Quit project		●
Command: Report		●
Command: Restarts reading time-sampled trend		
Command: Run pipeline		
Command: Save alarms history and trend buffers in flash		●
Command: Save recipe in data memory		●
Command: Save recipe received from device in buffer		●
Command: Save recipe received from device in data memory		●
Command: Send recipe from video buffer to device		●
Command: Send recipe to device		●
Command: Service page		●

Unless otherwise stated, there is no limit to the number of includable elements, only the size of project memory sets a limit.
 *) indicative value determined by the dimensions of the project, **) depends on memory available

Table 18.1: Functions and objects realizable with this VT (Part 2 of 4)

Code of terminal		
VT525H *****		
Objects/Functions	Quantity	▼
Command: Show alarms history		●
Command: Show page directory		●
Command: Show project information		●
Command: Show recipe directory		●
Command: Show sequence directory		
Command: Shows driver status page		●
Command: Shows page help		●
Command: Shows page with function: PG		
Command: Stops reading time sampled trend		
Command: Trend reading saved in device		
Command: Zero number of general pages		●
Date field		●
Day-of-the-week field		●
Dynamic texts: Bit-group-structured dynamic texts		●
Dynamic texts: Single-bit dynamic texts	1024*	●
Dynamic texts: Value-structured dynamic texts		●
E-keys		
Equations	32	●
F-keys		●
Free terminal		
Function: Disables key		●
Function: Go to page		●
Function: Internal command		●
Function: Invert bit value		●
Function: Macro		●
Function: None		●
Function: Reset bit permanently		●
Function: Reset real-time bit		●
Function: Sequences		
Function: Sets bit permanently		●
Function: Sets real-time bit		●
Function: Value-structure direct command		●
Global configuration of E-keys		
Global configuration of F-keys		●
Headers and footers (Total/Number of fields per H-F)	32/128	●
Info-messages (Total/active simultaneously)	256/256	●
Internal registers	4096bytes	●
Labels		●
LEDs assigned to sequence		

Unless otherwise stated, there is no limit to the number of includable elements, only the size of project memory sets a limit.
*) indicative value determined by the dimensions of the project, **) depends on memory available

Table 18.1: Functions and objects realizable with this VT (Part 3 of 4)

Code of terminal		
VT525H *****		
Objects/Functions	Quantity	▼
Lines		●
Lists of bitmap images		●
Lists of texts		●
Local configuration of E-keys		
Local configuration of F-keys		●
Macro field		
Macros (Total/Commands x macro)	1024/16	●
Message field		●
Message help	256	●
Multilanguage texts	6 Langs.	●
Object - Indicator		
Object - Potentiometer knob		
Object - Selector knob		
Object - Sliding potentiometer		
Object - Sliding selector		
Page	150	●
Page help	150	●
Password	10	●
Pipelines (Number/Tot bytes)		
Print		●
Print page (Total/Number of fields per page)	64/128	●
Programmable fonts		●
Project images		●
Public variables of ESANET network (Number/Total bytes)		
Recipe field for recipe structure		●
Recipes (Number of variables per recipe)	128/256	●
Rectangles		●
Redefinable characters		
Reports	32	●
Sequences - Random		
Sequences - Start/stop		
Static bitmaps		●
Symbolic field: Bit-group-structured dynamic bitmaps	1024*	●
Symbolic field: Single-bit-structured dynamic bitmaps		●
Symbolic field: Value-structured dynamic bitmaps		●
System messages		●
System variables assigned to recipe structure		●
Time long field		●
Time short field		●

Unless otherwise stated, there is no limit to the number of includable elements, only the size of project memory sets a limit.
 *) indicative value determined by the dimensions of the project, **) depends on memory available

Table 18.1: Functions and objects realizable with this VT (Part 4 of 4)

Code of terminal		
VT525H *****		
Objects/Functions	Quantity	▼
Timer	32	●
Touch Area	24	●
Trend buffers		
Trends (Trends x page/Channels x trend)		
Trends sampled automatically (Memory/Trends/Readings)		
Trends sampled on command (Memory/Trends/Readings)		
Value direct command: ADD		●
Value direct command: AND		●
Value direct command: OR		●
Value direct command: SET		●
Value direct command: SUBTRACT		●
Value direct command: XOR		●
Variables: Limit values and linear scaling variables	48 x pages	●
Variables: Movement variable (Mobile symbolic field)		●
Variables: Threshold variables		●
Variables: Floating Point numerical variables		●
Variables: Numerical variables (DEC, HEX, BIN, BCD)		●
Variables: String variables (ASCII)		●

Unless otherwise stated, there is no limit to the number of includable elements, only the size of project memory sets a limit.
 *) indicative value determined by the dimensions of the project, **) depends on memory available

Front view

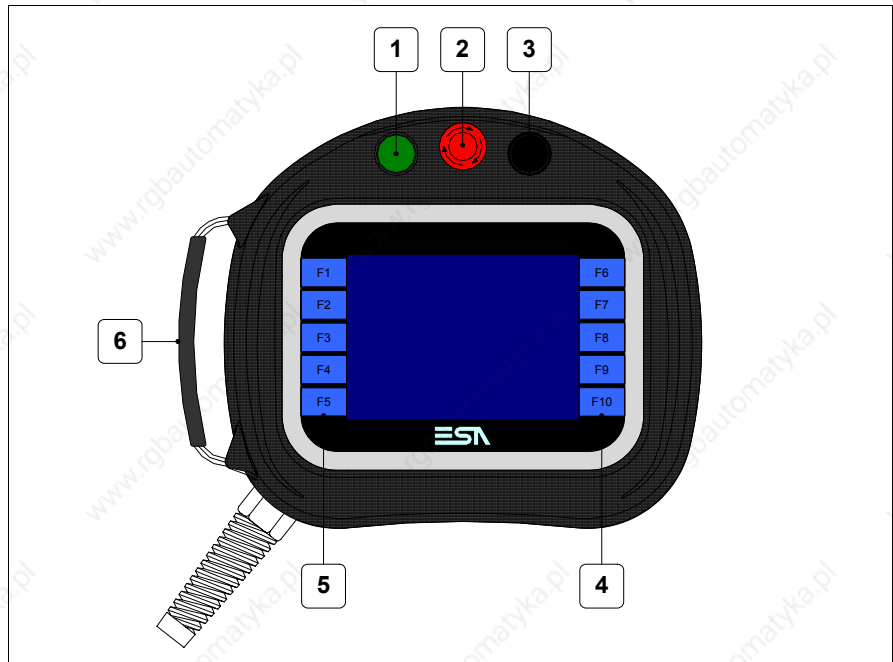

Key	Function
1	Command and/or signal unit
2	System shut-down button (Conforms to the following standard(s): EN 60947-5-1, UL-508, CSA 22.2. No. 14)
3	Command and/or signal unit
4	F-keys
5	F-keys
6	Adjustable gripper belt

Other buttons and signals are defined using the programming software (see Software Manual).

⚠ The system shut-down button and the enabling button do NOT guarantee the operator's complete personal safety. Be sure to design your system so that it ensures the operator's complete personal safety.

Rear view

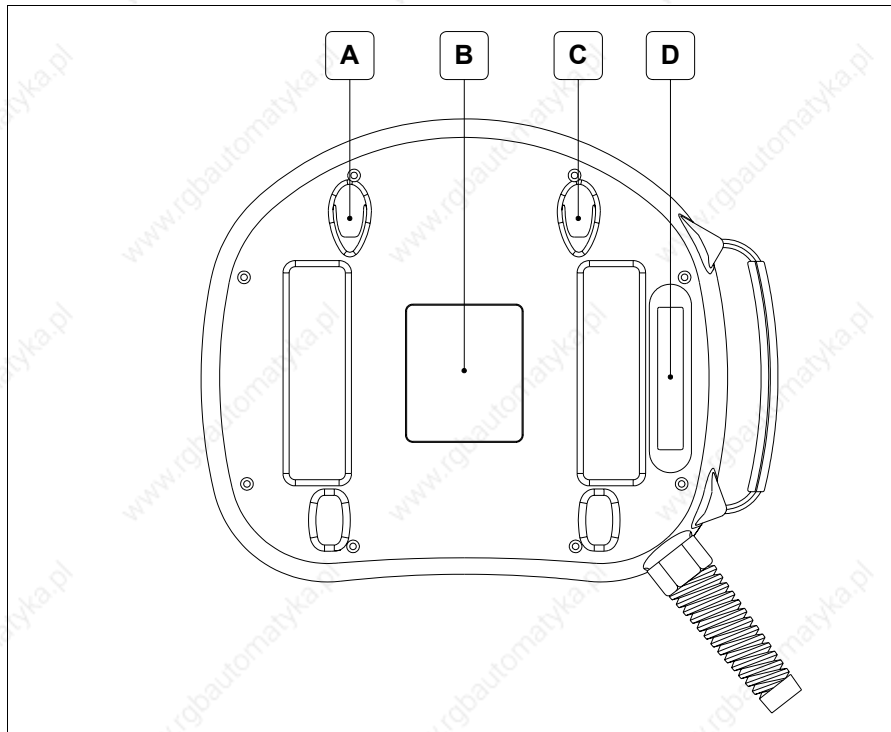

Position	Function
A	Housing for wall-fixing hook
B	Identification label
C	Housing for wall-fixing hook
D	Enabling button (Conforms to the following standard(s): IEC 60947-5-1, EN 60947-5-1, JIS C8201-5-1, UL-508, CSA 22.2. No. 14) (Approval(s): ISO12100/EN292, IEC60204-1/EN60204-1, ISO11161/prEN11161, ISO10218/EN775, ANSI/RIA R15.06)

⚠ The system shut-down button and the enabling button do NOT guarantee the operator's complete personal safety. Be sure to design your system so that it ensures the operator's complete personal safety.

Dimensions and Cut-out

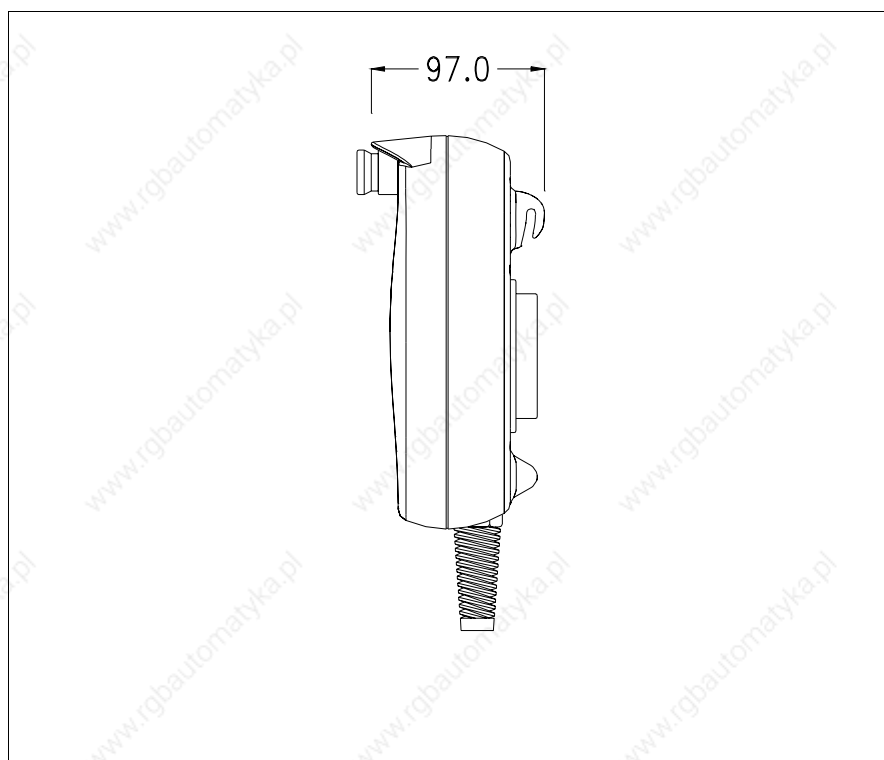
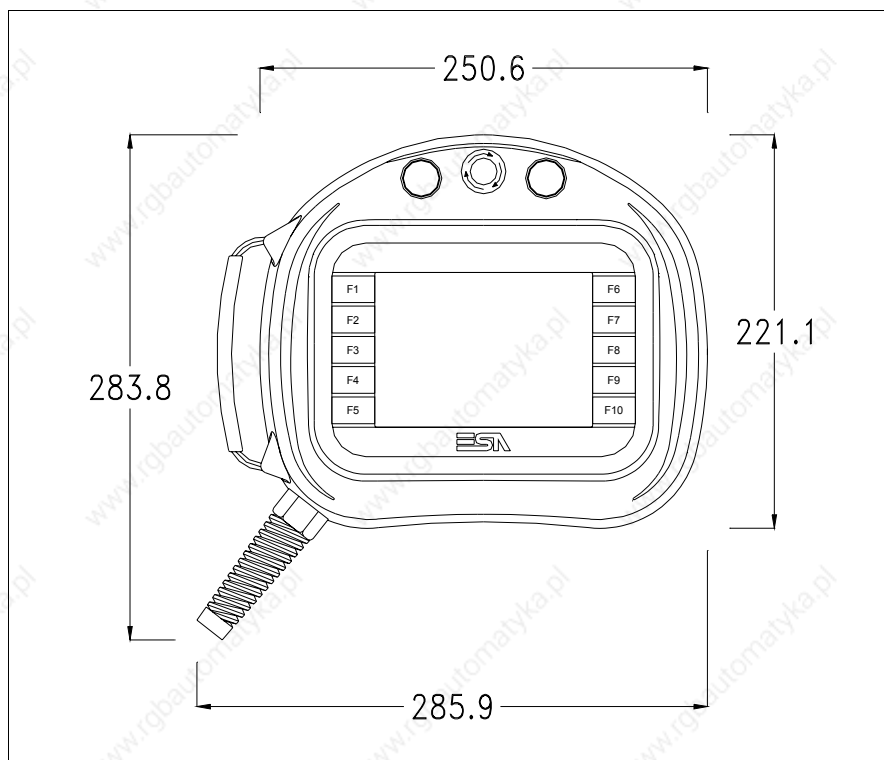

For VT mounting instructions see “Chapter 29 -> Mounting the terminal within the container“.

 **Where accessories need to be fixed in or onto the VT terminal, you are advised to do this before securing the VT to its container.**

Accessories

Any accessories should be mounted in accordance with the instructions in the relevant chapter (see “Chapter 33 -> Video terminal accessories“).

Connection cable

The terminal is provided with a 10m long (AWG24) 25x0.25mmq shielded cable already attached (see “Chapter 32 -> Connection cable for H Series terminals“).

Adjusting holding strap for grip

The strap can be altered to adjust the grip for different hand sizes. To alter strap:

- Open the leather cover
- Detach the strap ends
- Adjust the holding strap length
- Secure strap ends again
- Close leather cover

Calibration of Touch Screen

The screen of VT525H is made of resistive, sensitive glass; for this type of glass to work properly it requires a calibration procedure (**the terminal is already calibrated when supplied**), that is, the resistive area of the glass has to be adjusted to the visible area of the display.

Should it be thought necessary to repeat the calibration procedure this can be done by following the instructions set out below.

 **The procedure must be carried out with great care as the precision of the keys area depends on the calibration.**

How to perform the calibration procedure:

- Switch on the terminal; the following mask appears



- To access the calibration page, touch the message *****WAITING FOR BOOT FORCED***** three to six times in quick succession

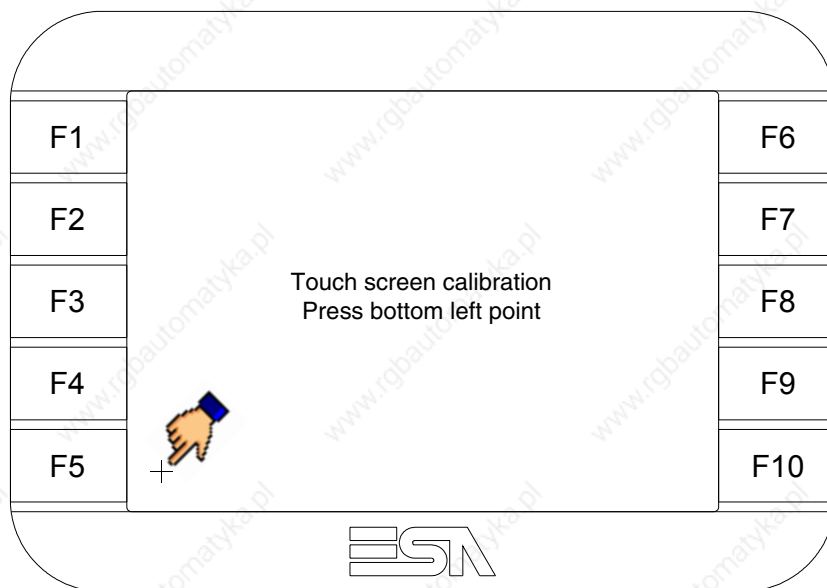

- Touch the corner indicated in the figure; then the following page appears on screen

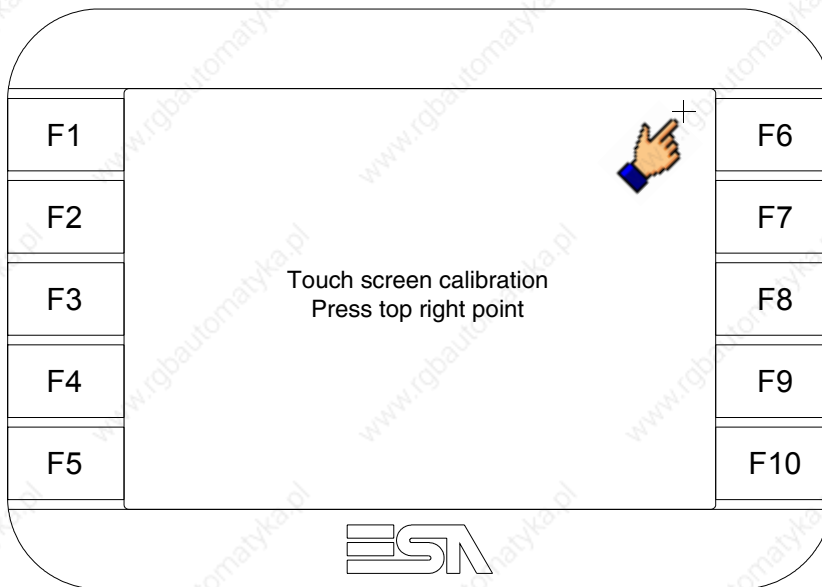

- Touch the corner indicated in the figure to complete the calibration procedure; the following page now appears

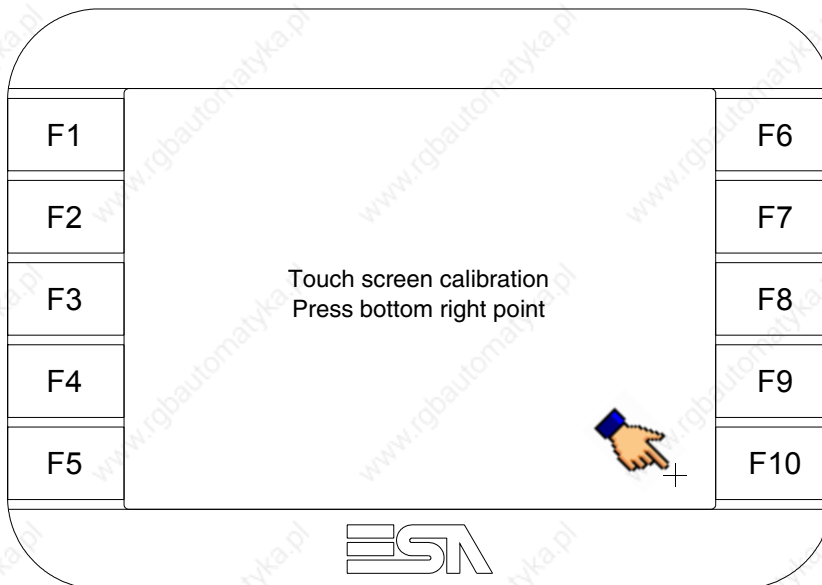

- Wait a few moments until the VT displays either the following mask or the project page (the page may be slightly different in its wording depending on which series the terminal belongs to)

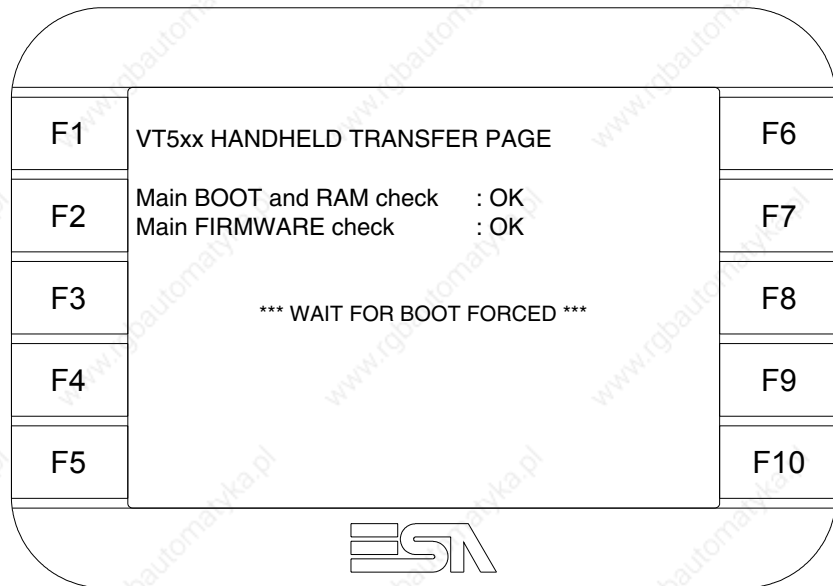

- Wait for the start-up of the VT to be completed

The calibration procedure has finished; if the calibration has been carried out wrongly or imprecisely, repeat the procedure.

Transfer PC -> VT

For everything to function properly, the first time the VT operator terminal is switched on it needs to be correctly loaded, that is it needs to have transferred to it:

- Firmware
- Communication driver
- Project

(Given that the transfer of the three files in practice occurs with a single operation, it will be defined as “Project transfer” for the sake of simplicity.)

For this it is essential that the VT be prepared to receive the transfer. (See also “Chapter 37 -> Command area”).

Preparation for reception

The program VTWIN (see Software Manual) must be used for the transfer, but the terminal must be set up to receive. This means carrying out the following steps:

- Check that the VT is off
- Check that there is a serial connection between the PC and the VT
- Switch on the VT and wait for the following mask to appear
- Press one after the other the diagonally opposite corners free of settable objects or buttons (at least one corner needs to be free)

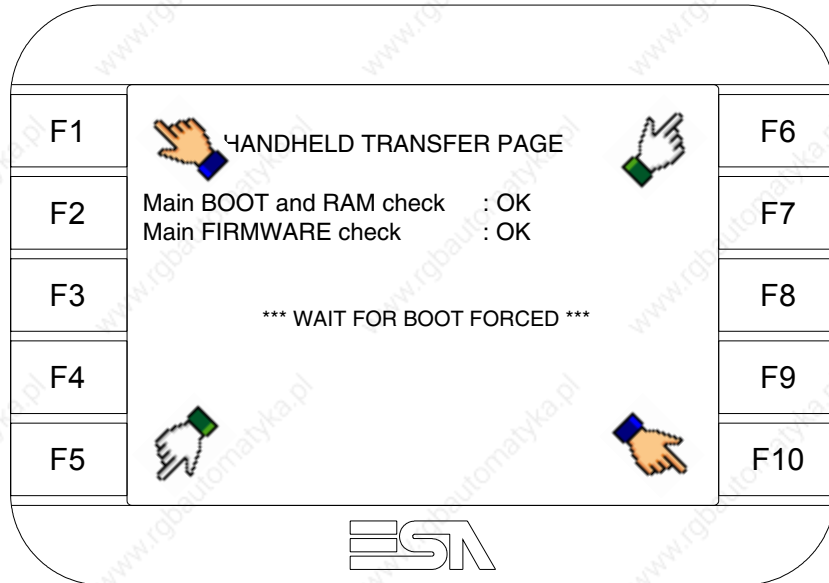

and wait a moment, or, using the appropriate button (see Page 18-21), till the VT displays the following mask

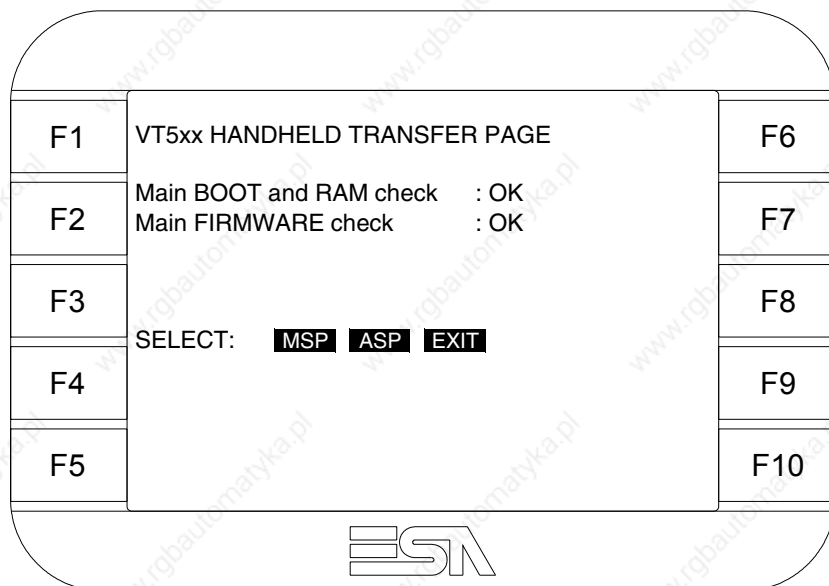

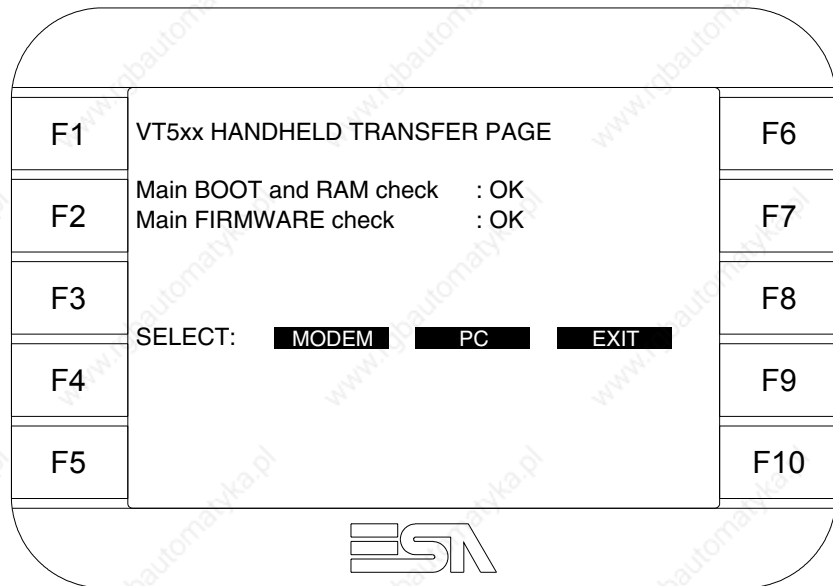

- Choose the port you intend to use for the transfer (MSP or ASP); touch the relevant on the display. The VT is now ready to receive (refer to Software Manual for transfer procedure).

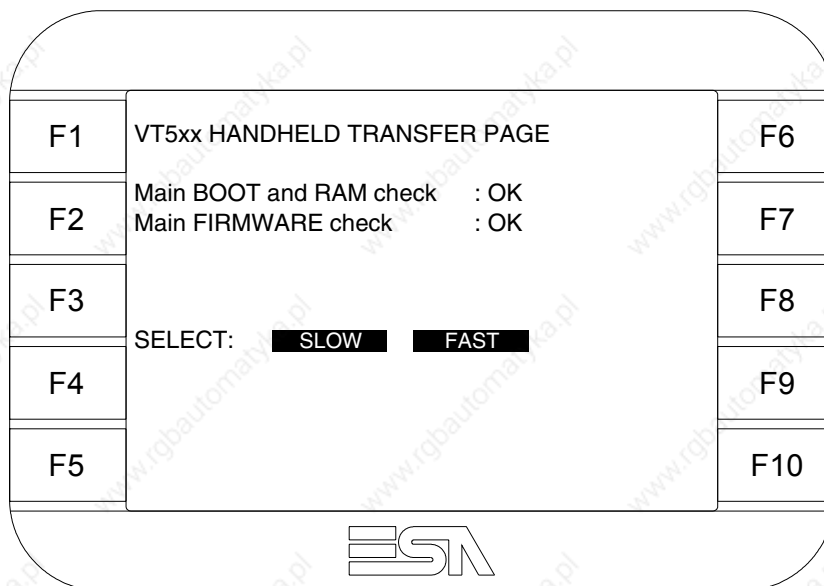

- Choose the required transfer mode: MODEM if you intend to use a modem or PC if you intend to use a serial port; touch the relevant on the display

If the choose made is PC, the VT is ready to receive (see Software Manual for transfer), if, on the other hand, you choose MODEM, the following mask will appear



The choice should be according to the speed you intend to use for the transfer (Slow=9600bit/sec or Fast=38400bit/sec), touch the relevant  on the display. The VT is now ready to receive (see Software Manual for the transfer).

Information relating to driver

After the project has been transferred, the VT can make available information relating to what has been loaded. The information regards:

- Serial ports present
- The name of the driver loaded
- The version of the driver loaded
- Network address of the VT
- Last error to have occurred

To acquire this information carry out the following operations:

- Be situated in any page of the project
- Press two diagonally opposed angles that are free of any settable objects or buttons (at least one angle must be free)

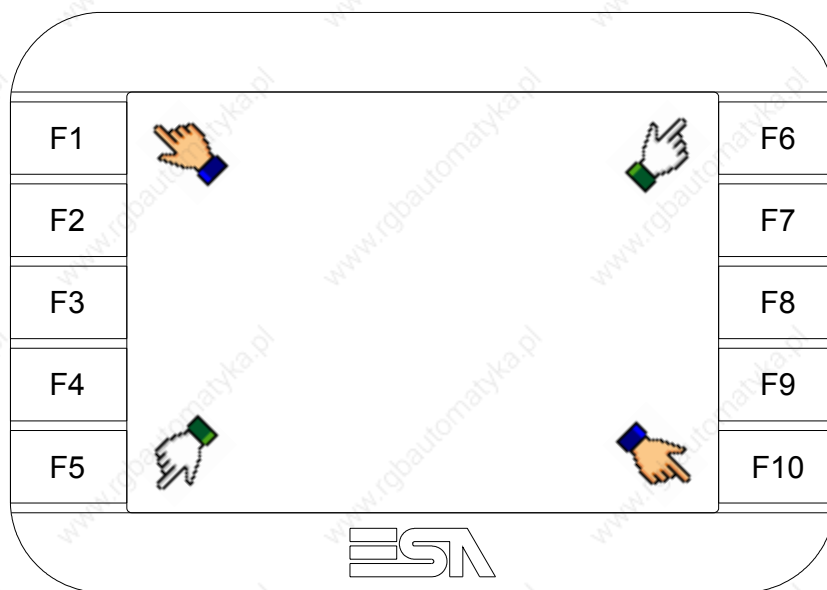

and you will see

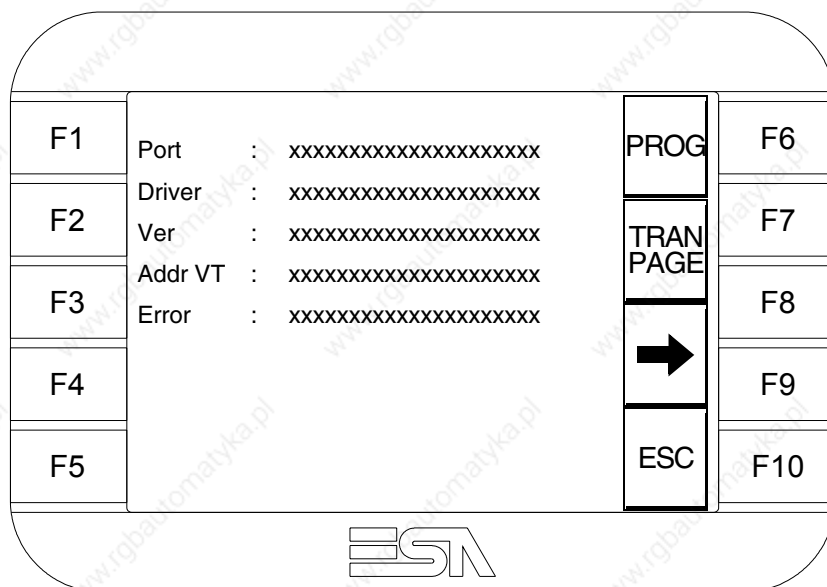

There is one of these pages for each communication port; movement between the various pages is effected by pressing .

From this page you can:

- Set the clock and the contrast
- Prepare the VT to receive the program

Setting the clock and the contrast:

To set the clock and the contrast, while displaying the above illustrated page, press **PROG**; the following mask appears

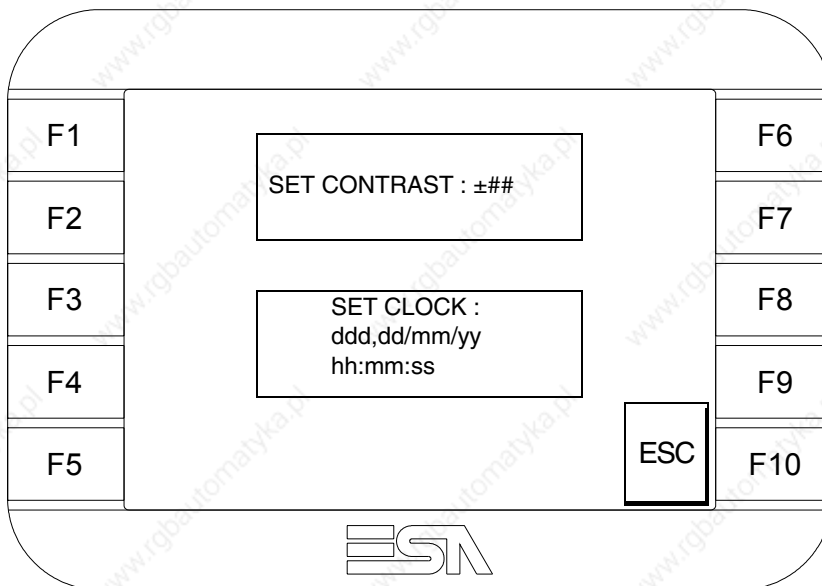

To set the contrast touch the words SET CONTRAST on the display; you will see the following mask

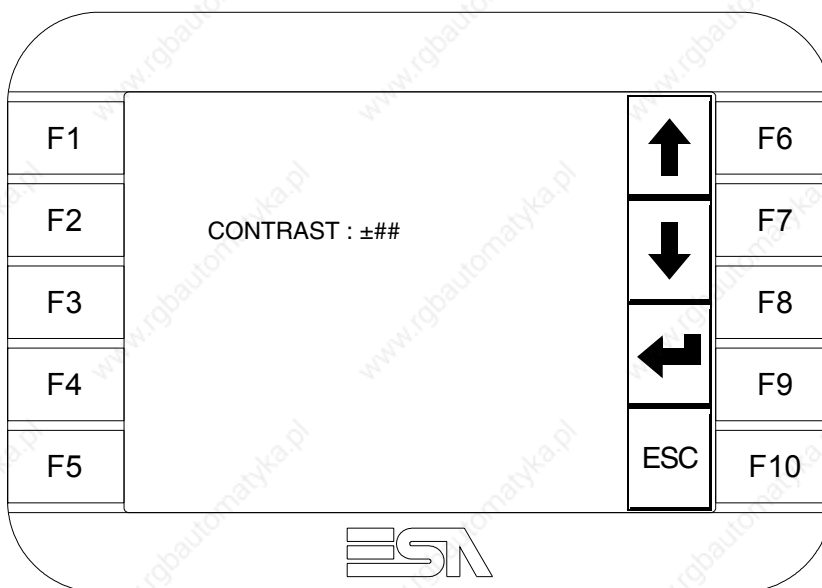

Use the arrow  for any variation (see "Chapter 36 -> Operation of

terminal with touch screen“).

To set the clock touch the words SET CLOCK on the display; the following mask appears

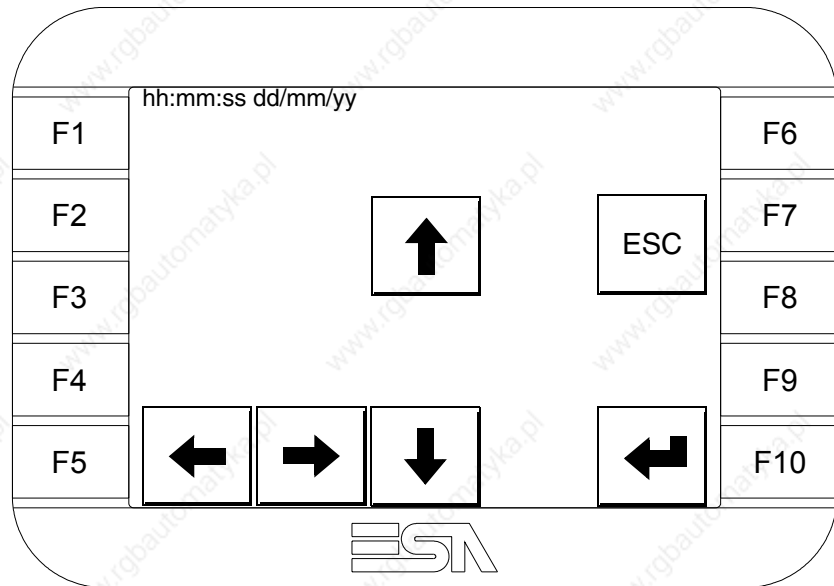

Use the arrow  for any variation (see “Chapter 36 -> Operation of terminal with touch screen“).

Prepare the VT to receive the program:

To prepare the VT to receive the program, while displaying the driver information page (see Page 18-18), press , and you will see the following mask



The on-screen to press depends on the port you intend to use (MSP or ASP). The VT terminal is now ready to receive (consult Software Manual for information on the transmission procedure).

The VT terminal is now ready to receive (consult Software Manual for information on the transmission procedure).

Possible error messages that may be encountered in the driver information page are:

- PR ERR

Problem-> Errors have been detected in the data exchange between the VT and the Device.

Solution-> Check the cable; there may be disturbance.

- COM BROKEN

Problem-> Communication between VT and Device interrupted.

Solution-> Check the serial connection cable.

An error message followed by [*] indicates that the error is not currently present but was and has since disappeared.

Example: COM BROKEN*

When ESC is pressed you quit the display of information regarding the driver.

Improving display color quality

To improve the color quality, adjust the contrast of the display: if the colors are too dark increase the contrast; if, on the other hand, the colors are too light, decrease the contrast.

Adjusting the contrast on the display

To improve the quality of the representation on the display it may be necessary to adjust its contrast. This can be done by going to the page proposed (see Page 18-20) and changing the value (from +31 to -32) in evidence at that moment. Increase the value to darken the display; to lighten it, decrease the value.

We advise this to be done at typical room temperature and with the terminal at operating temperature (about 30 minutes after switching on and with the screen saver disabled - see Software Manual).

Chapter 19 Video terminal VT525W

Contents	Page
Technical characteristics	19-2
Functions	19-4
Front view	19-8
Standard series rear view	19-9
Profibus-DP series rear view	19-10
CAN series rear view	19-11
Ethernet series rear view	19-12
Dimensions and Cut-out	19-13
Accessories	19-14
Calibration of Touch Screen	19-14
Termination of CAN line	19-17
Introducing the MAC address	19-18
Transfer PC -> VT	19-21
Preparation for reception	19-21
Information relating to driver	19-23
Improving display color quality	19-27
Adjusting the contrast on the display	19-27

This chapter consists of 28 pages.

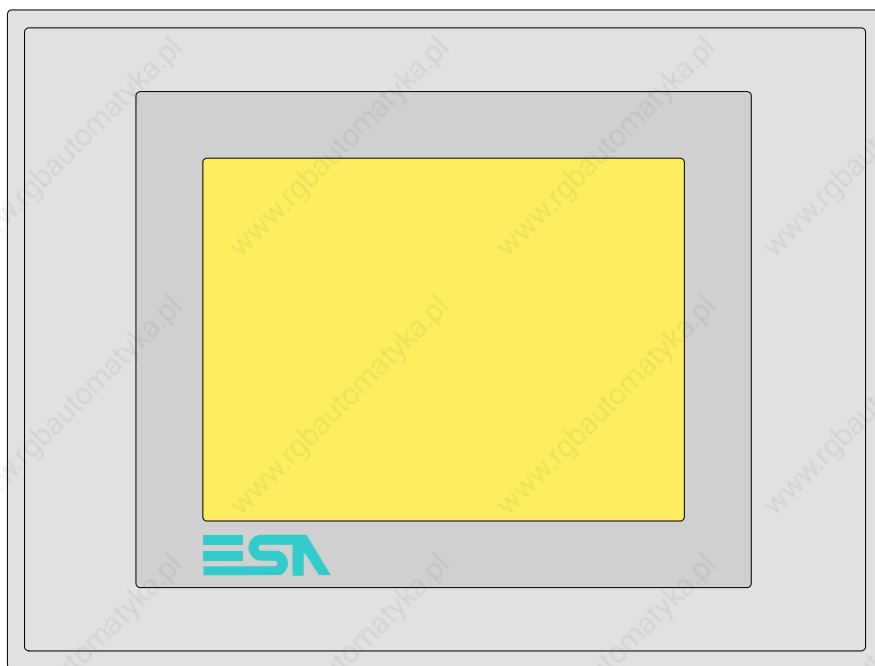

Technical characteristics The following table lists the principal technical characteristics of the product in question.

Code of terminal	Characteristics of the terminal			
VT525W 00000				
VT525W 000DP				
VT525W 000CN				
VT525W 000ET				
Display		▼	▼	▼
Type	LCD 4 tones of blue STN			
	LCD 16 Colors STN	●	●	●
	LCD 16 Colors TFT			
Touch screen	Matrix 20 x 16 (Cell:16x15 pixels)	●	●	●
Representational format	Graphic	●	●	●
Resolution [pixels]	320 x 240 (5,7")	●	●	●
Rows x characters	16 x 40 / 8 x 20 / 4 x 10	●	●	●
Display area size [mm]	115,2 x 86,4	●	●	●
Character matrix in text mode [pixels]	8 x15 / 16 x 30 / 32 x 60	●	●	●
Character size [mm] x 1 / x 2 / x 4	2,9 x 5,4 / 5,8 x 10,8 / 11,6 x 21,6	●	●	●
Contrast adjustment	Software	●	●	●
	Automatic compensation with temperature	●	●	●
Character sets	Programmable fonts/TTF Windows ®	●	●	●
Backlighting				
Type	LED			
	CCFL lamp	●	●	●
Minimum lamp-life at 25°C [hours]	15000	●	●	●

Code of terminal	Characteristics of the terminal			
VT525W 0000				
VT525W 000DP				
VT525W 000CN				
VT525W 000ET				
User memory				
Project [Bytes]	960K	●	●	●
Data memory [Bytes]	32K (Flash EPROM)	●	●	●
Memory for Windows ® -based fonts [Byte]	256K	●	●	●
Memory Card for backup	--			
Memory Card for expansion	--			
Interfaces				
MSP (Multi-serial port)	RS232/RS422/RS485/TTY-20mA			●
ASP (Auxiliary serial port)	RS232/RS485			
ASP-15L (Auxiliary serial port)	RS232/RS485			
ASP-8 (Auxiliary serial port)	RS232	●	●	●
ASP-9 (Auxiliary serial port)	RS232			
LPT parallel port	Centronics			
Auxiliary port	Connections for accessories			
Accessories				
Connectable accessories	See table "Chapter 33"	●	●	●
Clock				
Clock	Hardware (with Supercapacitor - Min.72h	●	●	●
Networks				
Integrated	Profibus-DP			●
	CAN Open (Optoisolated interface)		●	
	Ethernet 10/100Mbit RJ45	●		
Universal Bus Connector	--			
Optional	See table "Chapter 33"	●	●	●
Proprietary networks				
ESA-Net	Network server			
	Network client			●
Technical data				
Power supply	24Vdc (18..32Vdc)			
Power absorbed at 24Vdc	10W			
Protection fuse	Ø5x20mm - 800mA Quick Blow F			
Protection level	IP65 (front-end)			
Operating temperature	0..50°C			
Storage and transportation temperature	-20..+60°C			
Humidity (non-condensing)	<85%			
Weight	1400gr			
Dimensions				
External W x H x D [mm]	210 x 158 x 54			
Cut-out W x H [mm]	198 x 148			
Certification				
Certifications and approvals	CE, cULus, NEMA12			

Functions

The following table lists in alphabetical order all the functions of the VT in question.

Table 19.1: Functions and objects realizable with this VT (Part 1 of 4)

Code of terminal		
VT525W *****		
Objects/Functions	Quantity	▼
Alarm field		●
Alarm help	256	●
Alarm history buffer	256	●
Alarm statistics		
Alarms (Total/active simultaneously)	256/256	●
Arc		●
Automatic operations	32	●
Backup/Restore		●
Bar data		●
Bit-wise password	8bits	●
Buttons	320 x page	●
Circles		●
Command: Change language		●
Command: Clear trend buffer		
Command: Delete recipe		●
Command: Hardcopy		●
Command: Load recipe from data memory		●
Command: Modify password		●
Command: Next page		●
Command: Page help		●
Command: Password login		●
Command: Password logout		●
Command: Previous page		●
Command: Print alarm history		●
Command: Printer form feed		●
Command: Quit project		●
Command: Report		●
Command: Restarts reading time-sampled trend		
Command: Run pipeline		
Command: Save alarms history and trend buffers in flash		●
Command: Save recipe in data memory		●
Command: Save recipe received from device in buffer		●
Command: Save recipe received from device in data memory		●
Command: Send recipe from video buffer to device		●
Command: Send recipe to device		●
Command: Service page		●

Unless otherwise stated, there is no limit to the number of includable elements, only the size of project memory sets a limit.
*) indicative value determined by the dimensions of the project, **) depends on memory available

Table 19.1: Functions and objects realizable with this VT (Part 2 of 4)

Code of terminal		
VT525W *****		
Objects/Functions	Quantity	▼
Command: Show alarms history		●
Command: Show page directory		●
Command: Show project information		●
Command: Show recipe directory		●
Command: Show sequence directory		
Command: Shows driver status page		●
Command: Shows page help		●
Command: Shows page with function: PG		
Command: Stops reading time sampled trend		
Command: Trend reading saved in device		
Command: Zero number of general pages		●
Date field		●
Day-of-the-week field		●
Dynamic texts: Bit-group-structured dynamic texts	1024*	●
Dynamic texts: Single-bit dynamic texts		●
Dynamic texts: Value-structured dynamic texts		●
E-keys		
Equations	32	●
F-keys		
Free terminal		
Function: Disables key		
Function: Go to page		●
Function: Internal command		●
Function: Invert bit value		●
Function: Macro		●
Function: None		
Function: Reset bit permanently		●
Function: Reset real-time bit		●
Function: Sequences		
Function: Sets bit permanently		●
Function: Sets real-time bit		●
Function: Value-structure direct command		●
Global configuration of E-keys		
Global configuration of F-keys		
Headers and footers (Total/Number of fields per H-F)	32/128	●
Info-messages (Total/active simultaneously)	256/256	●
Internal registers	4096bytes	●
Labels		●
LEDs assigned to sequence		

Unless otherwise stated, there is no limit to the number of includable elements, only the size of project memory sets a limit.
 *) indicative value determined by the dimensions of the project, **) depends on memory available

Table 19.1: Functions and objects realizable with this VT (Part 3 of 4)

Code of terminal		
VT525W *****		
Objects/Functions	Quantity	▼
Lines		●
Lists of bitmap images		●
Lists of texts		●
Local configuration of E-keys		
Local configuration of F-keys		
Macro field		
Macros (Total/Commands x macro)	1024/16	●
Message field		●
Message help	256	●
Multilanguage texts	6 Langs.	●
Object - Indicator		
Object - Potentiometer knob		
Object - Selector knob		
Object - Sliding potentiometer		
Object - Sliding selector		
Page	150	●
Page help	150	●
Password	10	●
Pipelines (Number/Tot bytes)		
Print		●
Print page (Total/Number of fields per page)	64/128	●
Programmable fonts		●
Project images		●
Public variables of ESANET network (Number/Total bytes)		
Recipe field for recipe structure		●
Recipes (Number of variables per recipe)	128/256	●
Rectangles		●
Redefinable characters		
Reports	32	●
Sequences - Random		
Sequences - Start/stop		
Static bitmaps		●
Symbolic field: Bit-group-structured dynamic bitmaps	1024*	●
Symbolic field: Single-bit-structured dynamic bitmaps		●
Symbolic field: Value-structured dynamic bitmaps		●
System messages		●
System variables assigned to recipe structure		●
Time long field		●
Time short field		●

Unless otherwise stated, there is no limit to the number of includable elements, only the size of project memory sets a limit.
*) indicative value determined by the dimensions of the project, **) depends on memory available

Table 19.1: Functions and objects realizable with this VT (Part 4 of 4)

Code of terminal		
VT525W ****		
Objects/Functions	Quantity	▼
Timer	32	●
Touch Area	24	●
Trend buffers		
Trends (Trends x page/Channels x trend)		
Trends sampled automatically (Memory/Trends/Readings)		
Trends sampled on command (Memory/Trends/Readings)		
Value direct command: ADD		●
Value direct command: AND		●
Value direct command: OR		●
Value direct command: SET		●
Value direct command: SUBTRACT		●
Value direct command: XOR		●
Variables: Limit values and linear scaling variables	48 x pages	●
Variables: Movement variable (Mobile symbolic field)		●
Variables: Threshold variables		●
Variables: Floating Point numerical variables		●
Variables: Numerical variables (DEC, HEX, BIN, BCD)		●
Variables: String variables (ASCII)		●

Unless otherwise stated, there is no limit to the number of includable elements, only the size of project memory sets a limit.
 *) indicative value determined by the dimensions of the project, **) depends on memory available

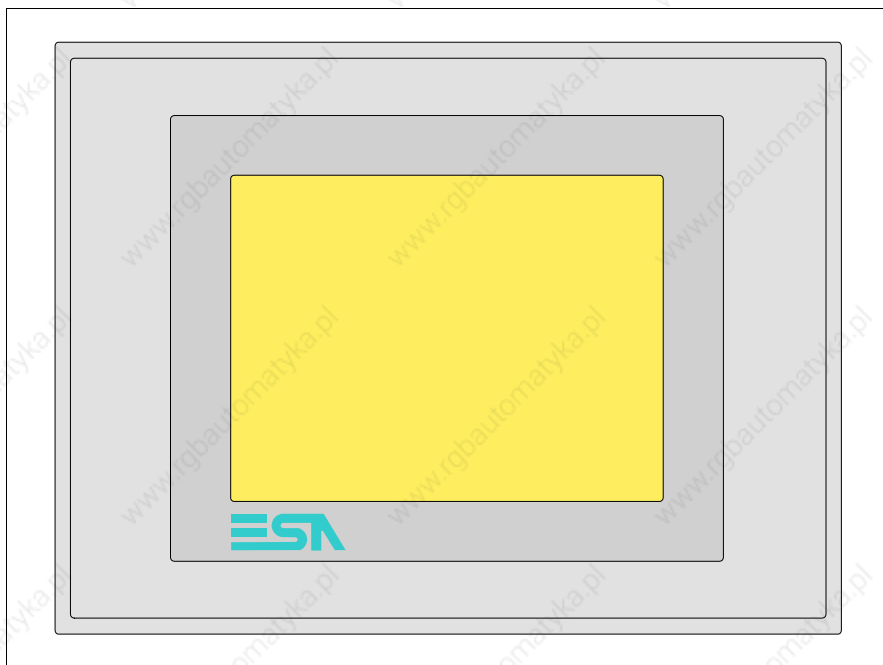
Front view

All buttons and signals are defined using the programming software (see Software Manual).

Standard series rear view

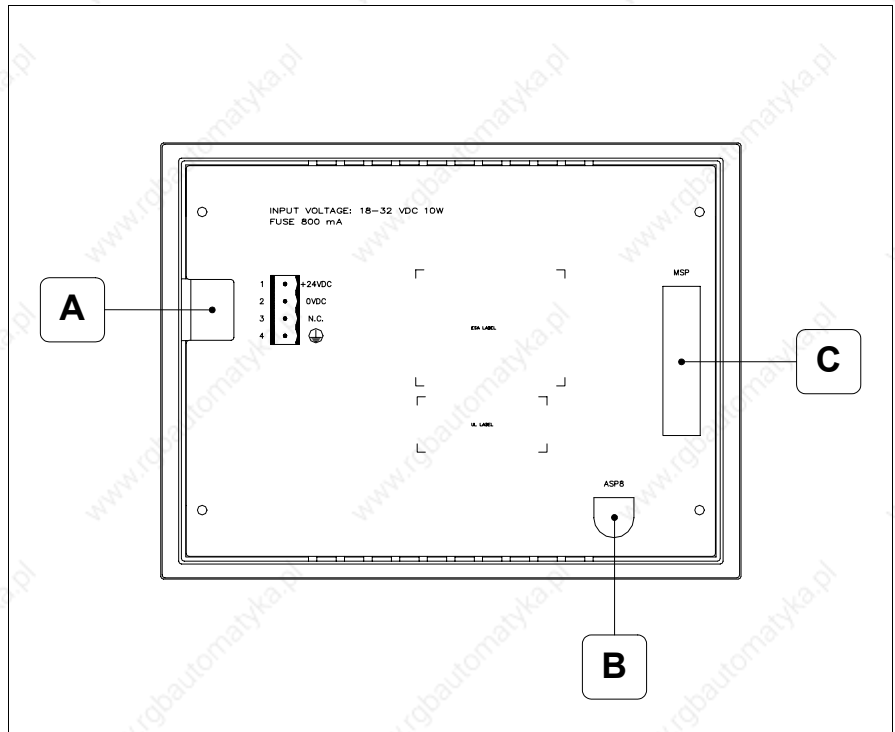

Position	Function
A	Power supply connector
B	ASP serial port for communicating with PC or other devices
C	MSP serial port for communicating with PLC/PC

Profibus-DP series rear view

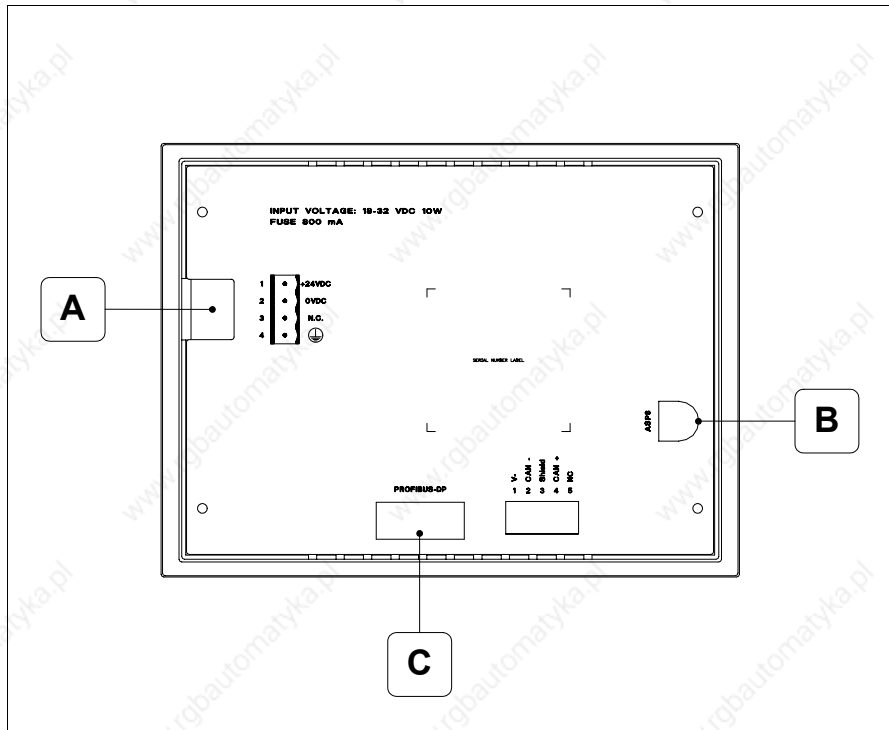

Position	Function
A	Power supply connector
B	ASP serial port for communicating with PC or other devices
C	Serial port for network communication

CAN series rear view

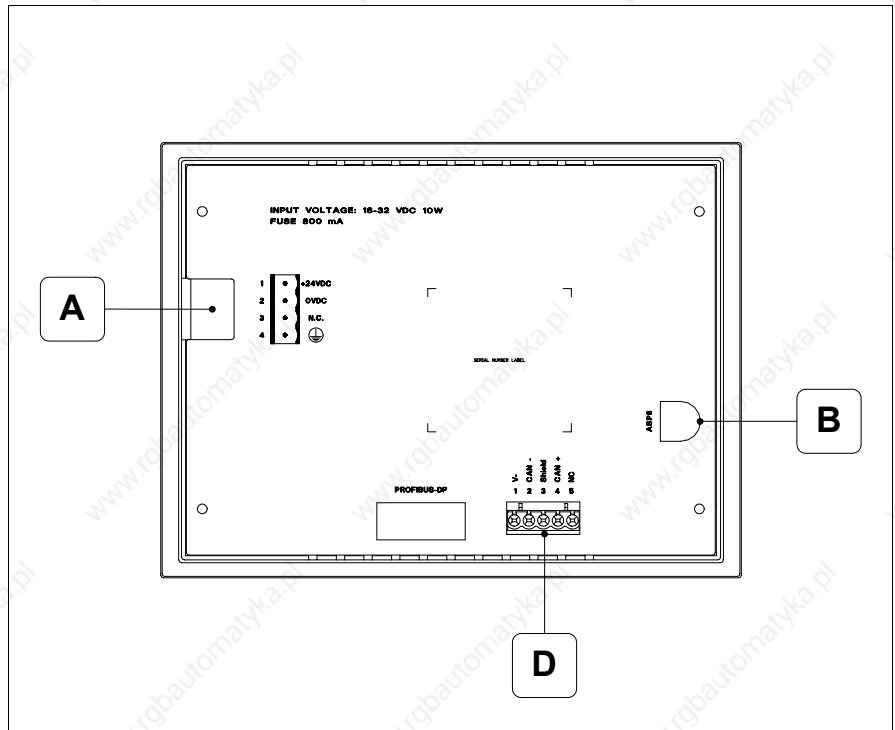

Position	Function
A	Power supply connector
B	ASP serial port for communicating with PC or other devices
D	CAN serial port

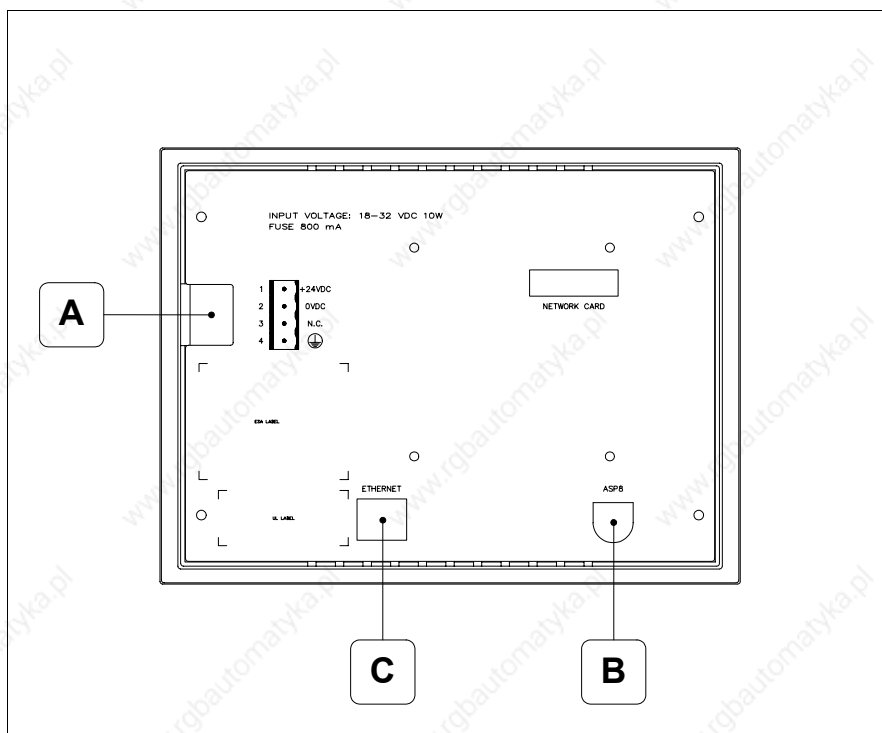
**Ethernet
series rear
view**

Position	Function
A	Power supply connector
B	ASP serial port for communicating with PC or other devices
C	Ethernet network 10/100Mbit RJ45 (For the diagnostic mode of the LEDs see "Chapter 30 -> Ethernet port")

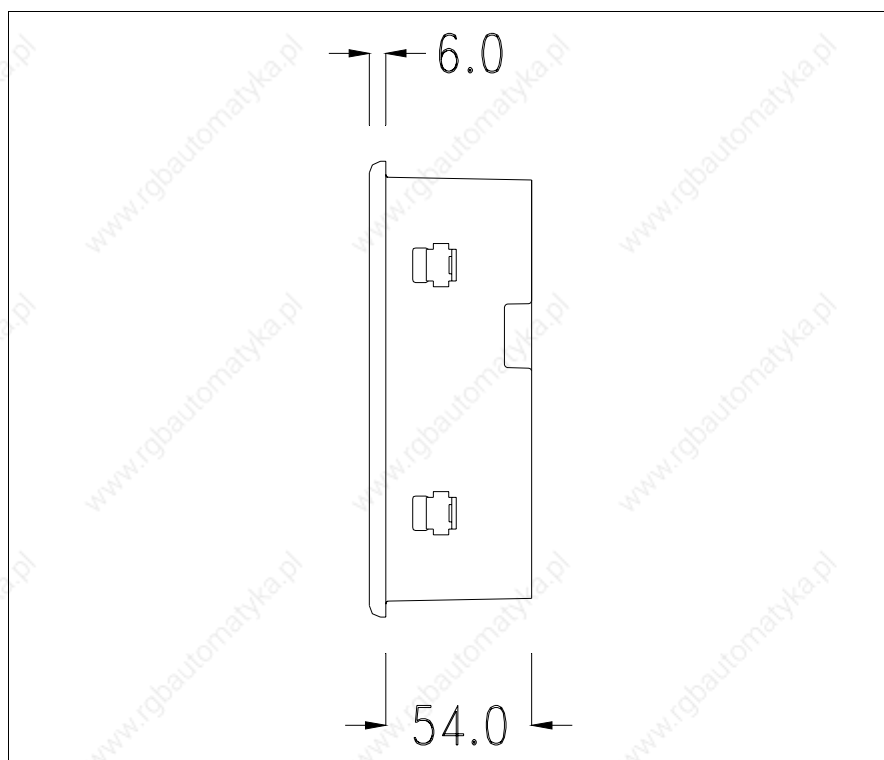
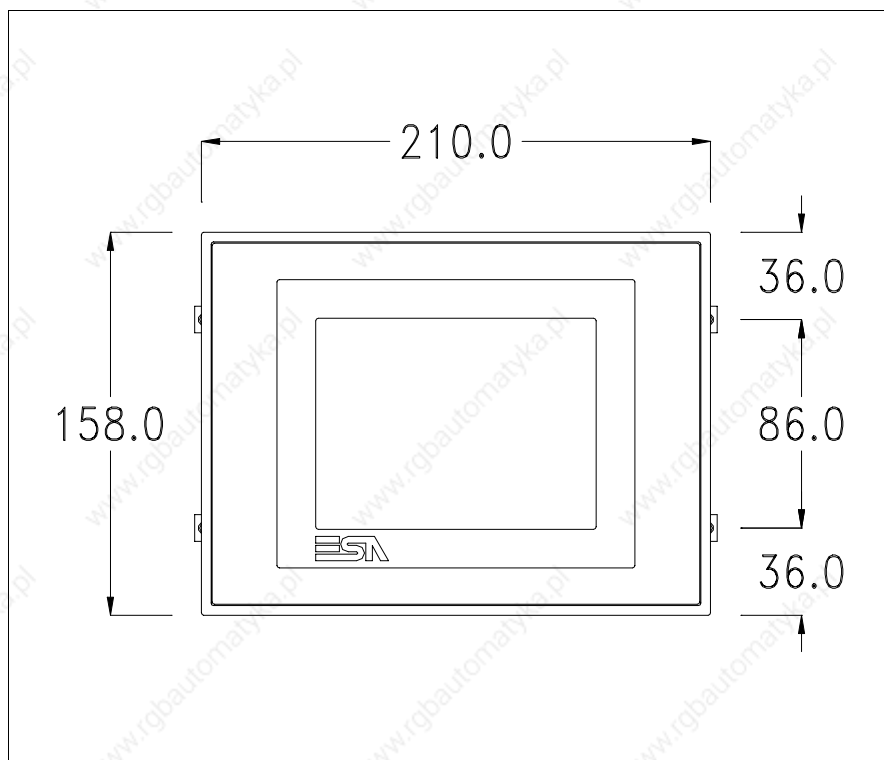
**Dimensions
and Cut-out**

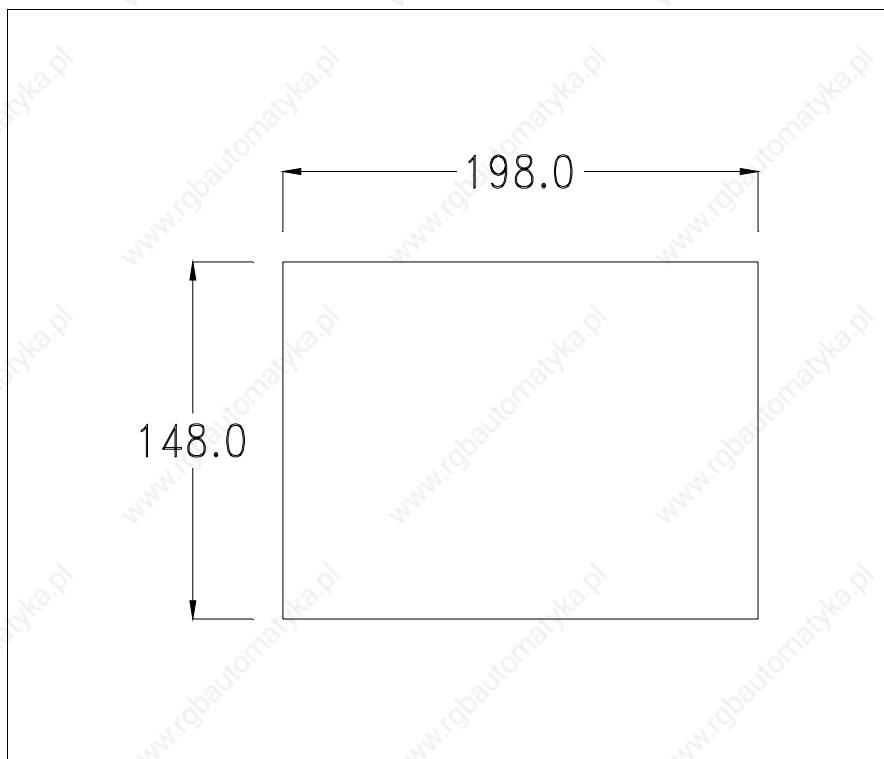

To fix the sealing gasket and secure the VT to the container see “Chapter 29 -> Mounting the terminal within the container“.

⚠ Where accessories need to be fixed in or onto the VT terminal, you are advised to do this before securing the VT to its container.

Accessories

Any accessories should be mounted in accordance with the instructions in the relevant chapter (see “Chapter 33 -> Video terminal accessories“).

Calibration of Touch Screen

The screen of VT525W is made of resistive, sensitive glass; for this type of glass to work properly it requires a calibration procedure (**the terminal is already calibrated when supplied**), that is, the resistive area of the glass has to be adjusted to the visible area of the display.

Should it be thought necessary to repeat the calibration procedure this can be done by following the instructions set out below.

⚠ The procedure must be carried out with great care as the precision of the keys area depends on the calibration.

How to perform the calibration procedure:

- Make sure the VT is not connected to the power supply
- Remove the back cover
- Identify jumper J1

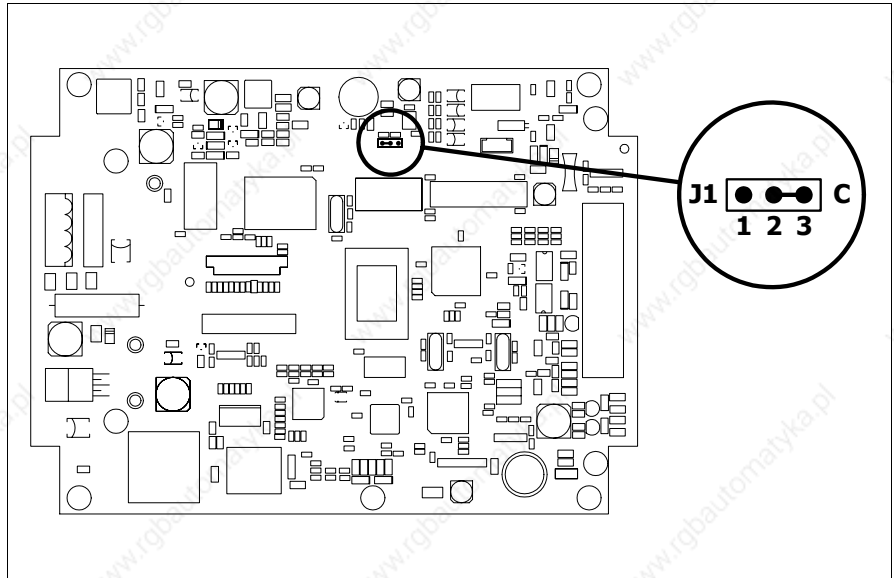

- Position J1 on pins 2-3 (C)
- Reconnect the power supply and switch on the terminal; the following mask appears

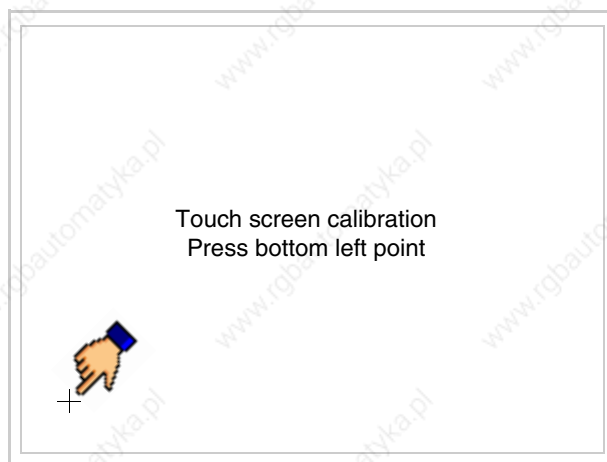

- Touch the corner indicated in the figure; then the following page appears on screen

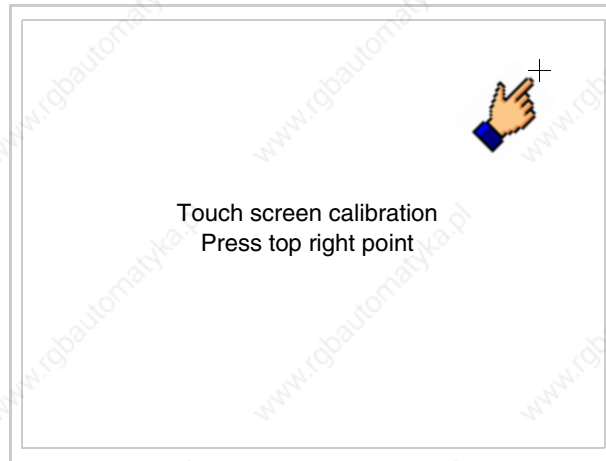

- Touch the corner indicated in the figure to complete the calibration procedure; the following page now appears

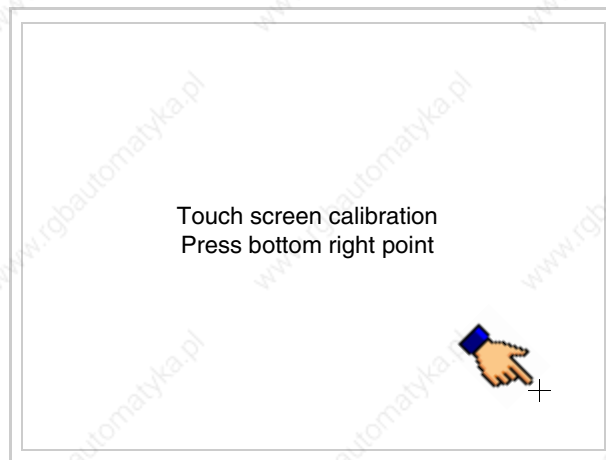

- Wait a few moments until the VT displays either the following mask or the project page (the page may be slightly different in its wording depending on which series the terminal belongs to)

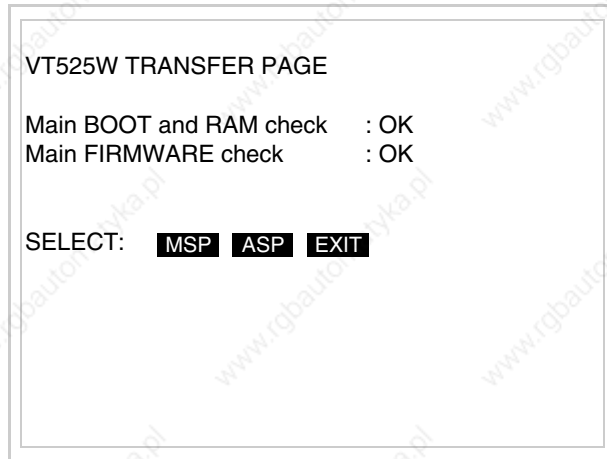

- Switch off the terminal
- Reposition J1 on pins 1-2
- Replace the back cover
- Switch on the terminal again

The calibration procedure has finished; if the calibration has been carried out wrongly or imprecisely, repeat the procedure.

Termination of CAN line

This paragraph applies only to the CAN series. The VT in question integrates the termination resistances of the serial line (typically 120 ohms) which can be inserted by means of a jumper (preset on 1-2, line not terminated). To activate the termination:

- Make sure the device is not connected to the power supply.
- Remove the cover.
- Identify the jumper unit J4.

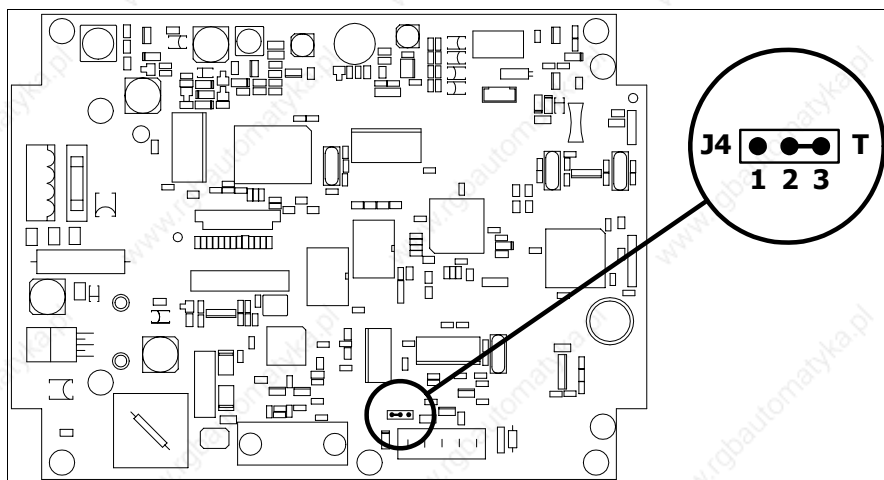

- Position the jumper between pins 2 and 3 (line terminated).
- Replace the back cover.
- Reconnect the power supply.

Introducing the MAC address

This paragraph relates only to the Ethernet series. The Media Access Control (MAC) address unambiguously identifies each terminal connected in the Ethernet network. The terminal is acquired with the address already programmed and is shown on the display of the terminal in the transfer page.

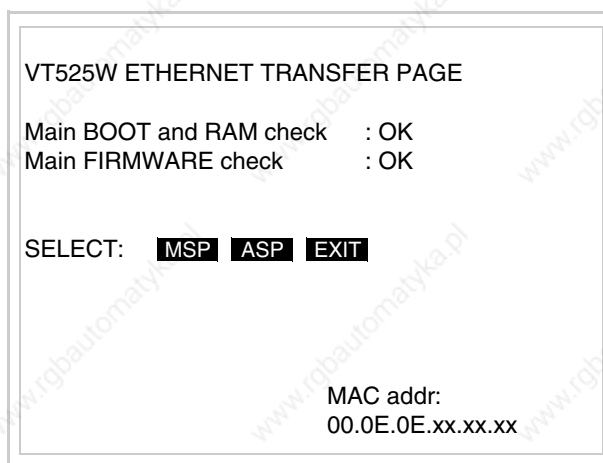

The MAC address is permanently memorized in the terminal, but should it be necessary to execute an “aided” BOOT update (see Software Manual “Chapter 14 -> BOOT update”) the address is lost.

⚠ This operation must be carried out only with the advice of the ESA Customer Care Department.

Terminals with no valid MAC address when switched present a mask for its insertion. If no MAC address belonging to the terminal is available, proceed as follows:

- Check that the VT is not connected to the power supply.
- Remove the back cover
- Locate the label carrying the MAC address

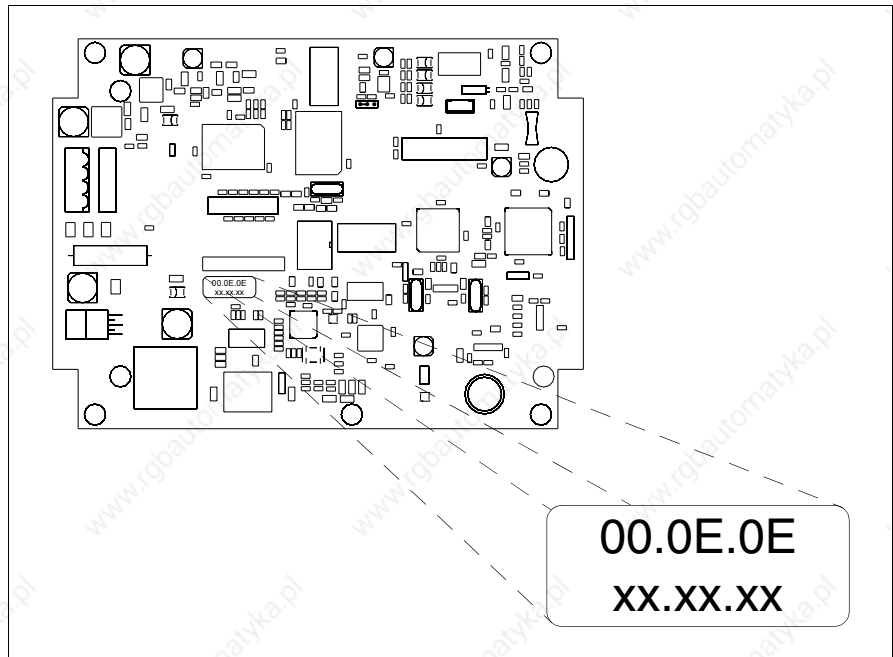

- Make a note of the number on the label (e.g. 00.0E.0E.00.00.01)

00.0E.0E -> fixed part that identifying as an ESA product
XX.XX.XX -> variable part different for each terminal

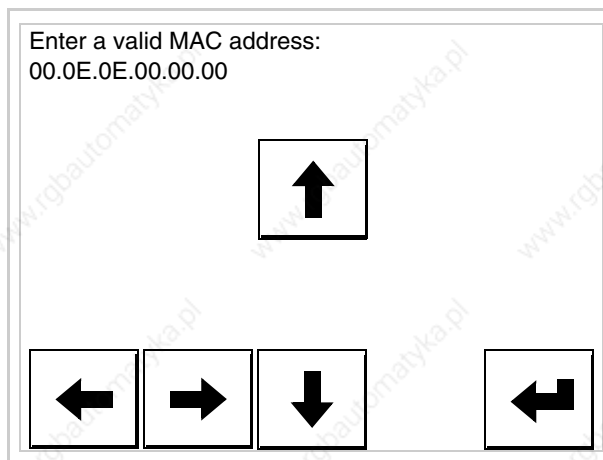

- Reconnect the power supply to the terminal and, if necessary, calibrate the touch screen (see Page 19-14)
- Replace the back cover
- Switch on the terminal again
- The following mask appears; introduce the address previously noted down (e.g. 00.0E.0E.00.00.01)

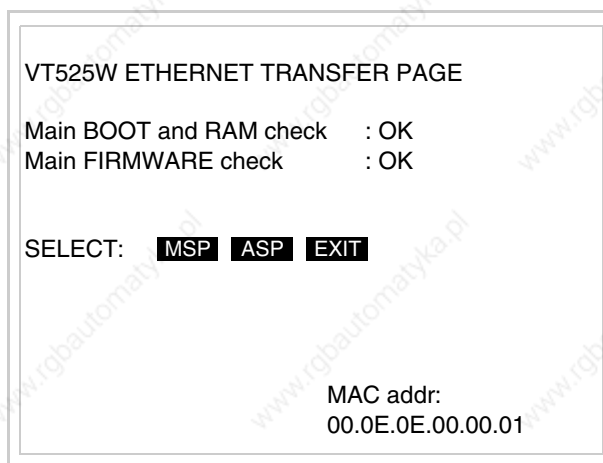

- Use the arrow  to make the setting. Once the address has been confirmed the following page is displayed



The procedure is now terminated.

-  **Should a wrong MAC address have been inserted contact the ESA Customer Care Department.**
-  **A wrong address could give rise to an error of conflict between VT terminals in the Ethernet network.**

Transfer PC -> VT

For everything to function properly, the first time the VT operator terminal is switched on it needs to be correctly loaded, that is it needs to have transferred to it:

- Firmware
- Communication driver
- Project

(Given that the transfer of the three files in practice occurs with a single operation, it will be defined as “Project transfer” for the sake of simplicity.)

For this it is essential that the VT be prepared to receive the transfer. (See also “Chapter 37 -> Command area”).

Preparation for reception

The program VTWIN (see Software Manual) must be used for the transfer, but the terminal must be set up to receive. This means carrying out the following steps:

- Check that the VT is off
- Check that there is a serial connection between the PC and the VT
- Switch on the VT and wait for the following mask to appear
- Press one after the other the diagonally opposite corners free of settable objects or buttons (at least one corner needs to be free)

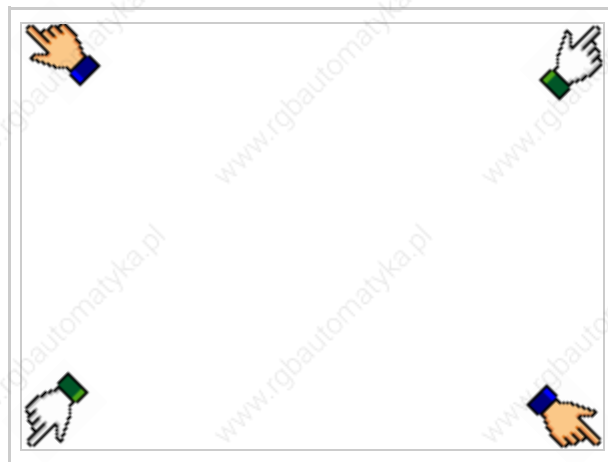

and wait a moment, or, using the appropriate button (see Page 19-25), till the VT displays the following mask

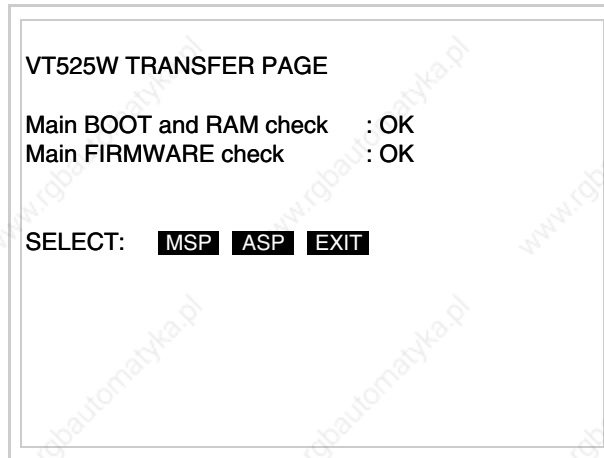

- Choose the port you intend to use for the transfer (MSP or ASP); touch the relevant on the display. The VT is now ready to receive (refer to Software Manual for transfer procedure).

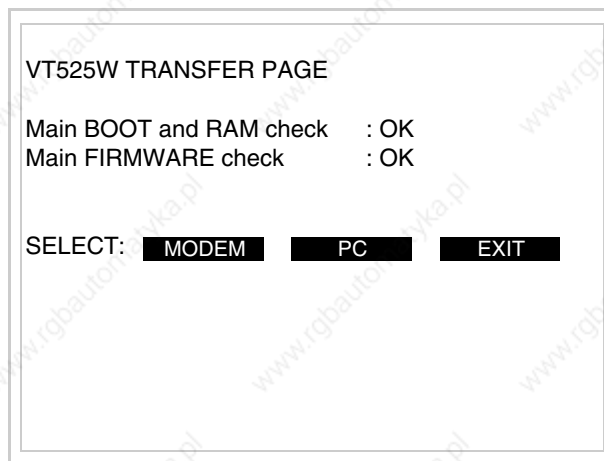

- Choose the required transfer mode: MODEM if you intend to use a modem or PC if you intend to use a serial port; touch the relevant on the display

If the choose made is PC, the VT is ready to receive (see Software Manual for transfer), if, on the other hand, you choose MODEM, the following mask will appear

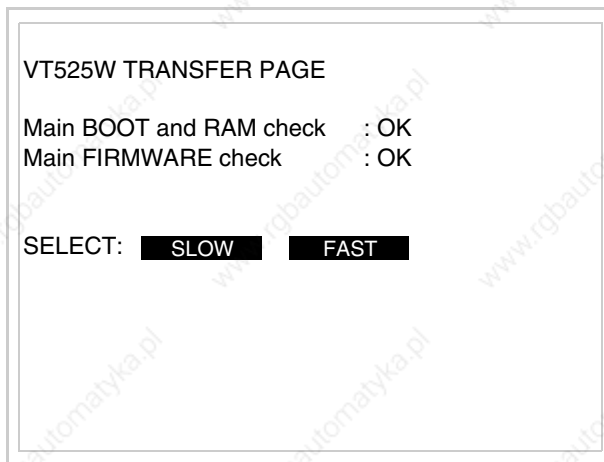

The choice should be according to the speed you intend to use for the transfer (Slow=9600bit/sec or Fast=38400bit/sec), touch the relevant on the display. The VT is now ready to receive (see Software Manual for the transfer).

Information relating to driver

After the project has been transferred, the VT can make available information relating to what has been loaded. The information regards:

- Serial ports present
- The name of the driver loaded
- The version of the driver loaded
- Network address of the VT
- Last error to have occurred

To acquire this information carry out the following operations:

- Be situated in any page of the project
- Press two diagonally opposed angles that are free of any settable objects or buttons (at least one angle must be free)

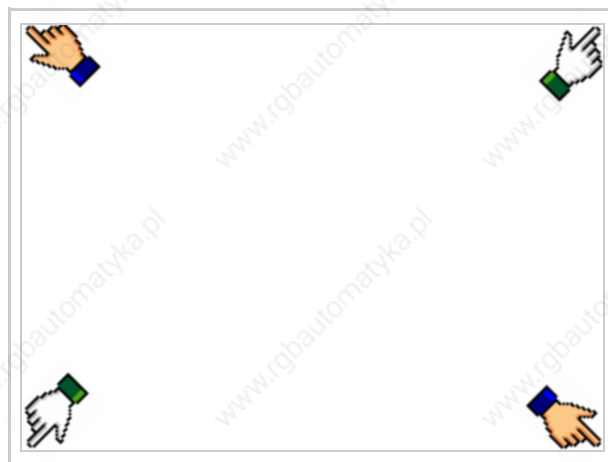

and you will see

Port	: xxxxxxxxxxxxxxxxxxxxxxxx	PROG
Driver	: xxxxxxxxxxxxxxxxxxxxxxxx	TRAN
Ver	: xxxxxxxxxxxxxxxxxxxxxxxx	PAGE
Addr VT	: xxxxxxxxxxxxxxxxxxxxxxxx	→
Error	: xxxxxxxxxxxxxxxxxxxxxxxx	ESC

There is one of these pages for each communication port; movement between the various pages is effected by pressing .

From this page you can:

- Set the clock and the contrast
- Prepare the VT to receive the program

Setting the clock and the contrast:

To set the clock and the contrast, while displaying the above illustrated page, press ; the following mask appears

SET CONTRAST : ±##	
SET CLOCK : ddd,dd/mm/yy hh:mm:ss	
	ESC

To set the contrast touch the words SET CONTRAST on the display; you will see the following mask

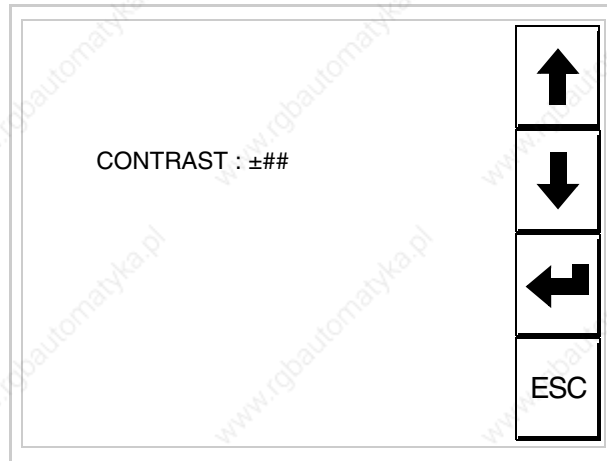

Use the arrow  for any variation (see “Chapter 36 -> Operation of terminal with touch screen”).

To set the clock touch the words SET CLOCK on the display; the following mask appears

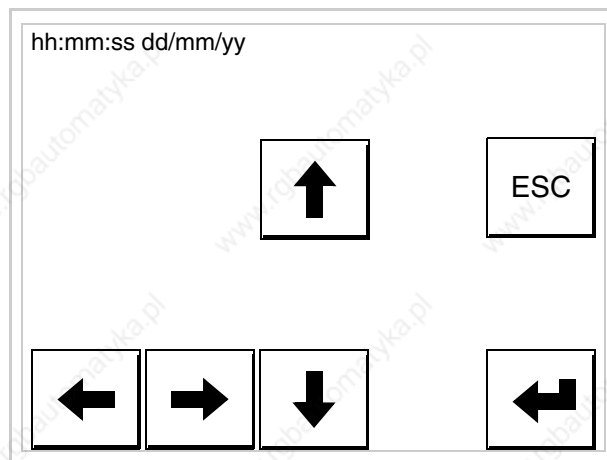

Use the arrow  for any variation (see “Chapter 36 -> Operation of terminal with touch screen”).

Prepare the VT to receive the program:

To prepare the VT to receive the program, while displaying the driver information page (see Page 19-23), press , and you will see the following mask

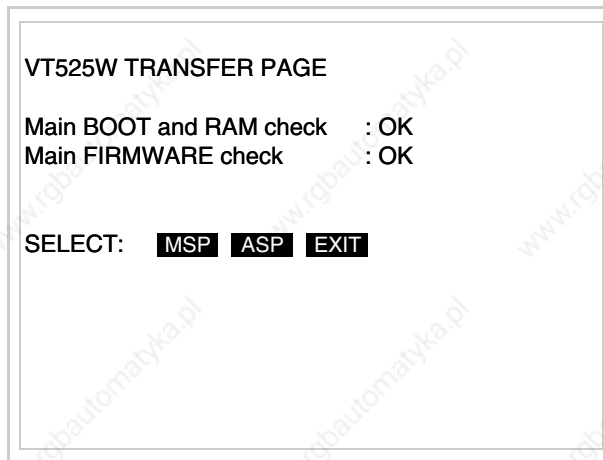

The on-screen to press depends on the port you intend to use (MSP or ASP). The VT terminal is now ready to receive (consult Software Manual for information on the transmission procedure).

The VT terminal is now ready to receive (consult Software Manual for information on the transmission procedure).

Possible error messages that may be encountered in the driver information page are:

- PR ERR

Problem-> Errors have been detected in the data exchange between the VT and the Device.
Solution-> Check the cable; there may be disturbance.

- COM BROKEN

Problem-> Communication between VT and Device interrupted.
Solution-> Check the serial connection cable.

An error message followed by [*] indicates that the error is not currently present but was and has since disappeared.

Example: COM BROKEN*

When ESC is pressed you quit the display of information regarding the driver.

Improving display color quality

To improve the color quality, adjust the contrast of the display: if the colors are too dark increase the contrast; if, on the other hand, the colors are too light, decrease the contrast.

Adjusting the contrast on the display

To improve the quality of the representation on the display it may be necessary to adjust its contrast. This can be done by going to the page proposed (see Page 19-25) and changing the value (from +31 to -32) in evidence at that moment. Increase the value to darken the display; to lighten it, decrease the value.

We advise this to be done at typical room temperature and with the terminal at operating temperature (about 30 minutes after switching on and with the screen saver disabled - see Software Manual).

Chapter 20 Video terminal VT555W

Contents	Page
Technical characteristics	20-2
Functions	20-4
Front view	20-8
Standard series rear view	20-9
CAN series rear view	20-10
Dimensions and Cut-out	20-11
Accessories	20-12
Termination of CAN line	20-12
Transfer PC -> VT	20-13
Preparation for reception	20-13
Information relating to driver	20-16
Adjusting the contrast on the display	20-19

This chapter consists of 20 pages.

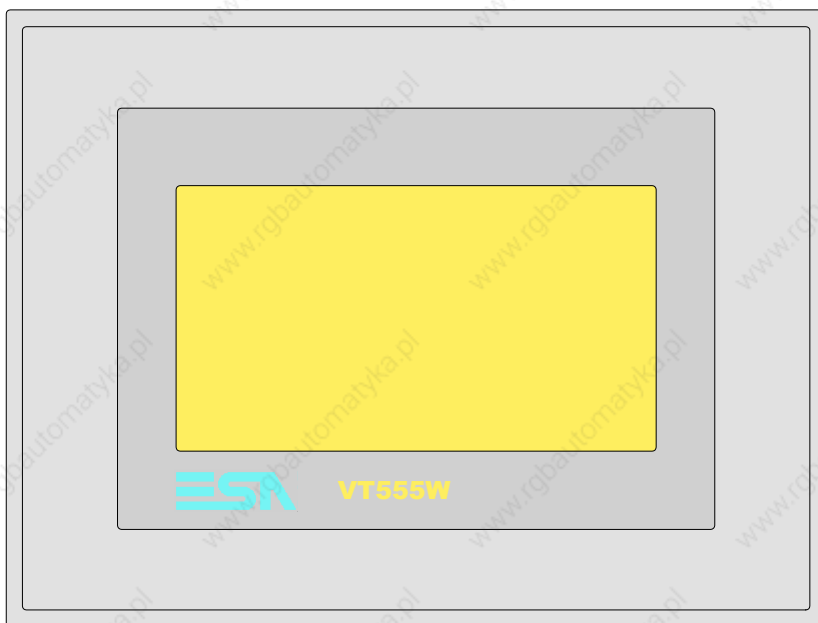

Technical characteristics

The following table lists the principal technical characteristics of the product in question.

Code of terminal		Characteristics of terminal					
VT555W 00000							
VT555W A0000							
VT555W AP000							
VT555W A00DP							
VT555W AP0DP							
VT555W 000CN							
Display			▼	▼	▼	▼	▼
Type	LCD Monochromatic STN	●	●	●	●	●	●
	LCD 16 Colors STN						
	LCD 16 Colors TFT						
Touch screen	Matrix 20 x 8 (Cell: 12x16 pixels)	●	●	●	●	●	●
Representational format	Graphic	●	●	●	●	●	●
Resolution [pixels]	240 x 128	●	●	●	●	●	●
Rows by characters	16 x 40 / 8 x 20 / 4 x 10	●	●	●	●	●	●
Display area size [mm]	123 x 68 (5,5")	●	●	●	●	●	●
Character matrix in text mode [pixels]	6 x 8 / 12 x 16 / 24 x 32	●	●	●	●	●	●
Character size [mm] x 1 / x 2 / x 4	3 x 4 / 6 x 8 / 12 x 16	●	●	●	●	●	●
Contrast adjustment	Software	●	●	●	●	●	●
	Automatic compensation with temperature						
Character sets *	Programmable fonts/TTF Windows ®	●	●	●	●	●	●
Backlighting							
Type	LED						
	CCFL lamp	●	●	●	●	●	●
Minimum lamp-life at 25°C [hours]	15000	●	●	●	●	●	●

* VT555W 00000 only programmable fonts

Code of terminal	Characteristics of terminal					
VT555W 00000						
VT555W A0000						
VT555W AP000						
VT555W A00DP						
VT555W AP0DP						
VT555W 000CN						
User memory						
Project [Bytes]	256K + 384K (Text + Graphics)					●
	192K + 384K (Text + Graphics)	●	●	●	●	●
Data memory [Bytes]	32K (With back-up battery)					●
	128K (With back-up battery)	●	●	●	●	●
Memory for Windows ® -based fonts [Byte]	64K					
Memory Card for backup	--					
Memory Card for expansion	--					
Interfaces						
MSP (Multi-serial port)	RS232/RS422/RS485/TTY-20mA	●	●	●	●	●
ASP (Auxiliary serial port)	RS232/RS485		●	●	●	●
ASP-15L (Auxiliary serial port)	RS232/RS485					
ASP-8 (Auxiliary serial port)	RS232					
ASP-9 (Auxiliary serial port)	RS232					
LPT parallel port	Centronics		●		●	
Auxiliary port	Connections for accessories					
Accessories						
Connectable accessories	See table "Chapter 33"	●	●	●	●	●
Clock						
Clock	Hardware (With back-up battery)	●	●	●	●	●
Networks						
Integrated	Profibus-DP		●	●		
	CAN Open (Optoisolated interface)	●				
	Ethernet 10/100Mbit RJ45					
Universal Bus Connector	--					
Optional	See table "Chapter 33"	●	●	●	●	●
Proprietary networks						
ESA-Net	Network server	●	●	●	●	●
	Network client	●	●	●	●	●
Technical data						
Power supply	24Vdc (18..32Vdc)					
Power absorbed at 24Vdc	15W					
Protection fuse	Ø5x20mm - 800mA Quick Blow F					
Protection level	IP65 (front-end)					
Operating temperature	0..50°C					
Storage and transportation temperature	-20..+60°C					
Humidity (non-condensing)	<85%					
Weight	1400gr					
Dimensions						
External W x H x D [mm]	210 x 158 x 54					
Cut-out W x H [mm]	198 x 148					
Certification						
Certifications and approvals	CE, cULus, NEMA12					

* VT555W 00000 only programmable fonts

Functions

The following table lists in alphabetical order all the functions of the VT in question.

Table 20.1: Functions and objects realizable with this VT (Part 1 of 4)

Code of terminal		
VT555W *****	Objects/Functions	Quantity
Alarm field		●
Alarm help	1024	●
Alarm history buffer	256	●
Alarm statistics		
Alarms (Total/active simultaneously)	1024/256	●
Arc		●
Automatic operations	32	●
Backup/Restore		●
Bar data		●
Bit-wise password	8bits	●
Buttons	160 x page	●
Circles		●
Command: Change language		●
Command: Clear trend buffer		●
Command: Delete recipe		●
Command: Hardcopy		●
Command: Load recipe from data memory		●
Command: Modify password		●
Command: Next page		●
Command: Page help		●
Command: Password login		●
Command: Password logout		●
Command: Previous page		●
Command: Print alarm history		●
Command: Printer form feed		●
Command: Quit project		●
Command: Report		●
Command: Restarts reading time-sampled trend		●
Command: Run pipeline		●
Command: Save alarms history and trend buffers in flash		
Command: Save recipe in data memory		●
Command: Save recipe received from device in buffer		●
Command: Save recipe received from device in data memory		●
Command: Send recipe from video buffer to device		●
Command: Send recipe to device		●
Command: Service page		●

Unless otherwise stated, there is no limit to the number of includable elements, only the size of project memory sets a limit.
*) indicative value determined by the dimensions of the project, **) depends on memory available

Table 20.1: Functions and objects realizable with this VT (Part 2 of 4)

Code of terminal		
VT555W *****		
Objects/Functions	Quantity	▼
Command: Show alarms history		●
Command: Show page directory		●
Command: Show project information		●
Command: Show recipe directory		●
Command: Show sequence directory		
Command: Shows driver status page		●
Command: Shows page help		●
Command: Shows page with function: PG		
Command: Stops reading time sampled trend		●
Command: Trend reading saved in device		●
Command: Zero number of general pages		●
Date field		●
Day-of-the-week field		●
Dynamic texts: Bit-group-structured dynamic texts		●
Dynamic texts: Single-bit dynamic texts	1024*	●
Dynamic texts: Value-structured dynamic texts		●
E-keys		
Equations	32	●
F-keys		
Free terminal		
Function: Disables key		
Function: Go to page		●
Function: Internal command		●
Function: Invert bit value		●
Function: Macro		●
Function: None		
Function: Reset bit permanently		●
Function: Reset real-time bit		●
Function: Sequences		
Function: Sets bit permanently		●
Function: Sets real-time bit		●
Function: Value-structure direct command		●
Global configuration of E-keys		
Global configuration of F-keys		
Headers and footers (Total/Number of fields per H-F)	128/128	●
Info-messages (Total/active simultaneously)	1024/256	●
Internal registers	4096bytes	●
Labels		●
LEDs assigned to sequence		

Unless otherwise stated, there is no limit to the number of includable elements, only the size of project memory sets a limit.
 *) indicative value determined by the dimensions of the project, **) depends on memory available

Table 20.1: Functions and objects realizable with this VT (Part 3 of 4)

Code of terminal		
VT555W *****		
Objects/Functions	Quantity	▼
Lines		●
Lists of bitmap images		●
Lists of texts		●
Local configuration of E-keys		
Local configuration of F-keys		
Macro field	24 x pages	
Macros (Total/Commands x macro)	1024/16	●
Message field		●
Message help	1024	●
Multilanguage texts	8 Langs.	●
Object - Indicator		
Object - Potentiometer knob		
Object - Selector knob		
Object - Sliding potentiometer		
Object - Sliding selector		
Page	1024	●
Page help	1024	●
Password	10	●
Pipelines (Number/Tot bytes)	64/512	●
Print		●
Print page (Total/Number of fields per page)	1024/128	●
Programmable fonts		●
Project images		●
Public variables of ESANET network (Number/Total bytes)	256/1024	●
Recipe field for recipe structure		●
Recipes (Number of variables per recipe)	1024/256	●
Rectangles		●
Redefinable characters		
Reports	128	●
Sequences - Random		
Sequences - Start/stop		
Static bitmaps		●
Symbolic field: Bit-group-structured dynamic bitmaps	1024*	●
Symbolic field: Single-bit-structured dynamic bitmaps		●
Symbolic field: Value-structured dynamic bitmaps		●
System messages		●
System variables assigned to recipe structure		●
Time long field		●
Time short field		●

Unless otherwise stated, there is no limit to the number of includable elements, only the size of project memory sets a limit.
 *) indicative value determined by the dimensions of the project, **) depends on memory available

Table 20.1: Functions and objects realizable with this VT (Part 4 of 4)

Code of terminal		
VT555W ****		
Objects/Functions	Quantity	▼
Timer	32	●
Touch Area	48	●
Trend buffers	128	●
Trends (Trends x page/Channels x trend)	4/4	●
Trends sampled automatically (Memory/Trends/Readings)	512bytes	●
Trends sampled on command (Memory/Trends/Readings)	/**/240	●
Value direct command: ADD		●
Value direct command: AND		●
Value direct command: OR		●
Value direct command: SET		●
Value direct command: SUBTRACT		●
Value direct command: XOR		●
Variables: Limit values and linear scaling variables	96 x pages	●
Variables: Movement variable (Mobile symbolic field)		●
Variables: Threshold variables		●
Variables: Floating Point numerical variables		●
Variables: Numerical variables (DEC, HEX, BIN, BCD)		●
Variables: String variables (ASCII)		●

Unless otherwise stated, there is no limit to the number of includable elements, only the size of project memory sets a limit.
 *) indicative value determined by the dimensions of the project, **) depends on memory available

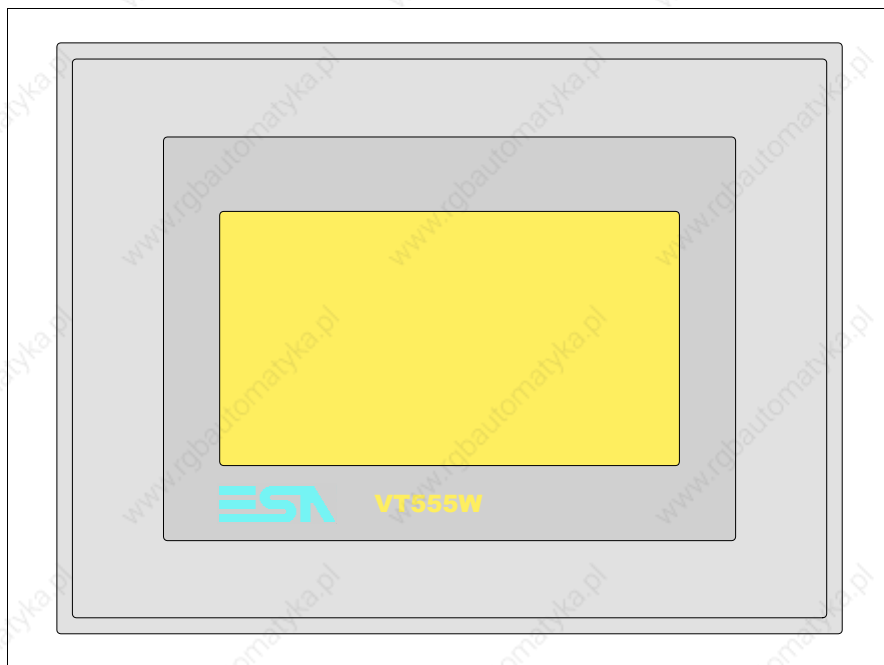
Front view

All buttons and signals are defined using the programming software (see Software Manual).

Standard series rear view

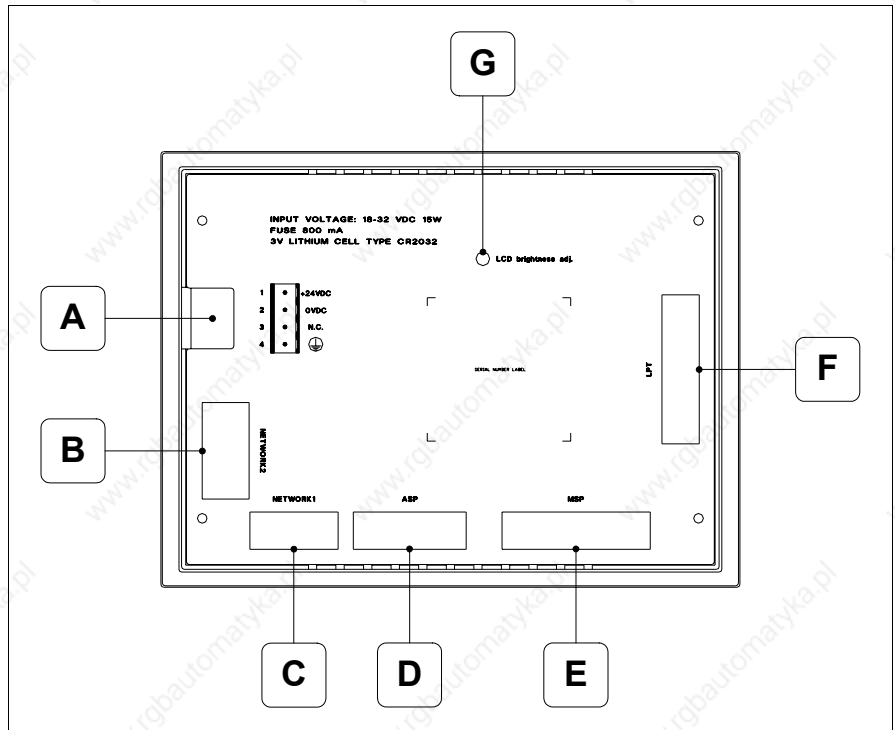

Position	Function
A	Power supply connector
B	NETWORK2 serial port for network communication (Option)
C	NETWORK1 serial port for network communication (Option)
D	ASP serial port for communicating with PC or other devices (Option)
E	MSP serial port for communicating with PLC/PC
F	LPT port for connecting printer (Option)
G	Trimmer for brightness control

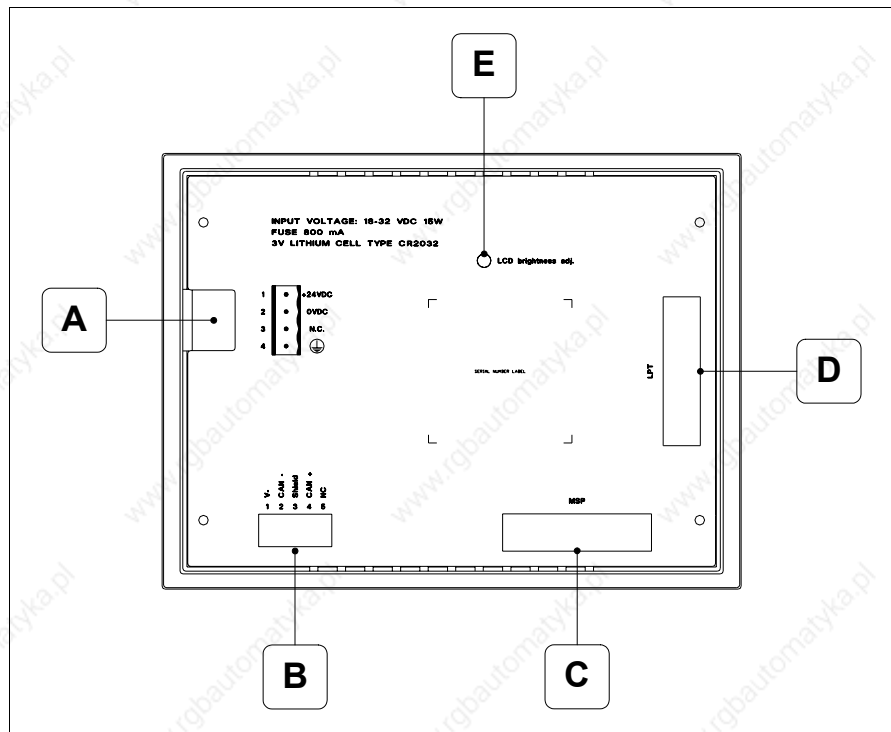
**CAN series
rear view**

Position	Function
A	Power supply connector
B	CAN serial port
C	MSP serial port for communicating with PLC/PC
D	LPT port for connecting printer (Option)
E	Trimmer for brightness control

Dimensions and Cut-out

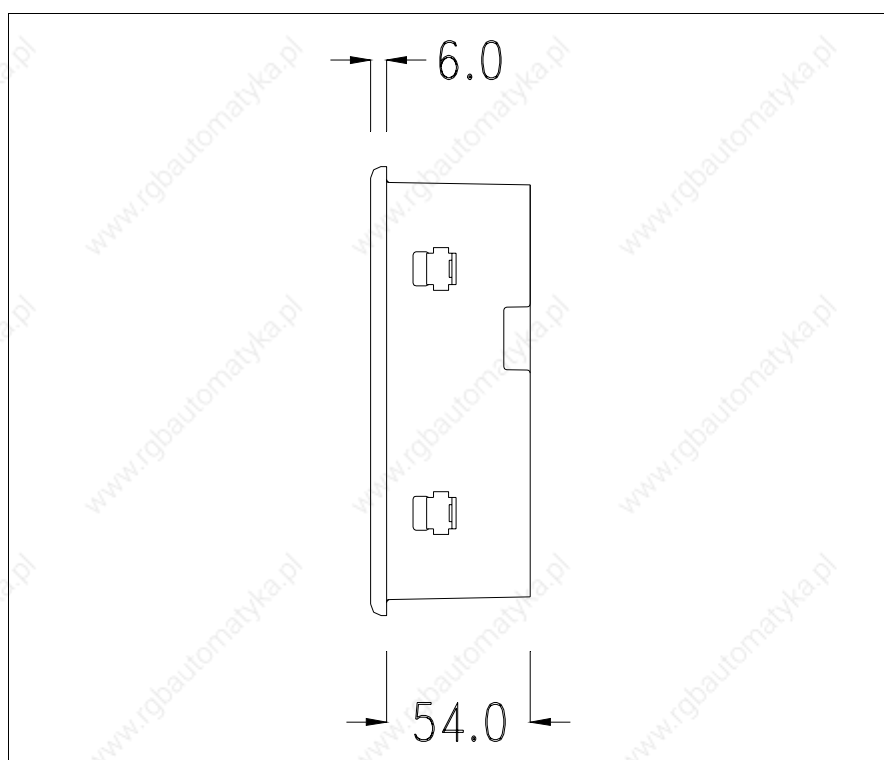
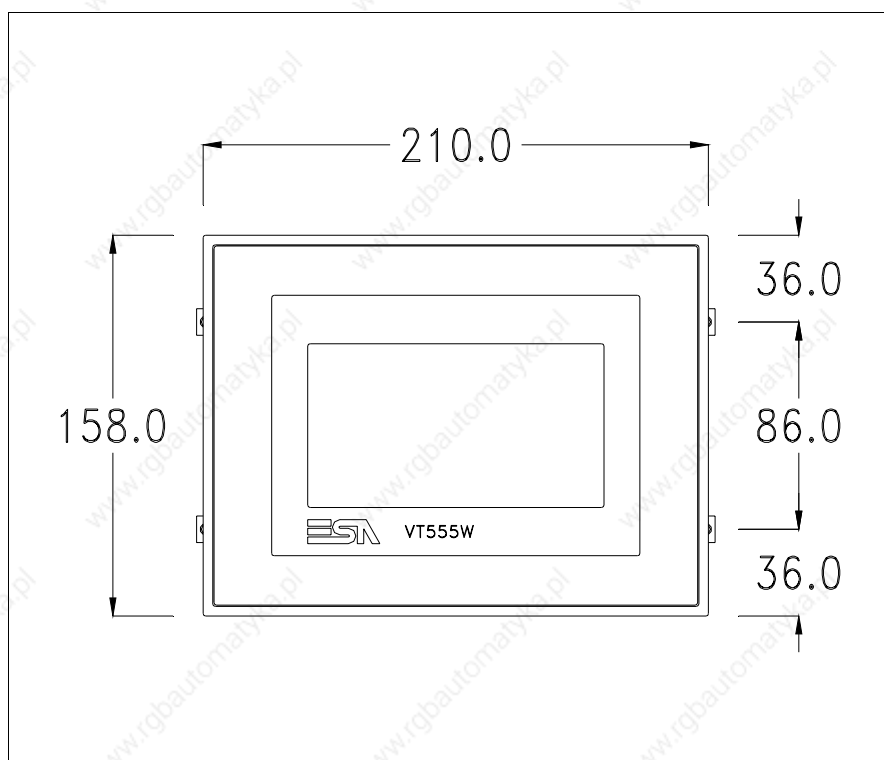

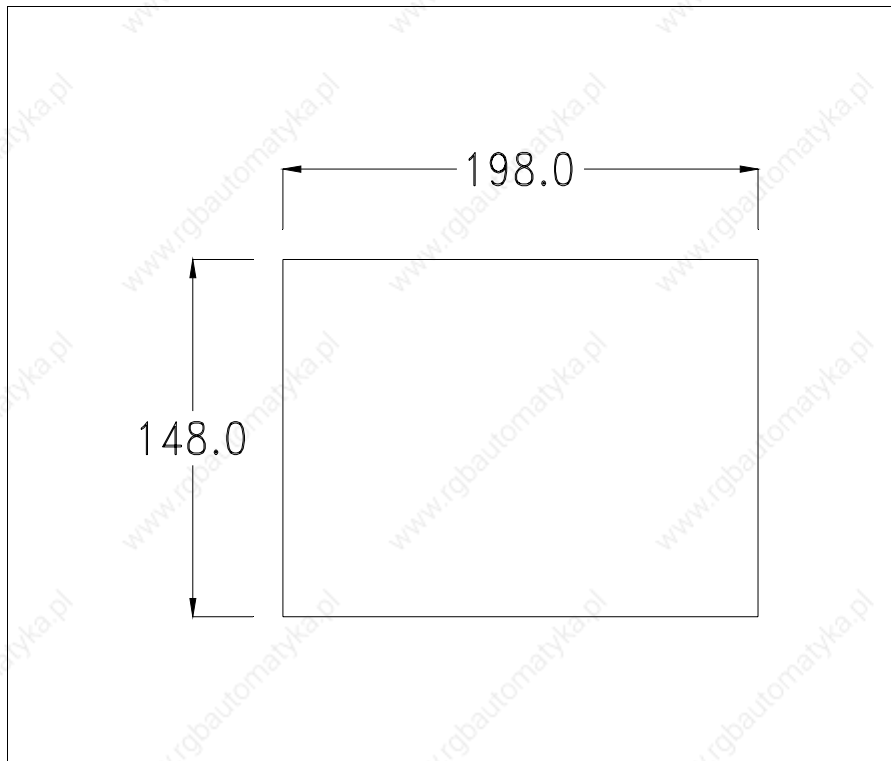

To fix the sealing gasket and secure the VT to the container see “Chapter 29 -> Mounting the terminal within the container“.

⚠ Where accessories need to be fixed in or onto the VT terminal, you are advised to do this before securing the VT to its container.

Accessories

Any accessories should be mounted in accordance with the instructions in the relevant chapter (see “Chapter 33 -> Video terminal accessories“).

Termination of CAN line

This paragraph applies only to the CAN series. The VT in question integrates the termination resistances of the serial line (typically 120 ohms) which can be inserted by means of a jumper (preset on 1-2, line not terminated). To activate the termination:

- Make sure the device is not connected to the power supply.
- Remove the cover.
- Identify the jumper unit J5.

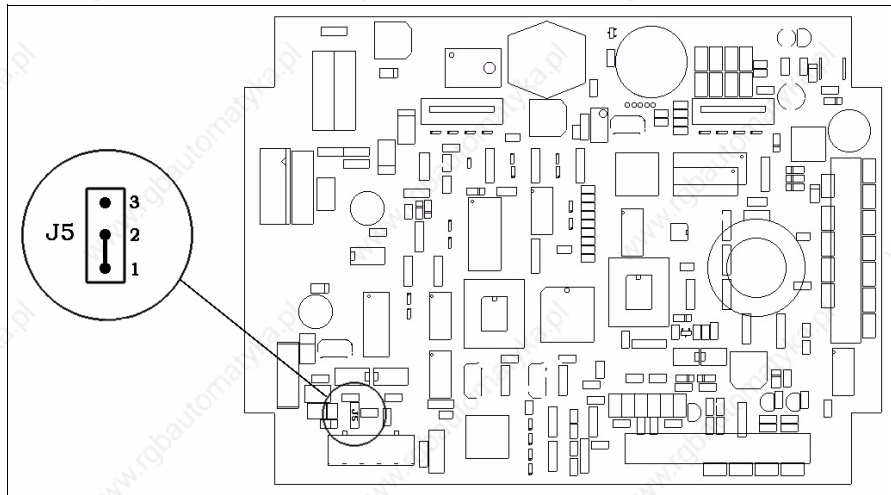

- Position the jumper between pins 2 and 3 (line terminated).
- Replace the back cover.
- Reconnect the power supply.

Transfer PC -> VT

For everything to function properly, the first time the VT operator terminal is switched on it needs to be correctly loaded, that is it needs to have transferred to it:

- Firmware
- Communication driver
- Project

(Given that the transfer of the three files in practice occurs with a single operation, it will be defined as “Project transfer” for the sake of simplicity.)

For this it is essential that the VT be prepared to receive the transfer. (See also “Chapter 37 -> Command area”).

Preparation for reception

The program VTWIN (see Software Manual) must be used for the transfer, but the terminal must be set up to receive. This means carrying out the following steps:

- Check that the VT is off
- Check that there is a serial connection between the PC and the VT
- Switch on the VT by pressing simultaneously on two diagonally opposed angles of the screen



and wait a moment, or, using the appropriate button (see Page 20-18), till the VT displays the following mask

VT terminal with no Modem function:

- Choose the port you intend to use for the transfer (MSP or ASP); touch the relevant  on the display. The VT is now ready to receive (refer to Software Manual for transfer procedure)

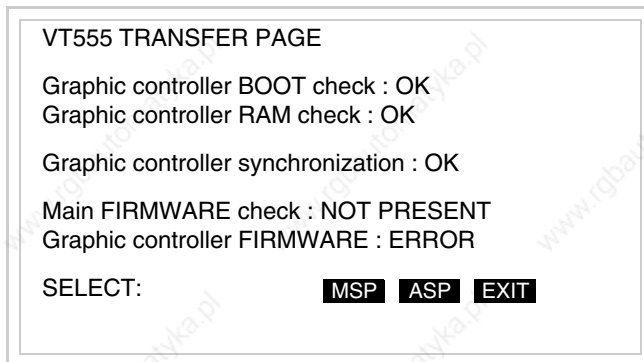

VT terminal with Modem function:

- Proceed from the preceding mask; the following mask appears

VT555 TRANSFER PAGE

Graphic controller BOOT check : OK
Graphic controller RAM check : OK

Graphic controller synchronization : OK

Main FIRMWARE check : NOT PRESENT
Graphic controller FIRMWARE : ERROR

SELECT: **MODEM** **PC** **EXIT**

- Choose the required transfer mode: MODEM if you intend to use a modem or PC if you intend to use a serial port; touch the relevant on the display

If the choose made is PC, the VT is ready to receive (see Software Manual for transfer), if, on the other hand, you choose MODEM, the following mask will appear

VT555 TRANSFER PAGE

Graphic controller BOOT check : OK
Graphic controller RAM check : OK

Graphic controller synchronization : OK

Main FIRMWARE check : NOT PRESENT
Graphic controller FIRMWARE : ERROR

SELECT: **SLOW** **FAST**

The choice should be according to the speed you intend to use for the transfer (Slow=9600bit/sec or Fast=38400bit/sec), touch the relevant on the display. The VT is now ready to receive (see Software Manual for the transfer).

**Information
relating to
driver**

After the project has been transferred, the VT can make available information relating to what has been loaded. The information regards:

- Serial ports present
- The name of the driver loaded
- The version of the driver loaded
- Network address of the VT
- Last error to have occurred

To acquire this information carry out the following operations:

- Be situated in any page of the project
- Press two diagonally opposed angles that are free of any settable objects or buttons (at least one angle must be free)



and there appears the following mask

Port	: xxxxxxxxxxxxxxxxxxxxxxxx	PROG
Driver	: xxxxxxxxxxxxxxxxxxxxxxxx	TRAN PAGE
Ver	: xxxxxxxxxxxxxxxxxxxxxxxx	➔
Addr VT	: xxxxxxxxxxxxxxxxxxxxxxxx	ESC
Error	: xxxxxxxxxxxxxxxxxxxxxxxx	

There is one of these pages for each communication port; movement between the various pages is effected by pressing .

From this page you can:

- Set the clock and the contrast
- Prepare the VT to receive the program

Setting the clock and the contrast:

To set the clock and the contrast, while displaying the above illustrated page, press ; the following mask appears

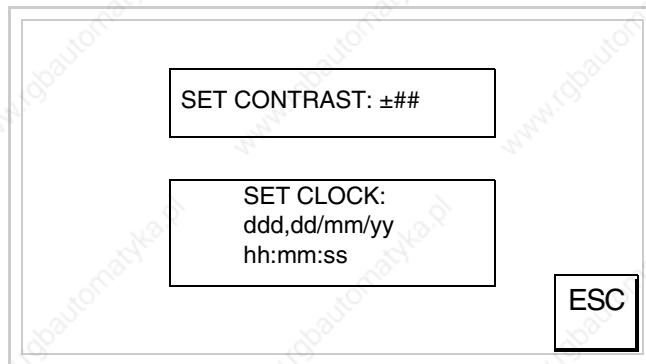

To set the contrast touch the words SET CONTRAST on the display; you will see the following mask



Use the arrow  for any variation (see “Chapter 36 -> Operation of terminal with touch screen”).

To set the clock touch the words SET CLOCK on the display; the following mask appears



For the clock to be used properly, a special battery has to be

inserted in the terminal (see “Chapter 33 -> Video terminal accessories”).

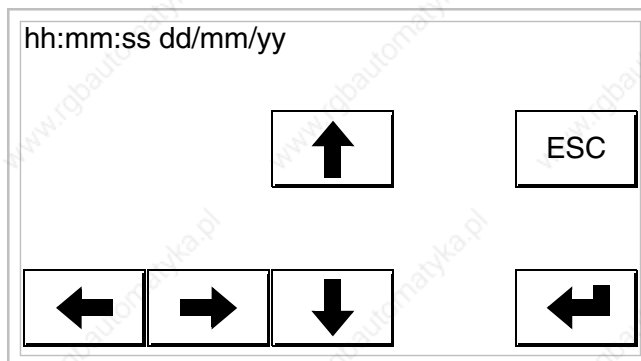

Use the arrow  for any variation (see “Chapter 36 -> Operation of terminal with touch screen”).

Prepare the VT to receive the program:

To prepare the VT to receive the program, while displaying the driver information page (see Page 20-16), press , and you will see the following mask

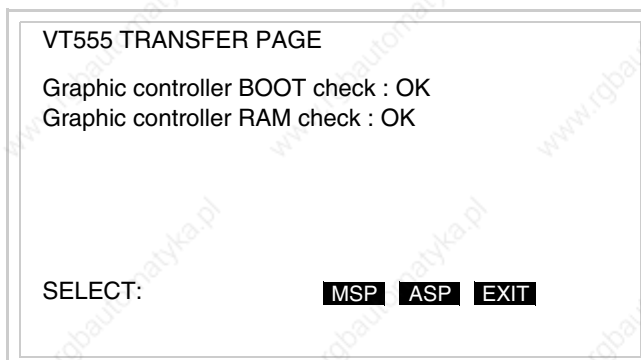

Which on-screen  you touch depends on the port you intend using.

The VT is now ready to receive (refer to Software Manual for information on the transfer procedure). Once you enter this mask, you can quit without transferring only by switching off and switching on the VT again or by pressing the EXIT .

Possible error messages that may be encountered in the driver information page are:

- PR ERR

Problem-> Errors have been detected in the data exchange between the VT and the Device.

Solution-> Check the cable; there may be disturbance.

- COM BROKEN

Problem-> Communication between VT and Device interrupted.

Solution-> Check the serial connection cable.

An error message followed by [*] indicates that the error is not currently present but was and has since disappeared.

Example: COM BROKEN*

When  is pressed you quit the display of information regarding the driver.

Adjusting the contrast on the display

To improve the quality of the representation on the display it may be necessary to adjust its contrast. This can be done by going to the page proposed (see Page 20-17) and changing the value (from +31 to -32) in evidence at that moment. Increase the value to darken the display; to lighten it, decrease the value.

Chapter 21 Video terminal VT560W

Contents	Page
Technical characteristics	21-2
Functions	21-4
Front view	21-8
Rear view	21-9
Dimensions and Cut-out	21-10
Accessories	21-11
Transfer PC -> VT	21-11
Preparation for reception	21-12
Information relating to driver	21-13
Improving display color quality	21-18
Adjusting the contrast on the display	21-18

This chapter consists of 18 pages.

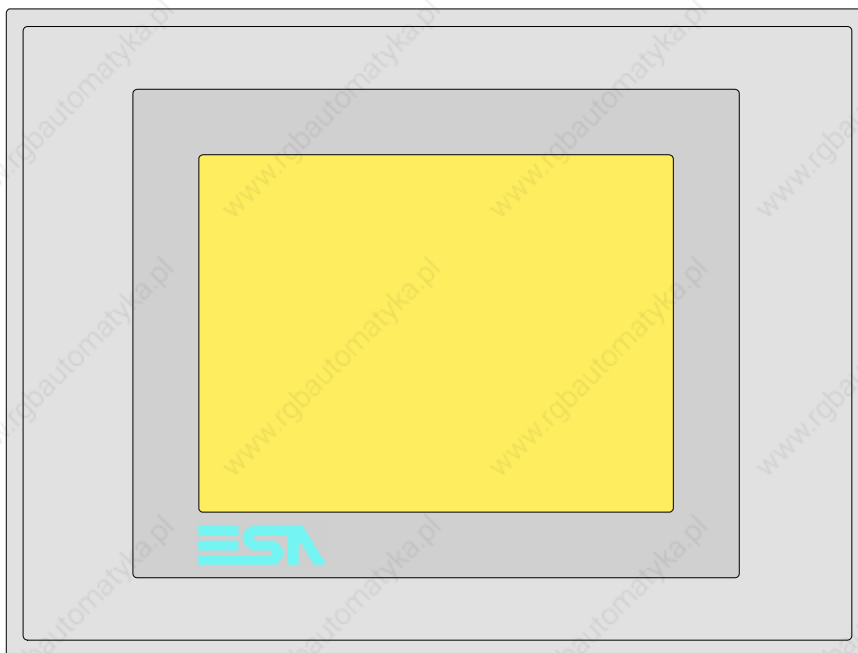

Technical characteristics

The following table lists the principal technical characteristics of the product in question.

Code of terminal	Characteristics of the terminal	
VT560W A0000		
VT560W A0M00		
Display		▼ ▼
Type	LCD 8 tones of blue STN	●
	LCD 16 Colors STN	●
	LCD 16 Colors TFT	
Touch screen	Matrix 20 x 16 (Cell:16x15 pixels)	● ●
Representational format	Graphic	● ●
Resolution [pixels]	320 x 240 (5,7")	● ●
Rows x characters	16 x 40 / 8 x 20 / 4 x 10	● ●
Display area size [mm]	115,6 x 87	● ●
Character matrix in text mode [pixels]	8 x15 / 16 x 30 / 32 x 60	● ●
Character size [mm] x 1 / x 2 / x 4	2,8 x 5,2 / 5,6 x 10,4 / 11,2 x 20,8	● ●
Contrast adjustment	Software	● ●
	Automatic compensation with temperature	● ●
Character sets	Programmable fonts/TTF Windows ®	● ●
Backlighting		
Type	LED	
	CCFL lamp	● ●
Minimum lamp-life at 25°C [hours]	15000	● ●

Code of terminal	Characteristics of the terminal	
VT560W A000		
VT560W A0M00		
User memory		
Project [Bytes]	192K + 832K (Text + Graphics)	● ●
Data memory [Bytes]	128K (With back-up battery)	● ●
Memory for Windows ® -based fonts [Byte]	128K	● ●
Memory Card for backup	4Mb	● ●
Memory Card for expansion	--	
Interfaces		
MSP (Multi-serial port)	RS232/RS422/RS485/TTY-20mA	● ●
ASP (Auxiliary serial port)	RS232/RS485	● ●
ASP-15L (Auxiliary serial port)	RS232/RS485	
ASP-8 (Auxiliary serial port)	RS232	
ASP-9 (Auxiliary serial port)	RS232	
LPT parallel port	Centronics	
Auxiliary port	Connections for accessories	
Accessories		
Connectable accessories	See table "Chapter 33"	● ●
Clock		
Clock	Hardware (With back-up battery)	● ●
Networks		
Integrated	Profibus-DP	
	CAN Open (Optoisolated interface)	
	Ethernet 10/100Mbit RJ45	
Universal Bus Connector	--	
Optional	See table "Chapter 33"	● ●
Proprietary networks		
ESA-Net	Network server	● ●
	Network client	● ●
Technical data		
Power supply	24Vdc (18..32Vdc)	
Power absorbed at 24Vdc	15W	
Protection fuse	Ø5x20mm - 800mA Quick Blow F	
Protection level	IP65 (front-end)	
Operating temperature	0..50°C	
Storage and transportation temperature	-20..+60°C	
Humidity (non-condensing)	<85%	
Weight	1400gr	
Dimensions		
External W x H x D [mm]	210 x 158 x 54	
Cut-out W x H [mm]	198 x 148	
Certification		
Certifications and approvals	CE, cULus, NEMA12	

Functions

The following table lists in alphabetical order all the functions of the VT in question.

Table 21.1: Functions and objects realizable with this VT (Part 1 of 4)

Code of terminal		
VT560W *****		
Objects/Functions	Quantity	▼
Alarm field		●
Alarm help	1024	●
Alarm history buffer	256	●
Alarm statistics		
Alarms (Total/active simultaneously)	1024/256	●
Arc		●
Automatic operations	32	●
Backup/Restore		●
Bar data		●
Bit-wise password	8bits	●
Buttons	320 x page	●
Circles		●
Command: Change language		●
Command: Clear trend buffer		●
Command: Delete recipe		●
Command: Hardcopy		●
Command: Load recipe from data memory		●
Command: Modify password		●
Command: Next page		●
Command: Page help		●
Command: Password login		●
Command: Password logout		●
Command: Previous page		●
Command: Print alarm history		●
Command: Printer form feed		●
Command: Quit project		●
Command: Report		●
Command: Restarts reading time-sampled trend		●
Command: Run pipeline		●
Command: Save alarms history and trend buffers in flash		
Command: Save recipe in data memory		●
Command: Save recipe received from device in buffer		●
Command: Save recipe received from device in data memory		●
Command: Send recipe from video buffer to device		●
Command: Send recipe to device		●
Command: Service page		●

Unless otherwise stated, there is no limit to the number of includable elements, only the size of project memory sets a limit.
*) indicative value determined by the dimensions of the project, **) depends on memory available

Table 21.1: Functions and objects realizable with this VT (Part 2 of 4)

Code of terminal		
VT560W *****		
Objects/Functions	Quantity	▼
Command: Show alarms history		●
Command: Show page directory		●
Command: Show project information		●
Command: Show recipe directory		●
Command: Show sequence directory		
Command: Shows driver status page		●
Command: Shows page help		●
Command: Shows page with function: PG		
Command: Stops reading time sampled trend		●
Command: Trend reading saved in device		●
Command: Zero number of general pages		●
Date field		●
Day-of-the-week field		●
Dynamic texts: Bit-group-structured dynamic texts	1024*	●
Dynamic texts: Single-bit dynamic texts		●
Dynamic texts: Value-structured dynamic texts		●
E-keys		
Equations	32	●
F-keys		
Free terminal		
Function: Disables key		
Function: Go to page		●
Function: Internal command		●
Function: Invert bit value		●
Function: Macro		●
Function: None		
Function: Reset bit permanently		●
Function: Reset real-time bit		●
Function: Sequences		
Function: Sets bit permanently		●
Function: Sets real-time bit		●
Function: Value-structure direct command		●
Global configuration of E-keys		
Global configuration of F-keys		
Headers and footers (Total/Number of fields per H-F)	128/128	●
Info-messages (Total/active simultaneously)	1024/256	●
Internal registers	4096bytes	●
Labels		●
LEDs assigned to sequence		

Unless otherwise stated, there is no limit to the number of includable elements, only the size of project memory sets a limit.
 *) indicative value determined by the dimensions of the project, **) depends on memory available

Table 21.1: Functions and objects realizable with this VT (Part 3 of 4)

Code of terminal		
VT560W *****		
Objects/Functions	Quantity	▼
Lines		●
Lists of bitmap images		●
Lists of texts		●
Local configuration of E-keys		
Local configuration of F-keys		
Macro field		
Macros (Total/Commands x macro)	1024/16	●
Message field		●
Message help	1024	●
Multilanguage texts	8 Langs.	●
Object - Indicator	64	●
Object - Potentiometer knob	64	●
Object - Selector knob	64	●
Object - Sliding potentiometer	64	●
Object - Sliding selector	64	●
Page	1024	●
Page help	1024	●
Password	10	●
Pipelines (Number/Tot bytes)	64/512	●
Print		●
Print page (Total/Number of fields per page)	1024/128	●
Programmable fonts		●
Project images		●
Public variables of ESANET network (Number/Total bytes)	256/1024	●
Recipe field for recipe structure		●
Recipes (Number of variables per recipe)	1024/512	●
Rectangles		●
Redefinable characters		
Reports	128	●
Sequences - Random		
Sequences - Start/stop		
Static bitmaps		●
Symbolic field: Bit-group-structured dynamic bitmaps	1024*	●
Symbolic field: Single-bit-structured dynamic bitmaps		●
Symbolic field: Value-structured dynamic bitmaps		●
System messages		●
System variables assigned to recipe structure		●
Time long field		●
Time short field		●

Unless otherwise stated, there is no limit to the number of includable elements, only the size of project memory sets a limit.
*) indicative value determined by the dimensions of the project, **) depends on memory available

Table 21.1: Functions and objects realizable with this VT (Part 4 of 4)

Code of terminal		
VT560W ****		
Objects/Functions	Quantity	▼
Timer	32	●
Touch Area	64	●
Trend buffers	128	●
Trends (Trends x page/Channels x trend)	4/4	●
Trends sampled automatically (Memory/Trends/Readings)	4096bytes	●
Trends sampled on command (Memory/Trends/Readings)	/**/320	●
Value direct command: ADD		●
Value direct command: AND		●
Value direct command: OR		●
Value direct command: SET		●
Value direct command: SUBTRACT		●
Value direct command: XOR		●
Variables: Limit values and linear scaling variables	112xpages	●
Variables: Movement variable (Mobile symbolic field)		●
Variables: Threshold variables		●
Variables: Floating Point numerical variables		●
Variables: Numerical variables (DEC, HEX, BIN, BCD)		●
Variables: String variables (ASCII)		●

Unless otherwise stated, there is no limit to the number of includable elements, only the size of project memory sets a limit.
 *) indicative value determined by the dimensions of the project, **) depends on memory available

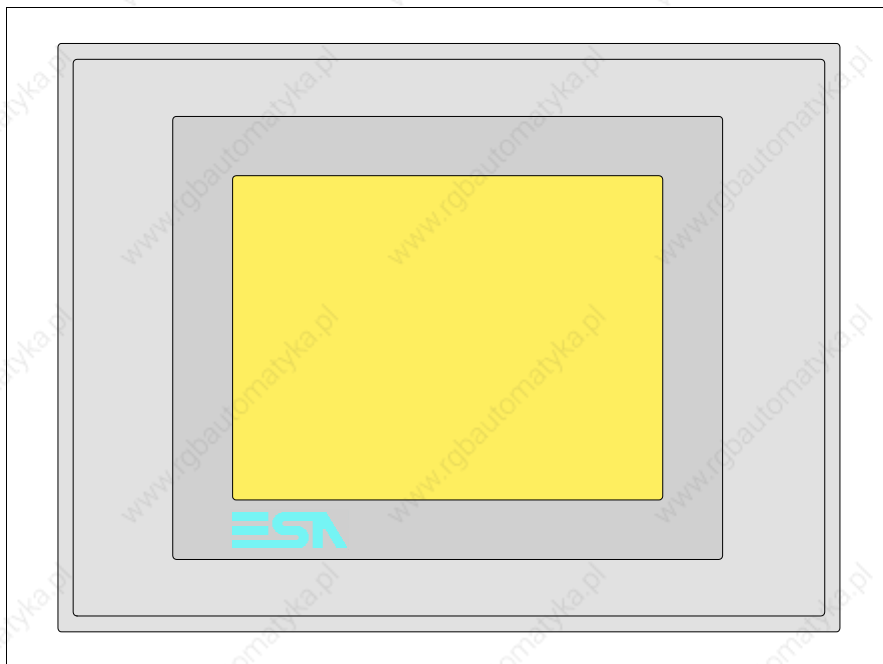
Front view

All buttons and signals are defined using the programming software (see Software Manual).

Rear view

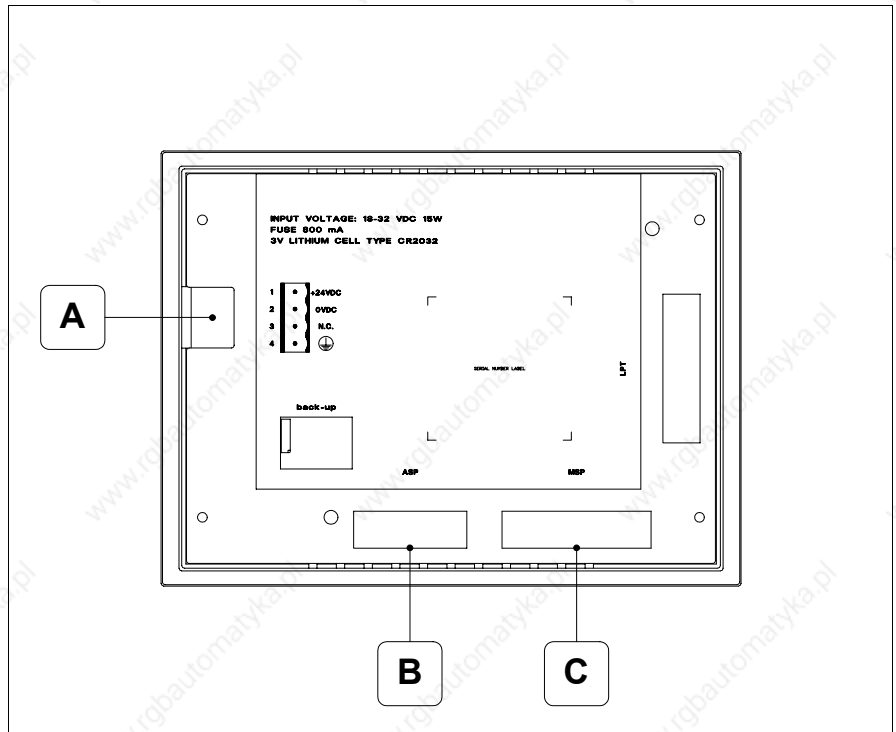

Position	Function
A	Power supply connector
B	ASP serial port for communicating with PC or other devices
C	MSP serial port for communicating with PLC/PC

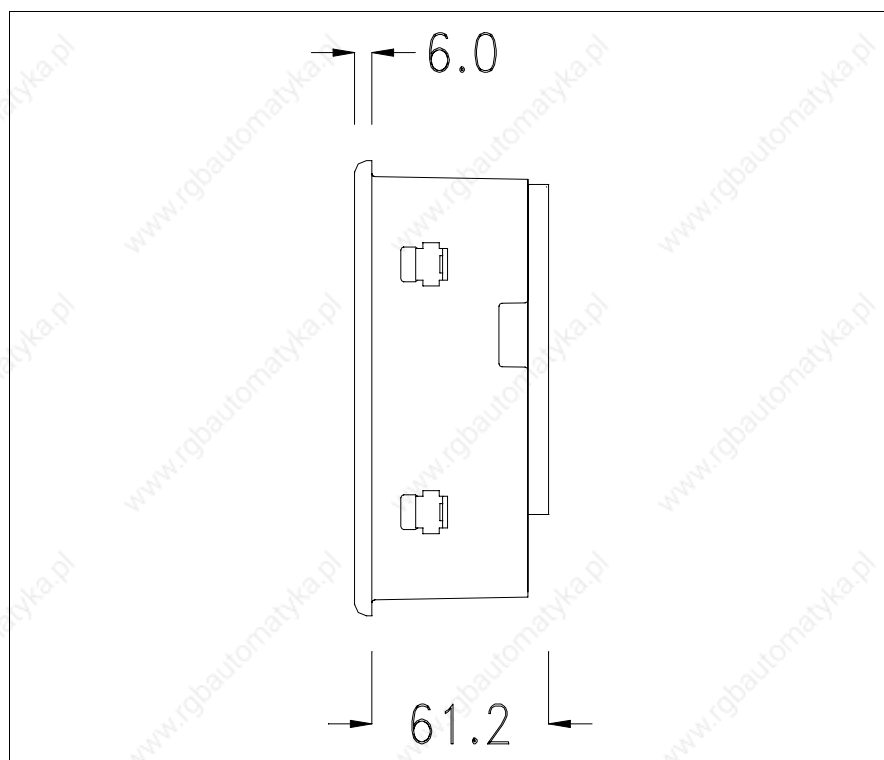
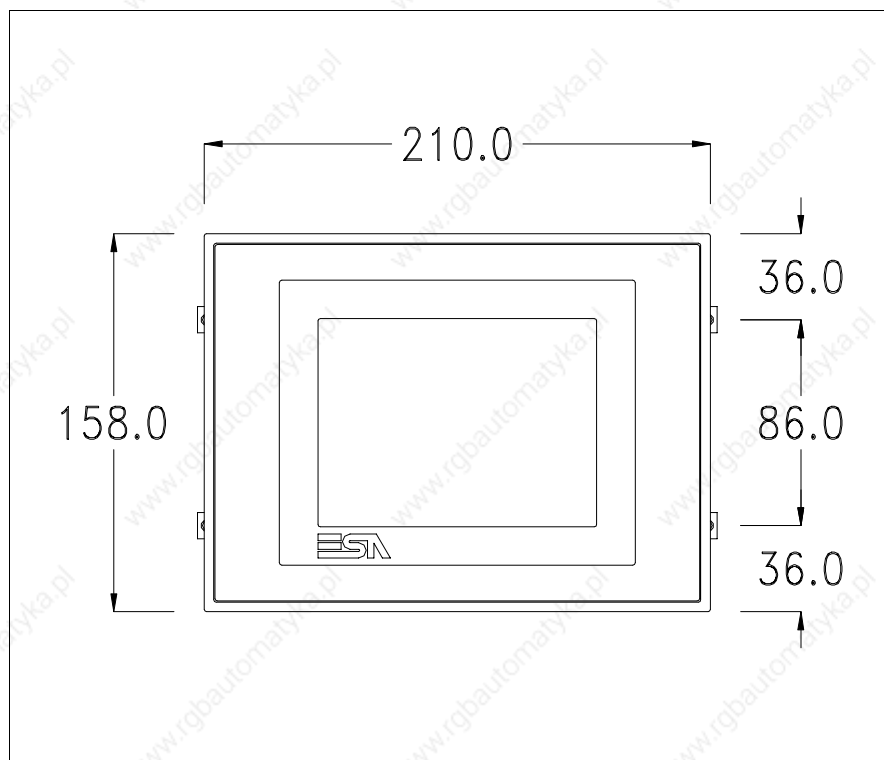
**Dimensions
and Cut-out**

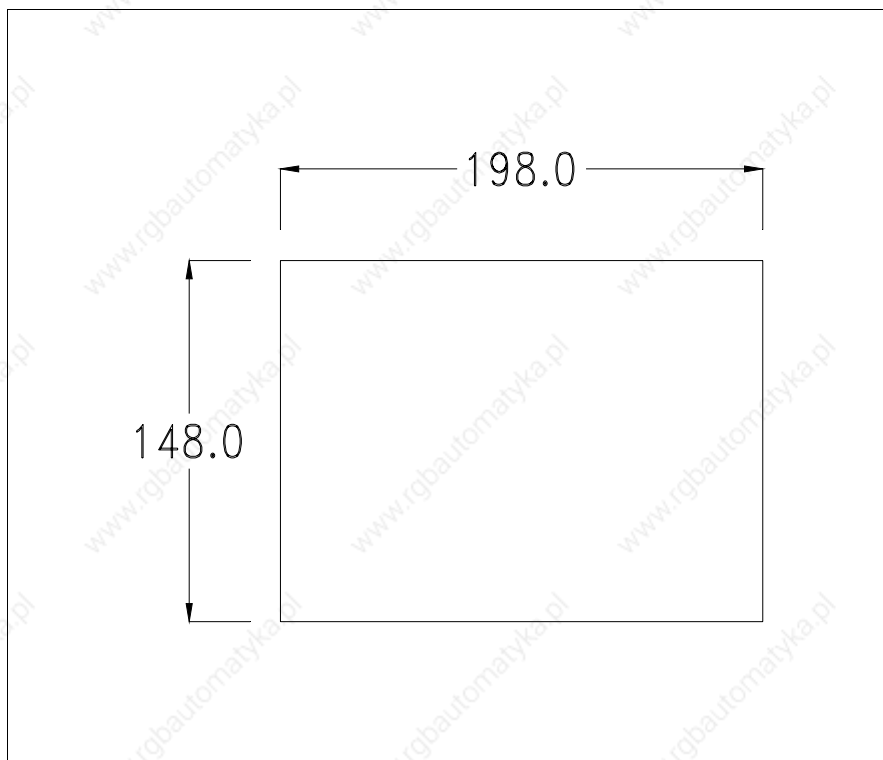

To fix the sealing gasket and secure the VT to the container see “Chapter 29 -> Mounting the terminal within the container”.

⚠ Where accessories need to be fixed in or onto the VT terminal, you are advised to do this before securing the VT to its container.

Accessories

Any accessories should be mounted in accordance with the instructions in the relevant chapter (see “Chapter 33 -> Video terminal accessories”).

Transfer PC -> VT

For everything to function properly, the first time the VT operator terminal is switched on it needs to be correctly loaded, that is it needs to have transferred to it:

- Firmware
- Communication driver
- Project

(Given that the transfer of the three files in practice occurs with a single operation, it will be defined as “Project transfer” for the sake of simplicity.)

For this it is essential that the VT be prepared to receive the transfer. (See also “Chapter 37 -> Command area”).

**Preparation
for reception**

The program VTWIN (see Software Manual) must be used for the transfer, but the terminal must be set up to receive. This means carrying out the following steps:

- Check that the VT is off
- Check that there is a serial connection between the PC and the VT
- Switch on the VT by pressing simultaneously on two diagonally opposed angles of the screen



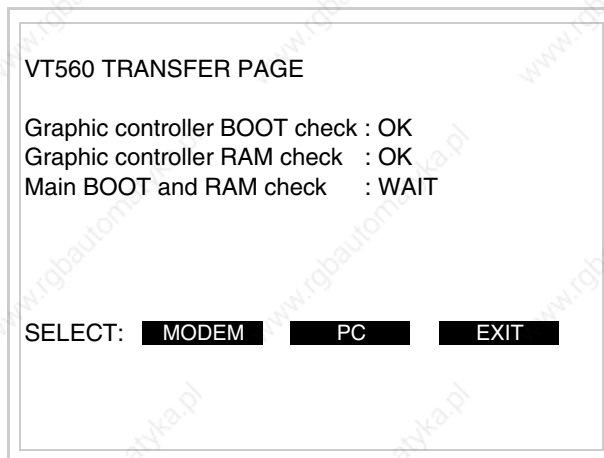

and wait a moment, or, using the appropriate button (see Page 21-16), till the VT displays the following mask

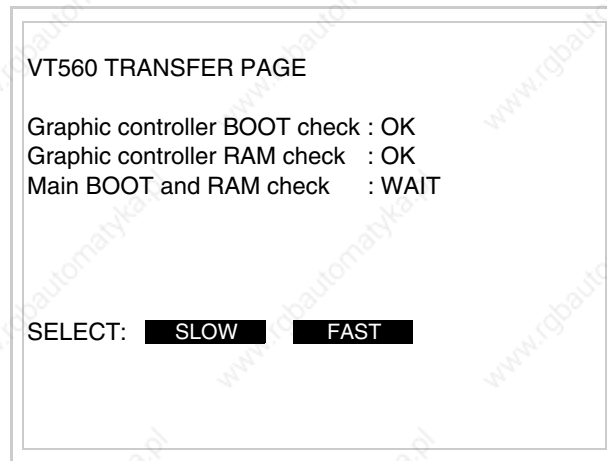

Choose the required transfer mode: MODEM if you intend to use a modem or PC if you intend to use a serial port; touch the relevant  on the display

If the choice made is PC, the VT is ready to receive (see Software Manual for transfer), if, on the other hand, you choose MODEM, the following mask will appear



The choice should be according to the speed you intend to use for the transfer (Slow=9600bit/sec or Fast=38400bit/sec), touch the relevant  on the display. The VT is now ready to receive (see Software Manual for the transfer).

Information relating to driver

After the project has been transferred, the VT can make available information relating to what has been loaded. The information regards:

- Serial ports present
- The name of the driver loaded
- The version of the driver loaded
- Network address of the VT
- Last error to have occurred

To acquire this information carry out the following operations:

- Be situated in any page of the project
- Press two diagonally opposed angles that are free of any settable objects or buttons (at least one angle must be free)



and you will see

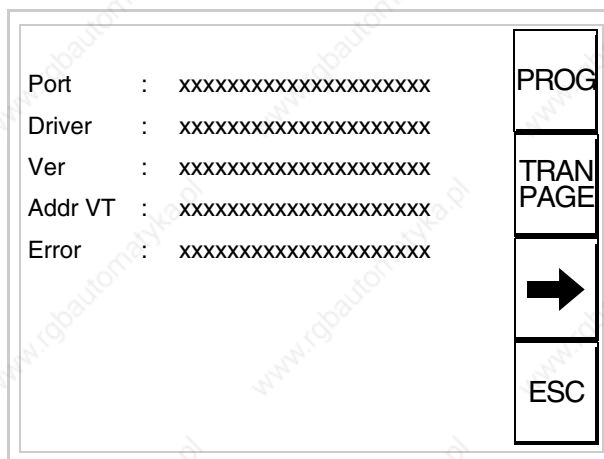

There is one of these pages for each communication port; movement between the various pages is effected by pressing .

From this page you can:

- Set the clock and the contrast
- Prepare the VT to receive the program
- Use the Memory Card

Setting the clock and the contrast:

To set the clock and the contrast, while displaying the above illustrated page, press ; the following mask appears

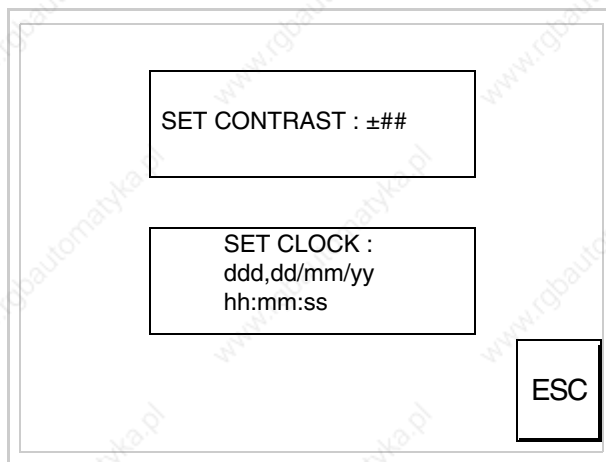

To set the contrast touch the words SET CONTRAST on the display; you will see the following mask

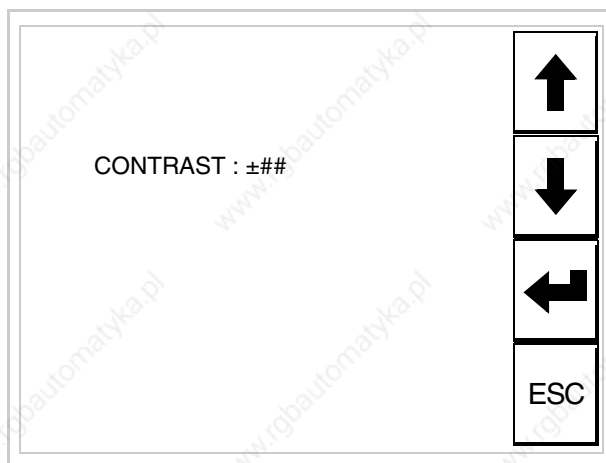



Use the arrow  for any variation (see "Chapter 36 -> Operation of terminal with touch screen").

To set the clock touch the words SET CLOCK on the display; the following mask appears

 **For the clock to be used properly, a special battery has to be inserted in the terminal (see "Chapter 33 -> Video terminal**

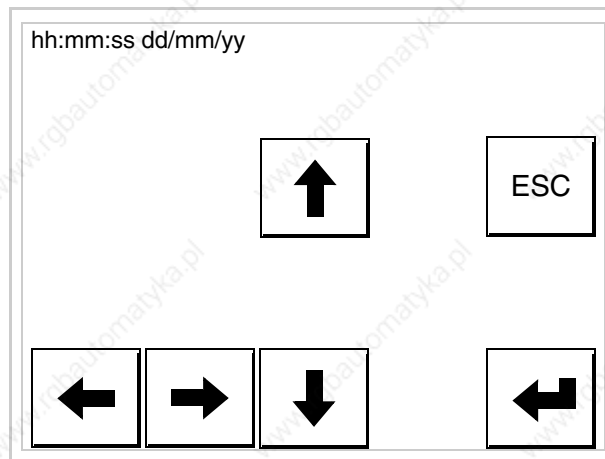
accessories“).



Use the arrow  for any variation (see “Chapter 36 -> Operation of terminal with touch screen“).

Prepare the VT to receive the program:

To prepare the VT to receive the program, while displaying the driver information page (see Page 21-13), press , and you will see the following mask

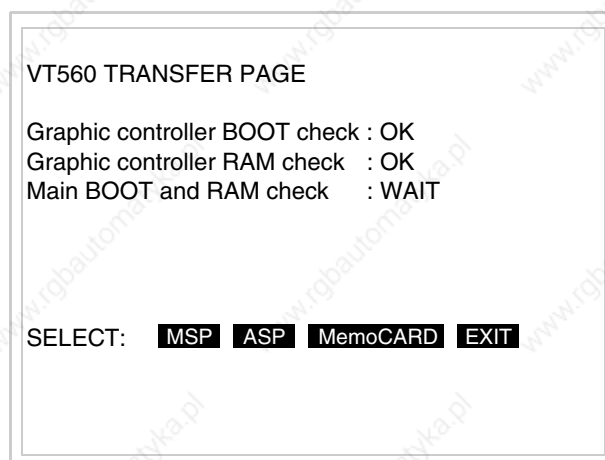

The on-screen  to press depends on the port you intend to use (MSP or ASP). The VT terminal is now ready to receive (consult Software Manual for information on the transmission procedure).

Using the Memory Card:

While displaying the driver information page, press  and the following mask will appear:

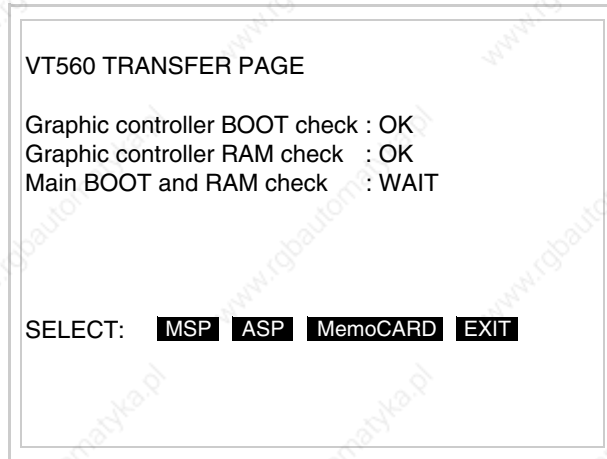

Touch the  MemoCARD on the screen (if the key is not on screen, see Page 21-12) and the following mask will appear:

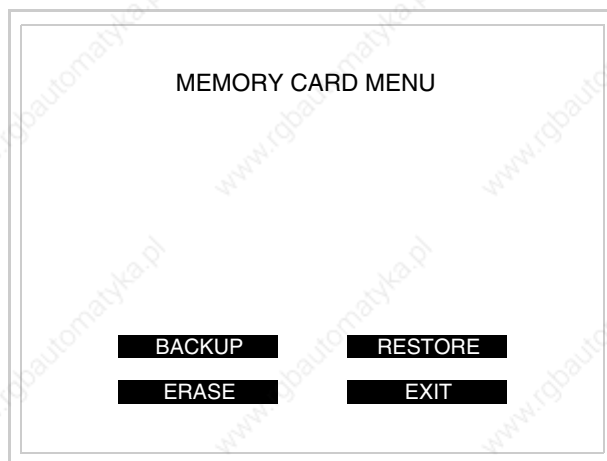

For the meaning and the functions of the keys see “Chapter 33 -> Memory card”.

Possible error messages that may be encountered in the driver information page are:

- PR ERR

Problem-> Errors have been detected in the data exchange between the VT and the Device.

Solution-> Check the cable; there may be disturbance.

- COM BROKEN

Problem-> Communication between VT and Device interrupted.

Solution-> Check the serial connection cable.

An error message followed by [*] indicates that the error is not currently present but was and has since disappeared.

Example: COM BROKEN*

When  is pressed you quit the display of information regarding the driver.

Improving display color quality

To improve the color quality, adjust the contrast of the display: if the colors are too dark increase the contrast; if, on the other hand, the colors are too light, decrease the contrast.

Adjusting the contrast on the display

To improve the quality of the representation on the display it may be necessary to adjust its contrast. This can be done by going to the page proposed (see Page 21-15) and changing the value (from +63 to -64) in evidence at that moment. Increase the value to darken the display; to lighten it, decrease the value.

We advise this to be done at typical room temperature and with the terminal at operating temperature (about 30 minutes after switching on and with the screen saver disabled - see Software Manual).

Chapter 22 Video terminal VT565W

Contents	Page
Technical characteristics	22-2
Functions	22-4
Front view	22-8
Rear view	22-9
Dimensions and Cut-out	22-10
Accessories	22-11
Transfer PC -> VT	22-11
Preparation for reception	22-12
Information relating to driver	22-15
Improving display color quality	22-19
Adjusting the contrast on the display	22-19

This chapter consists of 20 pages.

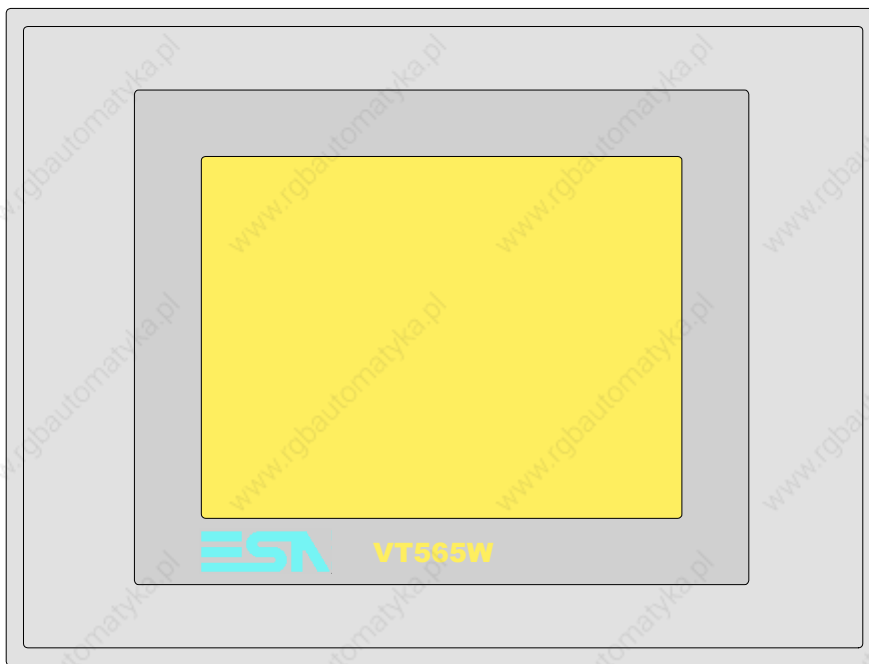

Technical characteristics

The following table lists the principal technical characteristics of the product in question.

Code of terminal	Characteristics of the terminal			
VT565W A0000				
VT565W AP000				
VT565W A0M00				
VT565W APM00				
Display				
Type	LCD 8 tones of grey STN	●	●	
	LCD 256 Colors STN			●
	LCD 256 Colors TFT			●
Touch screen	Matrix 20 x 16 (Cell:16x15 pixels)	●	●	●
Representational format	Graphic	●	●	●
Resolution [pixels]	320 x 240 (5,7")	●	●	●
Rows x characters	16 x 40 / 8 x 20 / 4 x 10	●	●	●
Display area size [mm]	115,6 x 87	●	●	●
Character matrix in text mode [pixels]	8 x15 / 16 x 30 / 32 x 60	●	●	●
Character size [mm] x 1 / x 2 / x 4	2,8 x 5,2 / 5,6 x 10,4 / 11,2 x 20,8	●	●	●
Contrast adjustment	Software	●	●	●
	Automatic compensation with temperature	●	●	●
Character sets	Programmable fonts/TTF Windows ®	●	●	●
Backlighting				
Type	LED			
	CCFL lamp	●	●	●
Minimum lamp-life at 25°C [hours]	15000	●	●	●

Code of terminal	Characteristics of the terminal			
VT565W A000				
VT565W AP000				
VT565W A0M00				
VT565W APM00				
User memory				
Project [Bytes]	192K + 832K (Text + Graphics)	●	●	●
Data memory [Bytes]	128K (With back-up battery)	●	●	●
Memory for Windows ® -based fonts [Byte]	128K	●	●	●
Memory Card for backup	4Mb	●	●	●
Memory Card for expansion	--			
Interfaces				
MSP (Multi-serial port)	RS232/RS422/RS485/TTY-20mA	●	●	●
ASP (Auxiliary serial port)	RS232/RS485	●	●	●
ASP-15L (Auxiliary serial port)	RS232/RS485			
ASP-8 (Auxiliary serial port)	RS232			
ASP-9 (Auxiliary serial port)	RS232			
LPT parallel port	Centronics	●	●	
Auxiliary port	Connections for accessories			
Accessories				
Connectable accessories	See table "Chapter 33"	●	●	●
Clock				
Clock	Hardware (With back-up battery)	●	●	●
Networks				
Integrated	Profibus-DP			
	CAN Open (Optoisolated interface)			
	Ethernet 10/100Mbit RJ45			
Universal Bus Connector	--			
Optional	See table "Chapter 33"	●	●	●
Proprietary networks				
ESA-Net	Network server	●	●	●
	Network client	●	●	●
Technical data				
Power supply	24Vdc (18..32Vdc)			
Power absorbed at 24Vdc	15W			
Protection fuse	Ø5x20mm - 800mA Quick Blow F			
Protection level	IP65 (front-end)			
Operating temperature	0..50°C			
Storage and transportation temperature	-20..+60°C			
Humidity (non-condensing)	<85%			
Weight	1400gr			
Dimensions				
External W x H x D [mm]	210 x 158 x 54			
Cut-out W x H [mm]	198 x 148			
Certification				
Certifications and approvals	CE, cULus, NEMA12			

Functions

The following table lists in alphabetical order all the functions of the VT in question.

Table 22.1: Functions and objects realizable with this VT (Part 1 of 4)

Code of terminal		
VT565W *****		
Objects/Functions	Quantity	▼
Alarm field		●
Alarm help	1024	●
Alarm history buffer	256	●
Alarm statistics		
Alarms (Total/active simultaneously)	1024/256	●
Arc		●
Automatic operations	32	●
Backup/Restore		●
Bar data		●
Bit-wise password	8bits	●
Buttons	320 x page	●
Circles		●
Command: Change language		●
Command: Clear trend buffer		●
Command: Delete recipe		●
Command: Hardcopy		●
Command: Load recipe from data memory		●
Command: Modify password		●
Command: Next page		●
Command: Page help		●
Command: Password login		●
Command: Password logout		●
Command: Previous page		●
Command: Print alarm history		●
Command: Printer form feed		●
Command: Quit project		●
Command: Report		●
Command: Restarts reading time-sampled trend		●
Command: Run pipeline		●
Command: Save alarms history and trend buffers in flash		
Command: Save recipe in data memory		●
Command: Save recipe received from device in buffer		●
Command: Save recipe received from device in data memory		●
Command: Send recipe from video buffer to device		●
Command: Send recipe to device		●
Command: Service page		●

Unless otherwise stated, there is no limit to the number of includable elements, only the size of project memory sets a limit.
*) indicative value determined by the dimensions of the project, **) depends on memory available

Table 22.1: Functions and objects realizable with this VT (Part 2 of 4)

Code of terminal		
VT565W ****		
Objects/Functions	Quantity	▼
Command: Show alarms history		●
Command: Show page directory		●
Command: Show project information		●
Command: Show recipe directory		●
Command: Show sequence directory		
Command: Shows driver status page		●
Command: Shows page help		●
Command: Shows page with function: PG		
Command: Stops reading time sampled trend		●
Command: Trend reading saved in device		●
Command: Zero number of general pages		●
Date field		●
Day-of-the-week field		●
Dynamic texts: Bit-group-structured dynamic texts	1024*	●
Dynamic texts: Single-bit dynamic texts		●
Dynamic texts: Value-structured dynamic texts		●
E-keys		
Equations	32	●
F-keys		
Free terminal		
Function: Disables key		
Function: Go to page		●
Function: Internal command		●
Function: Invert bit value		●
Function: Macro		●
Function: None		
Function: Reset bit permanently		●
Function: Reset real-time bit		●
Function: Sequences		
Function: Sets bit permanently		●
Function: Sets real-time bit		●
Function: Value-structure direct command		●
Global configuration of E-keys		
Global configuration of F-keys		
Headers and footers (Total/Number of fields per H-F)	128/128	●
Info-messages (Total/active simultaneously)	1024/256	●
Internal registers	4096bytes	●
Labels		●
LEDs assigned to sequence		

Unless otherwise stated, there is no limit to the number of includable elements, only the size of project memory sets a limit.
 *) indicative value determined by the dimensions of the project, **) depends on memory available

Table 22.1: Functions and objects realizable with this VT (Part 3 of 4)

Code of terminal		
VT565W *****		
Objects/Functions	Quantity	▼
Lines		●
Lists of bitmap images		●
Lists of texts		●
Local configuration of E-keys		
Local configuration of F-keys		
Macro field		
Macros (Total/Commands x macro)	1024/16	●
Message field		●
Message help	1024	●
Multilanguage texts	8 Langs.	●
Object - Indicator	64	●
Object - Potentiometer knob	64	●
Object - Selector knob	64	●
Object - Sliding potentiometer	64	●
Object - Sliding selector	64	●
Page	1024	●
Page help	1024	●
Password	10	●
Pipelines (Number/Tot bytes)	64/512	●
Print		●
Print page (Total/Number of fields per page)	1024/128	●
Programmable fonts		●
Project images		●
Public variables of ESANET network (Number/Total bytes)	256/1024	●
Recipe field for recipe structure		●
Recipes (Number of variables per recipe)	1024/512	●
Rectangles		●
Redefinable characters		
Reports	128	●
Sequences - Random		
Sequences - Start/stop		
Static bitmaps		●
Symbolic field: Bit-group-structured dynamic bitmaps	1024*	●
Symbolic field: Single-bit-structured dynamic bitmaps		●
Symbolic field: Value-structured dynamic bitmaps		●
System messages		●
System variables assigned to recipe structure		●
Time long field		●
Time short field		●

Unless otherwise stated, there is no limit to the number of includable elements, only the size of project memory sets a limit.
*) indicative value determined by the dimensions of the project, **) depends on memory available

Table 22.1: Functions and objects realizable with this VT (Part 4 of 4)

Code of terminal		
VT565W ****		
Objects/Functions	Quantity	▼
Timer	32	●
Touch Area	64	●
Trend buffers	128	●
Trends (Trends x page/Channels x trend)	4/4	●
Trends sampled automatically (Memory/Trends/Readings)	4096bytes	●
Trends sampled on command (Memory/Trends/Readings)	/**/320	●
Value direct command: ADD		●
Value direct command: AND		●
Value direct command: OR		●
Value direct command: SET		●
Value direct command: SUBTRACT		●
Value direct command: XOR		●
Variables: Limit values and linear scaling variables	112xpages	●
Variables: Movement variable (Mobile symbolic field)		●
Variables: Threshold variables		●
Variables: Floating Point numerical variables		●
Variables: Numerical variables (DEC, HEX, BIN, BCD)		●
Variables: String variables (ASCII)		●

Unless otherwise stated, there is no limit to the number of includable elements, only the size of project memory sets a limit.
 *) indicative value determined by the dimensions of the project, **) depends on memory available

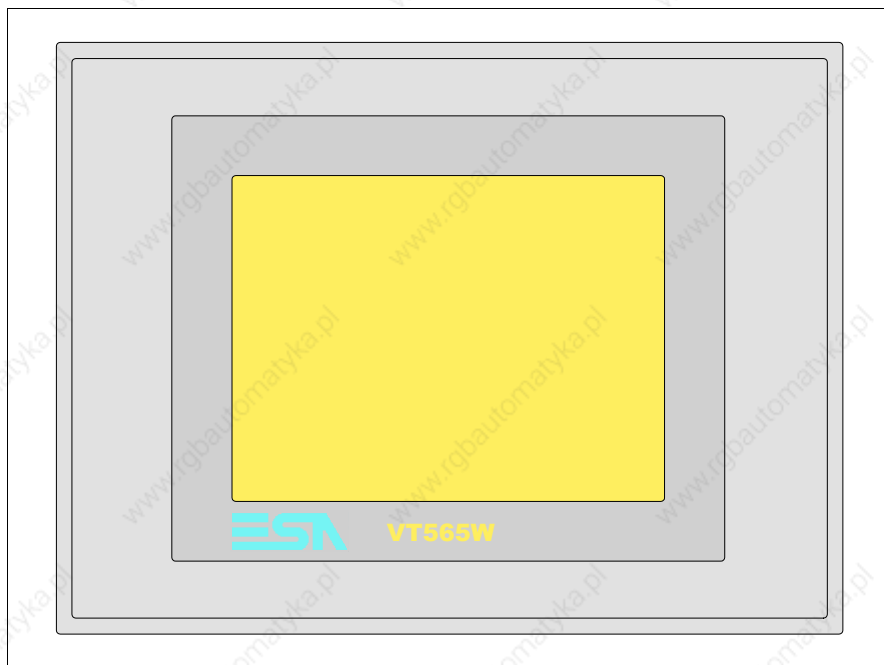
Front view

All buttons and signals are defined using the programming software (see Software Manual).

Rear view

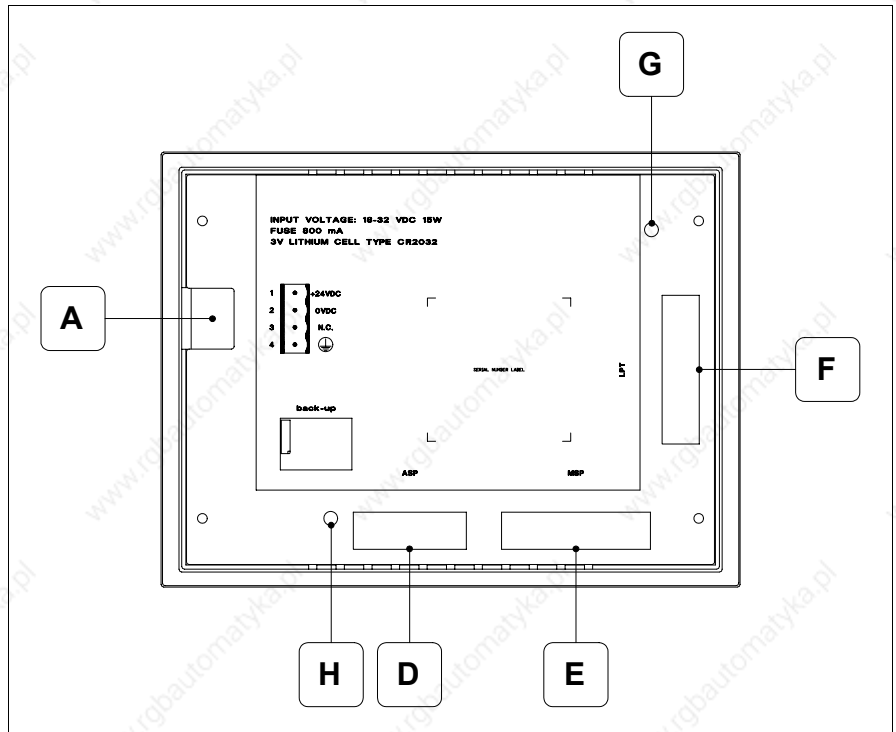

Position	Function
A	Power supply connector
D	ASP serial port for communicating with PC or other devices
E	MSP serial port for communicating with PLC/PC
F	LPT port for connecting printer (Optional)
G	Trimmer for brightness control (B&W)
H	Trimmer for brightness control (Color)

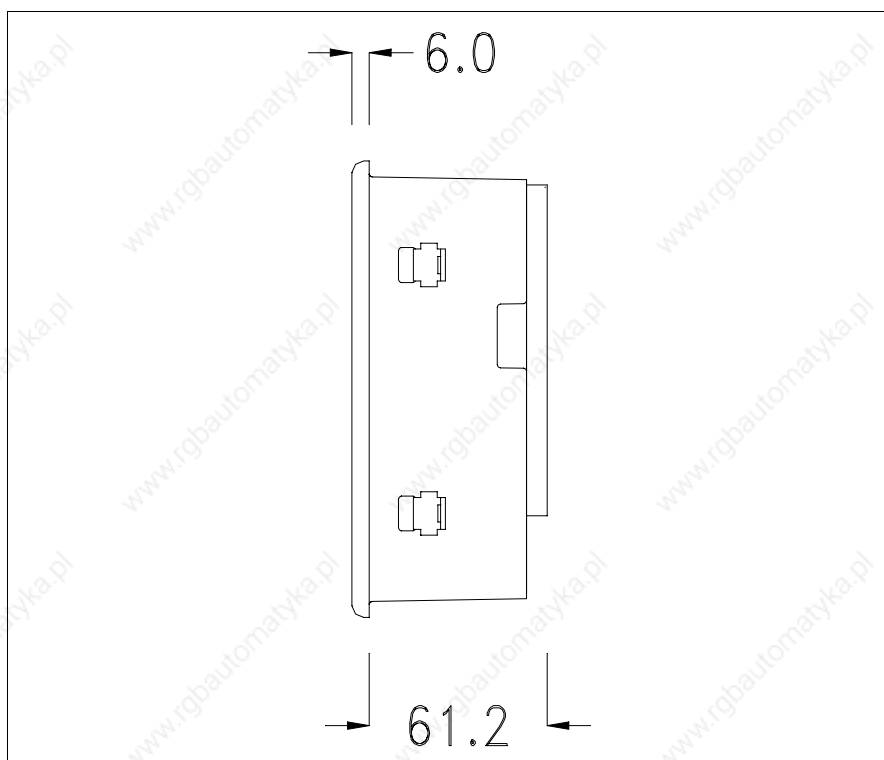
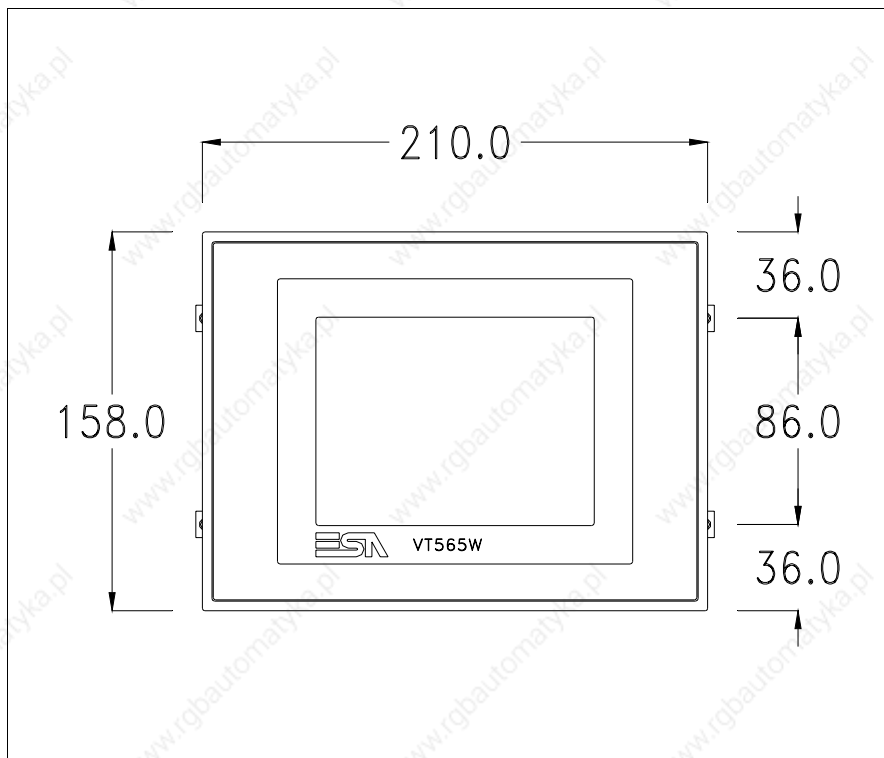
**Dimensions
and Cut-out**

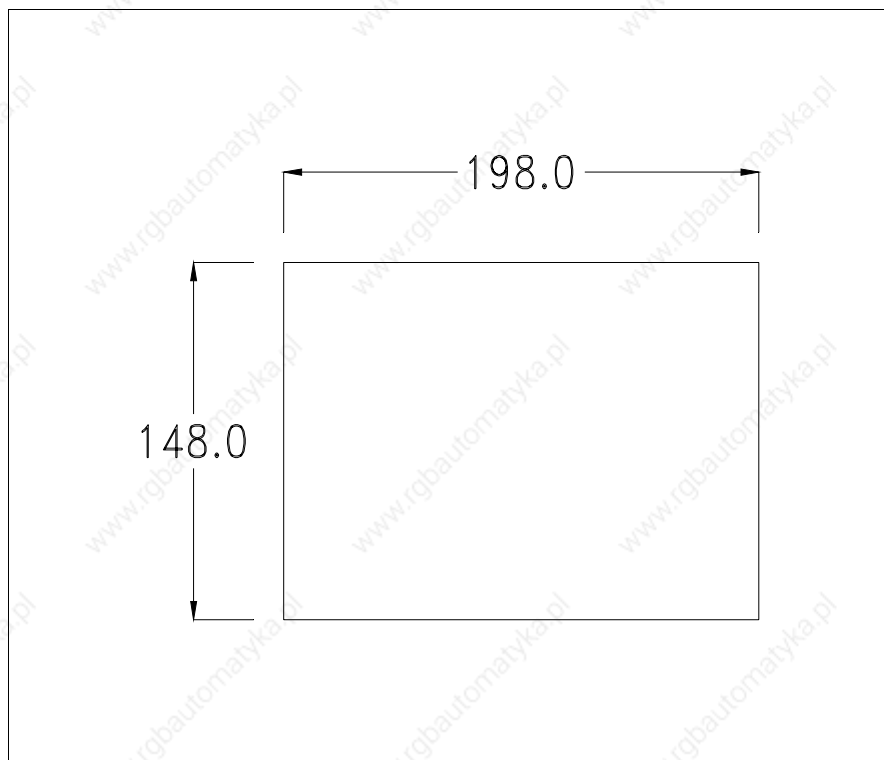

To fix the sealing gasket and secure the VT to the container see “Chapter 29 -> Mounting the terminal within the container”.

⚠ Where accessories need to be fixed in or onto the VT terminal, you are advised to do this before securing the VT to its container.

Accessories

Any accessories should be mounted in accordance with the instructions in the relevant chapter (see “Chapter 33 -> Video terminal accessories”).

Transfer PC -> VT

For everything to function properly, the first time the VT operator terminal is switched on it needs to be correctly loaded, that is it needs to have transferred to it:

- Firmware
- Communication driver
- Project

(Given that the transfer of the three files in practice occurs with a single operation, it will be defined as “Project transfer” for the sake of simplicity.)

For this it is essential that the VT be prepared to receive the transfer. (See also “Chapter 37 -> Command area”).

**Preparation
for reception**



The program VTWIN (see Software Manual) must be used for the transfer, but the terminal must be set up to receive. This means carrying out the following steps:

- Check that the VT is off
- Check that there is a serial connection between the PC and the VT
- Switch on the VT by pressing simultaneously on two diagonally opposed angles of the screen



and wait a moment, or, using the appropriate button (see Page 22-17), till the VT displays the following mask

VT terminal with no Modem function:

- Choose the port you intend to use for the transfer (MSP or ASP); touch the relevant  on the display. The VT is now ready to receive (refer to Software Manual for transfer procedure). The  MemoCARD appears if the Memory Card has been inserted in the VT (see Page 22-18)

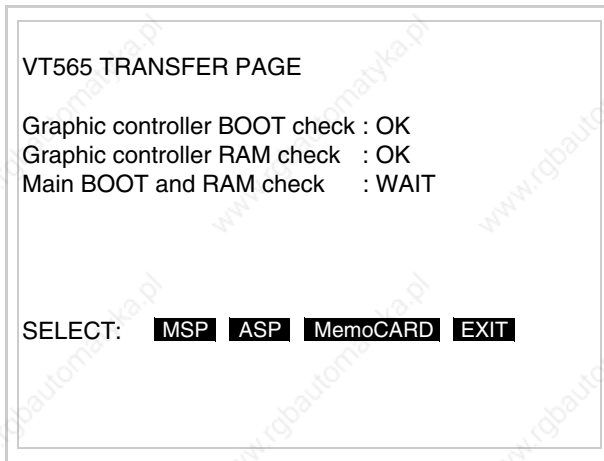

VT terminal with Modem function:

- Proceed from the preceding mask; the following mask appears

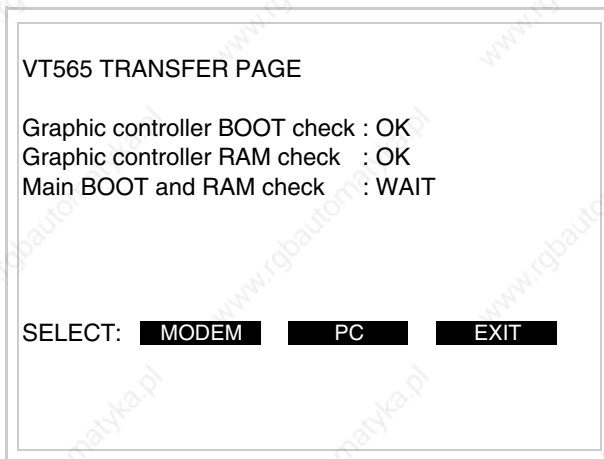

- Choose the required transfer mode: MODEM if you intend to use a modem or PC if you intend to use a serial port; touch the relevant on the display

If the choose made is PC, the VT is ready to receive (see Software Manual for transfer), if, on the other hand, you choose MODEM, the following mask will appear

VT565 TRANSFER PAGE

Graphic controller BOOT check : OK
Graphic controller RAM check : OK
Main BOOT and RAM check : WAIT

SELECT: SLOW FAST

The choice should be according to the speed you intend to use for the transfer (Slow=9600bit/sec or Fast=38400bit/sec), touch the relevant on the display. The VT is now ready to receive (see Software Manual for the transfer).

Information relating to driver

After the project has been transferred, the VT can make available information relating to what has been loaded. The information regards:

- Serial ports present
- The name of the driver loaded
- The version of the driver loaded
- Network address of the VT
- Last error to have occurred

To acquire this information carry out the following operations:

- Be situated in any page of the project
- Press two diagonally opposed angles that are free of any settable objects or buttons (at least one angle must be free)



and you will see

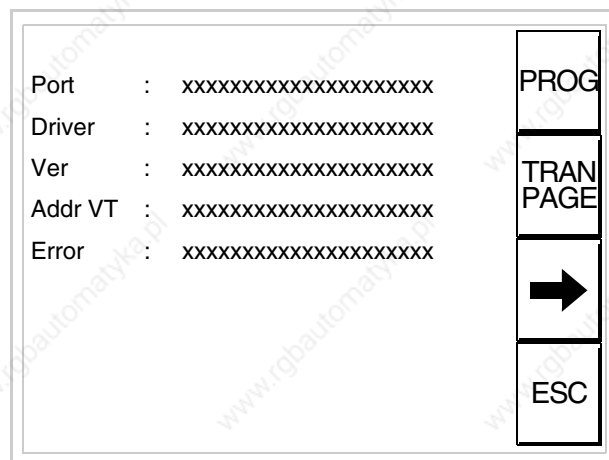

There is one of these pages for each communication port; movement between the various pages is effected by pressing .

From this page you can:

- Set the clock and the contrast
- Prepare the VT to receive the program
- Use the Memory Card

Setting the clock and the contrast:

To set the clock and the contrast, while displaying the above illustrated page, press ; the following mask appears

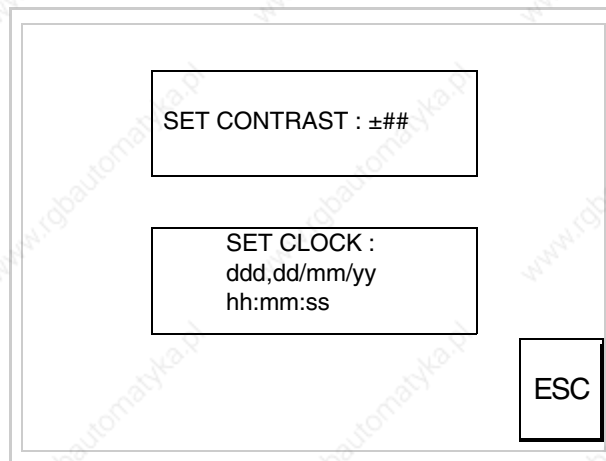

To set the contrast touch the words SET CONTRAST on the display; you will see the following mask

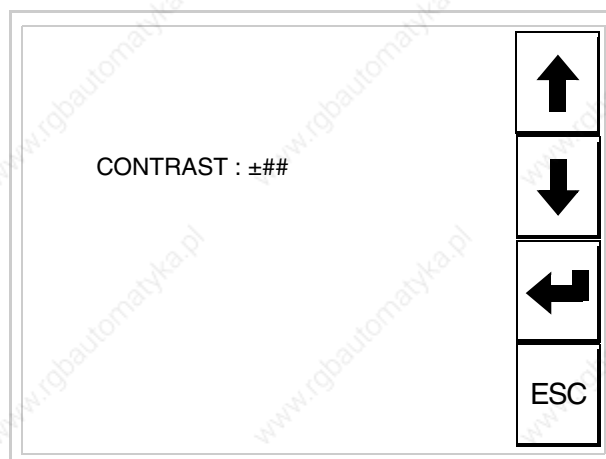

Use the arrow  for any variation (see “Chapter 36 -> Operation of terminal with touch screen”).

To set the clock touch the words SET CLOCK on the display; the following mask appears

▲ For the clock to be used properly, a special battery has to be inserted in the terminal (see “Chapter 33 -> Video terminal accessories”).

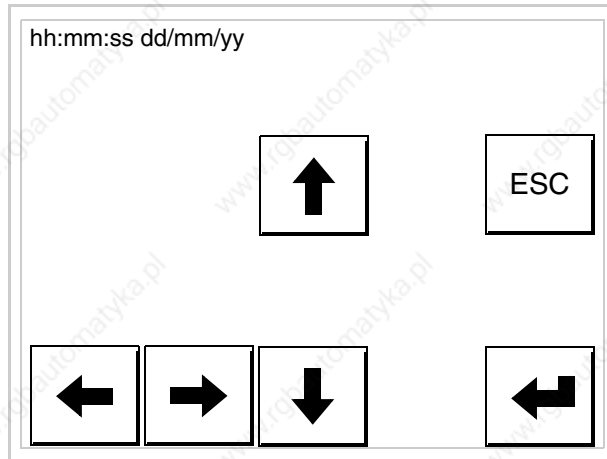

Use the arrow  for any variation (see “Chapter 36 -> Operation of terminal with touch screen”).

Prepare the VT to receive the program:

To prepare the VT to receive the program, while displaying the driver information page (see Page 22-15), press , and you will see the following mask

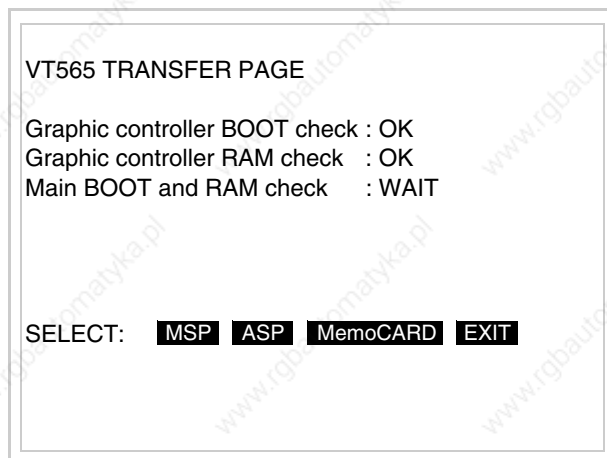

The on-screen  to press depends on the port you intend to use (MSP or ASP). The VT terminal is now ready to receive (consult Software Manual for information on the transmission procedure).

Using the Memory Card:

While displaying the driver information page, press  and the following mask will appear:

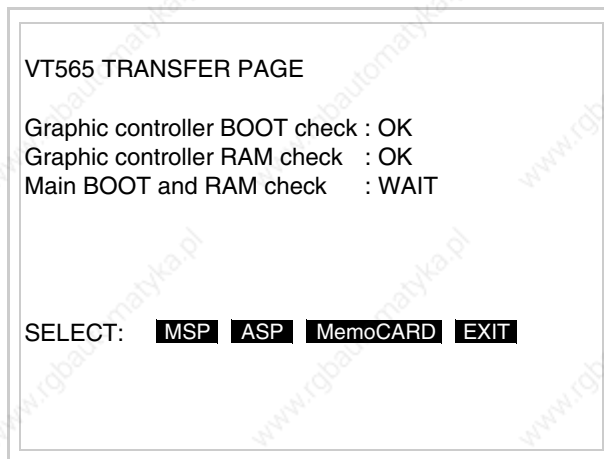

Touch the  MemoCARD on the screen (if the key is not on screen, see Page 22-12) and the following mask will appear:

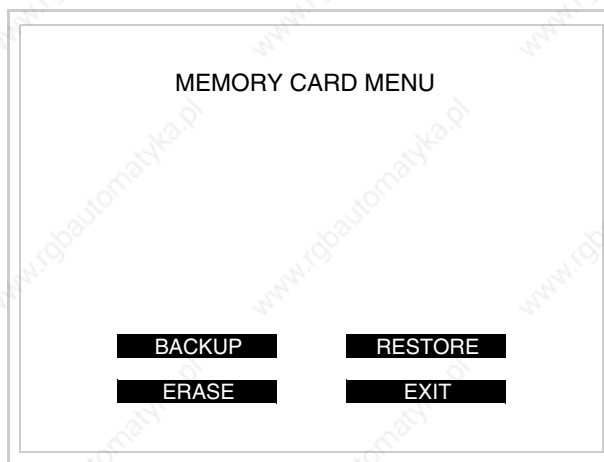

For the meaning and the functions of the keys see “Chapter 33 -> Memory card”.

Possible error messages that may be encountered in the driver information page are:

- PR ERR

Problem-> Errors have been detected in the data exchange between the VT and the Device.

Solution-> Check the cable; there may be disturbance.

- COM BROKEN

Problem-> Communication between VT and Device interrupted.

Solution-> Check the serial connection cable.

An error message followed by [*] indicates that the error is not currently present but was and has since disappeared.

Example: COM BROKEN*

When  is pressed you quit the display of information regarding the driver.

Improving display color quality

To improve the color quality, adjust the contrast of the display: if the colors are too dark increase the contrast; if, on the other hand, the colors are too light, decrease the contrast.

Adjusting the contrast on the display

To improve the quality of the representation on the display it may be necessary to adjust its contrast. This can be done by going to the page proposed (see Page 22-16) and changing the value (from +63 to -64) in evidence at that moment. Increase the value to darken the display; to lighten it, decrease the value.

We advise this to be done at typical room temperature and with the terminal at operating temperature (about 30 minutes after switching on and with the screen saver disabled - see Software Manual).

Chapter 23 Video terminal VT575W

Contents	Page
Technical characteristics	23-2
Functions	23-4
Front view	23-8
Standard series rear view	23-9
Profibus-DP series rear view	23-10
CAN series rear view	23-11
Ethernet series rear view	23-12
Dimensions and Cut-out	23-13
Accessories	23-14
Calibration of Touch Screen	23-14
Termination of CAN line	23-17
Introducing the MAC address	23-18
Transfer PC -> VT	23-21
Preparation for reception	23-21
Information relating to driver	23-23
Improving display color quality	23-29
Adjusting the contrast on the display	23-29

This chapter consists of 30 pages.

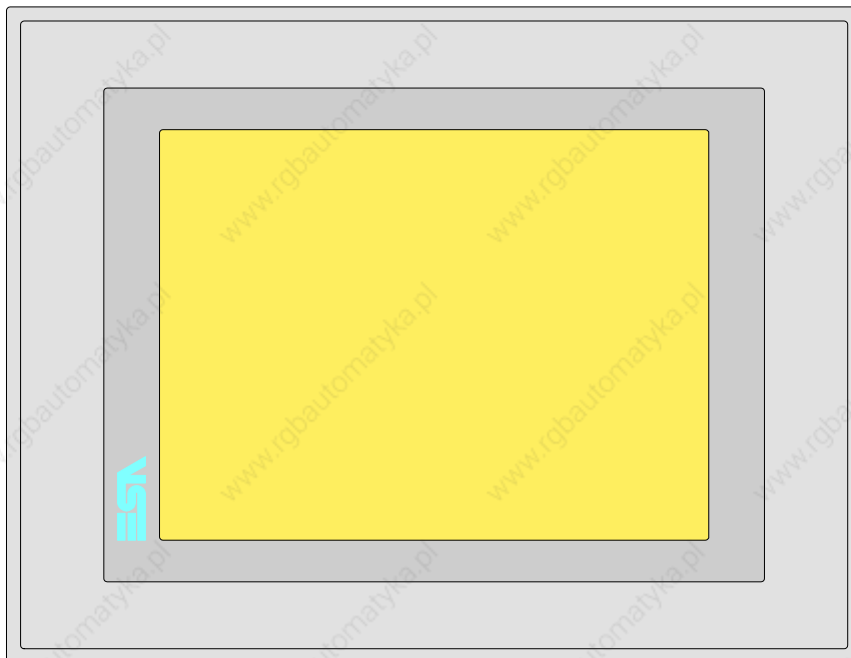

Technical characteristics The following table lists the principal technical characteristics of the product in question.

Code of terminal		Characteristics of the terminal			
VT575W APS00					
VT575W 0PSDP					
VT575W 0PSCN					
VT575W 0PSET					
Display					
Type	LCD Monochromatic STN				
	LCD 256 Colors STN	●	●	●	●
	LCD 256 Colors TFT				
Touch screen [cells]	Matrix 40x30 (Cell:16x16 pixels)	●	●	●	●
Representational format	Graphic	●	●	●	●
Resolution [pixels]	640 x 480 (7,5")	●	●	●	●
Rows per character	30 x 80 / 15 x 40 / 7 x 20	●	●	●	●
Dimension of visible area [mm]	158 x 118	●	●	●	●
Character matrix in text mode [pixels]	8 x16 / 16 x 32 / 32 x 64	●	●	●	●
Character size [mm] x1 / x2 / x4	1,89 x 3,79 / 3,79 x 7,58 / 7,58 x 15,16	●	●	●	●
Contrast adjustment	Software	●	●	●	●
	Automatic compensation with temperature	●	●	●	●
Character set	Programmable fonts/TTF Windows ®	●	●	●	●
Backlighting					
Type	LED				
	CCFL lamp	●	●	●	●
Minimum lamp-life at 25°C [hours]	15000	●	●	●	●

Code of terminal	Characteristics of the terminal			
VT575W APS00				
VT575W 0PSDP				
VT575W 0PSCN				
VT575W 0PSET				
User memory				
Project [Bytes]	960K + 6M (Text + Graphic)	●	●	●
Data memory [Bytes]	128K (Flash EPROM)	●	●	●
Memory for Windows ® -based fonts [Byte]	512K	●	●	●
Memory Card for backup	8Mb	●	●	●
Memory Card for expansion	4Mb (Only for graphic type)			
Interfaces				
MSP (Multi-serial port)	RS232/RS422/RS485/TTY-20mA	●	●	●
ASP (Auxiliary serial port)	RS232/RS485			●
ASP-15L (Auxiliary serial port)	RS232/RS485			
ASP-8 (Auxiliary serial port)	RS232			
ASP-9 (Auxiliary serial port)	RS232			
LPT parallel port	Centronics	●	●	●
Auxiliary port	Connection for accessory devices			
Accessories				
Connectable accessories	See table "Chapter 33"	●	●	●
Clock				
Clock	Hardware (with Supercapacitor - Min.72h Typically130h)	●	●	●
Networks				
Integrated	Profibus-DP			●
	CAN Open (Optoisolated interface)		●	
	Ethernet 10/100Mbit RJ45	●		
Universal Bus Connector	--			
Optional	See table "Chapter 33"	●	●	●
Proprietary networks				
ESA-Net	Network server	●	●	●
	Network client	●	●	●
Technical data				
Power supply	24Vdc (18..32Vdc)			
Power absorbed at 24Vdc	15W			
Protection fuse	Ø5x20mm - 1,25A Quick Blow F			
Protection level	IP65 (front-end)			
Operating temperature	0..50°C			
Storage and transportation temperature	-20..+60°C			
Humidity (non-condensing)	<85%			
Weight	1500gr			
Dimensions				
External W x H x D [mm]	245,9 x 188,6 x 37,6			
Cut-out W x H [mm]	233 x 176			
Certification				
Certifications and approvals	CE, cULus, NEMA12			

Functions

The following table lists in alphabetical order all the functions of the VT in question.

Table 23.1: Functions and objects realizable with this VT (Part 1 of 4)

Code of terminal		
VT575W *****		
Objects/Functions	Quantity	▼
Alarm field		●
Alarm help	1024	●
Alarm history buffer	256	●
Alarm statistics		
Alarms (Total/active simultaneously)	1024/256	●
Arc		●
Automatic operations	32	●
Backup/Restore		●
Bar data		●
Bit-wise password	8bits	●
Buttons	1200xpage	●
Circles		●
Command: Change language		●
Command: Clear trend buffer		●
Command: Delete recipe		●
Command: Hardcopy		●
Command: Load recipe from data memory		●
Command: Modify password		●
Command: Next page		●
Command: Page help		●
Command: Password login		●
Command: Password logout		●
Command: Previous page		●
Command: Print alarm history		●
Command: Printer form feed		●
Command: Quit project		●
Command: Report		●
Command: Restarts reading time-sampled trend		●
Command: Run pipeline		●
Command: Save alarms history and trend buffers in flash		●
Command: Save recipe in data memory		●
Command: Save recipe received from device in buffer		●
Command: Save recipe received from device in data memory		●
Command: Send recipe from video buffer to device		●
Command: Send recipe to device		●
Command: Service page		●

Unless otherwise stated, there is no limit to the number of includable elements, only the size of project memory sets a limit.
*) indicative value determined by the dimensions of the project, **) depends on memory available

Table 23.1: Functions and objects realizable with this VT (Part 2 of 4)

Code of terminal		
VT575W *****		
Objects/Functions	Quantity	▼
Command: Show alarms history		●
Command: Show page directory		●
Command: Show project information		●
Command: Show recipe directory		●
Command: Show sequence directory		
Command: Shows driver status page		●
Command: Shows page help		●
Command: Shows page with function: PG		
Command: Stops reading time sampled trend		●
Command: Trend reading saved in device		●
Command: Zero number of general pages		●
Date field		●
Day-of-the-week field		●
Dynamic texts: Bit-group-structured dynamic texts	1024*	●
Dynamic texts: Single-bit dynamic texts		●
Dynamic texts: Value-structured dynamic texts		●
E-keys		
Equations	32	●
F-keys		
Free terminal		
Function: Disables key		
Function: Go to page		●
Function: Internal command		●
Function: Invert bit value		●
Function: Macro		●
Function: None		
Function: Reset bit permanently		●
Function: Reset real-time bit		●
Function: Sequences		
Function: Sets bit permanently		●
Function: Sets real-time bit		●
Function: Value-structure direct command		●
Global configuration of E-keys		
Global configuration of F-keys		
Headers and footers (Total/Number of fields per H-F)	128/128	●
Info-messages (Total/active simultaneously)	1024/256	●
Internal registers	4096bytes	●
Labels		●
LEDs assigned to sequence		

Unless otherwise stated, there is no limit to the number of includable elements, only the size of project memory sets a limit.
 *) indicative value determined by the dimensions of the project, **) depends on memory available

Table 23.1: Functions and objects realizable with this VT (Part 3 of 4)

Code of terminal		
VT575W *****		
Objects/Functions	Quantity	
Lines		●
Lists of bitmap images		●
Lists of texts		●
Local configuration of E-keys		
Local configuration of F-keys		
Macro field		
Macros (Total/Commands x macro)	1024/16	●
Message field		●
Message help	1024	●
Multilanguage texts	8 Langs.	●
Object - Indicator	128	●
Object - Potentiometer knob	128	●
Object - Selector knob	128	●
Object - Sliding potentiometer	128	●
Object - Sliding selector	128	●
Page	1024	●
Page help	1024	●
Password	10	●
Pipelines (Number/Tot bytes)	64/512	●
Print		●
Print page (Total/Number of fields per page)	1024/128	●
Programmable fonts		●
Project images		●
Public variables of ESANET network (Number/Total bytes)	512/1024	●
Recipe field for recipe structure		●
Recipes (Number of variables per recipe)	1024/512	●
Rectangles		●
Redefinable characters		
Reports	128	●
Sequences - Random		
Sequences - Start/stop		
Static bitmaps		●
Symbolic field: Bit-group-structured dynamic bitmaps	1024*	●
Symbolic field: Single-bit-structured dynamic bitmaps		●
Symbolic field: Value-structured dynamic bitmaps		●
System messages		●
System variables assigned to recipe structure		●
Time long field		●
Time short field		●

Unless otherwise stated, there is no limit to the number of includable elements, only the size of project memory sets a limit.
*) indicative value determined by the dimensions of the project, **) depends on memory available

Table 23.1: Functions and objects realizable with this VT (Part 4 of 4)

Code of terminal		
VT575W ****		
Objects/Functions	Quantity	▼
Timer	32	●
Touch Area	256	●
Trend buffers	128	●
Trends (Trends x page/Channels x trend)	8/8	●
Trends sampled automatically (Memory/Trends/Readings)	6144bytes /**/480	●
Trends sampled on command (Memory/Trends/Readings)		●
Value direct command: ADD		●
Value direct command: AND		●
Value direct command: OR		●
Value direct command: SET		●
Value direct command: SUBTRACT		●
Value direct command: XOR		●
Variables: Limit values and linear scaling variables	256 x pages	●
Variables: Movement variable (Mobile symbolic field)		●
Variables: Threshold variables		●
Variables: Floating Point numerical variables		●
Variables: Numerical variables (DEC, HEX, BIN, BCD)		●
Variables: String variables (ASCII)		●

Unless otherwise stated, there is no limit to the number of includable elements, only the size of project memory sets a limit.
 *) indicative value determined by the dimensions of the project, **) depends on memory available

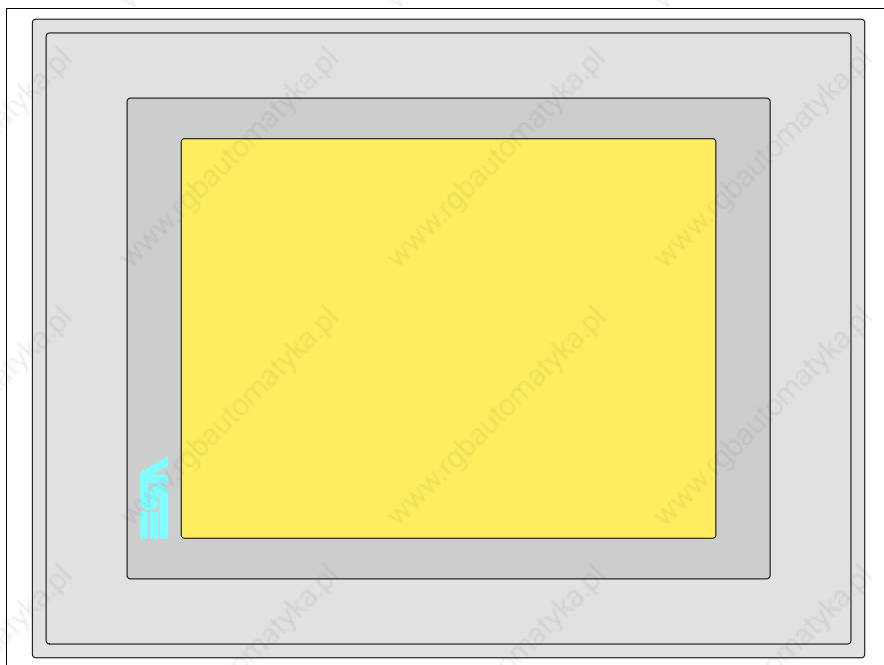
Front view

All buttons and signals are defined via the programming software (see Software Manual).

Standard series rear view

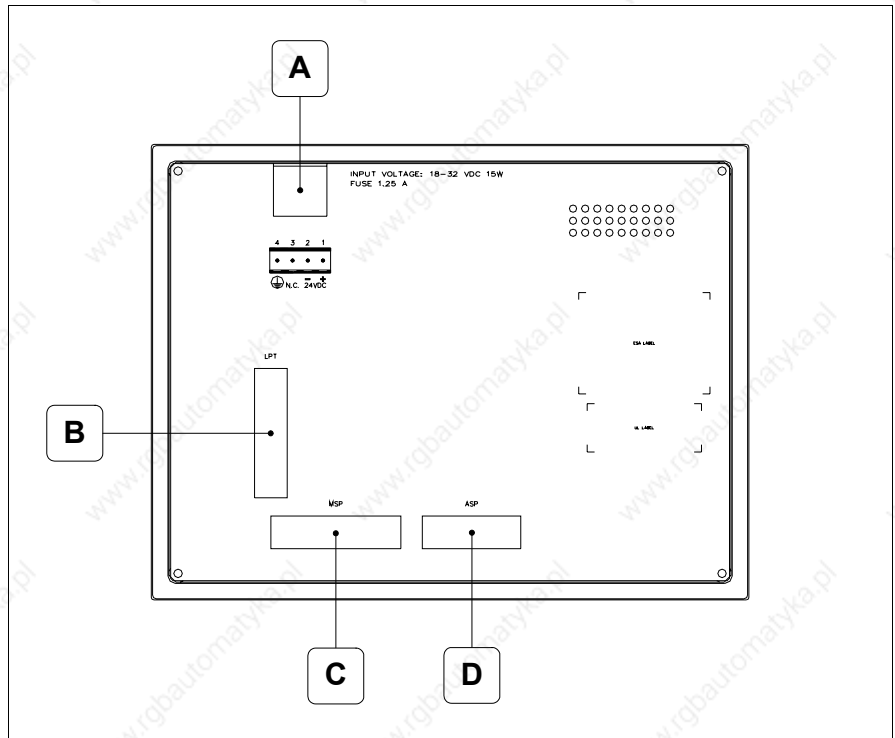

Position	Function
A	Power supply connector
B	LPT port for connecting printer
C	MSP serial port for communicating with PLC/PC
D	ASP serial port for communicating with PC or other devices

Profibus-DP series rear view

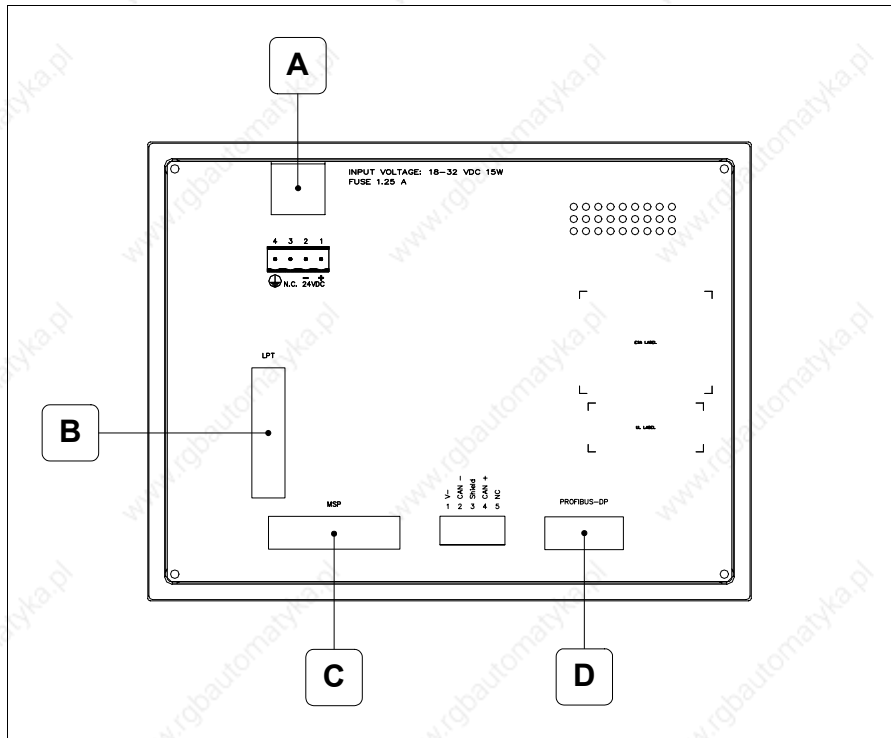

Position	Function
A	Power supply connector
B	LPT port for connecting printer
C	MSP serial port for communicating with PLC/PC
D	Serial port for network communication

CAN series rear view

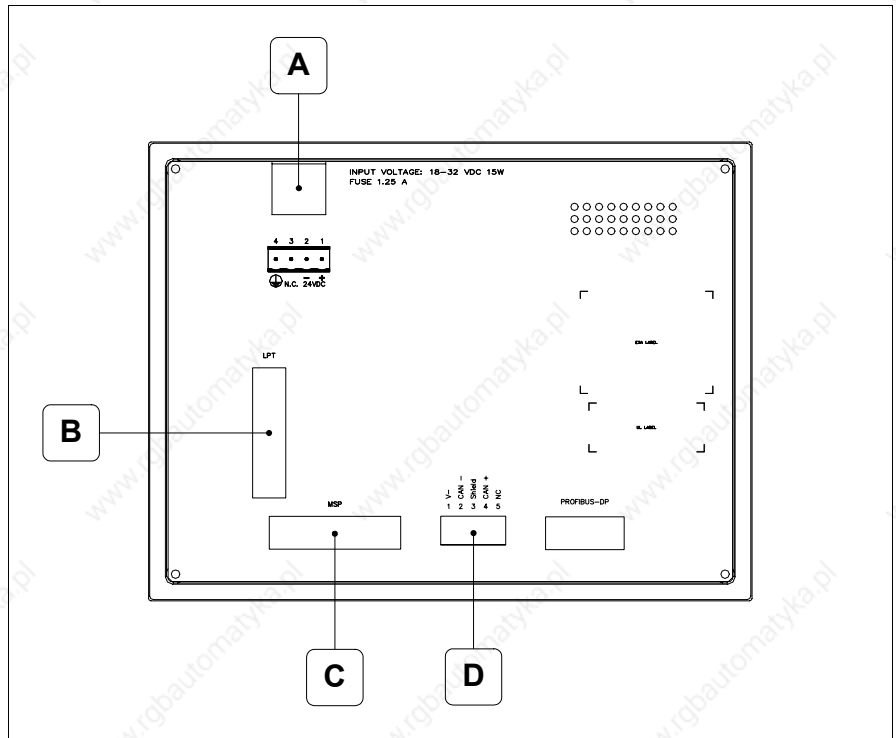

Position	Function
A	Power supply connector
B	LPT port for connecting printer
C	MSP serial port for communicating with PLC/PC
D	CAN serial port

Ethernet series rear view

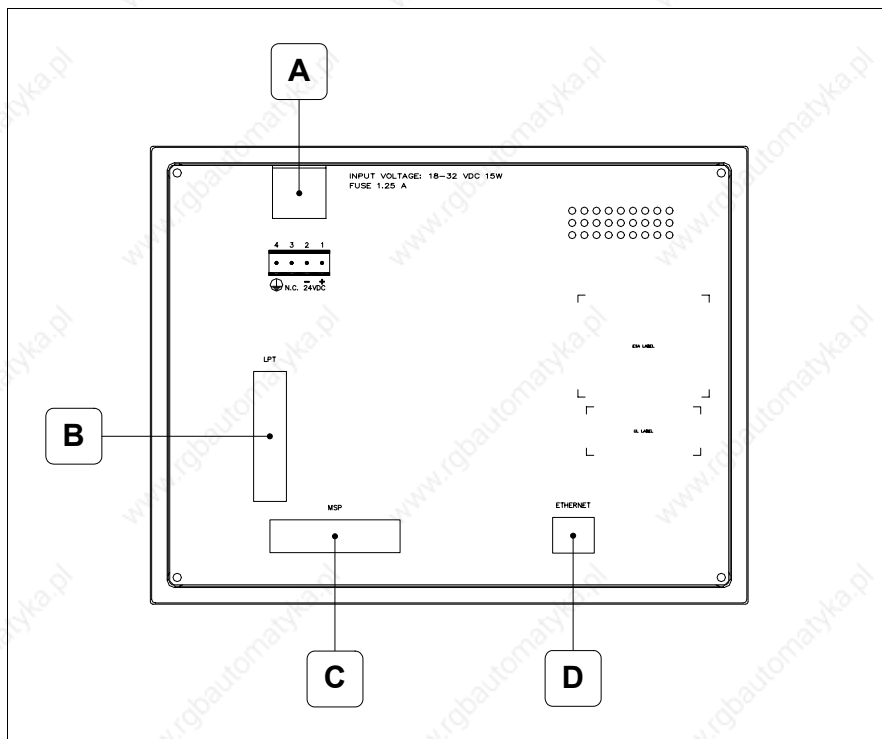

Position	Function
A	Power supply connector
B	LPT port for connecting printer
C	MSP serial port for communicating with PLC/PC
D	Ethernet network 10/100Mbit RJ45 (For the diagnostic mode of the LEDs see "Chapter 30 -> Ethernet port")

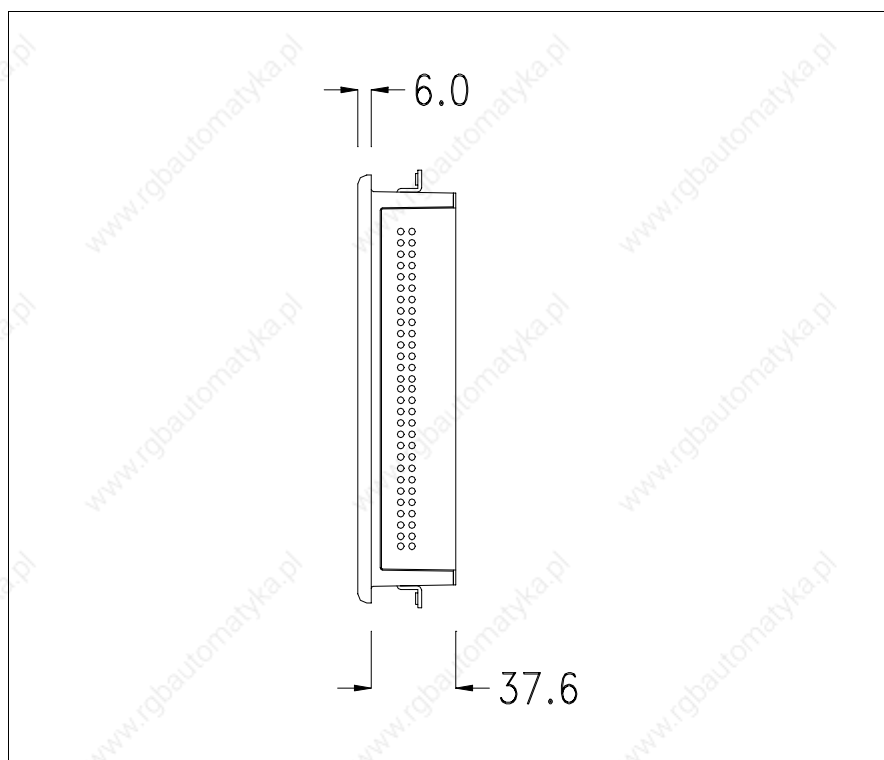
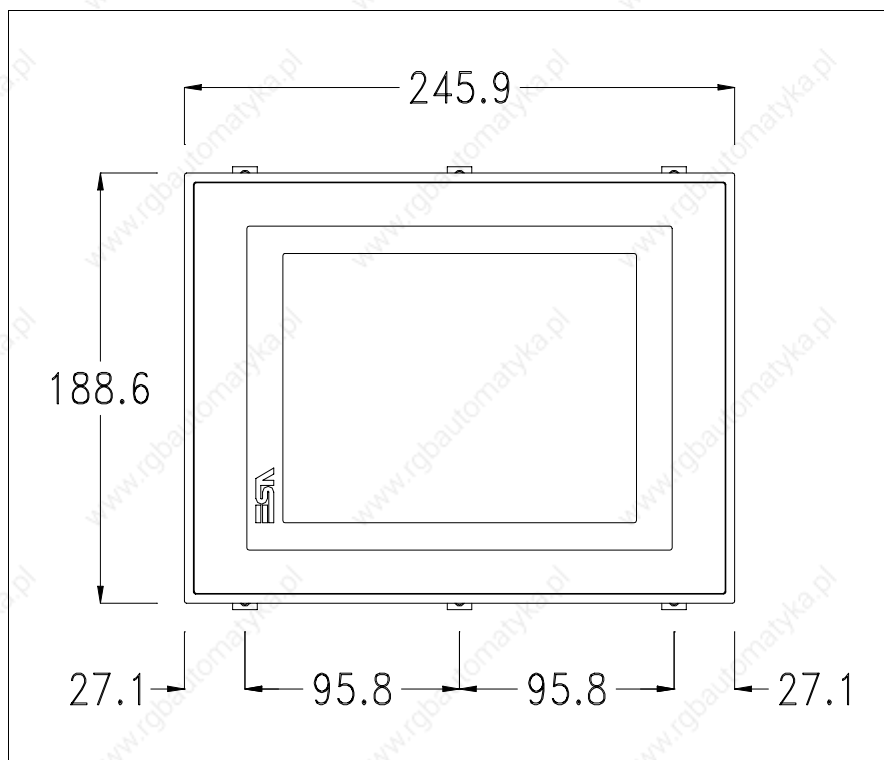
**Dimensions
and Cut-out**

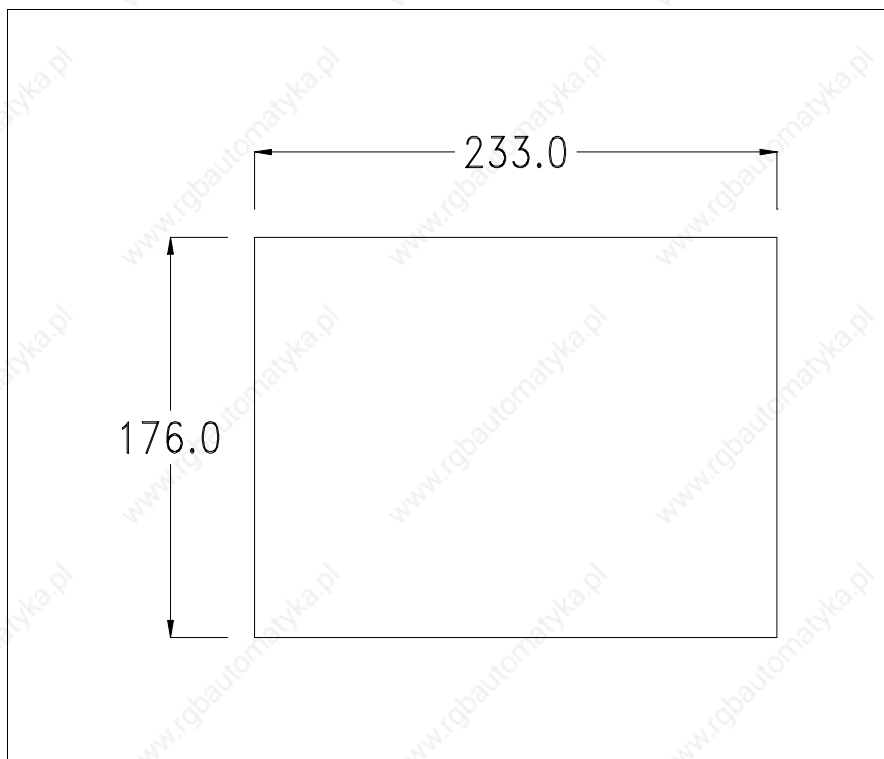

To fix the sealing gasket and secure the VT to the container see “Chapter 29 -> Mounting the terminal within the container“.

⚠ Where accessories need to be fixed in or onto the VT terminal, you are advised to do this before securing the VT to its container.

Accessories

Any accessories should be mounted in accordance with the instructions in the relevant chapter (see “Chapter 33 -> Video terminal accessories“).

Calibration of Touch Screen

The screen of VT575W is made of resistive, sensitive glass; for this type of glass to work properly it requires a calibration procedure (**the terminal is already calibrated when supplied**), that is, the resistive area of the glass has to be adjusted to the visible area of the display.

Should it be thought necessary to repeat the calibration procedure this can be done by following the instructions set out below.

⚠ The procedure must be carried out with great care as the precision of the keys area depends on the calibration.

How to perform the calibration procedure:

- Make sure the VT is not connected to the power supply
- Remove the back cover
- Identify jumper J11

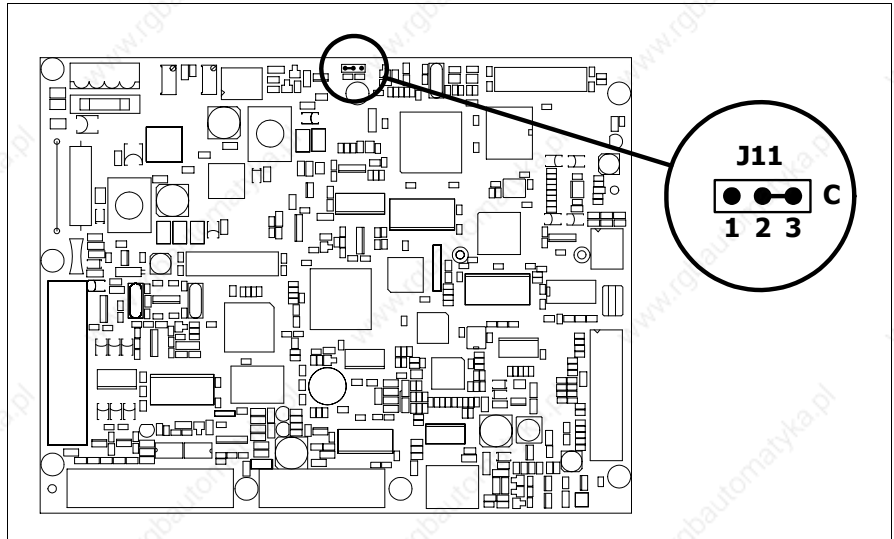

- Position J11 on pins 2-3 (C)
- Reconnect the power supply and switch on the terminal; the following mask appears

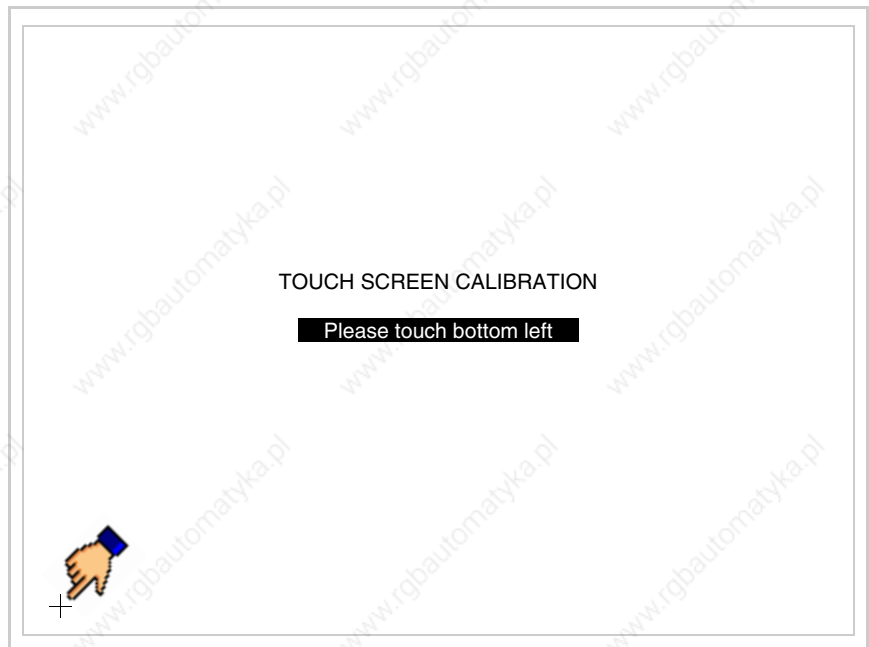

- Touch the corner indicated in the figure; then the following page appears on screen

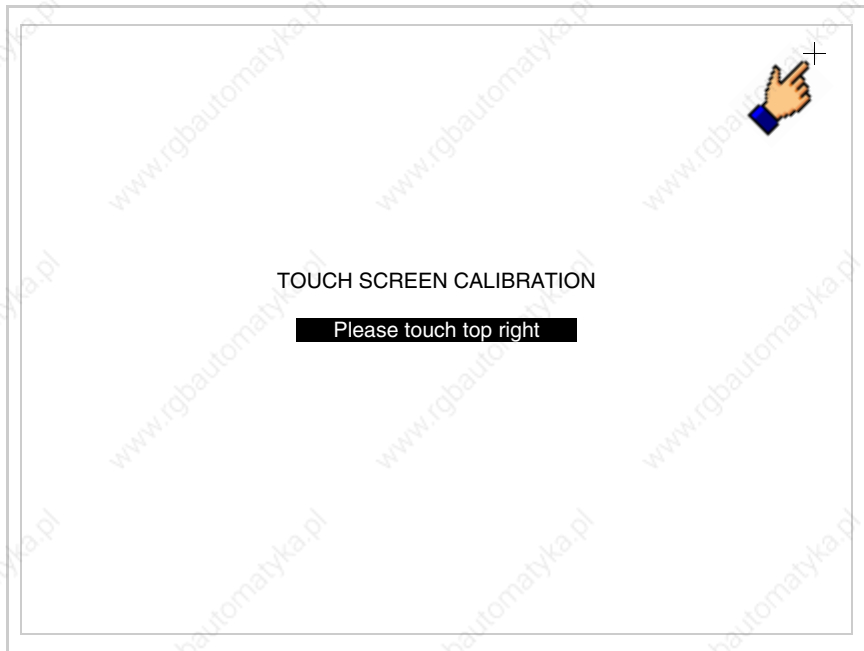

- Touch the corner indicated in the figure to complete the Calibrazione procedure; the following page now appears



- Wait a few moments until the VT displays either the following mask or the project page

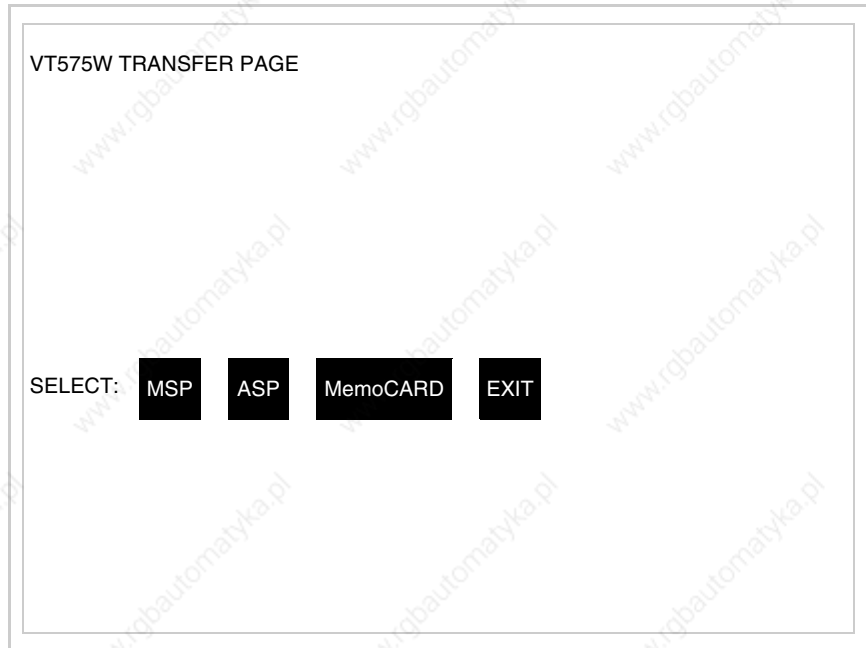

- Switch off the terminal
- Reposition J11 on pins 1-2
- Replace the back cover
- Switch on the terminal again

The calibration procedure has finished; if the calibration has been carried out wrongly or imprecisely, repeat the procedure.

Termination of CAN line

This paragraph applies only to the CAN series. The VT in question integrates the termination resistances of the serial line (typically 120 ohms) which can be inserted by means of a jumper (preset on 1-2, line not terminated). To activate the termination:

- Make sure the device is not connected to the power supply.
- Remove the cover.
- Identify the jumper unit J14.

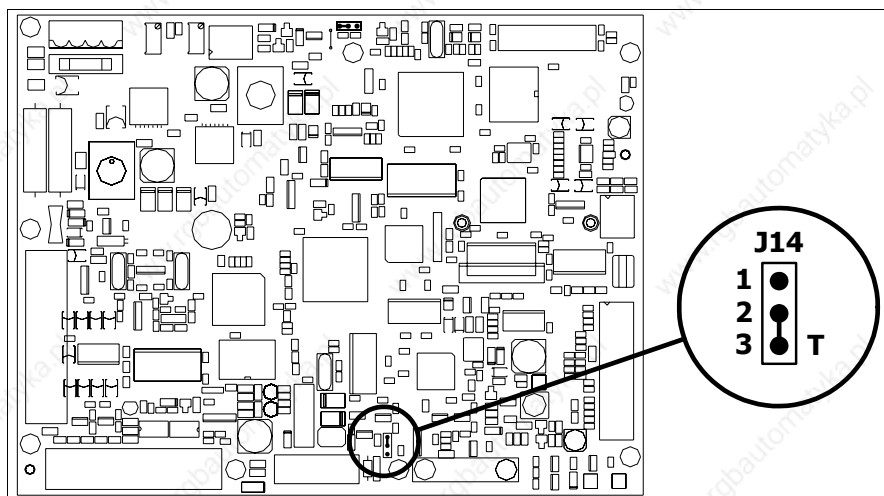

- Position the jumper between pins 2 and 3 (line terminated).
- Replace the back cover.
- Reconnect the power supply.

Introducing the MAC address

This paragraph relates only to the Ethernet series. The Media Access Control (MAC) address unambiguously identifies each terminal connected in the Ethernet network. The terminal is acquired with the address already programmed and is shown on the display of the terminal in the transfer page.

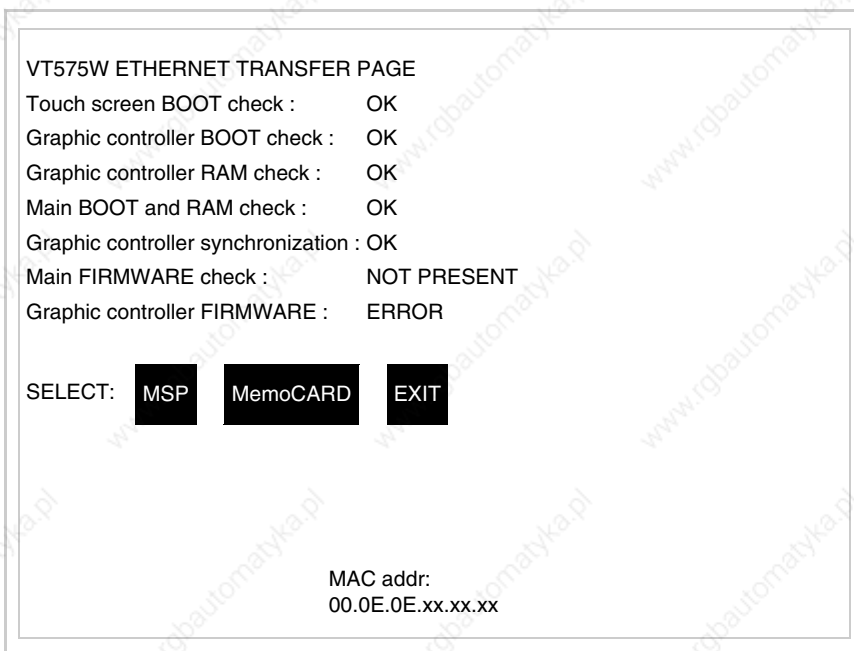

The MAC address is permanently memorized in the terminal, but should it

be necessary to execute an “aided” BOOT update (see Software Manual “Chapter 14 -> BOOT update“) the address is lost.

⚠ This operation must be carried out only with the advice of the ESA Customer Care Department.

Terminals with no valid MAC address when switched present a mask for its insertion. If no MAC address belonging to the terminal is available, proceed as follows:

- Check that the VT is not connected to the power supply.
- Remove the back cover
- Locate the label carrying the MAC address

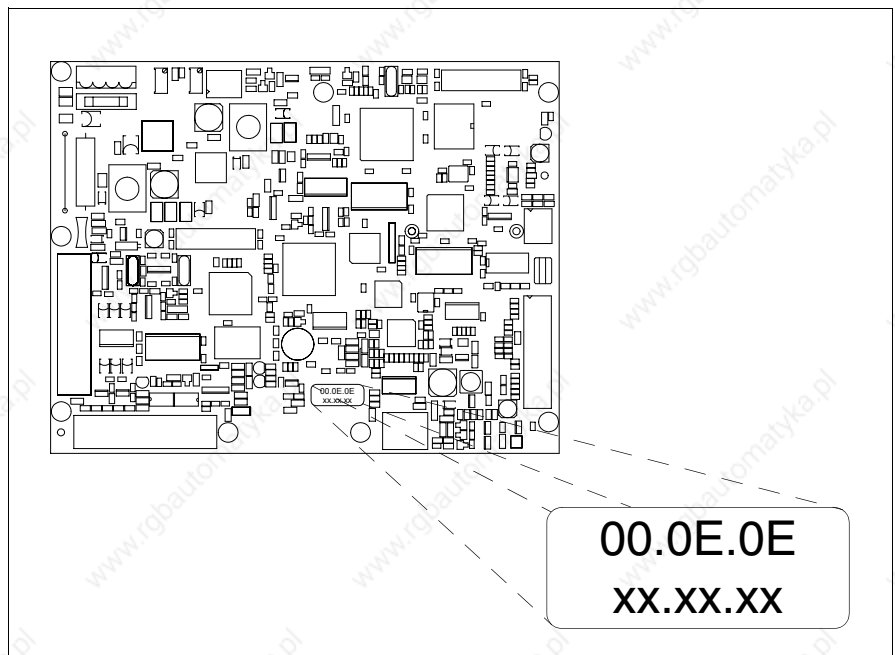

- Make a note of the number on the label (e.g. 00.0E.0E.00.00.01)

00.0E.0E -> fixed part that identifying as an ESA product
 XX.XX.XX -> variable part different for each terminal

- Reconnect the power supply to the terminal and, if necessary, calibrate the touch screen (see Page 23-14)
- Replace the back cover
- Switch on the terminal again
- The following mask appears; introduce the address previously noted down (e.g. 00.0E.0E.00.00.01)

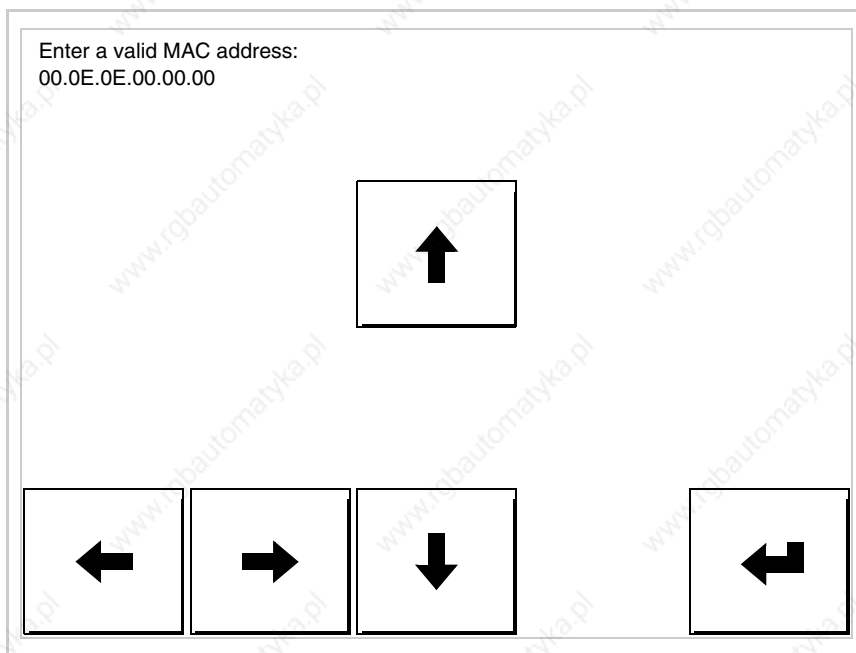

Enter a valid MAC address:
00.0E.0E.00.00.00

↑

← → ↓ ←

- Use the arrow  to make the setting. Once the address has been confirmed the following page is displayed

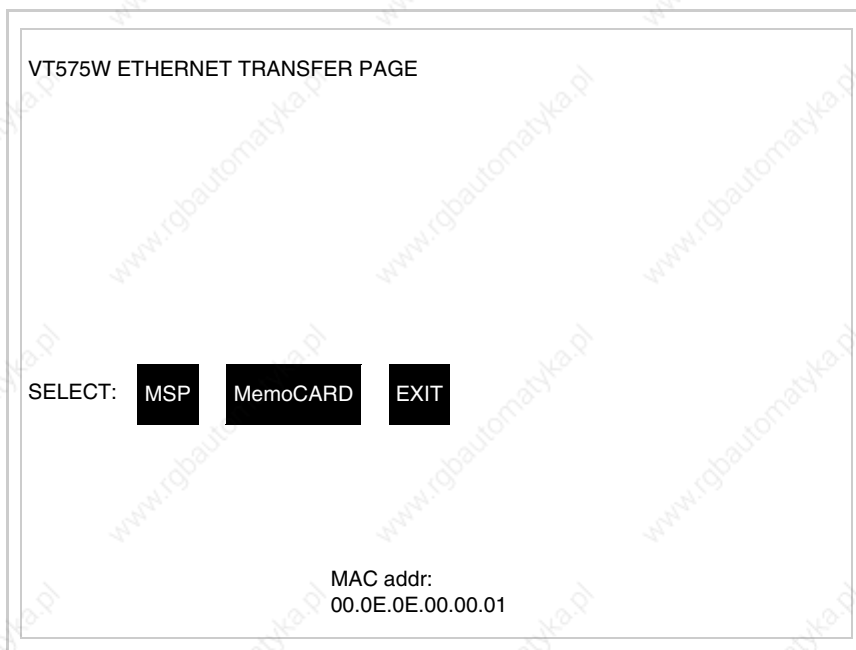

VT575W ETHERNET TRANSFER PAGE

SELECT: **MSP** **MemoCARD** **EXIT**

MAC addr:
00.0E.0E.00.00.01

The procedure is now terminated.



Should a wrong MAC address have been inserted contact the ESA Customer Care Department.

⚠ A wrong address could give rise to an error of conflict between VT terminals in the Ethernet network.

Transfer PC -> VT

For everything to function properly, the first time the VT operator terminal is switched on it needs to be correctly loaded, that is it needs to have transferred to it:

- Firmware
- Communication driver
- Project

(Given that the transfer of the three files in practice occurs with a single operation, it will be defined as “Project transfer” for the sake of simplicity.)

For this it is essential that the VT be prepared to receive the transfer. (See also “Chapter 37 -> Command area”).

Preparation for reception

The programme VTWIN must be used for the transfer (see Software Manual), but the terminal must be prepared for reception.

This means carrying out the following steps:

- Check that the VT is off
- Check that there is a serial connection between the PC and the VT
- Switch on the VT and wait for the following mask to appear
- Press one after the other two diagonally opposite corners free of settable objects or buttons (at least one corner needs to be free)

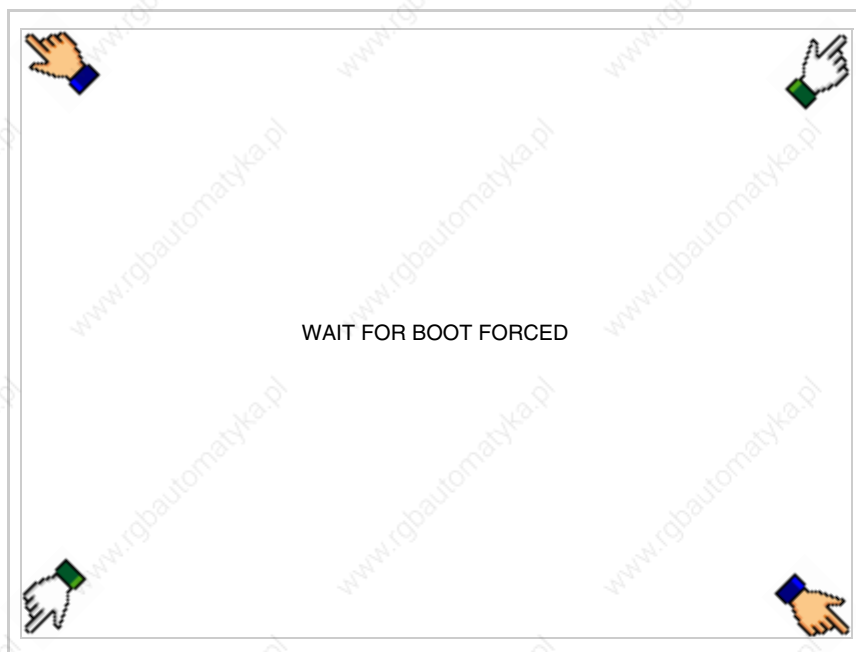

and wait a few moments, alternatively use the button provided (see Page 23-21), until the VT displays the following mask

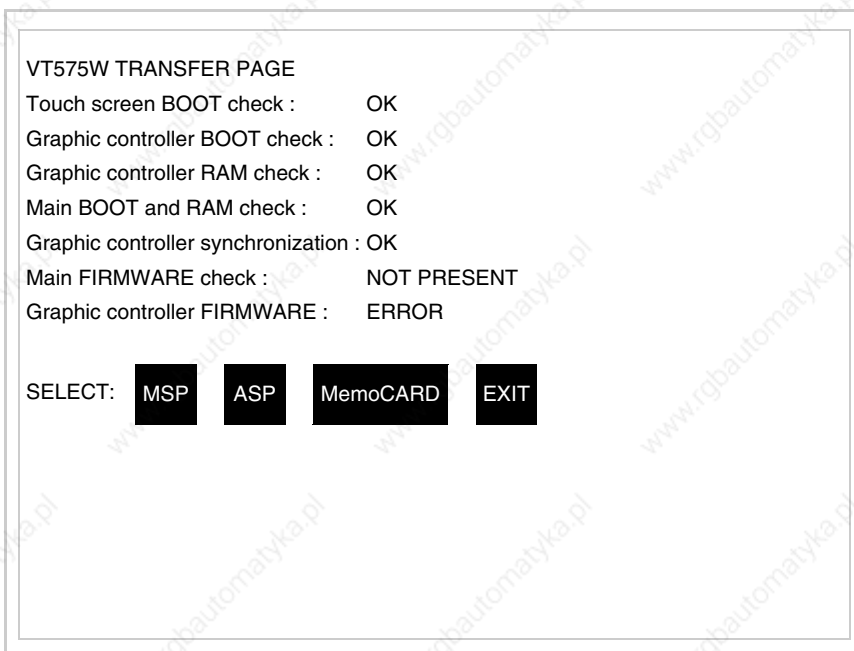

- Choose the port you intend to use for the transfer (MSP or ASP); touch the relevant on the display. The VT is now ready to receive (refer to Software Manual for transfer procedure). The MemoCARD appears if the Memory Card has been inserted in the VT (see Page 23-27)

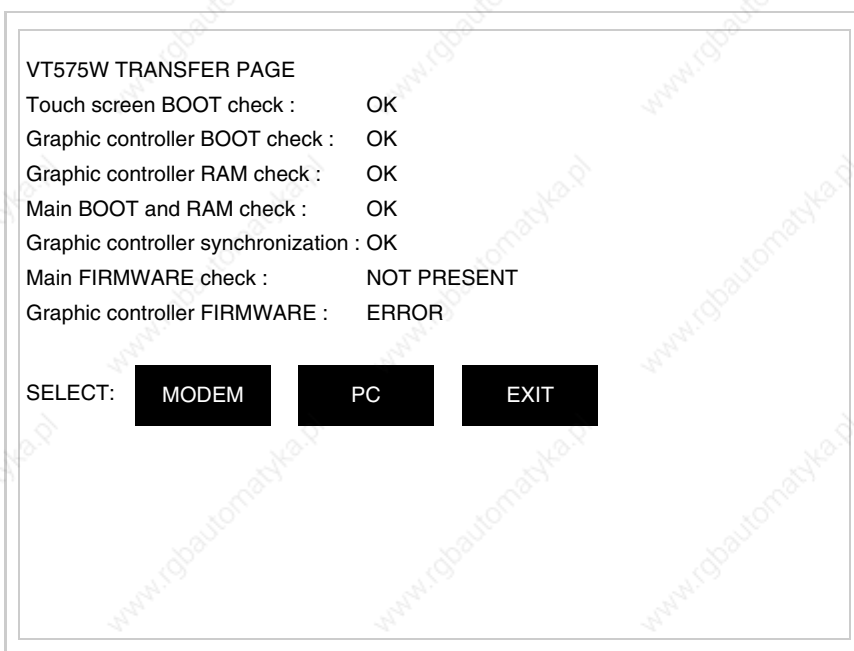

- Choose the required transfer mode: MODEM if you intend to use a modem or PC if you intend to use a serial port; touch the relevant on the display

If the choose made is PC, the VT is ready to receive (see Software Manual for transfer), if, on the other hand, you choose MODEM, the following mask will appear

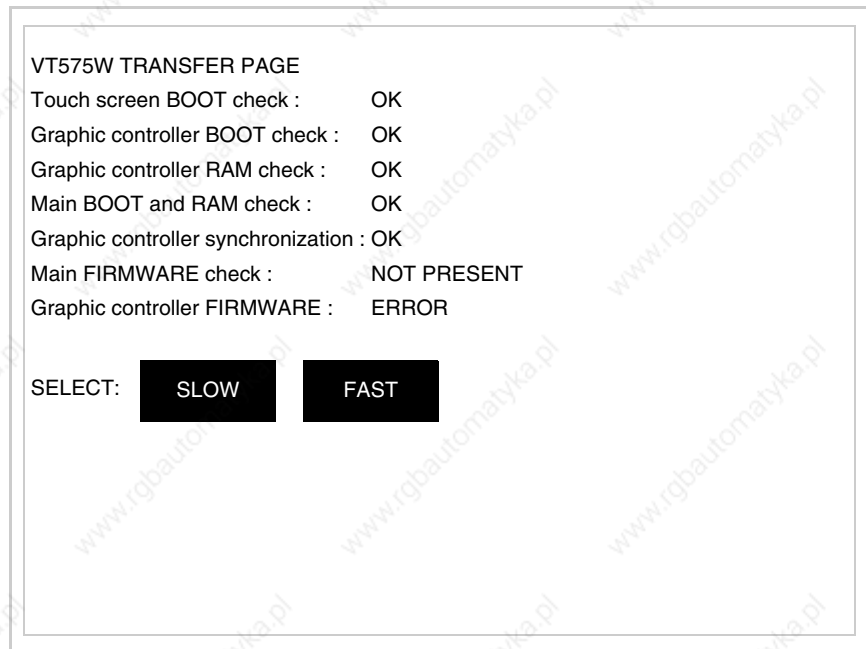

The choice should be according to the speed you intend to use for the transfer (Slow=9600bit/sec or Fast=38400bit/sec), touch the relevant on the display. The VT is now ready to receive (see Software Manual for the transfer).

Information relating to driver

After the project has been transferred, the VT can make available information relating to what has been loaded. The information regards:

- Serial ports present
- The name of the driver loaded
- The version of the driver loaded
- Network address of the VT
- Last error to have occurred

To acquire this information carry out the following operations:

- Be situated in any page of the project
- Press two diagonally opposed angles that are free of any settable objects

or buttons (at least one angle must be free)



and you will see



There is one of these pages for each communication port; movement between the various pages is effected by pressing .

From this page you can:

- Set the clock and the contrast
- Prepare the VT to receive the program
- Use the Memory Card

Setting the clock and the contrast:

To set the clock and the contrast, while displaying the above illustrated page, press ; the following mask appears

The image shows a rectangular display area with a thin border. Inside, there are two separate rectangular boxes, one above the other. The top box contains the text "SET CONTRAST : ±##". The bottom box contains the text "SET CLOCK :
ddd,dd/mm/yy
hh:mm:ss". In the bottom right corner of the display area, there is a small square button labeled "ESC".

To set the contrast touch the words SET CONTRAST on the display; you will see the following mask



Use the arrow  for any variation (see "Chapter 36 -> Operation of terminal with touch screen").

To set the clock touch the words SET CLOCK on the display; the following mask appears

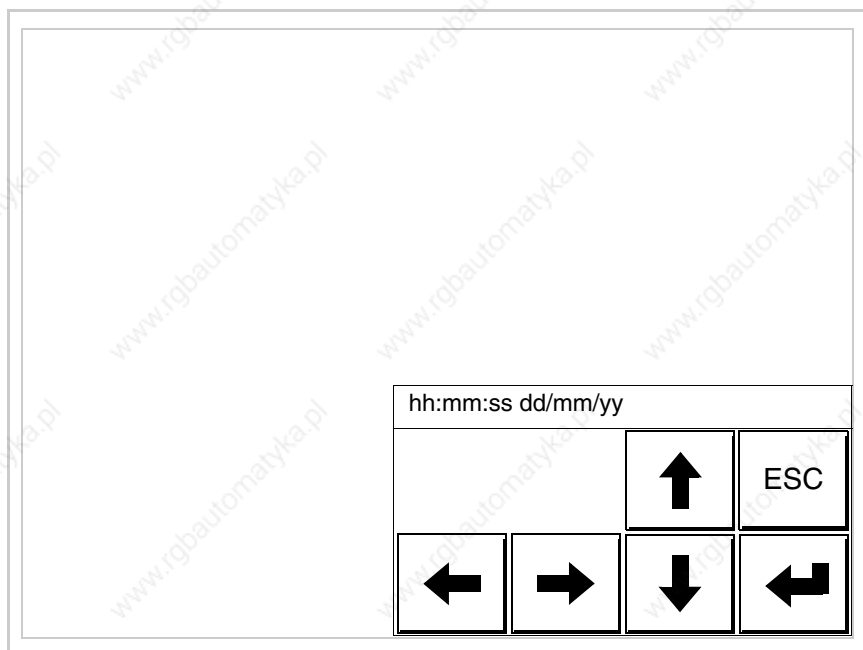

Use the arrow  for any variation (see “Chapter 36 -> Operation of terminal with touch screen”).

Prepare the VT to receive the program:

To prepare the VT to receive the program, while displaying the driver information page (see Page 23-23), press , and you will see the following mask

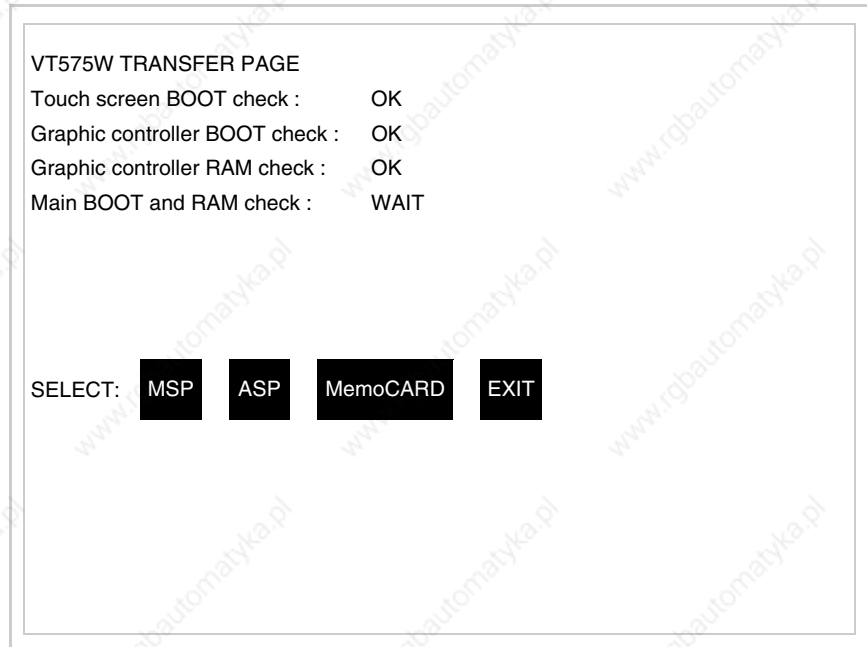

The on-screen  to press depends on the port you intend to use (MSP or ASP). The VT terminal is now ready to receive (consult Software Manual for information on the transmission procedure).

Using the Memory Card:

While displaying the driver information page, press  and the following mask will appear:

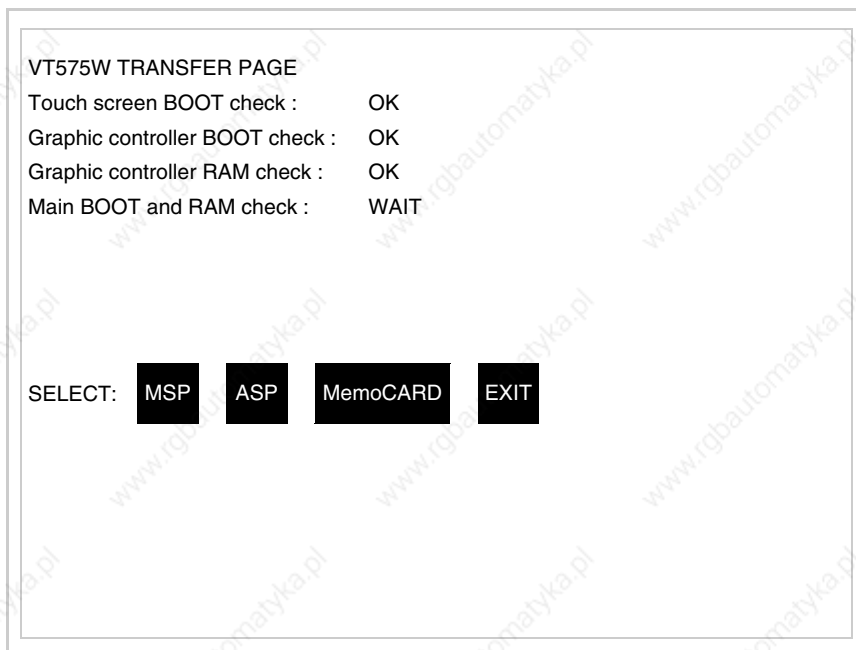

Touch the MemoCARD on the screen (if the key is not on screen, see Page 23-21) and the following mask will appear:

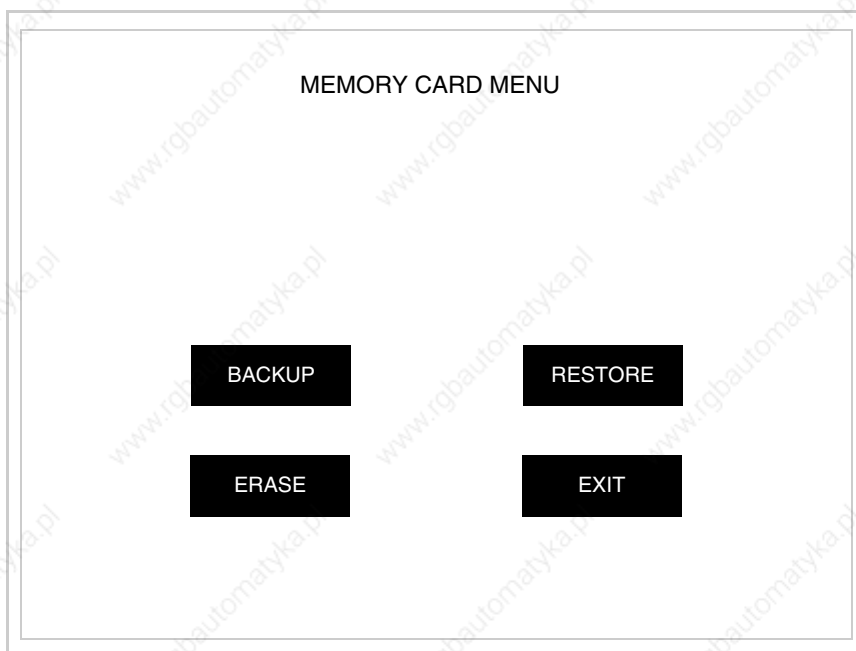

For the meaning and the functions of the keys see "Chapter 33 -> Memory card".

Possible error messages that may be encountered in the driver information page are:

- PR ERR

Problem-> Errors have been detected in the data exchange between the VT and the Device.

Solution-> Check the cable; there may be disturbance.

- COM BROKEN

Problem-> Communication between VT and Device interrupted.

Solution-> Check the serial connection cable.

An error message followed by [*] indicates that the error is not currently present but was and has since disappeared.

Example: COM BROKEN*

When  is pressed you quit the display of information regarding the driver.

Improving display color quality

To improve the color quality, adjust the contrast of the display: if the colors are too dark increase the contrast; if, on the other hand, the colors are too light, decrease the contrast.

Adjusting the contrast on the display

To improve the quality of the representation on the display it may be necessary to adjust its contrast. This can be done by going to the page proposed (see Page 23-25) and changing the value (from +63 to -64) in evidence at that moment. Increase the value to darken the display; to lighten it decrease the value.

We advise this to be done at typical room temperature and with the terminal at operating temperature (about 30 minutes after switching on and with the screen saver disabled - see Software Manual).

Chapter 24 Video terminal VT580W

Contents	Page
Technical characteristics	24-2
Functions	24-4
Front view	24-8
Standard series rear view	24-9
Profibus-DP series rear view	24-10
CAN series rear view	24-11
Ethernet series rear view	24-12
Dimensions and Cut-out	24-13
Accessories	24-14
Calibration of Touch Screen	24-14
Termination of CAN line	24-17
Introducing the MAC address	24-18
Transfer PC -> VT	24-21
Preparation for reception	24-21
Information relating to driver	24-23
Improving display color quality	24-29
Adjusting the contrast on the display	24-29

This chapter consists of 30 pages.



Technical characteristics The following table lists the principal technical characteristics of the product in question.

Code of terminal		Characteristics of the terminal			
VT580W APS00					
VT580W 0PSDP					
VT580W 0PSCN					
VT580W 0PSET					
Display					
Type	LCD Monochromatic STN				
	LCD 256 Colors STN				
	LCD 256 Colors TFT	●	●	●	●
Touch screen [cells]	Matrix 50x40 (Cell:16x15 pixels)	●	●	●	●
Representational format	Graphic	●	●	●	●
Resolution [pixels]	800 x 600 (8,4")	●	●	●	●
Rows per character	40 x 100 / 20 x 50 / 10 x 25	●	●	●	●
Dimension of visible area [mm]	174,8 x 131,2	●	●	●	●
Character matrix in text mode [pixels]	8 x 15 / 16 x 30 / 32 x 60	●	●	●	●
Character size [mm] x1 / x2 / x4	1,7 x 3,2 / 3,4 x 6,4 / 6,8 x 12,8	●	●	●	●
Contrast adjustment	Software	●	●	●	●
	Automatic compensation with temperature	●	●	●	●
Character set	Programmable fonts/TTF Windows ®	●	●	●	●
Backlighting					
Type	LED				
	CCFL lamp	●	●	●	●
Minimum lamp-life at 25°C [hours]	50000	●	●	●	●

Code of terminal	Characteristics of the terminal			
VT580W APS00				
VT580W 0PSPD				
VT580W 0PSCN				
VT580W 0PSET				
User memory				
Project [Bytes]	960K + 6M (Text + Graphic)	●	●	●
Data memory [Bytes]	128K (Flash EPROM)	●	●	●
Memory for Windows ® -based fonts [Byte]	512K	●	●	●
Memory Card for backup	8Mb	●	●	●
Memory Card for expansion	4Mb (Only for graphic type)			
Interfaces				
MSP (Multi-serial port)	RS232/RS422/RS485/TTY-20mA	●	●	●
ASP (Auxiliary serial port)	RS232/RS485			●
ASP-15L (Auxiliary serial port)	RS232/RS485			
ASP-8 (Auxiliary serial port)	RS232			
ASP-9 (Auxiliary serial port)	RS232			
LPT parallel port	Centronics	●	●	●
Auxiliary port	Connection for accessory devices			
Accessories				
Connectable accessories	See table "Chapter 33"	●	●	●
Clock				
Clock	Hardware (with Supercapacitor - Min.72h Typically130h)	●	●	●
Networks				
Integrated	Profibus-DP			●
	CAN Open (Optoisolated interface)		●	
	Ethernet 10/100Mbit RJ45	●		
Universal Bus Connector	--			
Optional	See table "Chapter 33"	●	●	●
Proprietary networks				
ESA-Net	Network server	●	●	●
	Network client	●	●	●
Technical data				
Power supply	24Vdc (18..32Vdc)			
Power absorbed at 24Vdc	15W			
Protection fuse	Ø5x20mm - 1,25A Quick Blow F			
Protection level	IP65 (front-end)			
Operating temperature	0..50°C			
Storage and transportation temperature	-20..+60°C			
Humidity (non-condensing)	<85%			
Weight	1500gr			
Dimensions				
External W x H x D [mm]	245,9 x 188,6 x 37,6			
Cut-out W x H [mm]	233 x 176			
Certification				
Certifications and approvals	CE, cULus, NEMA12			

Functions

The following table lists in alphabetical order all the functions of the VT in question.

Table 24.1: Functions and objects realizable with this VT (Part 1 of 4)

Code of terminal		
VT580W *****		
Objects/Functions	Quantity	▼
Alarm field		●
Alarm help	1024	●
Alarm history buffer	256	●
Alarm statistics		
Alarms (Total/active simultaneously)	1024/256	●
Arc		●
Automatic operations	32	●
Backup/Restore		●
Bar data		●
Bit-wise password	8bits	●
Buttons	1200xpage	●
Circles		●
Command: Change language		●
Command: Clear trend buffer		●
Command: Delete recipe		●
Command: Hardcopy		●
Command: Load recipe from data memory		●
Command: Modify password		●
Command: Next page		●
Command: Page help		●
Command: Password login		●
Command: Password logout		●
Command: Previous page		●
Command: Print alarm history		●
Command: Printer form feed		●
Command: Quit project		●
Command: Report		●
Command: Restarts reading time-sampled trend		●
Command: Run pipeline		●
Command: Save alarms history and trend buffers in flash		●
Command: Save recipe in data memory		●
Command: Save recipe received from device in buffer		●
Command: Save recipe received from device in data memory		●
Command: Send recipe from video buffer to device		●
Command: Send recipe to device		●
Command: Service page		●

Unless otherwise stated, there is no limit to the number of includable elements, only the size of project memory sets a limit.
*) indicative value determined by the dimensions of the project, **) depends on memory available

Table 24.1: Functions and objects realizable with this VT (Part 2 of 4)

Code of terminal		
VT580W *****		
Objects/Functions	Quantity	▼
Command: Show alarms history		●
Command: Show page directory		●
Command: Show project information		●
Command: Show recipe directory		●
Command: Show sequence directory		
Command: Shows driver status page		●
Command: Shows page help		●
Command: Shows page with function: PG		
Command: Stops reading time sampled trend		●
Command: Trend reading saved in device		●
Command: Zero number of general pages		●
Date field		●
Day-of-the-week field		●
Dynamic texts: Bit-group-structured dynamic texts		●
Dynamic texts: Single-bit dynamic texts	1024*	●
Dynamic texts: Value-structured dynamic texts		●
E-keys		
Equations	32	●
F-keys		
Free terminal		
Function: Disables key		
Function: Go to page		●
Function: Internal command		●
Function: Invert bit value		●
Function: Macro		●
Function: None		
Function: Reset bit permanently		●
Function: Reset real-time bit		●
Function: Sequences		
Function: Sets bit permanently		●
Function: Sets real-time bit		●
Function: Value-structure direct command		●
Global configuration of E-keys		
Global configuration of F-keys		
Headers and footers (Total/Number of fields per H-F)	128/128	●
Info-messages (Total/active simultaneously)	1024/256	●
Internal registers	4096bytes	●
Labels		●
LEDs assigned to sequence		

Unless otherwise stated, there is no limit to the number of includable elements, only the size of project memory sets a limit.
 *) indicative value determined by the dimensions of the project, **) depends on memory available

Table 24.1: Functions and objects realizable with this VT (Part 3 of 4)

Code of terminal		
VT580W *****		
Objects/Functions	Quantity	▼
Lines		●
Lists of bitmap images		●
Lists of texts		●
Local configuration of E-keys		
Local configuration of F-keys		
Macro field		
Macros (Total/Commands x macro)	1024/16	●
Message field		●
Message help	1024	●
Multilanguage texts	8 Langs.	●
Object - Indicator	128	●
Object - Potentiometer knob	128	●
Object - Selector knob	128	●
Object - Sliding potentiometer	128	●
Object - Sliding selector	128	●
Page	1024	●
Page help	1024	●
Password	10	●
Pipelines (Number/Tot bytes)	64/512	●
Print		●
Print page (Total/Number of fields per page)	1024/128	●
Programmable fonts		●
Project images		●
Public variables of ESANET network (Number/Total bytes)	512/1024	●
Recipe field for recipe structure		●
Recipes (Number of variables per recipe)	1024/512	●
Rectangles		●
Redefinable characters		
Reports	128	●
Sequences - Random		
Sequences - Start/stop		
Static bitmaps		●
Symbolic field: Bit-group-structured dynamic bitmaps	1024*	●
Symbolic field: Single-bit-structured dynamic bitmaps		●
Symbolic field: Value-structured dynamic bitmaps		●
System messages		●
System variables assigned to recipe structure		●
Time long field		●
Time short field		●

Unless otherwise stated, there is no limit to the number of includable elements, only the size of project memory sets a limit.
*) indicative value determined by the dimensions of the project, **) depends on memory available

Table 24.1: Functions and objects realizable with this VT (Part 4 of 4)

Code of terminal		
VT580W ****		
Objects/Functions	Quantity	▼
Timer	32	●
Touch Area	256	●
Trend buffers	128	●
Trends (Trends x page/Channels x trend)	8/8	●
Trends sampled automatically (Memory/Trends/Readings)	6144bytes /**/480	●
Trends sampled on command (Memory/Trends/Readings)		●
Value direct command: ADD		●
Value direct command: AND		●
Value direct command: OR		●
Value direct command: SET		●
Value direct command: SUBTRACT		●
Value direct command: XOR		●
Variables: Limit values and linear scaling variables	256 x pages	●
Variables: Movement variable (Mobile symbolic field)		●
Variables: Threshold variables		●
Variables: Floating Point numerical variables		●
Variables: Numerical variables (DEC, HEX, BIN, BCD)		●
Variables: String variables (ASCII)		●

Unless otherwise stated, there is no limit to the number of includable elements, only the size of project memory sets a limit.
 *) indicative value determined by the dimensions of the project, **) depends on memory available

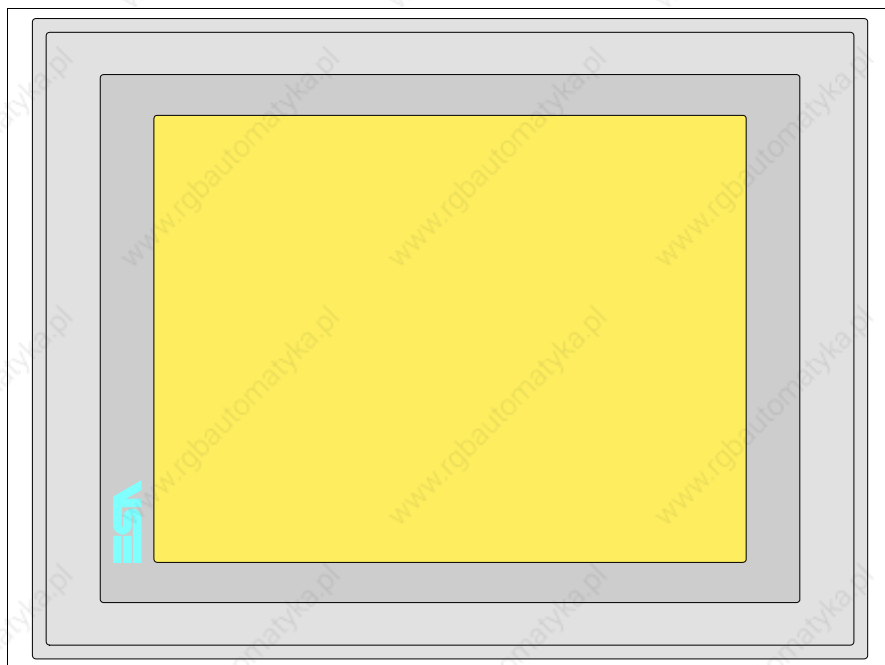
Front view

All buttons and signals are defined via the programming software (see Software Manual).

Standard series rear view

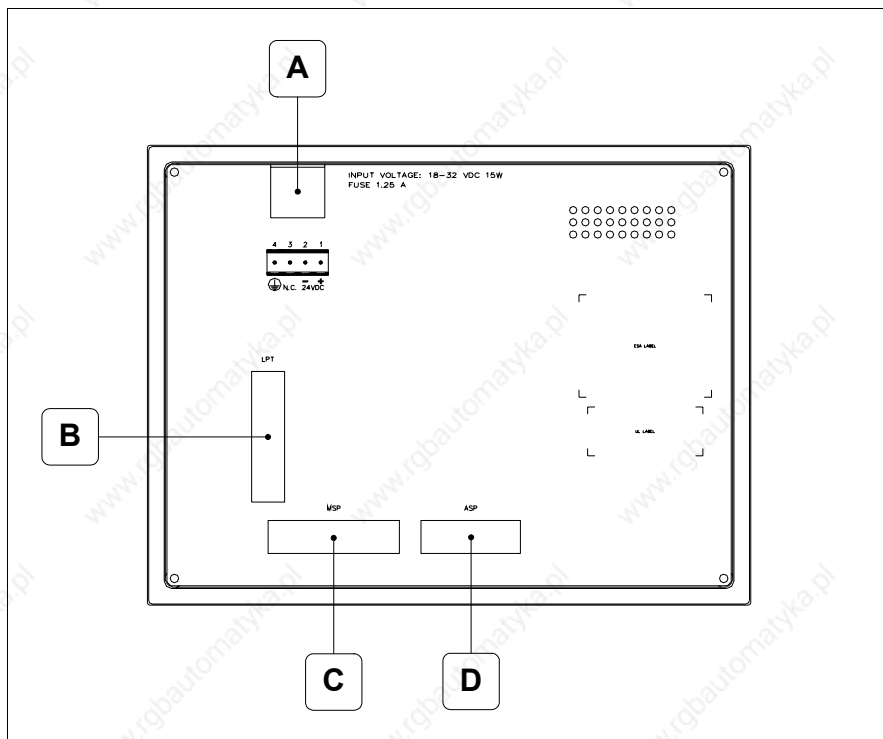

Position	Function
A	Power supply connector
B	LPT port for connecting printer
C	MSP serial port for communicating with PLC/PC
D	ASP serial port for communicating with PC or other devices

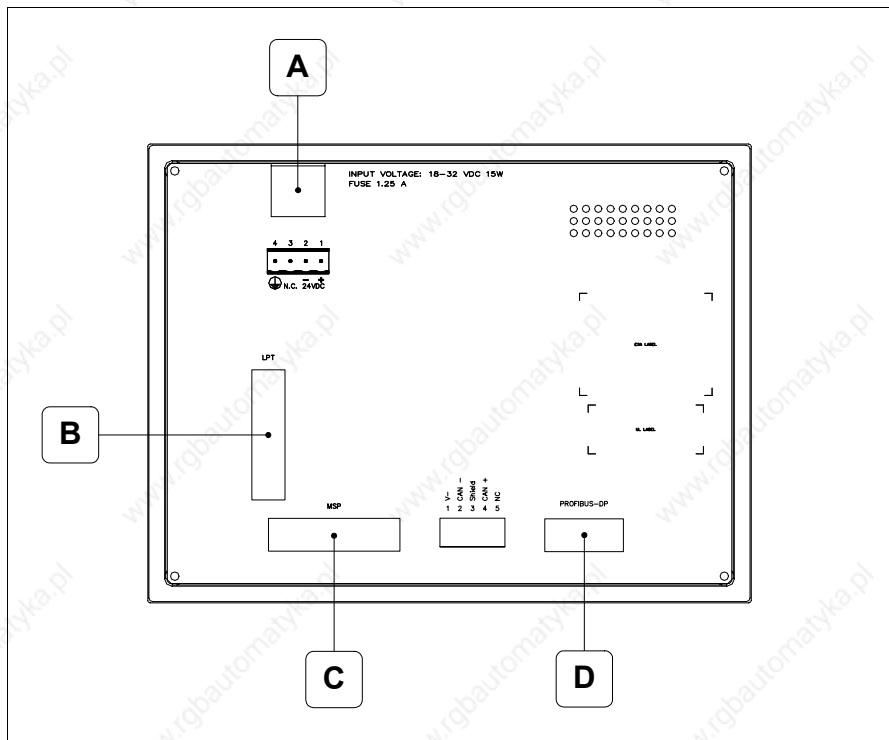
**Profibus-DP
series rear
view**

Position	Function
A	Power supply connector
B	LPT port for connecting printer
C	MSP serial port for communicating with PLC/PC
D	Serial port for network communication

CAN series rear view

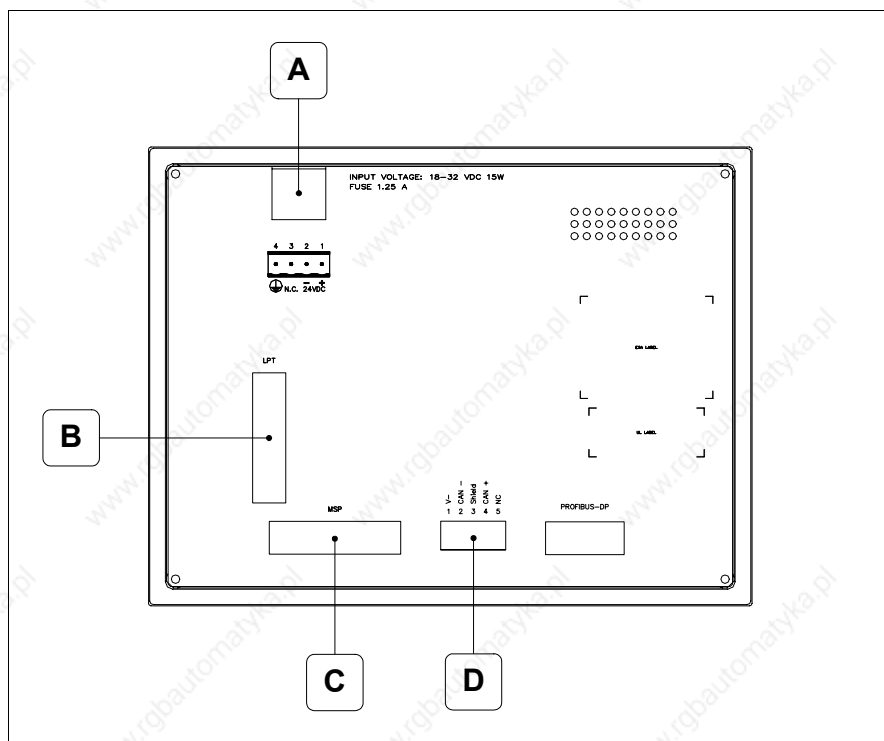

Position	Function
A	Power supply connector
B	LPT port for connecting printer
C	MSP serial port for communicating with PLC/PC
D	CAN serial port

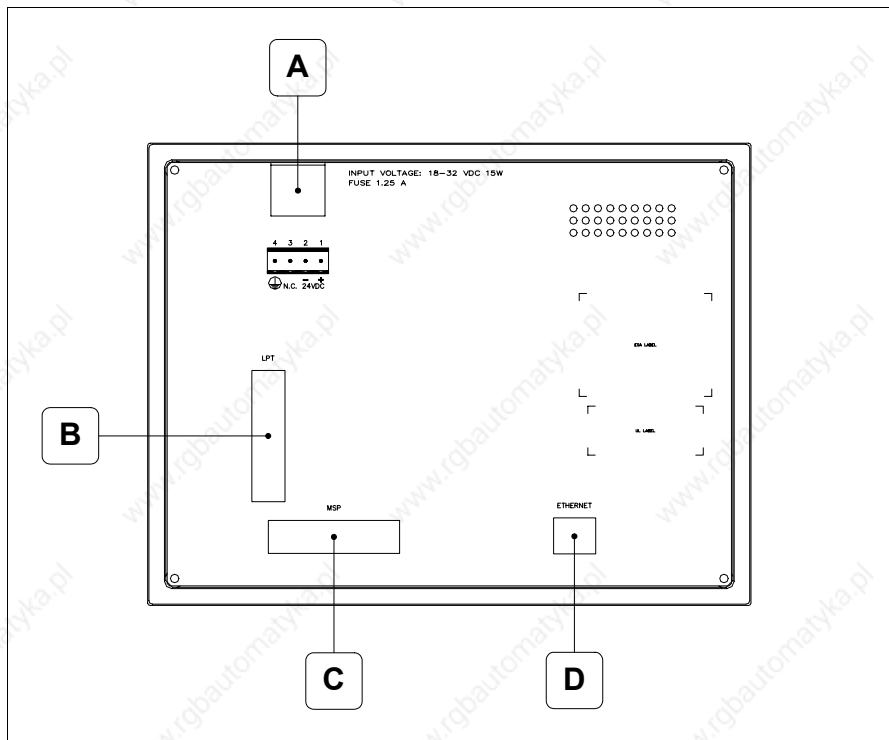
Ethernet
series rear
view

Position	Function
A	Power supply connector
B	LPT port for connecting printer
C	MSP serial port for communicating with PLC/PC
D	Ethernet network 10/100Mbit RJ45 (For the diagnostic mode of the LEDs see "Chapter 30 -> Ethernet port")

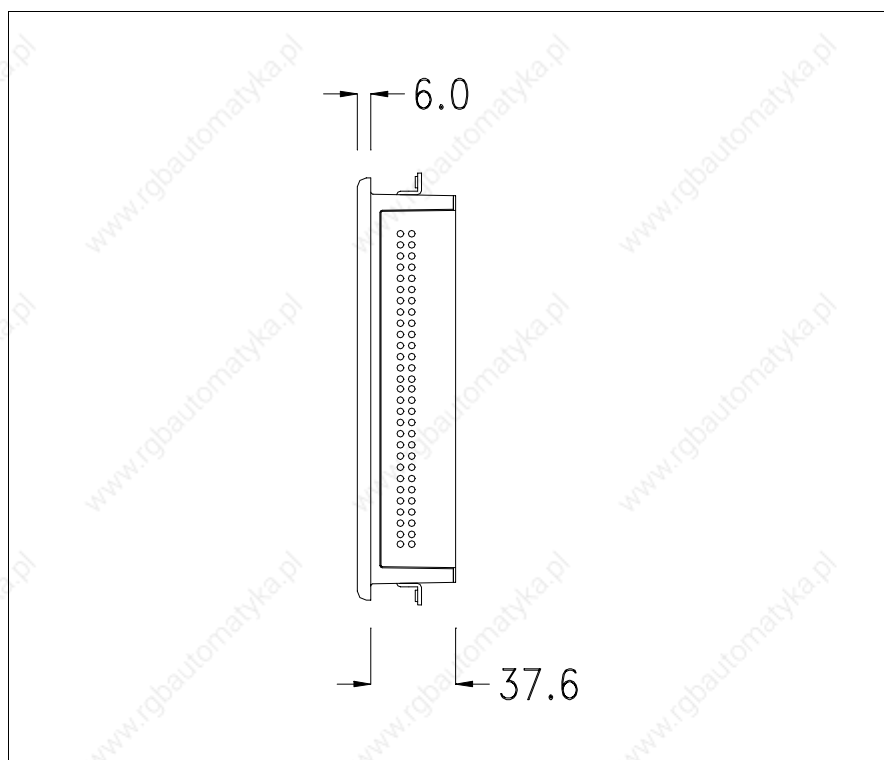
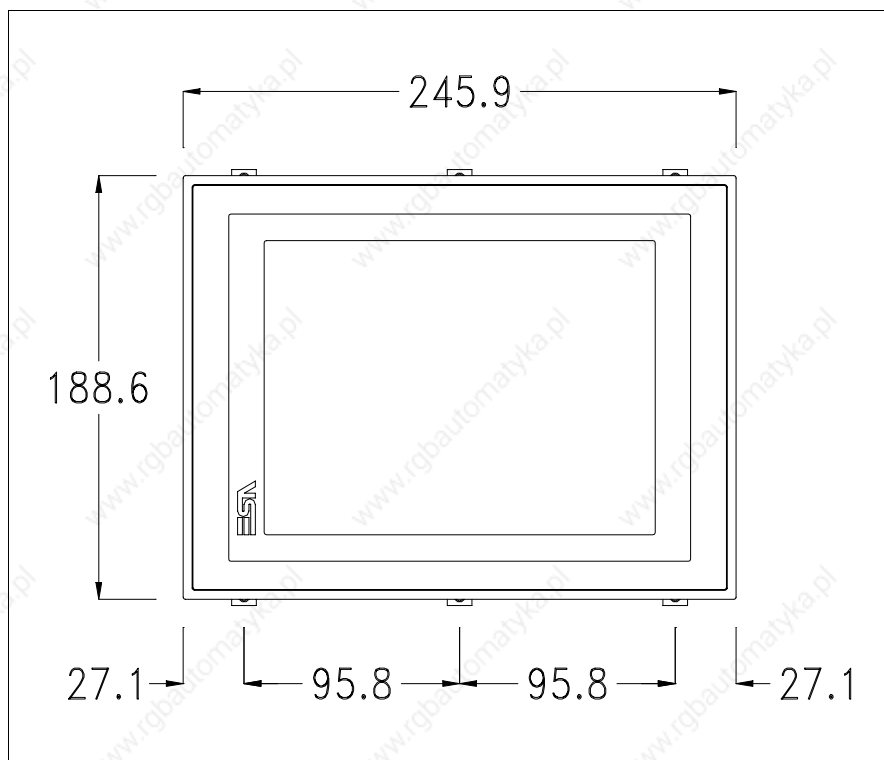
**Dimensions
and Cut-out**

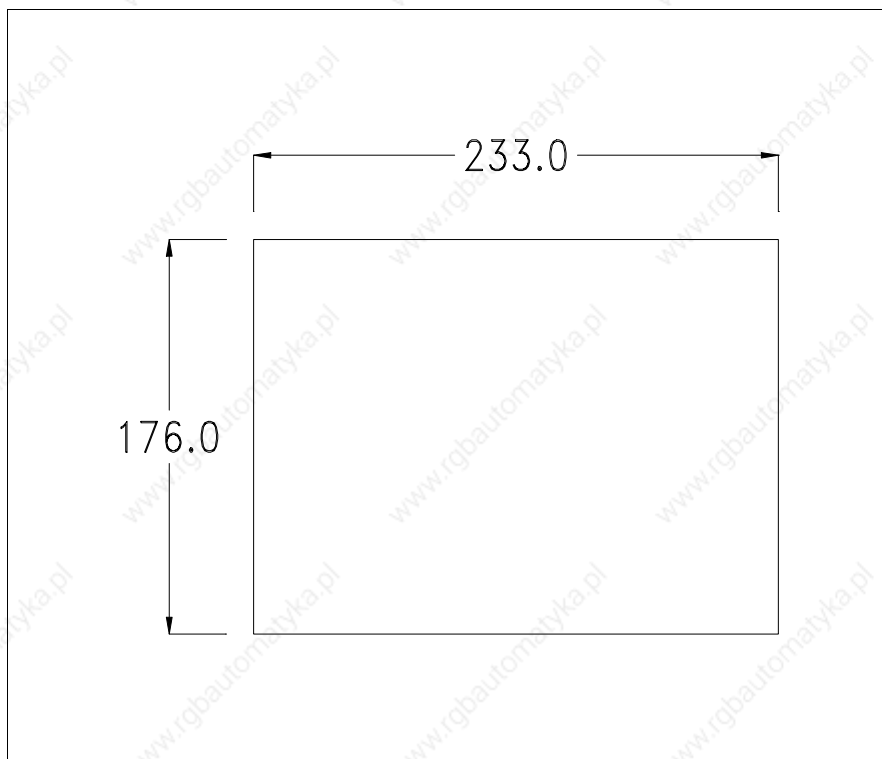

To fix the sealing gasket and secure the VT to the container see “Chapter 29 -> Mounting the terminal within the container“.

⚠ Where accessories need to be fixed in or onto the VT terminal, you are advised to do this before securing the VT to its container.

Accessories

Any accessories should be mounted in accordance with the instructions in the relevant chapter (see “Chapter 33 -> Video terminal accessories“).

Calibration of Touch Screen

The screen of VT580W is made of resistive, sensitive glass; for this type of glass to work properly it requires a calibration procedure (**the terminal is already calibrated when supplied**), that is, the resistive area of the glass has to be adjusted to the visible area of the display.

Should it be thought necessary to repeat the calibration procedure this can be done by following the instructions set out below.

⚠ The procedure must be carried out with great care as the precision of the keys area depends on the calibration.

How to perform the calibration procedure:

- Make sure the VT is not connected to the power supply
- Remove the back cover
- Identify jumper J11

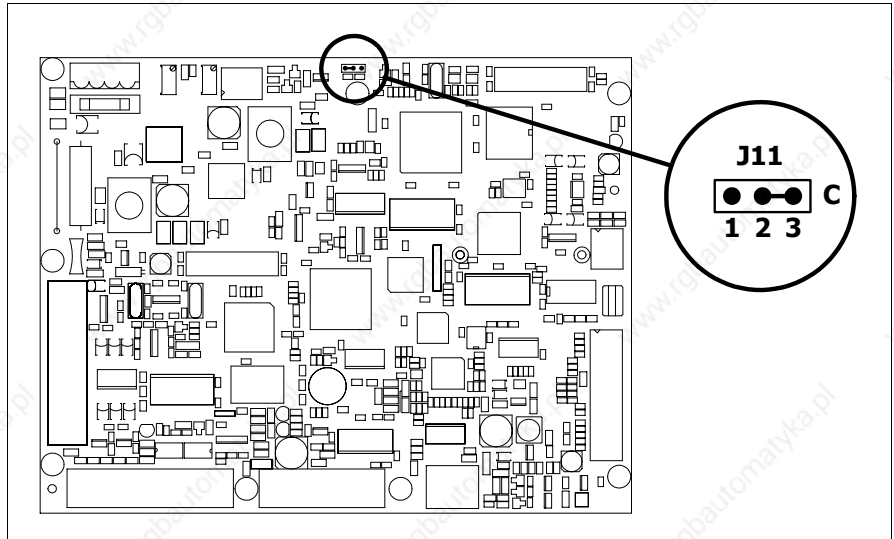

- Position J11 on pins 2-3 (C)
- Reconnect the power supply and switch on the terminal; the following mask appears

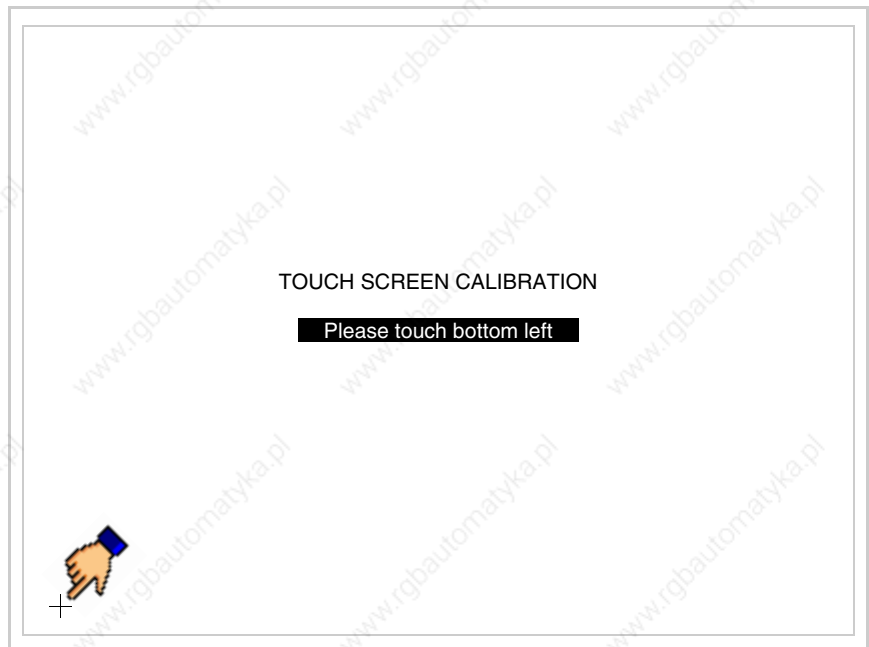

- Touch the corner indicated in the figure; then the following page appears on screen

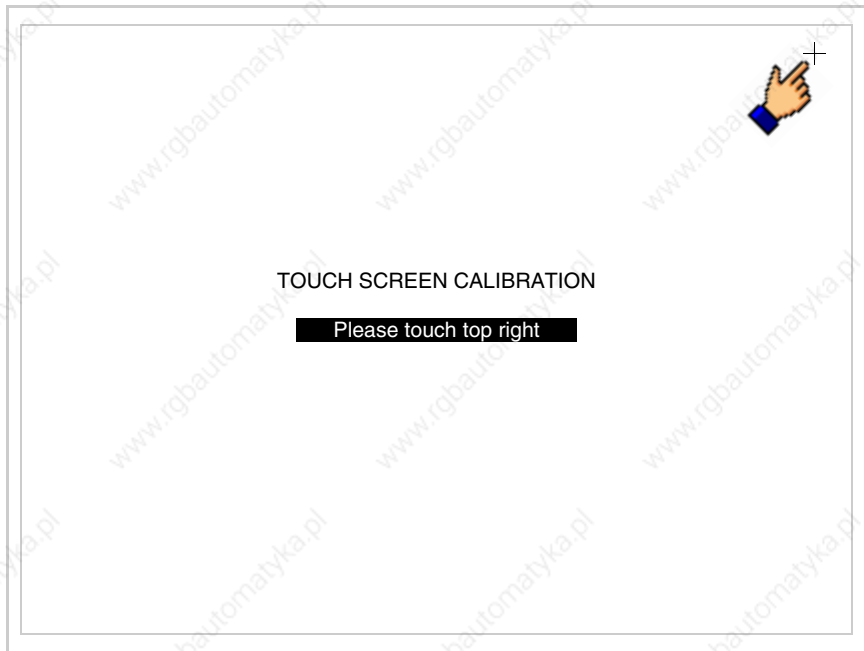

- Touch the corner indicated in the figure to complete the Calibracione procedure; the following page now appears



- Wait a few moments until the VT displays either the following mask or the project page

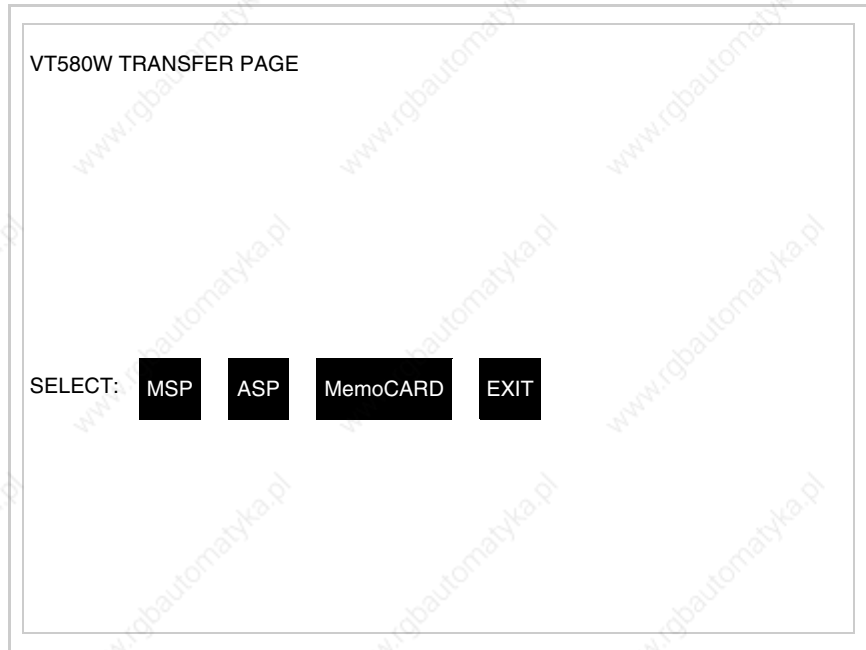

- Switch off the terminal
- Reposition J11 on pins 1-2
- Replace the back cover
- Switch on the terminal again

The calibration procedure has finished; if the calibration has been carried out wrongly or imprecisely, repeat the procedure.

Termination of CAN line

This paragraph applies only to the CAN series. The VT in question integrates the termination resistances of the serial line (typically 120 ohms) which can be inserted by means of a jumper (preset on 1-2, line not terminated). To activate the termination:

- Make sure the device is not connected to the power supply.
- Remove the cover.
- Identify the jumper unit J14.

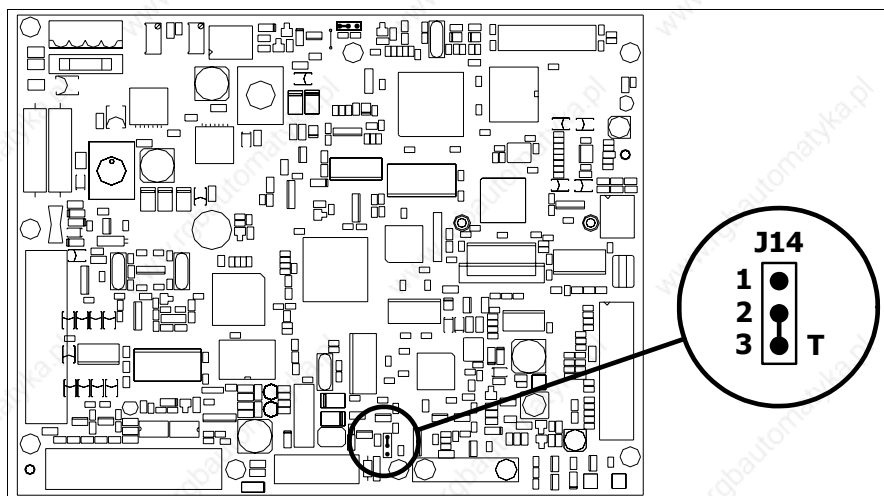

- Position the jumper between pins 2 and 3 (line terminated).
- Replace the back cover.
- Reconnect the power supply.

Introducing the MAC address

This paragraph relates only to the Ethernet series. The Media Access Control (MAC) address unambiguously identifies each terminal connected in the Ethernet network. The terminal is acquired with the address already programmed and is shown on the display of the terminal in the transfer page.

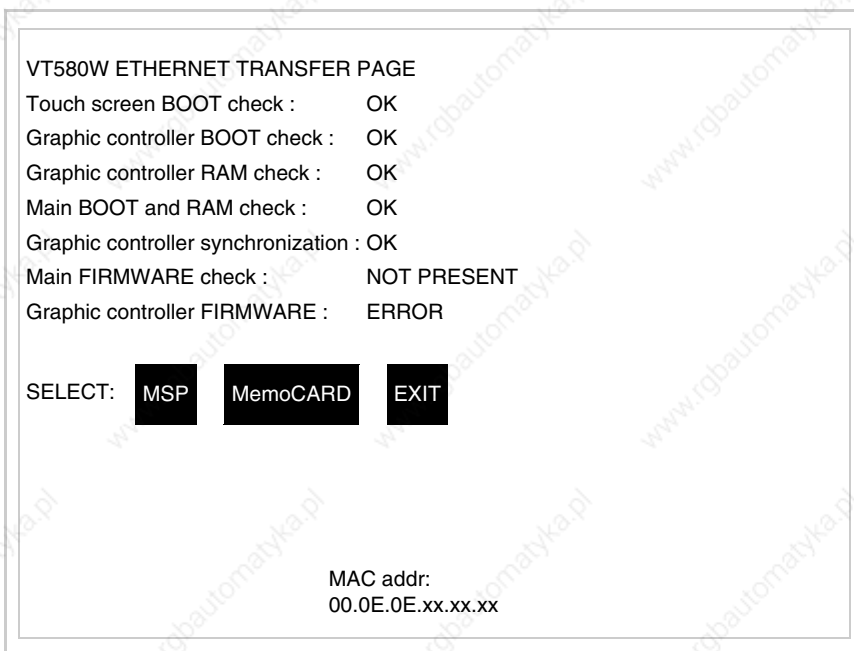

The MAC address is permanently memorized in the terminal, but should it

be necessary to execute an “aided” BOOT update (see Software Manual “Chapter 14 -> BOOT update“) the address is lost.

⚠ This operation must be carried out only with the advice of the ESA Customer Care Department.

Terminals with no valid MAC address when switched present a mask for its insertion. If no MAC address belonging to the terminal is available, proceed as follows:

- Check that the VT is not connected to the power supply.
- Remove the back cover
- Locate the label carrying the MAC address

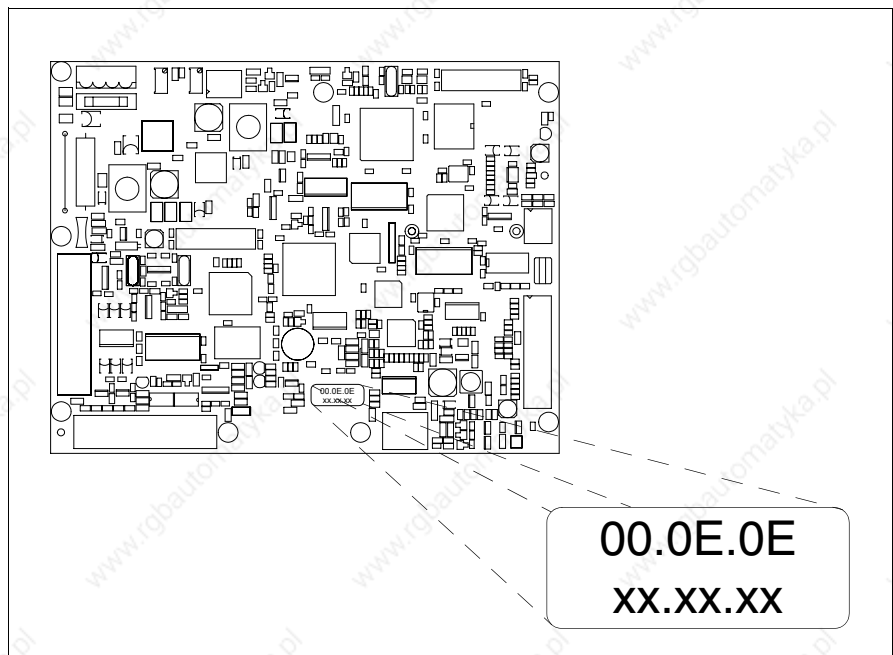

- Make a note of the number on the label (e.g. 00.0E.0E.00.00.01)

00.0E.0E -> fixed part that identifying as an ESA product
 XX.XX.XX -> variable part different for each terminal

- Reconnect the power supply to the terminal and, if necessary, calibrate the touch screen (see Page 24-14)
- Replace the back cover
- Switch on the terminal again
- The following mask appears; introduce the address previously noted down (e.g. 00.0E.0E.00.00.01)

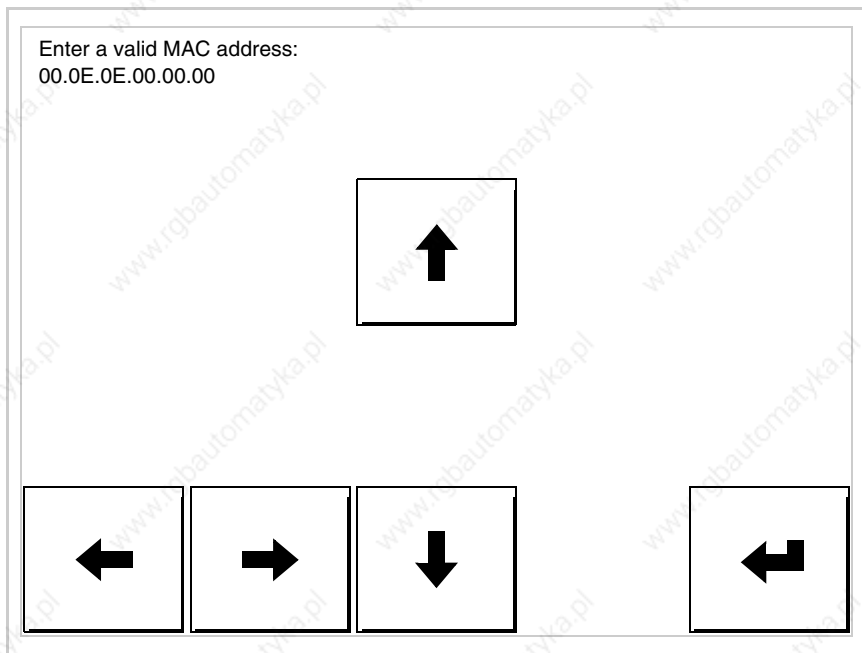

Enter a valid MAC address:
00.0E.0E.00.00.00

↑

← → ↓ ←

- Use the arrow  to make the setting. Once the address has been confirmed the following page is displayed

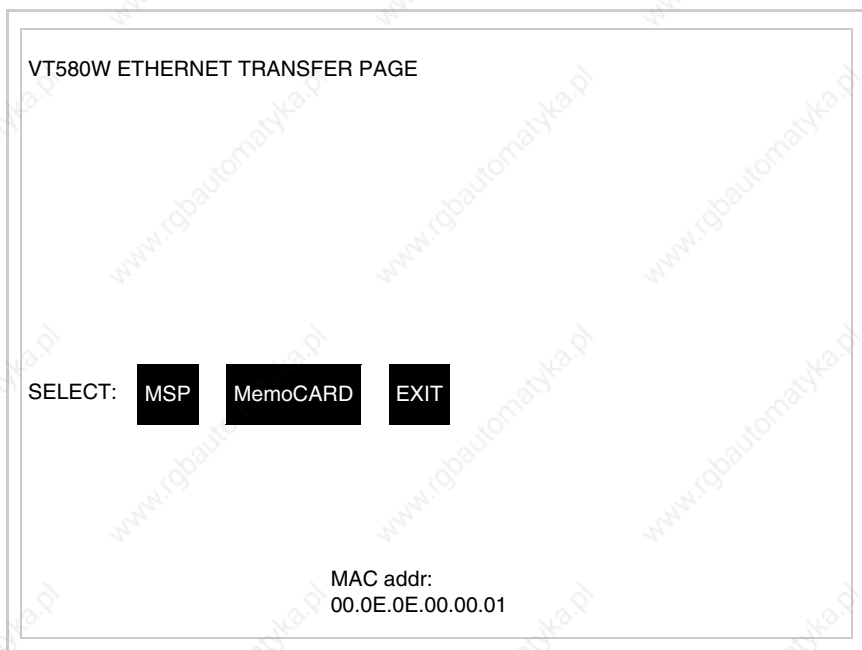

VT580W ETHERNET TRANSFER PAGE

SELECT: **MSP** **MemoCARD** **EXIT**

MAC addr:
00.0E.0E.00.00.01

The procedure is now terminated.



Should a wrong MAC address have been inserted contact the ESA Customer Care Department.

⚠ A wrong address could give rise to an error of conflict between VT terminals in the Ethernet network.

Transfer PC -> VT

For everything to function properly, the first time the VT operator terminal is switched on it needs to be correctly loaded, that is it needs to have transferred to it:

- Firmware
- Communication driver
- Project

(Given that the transfer of the three files in practice occurs with a single operation, it will be defined as “Project transfer” for the sake of simplicity.)

For this it is essential that the VT be prepared to receive the transfer. (See also “Chapter 37 -> Command area”).

Preparation for reception

The programme VTWIN must be used for the transfer (see Software Manual), but the terminal must be prepared for reception.

This means carrying out the following steps:

- Check that the VT is off
- Check that there is a serial connection between the PC and the VT
- Switch on the VT and wait for the following mask to appear
- Press one after the other two diagonally opposite corners free of settable objects or buttons (at least one corner needs to be free)



and wait a few moments, alternatively use the button provided (see Page 24-21), until the VT displays the following mask

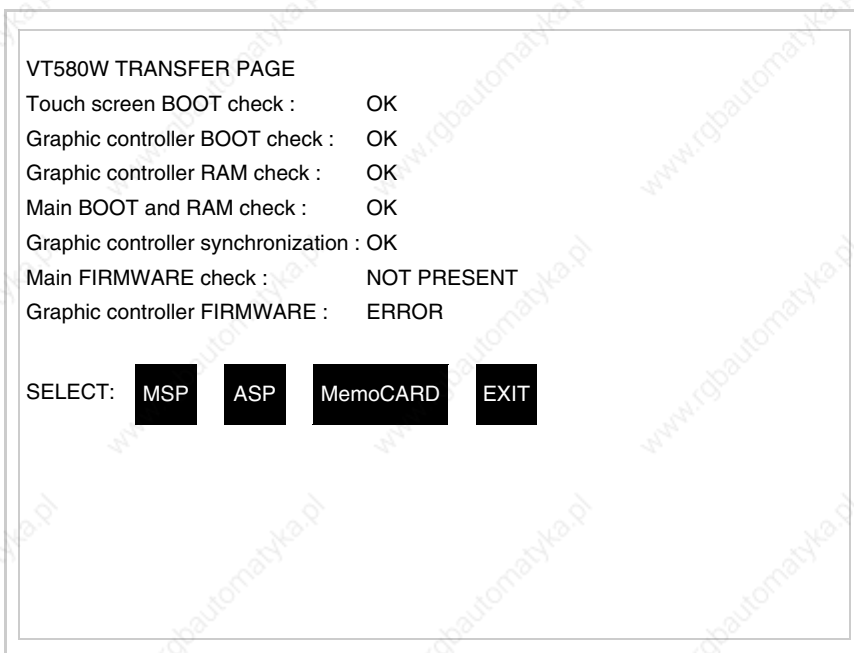

- Choose the port you intend to use for the transfer (MSP or ASP); touch the relevant on the display. The VT is now ready to receive (refer to Software Manual for transfer procedure). The MemoCARD appears if the Memory Card has been inserted in the VT (see Page 24-27)

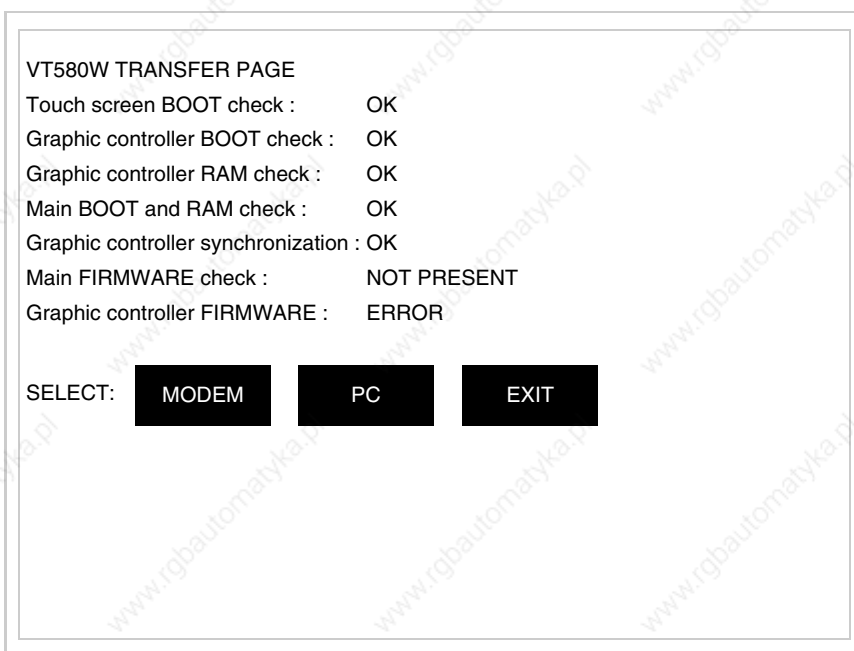

- Choose the required transfer mode: MODEM if you intend to use a modem or PC if you intend to use a serial port; touch the relevant on the display

If the choose made is PC, the VT is ready to receive (see Software Manual for transfer), if, on the other hand, you choose MODEM, the following mask will appear

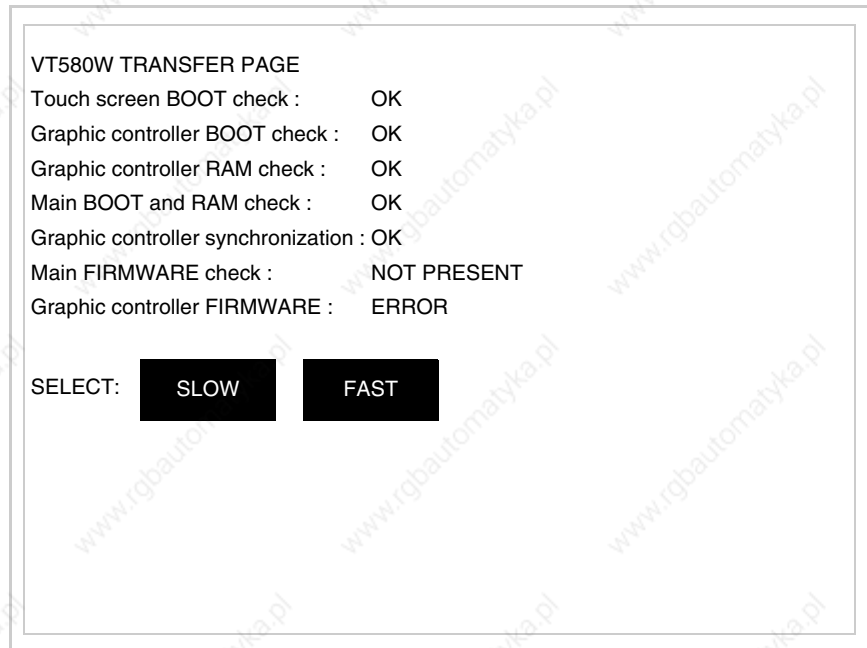

The choice should be according to the speed you intend to use for the transfer (Slow=9600bit/sec or Fast=38400bit/sec), touch the relevant on the display. The VT is now ready to receive (see Software Manual for the transfer).

Information relating to driver

After the project has been transferred, the VT can make available information relating to what has been loaded. The information regards:

- Serial ports present
- The name of the driver loaded
- The version of the driver loaded
- Network address of the VT
- Last error to have occurred

To acquire this information carry out the following operations:

- Be situated in any page of the project
- Press two diagonally opposed angles that are free of any settable objects

or buttons (at least one angle must be free)



and you will see



There is one of these pages for each communication port; movement between the various pages is effected by pressing .

From this page you can:

- Set the clock and the contrast
- Prepare the VT to receive the program
- Use the Memory Card

Setting the clock and the contrast:

To set the clock and the contrast, while displaying the above illustrated page, press ; the following mask appears

The image shows a rectangular display area with a thin border. Inside, there are two separate rectangular boxes, one above the other. The top box contains the text "SET CONTRAST : ±##". The bottom box contains the text "SET CLOCK :
ddd,dd/mm/yy
hh:mm:ss". In the bottom right corner of the display area, there is a small square button labeled "ESC".

To set the contrast touch the words SET CONTRAST on the display; you will see the following mask



Use the arrow  for any variation (see “Chapter 36 -> Operation of terminal with touch screen”).

To set the clock touch the words SET CLOCK on the display; the following mask appears

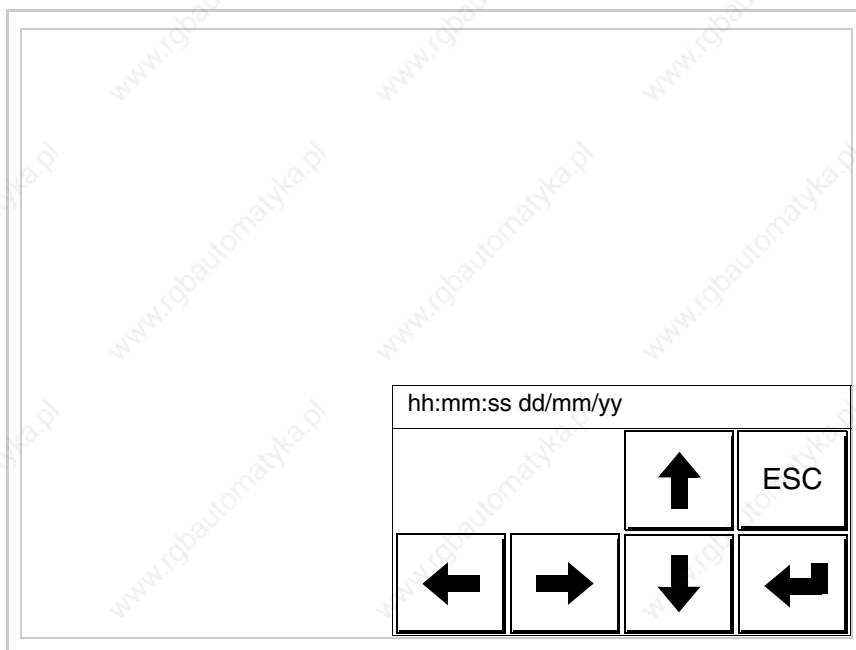

Use the arrow  for any variation (see “Chapter 36 -> Operation of terminal with touch screen”).

Prepare the VT to receive the program:

To prepare the VT to receive the program, while displaying the driver information page (see Page 24-23), press , and you will see the following mask

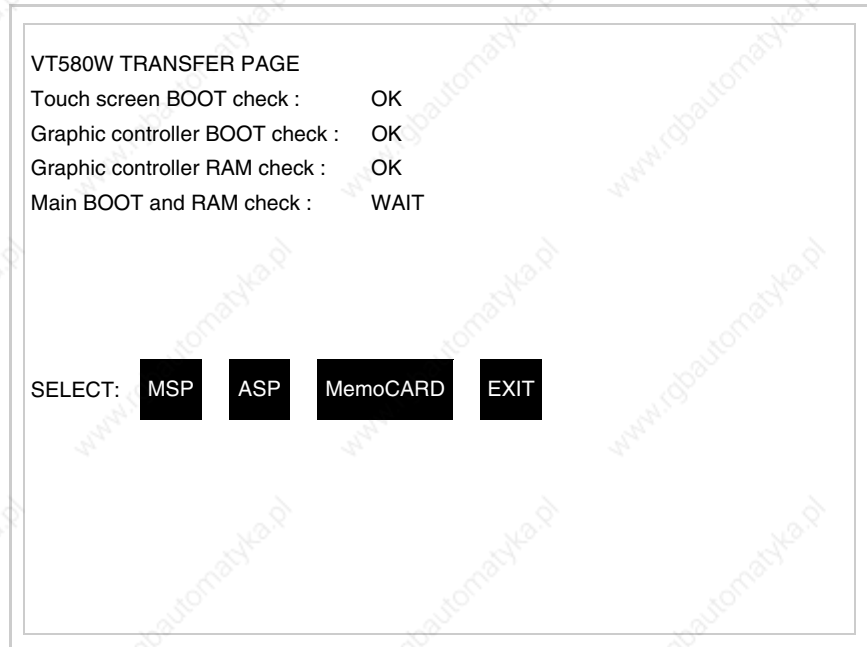

The on-screen  to press depends on the port you intend to use (MSP or ASP). The VT terminal is now ready to receive (consult Software Manual for information on the transmission procedure).

Using the Memory Card:

While displaying the driver information page, press  and the following mask will appear:

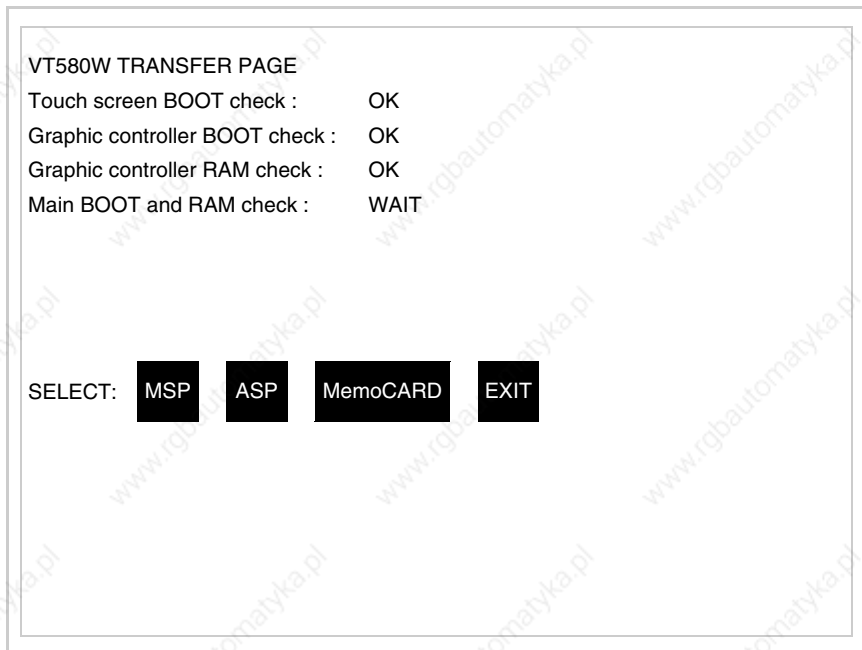

Touch the MemoCARD on the screen (if the key is not on screen, see Page 24-21) and the following mask will appear:

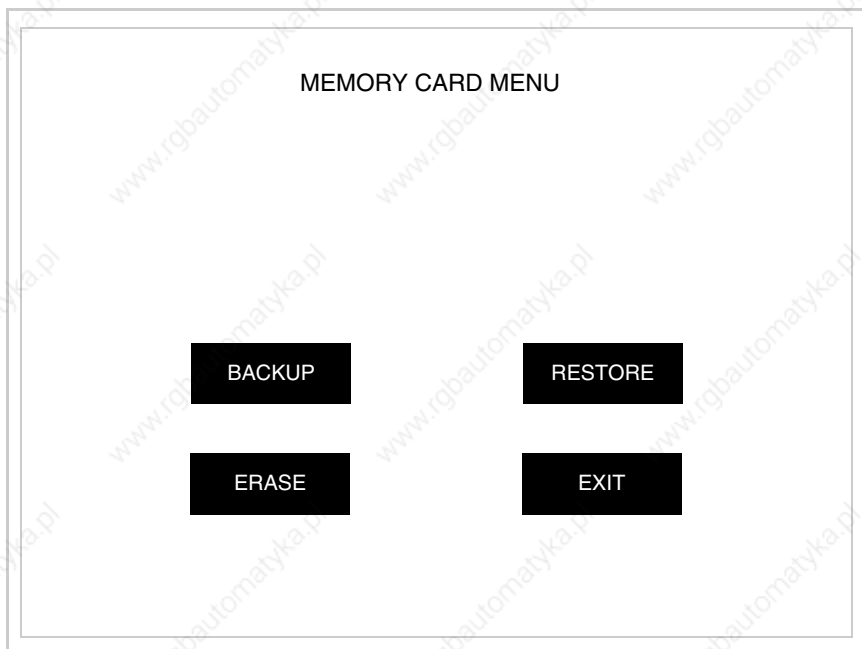

For the meaning and the functions of the keys see "Chapter 33 -> Memory card".

Possible error messages that may be encountered in the driver information page are:

- PR ERR

Problem-> Errors have been detected in the data exchange between the VT and the Device.

Solution-> Check the cable; there may be disturbance.

- COM BROKEN

Problem-> Communication between VT and Device interrupted.

Solution-> Check the serial connection cable.

An error message followed by [*] indicates that the error is not currently present but was and has since disappeared.

Example: COM BROKEN*

When  is pressed you quit the display of information regarding the driver.

Improving display color quality

To improve the color quality, adjust the contrast of the display: if the colors are too dark increase the contrast; if, on the other hand, the colors are too light, decrease the contrast.

Adjusting the contrast on the display

To improve the quality of the representation on the display it may be necessary to adjust its contrast. This can be done by going to the page proposed (see Page 24-25) and changing the value (from +63 to -64) in evidence at that moment. Increase the value to darken the display; to lighten it decrease the value.

We advise this to be done at typical room temperature and with the terminal at operating temperature (about 30 minutes after switching on and with the screen saver disabled - see Software Manual).

 **This parameter has no effect when a TFT display is used. This kind of technology does not need adjustment.**

Chapter 25 Video terminal VT585W

Contents	Page
Technical characteristics	25-2
Functions	25-4
Front view	25-8
Customizing label	25-9
Standard series rear view	25-10
CAN series rear view	25-11
Dimensions and Cut-out	25-12
Accessories	25-13
Calibration of Touch Screen	25-13
Termination of CAN line	25-18
Transfer PC -> VT	25-19
Preparation for reception	25-19
Information relating to driver	25-22
Improving display color quality	25-28
Adjusting the contrast on the display	25-28

This chapter consists of 28 pages.

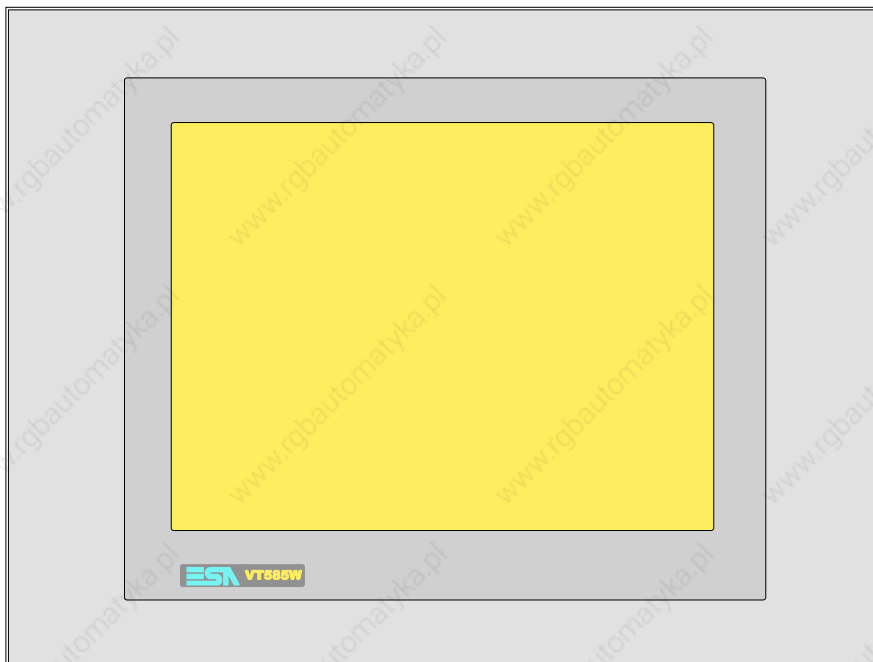

Technical characteristics The following table lists the principal technical characteristics of the product in question.

Code of terminal	Characteristics of the terminal		
VT585W APS00			
VT585W APT00			
VT585W 0PSCN			
Display			
Type	LCD Monochromatic STN		
	LCD 256 Colors STN	●	●
	LCD 256 Colors TFT		●
Touch screen [cells]	Matrix 40x30 (Cell:16x16 pixels)	●	●
Representational format	Graphic	●	●
Resolution [pixels]	640 x 480 (10,4")	●	●
Rows per character	30 x 80 / 15 x 40 / 7 x 20	●	●
Dimension of visible area [mm]	211,2 x 158		●
	211,2 x 158,4	●	●
Character matrix in text mode [pixels]	8 x16 / 16 x 32 / 32 x 64	●	●
Character size [mm] x1 / x2 / x4	2,7 x 5,4 / 5,4 x 10,7 / 10,7 x 21,4	●	●
Contrast adjustment	Software	●	●
	Automatic compensation with temperature	●	●
Character set	Programmable fonts/TTF Windows ®	●	●
Backlighting			
Type	LED		
	CCFL lamp	●	●
Minimum lamp-life at 25°C [hours]	15000	●	●

Code of terminal	Characteristics of the terminal		
VT585W APS00			
VT585W APT00			
VT585W 0PSCN			
User memory			
Project [Bytes]	640K + 1792K (Text + Graphic)	●	● ●
Data memory [Bytes]	128K (With back-up battery)	●	● ●
Memory for Windows ® -based fonts [Byte]	512K	●	● ●
Memory Card for backup	8Mb	●	● ●
Memory Card for expansion	4Mb (Only for graphic type)	●	● ●
Interfaces			
MSP (Multi-serial port)	RS232/RS422/RS485/TTY-20mA	●	● ●
ASP (Auxiliary serial port)	RS232/RS485		● ●
ASP-15L (Auxiliary serial port)	RS232/RS485		
ASP-8 (Auxiliary serial port)	RS232		
ASP-9 (Auxiliary serial port)	RS232		
LPT parallel port	Centronics	●	● ●
Auxiliary port	Connection for accessory devices	●	● ●
Accessories			
Connectable accessories	See table "Chapter 33"	●	● ●
Clock			
Hardware clock	With back-up battery	●	● ●
Networks			
Integrated	Profibus-DP		
	CAN Open (Optoisolated interface)	●	
	Ethernet 10/100Mbit RJ45		
Universal Bus Connector	--		
Optional	See table "Chapter 33"	●	● ●
Proprietary networks			
ESA-Net	Network server	●	● ●
	Network client	●	● ●
Technical data			
Power supply	24Vdc (18..32Vdc)		
Power absorbed at 24Vdc	15W		
Protection fuse	Ø5x20mm - 1,25A Quick Blow F		
Protection level	IP65 (front-end)		
Operating temperature	0..50°C		
Storage and transportation temperature	-20..+60°C		
Humidity (non-condensing)	<85%		
Weight	4000gr		
Dimensions			
External W x H x D [mm]	346 x 260 x 74		
Cut-out W x H [mm]	314 x 240		
Certification			
Certifications and approvals	CE, cULus, NEMA12		

Functions

The following table lists in alphabetical order all the functions of the VT in question.

Table 25.1: Functions and objects realizable with this VT (Part 1 of 4)

Code of terminal		
VT585W *****	Objects/Functions	Quantity
Alarm field		●
Alarm help	1024	●
Alarm history buffer	256	●
Alarm statistics		
Alarms (Total/active simultaneously)	1024/256	●
Arc		●
Automatic operations	32	●
Backup/Restore		●
Bar data		●
Bit-wise password	8bits	●
Buttons	1200xpage	●
Circles		●
Command: Change language		●
Command: Clear trend buffer		●
Command: Delete recipe		●
Command: Hardcopy		●
Command: Load recipe from data memory		●
Command: Modify password		●
Command: Next page		●
Command: Page help		●
Command: Password login		●
Command: Password logout		●
Command: Previous page		●
Command: Print alarm history		●
Command: Printer form feed		●
Command: Quit project		●
Command: Report		●
Command: Restarts reading time-sampled trend		●
Command: Run pipeline		●
Command: Save alarms history and trend buffers in flash		
Command: Save recipe in data memory		●
Command: Save recipe received from device in buffer		●
Command: Save recipe received from device in data memory		●
Command: Send recipe from video buffer to device		●
Command: Send recipe to device		●
Command: Service page		●

Unless otherwise stated, there is no limit to the number of includable elements, only the size of project memory sets a limit.
*) indicative value determined by the dimensions of the project, **) depends on memory available

Table 25.1: Functions and objects realizable with this VT (Part 2 of 4)

Code of terminal		
VT585W *****		
Objects/Functions	Quantity	▼
Command: Show alarms history		●
Command: Show page directory		●
Command: Show project information		●
Command: Show recipe directory		●
Command: Show sequence directory		
Command: Shows driver status page		●
Command: Shows page help		●
Command: Shows page with function: PG		
Command: Stops reading time sampled trend		●
Command: Trend reading saved in device		●
Command: Zero number of general pages		●
Date field		●
Day-of-the-week field		●
Dynamic texts: Bit-group-structured dynamic texts	1024*	●
Dynamic texts: Single-bit dynamic texts		●
Dynamic texts: Value-structured dynamic texts		●
E-keys		
Equations	32	●
F-keys		
Free terminal		
Function: Disables key		
Function: Go to page		●
Function: Internal command		●
Function: Invert bit value		●
Function: Macro		●
Function: None		
Function: Reset bit permanently		●
Function: Reset real-time bit		●
Function: Sequences		
Function: Sets bit permanently		●
Function: Sets real-time bit		●
Function: Value-structure direct command		●
Global configuration of E-keys		
Global configuration of F-keys		
Headers and footers (Total/Number of fields per H-F)	128/128	●
Info-messages (Total/active simultaneously)	256/256	●
Internal registers	4096bytes	●
Labels		●
LEDs assigned to sequence		

Unless otherwise stated, there is no limit to the number of includable elements, only the size of project memory sets a limit.
 *) indicative value determined by the dimensions of the project, **) depends on memory available

Table 25.1: Functions and objects realizable with this VT (Part 3 of 4)

Code of terminal		
VT585W *****		
Objects/Functions	Quantity	▼
Lines		●
Lists of bitmap images		●
Lists of texts		●
Local configuration of E-keys		
Local configuration of F-keys		
Macro field		
Macros (Total/Commands x macro)	1024/16	●
Message field		●
Message help	256	●
Multilanguage texts	8 Langs.	●
Object - Indicator	256	●
Object - Potentiometer knob	256	●
Object - Selector knob	256	●
Object - Sliding potentiometer	256	●
Object - Sliding selector	256	●
Page	1024	●
Page help	1024	●
Password	10	●
Pipelines (Number/Tot bytes)	64/512	●
Print		●
Print page (Total/Number of fields per page)	1024/128	●
Programmable fonts		●
Project images		●
Public variables of ESANET network (Number/Total bytes)	512/1024	●
Recipe field for recipe structure		●
Recipes (Number of variables per recipe)	1024/512	●
Rectangles		●
Redefinable characters		
Reports	128	●
Sequences - Random		
Sequences - Start/stop		
Static bitmaps		●
Symbolic field: Bit-group-structured dynamic bitmaps	1024*	●
Symbolic field: Single-bit-structured dynamic bitmaps		●
Symbolic field: Value-structured dynamic bitmaps		●
System messages		●
System variables assigned to recipe structure		●
Time long field		●
Time short field		●

Unless otherwise stated, there is no limit to the number of includable elements, only the size of project memory sets a limit.
*) indicative value determined by the dimensions of the project, **) depends on memory available

Table 25.1: Functions and objects realizable with this VT (Part 4 of 4)

Code of terminal		
VT585W ****		
Objects/Functions	Quantity	▼
Timer	32	●
Touch Area	256	●
Trend buffers	128	●
Trends (Trends x page/Channels x trend)	8/8	●
Trends sampled automatically (Memory/Trends/Readings)	8192bytes	●
Trends sampled on command (Memory/Trends/Readings)	/**/640	●
Value direct command: ADD		●
Value direct command: AND		●
Value direct command: OR		●
Value direct command: SET		●
Value direct command: SUBTRACT		●
Value direct command: XOR		●
Variables: Limit values and linear scaling variables	304 x pages	●
Variables: Movement variable (Mobile symbolic field)		●
Variables: Threshold variables		●
Variables: Floating Point numerical variables		●
Variables: Numerical variables (DEC, HEX, BIN, BCD)		●
Variables: String variables (ASCII)		●

Unless otherwise stated, there is no limit to the number of includable elements, only the size of project memory sets a limit.
 *) indicative value determined by the dimensions of the project, **) depends on memory available

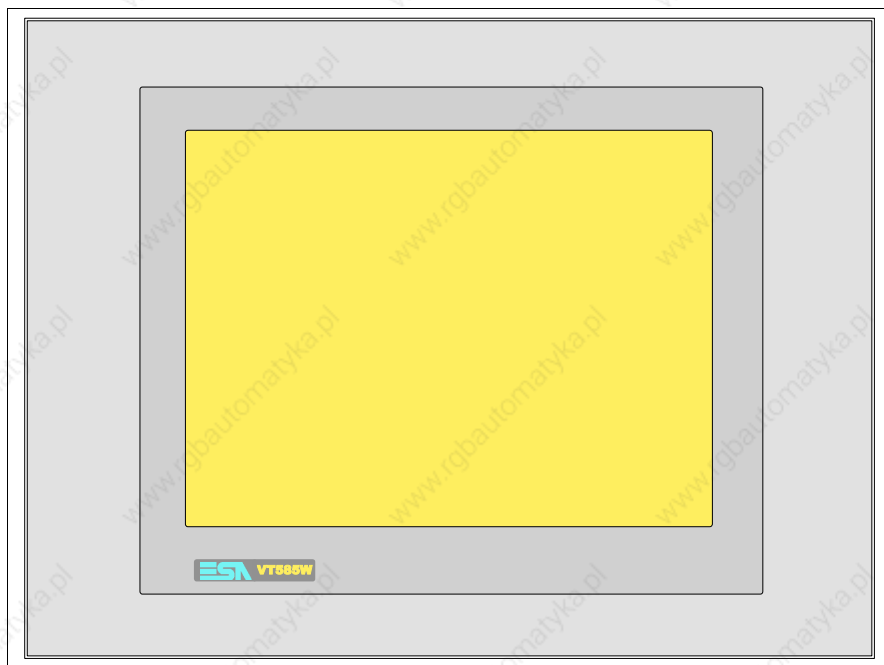
Front view

All buttons and signals are defined via the programming software (see Software Manual).

Customizing label

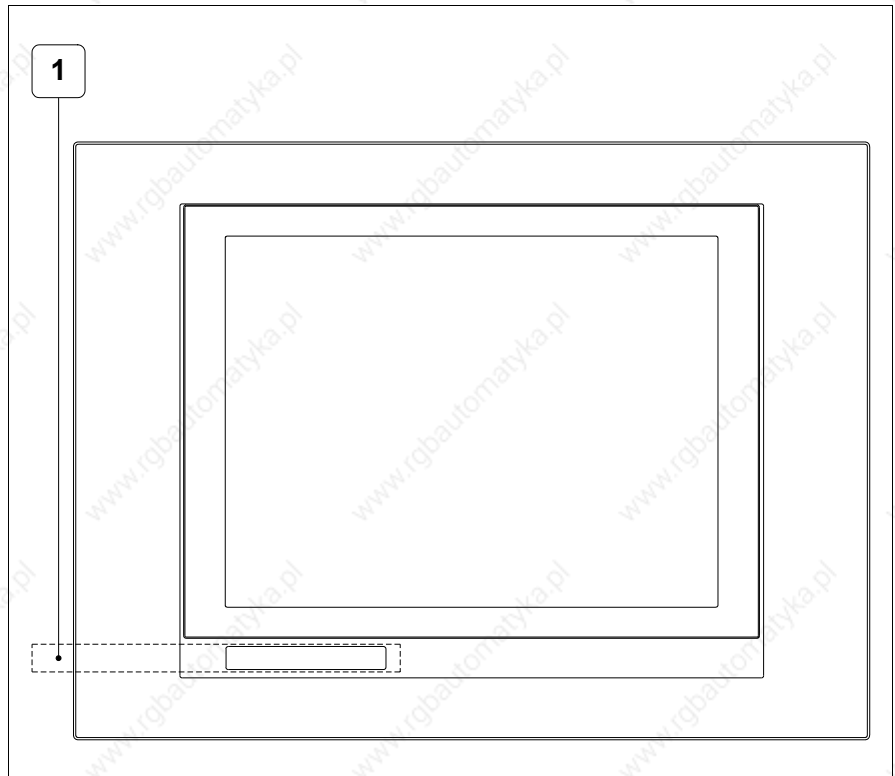

Position	Function - Dimensions L x H (mm)
1	ESA Logo, VT Model - 160 x 12

 **The total thickness of the label must not exceed 125µm (micrometers). Do not use either stiff materials or glues.**

 **Before starting to insert the customized label, see “Chapter 28 -> Inserting customized labels”.**

Standard series rear view

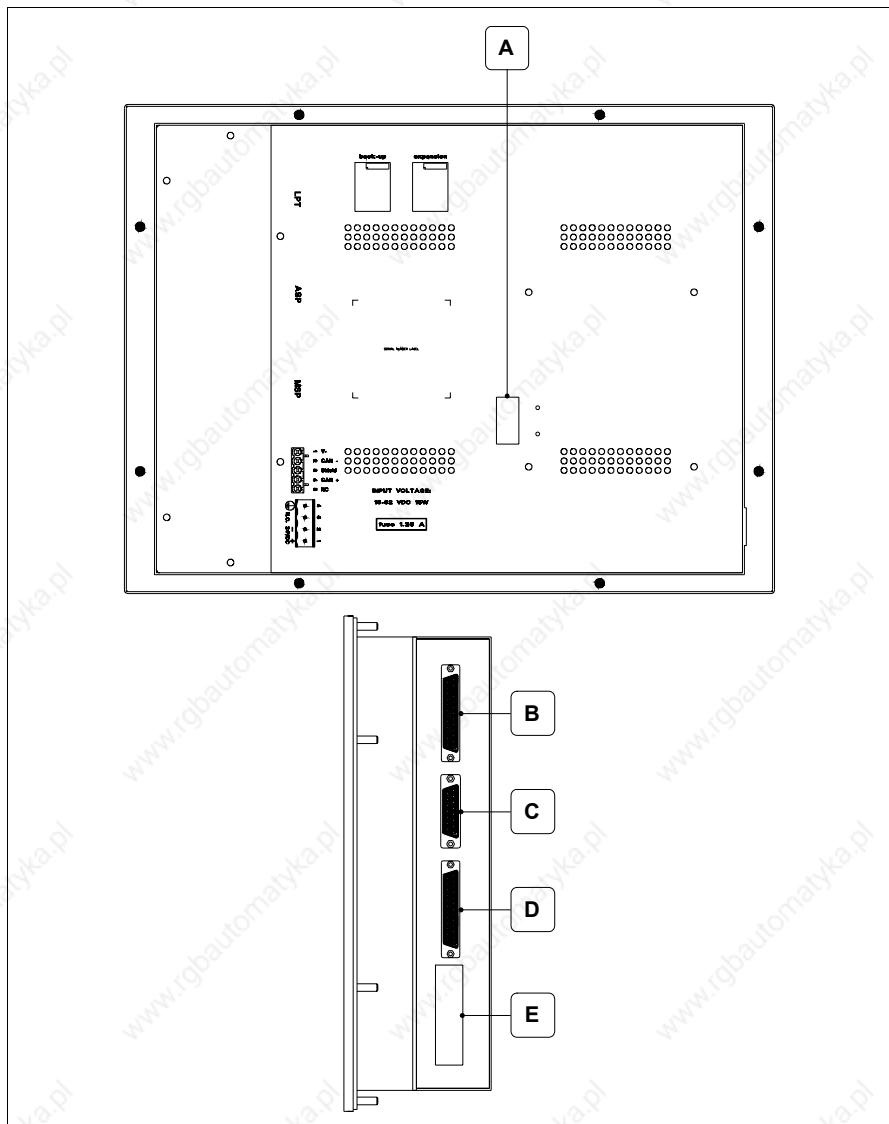

Position	Function
A	Auxiliary port for connecting optional accessories
B	LPT port for connecting printer
C	ASP serial port for communicating with PC or other devices
D	MSP serial port for communicating with PLC/PC
E	Power supply connector

CAN series rear view

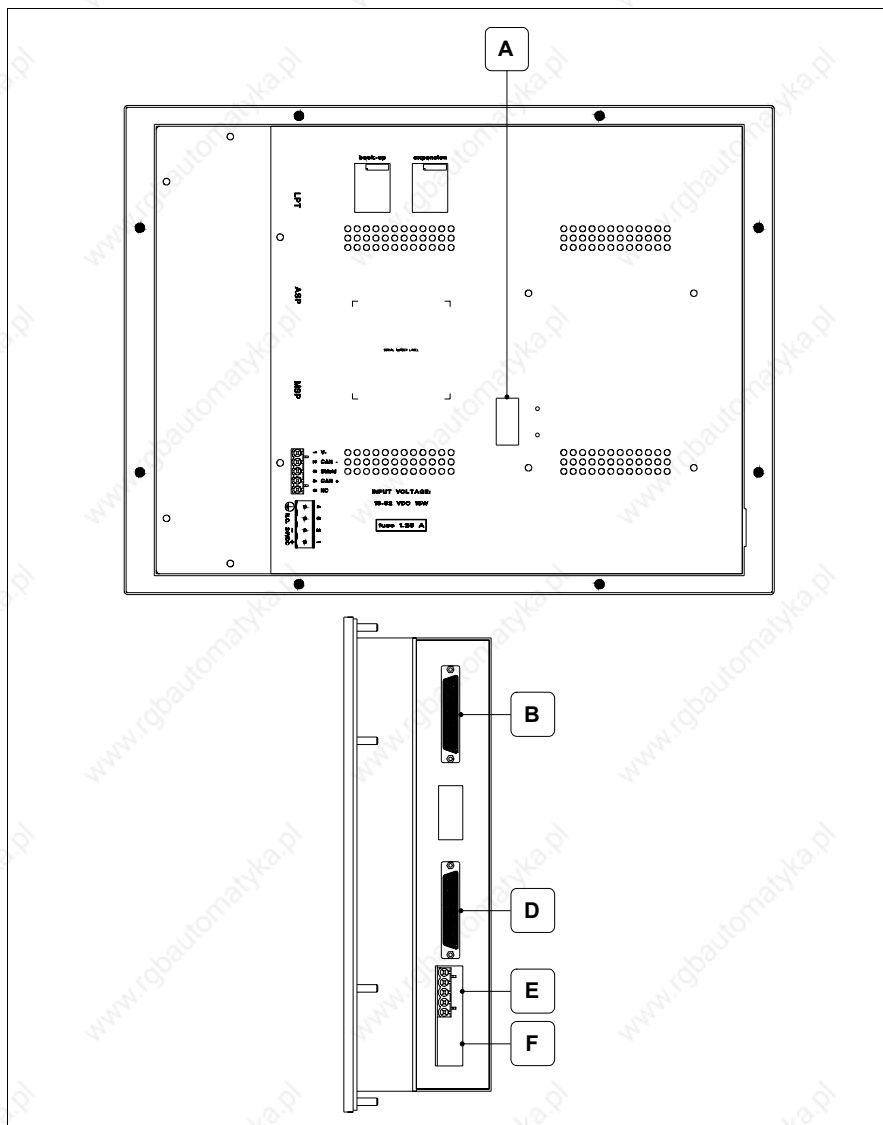

Position	Function
A	Auxiliary port for connecting optional accessories
B	LPT port for connecting printer
D	MSP serial port for communicating with PLC/PC
E	CAN serial port
F	Power supply connector

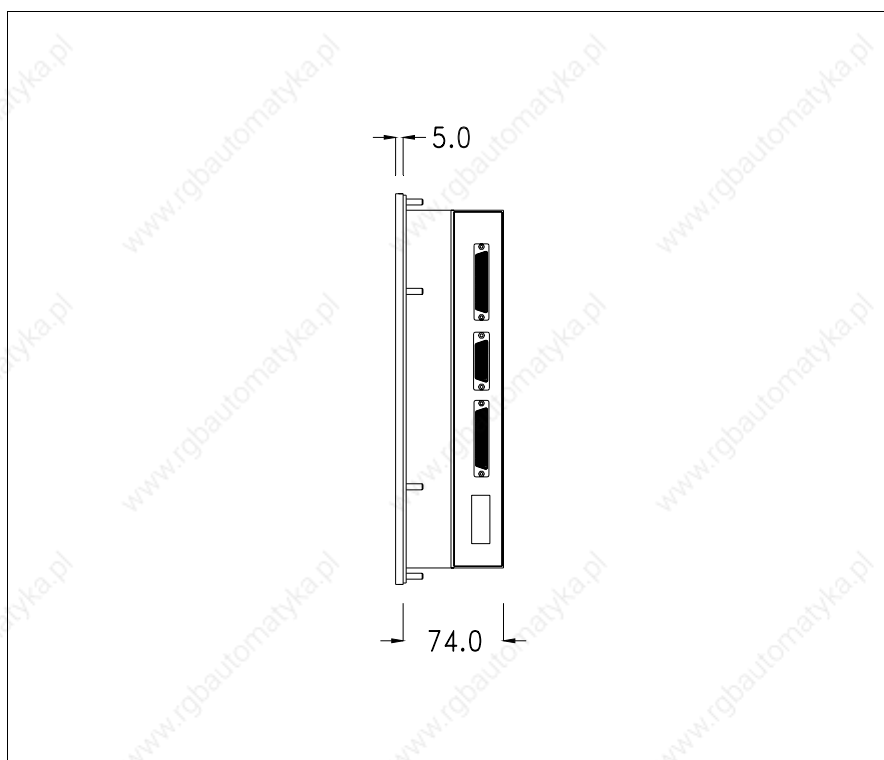
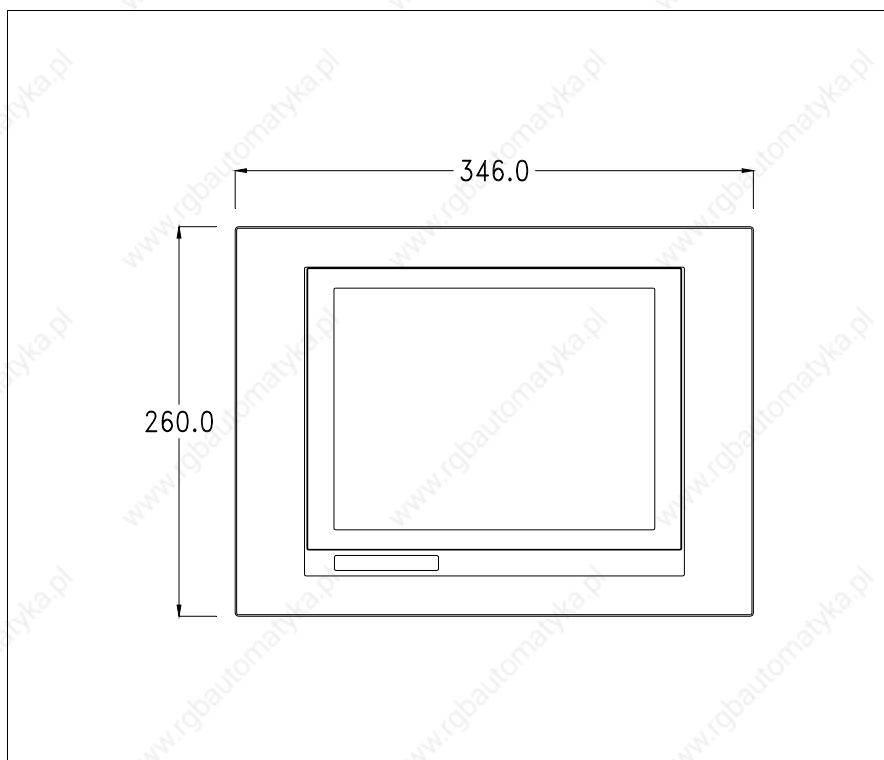
**Dimensions
and Cut-out**

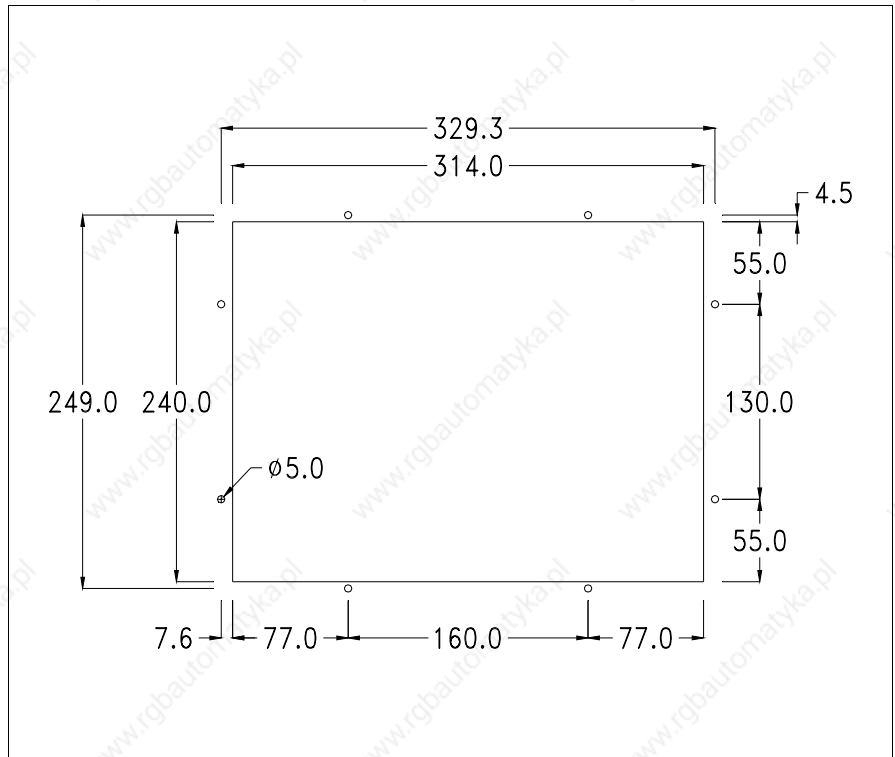

To fix the sealing gasket and secure the VT to the container see “Chapter 29 -> Mounting the terminal within the container“.

⚠ Where accessories need to be fixed in or onto the VT terminal, you are advised to do this before securing the VT to its container.

Accessories

Any accessories should be mounted in accordance with the instructions in the relevant chapter (see “Chapter 33 -> Video terminal accessories“).

Calibration of Touch Screen

The screen of VT585W is made of resistive, sensitive glass; for this type of glass to work properly it requires a calibration procedure (**the terminal is already calibrated when supplied**), that is, the resistive area of the glass has to be adjusted to the visible area of the display.

Should it be thought necessary to repeat the calibration procedure this can be done (terminal Rev. 5 or above) by following the instructions set out below.

⚠ The procedure must be carried out with great care as the precision of the keys area depends on the calibration.

How to perform the calibration procedure:

- Make sure the VT is not connected to the power supply
- Remove the back cover
- Identify jumpers JP5 and JP12

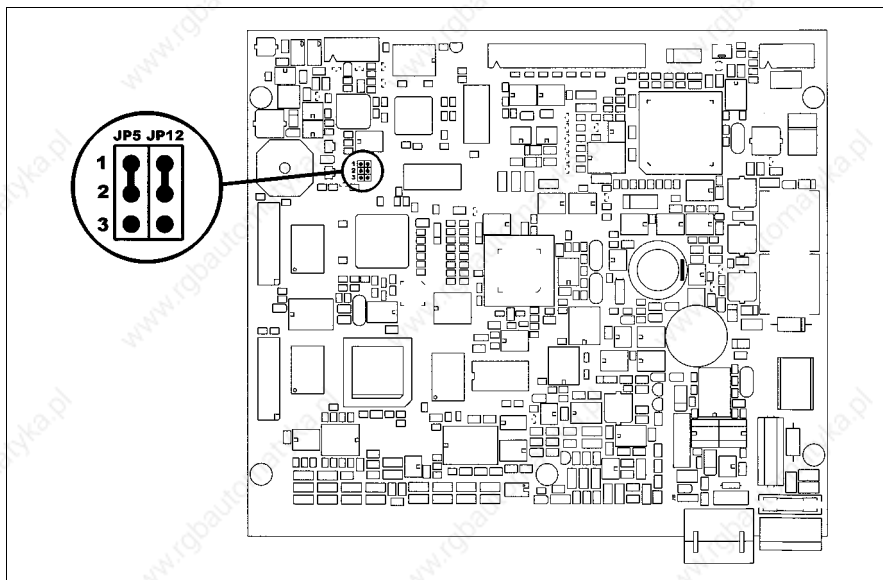

- Position JP5 and JP12 on pins 2-3
- Reconnect the power supply and switch on the terminal; the following mask appears (the number and type of mask depend on the release version of the terminal)

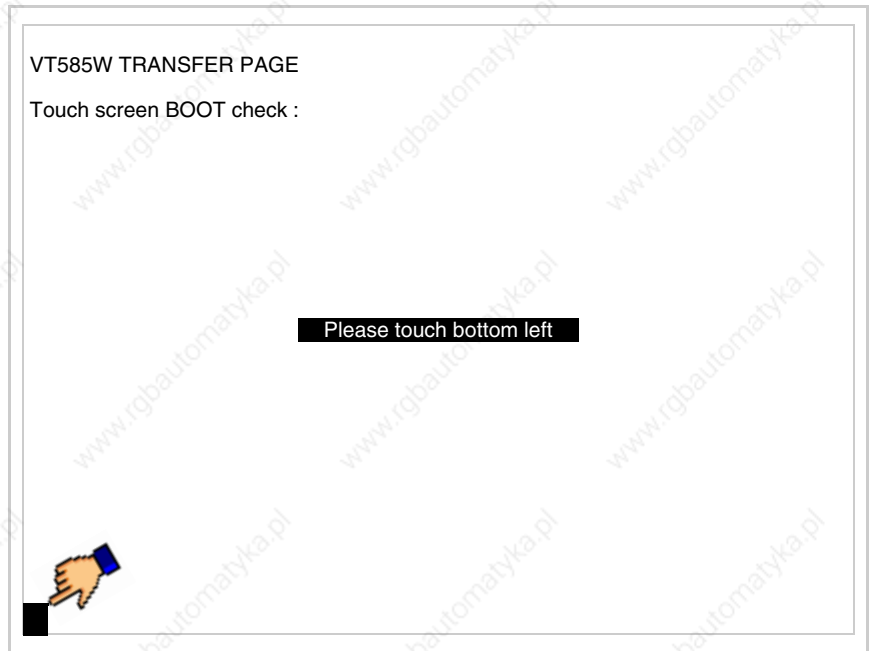
Release 5.0 to 5.2:

- Touch the corner indicated in the figure; then the following page appears on screen

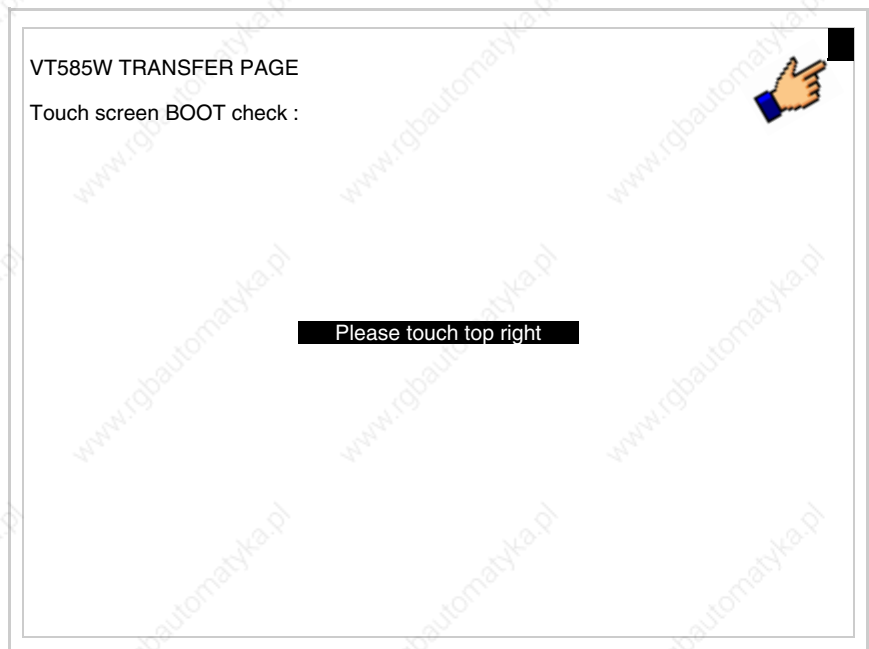

- Touch the corner indicated in the figure to complete the Calibrazione procedure; the following page now appears

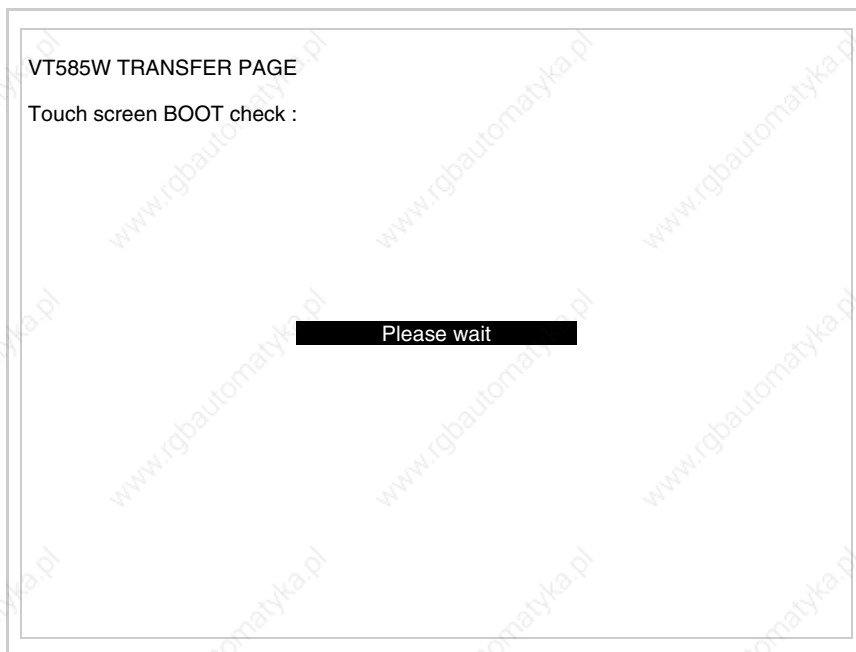
**Release 5.3 or later:**

- Touch the corner indicated in the figure; then the following page appears on screen



- Touch the corner indicated in the figure; then the following page appears on screen



- Touch the corner indicated in the figure to complete the calibration procedure. Wait a few moments until the VT displays either the following

mask or the project page

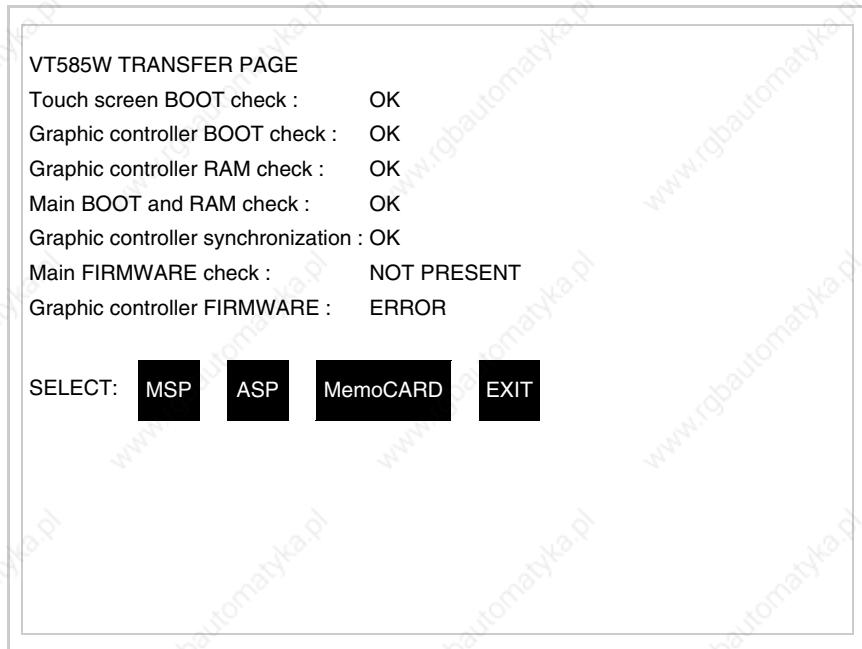

- Switch off the terminal
- Reposition JP5 and JP12 on pins 1-2
- Replace the back cover
- Switch on the terminal again

The calibration procedure has finished; if the calibration has been carried out wrongly or imprecisely, repeat the procedure.

Termination of CAN line

This paragraph applies only to the CAN series. The VT in question integrates the termination resistances of the serial line (typically 120 ohms) which can be inserted by means of a jumper (preset on 1-2, line not terminated). To activate the termination:

- Make sure the device is not connected to the power supply.
- Remove the cover.
- Identify the jumper unit J6.

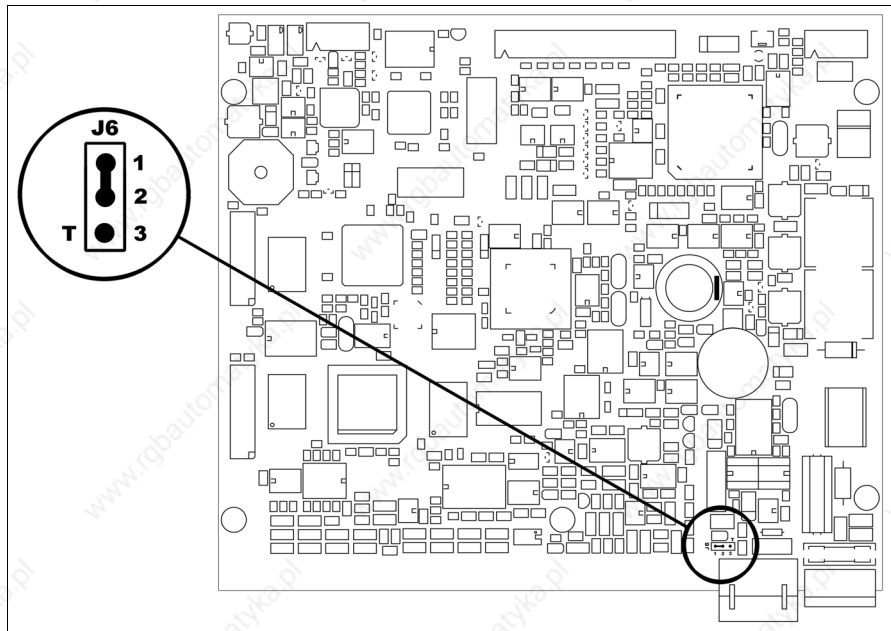

- Position the jumper between pins 2 and 3 (line terminated).
- Replace the back cover.
- Reconnect the power supply.

Transfer PC -> VT

For everything to function properly, the first time the VT operator terminal is switched on it needs to be correctly loaded, that is it needs to have transferred to it:

- Firmware
- Communication driver
- Project

(Given that the transfer of the three files in practice occurs with a single operation, it will be defined as “Project transfer” for the sake of simplicity.)

For this it is essential that the VT be prepared to receive the transfer. (See also “Chapter 37 -> Command area”).

Preparation for reception

The programme VTWIN must be used for the transfer (see Software Manual), but the terminal must be prepared for reception.

This means carrying out the following steps:



- Check that the VT is off
- Check that there is a serial connection between the PC and the VT

- Switch on the VT and wait for the following mask to appear
- Press one after the other two diagonally opposite corners free of settable objects or buttons (at least one corner needs to be free)



and wait a few moments, alternatively use the button provided (see Page 25-19), until the VT displays the following mask

VT terminal with no Modem function:

- Choose the port you intend to use for the transfer (MSP or ASP); touch the relevant  on the display. The VT is now ready to receive (refer to Software Manual for transfer procedure). The  MemoCARD appears if the Memory Card has been inserted in the VT (see Page 25-26)

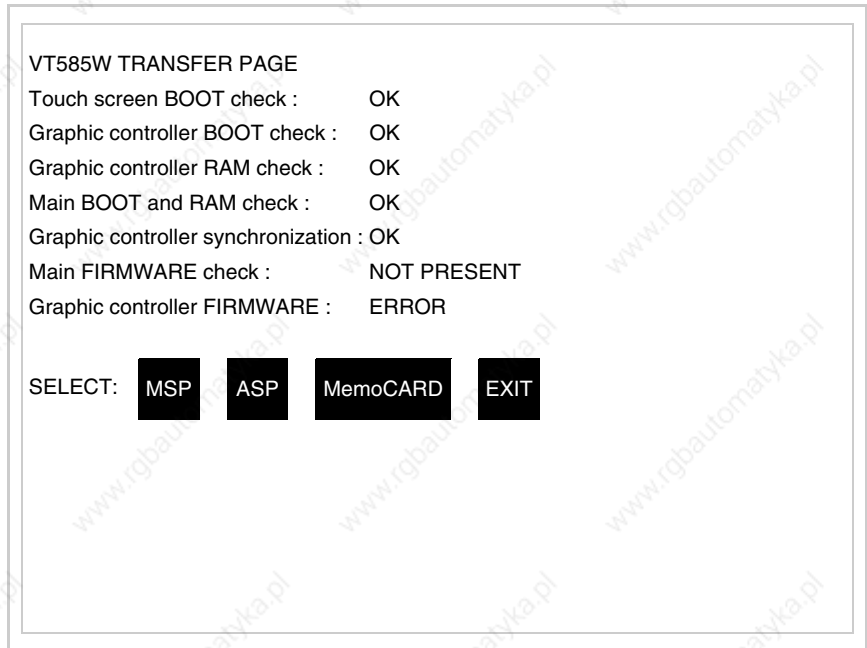

VT terminal with Modem function:

- Proceed from the preceding mask; the following mask appears

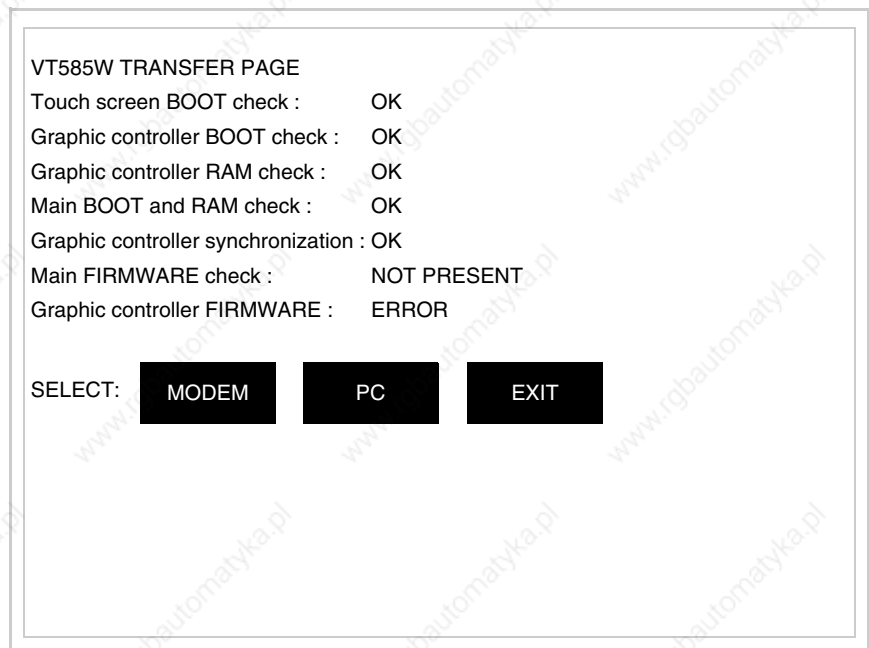

- Choose the required transfer mode: MODEM if you intend to use a modem or PC if you intend to use a serial port; touch the relevant on the display

If the choice made is PC, the VT is ready to receive (see Software Manual for transfer), if, on the other hand, you choose MODEM, the following mask will appear

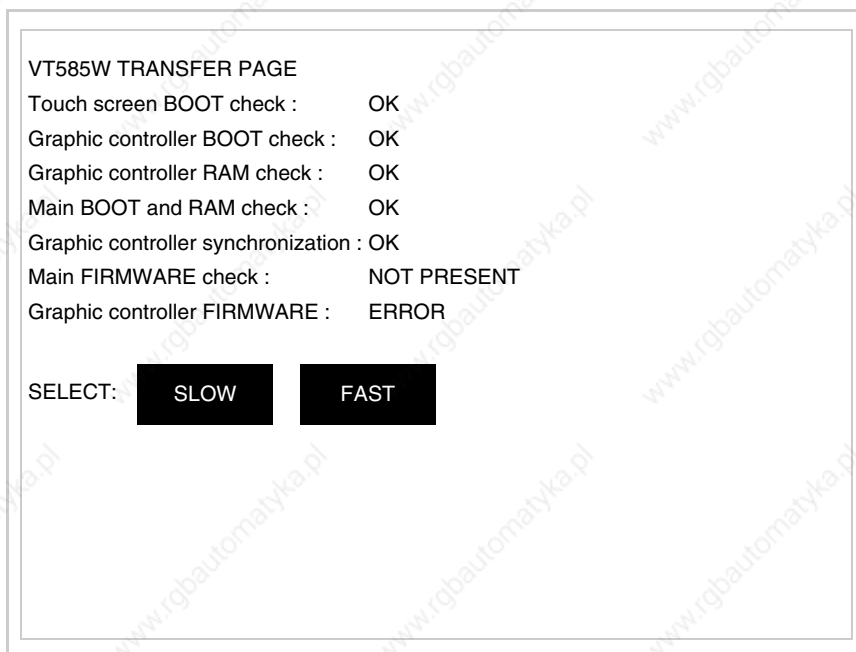

The choice should be according to the speed you intend to use for the transfer (Slow=9600bit/sec or Fast=38400bit/sec), touch the relevant  on the display. The VT is now ready to receive (see Software Manual for the transfer).

Information relating to driver

After the project has been transferred, the VT can make available information relating to what has been loaded. The information regards:

- Serial ports present
- The name of the driver loaded
- The version of the driver loaded
- Network address of the VT
- Last error to have occurred

To acquire this information carry out the following operations:

- Be situated in any page of the project
- Press two diagonally opposed angles that are free of any settable objects or buttons (at least one angle must be free)



and you will see



There is one of these pages for each communication port; movement between the various pages is effected by pressing .

From this page you can:

- Set the clock and the contrast
- Prepare the VT to receive the program
- Use the Memory Card

Setting the clock and the contrast:

To set the clock and the contrast, while displaying the above illustrated page, press ; the following mask appears

The image shows a rectangular frame representing the video terminal display. Inside the frame, there are two rectangular boxes stacked vertically. The top box contains the text "SET CONTRAST: ±##". The bottom box contains the text "SET CLOCK:" followed by "ddd,dd/mm/yy" and "hh:mm:ss" on separate lines. In the bottom right corner of the frame, there is a small rectangular box containing the text "ESC".

To set the contrast touch the words SET CONTRAST on the display; you will see the following mask



Use the arrow  for any variation (see “Chapter 36 -> Operation of terminal with touch screen”).

To set the clock touch the words SET CLOCK on the display; the following mask appears

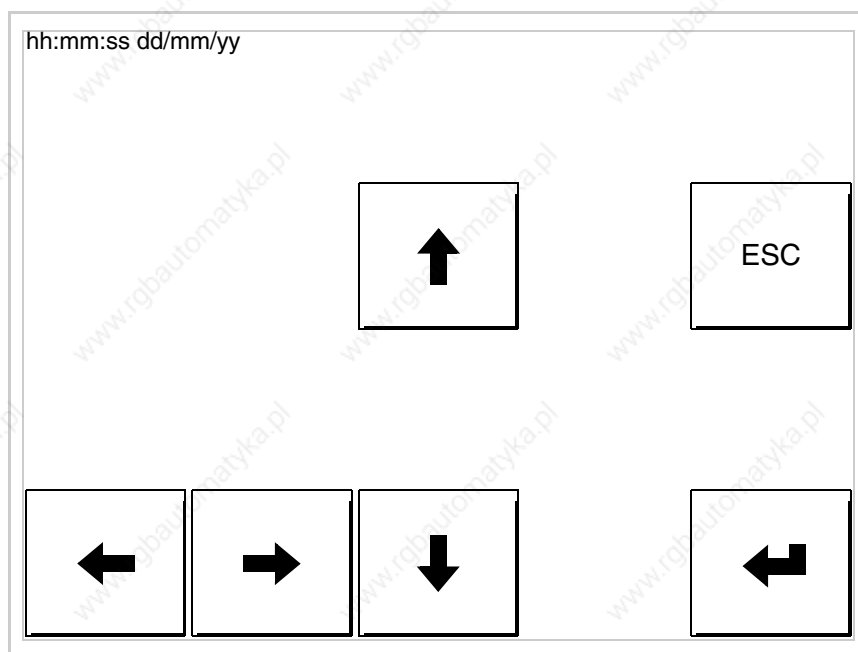



Use the arrow  for any variation (see “Chapter 36 -> Operation of terminal with touch screen”).

 **For the clock to be used properly, a special battery has to be inserted in the terminal** (see “Chapter 33 -> Video terminal accessories”).

Prepare the VT to receive the program:

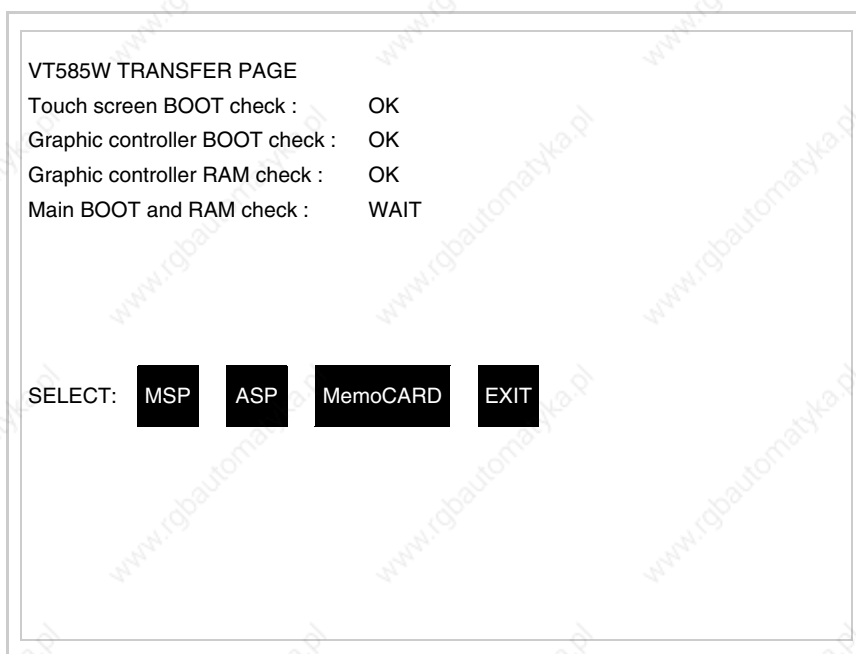
To prepare the VT to receive the program, while displaying the driver information page (see Page 25-22), press , and you will see the following mask



The on-screen  to press depends on the port you intend to use (MSP or ASP). The VT terminal is now ready to receive (consult Software Manual for information on the transmission procedure).

Using the Memory Card:

While displaying the driver information page, press  and the following mask will appear:

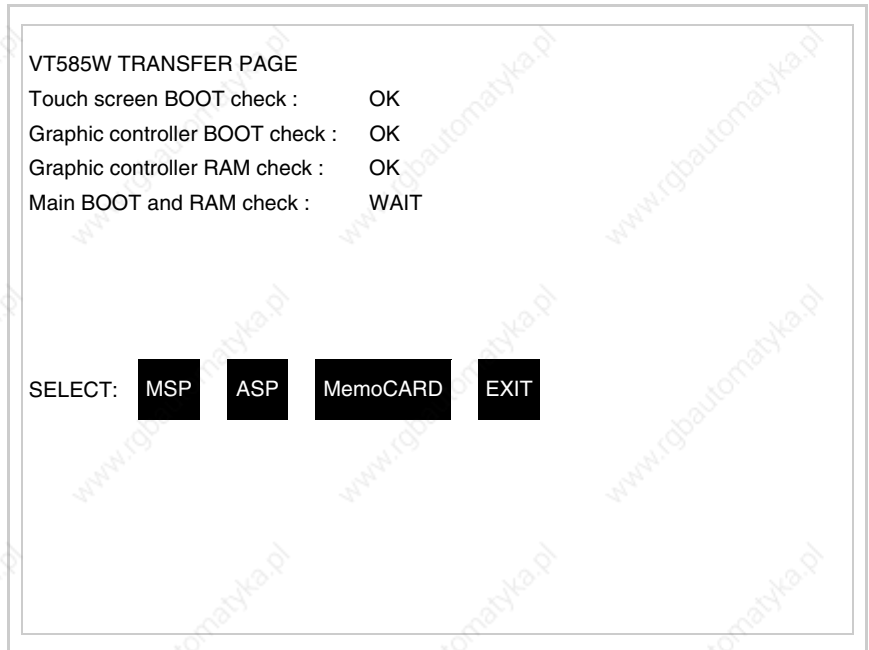

Touch the MemoCARD on the screen (if the key is not on screen, see Page 25-19) and the following mask will appear:

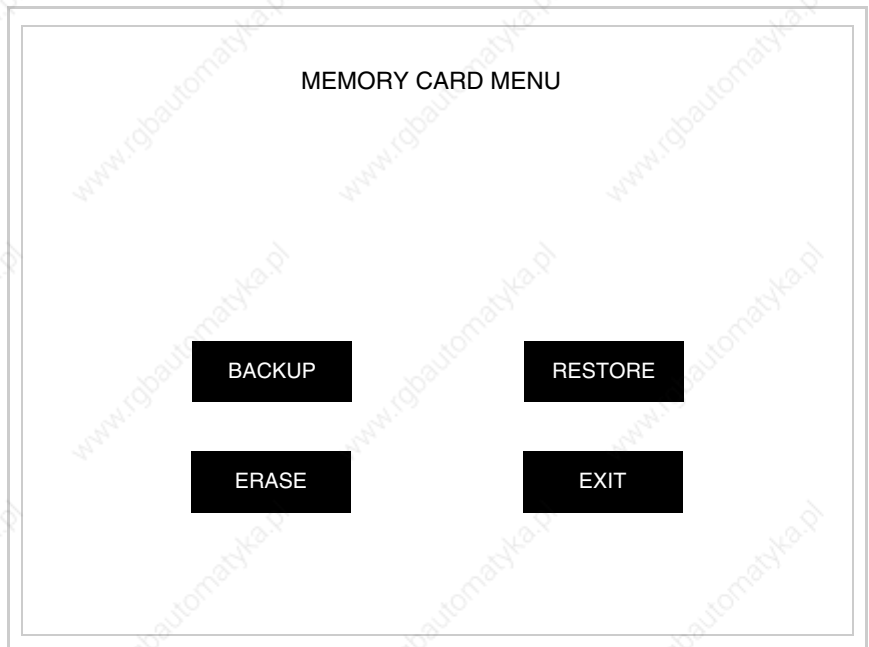

For the meaning and the functions of the keys see "Chapter 33 -> Memory card".

Possible error messages that may be encountered in the driver information page are:

- PR ERR

Problem-> Errors have been detected in the data exchange between the VT and the Device.

Solution-> Check the cable; there may be disturbance.

- COM BROKEN

Problem-> Communication between VT and Device interrupted.

Solution-> Check the serial connection cable.

An error message followed by [*] indicates that the error is not currently present but was and has since disappeared.

Example: COM BROKEN*

When  is pressed you quit the display of information regarding the driver.

Improving display color quality

To improve the color quality, adjust the contrast of the display: if the colors are too dark increase the contrast; if, on the other hand, the colors are too light, decrease the contrast.

Adjusting the contrast on the display

To improve the quality of the representation on the display it may be necessary to adjust its contrast. This can be done by going to the page proposed (see Page 25-24) and changing the value (from +63 to -64) in evidence at that moment. Increase the value to darken the display; to lighten it decrease the value.

We advise this to be done at typical room temperature and with the terminal at operating temperature (about 30 minutes after switching on and with the screen saver disabled - see Software Manual).

 **This parameter has no effect when a TFT display is used. This kind of technology does not need adjustment.**

Chapter 26 Video terminal VT585WB

Contents	Page
Technical characteristics	26-2
Functions	26-4
Front view	26-8
Standard series rear view	26-9
Profibus-DP series rear view	26-10
CAN series rear view	26-11
Ethernet series rear view	26-12
Dimensions and Cut-out	26-13
Accessories	26-14
Calibration of Touch Screen	26-14
Termination of CAN line	26-17
Introducing the MAC address	26-18
Transfer PC -> VT	26-21
Preparation for reception	26-21
Information relating to driver	26-23
Improving display color quality	26-29
Adjusting the contrast on the display	26-29

This chapter consists of 30 pages.

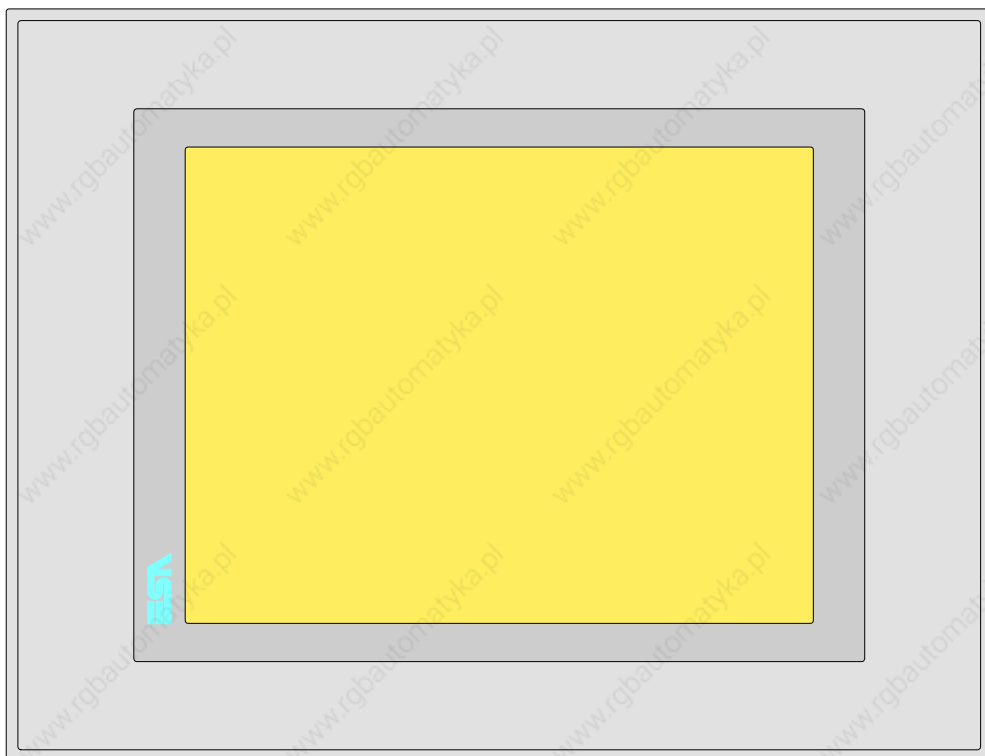

Technical characteristics

The following table lists the principal technical characteristics of the product in question.

Code of terminal	Characteristics of the terminal			
VT585W BPT00				
VT585W BPTDP				
VT585W BPTCN				
VT585W BPTET				
Display		▼	▼	▼
Type	LCD Monochromatic STN			
	LCD 256 Colors STN			
	LCD 256 Colors TFT	●	●	●
Touch screen [cells]	Matrix 40x30 (Cell:16x16 pixels)	●	●	●
Representational format	Graphic	●	●	●
Resolution [pixels]	640 x 480 (10,4")	●	●	●
Rows per character	30 x 80 / 15 x 40 / 7 x 20	●	●	●
Dimension of visible area [mm]	211,2 x 158	●	●	●
Character matrix in text mode [pixels]	8 x16 / 16 x 32 / 32 x 64	●	●	●
Character size [mm] x1 / x2 / x4	2,7 x 5,4 / 5,4 x 10,7 / 10,7 x 21,4	●	●	●
Contrast adjustment	Software	●	●	●
	Automatic compensation with temperature			
Character set	Programmable fonts/TTF Windows ®	●	●	●

Code of terminal	Characteristics of the terminal			
VT585W BPT00				
VT585W BPTDP				
VT585W BPTCN				
VT585W BPTET				
Backlighting				
Type	LED			
	CCFL lamp	●	●	●
Minimum lamp-life at 25°C [hours]	30000	●	●	●
User memory				
Project [Bytes]	960K + 6M (Text + Graphic)	●	●	●
Data memory [Bytes]	128K (Flash EPROM)	●	●	●
Memory for Windows ® -based fonts [Byte]	512K	●	●	●
Memory Card for backup	8Mb	●	●	●
Memory Card for expansion	4Mb (Only for graphic type)			
Interfaces				
MSP (Multi-serial port)	RS232/RS422/RS485/TTY-20mA	●	●	●
ASP (Auxiliary serial port)	RS232/RS485			●
ASP-15L (Auxiliary serial port)	RS232/RS485			
ASP-8 (Auxiliary serial port)	RS232			
ASP-9 (Auxiliary serial port)	RS232			
LPT parallel port	Centronics	●	●	●
Auxiliary port	Connection for accessory devices			
Accessories				
Connectable accessories	See table "Chapter 33"	●	●	●
Clock				
Clock	Hardware (with Supercapacitor - Min.72h Typically130h)	●	●	●
Networks				
Integrated	Profibus-DP			●
	CAN Open (Optoisolated interface)		●	
	Ethernet 10/100Mbit RJ45	●		
Universal Bus Connector	--			
Optional	See table "Chapter 33"	●	●	●
Proprietary networks				
ESA-Net	Network server	●	●	●
	Network client	●	●	●
Technical data				
Power supply	24Vdc (18..32Vdc)			
Power absorbed at 24Vdc	15W			
Protection fuse	Ø5x20mm - 1,25A Quick Blow F			
Protection level	IP65 (front-end)			
Operating temperature	0..50°C			
Storage and transportation temperature	-20..+60°C			
Humidity (non-condensing)	<85%			
Weight	1900gr			
Dimensions				
External W x H x D [mm]	336,3 x 256 x 44			
Cut-out W x H [mm]	314 x 240			
Certification				
Certifications and approvals	CE, cULus, NEMA12			

Functions

The following table lists in alphabetical order all the functions of the VT in question.

Table 26.1: Functions and objects realizable with this VT (Part 1 of 4)

Code of terminal		
VT585W B****		
Objects/Functions	Quantity	▼
Alarm field		●
Alarm help	1024	●
Alarm history buffer	256	●
Alarm statistics		
Alarms (Total/active simultaneously)	1024/256	●
Arc		●
Automatic operations	32	●
Backup/Restore		●
Bar data		●
Bit-wise password	8bits	●
Buttons	1200xpage	●
Circles		●
Command: Change language		●
Command: Clear trend buffer		●
Command: Delete recipe		●
Command: Hardcopy		●
Command: Load recipe from data memory		●
Command: Modify password		●
Command: Next page		●
Command: Page help		●
Command: Password login		●
Command: Password logout		●
Command: Previous page		●
Command: Print alarm history		●
Command: Printer form feed		●
Command: Quit project		●
Command: Report		●
Command: Restarts reading time-sampled trend		●
Command: Run pipeline		●
Command: Save alarms history and trend buffers in flash		●
Command: Save recipe in data memory		●
Command: Save recipe received from device in buffer		●
Command: Save recipe received from device in data memory		●
Command: Send recipe from video buffer to device		●
Command: Send recipe to device		●
Command: Service page		●

Unless otherwise stated, there is no limit to the number of includable elements, only the size of project memory sets a limit.
*) indicative value determined by the dimensions of the project, **) depends on memory available

Table 26.1: Functions and objects realizable with this VT (Part 2 of 4)

Code of terminal		
VT585W B****		
Objects/Functions	Quantity	▼
Command: Show alarms history		●
Command: Show page directory		●
Command: Show project information		●
Command: Show recipe directory		●
Command: Show sequence directory		
Command: Shows driver status page		●
Command: Shows page help		●
Command: Shows page with function: PG		
Command: Stops reading time sampled trend		●
Command: Trend reading saved in device		●
Command: Zero number of general pages		●
Date field		●
Day-of-the-week field		●
Dynamic texts: Bit-group-structured dynamic texts		●
Dynamic texts: Single-bit dynamic texts	1024*	●
Dynamic texts: Value-structured dynamic texts		●
E-keys		
Equations	32	●
F-keys		
Free terminal		
Function: Disables key		
Function: Go to page		●
Function: Internal command		●
Function: Invert bit value		●
Function: Macro		●
Function: None		
Function: Reset bit permanently		●
Function: Reset real-time bit		●
Function: Sequences		
Function: Sets bit permanently		●
Function: Sets real-time bit		●
Function: Value-structure direct command		●
Global configuration of E-keys		
Global configuration of F-keys		
Headers and footers (Total/Number of fields per H-F)	128/128	●
Info-messages (Total/active simultaneously)	1024/256	●
Internal registers	4096bytes	●
Labels		●
LEDs assigned to sequence		

Unless otherwise stated, there is no limit to the number of includable elements, only the size of project memory sets a limit.
 *) indicative value determined by the dimensions of the project, **) depends on memory available

Table 26.1: Functions and objects realizable with this VT (Part 3 of 4)

Code of terminal		
VT585W B****		
Objects/Functions	Quantity	
Lines		●
Lists of bitmap images		●
Lists of texts		●
Local configuration of E-keys		
Local configuration of F-keys		
Macro field		
Macros (Total/Commands x macro)	1024/16	●
Message field		●
Message help	1024	●
Multilanguage texts	8 Langs.	●
Object - Indicator	256	●
Object - Potentiometer knob	256	●
Object - Selector knob	256	●
Object - Sliding potentiometer	256	●
Object - Sliding selector	256	●
Page	1024	●
Page help	1024	●
Password	10	●
Pipelines (Number/Tot bytes)	64/512	●
Print		●
Print page (Total/Number of fields per page)	1024/128	●
Programmable fonts		●
Project images		●
Public variables of ESANET network (Number/Total bytes)	512/1024	●
Recipe field for recipe structure		●
Recipes (Number of variables per recipe)	1024/512	●
Rectangles		●
Redefinable characters		
Reports	128	●
Sequences - Random		
Sequences - Start/stop		
Static bitmaps		●
Symbolic field: Bit-group-structured dynamic bitmaps	1024*	●
Symbolic field: Single-bit-structured dynamic bitmaps		●
Symbolic field: Value-structured dynamic bitmaps		●
System messages		●
System variables assigned to recipe structure		●
Time long field		●
Time short field		●

Unless otherwise stated, there is no limit to the number of includable elements, only the size of project memory sets a limit.
 *) indicative value determined by the dimensions of the project, **) depends on memory available

Table 26.1: Functions and objects realizable with this VT (Part 4 of 4)

Code of terminal		
VT585W B****		
Objects/Functions	Quantity	▼
Timer	32	●
Touch Area	256	●
Trend buffers	128	●
Trends (Trends x page/Channels x trend)	8/8	●
Trends sampled automatically (Memory/Trends/Readings)	8192bytes	●
Trends sampled on command (Memory/Trends/Readings)	/**/640	●
Value direct command: ADD		●
Value direct command: AND		●
Value direct command: OR		●
Value direct command: SET		●
Value direct command: SUBTRACT		●
Value direct command: XOR		●
Variables: Limit values and linear scaling variables	320 x pages	●
Variables: Movement variable (Mobile symbolic field)		●
Variables: Threshold variables		●
Variables: Floating Point numerical variables		●
Variables: Numerical variables (DEC, HEX, BIN, BCD)		●
Variables: String variables (ASCII)		●

Unless otherwise stated, there is no limit to the number of includable elements, only the size of project memory sets a limit.
 *) indicative value determined by the dimensions of the project, **) depends on memory available

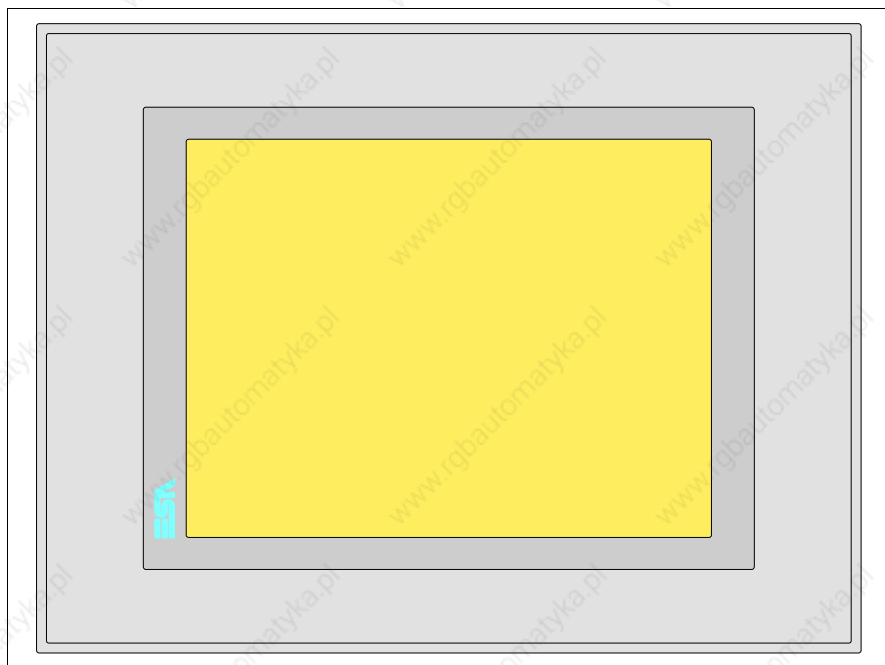
Front view

All buttons and signals are defined via the programming software (see Software Manual).

Standard series rear view

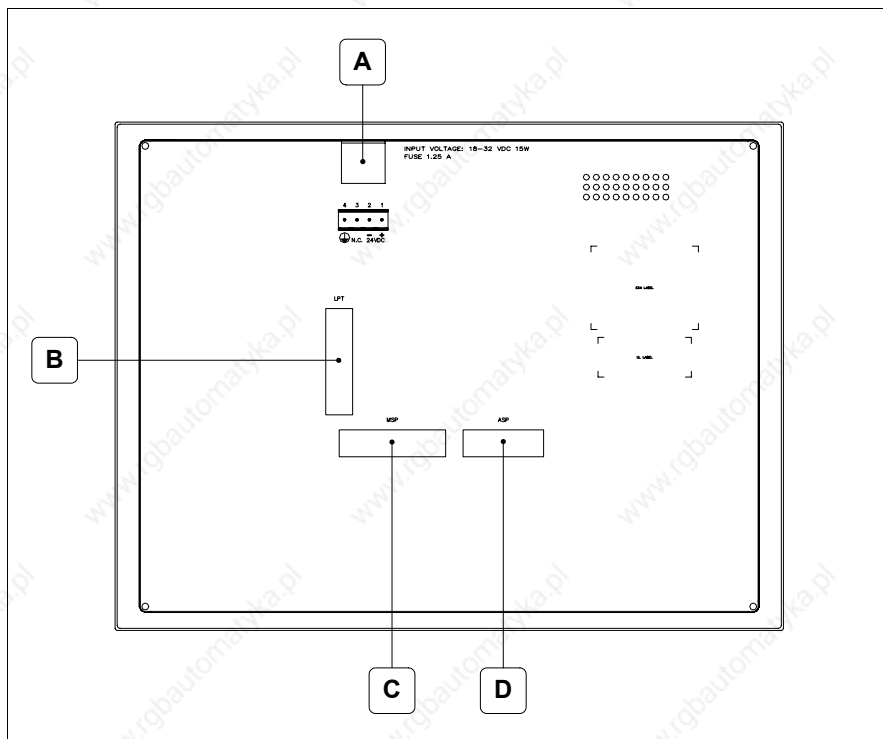

Position	Function
A	Power supply connector
B	LPT port for connecting printer
C	MSP serial port for communicating with PLC/PC
D	ASP serial port for communicating with PC or other devices

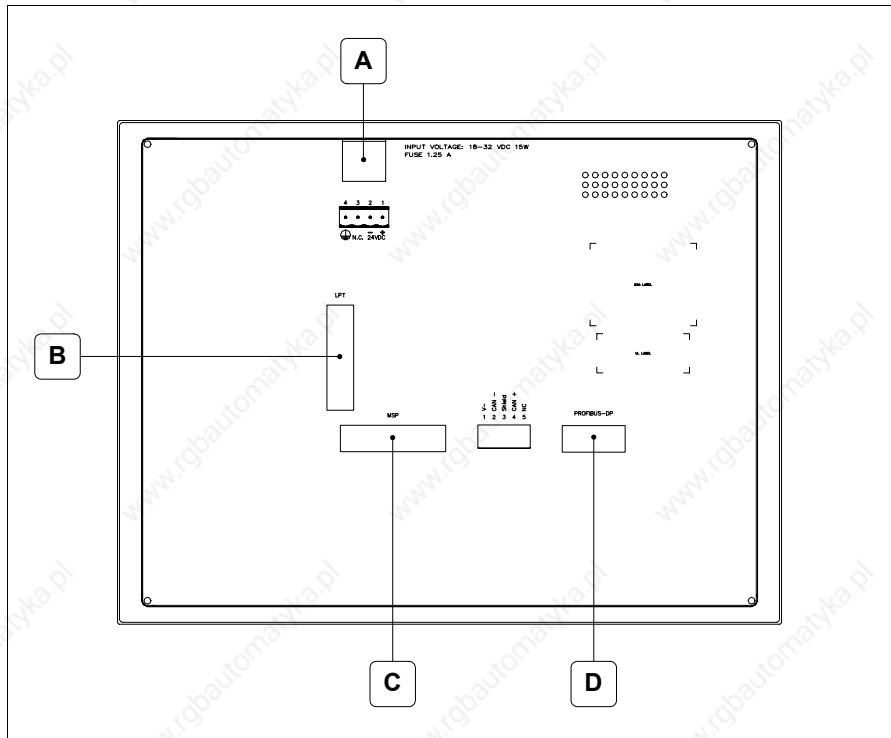
**Profibus-DP
series rear
view**

Position	Function
A	Power supply connector
B	LPT port for connecting printer
C	MSP serial port for communicating with PLC/PC
D	Serial port for network communication

CAN series rear view

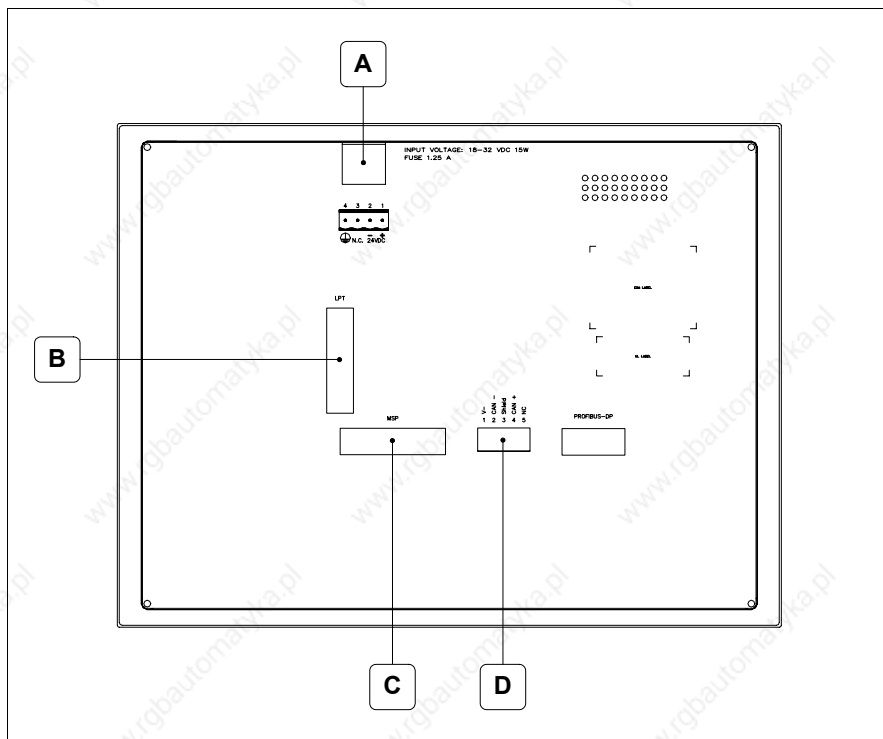

Position	Function
A	Power supply connector
B	LPT port for connecting printer
C	MSP serial port for communicating with PLC/PC
D	CAN serial port

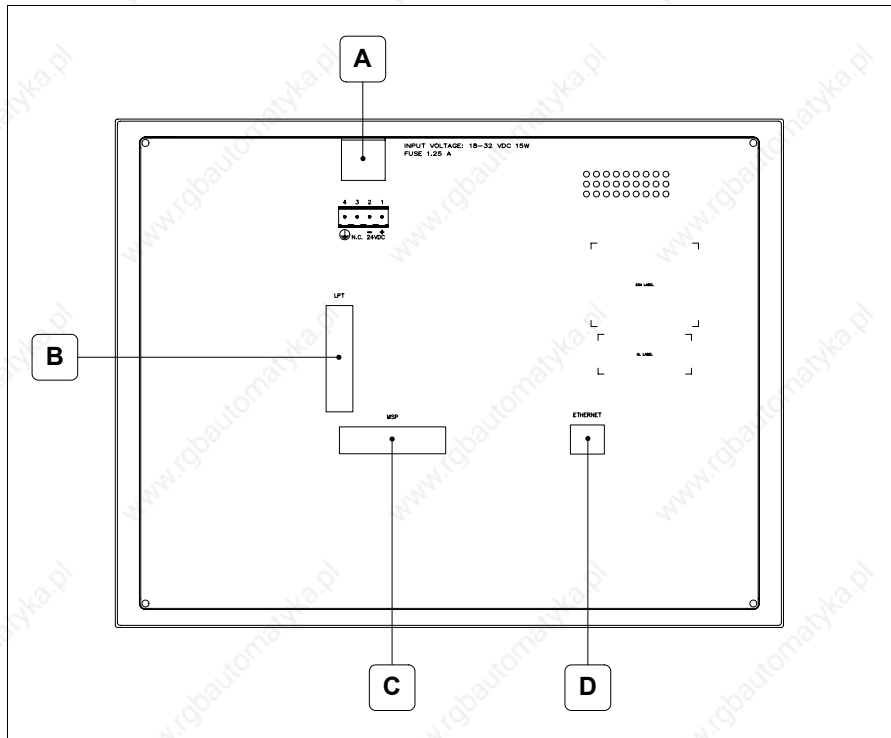
**Ethernet
series rear
view**

Position	Function
A	Power supply connector
B	LPT port for connecting printer
C	MSP serial port for communicating with PLC/PC
D	Ethernet network 10/100Mbit RJ45 (For the diagnostic mode of the LEDs see "Chapter 30 -> Ethernet port")

Dimensions and Cut-out

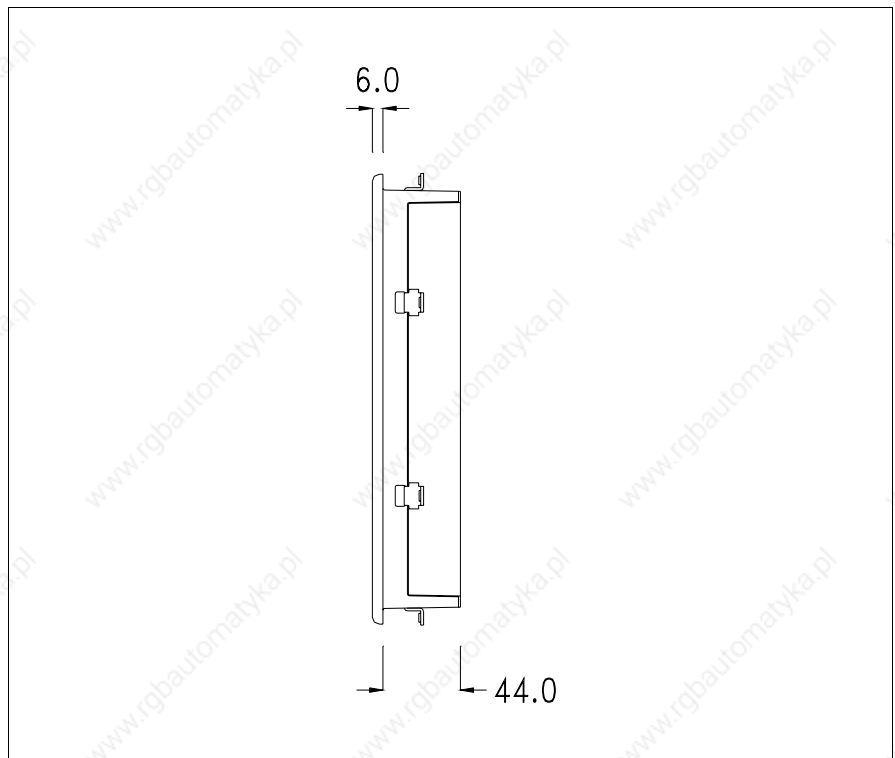
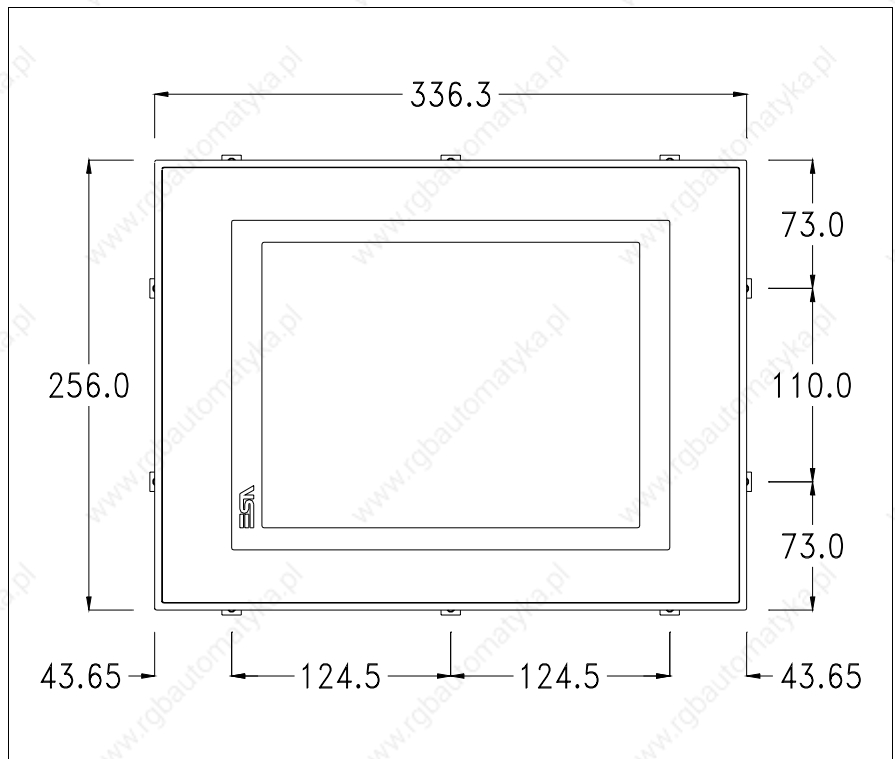

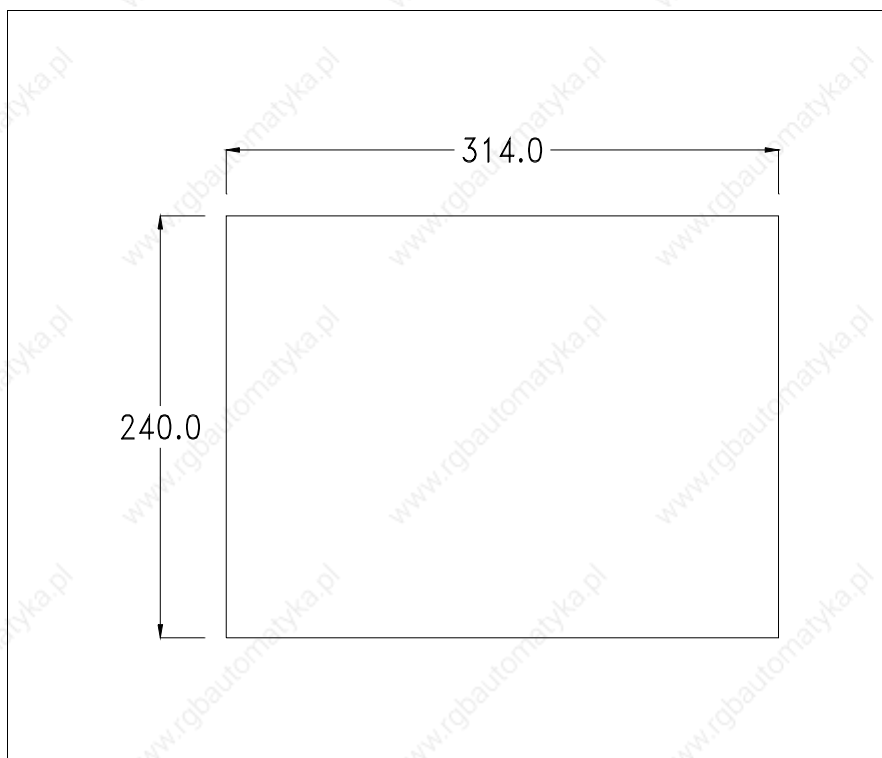

To fix the sealing gasket and secure the VT to the container see “Chapter 29 -> Mounting the terminal within the container“.

⚠ Where accessories need to be fixed in or onto the VT terminal, you are advised to do this before securing the VT to its container.

Accessories

Any accessories should be mounted in accordance with the instructions in the relevant chapter (see “Chapter 33 -> Video terminal accessories“).

Calibration of Touch Screen

The screen of VT585WB is made of resistive, sensitive glass; for this type of glass to work properly it requires a calibration procedure (**the terminal is already calibrated when supplied**), that is, the resistive area of the glass has to be adjusted to the visible area of the display.

Should it be thought necessary to repeat the calibration procedure this can be done by following the instructions set out below.

⚠ The procedure must be carried out with great care as the precision of the keys area depends on the calibration.

How to perform the calibration procedure:

- Make sure the VT is not connected to the power supply
- Remove the back cover
- Identify jumper J11

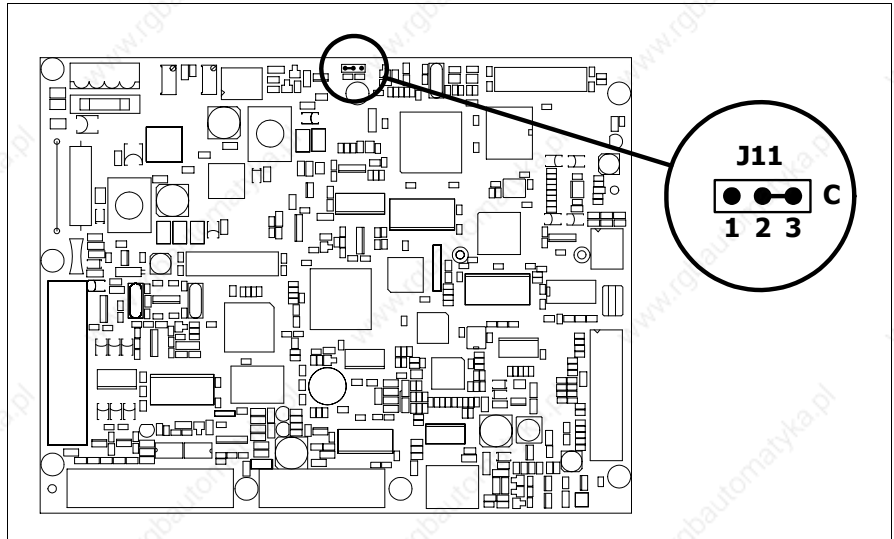

- Position J11 on pins 2-3 (C)
- Reconnect the power supply and switch on the terminal; the following mask appears

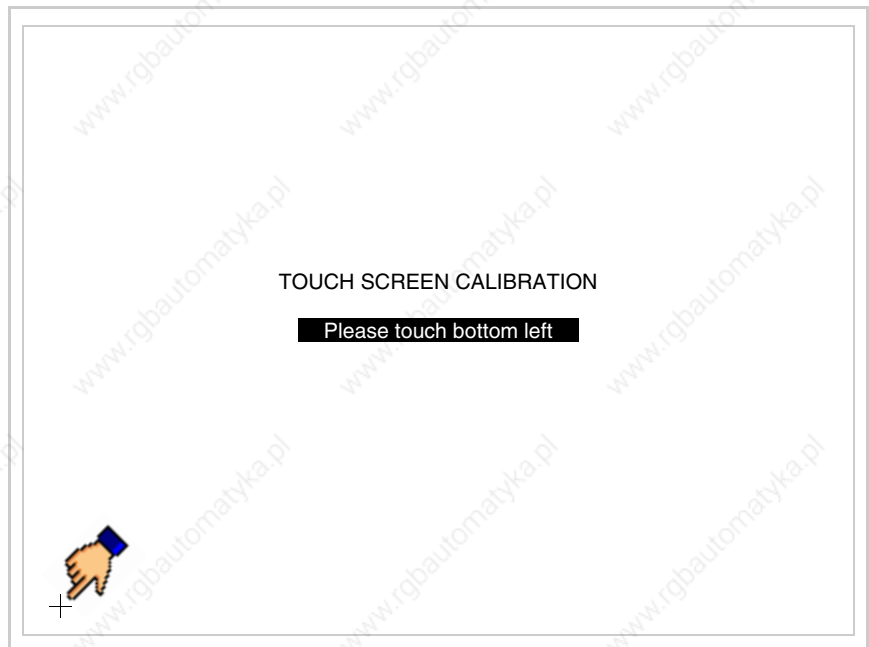

- Touch the corner indicated in the figure; then the following page appears on screen

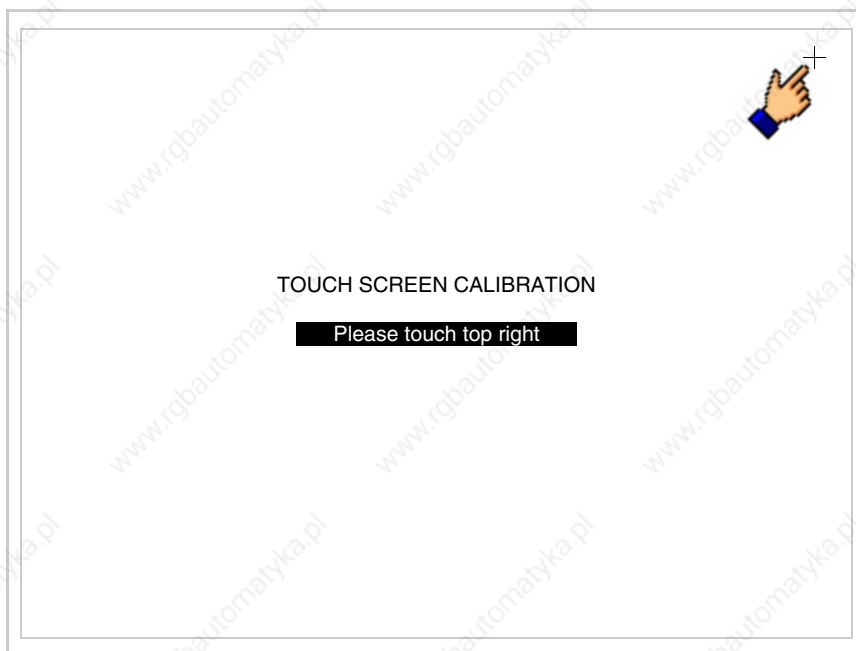

- Touch the corner indicated in the figure to complete the Calibrazione procedure; the following page now appears



- Wait a few moments until the VT displays either the following mask or the project page

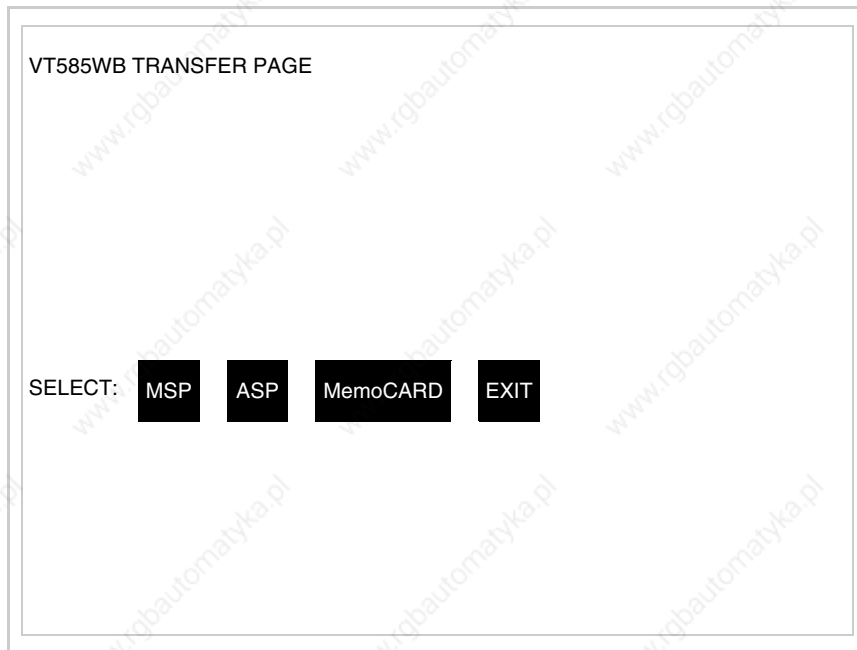

- Switch off the terminal
- Reposition J11 on pins 1-2
- Replace the back cover
- Switch on the terminal again

The calibration procedure has finished; if the calibration has been carried out wrongly or imprecisely, repeat the procedure.

Termination of CAN line

This paragraph applies only to the CAN series. The VT in question integrates the termination resistances of the serial line (typically 120 ohms) which can be inserted by means of a jumper (preset on 1-2, line not terminated). To activate the termination:

- Make sure the device is not connected to the power supply.
- Remove the cover.
- Identify the jumper unit J14.

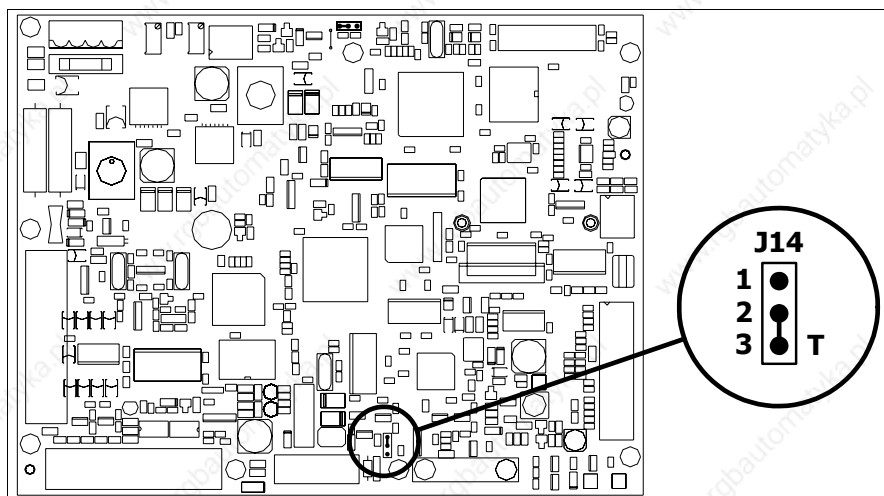

- Position the jumper between pins 2 and 3 (line terminated).
- Replace the back cover.
- Reconnect the power supply.

Introducing the MAC address

This paragraph relates only to the Ethernet series. The Media Access Control (MAC) address unambiguously identifies each terminal connected in the Ethernet network. The terminal is acquired with the address already programmed and is shown on the display of the terminal in the transfer page.

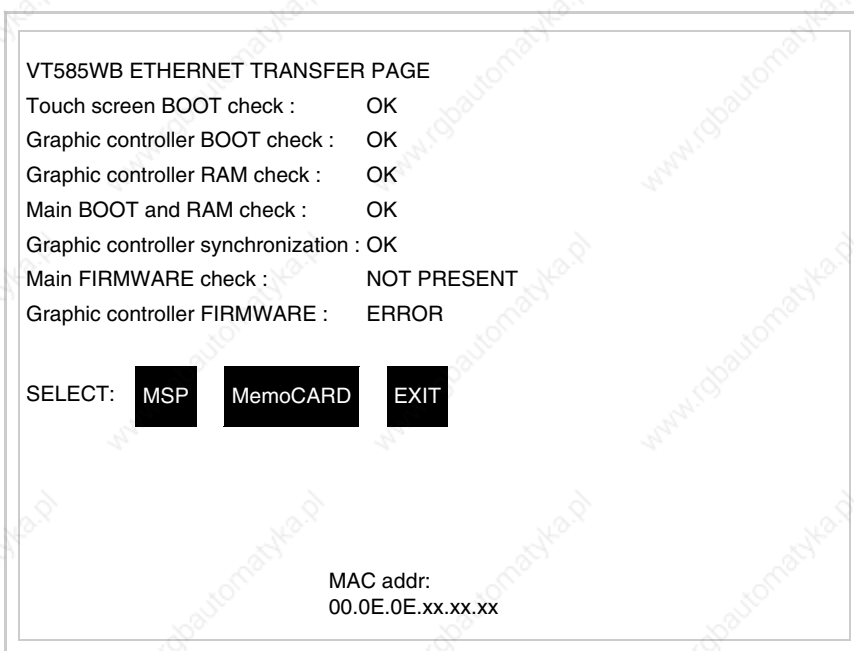

The MAC address is permanently memorized in the terminal, but should it

be necessary to execute an “aided” BOOT update (see Software Manual “Chapter 14 -> BOOT update“) the address is lost.

⚠ This operation must be carried out only with the advice of the ESA Customer Care Department.

Terminals with no valid MAC address when switched present a mask for its insertion. If no MAC address belonging to the terminal is available, proceed as follows:

- Check that the VT is not connected to the power supply.
- Remove the back cover
- Locate the label carrying the MAC address

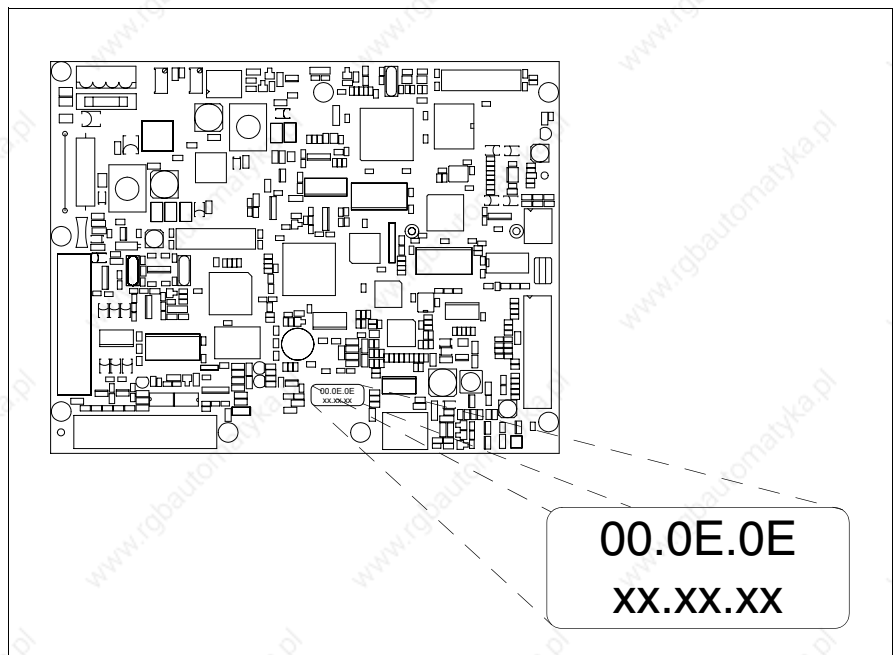

- Make a note of the number on the label (e.g. 00.0E.0E.00.00.01)

00.0E.0E -> fixed part that identifying as an ESA product
 XX.XX.XX -> variable part different for each terminal

- Reconnect the power supply to the terminal and, if necessary, calibrate the touch screen (see Page 26-14)
- Replace the back cover
- Switch on the terminal again
- The following mask appears; introduce the address previously noted down (e.g. 00.0E.0E.00.00.01)

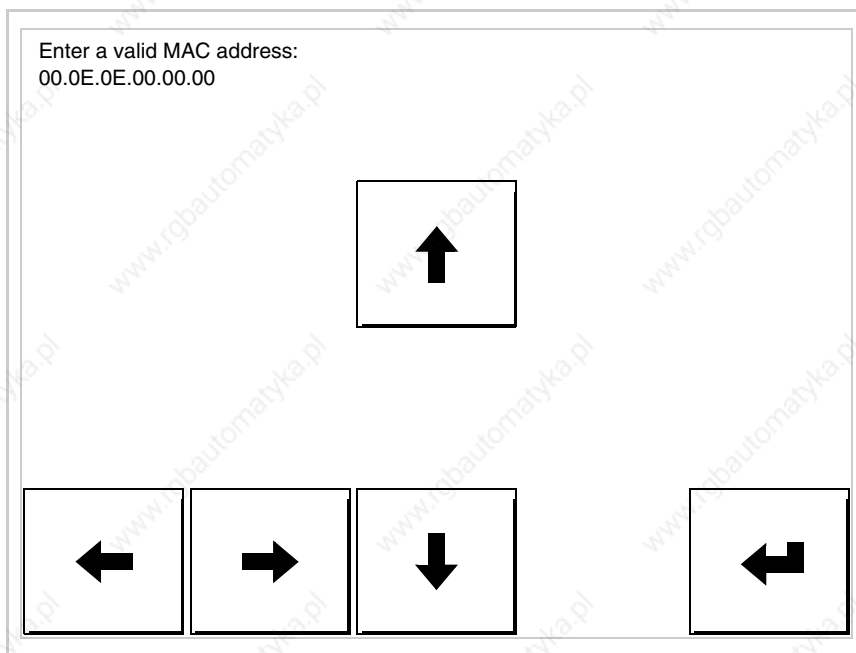

Enter a valid MAC address:
00.0E.0E.00.00.00

↑

← → ↓ ↶

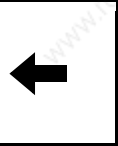
- Use the arrow  to make the setting. Once the address has been confirmed the following page is displayed

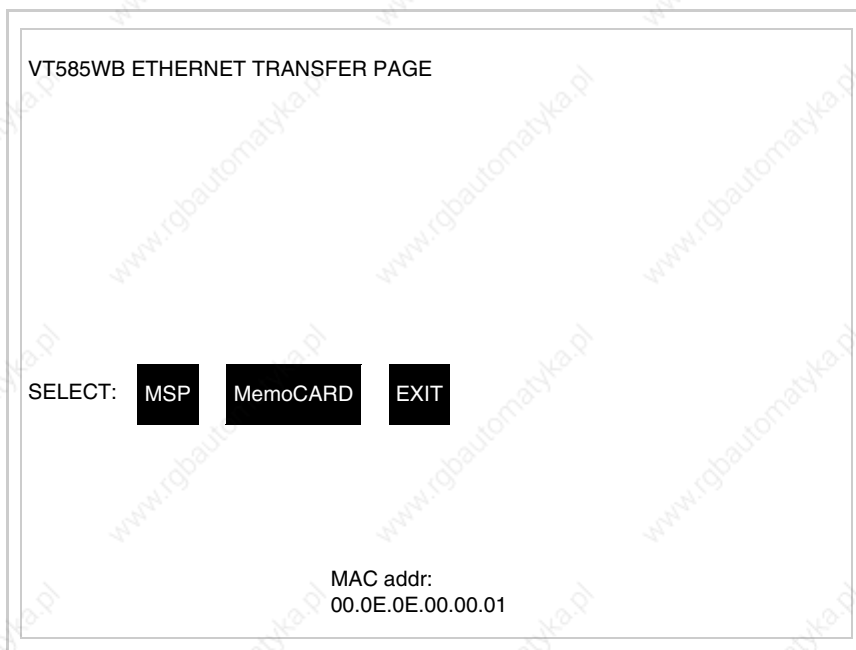

VT585WB ETHERNET TRANSFER PAGE

SELECT: **MSP** **MemoCARD** **EXIT**

MAC addr:
00.0E.0E.00.00.01

The procedure is now terminated.



Should a wrong MAC address have been inserted contact the ESA Customer Care Department.

⚠ A wrong address could give rise to an error of conflict between VT terminals in the Ethernet network.

Transfer PC -> VT

For everything to function properly, the first time the VT operator terminal is switched on it needs to be correctly loaded, that is it needs to have transferred to it:

- Firmware
- Communication driver
- Project

(Given that the transfer of the three files in practice occurs with a single operation, it will be defined as “Project transfer” for the sake of simplicity.)

For this it is essential that the VT be prepared to receive the transfer. (See also “Chapter 37 -> Command area”).

Preparation for reception

The programme VTWIN must be used for the transfer (see Software Manual), but the terminal must be prepared for reception.

This means carrying out the following steps:

- Check that the VT is off
- Check that there is a serial connection between the PC and the VT
- Switch on the VT and wait for the following mask to appear
- Press one after the other two diagonally opposite corners free of settable objects or buttons (at least one corner needs to be free)

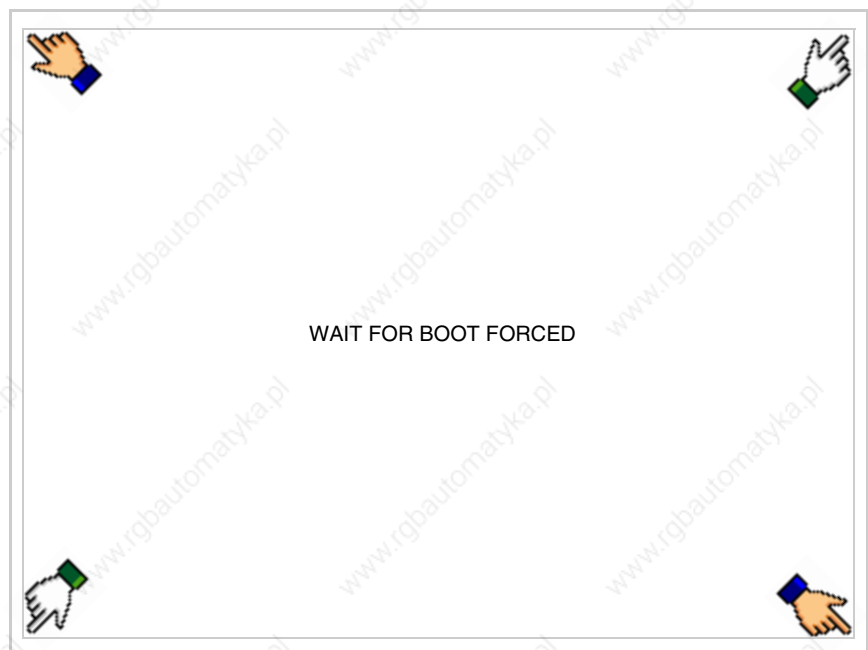

and wait a few moments, alternatively use the button provided (see Page 26-21), until the VT displays the following mask

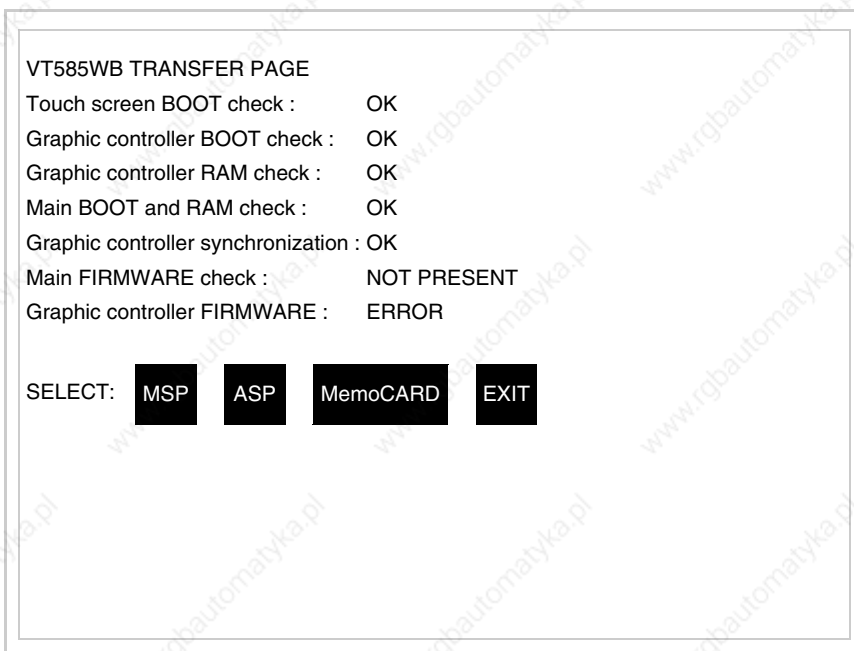

- Choose the port you intend to use for the transfer (MSP or ASP); touch the relevant on the display. The VT is now ready to receive (refer to Software Manual for transfer procedure). The MemoCARD appears if the Memory Card has been inserted in the VT (see Page 26-27)

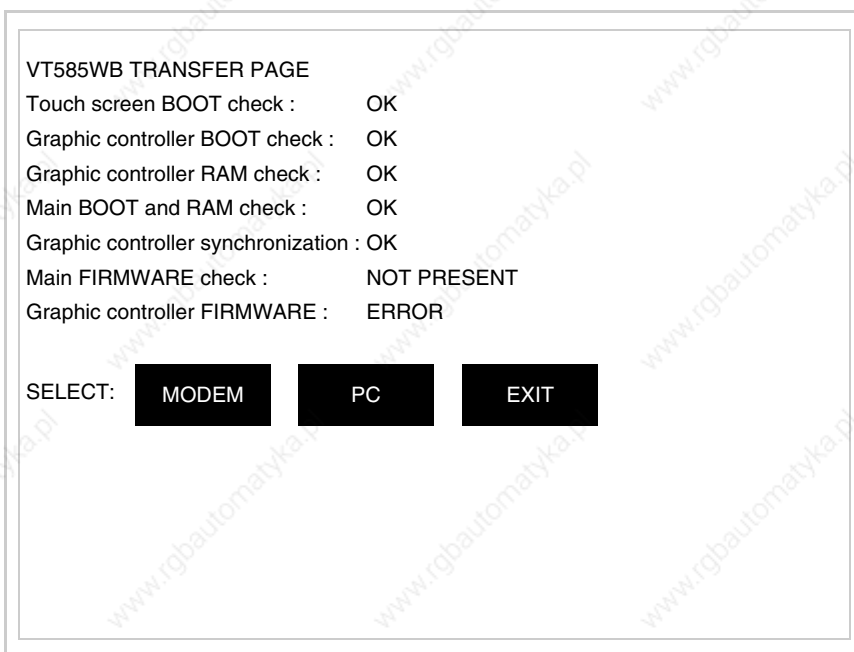

- Choose the required transfer mode: MODEM if you intend to use a modem or PC if you intend to use a serial port; touch the relevant on the display

If the choose made is PC, the VT is ready to receive (see Software Manual for transfer), if, on the other hand, you choose MODEM, the following mask will appear

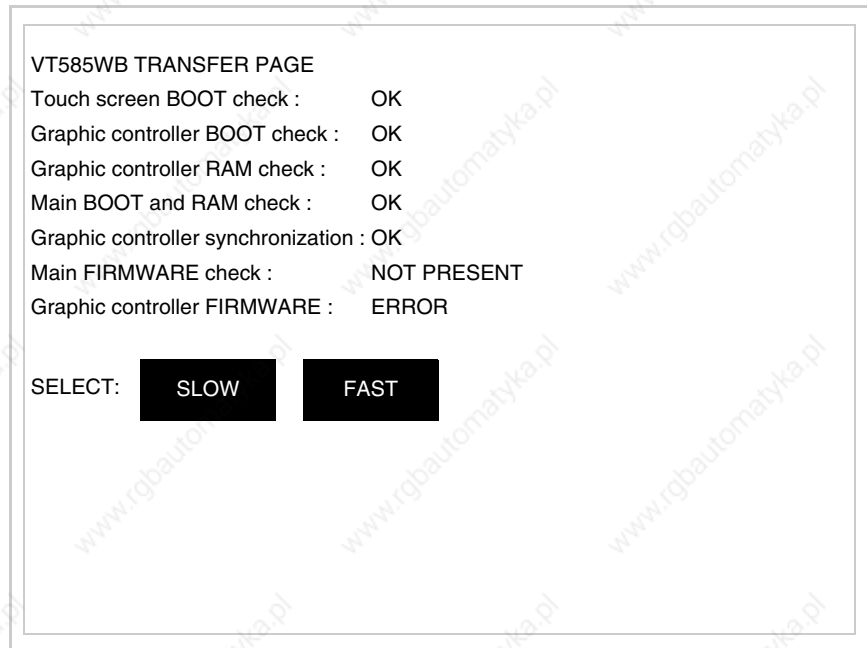

The choice should be according to the speed you intend to use for the transfer (Slow=9600bit/sec or Fast=38400bit/sec), touch the relevant on the display. The VT is now ready to receive (see Software Manual for the transfer).

Information relating to driver

After the project has been transferred, the VT can make available information relating to what has been loaded. The information regards:

- Serial ports present
- The name of the driver loaded
- The version of the driver loaded
- Network address of the VT
- Last error to have occurred

To acquire this information carry out the following operations:

- Be situated in any page of the project
- Press two diagonally opposed angles that are free of any settable objects

or buttons (at least one angle must be free)



and you will see



There is one of these pages for each communication port; movement between the various pages is effected by pressing .

From this page you can:

- Set the clock and the contrast
- Prepare the VT to receive the program
- Use the Memory Card

Setting the clock and the contrast:

To set the clock and the contrast, while displaying the above illustrated page, press ; the following mask appears

SET CONTRAST : ±##

SET CLOCK :
ddd,dd/mm/yy
hh:mm:ss

ESC

To set the contrast touch the words SET CONTRAST on the display; you will see the following mask



Use the arrow  for any variation (see "Chapter 36 -> Operation of terminal with touch screen").

To set the clock touch the words SET CLOCK on the display; the following mask appears

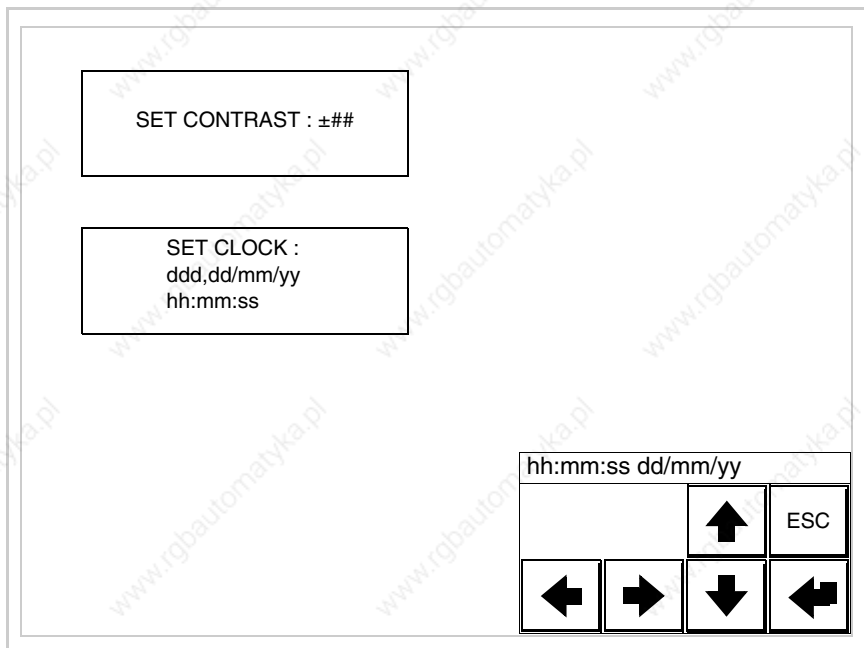

Use the arrow  for any variation (see “Chapter 36 -> Operation of terminal with touch screen”).

Prepare the VT to receive the program:

To prepare the VT to receive the program, while displaying the driver information page (see Page 26-23), press , and you will see the following mask

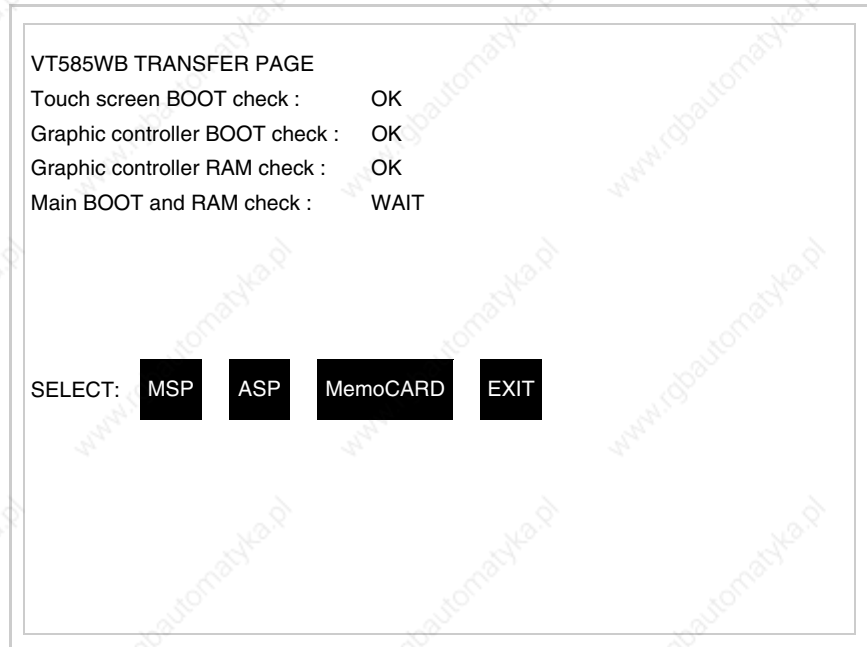

The on-screen  to press depends on the port you intend to use (MSP or ASP). The VT terminal is now ready to receive (consult Software Manual for information on the transmission procedure).

Using the Memory Card:

While displaying the driver information page, press  and the following mask will appear:

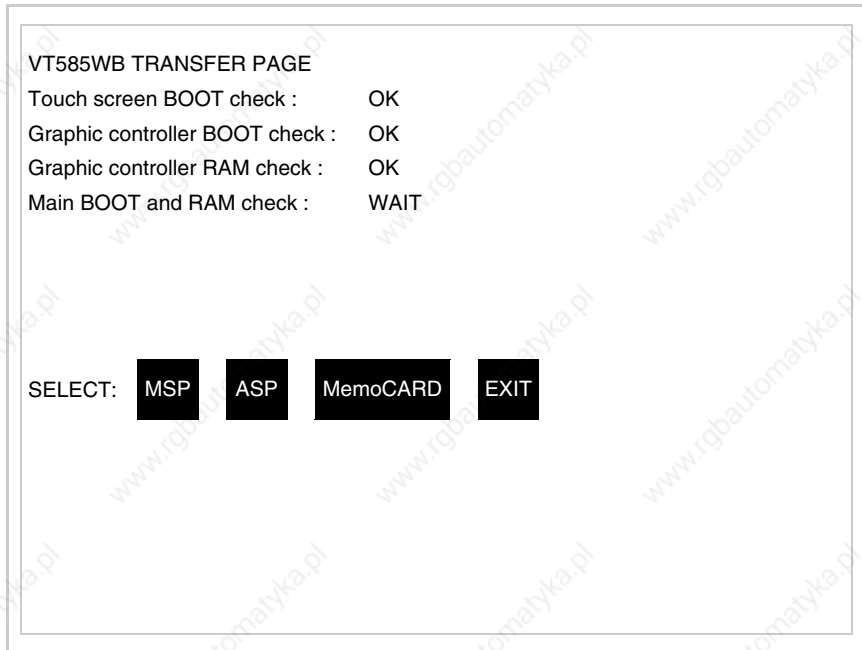

Touch the MemoCARD on the screen (if the key is not on screen, see Page 26-21) and the following mask will appear:

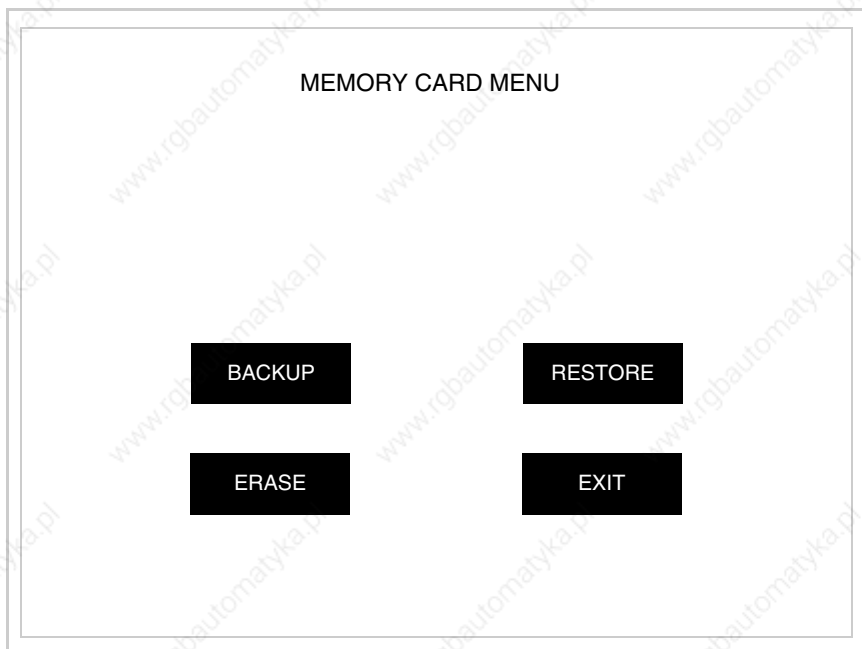

For the meaning and the functions of the keys see "Chapter 33 -> Memory card".

Possible error messages that may be encountered in the driver information page are:

- PR ERR

Problem-> Errors have been detected in the data exchange between the VT and the Device.

Solution-> Check the cable; there may be disturbance.

- COM BROKEN

Problem-> Communication between VT and Device interrupted.

Solution-> Check the serial connection cable.

An error message followed by [*] indicates that the error is not currently present but was and has since disappeared.

Example: COM BROKEN*

When  is pressed you quit the display of information regarding the driver.

Improving display color quality

To improve the color quality, adjust the contrast of the display: if the colors are too dark increase the contrast; if, on the other hand, the colors are too light, decrease the contrast.

Adjusting the contrast on the display

To improve the quality of the representation on the display it may be necessary to adjust its contrast. This can be done by going to the page proposed (see Page 26-25) and changing the value (from +63 to -64) in evidence at that moment. Increase the value to darken the display; to lighten it decrease the value.



This parameter has no effect when a TFT display is used. This kind of technology does not need adjustment.

Chapter 27 Video terminal VT595W

Contents	Page
Technical characteristics	27-2
Functions	27-4
Front view	27-8
Standard series rear view	27-9
Profibus-DP series rear view	27-10
CAN series rear view	27-11
Ethernet series rear view	27-12
Dimensions and Cut-out	27-13
Accessories	27-14
Calibration of Touch Screen	27-14
Termination of CAN line	27-17
Introducing the MAC address	27-18
Transfer PC -> VT	27-21
Preparation for reception	27-21
Information relating to driver	27-23
Improving display color quality	27-29
Adjusting the contrast on the display	27-29

This chapter consists of 30 pages.

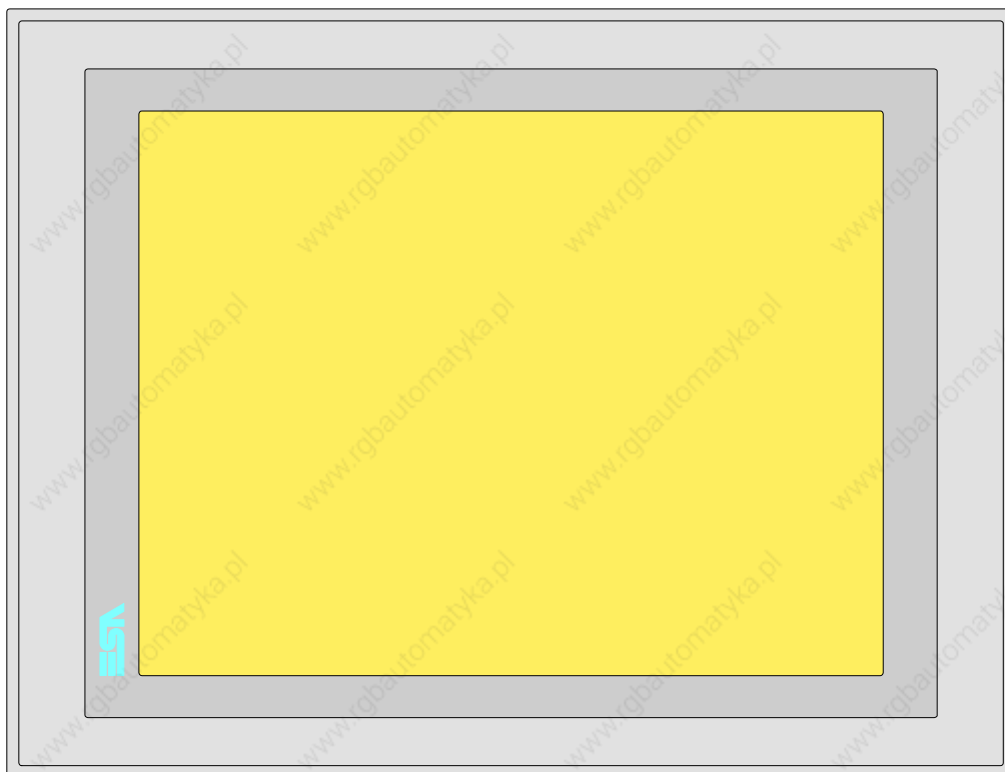

Technical characteristics

The following table lists the principal technical characteristics of the product in question.

Code of terminal	Characteristics of the terminal			
VT595W APT00				
VT595W OPTDP				
VT595W OPTCN				
VT595W OPTET				
Display		▼	▼	▼
Type	LCD Monochromatic STN			
	LCD 256 Colors STN			
	LCD 256 Colors TFT	●	●	●
Touch screen [cells]	Matrix 50x40 (Cell:16x15 pixels)	●	●	●
Representational format	Graphic	●	●	●
Resolution [pixels]	800 x 600 (12,1")	●	●	●
Rows per character	40 x 100 / 20 x 50 / 10 x 25	●	●	●
Dimension of visible area [mm]	246 x 185	●	●	●
Character matrix in text mode [pixels]	8 x15 / 16 x 30 / 32 x 60	●	●	●
Character size [mm] x1 / x2 / x4	2,5 x 4,6 / 5 x 9,2 / 10 x 18,4	●	●	●
Contrast adjustment	Software	●	●	●
	Automatic compensation with temperature			
Character set	Programmable fonts/TTF Windows ®	●	●	●

Code of terminal	Characteristics of the terminal			
VT595W APT00				
VT595W OPTDP				
VT595W OPTCN				
VT595W OPTET				
Backlighting				
Type	LED			
	CCFL lamp	●	●	●
Minimum lamp-life at 25°C [hours]	50000	●	●	●
User memory				
Project [Bytes]	960K + 6M (Text + Graphic)	●	●	●
Data memory [Bytes]	128K (Flash EPROM)	●	●	●
Memory for Windows ® -based fonts [Byte]	512K	●	●	●
Memory Card for backup	8Mb	●	●	●
Memory Card for expansion	4Mb (Only for graphic type)			
Interfaces				
MSP (Multi-serial port)	RS232/RS422/RS485/TTY-20mA	●	●	●
ASP (Auxiliary serial port)	RS232/RS485			●
ASP-15L (Auxiliary serial port)	RS232/RS485			
ASP-8 (Auxiliary serial port)	RS232			
ASP-9 (Auxiliary serial port)	RS232			
LPT parallel port	Centronics	●	●	●
Auxiliary port	Connection for accessory devices			
Accessories				
Connectable accessories	See table "Chapter 33"	●	●	●
Clock				
Clock	Hardware (with Supercapacitor - Min.72h Typically130h)	●	●	●
Networks				
Integrated	Profibus-DP			●
	CAN Open (Optoisolated interface)		●	
	Ethernet 10/100Mbit RJ45	●		
Universal Bus Connector	--			
Optional	See table "Chapter 33"	●	●	●
Proprietary networks				
ESA-Net	Network server	●	●	●
	Network client	●	●	●
Technical data				
Power supply	24Vdc (18..32Vdc)			
Power absorbed at 24Vdc	15W			
Protection fuse	Ø5x20mm - 1,25A Quick Blow F			
Protection level	IP65 (front-end)			
Operating temperature	0..50°C			
Storage and transportation temperature	-20..+60°C			
Humidity (non-condensing)	<85%			
Weight	2100gr			
Dimensions				
External W x H x D [mm]	336,3 x 256 x 44			
Cut-out W x H [mm]	314 x 240			
Certification				
Certifications and approvals	CE, cULus, NEMA12			

Functions

The following table lists in alphabetical order all the functions of the VT in question.

Table 27.1: Functions and objects realizable with this VT (Part 1 of 4)

Code of terminal		
VT595W *****		
Objects/Functions	Quantity	▼
Alarm field		●
Alarm help	1024	●
Alarm history buffer	256	●
Alarm statistics		
Alarms (Total/active simultaneously)	1024/256	●
Arc		●
Automatic operations	32	●
Backup/Restore		●
Bar data		●
Bit-wise password	8bits	●
Buttons	1200xpage	●
Circles		●
Command: Change language		●
Command: Clear trend buffer		●
Command: Delete recipe		●
Command: Hardcopy		●
Command: Load recipe from data memory		●
Command: Modify password		●
Command: Next page		●
Command: Page help		●
Command: Password login		●
Command: Password logout		●
Command: Previous page		●
Command: Print alarm history		●
Command: Printer form feed		●
Command: Quit project		●
Command: Report		●
Command: Restarts reading time-sampled trend		●
Command: Run pipeline		●
Command: Save alarms history and trend buffers in flash		●
Command: Save recipe in data memory		●
Command: Save recipe received from device in buffer		●
Command: Save recipe received from device in data memory		●
Command: Send recipe from video buffer to device		●
Command: Send recipe to device		●
Command: Service page		●

Unless otherwise stated, there is no limit to the number of includable elements, only the size of project memory sets a limit.
*) indicative value determined by the dimensions of the project, **) depends on memory available

Table 27.1: Functions and objects realizable with this VT (Part 2 of 4)

Code of terminal		
VT595W ****		
Objects/Functions	Quantity	▼
Command: Show alarms history		●
Command: Show page directory		●
Command: Show project information		●
Command: Show recipe directory		●
Command: Show sequence directory		
Command: Shows driver status page		●
Command: Shows page help		●
Command: Shows page with function: PG		
Command: Stops reading time sampled trend		●
Command: Trend reading saved in device		●
Command: Zero number of general pages		●
Date field		●
Day-of-the-week field		●
Dynamic texts: Bit-group-structured dynamic texts		●
Dynamic texts: Single-bit dynamic texts	1024*	●
Dynamic texts: Value-structured dynamic texts		●
E-keys		
Equations	32	●
F-keys		
Free terminal		
Function: Disables key		
Function: Go to page		●
Function: Internal command		●
Function: Invert bit value		●
Function: Macro		●
Function: None		
Function: Reset bit permanently		●
Function: Reset real-time bit		●
Function: Sequences		
Function: Sets bit permanently		●
Function: Sets real-time bit		●
Function: Value-structure direct command		●
Global configuration of E-keys		
Global configuration of F-keys		
Headers and footers (Total/Number of fields per H-F)	128/128	●
Info-messages (Total/active simultaneously)	1024/256	●
Internal registers	4096bytes	●
Labels		●
LEDs assigned to sequence		

Unless otherwise stated, there is no limit to the number of includable elements, only the size of project memory sets a limit.
 *) indicative value determined by the dimensions of the project, **) depends on memory available

Table 27.1: Functions and objects realizable with this VT (Part 3 of 4)

Code of terminal		
VT595W *****		
Objects/Functions	Quantity	▼
Lines		●
Lists of bitmap images		●
Lists of texts		●
Local configuration of E-keys		
Local configuration of F-keys		
Macro field		
Macros (Total/Commands x macro)	1024/16	●
Message field		●
Message help	1024	●
Multilanguage texts	8 Langs.	●
Object - Indicator	256	●
Object - Potentiometer knob	256	●
Object - Selector knob	256	●
Object - Sliding potentiometer	256	●
Object - Sliding selector	256	●
Page	1024	●
Page help	1024	●
Password	10	●
Pipelines (Number/Tot bytes)	64/512	●
Print		●
Print page (Total/Number of fields per page)	1024/128	●
Programmable fonts		●
Project images		●
Public variables of ESANET network (Number/Total bytes)	1024/1024	●
Recipe field for recipe structure		●
Recipes (Number of variables per recipe)	1024/512	●
Rectangles		●
Redefinable characters		
Reports	128	●
Sequences - Random		
Sequences - Start/stop		
Static bitmaps		●
Symbolic field: Bit-group-structured dynamic bitmaps	1024*	●
Symbolic field: Single-bit-structured dynamic bitmaps		●
Symbolic field: Value-structured dynamic bitmaps		●
System messages		●
System variables assigned to recipe structure		●
Time long field		●
Time short field		●

Unless otherwise stated, there is no limit to the number of includable elements, only the size of project memory sets a limit.
*) indicative value determined by the dimensions of the project, **) depends on memory available

Table 27.1: Functions and objects realizable with this VT (Part 4 of 4)

Code of terminal		
VT595W ****		
Objects/Functions	Quantity	▼
Timer	32	●
Touch Area	256	●
Trend buffers	128	●
Trends (Trends x page/Channels x trend)	8/8	●
Trends sampled automatically (Memory/Trends/Readings)	8192bytes	●
Trends sampled on command (Memory/Trends/Readings)	/**/640	●
Value direct command: ADD		●
Value direct command: AND		●
Value direct command: OR		●
Value direct command: SET		●
Value direct command: SUBTRACT		●
Value direct command: XOR		●
Variables: Limit values and linear scaling variables	400 x pages	●
Variables: Movement variable (Mobile symbolic field)		●
Variables: Threshold variables		●
Variables: Floating Point numerical variables		●
Variables: Numerical variables (DEC, HEX, BIN, BCD)		●
Variables: String variables (ASCII)		●

Unless otherwise stated, there is no limit to the number of includable elements, only the size of project memory sets a limit.
 *) indicative value determined by the dimensions of the project, **) depends on memory available

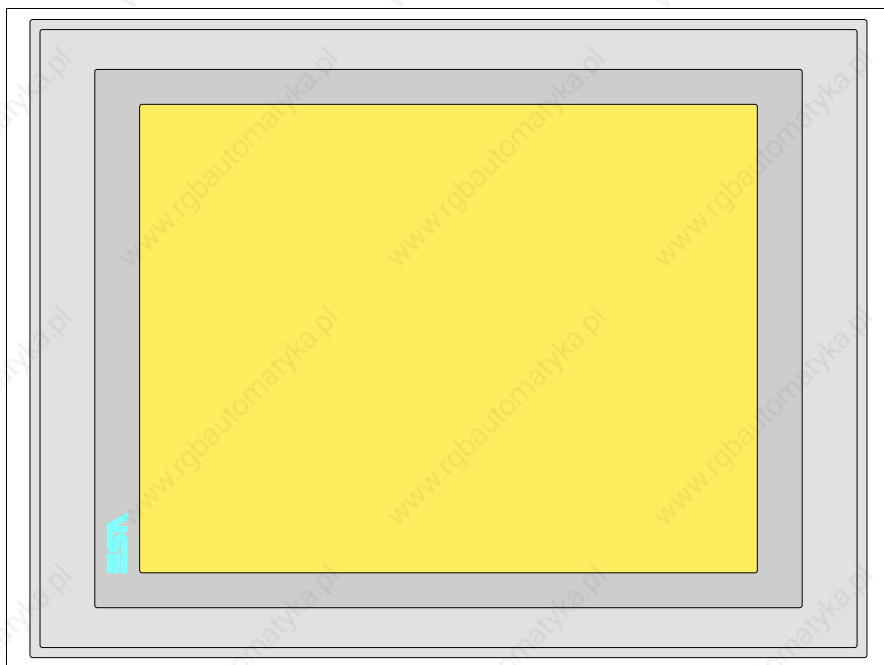
Front view

All buttons and signals are defined via the programming software (see Software Manual).

Standard series rear view

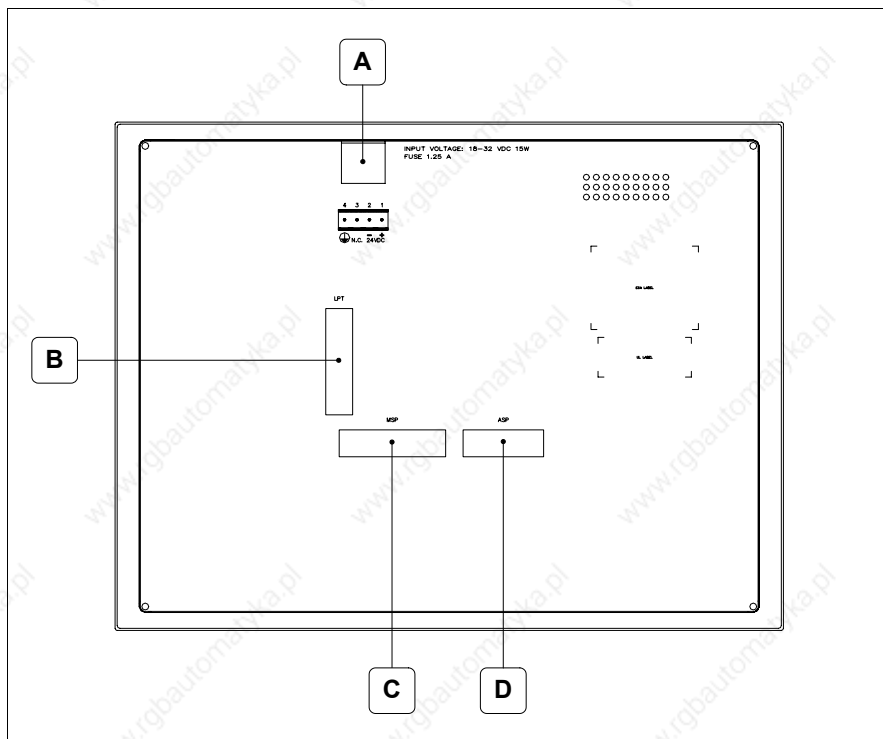

Position	Function
A	Power supply connector
B	LPT port for connecting printer
C	MSP serial port for communicating with PLC/PC
D	ASP serial port for communicating with PC or other devices

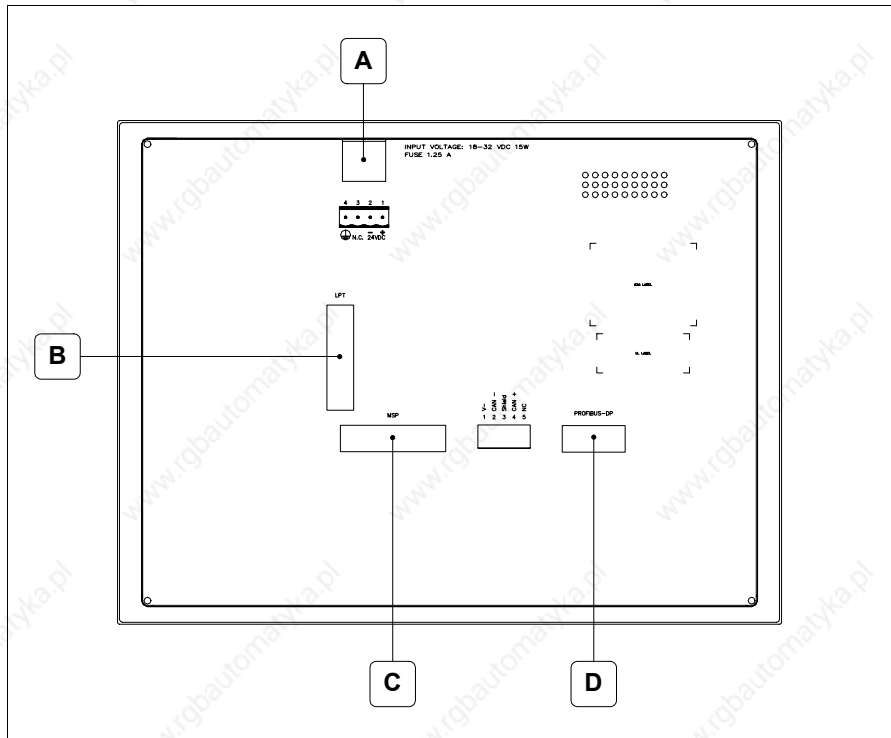
**Profibus-DP
series rear
view**

Position	Function
A	Power supply connector
B	LPT port for connecting printer
C	MSP serial port for communicating with PLC/PC
D	Serial port for network communication

CAN series rear view

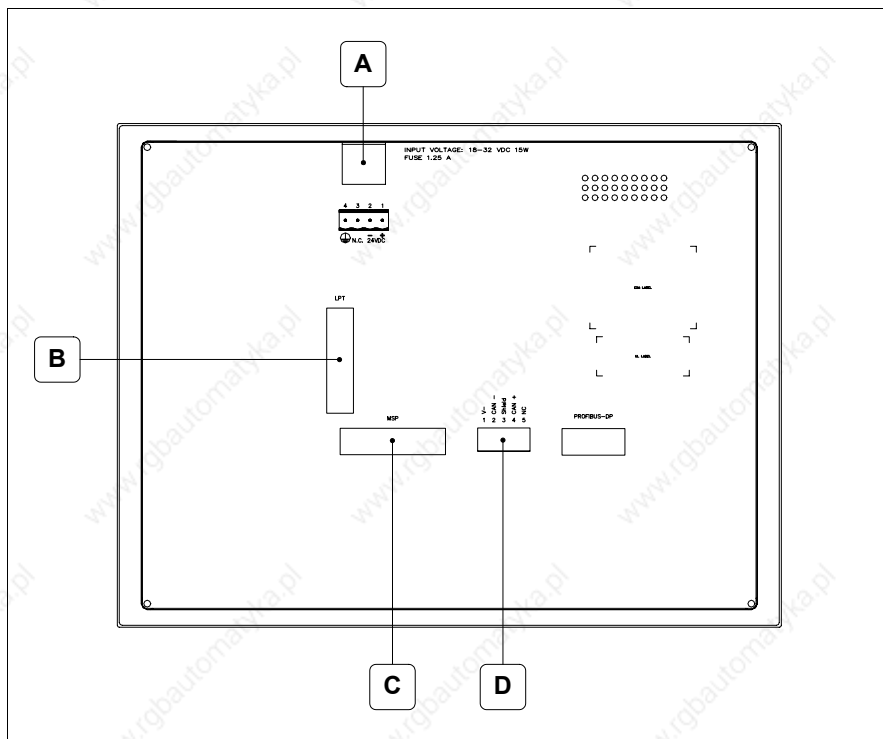

Position	Function
A	Power supply connector
B	LPT port for connecting printer
C	MSP serial port for communicating with PLC/PC
D	CAN serial port

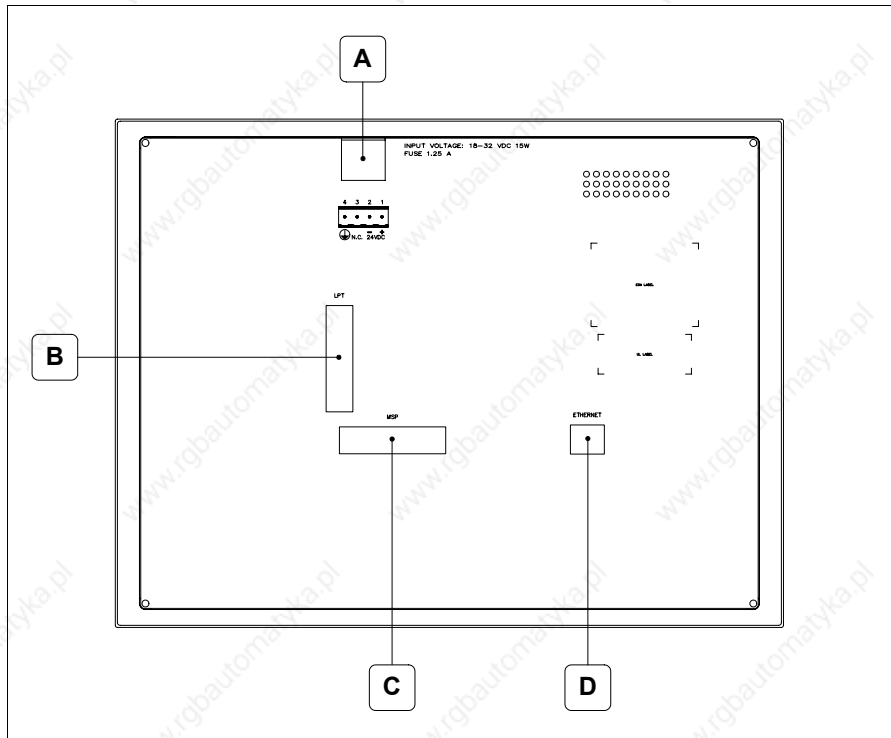
**Ethernet
series rear
view**

Position	Function
A	Power supply connector
B	LPT port for connecting printer
C	MSP serial port for communicating with PLC/PC
D	Ethernet network 10/100Mbit RJ45 (For the diagnostic mode of the LEDs see "Chapter 30 -> Ethernet port")

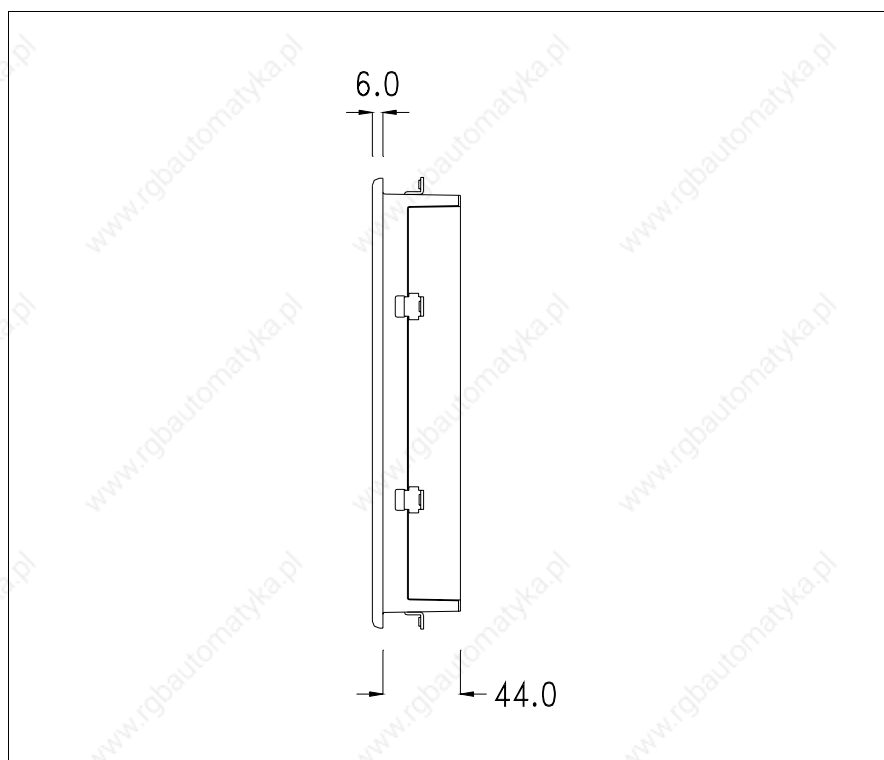
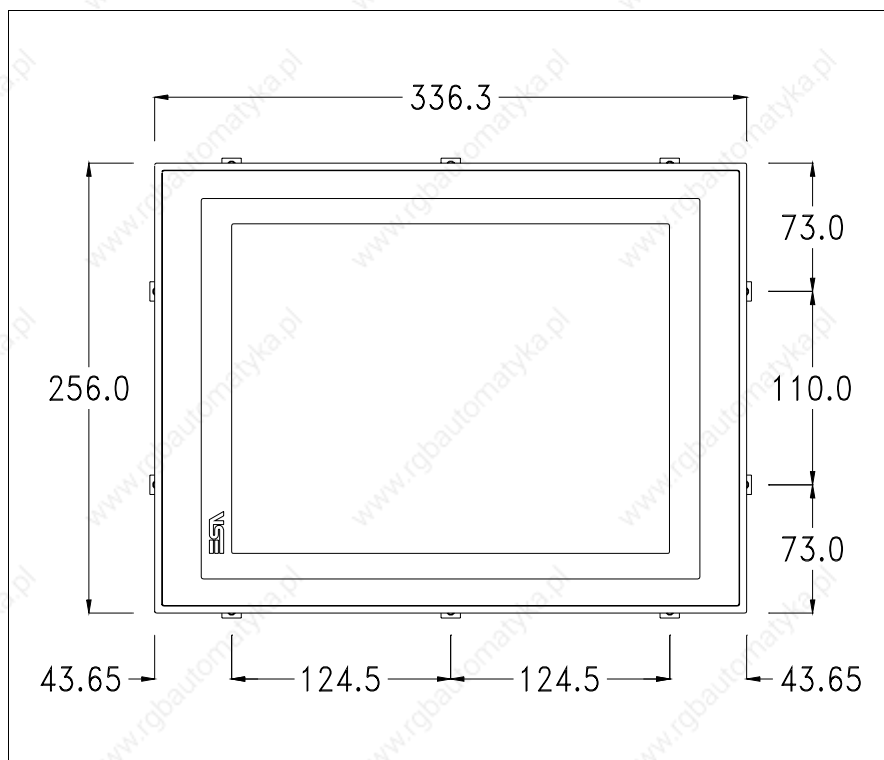
**Dimensions
and Cut-out**

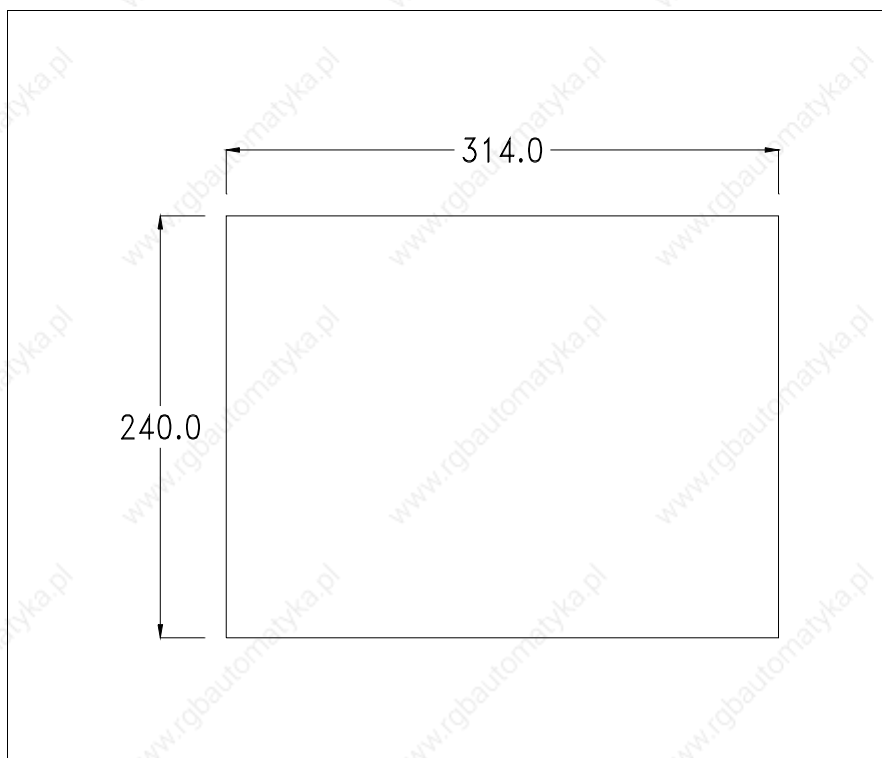

To fix the sealing gasket and secure the VT to the container see “Chapter 29 -> Mounting the terminal within the container“.

⚠ Where accessories need to be fixed in or onto the VT terminal, you are advised to do this before securing the VT to its container.

Accessories

Any accessories should be mounted in accordance with the instructions in the relevant chapter (see “Chapter 33 -> Video terminal accessories“).

Calibration of Touch Screen

The screen of VT595W is made of resistive, sensitive glass; for this type of glass to work properly it requires a calibration procedure (**the terminal is already calibrated when supplied**), that is, the resistive area of the glass has to be adjusted to the visible area of the display.

Should it be thought necessary to repeat the calibration procedure this can be done by following the instructions set out below.

⚠ The procedure must be carried out with great care as the precision of the keys area depends on the calibration.

How to perform the calibration procedure:

- Make sure the VT is not connected to the power supply
- Remove the back cover
- Identify jumper J11

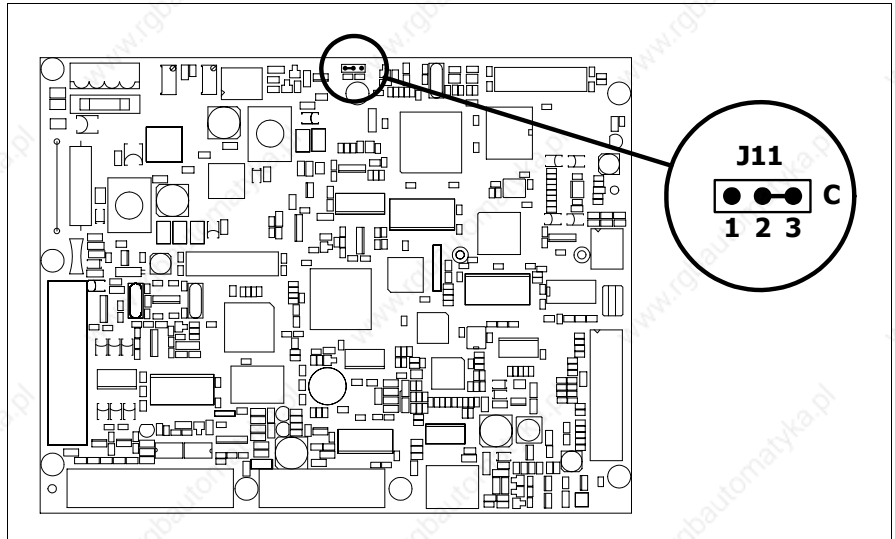

- Position J11 on pins 2-3 (C)
- Reconnect the power supply and switch on the terminal; the following mask appears

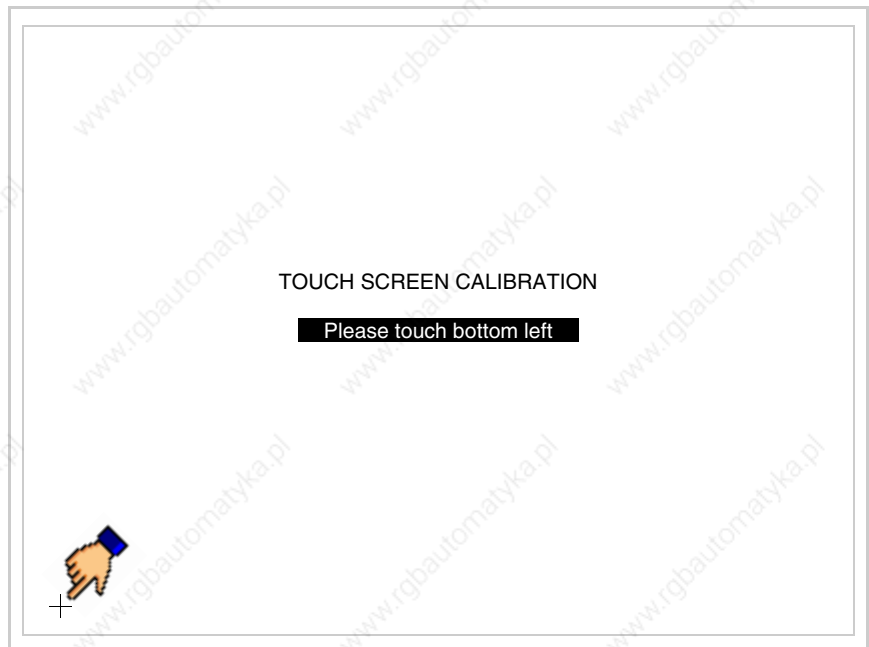

- Touch the corner indicated in the figure; then the following page appears on screen

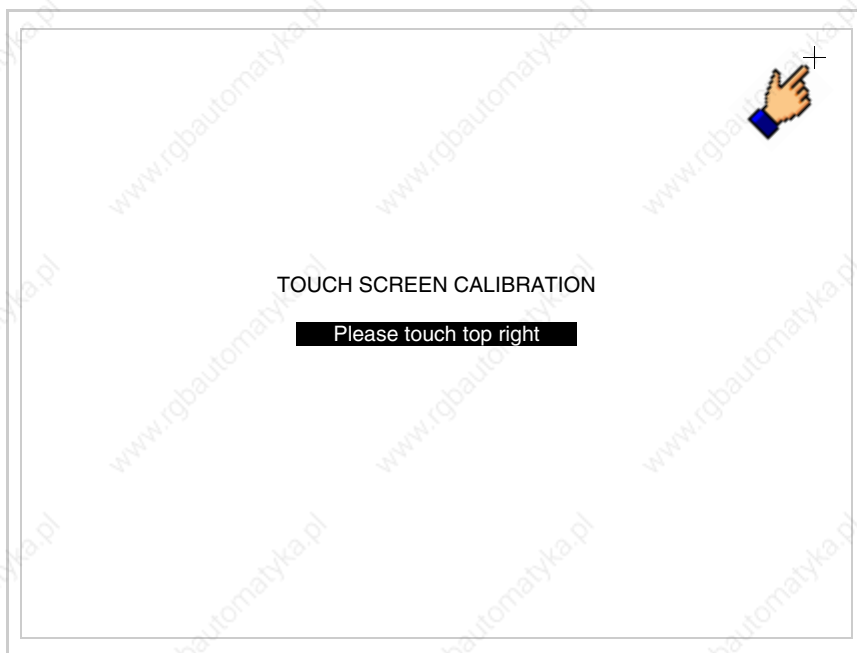

- Touch the corner indicated in the figure to complete the Calibrazione procedure; the following page now appears



- Wait a few moments until the VT displays either the following mask or the project page

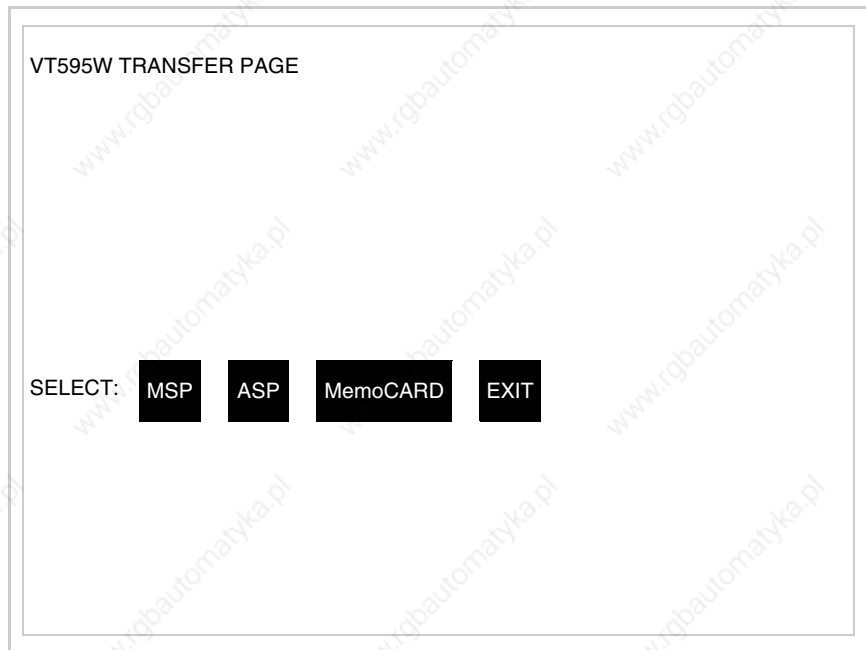

- Switch off the terminal
- Reposition J11 on pins 1-2
- Replace the back cover
- Switch on the terminal again

The calibration procedure has finished; if the calibration has been carried out wrongly or imprecisely, repeat the procedure.

Termination of CAN line

This paragraph applies only to the CAN series. The VT in question integrates the termination resistances of the serial line (typically 120 ohms) which can be inserted by means of a jumper (preset on 1-2, line not terminated). To activate the termination:

- Make sure the device is not connected to the power supply.
- Remove the cover.
- Identify the jumper unit J14.

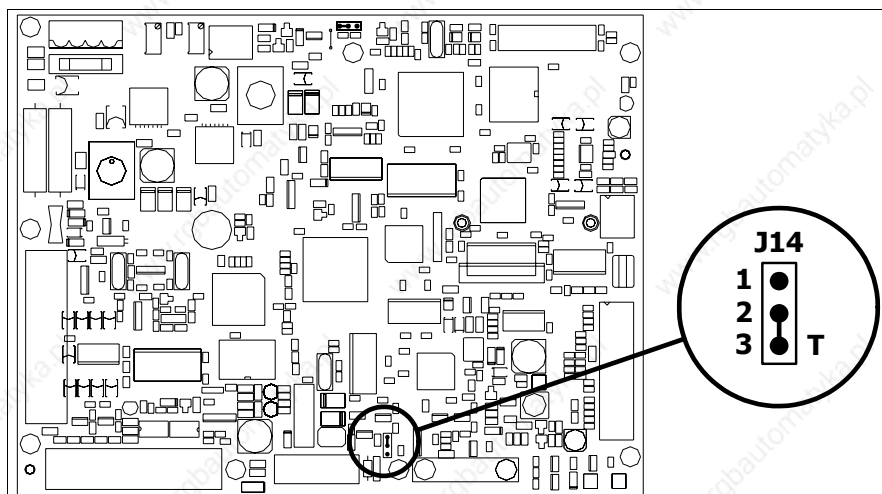

- Position the jumper between pins 2 and 3 (line terminated).
- Replace the back cover.
- Reconnect the power supply.

Introducing the MAC address

This paragraph relates only to the Ethernet series. The Media Access Control (MAC) address unambiguously identifies each terminal connected in the Ethernet network. The terminal is acquired with the address already programmed and is shown on the display of the terminal in the transfer page.

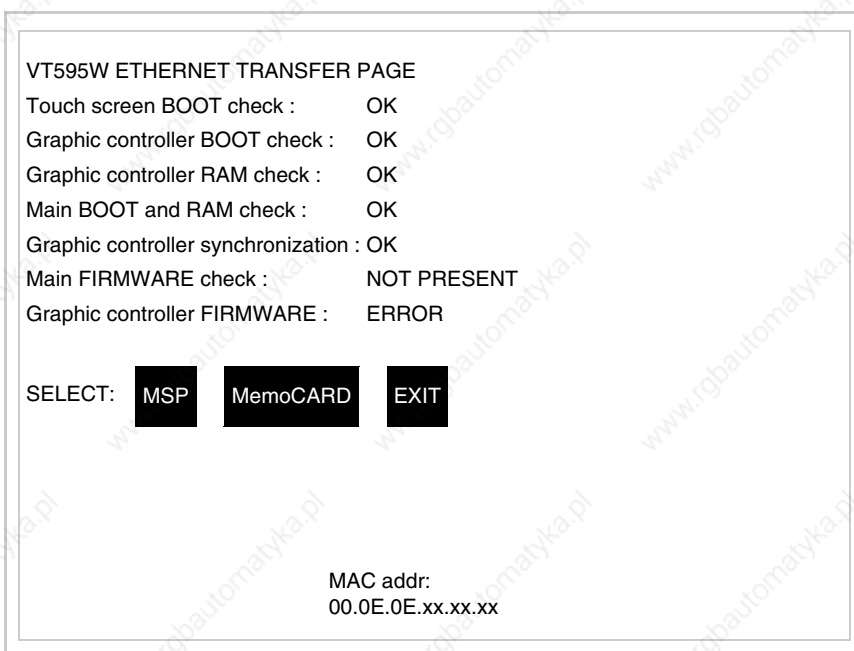

The MAC address is permanently memorized in the terminal, but should it

be necessary to execute an “aided” BOOT update (see Software Manual “Chapter 14 -> BOOT update“) the address is lost.

⚠ This operation must be carried out only with the advice of the ESA Customer Care Department.

Terminals with no valid MAC address when switched present a mask for its insertion. If no MAC address belonging to the terminal is available, proceed as follows:

- Check that the VT is not connected to the power supply.
- Remove the back cover
- Locate the label carrying the MAC address

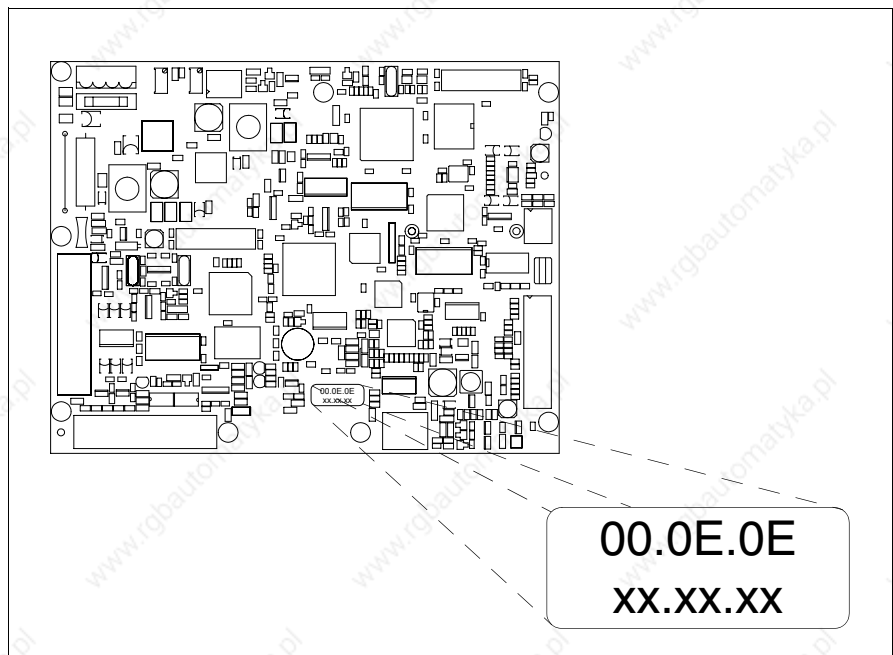

- Make a note of the number on the label (e.g. 00.0E.0E.00.00.01)

00.0E.0E -> fixed part that identifying as an ESA product
 XX.XX.XX -> variable part different for each terminal

- Reconnect the power supply to the terminal and, if necessary, calibrate the touch screen (see Page 27-14)
- Replace the back cover
- Switch on the terminal again
- The following mask appears; introduce the address previously noted down (e.g. 00.0E.0E.00.00.01)

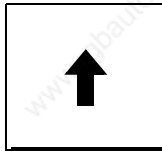

Enter a valid MAC address:
00.0E.0E.00.00.00

↑

← → ↓ ↶

- Use the arrow  to make the setting. Once the address has been confirmed the following page is displayed

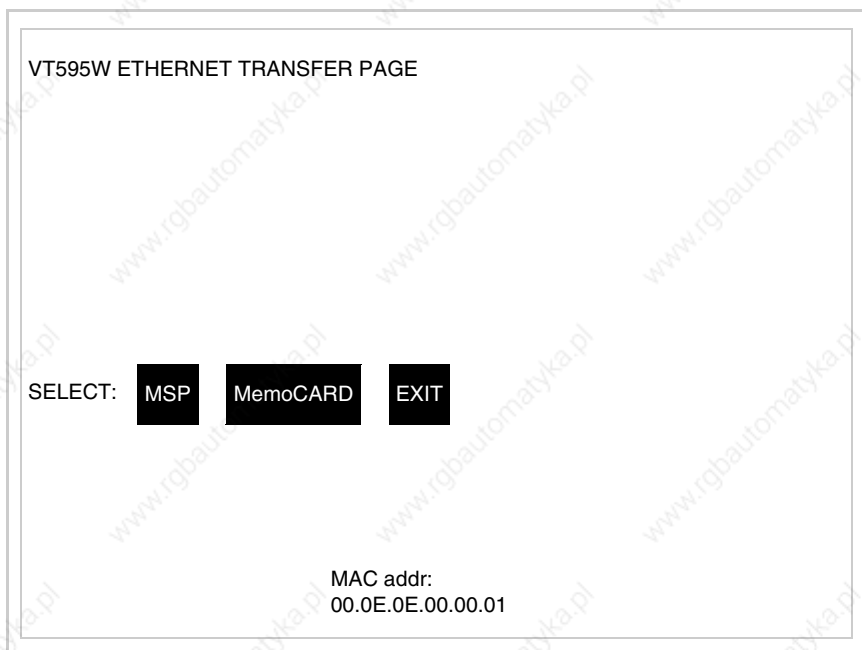

VT595W ETHERNET TRANSFER PAGE

SELECT: **MSP** **MemoCARD** **EXIT**

MAC addr:
00.0E.0E.00.00.01

The procedure is now terminated.



Should a wrong MAC address have been inserted contact the ESA Customer Care Department.

⚠ A wrong address could give rise to an error of conflict between VT terminals in the Ethernet network.

Transfer PC -> VT

For everything to function properly, the first time the VT operator terminal is switched on it needs to be correctly loaded, that is it needs to have transferred to it:

- Firmware
- Communication driver
- Project

(Given that the transfer of the three files in practice occurs with a single operation, it will be defined as “Project transfer” for the sake of simplicity.)

For this it is essential that the VT be prepared to receive the transfer. (See also “Chapter 37 -> Command area”).

Preparation for reception

The programme VTWIN must be used for the transfer (see Software Manual), but the terminal must be prepared for reception.

This means carrying out the following steps:

- Check that the VT is off
- Check that there is a serial connection between the PC and the VT
- Switch on the VT and wait for the following mask to appear
- Press one after the other two diagonally opposite corners free of settable objects or buttons (at least one corner needs to be free)

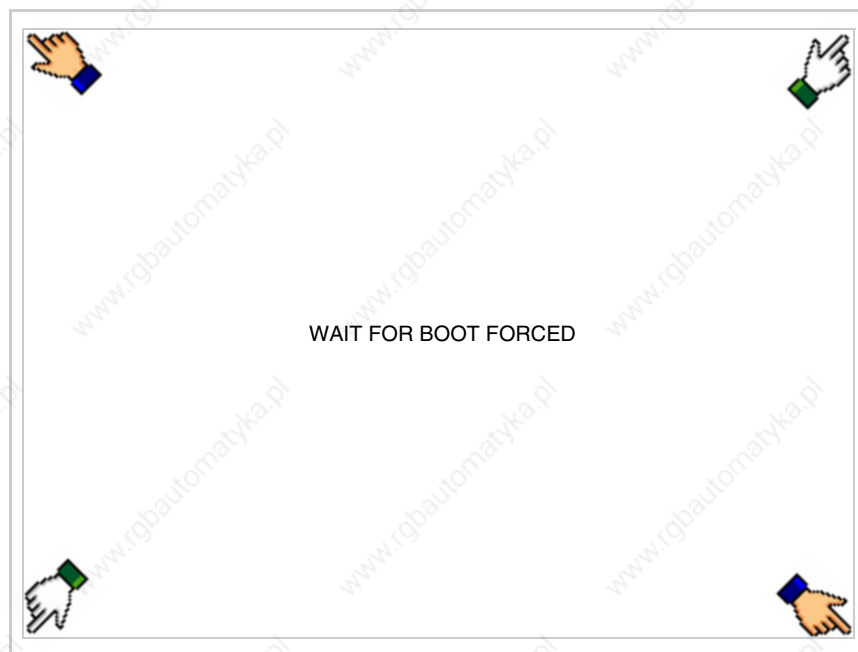

and wait a few moments, alternatively use the button provided (see Page 27-21), until the VT displays the following mask

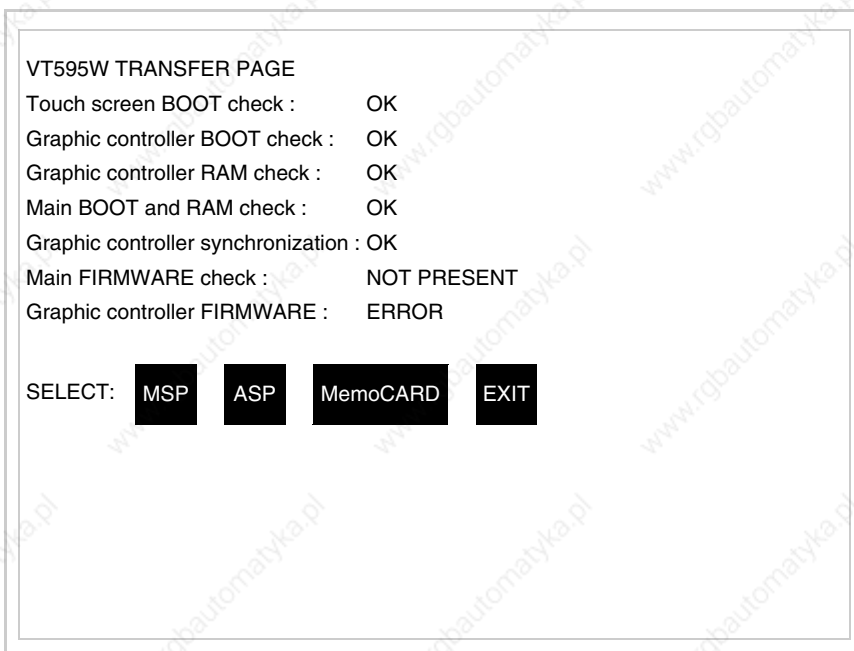

- Choose the port you intend to use for the transfer (MSP or ASP); touch the relevant on the display. The VT is now ready to receive (refer to Software Manual for transfer procedure). The MemoCARD appears if the Memory Card has been inserted in the VT (see Page 27-27)

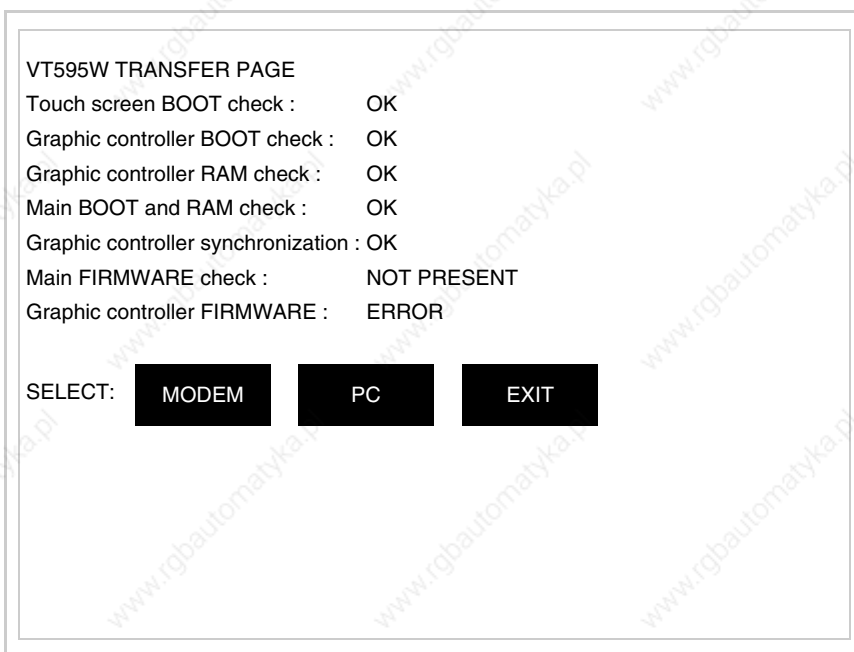

- Choose the required transfer mode: MODEM if you intend to use a modem or PC if you intend to use a serial port; touch the relevant on the display

If the choose made is PC, the VT is ready to receive (see Software Manual for transfer), if, on the other hand, you choose MODEM, the following mask will appear

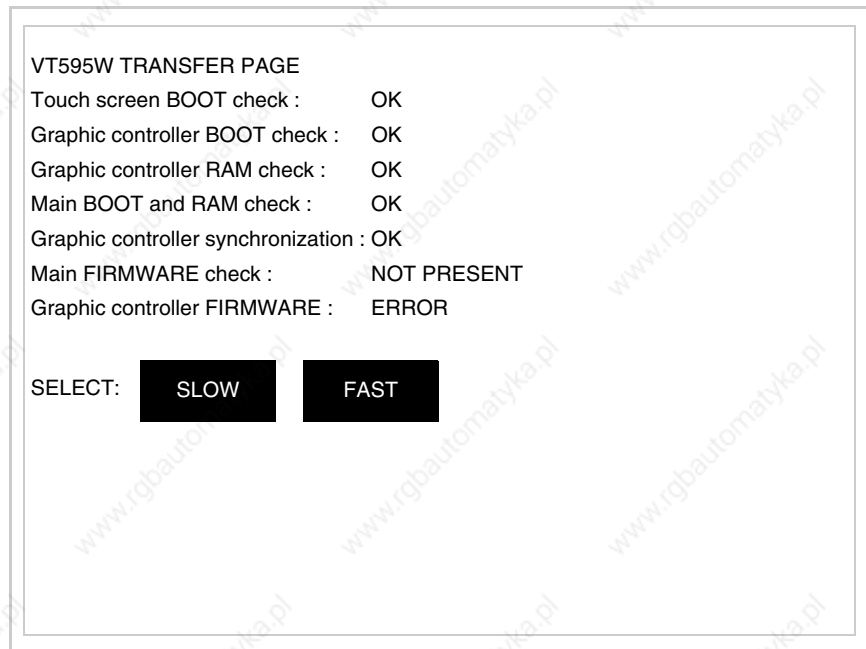

The choice should be according to the speed you intend to use for the transfer (Slow=9600bit/sec or Fast=38400bit/sec), touch the relevant on the display. The VT is now ready to receive (see Software Manual for the transfer).

Information relating to driver

After the project has been transferred, the VT can make available information relating to what has been loaded. The information regards:

- Serial ports present
- The name of the driver loaded
- The version of the driver loaded
- Network address of the VT
- Last error to have occurred

To acquire this information carry out the following operations:

- Be situated in any page of the project
- Press two diagonally opposed angles that are free of any settable objects

or buttons (at least one angle must be free)



and you will see



There is one of these pages for each communication port; movement between the various pages is effected by pressing .

From this page you can:

- Set the clock and the contrast
- Prepare the VT to receive the program
- Use the Memory Card

Setting the clock and the contrast:

To set the clock and the contrast, while displaying the above illustrated page, press ; the following mask appears

The image shows a rectangular display area with a thin border. Inside, there are two separate rectangular boxes, one above the other. The top box contains the text "SET CONTRAST : ±##". The bottom box contains the text "SET CLOCK :
ddd,dd/mm/yy
hh:mm:ss". In the bottom right corner of the display area, there is a small square button labeled "ESC".

To set the contrast touch the words SET CONTRAST on the display; you will see the following mask



Use the arrow  for any variation (see “Chapter 36 -> Operation of terminal with touch screen”).

To set the clock touch the words SET CLOCK on the display; the following mask appears

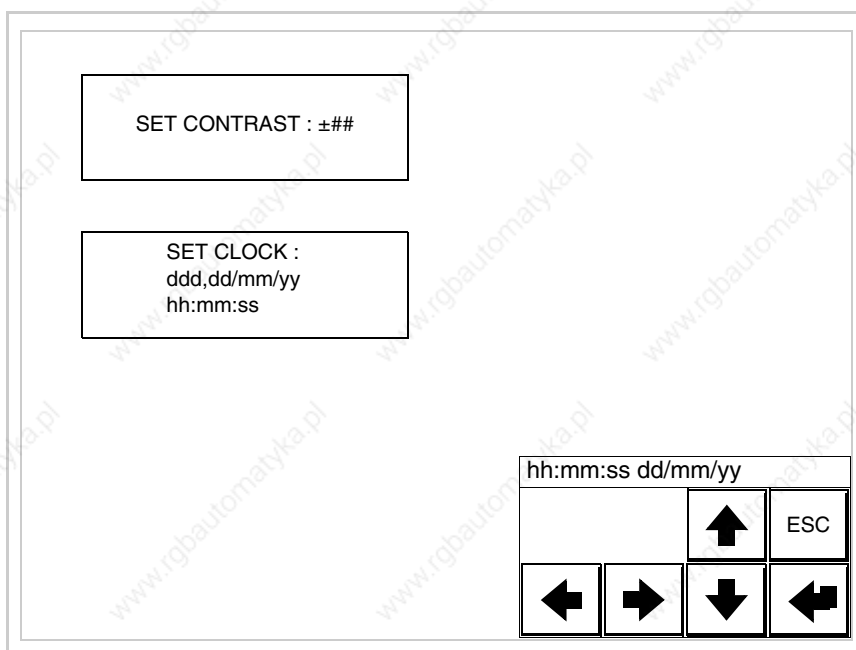

Use the arrow  for any variation (see “Chapter 36 -> Operation of terminal with touch screen”).

Prepare the VT to receive the program:

To prepare the VT to receive the program, while displaying the driver information page (see Page 27-23), press , and you will see the following mask

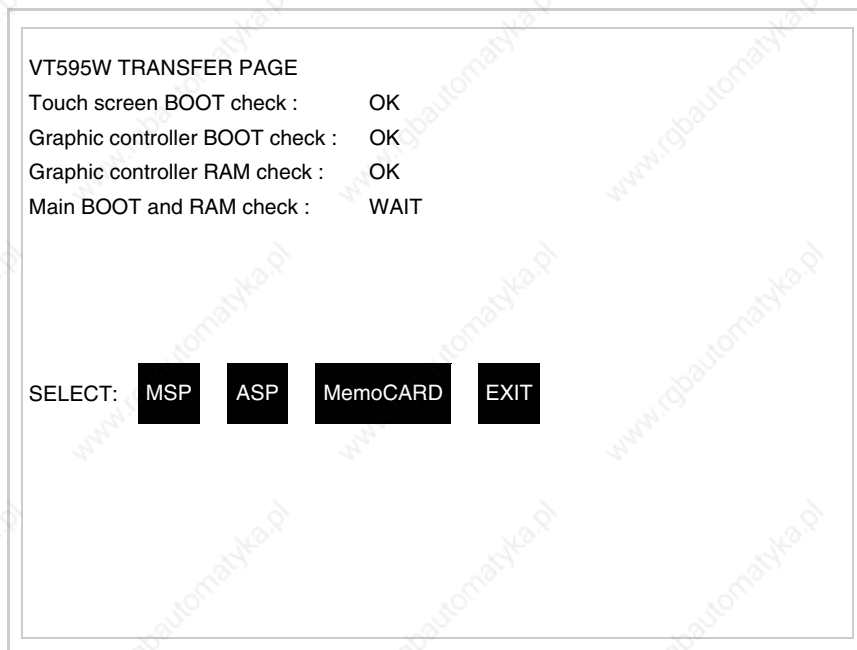

The on-screen  to press depends on the port you intend to use (MSP or ASP). The VT terminal is now ready to receive (consult Software Manual for information on the transmission procedure).

Using the Memory Card:

While displaying the driver information page, press  and the following mask will appear:

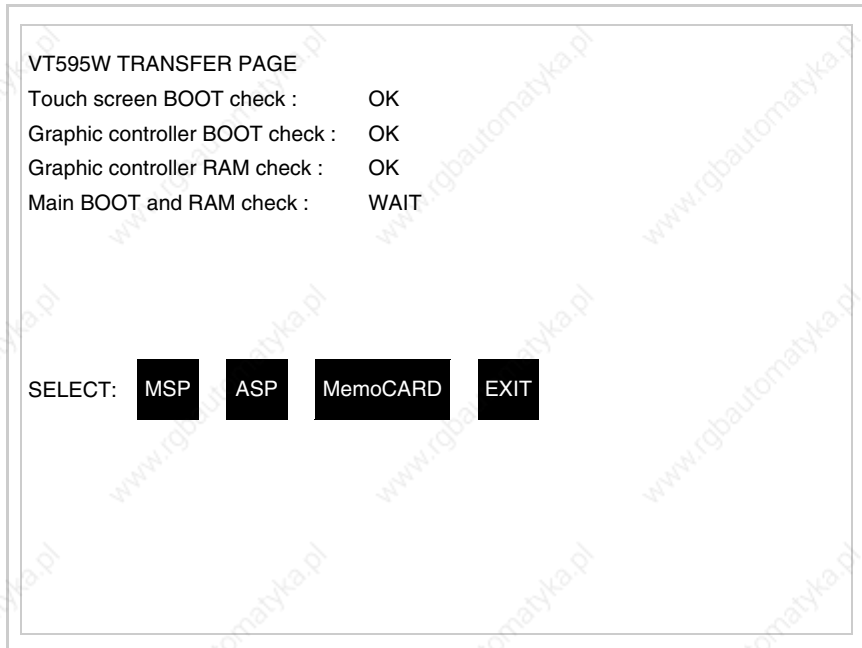

Touch the MemoCARD on the screen (if the key is not on screen, see Page 27-21) and the following mask will appear:

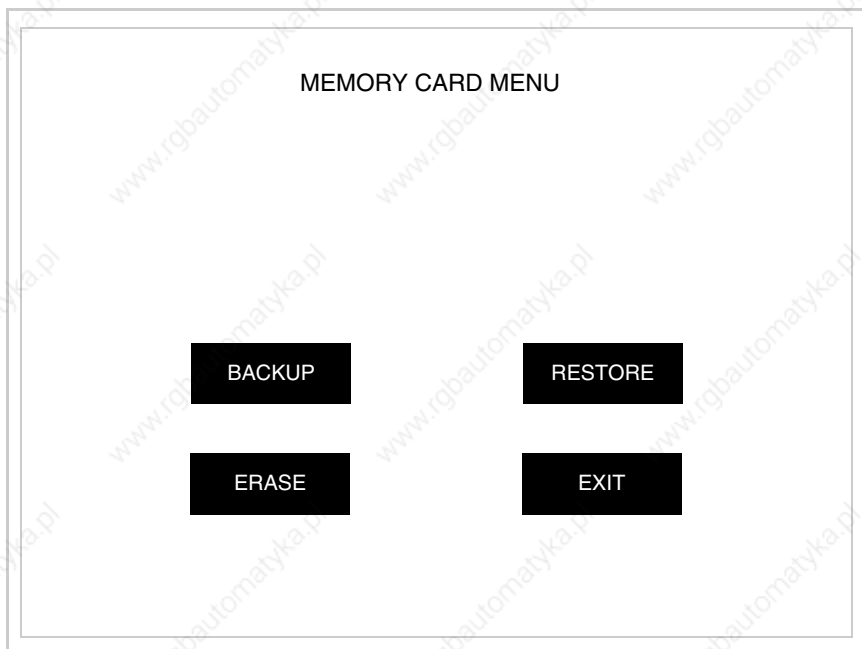

For the meaning and the functions of the keys see "Chapter 33 -> Memory card".

Possible error messages that may be encountered in the driver information page are:

- PR ERR

Problem-> Errors have been detected in the data exchange between the VT and the Device.

Solution-> Check the cable; there may be disturbance.

- COM BROKEN

Problem-> Communication between VT and Device interrupted.

Solution-> Check the serial connection cable.

An error message followed by [*] indicates that the error is not currently present but was and has since disappeared.

Example: COM BROKEN*

When  is pressed you quit the display of information regarding the driver.

Improving display color quality

To improve the color quality, adjust the contrast of the display: if the colors are too dark increase the contrast; if, on the other hand, the colors are too light, decrease the contrast.

Adjusting the contrast on the display

To improve the quality of the representation on the display it may be necessary to adjust its contrast. This can be done by going to the page proposed (see Page 27-25) and changing the value (from +63 to -64) in evidence at that moment. Increase the value to darken the display; to lighten it decrease the value.



This parameter has no effect when a TFT display is used. This kind of technology does not need adjustment.

Chapter 28 Inserting customized labels

Contents	Page
Label	28-2
Warnings	28-2
Notes	28-4

This chapter consists of 4 pages.

VT terminals are supplied with labels already set in the appropriate spaces.

If it is necessary to customize keys, the logo or the model the labels can be replaced with the neutral ones supplied in kit with the terminal (only for F-keys) or by inserting labels of other materials provided they conform with the points set out below.



Failure to follow the following indications may cause damage to the terminal.

Label

The label must be of a material that is flexible and does not exceed 125 μ m (micrometers).



Use neither stiff materials nor glues.

Warnings

Before starting to insert the customized label the following points **MUST BE** observed:

- Remove the label already inserted.
- Follow the indications set out in the paragraph Label.
- Do not use compressed air to help insert the label.
- Do not use rigid or other instruments to insert the label.
- Do not fold the label between the terminal and the casing. The following figures illustrate the correct and the incorrect positions for the label.

Correct insertion:

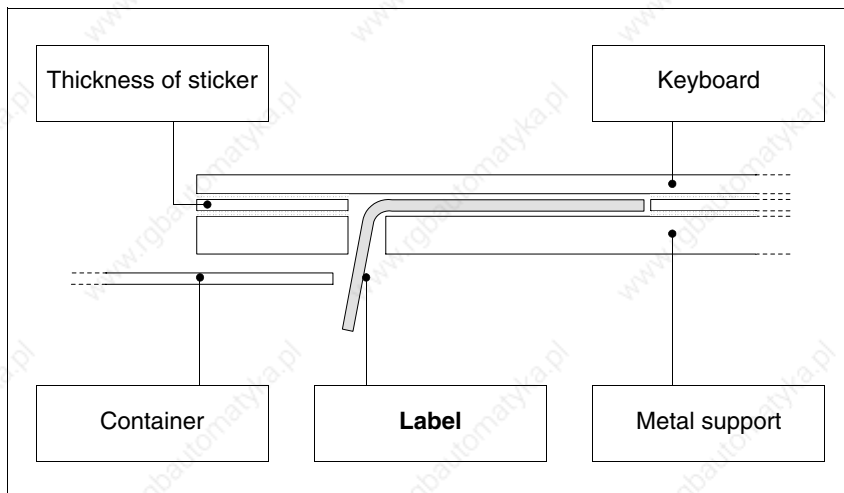

The label illustrated is free and creates no tension on the keyboard.

INCORRECT insertion which could cause compromised adhesion:

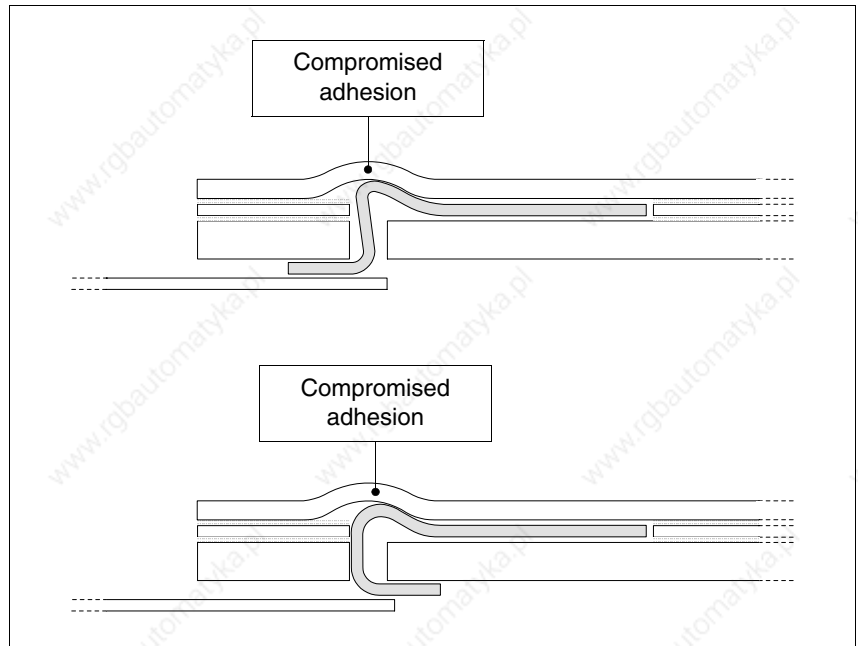

The labels illustrated generate pressure that over time could cause the keyboard to scollare.

- The oversize part of the label must go under the back cover or in the appropriate fixing points (the choice is determined by the type of VT being used).

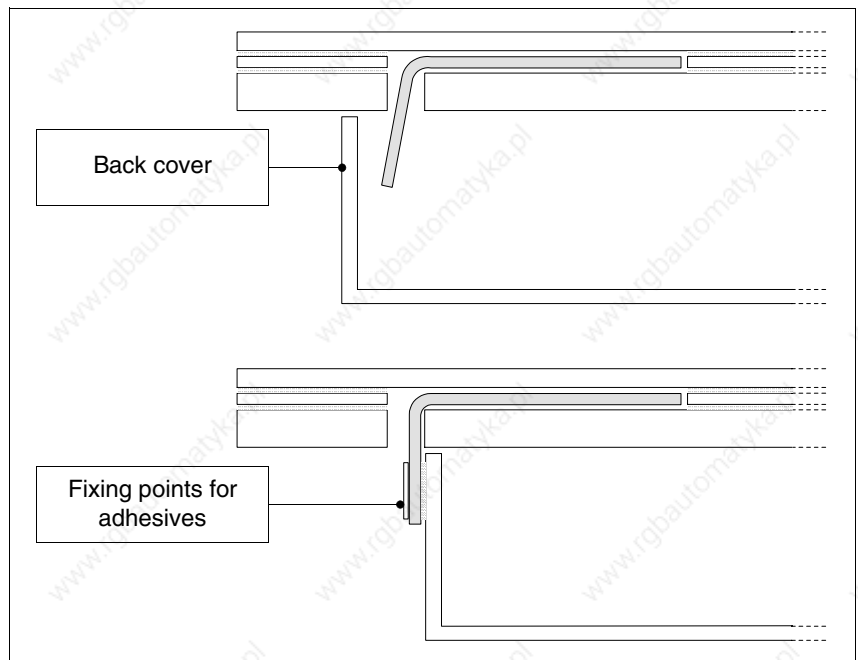

Notes

Here are some tips to make it easier to insert the label:

- Round off the corners.

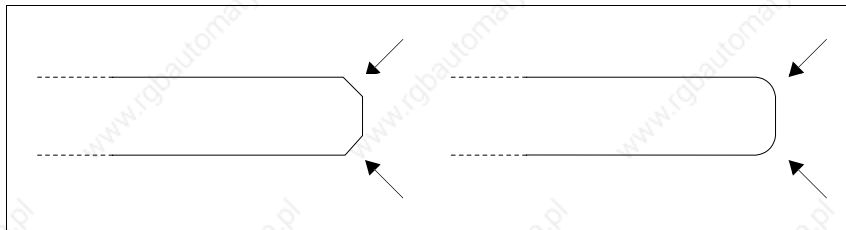

- If there seems to be some resistance pull the label out and reinsert it.
- If more than one label is used, insert them all at the same time.

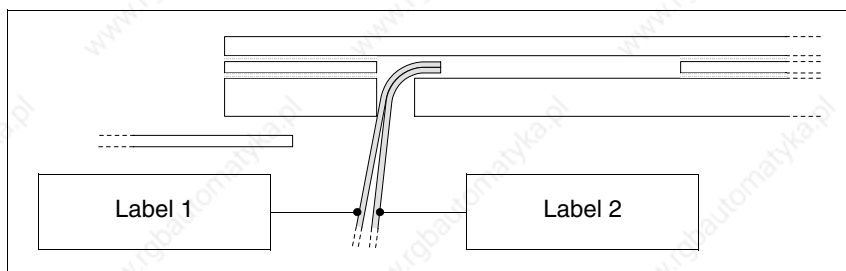

Take care not to exceed the total thickness permitted (see Page 28-2 -> Label).

- Do not bend the label at right angles and/or do not bend them so sharply that they might be damaged.
- Slightly bend the label lengthwise to make it stiffer.

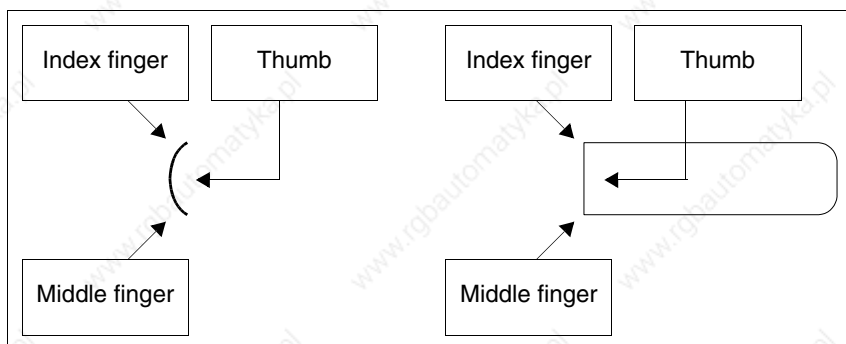

Chapter 29 Mounting the terminal within the container

Contents	Page
Using nuts	29-2
Using hooks	29-3
Fixing using external support	29-6
Tightening the fixing screws	29-3

This chapter consists of 10 pages.

The VT comes supplied with the elements necessary for mounting it within the host container and fixing the sealing gasket giving the declared level of IP protection.

There are three kinds of terminal: those with the gasket already in place and the mounting within the container being secured by means of nuts, and those where the gasket is to be fitted in the installation phase and the means of securing are hooks and those with seal already attached which are fixed to the container using external support.

Using nuts

The figure below shows the front and back views of a VT inserted in a container. Under the figure is to be found the sequence of operations to be carried out to ensure that the fixing is correct.

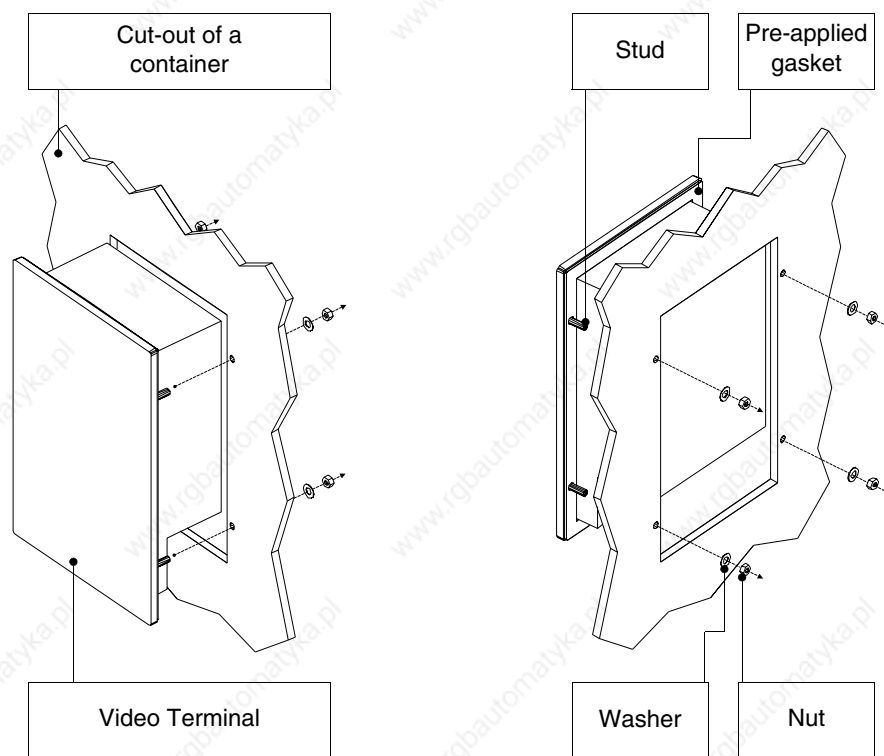

After preparing the container that will host the VT:

- Insert the VT in the cut-out
- Hold the VT against the wall
- Insert first the washer then the nut into the fastener
- Tighten the nuts till the gasket has a firm grip (see also Page 29-10)

Using hooks

The illustrations appearing below show in front and rear views the sequence of actions for mounting a VT within a container.

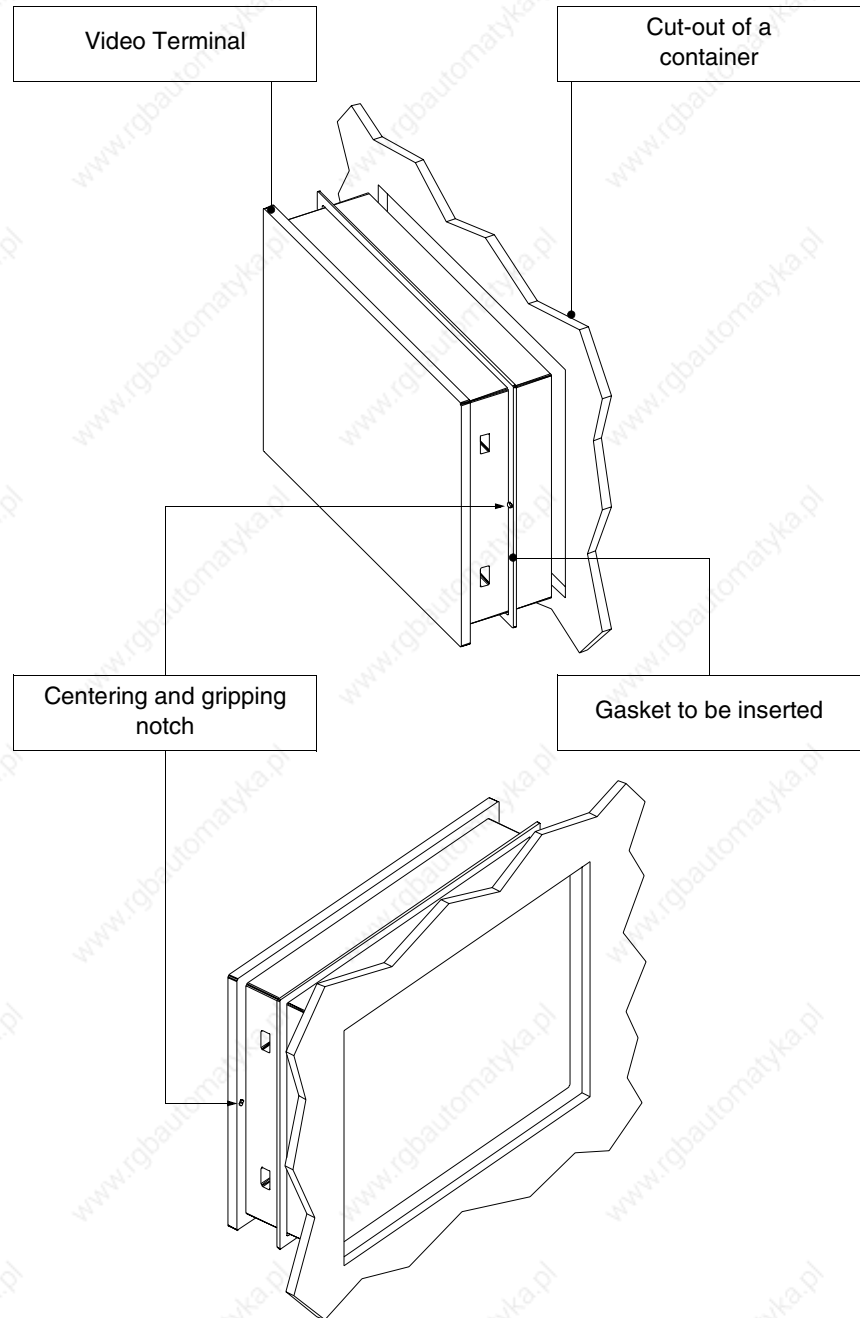

After preparing the container that will host the VT:

- Insert the gasket in the VT the right way round as indicated by the centering notches

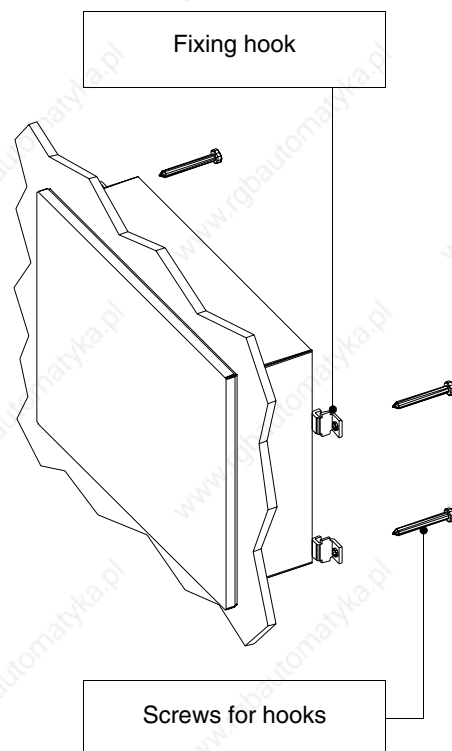

- Prepare the fixing hooks
- Thread the screws into the hook by about 10mm

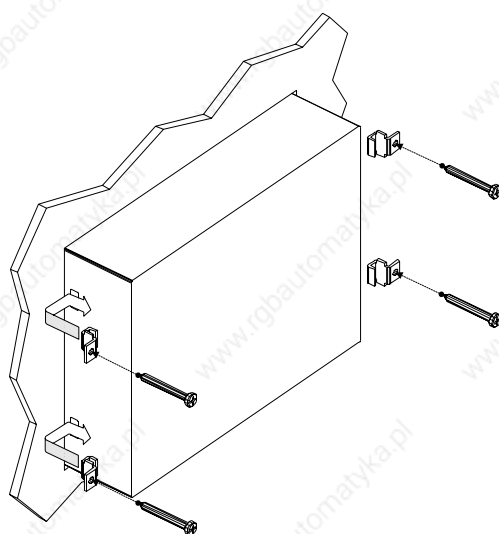

- Insert the VT and hold it pressed against the container
- Insert the hooks into the slots following the direction indicated by the arrow and tighten the screws as far as they go (see also Page 29-10)

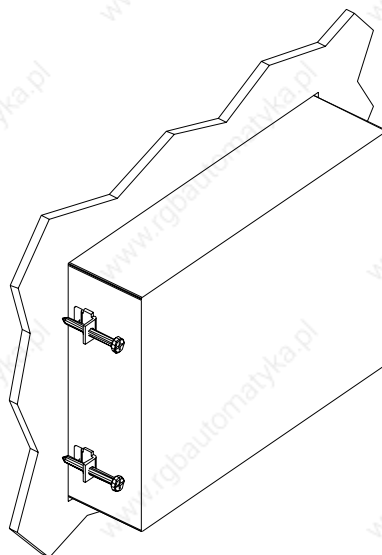

View of terminal with correct fixing.

⚠ The number and position of the hooks do not influence the fixing procedure. The illustrations are to show the way the hooks work.

Fixing using external support

The figure below shows the hook to use to mount those VTs requiring a support external to the container.

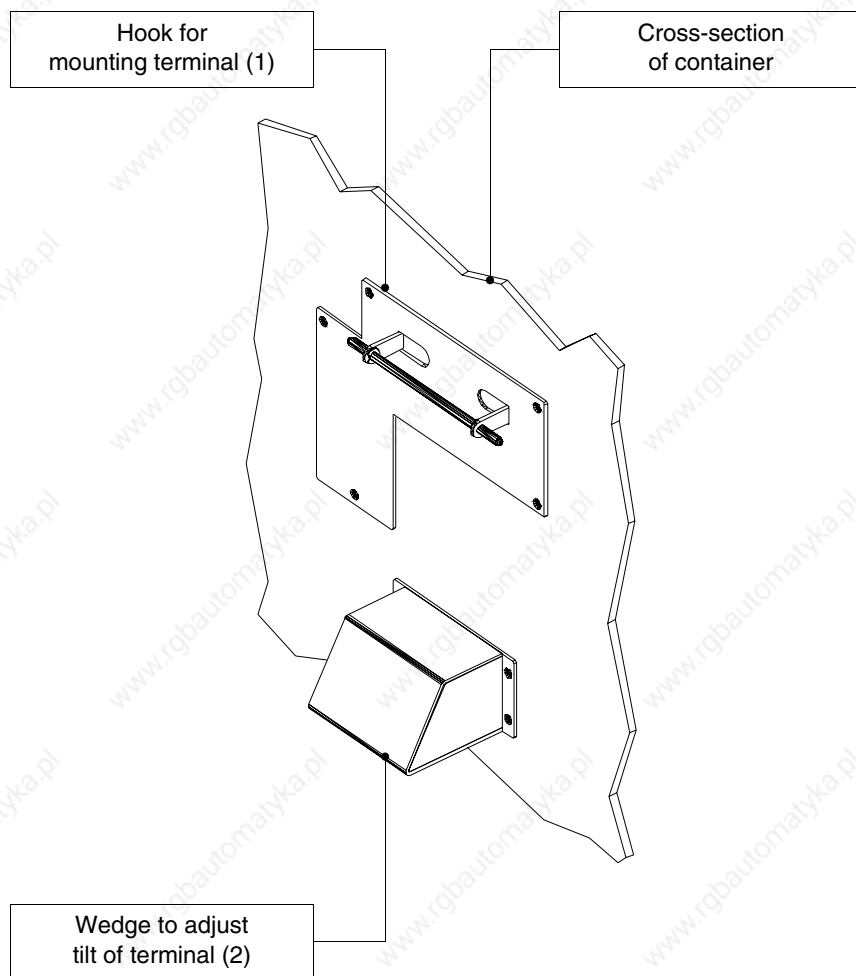

Before proceeding with the explanation of the steps required to mount the terminal it needs to be said that the hook allows the terminal to be positioned at various heights and angles, so the exact position must be defined.

To help do this, the following figure shows the maximum movement possible from the operator's view point, depending on how the tilt adjustment wedge is positioned (intermediate positions for intermediate tilt angles).



Do not use or position other than as indicated.



Do not alter the original form of the mounting hook or the tilt adjustment wedge.

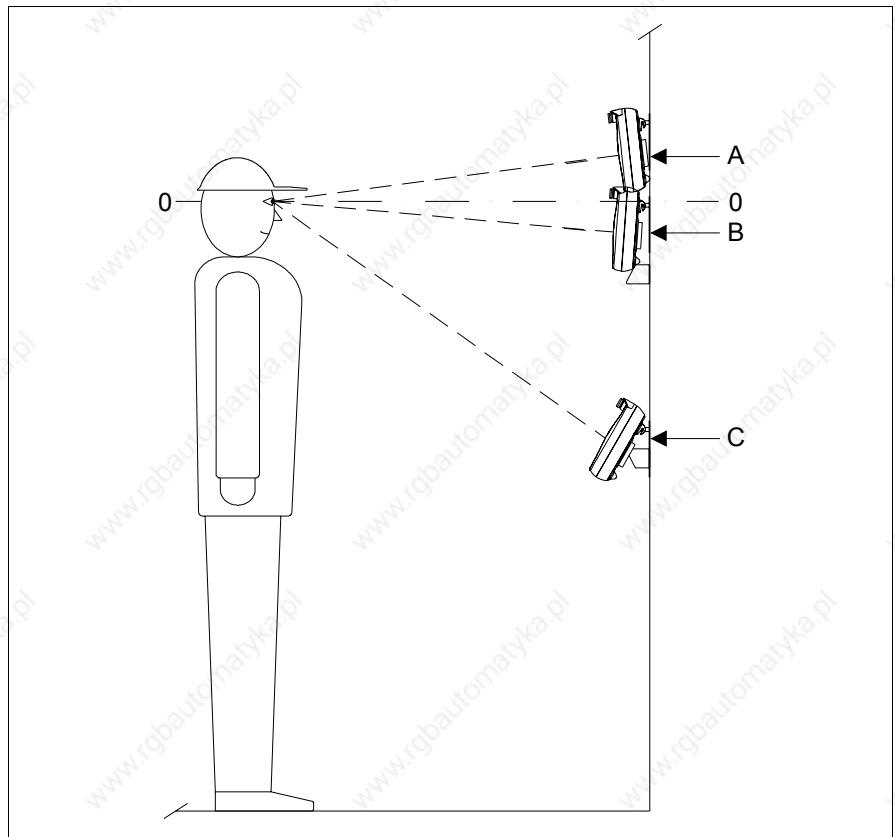

Position	Maximum movement possible relative to operator's viewing level (0-0)	
0 - A	120mm	
0 - B	80mm	
0 - C	620mm	

! The hook is for fixing to a plastic or metal surface or container. Should the terminal be fixed to a wall or suchlike, the user will be responsible for supplying the correct screws for the type of material in question.

After defining the position of the support hook:

- Position the hook (preferably on a smooth surface) and secure using the screws supplied. If a 3MA threaded hole is made, just use the screws, otherwise use the washer and nut.

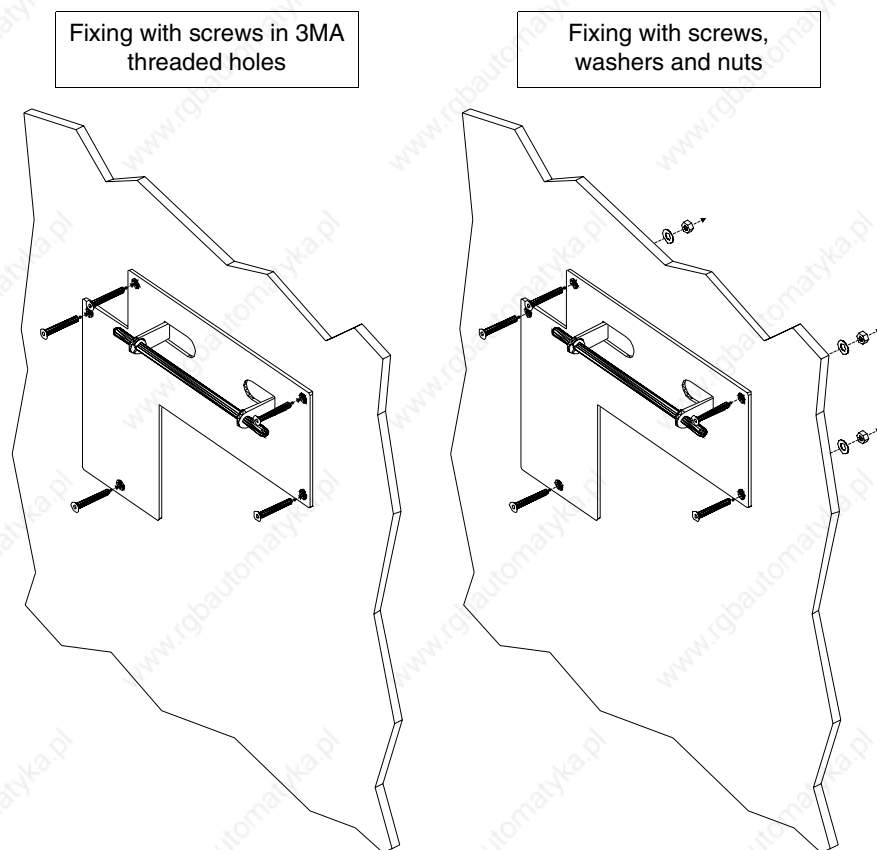

- The tilt adjustment wedge must be positioned (position 0-A, 0-B or intermediate) using the same criterion as with the previous point

Fixing with screws in 3MA
threaded holes

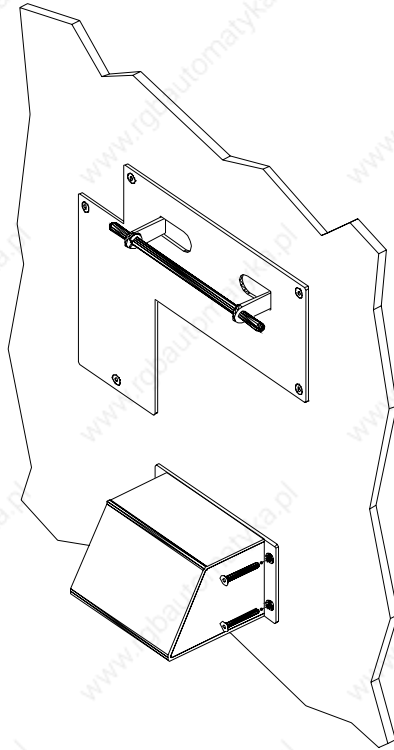

Fixing with screws,
washers and nuts

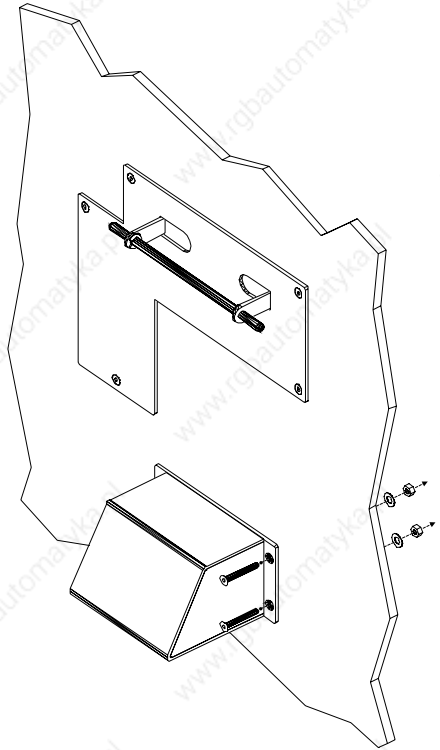

The VT can now be inserted following the direction of the arrows.

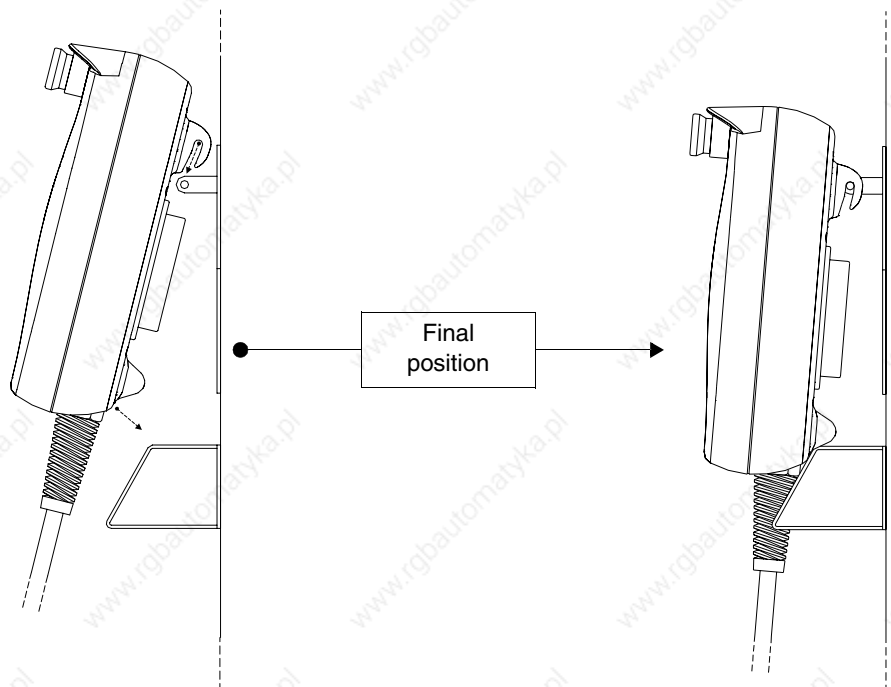

Tightening the fixing screws

For the best possible grip of the basket to the container, you are advised:

- To respect the screwing sequence illustrated.

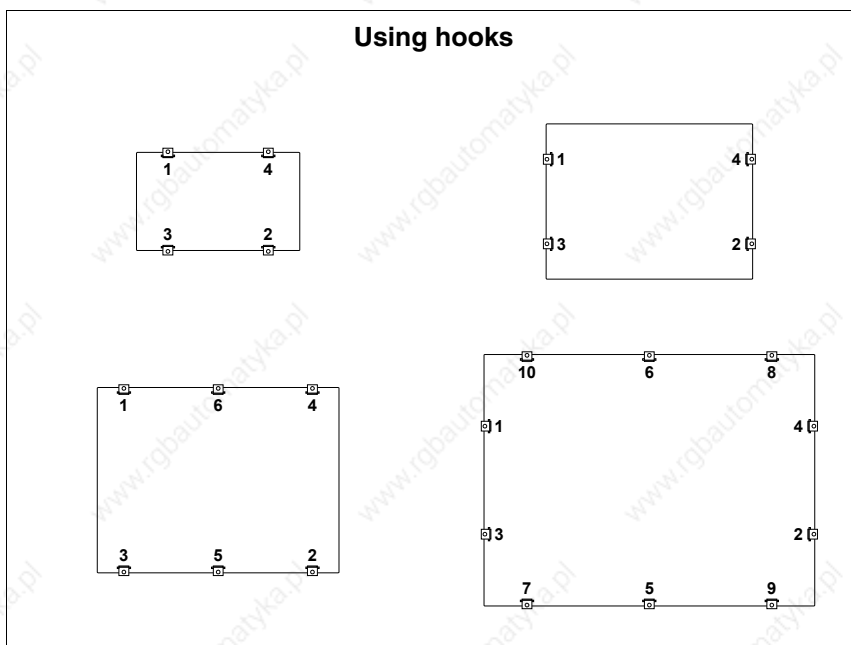
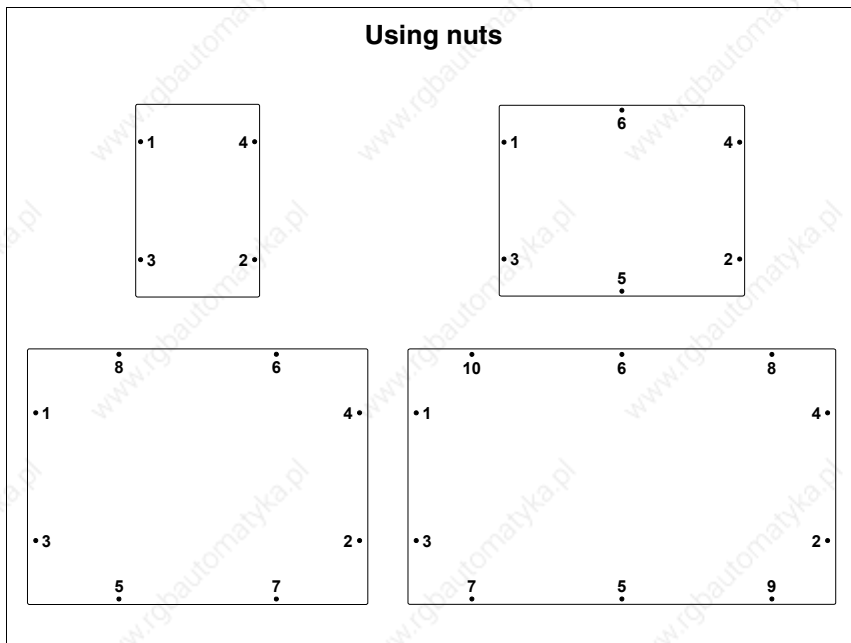

- Initially tighten the fixing screws with moderate pressure so as to ensure that contact is even at all points; once all the screws have been inserted, repeat the sequence with a final tightening.

Chapter 30 Communication ports

Contents	Page
General notes	30-2
Necessary steps	30-2
MSP serial port	30-3
ASP serial port	30-4
ASP-15L serial port	30-5
ASP-9 serial port	30-6
ASP-8 serial port	30-6
LPT parallel port	30-7
Ethernet port	30-8
Interbus-S port	30-9
Profibus-DP port	30-10
CAN port	30-10
RS485 serial port	30-11
PC/VT serial port	30-11
PC <-> VT connection	30-12

This chapter consists of 14 pages.

All VTs communicate with other devices by means of serial and/or parallel communication ports. We list on the following page the individual ports with the respective type of communication and the function of the connection pins.

General notes

Serial communication is particularly prone to disturbances. To limit the influence of these disturbances it is necessary to use good quality shielded cables.

The table immediately below lists the characteristics of the cable we recommend for serial connection.

Specifications of serial connection cable	
Direct current resistance	Max. 151 Ohm/Km
Capacity coupling	Max. 29pF/m
Shielding	> 80% or total



Particular care should be taken in the choice and lay-out of cables, specially with regard to the VT <-> Device connection serial cable.

Always:

- Find the shortest route
- Lay disturbed cables separately



Disconnect the power supply before connecting or disconnecting the communication cables so as to avoid possible damage to the VT and/or the connected device.

Necessary steps

To have the communication ports (MSP, ASP, ASP-9 or ASP-8) functioning properly, certain pins on the VT side need to be jump-connected. The ASP-15L port requires no jumpers. Which pins need to be connected depends on which communication standard is to be used (RS232, RS422, RS485 or C.L.TTY-20mA).

Table 30.1: Jumpers to be effected inside the communication cable.

Signal	Pin number				Communication standard							
	MSP	ASP-8	ASP-9	ASP	RS232	RS422	RS485	C.L.a	C.L.p			
RTS OUT	4	4	7	10	●	2	●	2	●	2	●	2
CTS IN	5	5	8	11	●		●		●		●	
IKR OUT (C.L.)	15				●	1	●	1	●	1		
RX+ IN (C.L.)	18				●		●		●			
Signal GND	7				●		●		●			
RX- IN (C.L.)	25				●	1	●	1	●	1		
TX- OUT (C.L.)	11								●			

Notes:

- 1 - Jumpers always to be effected.
2 - Jumpers to be effected only if the corresponding signals are not handled by the device connected to the VT.

C.L.a - Current Loop (Activ VT), C.L.p - Current Loop (Passive VT)

MSP serial port

The MSP (Multi Serial Port) is present on all VTs and is used to connect other devices including the PC used to transfer the project. It consists of a connector (D-Sub 25 pin female) and can communicate using RS232, RS422, RS485 and C.L. (TTY-20mA).

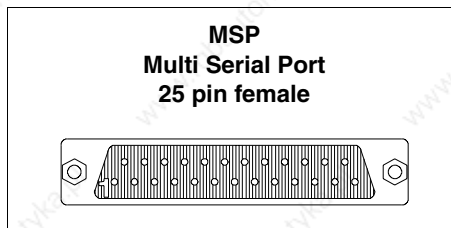

Pin	Signal	Notes
1	N.C.	Not connected
2	Tx OUT	RS232
3	Rx IN	RS232
4	RTS OUT	RS232
5	CTS IN	RS232
6	N.C.	Not connected
7	Signal GND	Internal reference 0Volt
8	N.C.	Not connected
9	Tx +OUT	C.L. (TTY-20mA) Current loop
10	Tx/Rx -IN/OUT	RS485
11	Tx -OUT	C.L. (TTY-20mA) Current loop
12	Tx -OUT	RS422
13	Rx +IN	RS422
14	IKT OUT	C.L. (TTY-20mA) Current loop
15	IKR OUT	C.L. (TTY-20mA) Current loop
16	+5Vdc (150mA Max.)	Reserved for Esa
17	N.C.	Not connected
18	Rx +IN	C.L. (TTY-20mA) Current loop
19	N.C.	Not connected
20	N.C.	Not connected
21	N.C.	Not connected
22	Tx/Rx +IN/OUT	RS485
23	Tx +OUT	RS422
24	Rx -IN	RS422
25	Rx -IN	C.L. (TTY-20mA) Current loop

⚠ Pin 16 does not provide for commuting any kind of load (coils etc.); an input disturbance at Pin 16 can cause the VT and therefore also the industrial process itself to malfunction.

⚠ Strong input disturbances at Pin 16 could damage the VT.

⚠ Before connecting in RS422/485, check the polarities. With some devices the Tx+/Rx+ and Tx-/Rx- signals or the polarities are inverted.

ASP serial port

The ASP (Auxiliary Serial Port) consists of a D-Sub 15 pin female connector and can communicate using RS232 and RS485.

ASP
Auxiliary Serial Port
15 pin female

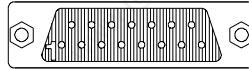

Pin	Signal	Notes
1	DCD IN	RS232
2	RX IN	RS232
3	TX OUT	RS232
4	DTR OUT	RS232
5	Signal GND	Internal reference 0Volt
6	N.C.	Not connected
7	Signal GND	Internal reference 0Volt
8	Tx/Rx +IN/OUT	RS485
9	DSR IN	RS232
10	RTS OUT	RS232
11	CTS IN	RS232
12	RI IN	RS232
13	+5Vdc (150mA Max.)	Reserved for Esa
14	N.C.	Not connected
15	Tx/Rx -IN/OUT	RS485

⚠ Pin 13 does not provide for commuting any kind of load (coils etc.); an input disturbance at Pin 13 can cause the VT and therefore also the industrial process itself to malfunction.



Strong input disturbances at Pin 13 could damage the VT.



Before connecting in RS422/485, check the polarities. With some devices the Tx+/Rx+ and Tx-/Rx- signals or the polarities are inverted.

ASP-15L serial port

The ASP (Auxiliary Serial Port) consists of a D-Sub 15 pin female connector and can communicate using RS232 and RS485. Unlike the ASP it does not carry all signals.

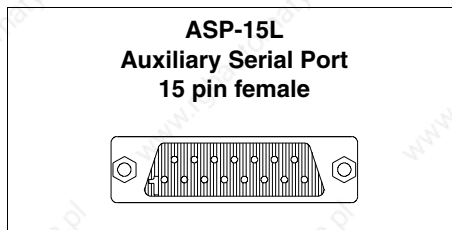

Pin	Signal	Notes
1	N.C.	Not connected
2	RX IN	RS232
3	TX OUT	RS232
4	N.C.	Not connected
5	Signal GND	Internal reference 0Volt
6	N.C.	Not connected
7	N.C.	Not connected
8	Tx/Rx +IN/OUT	RS485
9	N.C.	Not connected
10	N.C.	Not connected
11	N.C.	Not connected
12	N.C.	Not connected
13	N.C.	Not connected
14	N.C.	Not connected
15	Tx/Rx -IN/OUT	RS485

⚠ Before connecting in RS485, check the polarities. With some devices the Tx+/Rx+ and Tx-/Rx- signals or the polarities are inverted.

ASP-9 serial port

The ASP-9 serial port (Auxiliary Serial Port) consists of a D-Sub 9 pin male connector and can communicate using RS232.



Pin	Signal	Notes
1	DCD IN	--
2	RX IN	--
3	TX OUT	--
4	DTR OUT	--
5	Signal GND	Internal reference 0Volt
6	DSR IN	--
7	RTS OUT	--
8	CTS IN	--
9	RI IN	--

ASP-8 serial port

The ASP-8 (Auxiliary Serial Port) consists of a Minidin 8 pin female connector and can communicate using RS232.

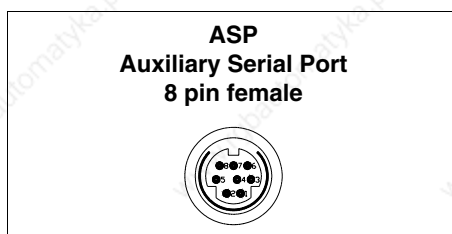

Pin	Signal	Notes
1	RX IN	--
2	TX OUT	--
3	N.C.	Not connected
4	RTS OUT	--
5	CTS IN	--
6	N.C.	Not connected
7	Signal GND	Internal reference 0Volt
8	+5Vdc (150mA Max.)	Reserved for Esa

⚠ Pin 8 does not provide for commuting any kind of load (coils etc.); an input disturbance at Pin 8 can cause the VT and therefore also the industrial process itself to malfunction.



Strong input disturbances at Pin 8 could damage the VT.

LPT parallel port

The LPT parallel port consists of a D-Sub 25 pin female connector. It is used to connect directly with the printer.

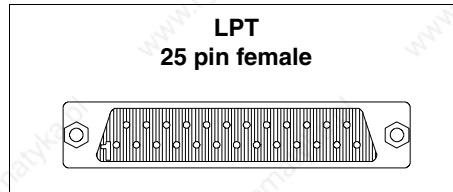

Pin	Signal	Notes
1	Strobe	--
2	PRN Data 0	--
3	PRN Data 1	--
4	PRN Data 2	--
5	PRN Data 3	--
6	PRN Data 4	--
7	PRN Data 5	--
8	PRN Data 6	--
9	PRN Data 7	--
10	N.C.	Not connected
11	PRN Busy	--
12	N.C.	Not connected
13	N.C.	Not connected
14	N.C.	Not connected
15	N.C.	Not connected
16	N.C.	Not connected
17	N.C.	Not connected
18	Signal GND	Internal reference 0Volt
19	Signal GND	Internal reference 0Volt
20	Signal GND	Internal reference 0Volt
21	Signal GND	Internal reference 0Volt
22	Signal GND	Internal reference 0Volt
23	Signal GND	Internal reference 0Volt
24	Signal GND	Internal reference 0Volt
25	Signal GND	Internal reference 0Volt

Ethernet port

The Ethernet port comprises an RJ45 8 pin female connector and is dedicated to creating network links with other terminals, with PCs and any other device that supports this standard.

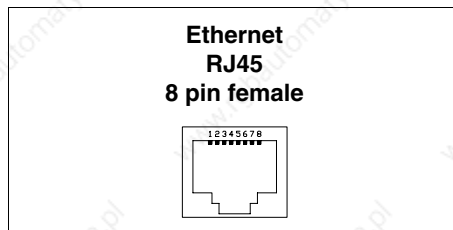

Pin	Signal	Notes
1	TX+	--
2	TX-	--
3	RX+	--
4	--	Reclosing with pin 5 and 75 ohm termination
5	--	Reclosing with pin 4 and 75 ohm termination
6	RX-	--
7	--	Reclosing with pin 8 and 75 ohm termination
8	--	Reclosing with pin 7 and 75 ohm termination

The Ethernet connector has two diagnostic LEDs on the communication and on the network connection. The following table gives the respective meanings.

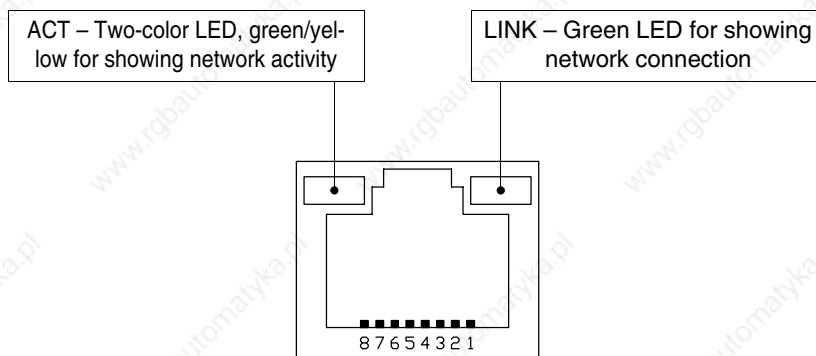

Led		Meaning
ACT	LINK	
Off	Off	Cable disconnected, interrupted or participants off
Do not care	On	Network connection
Yellow	On	Data exchange at 10Mbit
Green	On	Data exchange at 100Mbit

Interbus-S port

The NETWORK1 communication port consists of a 9-pin female D-Sub connector.

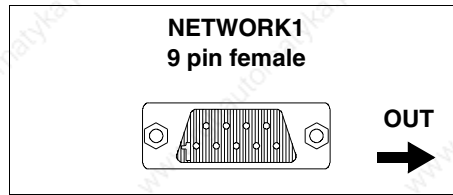

Pin	Signal	Notes
1	DO2	--
2	DI2	--
3	GND	Internal reference 0Volt
4	N.C.	Not connected
5	+5V	Reserved for Esa
6	/DO2	--
7	/DI2	--
8	N.C.	Not connected
9	RBST	--

⚠ Pin 5 does not provide for commuting any kind of load (coils etc.); an input disturbance at Pin 5 can cause the VT and therefore also the industrial process itself to malfunction.

☠ Strong input disturbances at Pin 5 could damage the VT.

The NETWORK2 communication port consists of a 9-pin male D-Sub connector.

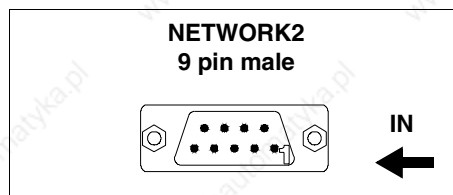

Pin	Signal	Notes
1	DO1	--
2	DI1	--
3	GND	Internal reference 0Volt
4	N.C.	Not connected
5	N.C.	Not connected
6	/DO1	--
7	/DI1	--
8	N.C.	Not connected
9	N.C.	Not connected

**Profibus-DP
port**

The communication port consists of a 9-pin female D-Sub connector.

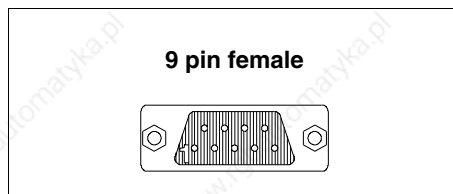

Pin	Signal	Notes
1	Shield	--
2	N.C.	Not connected
3	TxRx485+ Data B	--
4	Repeater-Control-signal RTS	--
5	Signal GND	Internal reference 0Volt
6	P5V	Reserved for Esa
7	N.C.	Not connected
8	TxRx485- Data A	--
9	N.C.	Not connected

⚠ Pin 6 does not provide for commutating any kind of load (coils etc.); an input disturbance at Pin 6 can cause the VT and therefore also the industrial process itself to malfunction.

🔥 Strong input disturbances at Pin 6 could damage the VT.

CAN port

The communication port consists of a 5 pin female terminal block (optoisolated interface).

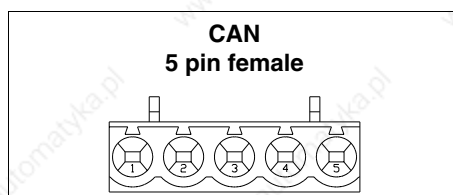

Pin	Signal	Notes
1	V-	--
2	CAN -	--
3	Shield	--
4	CAN +	--
5	N.C.	Not connected

RS485 serial port

The communication port consists of a 9-pin male D-Sub connector.

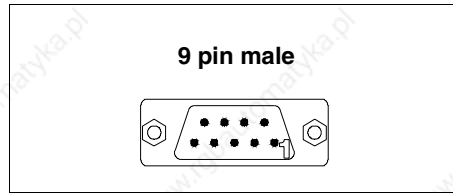

Pin	Signal	Notes
1	N.C.	Not connected
2	N.C.	Not connected
3	Tx/Rx +IN/OUT	RS485
4	N.C.	Not connected
5	Signal GND	Internal reference 0Volt
6	N.C.	Not connected
7	N.C.	Not connected
8	Tx/Rx -IN/OUT	RS485
9	N.C.	Not connected

PC/VT serial port

The communication port consists of a 9-pin male D-Sub connector for connecting a PC or VT in RS232.

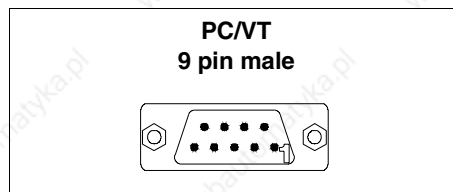

Pin	Signal	Notes
1	N.C.	Not connected
2	RX IN	--
3	TX OUT	--
4	DTR OUT	--
5	Signal GND	Internal reference 0Volt
6	N.C.	Not connected
7	RTS OUT	--
8	N.C.	Not connected
9	N.C.	Not connected

**PC <-> VT
connection**

To transfer the communication firmware, the communication driver and the project the VT must be connected to the PC (see Software Manual) and can be done using either Serial or Modem.

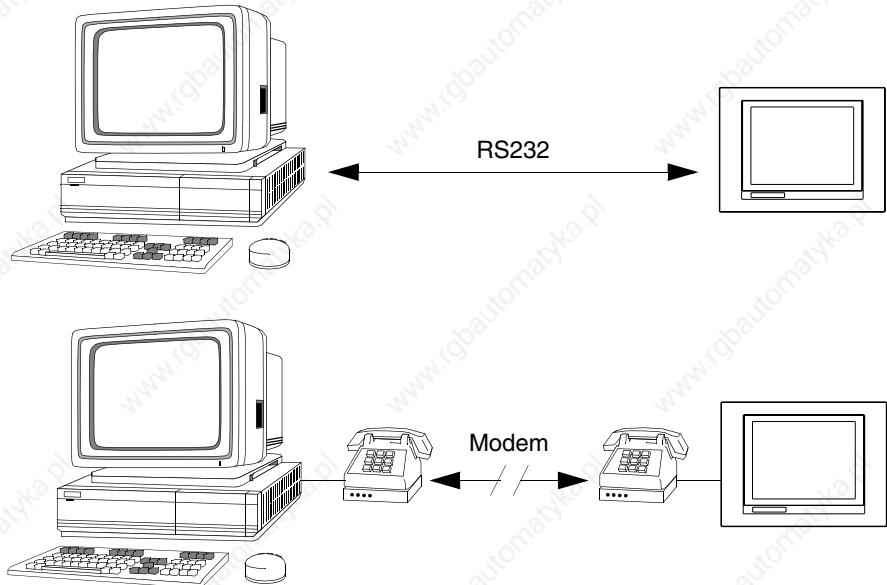

The cable required to make the connection is illustrated below.

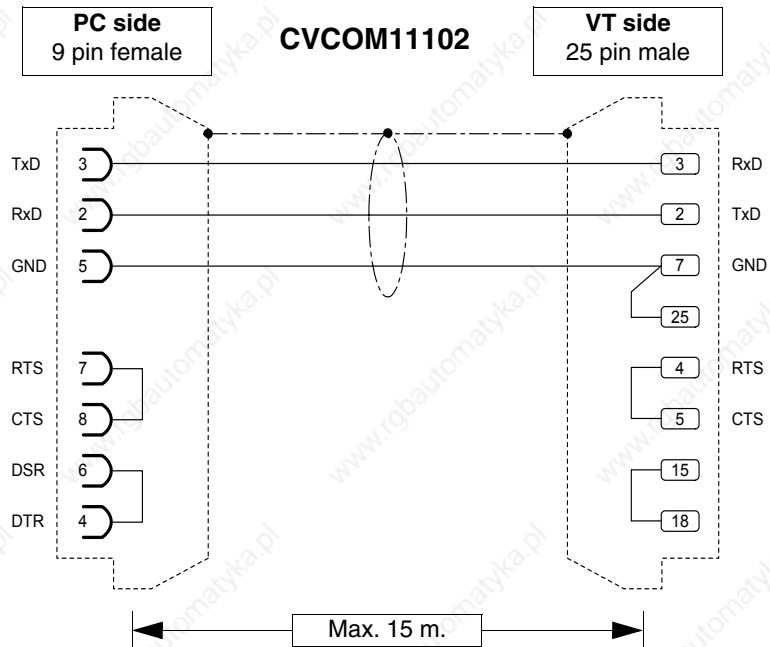

The cable in the above figure, together with the relevant adapters, can be used for all serial port connections of the VT. Below we list the adapters and the combinations necessary for the various connections.

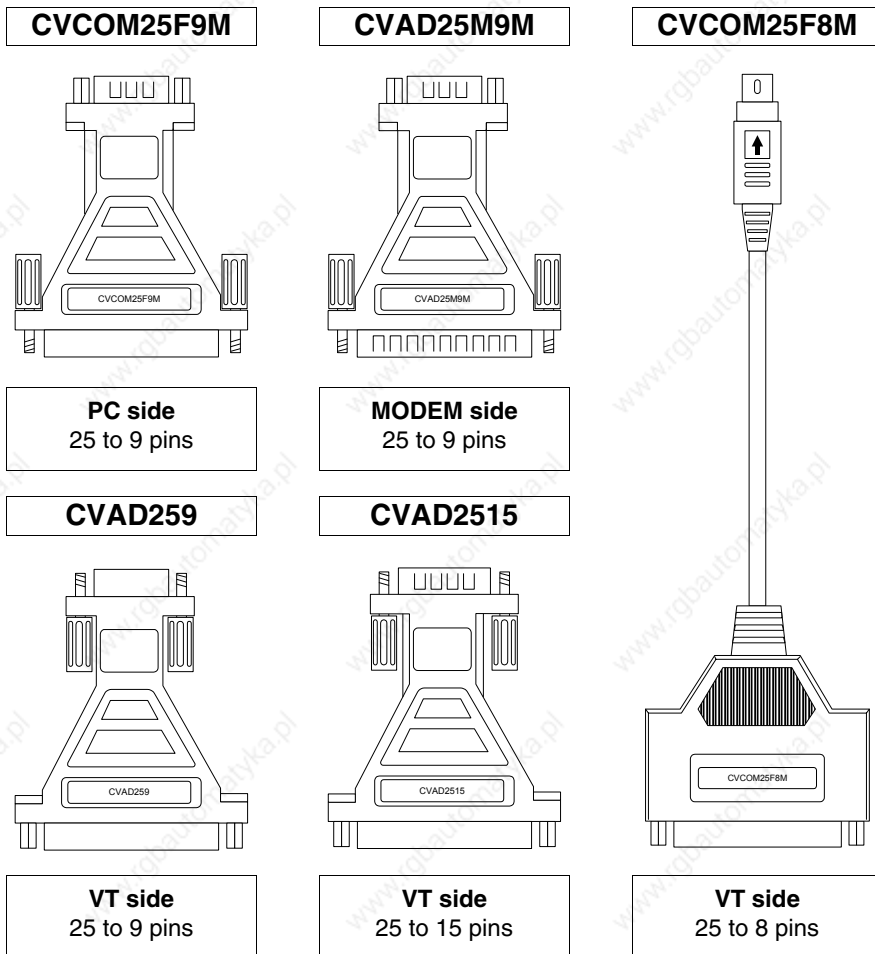

The table shows how to combine adaptors and cables connection to the various ports.

Table 30.2: Combination of serial transfer + adapters

MODEM	Serial		Cable	Adaptor				
	PC	VT	CVCOM 11102	CVCOM 25M9M	CVCOM 25F9M	CVCOM 25F8M	CVAD 259	CVAD 2515
--	9 pins	MSP	●	--	--	--	--	--
--	9 pins	ASP	●	--	--	--	--	●
--	9 pins	ASP-15L	●	--	--	--	--	●
--	9 pins	ASP-9	●	--	--	--	●	--
--	9 pins	ASP-8	●	--	--	●	--	--
--	25 pins	MSP	●	--	●	--	--	--
--	25 pins	ASP	●	--	●	--	--	●
--	25 pins	ASP-15L	●	--	●	--	--	●
--	25 pins	ASP-9	●	--	●	--	●	--
--	25 pins	ASP-8	●	--	●	●	--	--
25 pins	--	MSP	●	●	--	--	--	--
25 pins	--	ASP	●	●	--	--	--	●
25 pins	--	ASP-15L	--	--	--	--	--	--
25 pins	--	ASP-9	●	●	--	--	●	--
25 pins	--	ASP-8	--	--	--	--	--	--

Chapter 31 Settings for the Modem

Contents	Page
AT commands to be sent	31-2
Sending commands	31-3

This chapter consists of 6 pages.

Before proceeding to transfer via Modem it has to be set up for reception, that is, such that on receiving the call the Modem automatically responds and goes into data reception mode.



AT commands to be sent

Modems need a series of commands, some of which can be used to set the Modem. The table below lists the commands (supported by the majority of modems) necessary for setting the Modem as the VTs require. The command also comprises the parameter required.

Table 31.1: AT commands

Command	Effect
AT&D0	The modem ignores the DTR signal and considers it always activated.
AT&H0 or AT&K0	Disables the RTS/CTS flow check.
AT&R1	The modem ignores the RTS and considers it always active.
ATS0=3	Let it ring 3 times before responding.
ATLn	Set the volume of the modem, where n can have a value from 1 to 3 (1=Min - 3=Max).
AT&W0	Save the modem configuration.
AT&F	Reload the factory-made settings (default).

⚠ Should the commands not be accepted by the modem being used for the transfer, consult the producer's manual for a complete list of valid commands.

Sending commands

To send the commands connect the modem to the serial port of the PC using a standard serial cable.

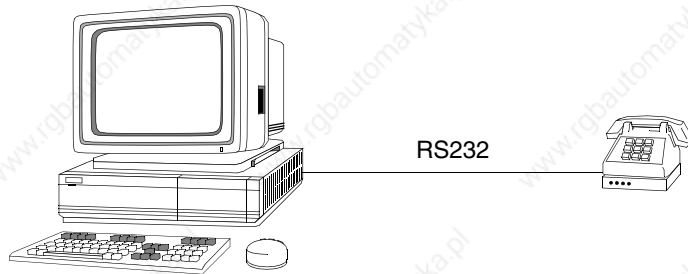

Once the connection and access are established the modem runs the HyperTerminal program (supplied with the PC's operating system) by clicking on **Start > Programs > Accessories > Communications > HyperTerminal**

Insert the name to be given to the connection.

Click on the  OK.

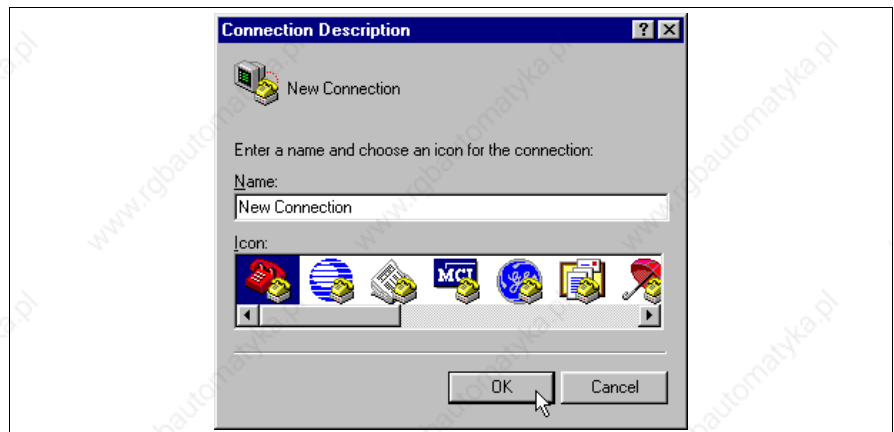

Set the COM where the Modem is connected (e.g. COM1).

Click on the  OK.



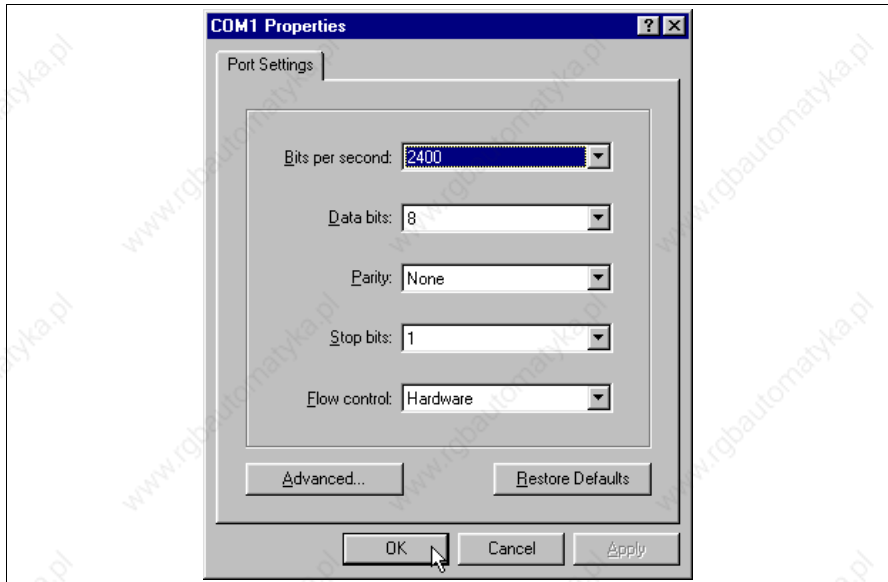

Set as in fig.

Click on the OK.

The main mask appears.

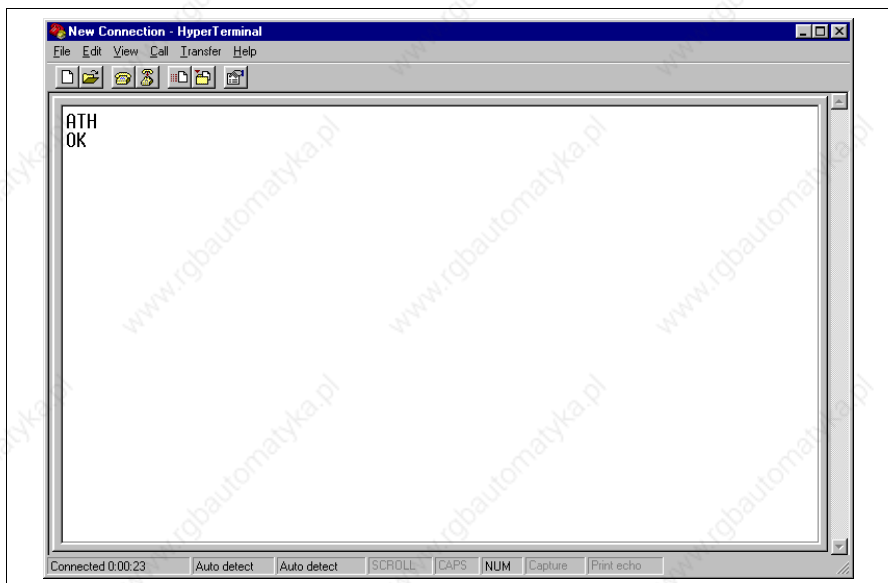

Check that there is a connection between PC and Modem.

Digit the ATH command and confirm with the Enter key of the PC.

If the message OK appears it means the connection is active.

Using the same criterion, digit all the commands necessary for setting the modem (see Page 31-2 -> AT commands to be sent).

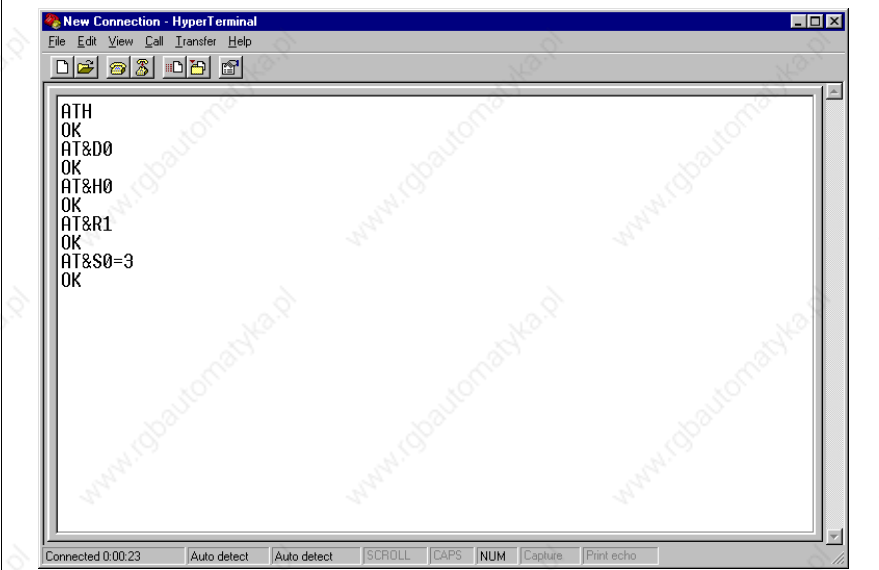

```
New Connection - HyperTerminal
File Edit View Call Transfer Help
ATH
OK
AT&D0
OK
AT&H0
OK
AT&R1
OK
AT&S0=3
OK
Connected 0:00:23 Auto detect Auto detect SCROLL CAPS NUM Capture Print echo
```

! If the modem is switched off the settings are lost. If they need to be kept, the settings can be saved using the appropriate command.

If required, you can digit `AT&W0` and confirm using the PC's Enter key.

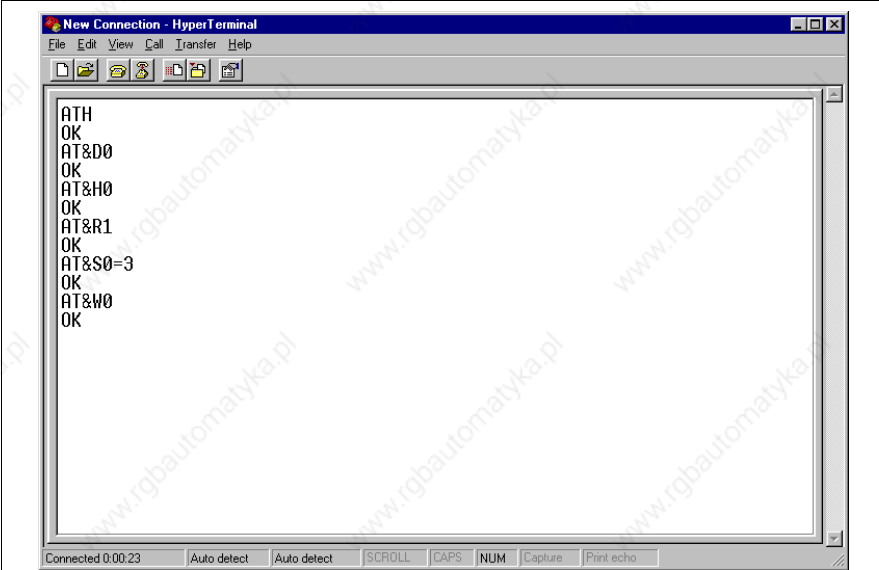

```
New Connection - HyperTerminal
File Edit View Call Transfer Help
ATH
OK
AT&D0
OK
AT&H0
OK
AT&R1
OK
AT&S0=3
OK
AT&W0
OK
Connected 0:00:23 Auto detect Auto detect SCROLL CAPS NUM Capture Print echo
```

The modem is ready to be connected to the VT.

Chapter 32 Connection cable for H Series terminals

Contents	Page
Standard series connection cable	32-2
Standard series connections without VTHCB	32-3
Standard series connections with VTHCB	32-6
CAN series connection cable	32-7
CAN series connections	32-7
Lay-out of button functions	32-8

This chapter consists of 10 pages.

Terminals belonging to H Series (Hand Held) are supplied with a 10-meter protected cable of 25x0.25 mm² (AWG24), already cabled.



Under no circumstances should you modify the length of the connection cable, as this could lead to malfunctioning.

Standard series connection cable

Below are the connections.

Cable from VT	Signals	Command and/or signal unit
Yellow-Green	⊕	Power supply
Red	+24VDC	
Black	0VDC	
Pink	TX RS232 OUT - MSP	Serial communication line
White	RX RS232 IN - MSP	
Blue	RTS RS232 OUT - MSP	
Green	CTS RS232 IN - MSP	
Yellow	Signal GND	
White-Grey	TX/RX RS485 -IN/OUT - MSP	
Yellow-White	TX/RX RS485 +IN/OUT - MSP	
Blue-Brown	TX RS232 OUT - ASP	
White-Red	RX RS232 IN - ASP	System shut-down button
White-Black	NC1	
Brown-Pink	NC2	
White-Blue	NC3	
Brown-Grey	NC4	Enabling button
Brown-Red	C1	
Yellow-Brown	NC1	
Violet	C2	Black button
Green-Brown	NO2	
Green-White	NO	Luminous green button
White-Pink	C	
Red-Blue	NO	Bulb
Grey-Pink	C	
Brown	-	
Grey	+	

In order to simplify the connection with the other devices you should use the VTHCB board (optional). This interface transforms the signals from the terminal serial line into the ESA standard (MSP, ASP-15L), allowing to use standard connection cables (see "Chapter 40 -> Connessione del Terminale ai Dispositivi").

To see what button does what, see Page 32-8.

Standard series connections without VTHCB

Connection to the DEVICE is possible in the modalities described below.

⚠ For practical reasons, the diagrams below represent both connections, although these are independent from each other. It is possible to perform the connections of the only serial you intend to use.

⚠ The serial line used directly on the cable DOES NOT allow the use of ESA standard connection cables (see "Chapter 40 -> Connessione del Terminale ai Dispositivi").

RS232 without RTS/CTS management:

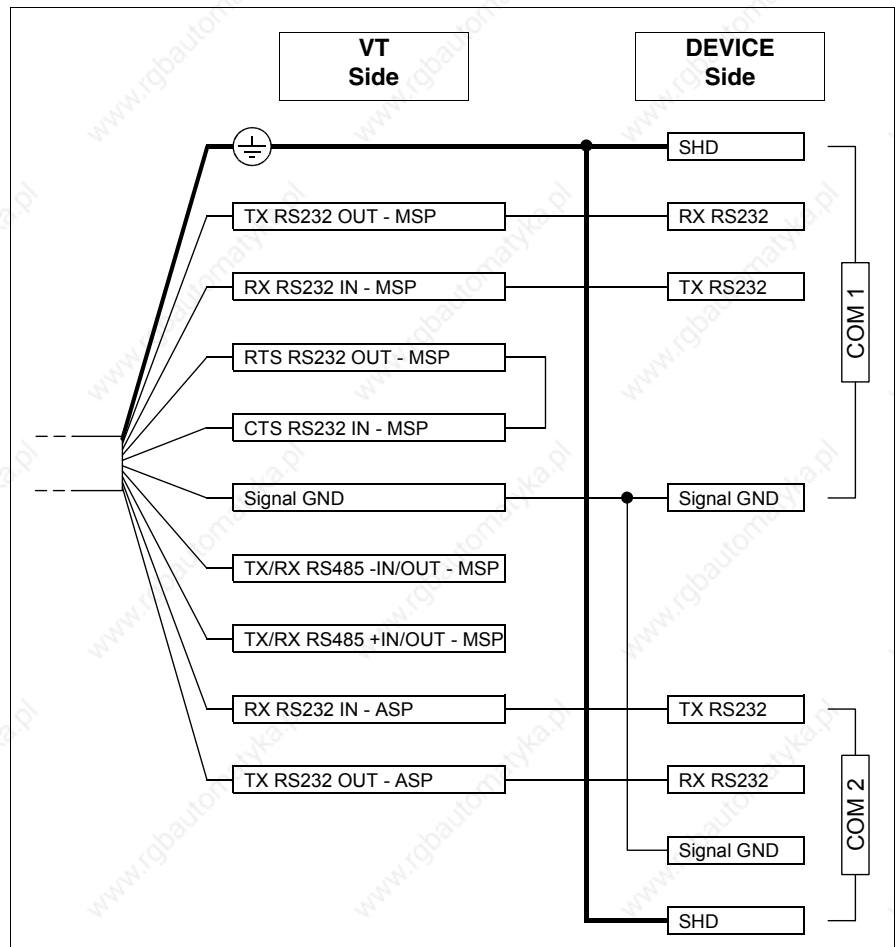

RS232 connection with RTS/CTS management:

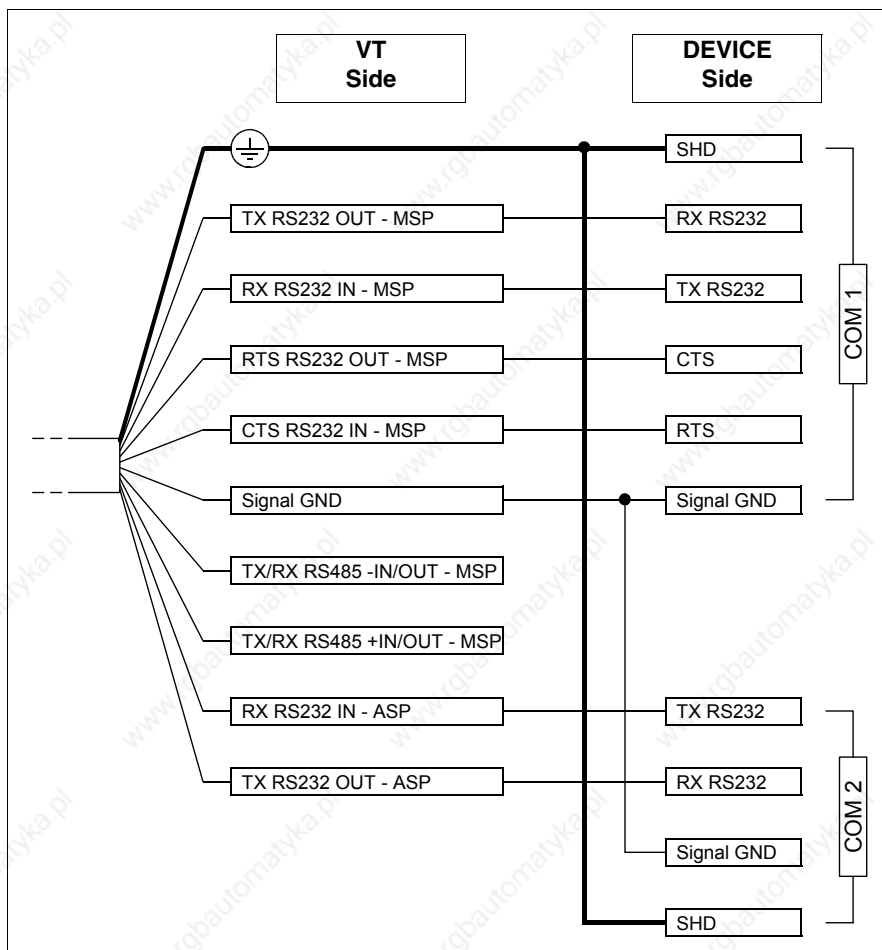

RS485 connection:

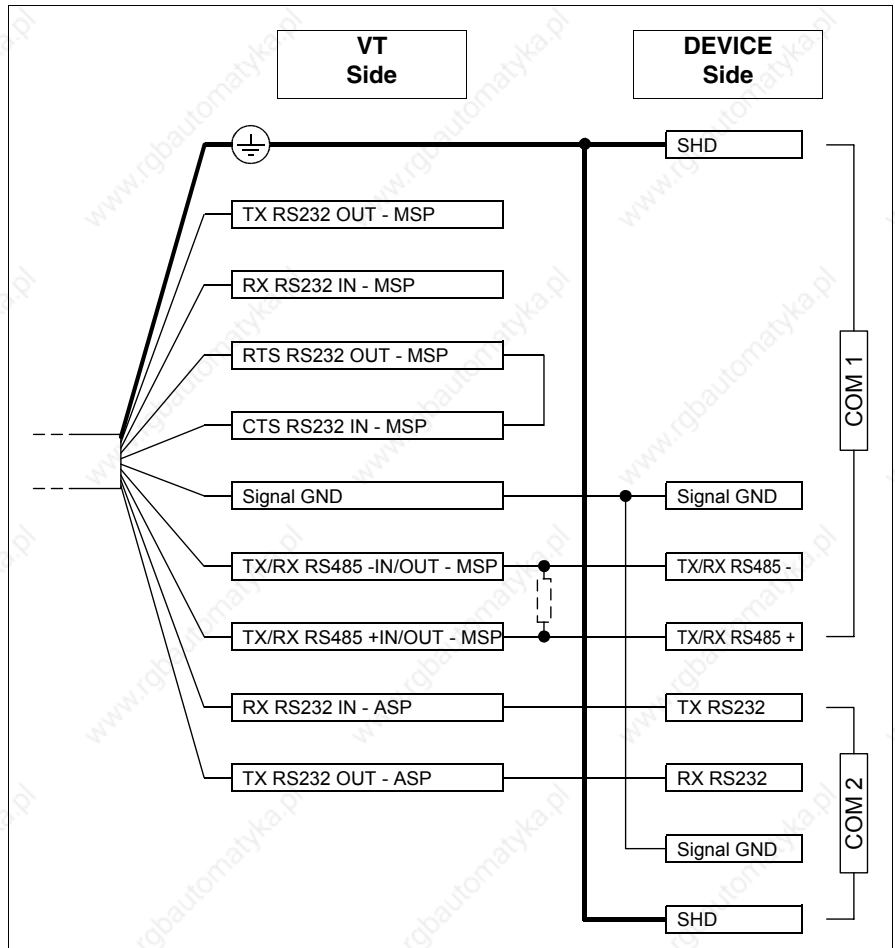

⚠ Always insert a 220 Ohm 1/4W resistance when the connection between VT and the device is point-to-point, or when the VT is inserted as the first or the last component in a network (see also "Chapter 34 -> Collegamento in rete").

It is possible to connect with the PC to transfer the project, as follows.

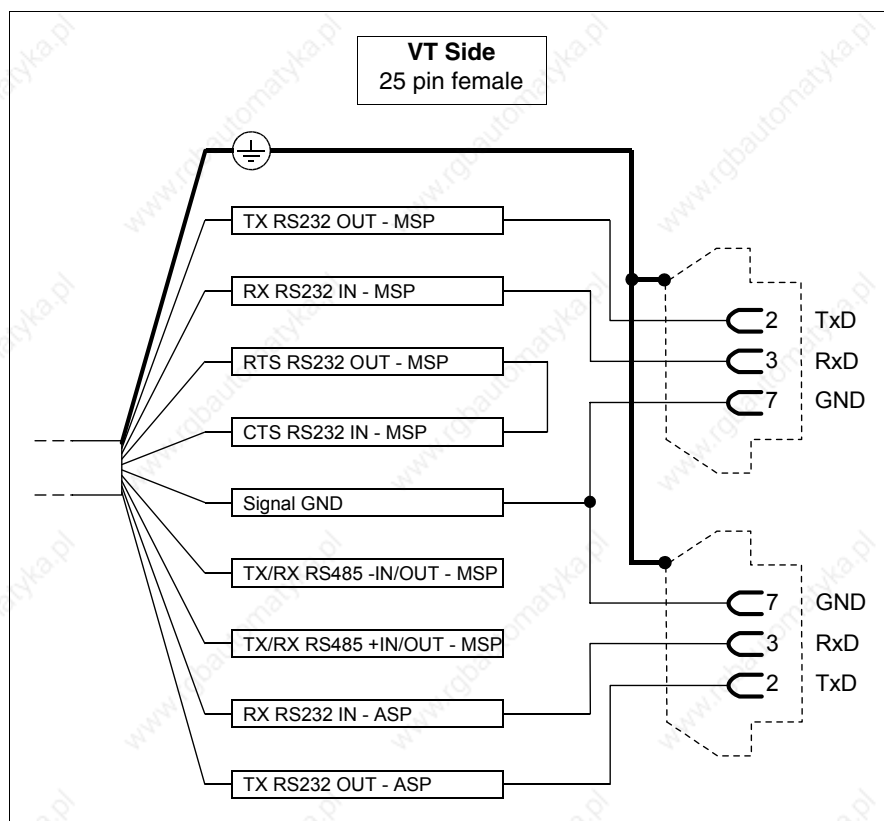

⚠ The use of a female 25-pole connector allows to use a standard CVCOM11102 cable for the transfer (see also “Chapter 30 -> Collegamento PC <-> VT”).

Standard series connections with VTHCB

For the connection of board VTHCB, please refer to its respective chapter (see “Chapter 33 -> Accessori per terminali video”).

CAN series connection cable

Below are the connections.

Cable from VT	Signals	Command and/or signal unit
Yellow-Green	⊕	Power supply
Red	+24VDC	
Black	0VDC	
Pink	TX RS232 OUT	Serial communication line
White	RX RS232 IN	
Yellow	Signal GND	
Blue	CAN-	CAN communication line
Green	V-	
White-Grey	Shield	
Yellow-White	CAN+	System shut-down button
White-Black	NC1	
Brown-Pink	NC2	
White-Blue	NC3	
Brown-Grey	NC4	Enabling button
Brown-Red	C1	
Yellow-Brown	NC1	
Violet	C2	
Green-Brown	NO2	Black button
Green-White	NO	
White-Pink	C	Luminous green button
Red-Blue	NO	
Grey-Pink	C	
Brown	-	Bulb
Grey	+	

 **The CAN series integrates the serial line termination resistances (typical 120 Ohm). The terminal is always supplied with a terminated CAN line.**

To see which button does what, see Page 32-8.

CAN series connections

The CAN terminal is not expected to be used with the accessory board VTHCB, which is why connections must be carried out directly on the cable.

For the connection diagram, see “Chapter 34 -> CAN Collegamento”.

It is possible to connect with the PC to transfer the project, as follows.

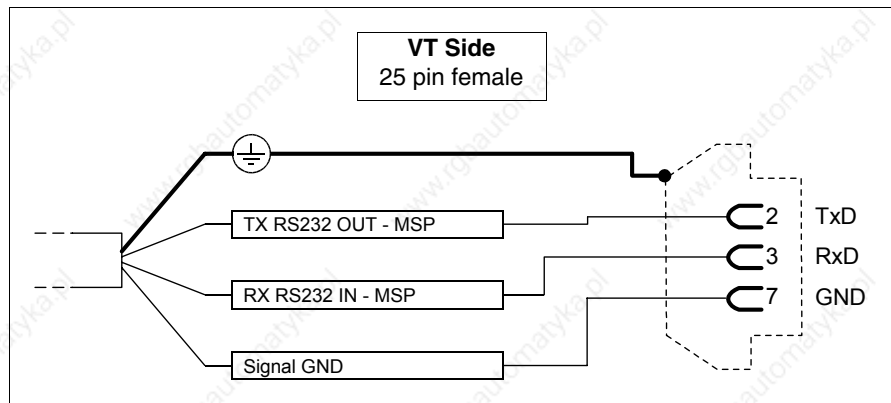

⚠ The use of a female 25-pole connector allows to use a standard CVCOM11102 cable for the transfer (see also “Chapter 30 -> Collegamento PC <-> VT”).

Lay-out of button functions

System shut-down button

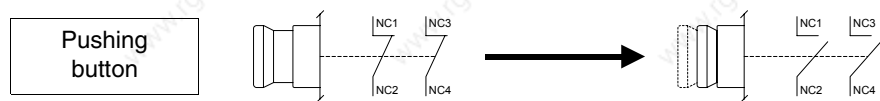

Enabling button

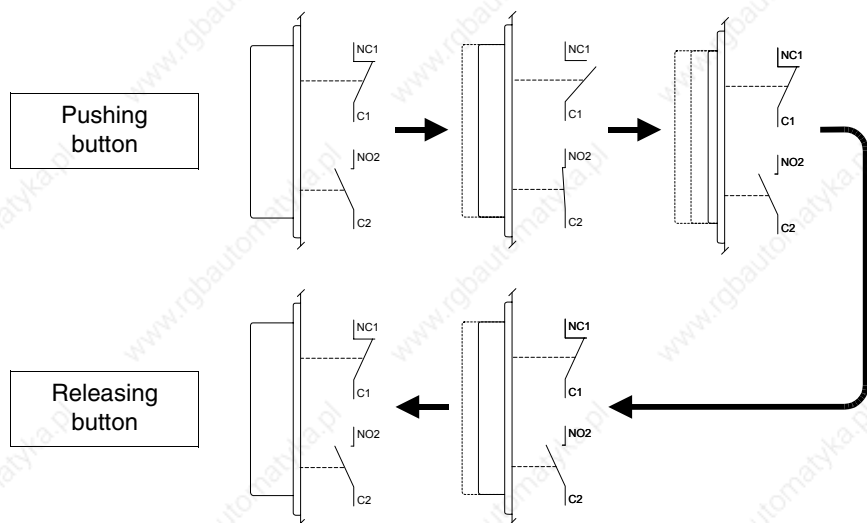

⚠ The system shut-down button and the enabling button do NOT guarantee the operator's complete personal safety. Be sure to

design your system so that it ensures the operator's complete personal safety.

Chapter 33 Video terminal accessories

Contents	Page
1/2AA Battery	33-4
Cell battery	33-4
Flash module	33-5
Fixing hook for Hand Held	33-8
Interface for connecting Hand Held with MSP/ASP-15L	33-9
Memory card	33-13
Memory module	33-18
Integrated Interbus-S module	33-19
Integrated Profibus-DP module	33-21
Protfilm4/6/6H/10/12	33-22
RS485 Serial module	33-21
Interbus-S and Profibus-DP card	33-27
Connection card for PC-NET	33-34
Adapter for external CAN network	33-37
20 key serial keyboard	33-42
Blank keyboard	33-46

This chapter consists of 50 pages.

The video terminals are made to take a series of accessories that increase their capacity and/or functionality. This chapter shows how these accessories relate to the various products. The table below shows which terminals will take which accessories.

Table 33.1: Accessories connectable to VT terminals (Part 1 of 2)

ACCESSORIES	TERMINALS SUPPORTING THE ACCESSORY
Lithium battery 3,6V 1/2AA	VT170W, VT190W
Lithium button cell battery 3V CR2032	VT300W, VT310W, VT320W, VT330W, VT555W, VT56xW, VT585W
Flash module 04	VT300W ² , VT310W ² , VT320W ² , VT330W ^{3-D} , VT56xW ^{2-C} , VT585W ^{3-D}
Flash module 08	VT330W ^{2-D} , VT575W ² , VT580W ² , VT585W ^{2-D} , VT585WB ² , VT595W ²
Fixing hook for Hand Held	VT505H, VT525H
Interface for connecting Hand Held with MSP/ASP-15L	VT505H, VT525H
Memory Card 4 Mbytes	VT300W ² , VT310W ² , VT320W ² , VT330W ^{3-B} , VT56xW ^{2-A} , VT585W ^{3-B}
Memory Card 8 Mbytes	VT330W ^{2-B} , VT575W ² , VT580W ² , VT585W ^{2-B} , VT585WB ² , VT595W ²
Memory module 512Kbytes	VT170W ¹ , VT190W ¹
Integrated Interbus-S module	VT170W, VT190W
Integrated Profibus-DP module	VT170W, VT190W
RS485 serial module	VT170W, VT190W
Protfilm4	VT155W, VT185W
Protfilm6	VT505W, VT515W, VT525W, VT555W, VT56xW, VT575W, VT580W
Protfilm6H	VT505H, VT525H
Protfilm10	VT585W, VT585WB
Protfilm12	VT585W
Interbus-S module	VT50 ⁵ , VT60, VT150W ⁵ , VT160W, VT170W, VT190W, VT300W ⁴⁻⁵ , VT310W ⁴ , VT320W ⁴ , VT330W ⁴ , VT155W ⁵ , VT185W ⁵ , VT505W ⁵ , VT515W ⁵ , VT525W ⁵ , VT555W ⁵ , VT56xW, VT575W, VT580W, VT585W ⁴ , VT585WB, VT595W
Profibus-DP module	VT50 ⁵ , VT60, VT150W ⁵ , VT160W, VT170W, VT190W, VT300W ⁴⁻⁵ , VT310W ⁴ , VT320W ⁴ , VT330W ⁴ , VT155W ⁵ , VT185W ⁵ , VT505W ⁵ , VT515W ⁵ , VT525W ⁵ , VT555W ⁵ , VT56xW, VT575W, VT580W, VT585W ⁴ , VT585WB, VT595W
Connection card for PC-NET	VT50 ⁵ , VT60, VT150W ⁵ , VT160W, VT170W, VT190W, VT300W ⁵ , VT310W, VT320W, VT330W, VT155W ⁵ , VT185W ⁵ , VT505W ⁵ , VT525W ⁵ , VT515W ⁵ , VT555W ⁵ , VT56xW, VT575W, VT580W, VT585W, VT585WB, VT595W
Adapter for external CAN network	VT50 ⁵ , VT60, VT150W ⁵ , VT160W, VT170W, VT190W, VT300W ⁴⁻⁵ , VT310W ⁴ , VT320W ⁴ , VT330W ⁴ , VT155W ⁵ , VT185W ⁵ , VT505W ⁵ , VT525W ⁵ , VT515W ⁵ , VT555W ⁵ , VT56xW, VT575W, VT580W, VT585W ⁴ , VT585WB, VT595W
Notes:	
1 - Already present on purchase	A - For terminals up to Rev. 3
2 - To be used as backup	B - For terminals up to Rev. 4
3 - To be used as expansion	C - For terminals from Rev. 4
4 - Can be fixed to back cover	D - For terminals from Rev. 5
5 - Not applicable in the case of CAN series terminals	

-- : not connectable

Table 33.1: Accessories connectable to VT terminals (Part 2 of 2)

ACCESSORIES	TERMINALS SUPPORTING THE ACCESSORY
Blank keyboard	VT150W, VT300W, VT310W, VT320W
Serial keyboard with 20 keys + LEDs	VT150W, VT300W, VT310W, VT320W
Notes: 1 - Already present on purchase 2 - To be used as backup 3 - To be used as expansion 4 - Can be fixed to back cover 5 - Not applicable in the case of CAN series terminals A - For terminals up to Rev. 3 B - For terminals up to Rev. 4 C - For terminals from Rev. 4 D - For terminals from Rev. 5	
-- : not connectable	

1/2AA Battery

The function of the battery is both to maintain the contents of the RAM (work recipes) and to keep the internal clock going when there is no power supply.

Battery to be used

Lithium 3.6V ½AA

 **The battery should be replaced about every 12 months.**

- The battery needs to be changed either when the Battery LED (on the VT keyboard) comes on or when indicated by the “Chapter 37 -> Status area for the terminal”. Failure to change the battery will lead to the contents of the data memory being lost.
- The battery must be substituted with the VT power off. At this point a high capacity condenser will momentarily preserve the RAM memory information (information is typically retained for 24 hours).

 **Discarded batteries should be placed in appropriate containers.**

Procedure for inserting or substituting the battery:

- Check that the power supply is not connected.
- Take off the hatch covering the battery compartment of the VT (see “Chapter 7 -> Rear view” and/or “Chapter 8 -> Rear view”).
- Pull off the black plastic safety-cover that snaps over the battery compartment.
- Insert the new battery checking that the polarities are correct.
- Push the safety-cover back on till it snaps into place.
- Replace the hatch covering the battery compartment of the VT (see “Chapter 7 -> Rear view” and/or “Chapter 8 -> Rear view”).
- Reconnect the power supply.

Cell battery

The function of the battery is both to maintain the contents of the RAM (work recipes) and to keep the internal clock going when there is no power supply.

Battery to be usedLithium 3V cell battery
CR2032

 **The battery should be replaced about every 12 months.**

- The battery needs to be changed either when the Battery LED (on the VT keyboard) comes on or when indicated by the “Chapter 37 -> Status area for the terminal“. Failure to change the battery will lead to the contents of the data memory being lost.

⚠ In the case of products with a Touch Screen, the running down and/or absence of the battery is not indicated on the screen.

- The battery must be substituted with the VT power off. At this point a high capacity condenser will momentarily preserve the RAM memory information (information is typically retained for 24 hours).

⚠ Discarded batteries should be placed in appropriate containers.

Procedure for inserting or substituting the battery:

- Check that the power supply is not connected.
- Take off the hatch covering the battery compartment of the VT.
- Insert the new battery checking that the polarities are correct.
- Replace the hatch covering the battery compartment of the VT.
- Reconnect the power supply.

Flash module

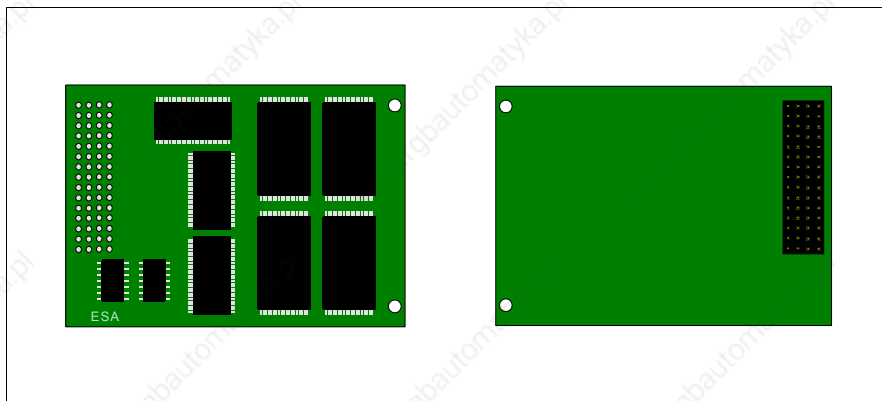

For more information regarding functions and technical details see Page 33-13 -> “Memory card“.

Inserting the flash module into the VT:

Procedure for inserting the card:

- Check that the VT is not connected to the power supply.
- Remove the back cover.
- Locate the following element.

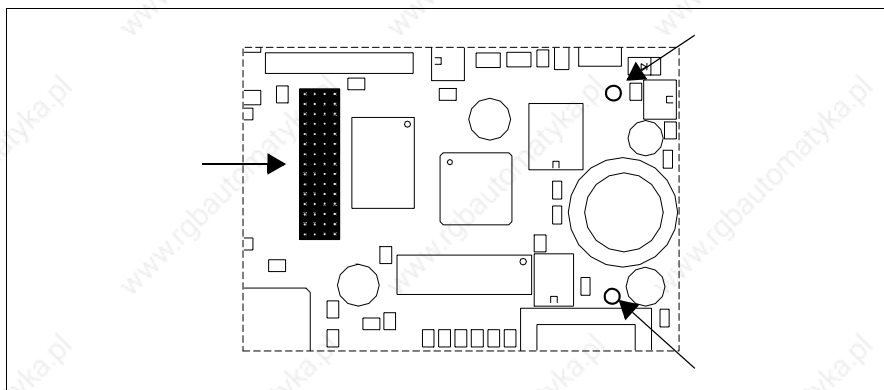

⚠ The position and direction on the printed circuit board may be different depending on which VT model is used.

- Insert the spacers (A) in the holes (B) taking care which way round they are put; then insert the “flash module” into the terminal.

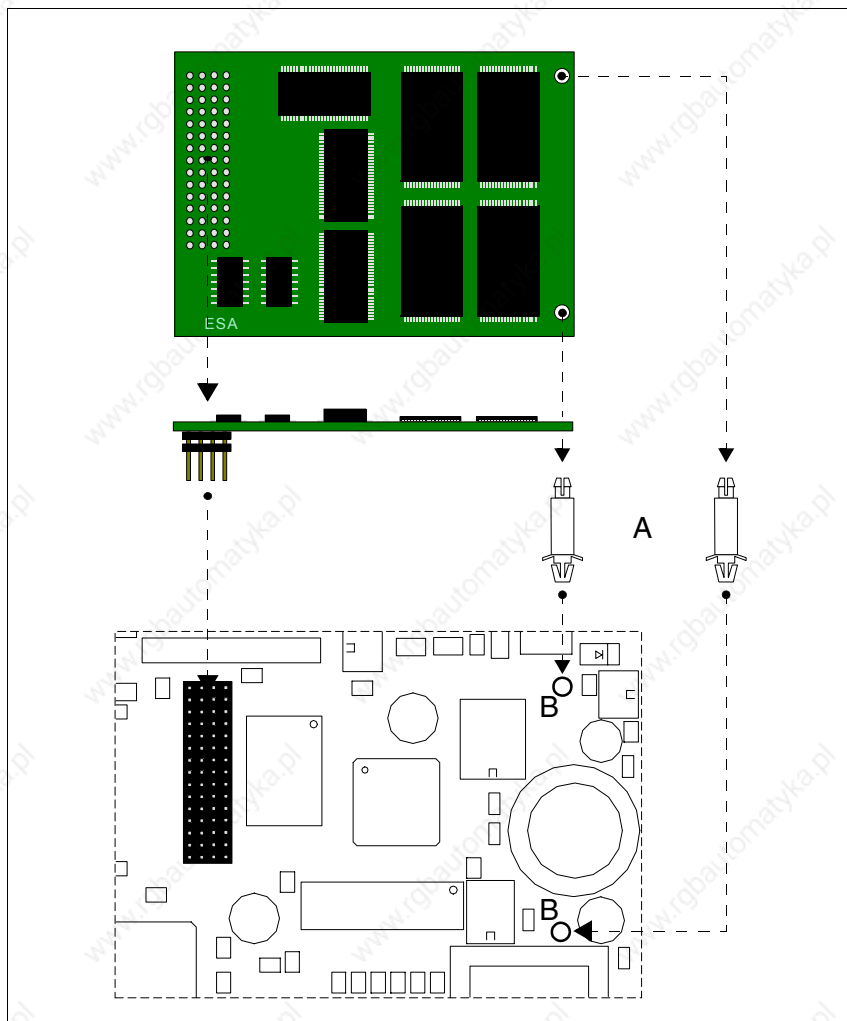

- Replace the back cover of the VT
- Reconnect the VT to the power supply.

Procedure for removing the flash module:

- Check that the VT power supply is disconnected.
- Remove the back cover.
- Locate the following element.

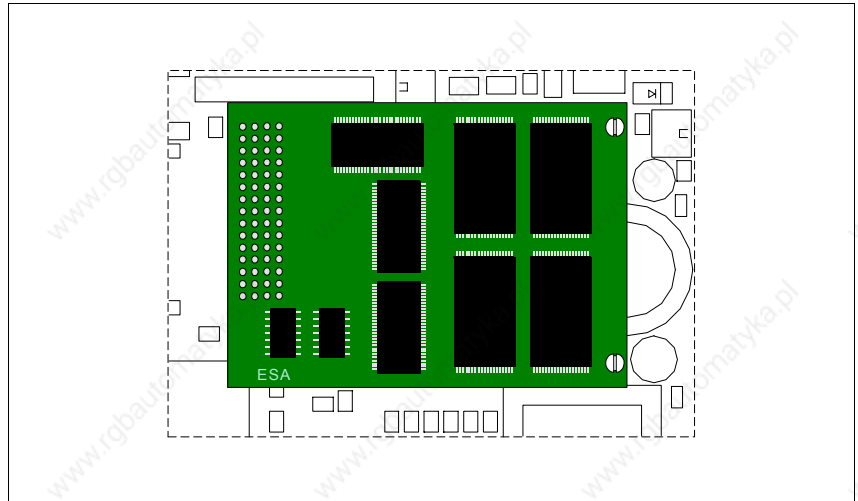

- To extract the connector (A), pull lightly, then pull on the corners, one by one, and at the same time press down on the head of the spacer (B).

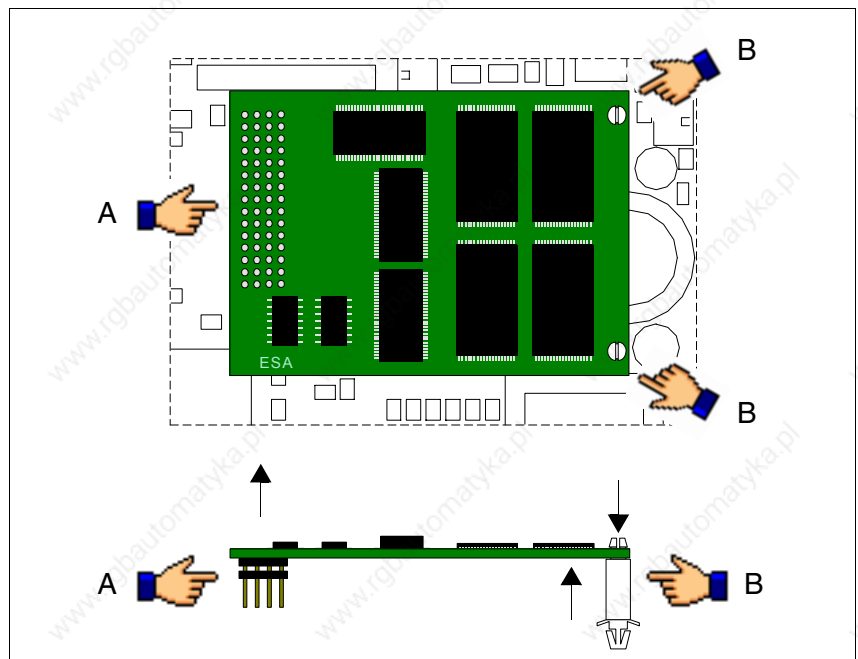

- Replace the back cover of the VT
- Reconnect the VT to the power supply.

Use of Flash module:

For information regarding the operation of the card, see Page 33-16 -> "Using the Memory Card:".

Fixing hook for Hand Held

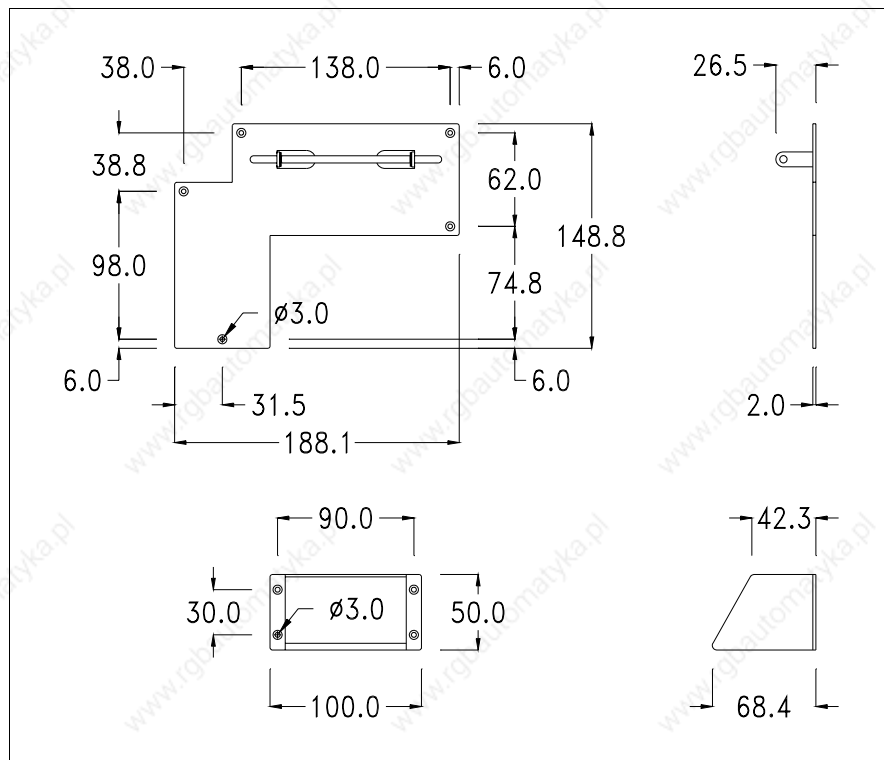

This is an accessory for fixing VTs that can't be embedded.



Do not alter the original form of the mounting hook or the tilt adjustment wedge.

Fixing the device:

Various ways of fixing the device are possible. For details see "Chapter 29 -> Fixing using external support".

Interface for connecting Hand Held with MSP/ASP-15L

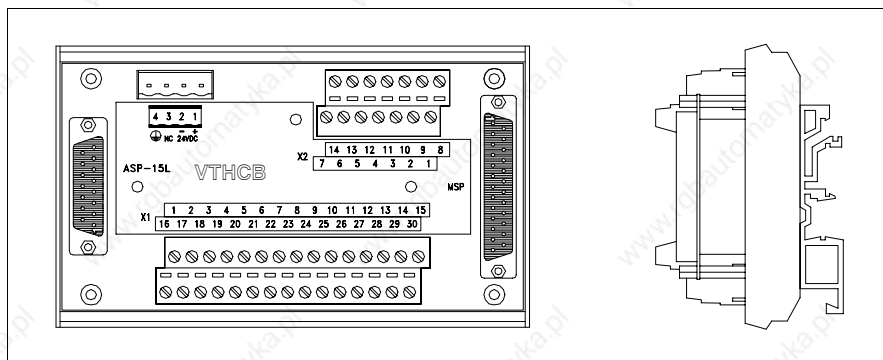

The table below lists the principal technical characteristics of the product under discussion.

Connector block	
Number of connection points (X1/X2)	30/14
Section of connectable wire	0,05-1,5 mmq (30-16AWG)
Stripped length of connectable wire	5-6 mm
Technical data	
Power supply	24Vdc (18..32Vcc)
Power absorbed at 24Vdc	0,5W
Protection level	--
Operating temperature	0..50°C
Storage and transportation temperature	-20..+60°C
Humidity (non-condensing)	85%
Weight	250gr
Dimensions	
External W x H x D [mm]	136 x 82 x 54,5
Cut-out W x H [mm]	--

The above-mentioned board enables a VTxxxH to be connected to other devices using standard ESA cables (see “Chapter 40 -> Connection cables”). The board has a 25-pin female D-Sub MSP connector (for details see “Chapter 30 -> MSP serial port”) and a 15-pin female D-Sub ASP-15L connector (for details see “Chapter 30 -> ASP-15L serial port”).

⚠ The ASP-15L port does not work when connected to a VT505H and is limited to RS232 when connected to a VT525H.

⚠ See “Chapter 2 -> Power Supply” for connecting the power supply.

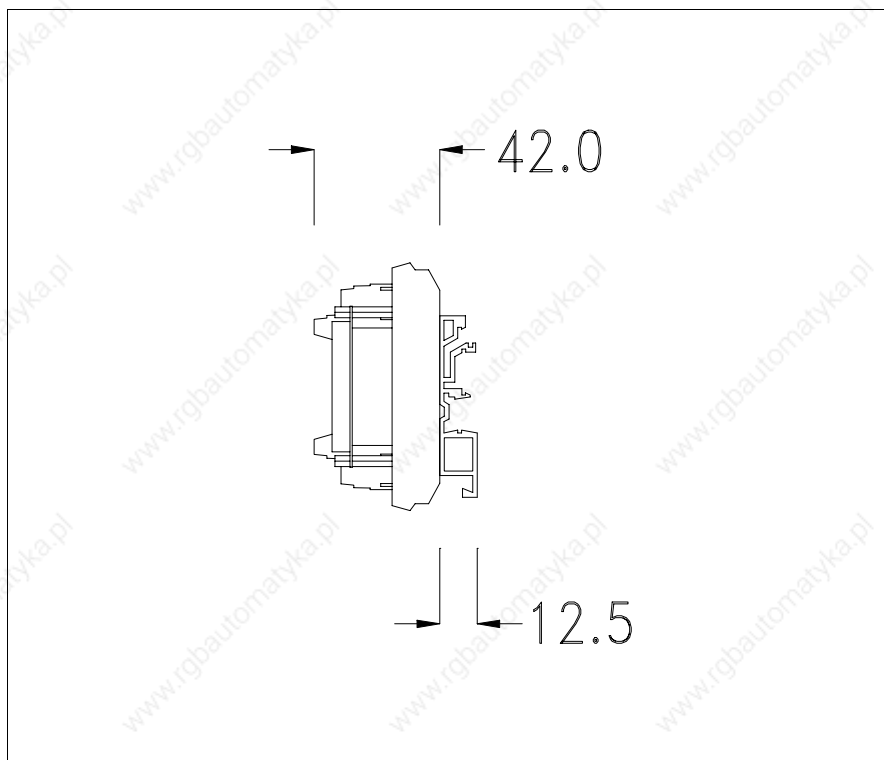
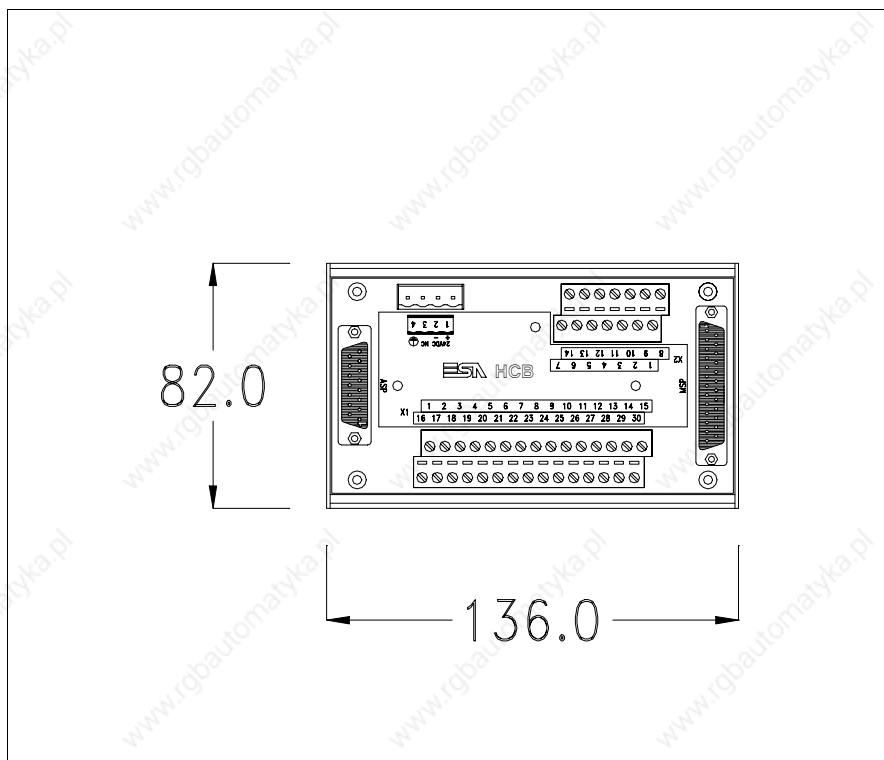
Dimensions:

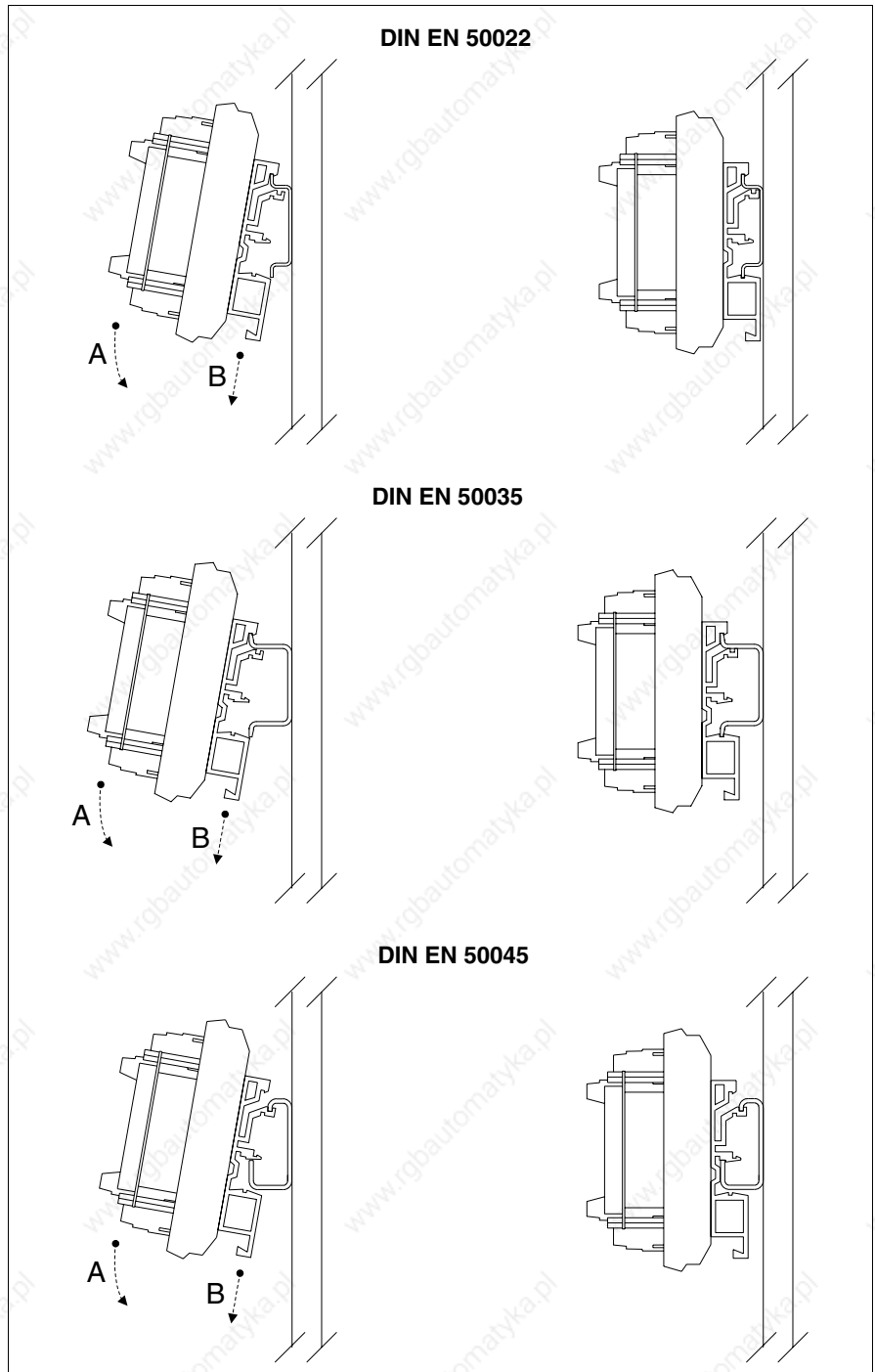
Securing the DIN rail mounting plate:

- Hook the upper part of the plate onto the DIN rail.
- Press the device in the direction indicated. (Arrow A)
- To make it easier to hook on, pull the spring-clip in the direction indicated. (Arrow B)

Connection cable :

The terminal is provided with a 25x0.25mmq (AWG24) shielded cable already attached to be connected to terminal block X1 (strip back cable 5-6mm).

Connection VT <-> VTHCB			Connection VTHCB <-> Electrical panel	
Command and/or signal unit	Cable from VT	Connector block X1	Connector block X2	Internal switchboard
Other signals relating to operation of board	Yellow-Green	19	--	See electrical lay-out for end user
	Red	1		
	Black	16		
	Pink	13		
	White	28		
	Blue	29		
	Green	30		
	Yellow	17		
	White-Grey	14		
	Yellow-White	15		
VT525H only	Blue-Brown	5		
	White-Red	20		
System shut-down button	NC1	White-Black	6	7
	NC2	Brown-Pink	21	14
	NC3	White-Blue	22	13
	NC4	Brown-Grey	7	6
Enabling button	C1	Brown-Red	23	12
	NC1	Yellow-Brown	8	5
	C2	Violet	24	11
	NO2	Green-Brown	9	4
Black button	NO	Green-White	11	2
	C	White-Pink	10	3
Luminous green button	NO	Red-Blue	26	9
	C	Grey-Pink	25	10
Bulb	-	Brown	27	8
	+	Grey	12	1

 **Never alter the length of the connection cable as this may cause malfunctioning.**

Example of implementation of VTHCB board.

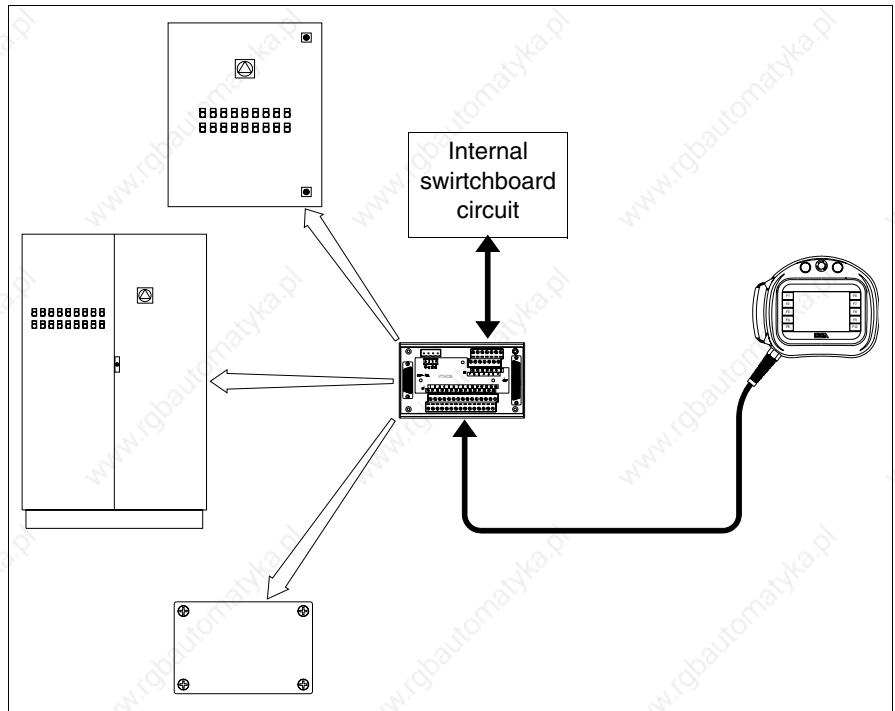

Memory card

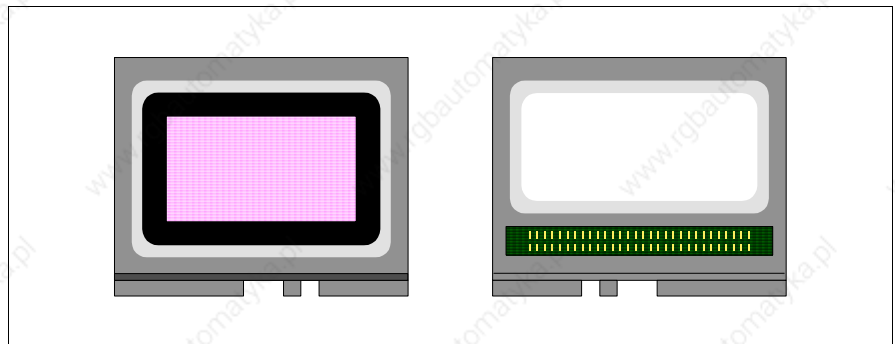

This is a removable device in which you can store the information contained in the VT terminal.

The Memory Card (Flash EPROM type) can be used:

- as a backup for the project and firmware
- to load one or more terminals without using a PC
- to send the end-user updates (without VTWIN)

The types of information that can be stored on the Memory Card are:

- Firmware
- Project
- Recipes
- Alarm history buffer
- Start-up language
- Password

The following table lists the principal technical characteristics of the product in question.

Technical data	
Memory	4Mb or 8Mb

Inserting the memory card into the VT:

Procedure for inserting the card:

- Check that the VT is not connected to the power supply.
- Remove the back cover.
- Locate the following element.

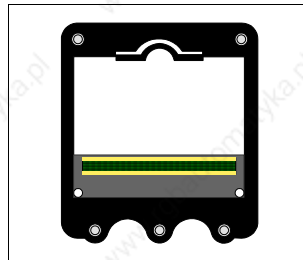

- Insert the memory card in its housing, checking that it is the right way round.

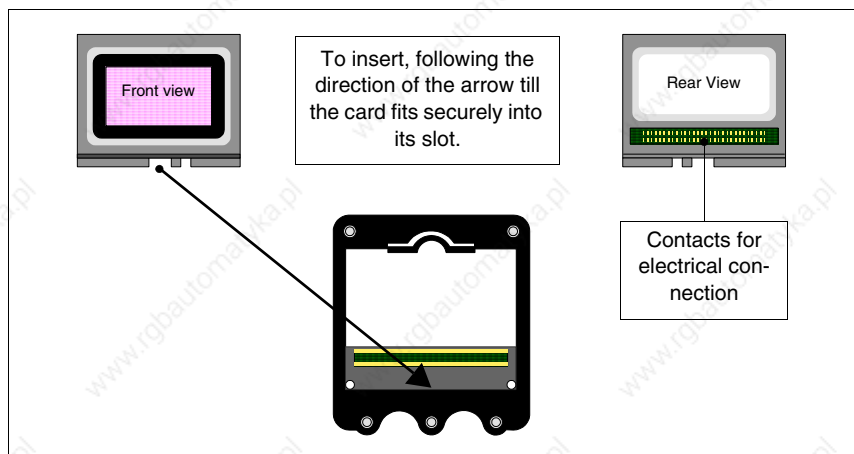

- Once the memory card fits in the groove, press lightly as shown in the figure till you feel it click into place.

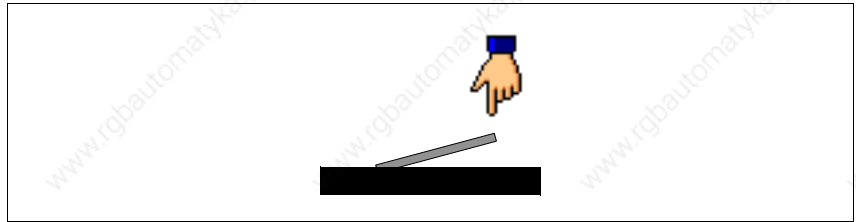

- Replace the back cover of the VT
- Reconnect the VT to the power supply.

Procedure for removing the memory card:

- Check that the VT power supply is disconnected.
- Remove the back cover.
- Locate the following element.

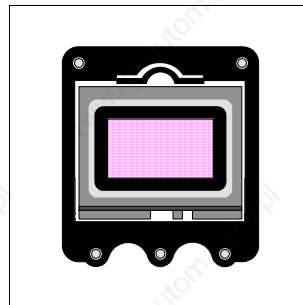

- Press lightly on the fixing tab of the memory card (see figure below) in the direction of the arrow.

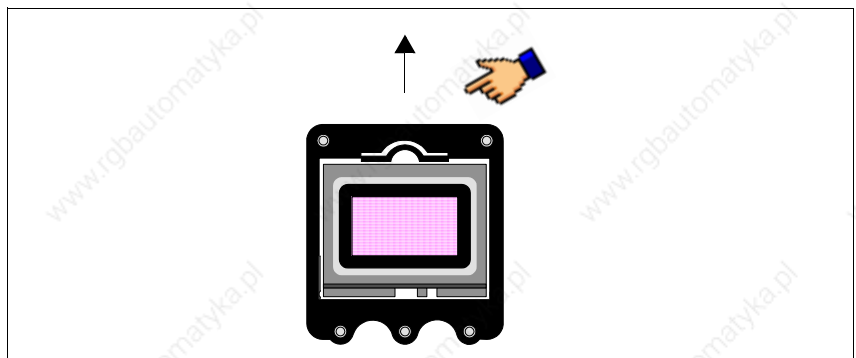

- Once the memory card is unhooked (see figure) remove it following the direction of the arrow.

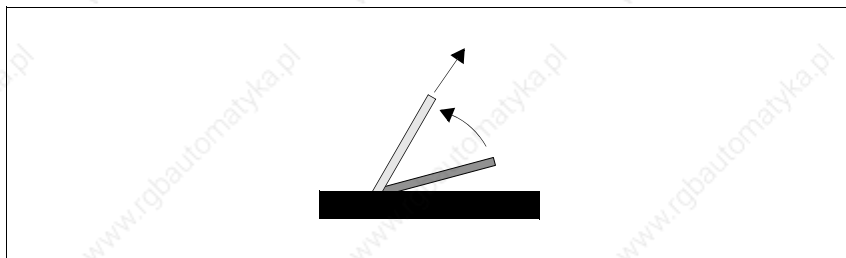

- Replace the back cover on the VT
- Reconnect the power supply to the VT

Using the Memory Card:

To operate the memory card you need to be in an appropriate page containing the menu with the corresponding commands (for how to enter the menu page see the chapter for the product concerned).

The graphic form of the page, the contents of the menus and their meaning depend on the type of terminal being used.

! The functions listed below do NOT require confirmation; press the key and the function will be executed (also in the case of Erase).

The following are the functions available with VT300W, VT310W, VT320W, VT56xW, VT585W:

- Erase
- Restore
- Backup
- Exit

Erase:

Makes it possible to erase the Memory Card completely with permanent loss of data on it.

Restore:

Makes it possible to transfer the contents of the Memory Card to the VT terminal.

Backup:

Makes it possible to transfer data from the memory of the VT terminal to the Memory Card.

Exit:

Makes it possible to quit the menu page and return to the previous page.

 **It is not possible to partially cancel or write the Memory Card; consequently single items of information (only firmware, only recipes, etc.) can neither be added or deleted.**

The following are the functions available with VT330W, VT575W, VT580W, VT585WB and VT595W:

- Backup ALL
- Backup FW/PRJ
- Backup RECIPES
- Backup ALARMS
- Restore ALL
- Restore FW/PRJ
- Restore RECIPES
- Restore ALARMS
- Exit

Backup ALL:

This function allows you to clear the memory card of its data, all its contents being definitively lost, and then to transfer to it all the data contained in VT memory.

Backup FW/PRJ:

This function allows you to clear the relevant section of the memory card of its data, all its contents being definitively lost, and then to transfer to it the project (Start-up language and Password included) and the firmware contained in VT memory.

Backup RECIPES:

This function allows you to clear the relevant section of the memory card of its data, all its contents being definitively lost, and then to transfer to it the recipes contained in VT memory.

Backup ALARMS:

This function allows you to clear the relevant section of the memory card of its data, all its contents being definitively lost, and then to transfer to it the alarm buffer contained in VT memory.

Restore ALL:

This function allows you to transfer the complete content of the memory card to the VT.

Restore FW/PRJ:

This function allows you to transfer the project and the firmware contained in the memory card into the VT.

Restore RECIPES:

This function allows you to transfer the recipes contained in the memory card into the VT.

Restore ALARMS:

This function allows you to transfer the alarm buffers contained in the memory card into the VT.

Exit:

Makes it possible to quit the menu page and return to the previous page.

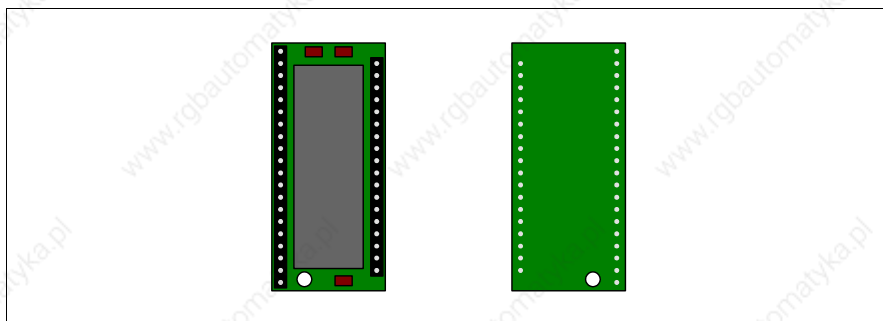
Memory module

This is a removable device capable of saving the VT's firmware and its project.

⚠ Although the device is removable, there must be a Memory module in the terminal for it to function.

The following table lists the principal technical characteristics of the product under discussion.

Technical data	
Memory	512Kbytes

Substituting the Memory module:

- Check that the VT power supply is not connected.
- Remove the back cover.
- Locate the already existing module.
- Remove this module with great care.
- Insert the new module.
- Replace the back cover.
- Reconnect the power supply.

Integrated Interbus-S module

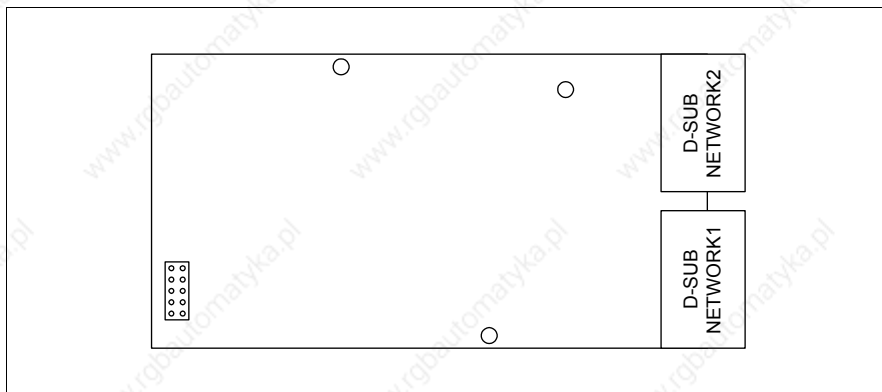

The integrated module shown above allows you to connect a number of terminals in an Interbus-S network. For more details concerning the network connection of the terminals see “Chapter 34 -> Network connection“.

The NETWORK1 communication port consists of a 9-pin female D-Sub connector (see “Chapter 30 -> Interbus-S port“).

The NETWORK2 communication port consists of a 9-pin male D-Sub connector (see “Chapter 30 -> Interbus-S port“).

Inserting the module in the VT:

- Check that the power supply of the VT is not connected.
- Remove the back cover.
- Locate the elements indicated by the arrow.

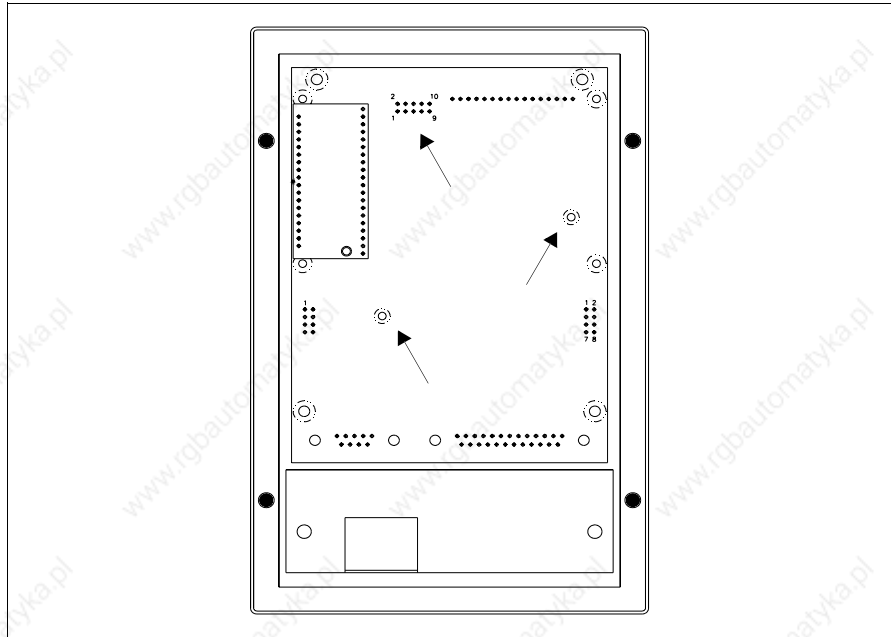

- Insert the spacers (A) into the holes (B), checking that they are the right way round; now insert the module into the terminal.

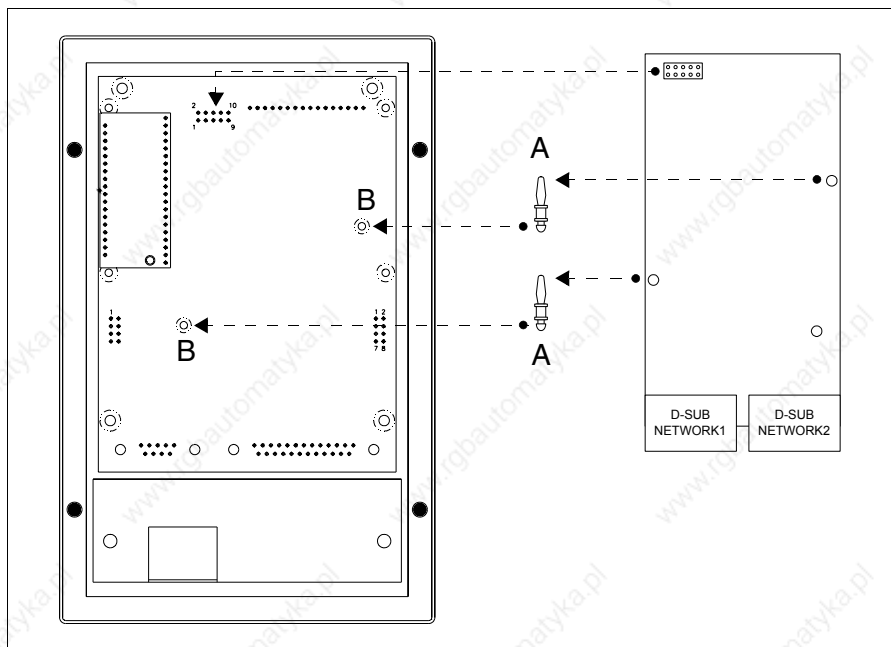

- Set the network address using the appropriate Dip-Switch (not present on this module).
- Replace the back cover.
- Reconnect the power supply of the VT.

▲ The figures above relate to VT170W; basically the procedure for insertion is the same for all the products in which this type of module can be inserted (see Page 33-2).

Integrated Profibus-DP module

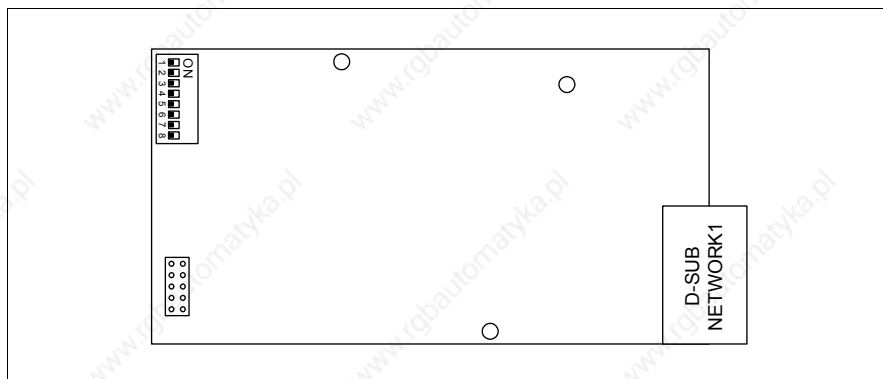

The integrated module shown above enables a number of terminals to be connected in a Profibus-DP network. (For further details on how terminals are connected in the network see “Chapter 34 -> Network connection“.) The NETWORK1 communication port consists of a 9-pin female D-Sub connector (see “Chapter 30 -> Profibus-DP port“).

See Page 33-19 for how to insert the module in the VT.

RS485 Serial module

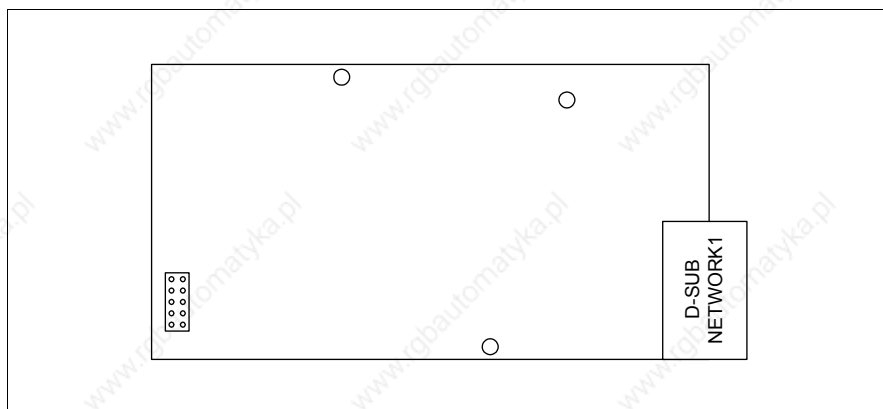

The integrated module shown above allows many terminals to be connected in an ESA-Net network. (For further details regarding the connection of terminals in the network see “Chapter 34 -> Network connection“.)

The NETWORK1 communication port consists of a 9-pin male D-Sub connector (see “Chapter 30 -> RS485 serial port“).

See Page 33-19 for how to insert the module into the VT.

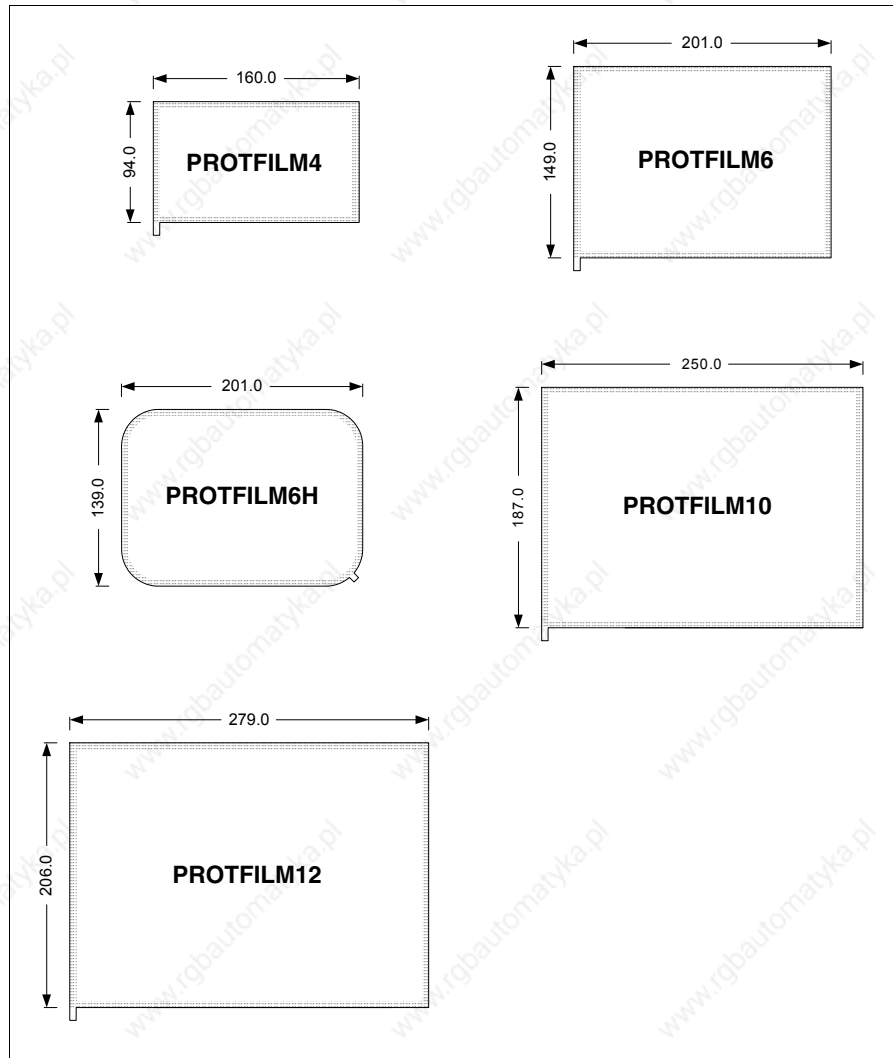
**Protfilm4/6/6H/
10/12**

This is a transparent protective film to be applied to the front of the touch screen terminal to protect it from wear on the part of external agents (see “Chapter 41 -> Resistance to chemical substances”).

Applying the film:

How to apply the adhesive film:

- Remove any trace of dirt or grease from the terminal using denaturized ethyl alcohol
- Dry the area thoroughly
- Locate the adhesive part of the transparent film

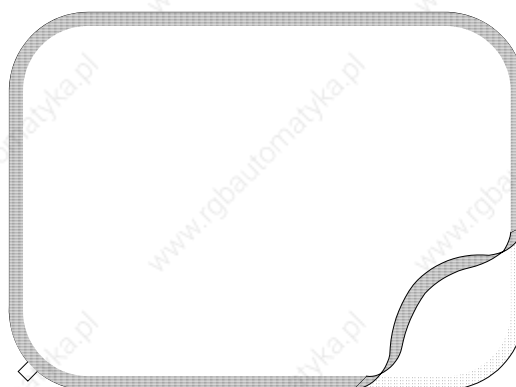
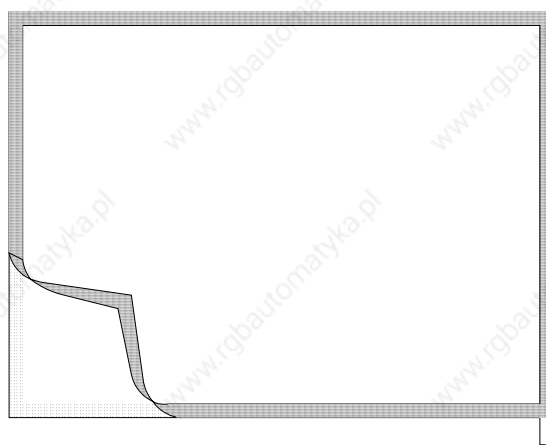

- Position the film near the upper edge and smooth it down delicately

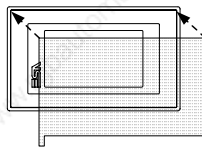

VT155/185W

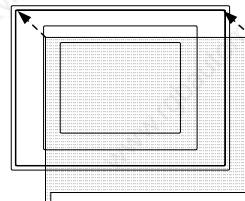

VT505/515/525/555/56xW

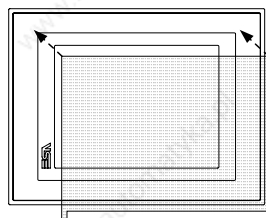

VT575W

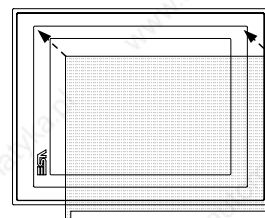

VT580W

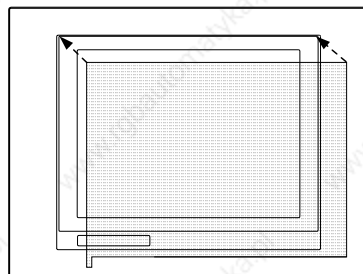

VT585W

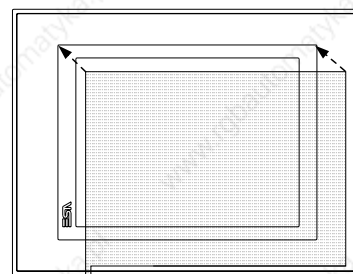

VT585WB

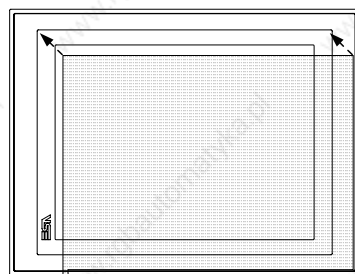

VT595W

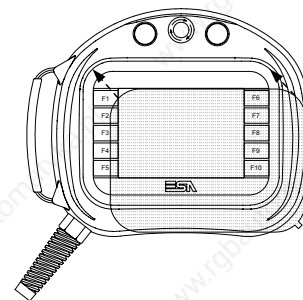

VT505/525H

- Pass a soft cloth firmly over the edges to ensure adhesion

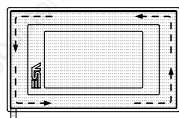

VT155/185W

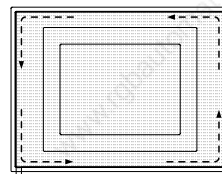

VT505/515/525/555/56xW

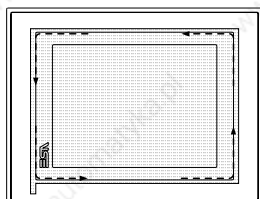

VT575W

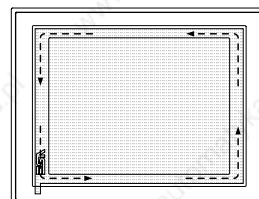

VT580W

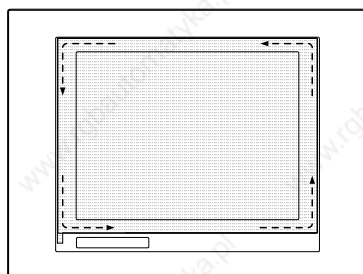

VT585W

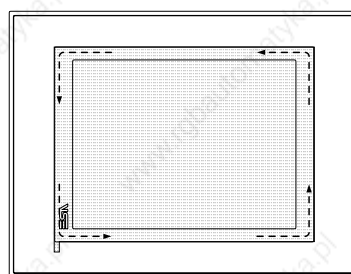

VT585WB

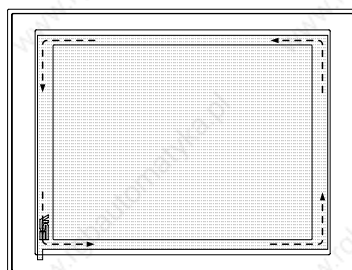

VT595W

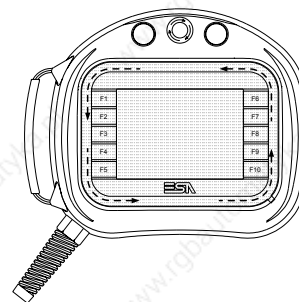

VT505/525H

How to remove the adhesive film:

- To remove the film, pull upwards using the tab

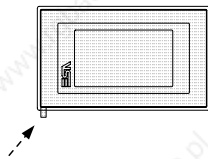

VT155/185W

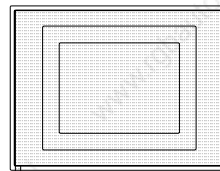

VT505/515/525/555/56xW

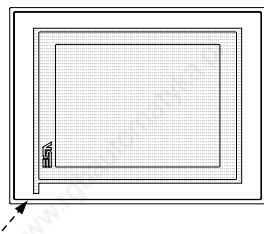

VT575W

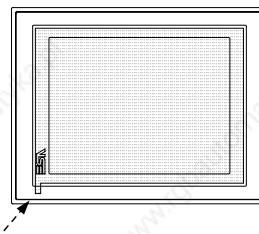

VT580W

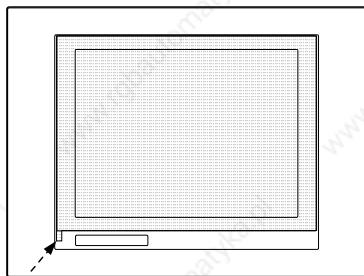

VT585W

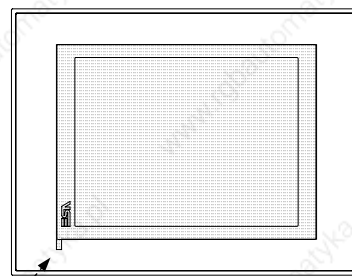

VT585WB

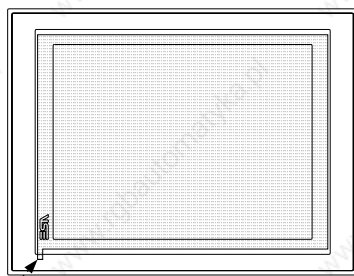

VT595W

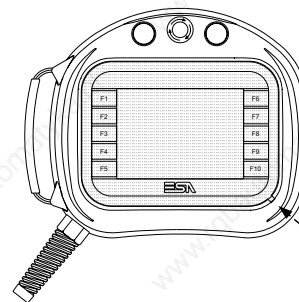

VT505/525H

Interbus-S and Profibus-DP card

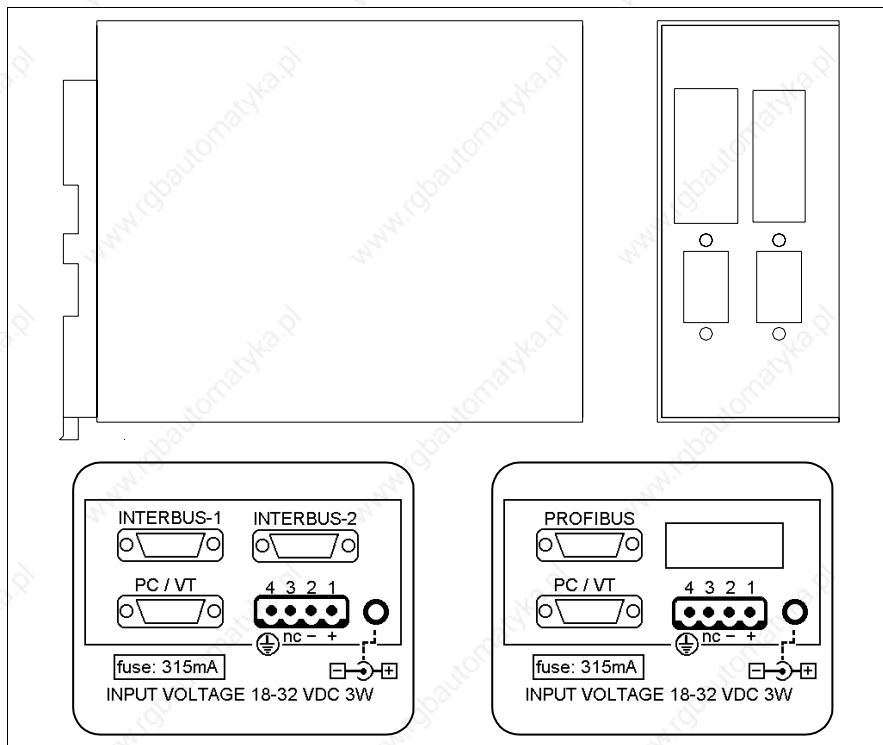

⚠ The casing is the same both for the Interbus-S and the Profibus-DP networks; a label is attached to indicate which network is contained.

The table below lists the principal technical characteristics of the product under discussion.

Technical data	
Power supply	24Vdc (18..32Vdc)
Power absorbed at 24Vdc	3W
Protection level	--
Operating temperature	0..50°C
Storage and transportation temperature	-20..+60°C
Humidity (non-condensing)	85%
Weight	800gr
Dimensions	
External W x H x D [mm]	48,8 x 107,2 x 139,4
Cut-out W x H [mm]	--

The device incorporates the Interbus-S and Profibus-DP network cards (see Page 33-19 and Page 33-21 for information); it also contains a power supply card with a communication port composed of a 9 pin male D-Sub connector for connecting a PC or VT in RS232 (see “Chapter 30 -> PC/VT serial port”).

The external power supply for this card can also come via a 4-pin connector or a jack.

! See “Chapter 2 -> Power Supply“ for connecting the power supply.

The connection to the VT uses the following cables.

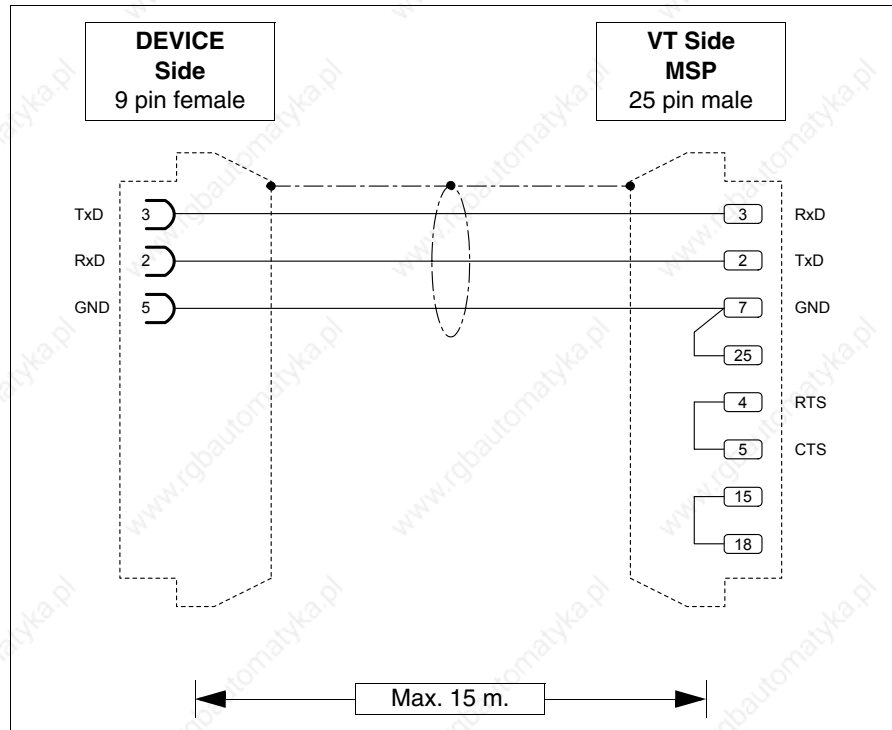

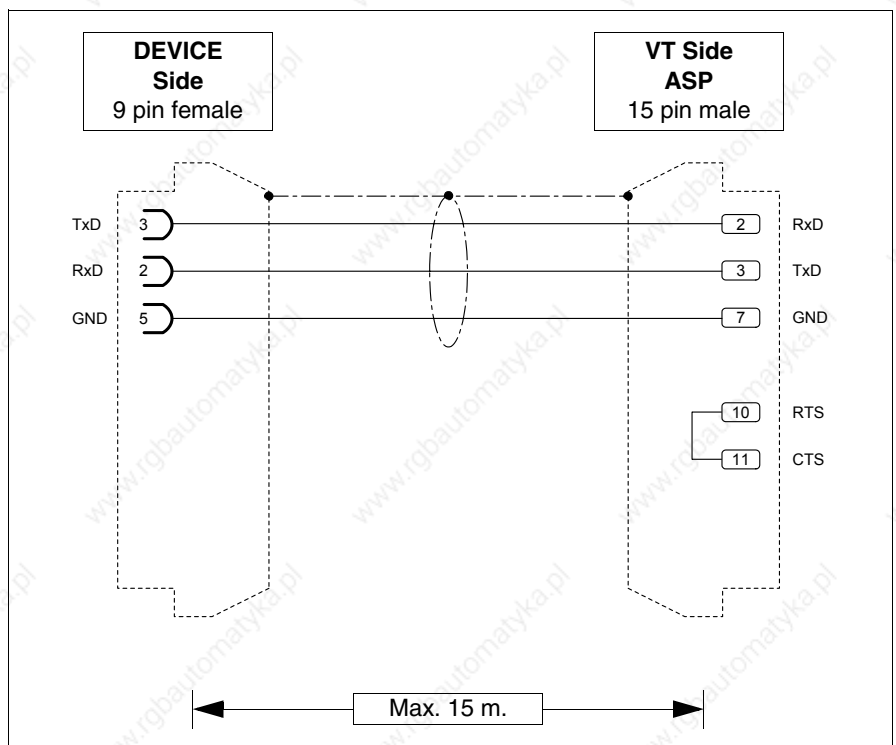
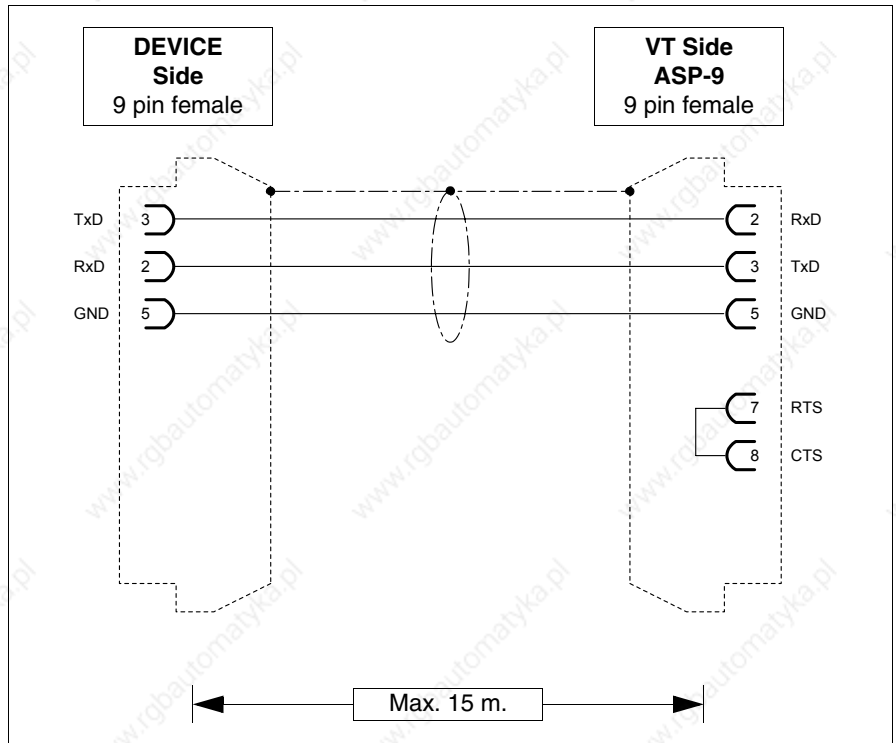

The connection to the PC uses the following cables.

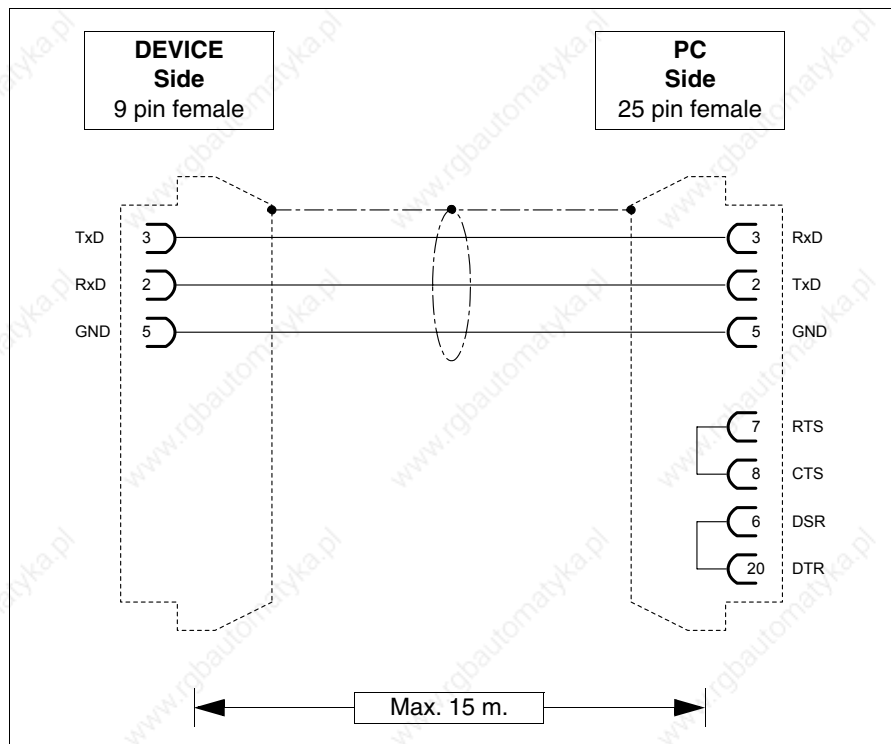
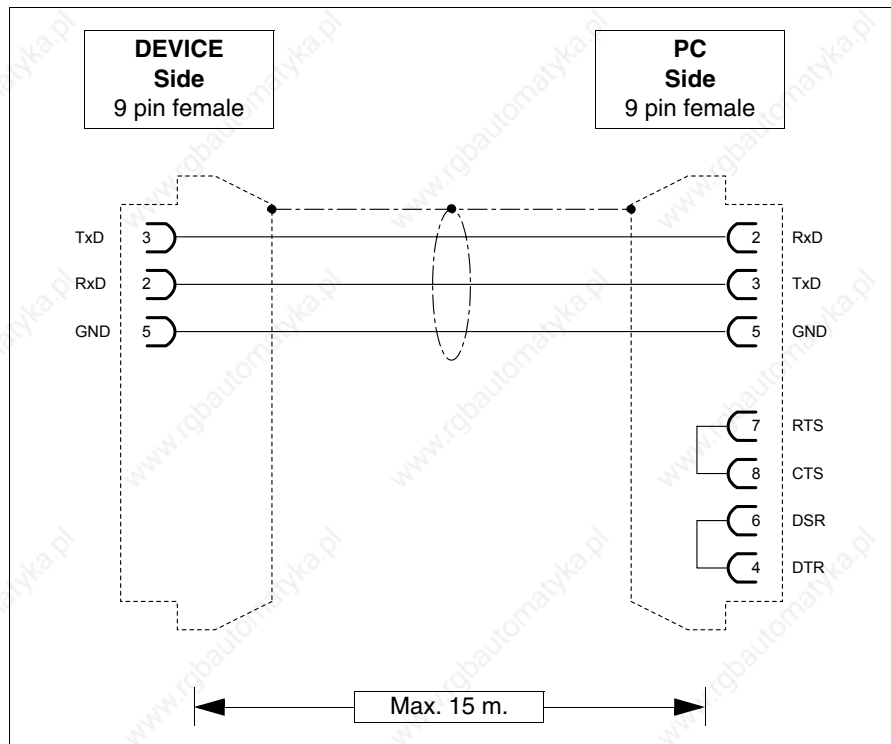

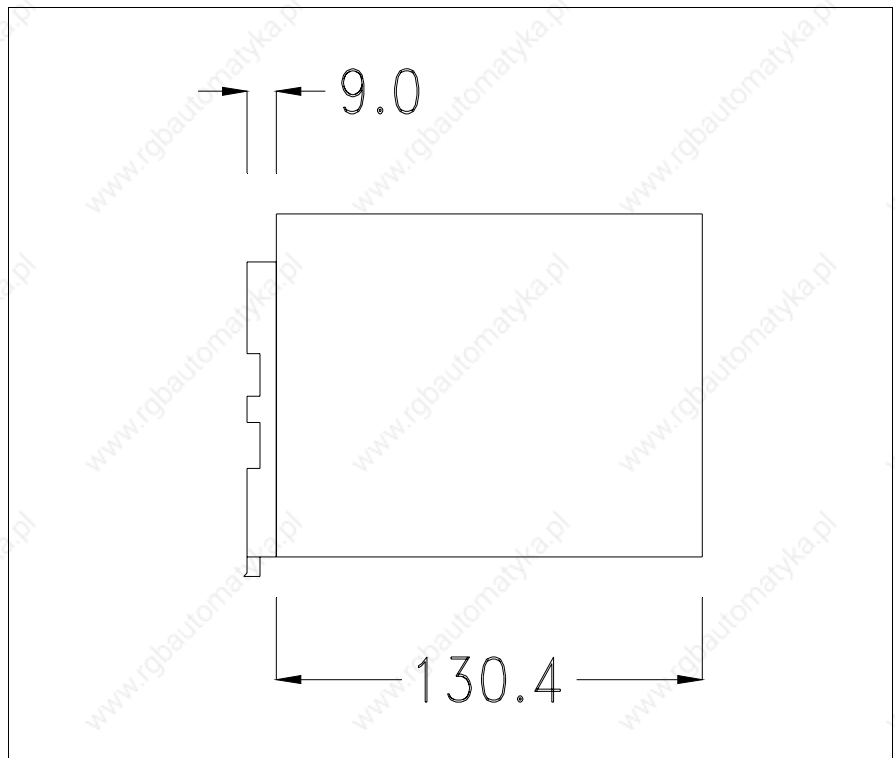
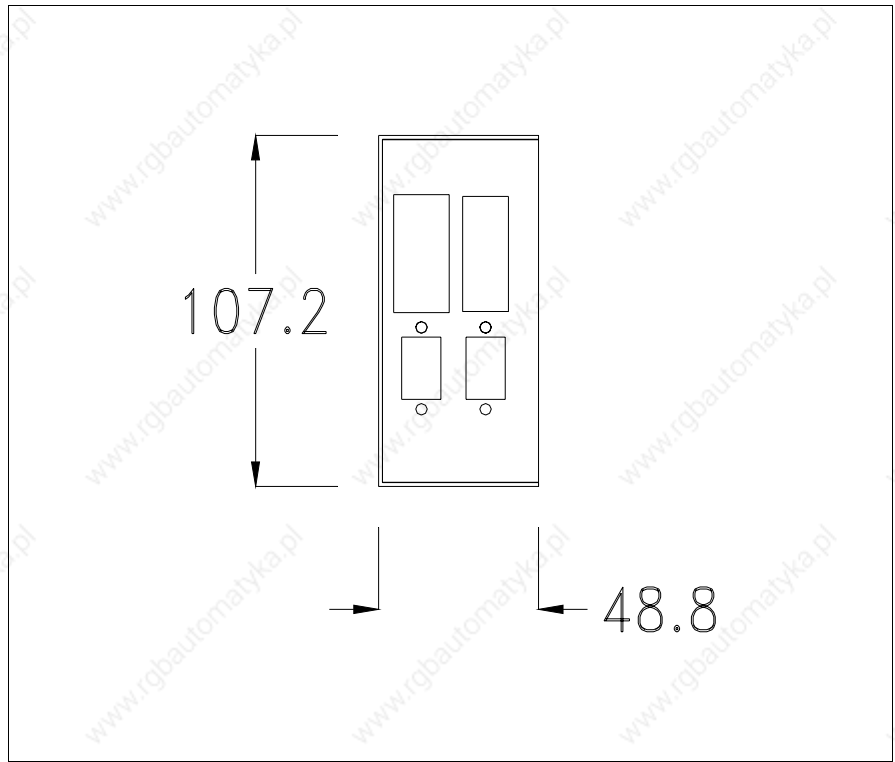
Dimensions:

Securing the DIN rail mounting plate:

The device is supplied with a special molded plate for attaching to the DIN rail. The following figure shows how to fit the plate to the device.

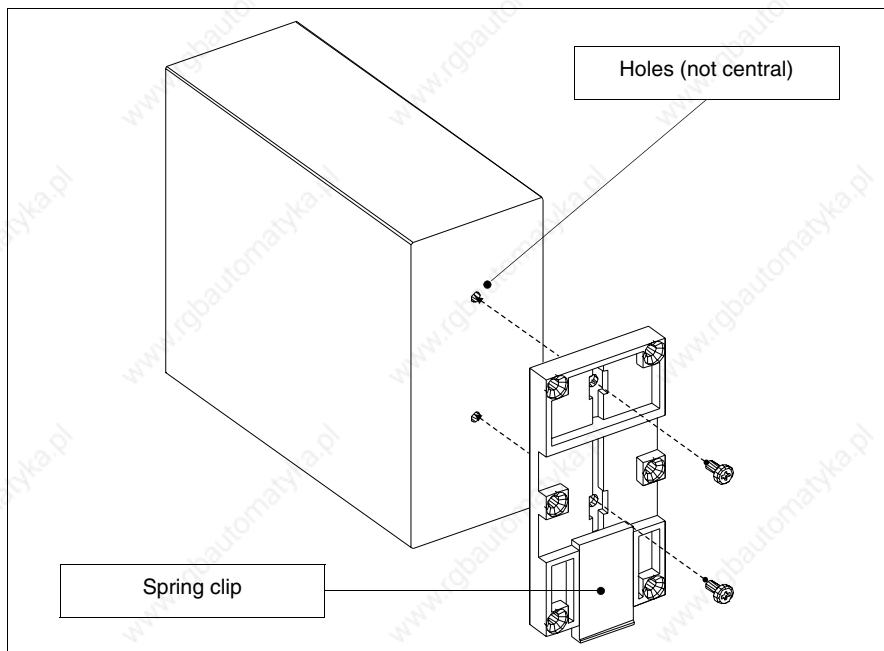

- Locate the two fixing holes.
- Position the device such that the holes are decentered towards the top
- Secure the mounting plate with the screws supplied keeping the spring-clip down.

Attaching the device to the DIN rail:

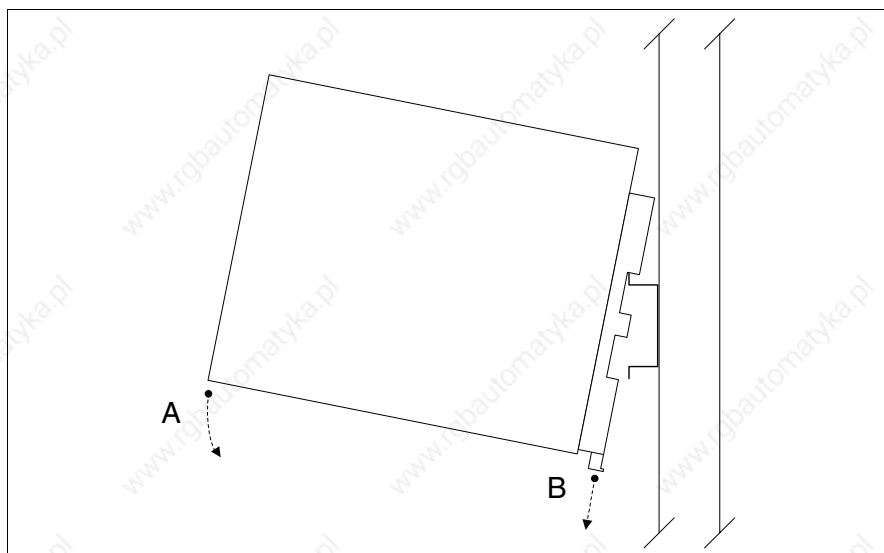

- Once the mounting plate has been attached,
- Hook the upper part of the plate onto the DIN rail.
- Press the device in the direction indicated. (Arrow A)
- To make it easier to hook on, pull the spring-clip in the direction indicated. (Arrow B)

Fixing the device to the back cover:

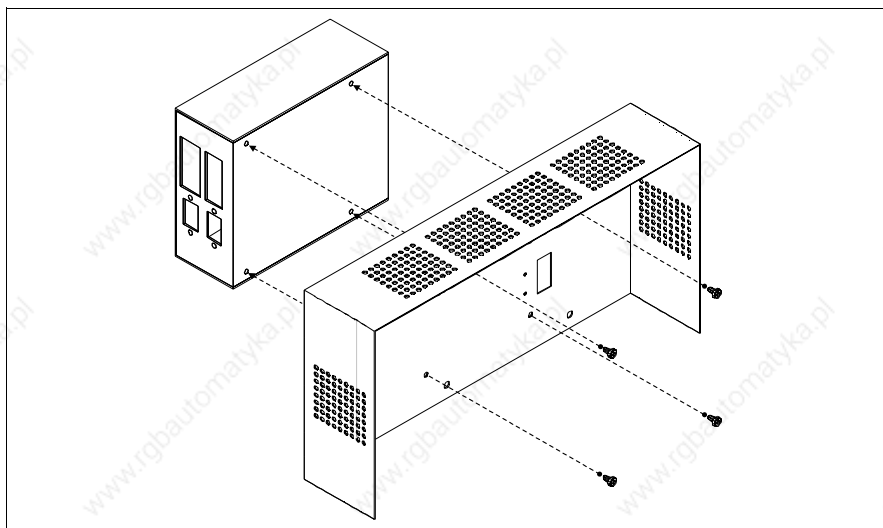
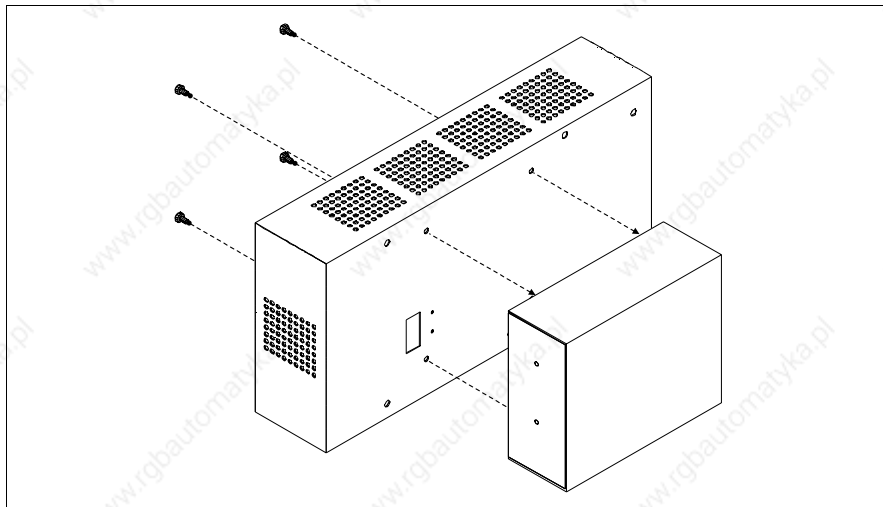

- Check that the VT power supply is not connected.
- Remove the back cover.
- Attach the device as illustrated above using the appropriate screws supplied and making sure the direction is correct.
- Replace the back cover.
- Reconnect the VT power supply.

! The above illustrations refer to VT320W; the procedure is basically the same for all those products that can be fixed to the back cover (see Page 33-2).

Connection card for PC-NET

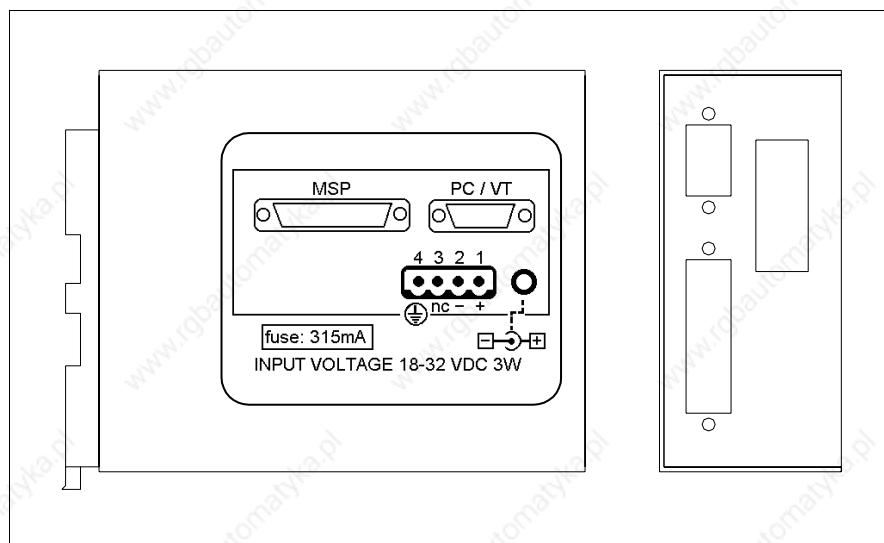

The table below lists the principal technical characteristics of the product under discussion.

Technical data	
Power supply	24Vdc (18..32Vdc)
Power absorbed at 24Vdc	3W
Protection level	--
Operating temperature	0..50°C
Storage and transportation temperature	-20..+60°C
Humidity (non-condensing)	85%
Weight	800gr
User memory	
Project [Bytes]	16K
Definible groups	255*
Objects per group	255*
Simultaneously active groups	10
Dimensions	
External W x H x D [mm]	48,8 x 107,2 x 139,4
Cut-out W x H [mm]	--

The adapter indicated above makes it possible to connect a device to a PC or several VTs to a PC using the ESANET network. The adapter is equipped with a D-Sub 25 pin female MSP connector (for details see "Chapter 30 -> MSP serial port") and a D-Sub 9 pin male PC/VT connector (for details see Page 33-27). The external power supply for this card can also come via a 4-pin connector or a jack.

! See "Chapter 2 -> Power Supply" for connecting the power supply.

The connection to the PC uses the following cables.

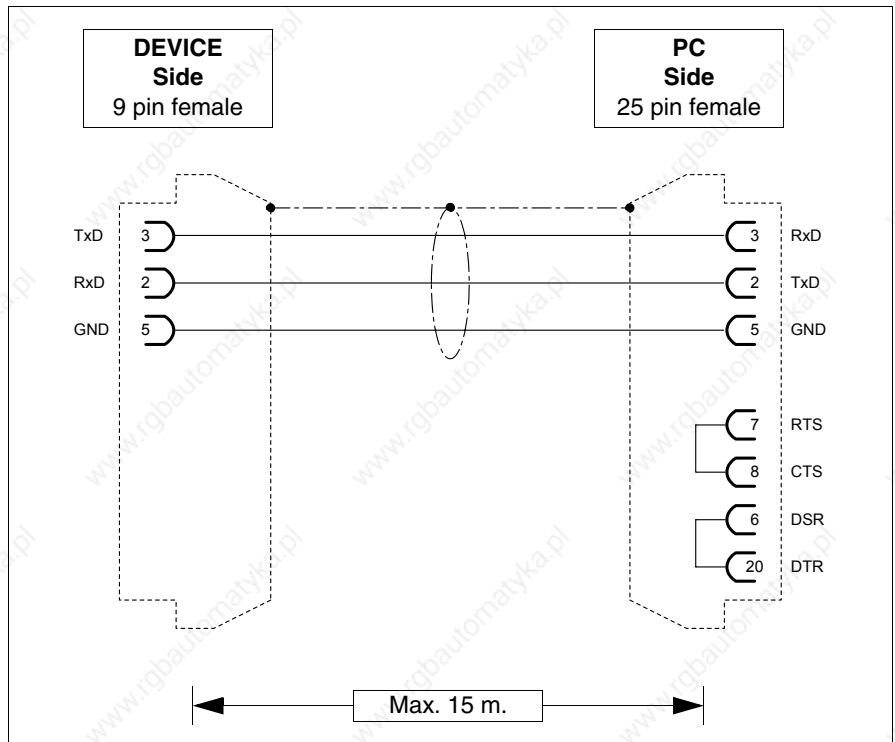
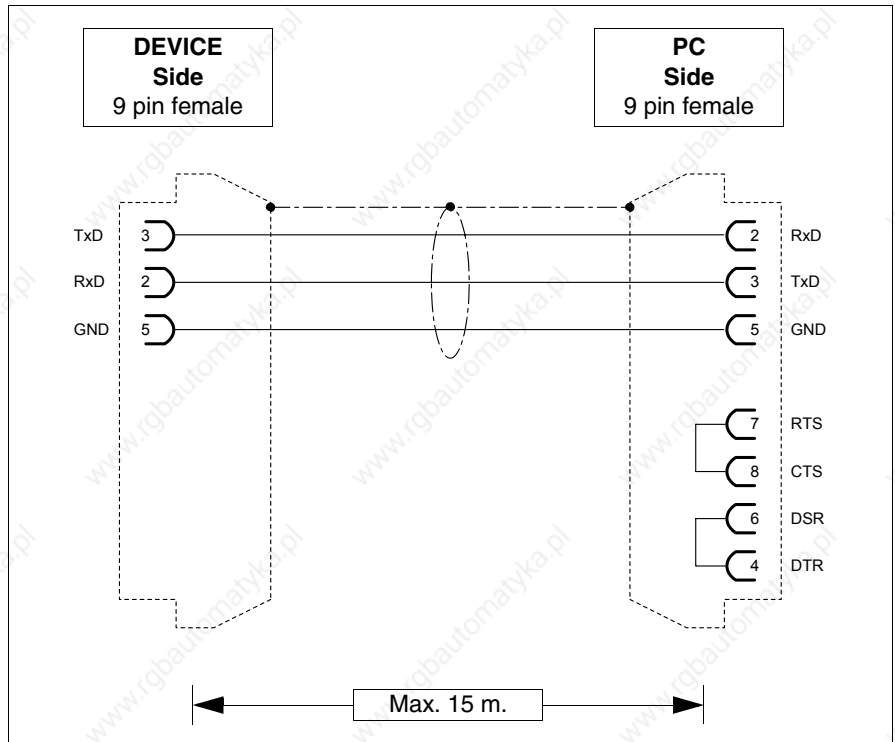

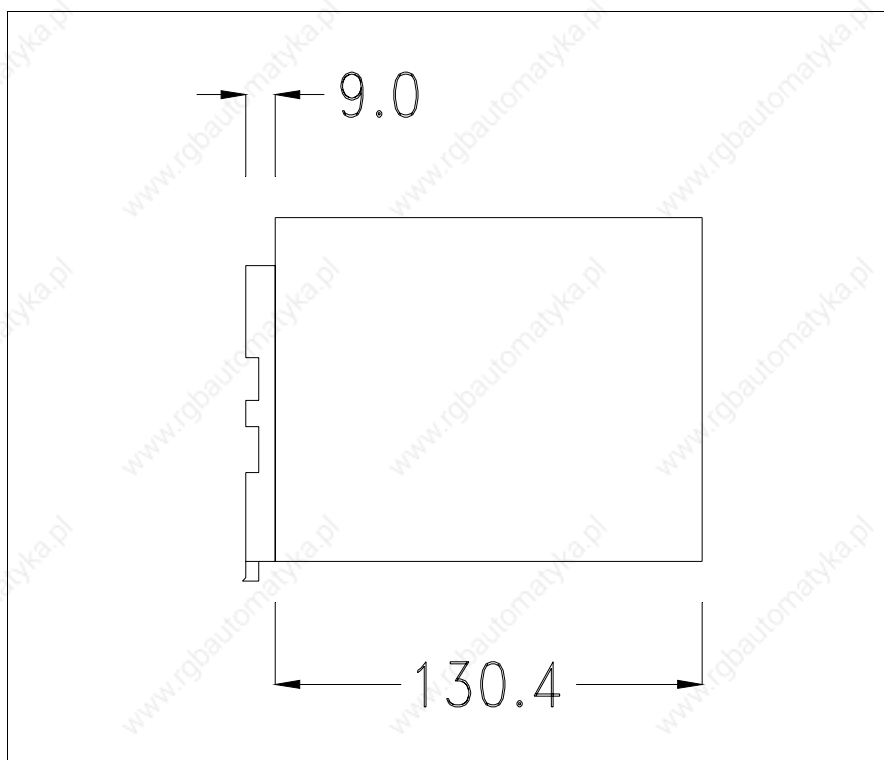
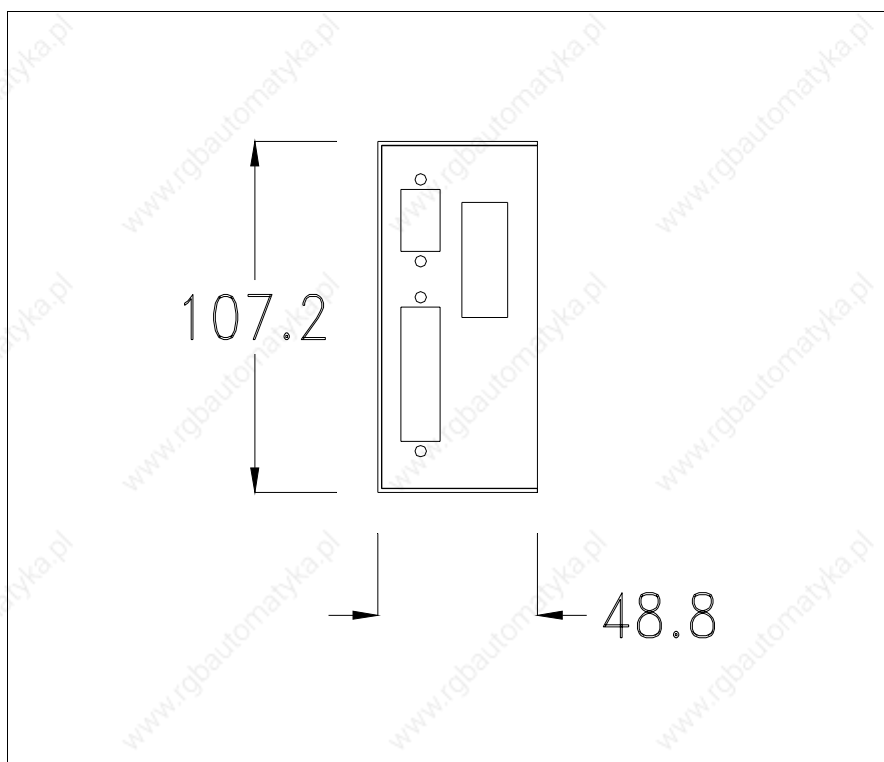
Dimensions:

Fixing the device:

Various ways of fixing the device are possible. For details see Page 33-32, Page 33-32 and Page 33-33.

Adapter for external CAN network

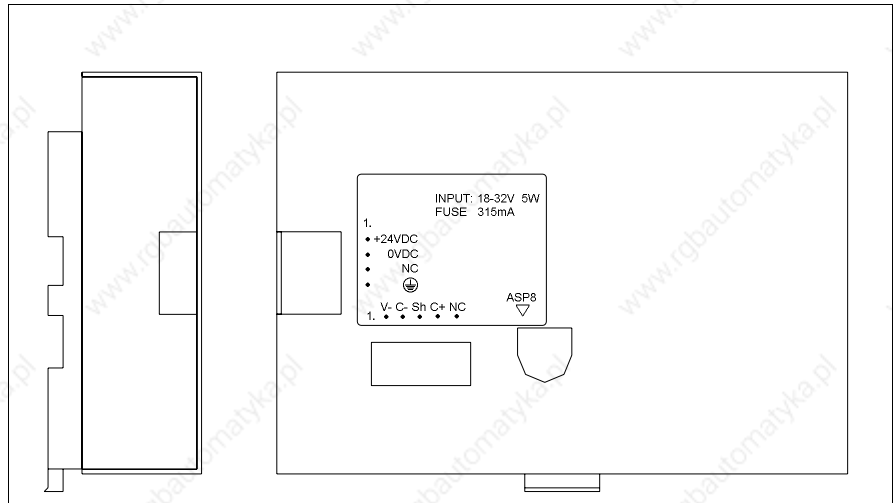

The table below lists the principal technical characteristics of the product under discussion.

Technical data	
Power supply	24Vdc (18..32Vdc)
Power absorbed at 24Vdc	5W
Protection level	--
Operating temperature	0..50°C
Storage and transportation temperature	-20..+60°C
Humidity (non-condensing)	85%
Weight	580gr
Dimensions	
External W x H x D [mm]	152,4 x 107,2 x 31,7
Cut-out W x H [mm]	--

The above adapter makes it possible to connect several terminals in a CAN network. For further details regarding the connect in network of the terminals see "Chapter 34 -> Network connection". The adapter is equipped with a Minidin 8 pin female ASP-8 connector (for details see "Chapter 30 -> ASP-8 serial port") and a disconnectable 5 pin female terminal block for connecting the CAN network (optoisolated interface - see "Chapter 30 -> CAN port").



See "Chapter 2 -> Power Supply" for connecting the power supply.

The connection to the VT uses the following cables.

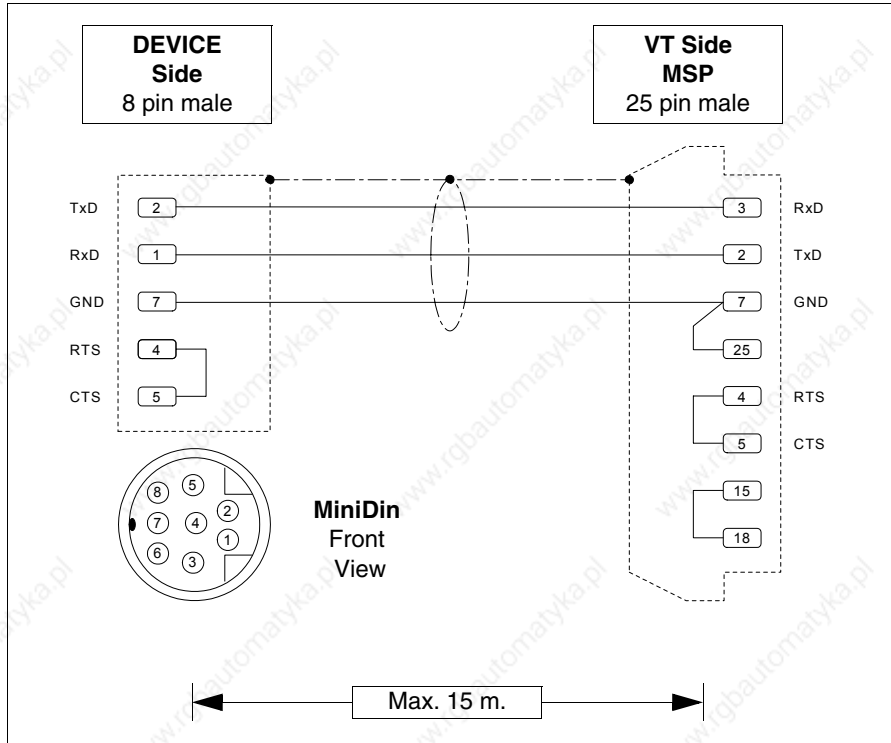

Dimensions:

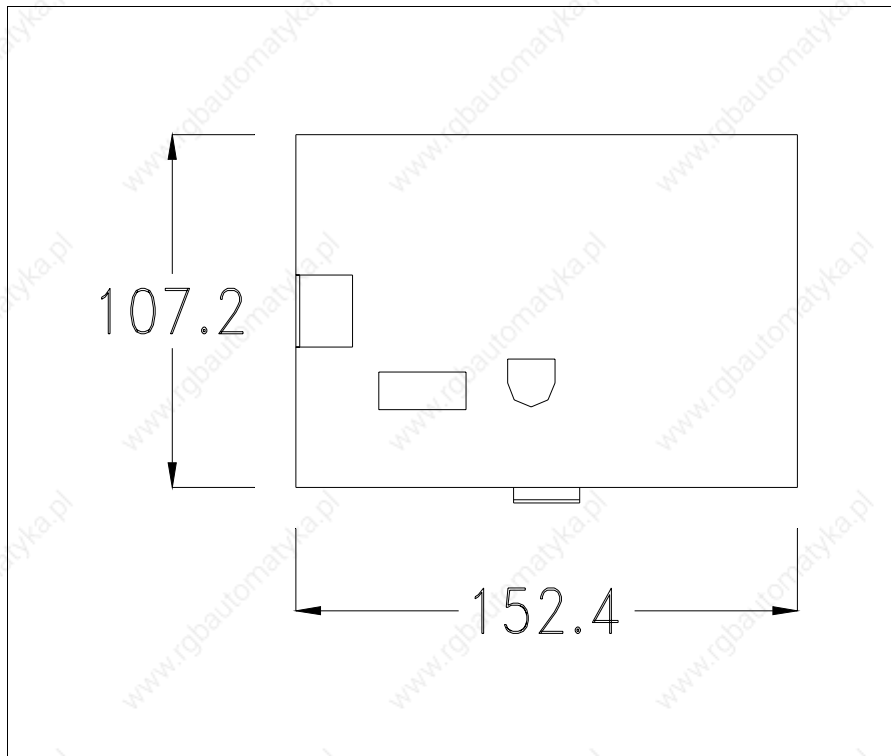

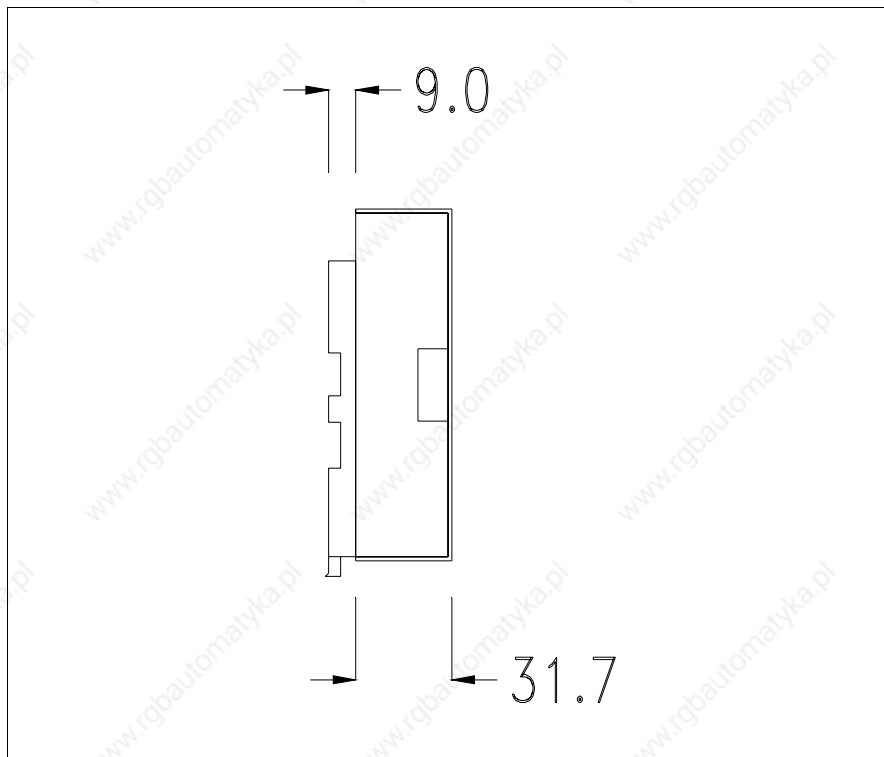

Termination of CAN line:

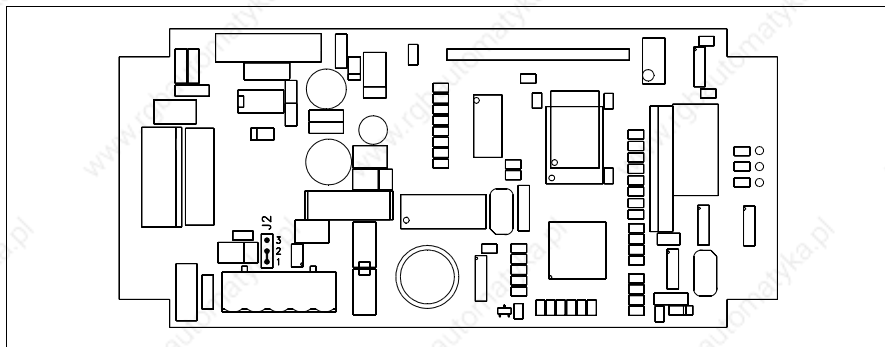

The device in question integrates the termination resistances of the serial line (typically 120 ohms) which can be inserted by means of a jumper (pre-set on 1-2, line not terminated). To activate the termination:

- Make sure the device is not connected to the power supply.
- Remove the cover.
- Identify the jumper unit J2.
- Position the jumper between pins 2 and 3 (line terminated).
- Replace the back cover.
- Reconnect the power supply.

Securing the DIN rail mounting plate:

The device is supplied with a special molded plate for attaching to the DIN rail. The following figure shows how to fit the plate to the device.

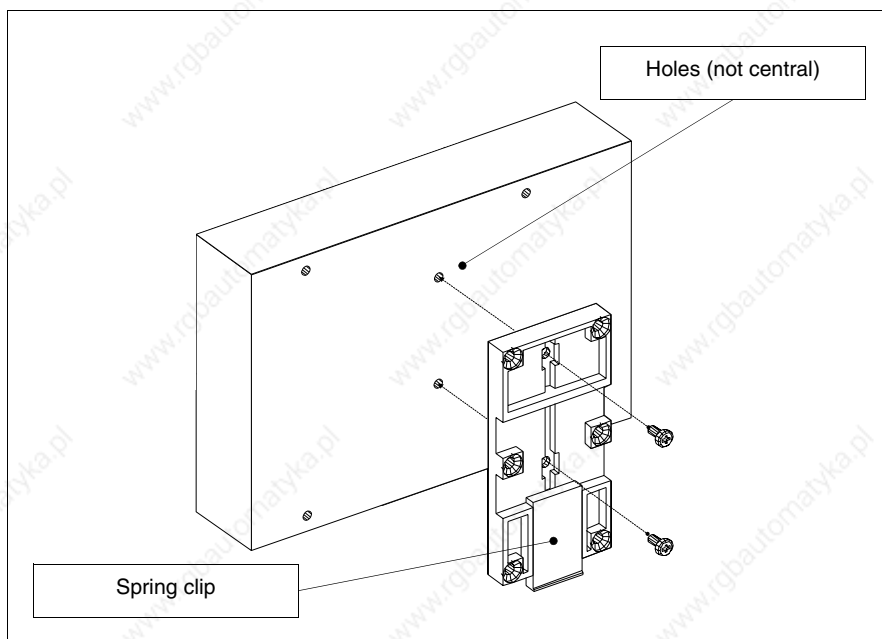

- Locate the two fixing holes.
- Position the device such that the holes are decentered towards the top
- Secure the mounting plate with the screws supplied keeping the spring-clip down.

Attaching the device to the DIN rail:

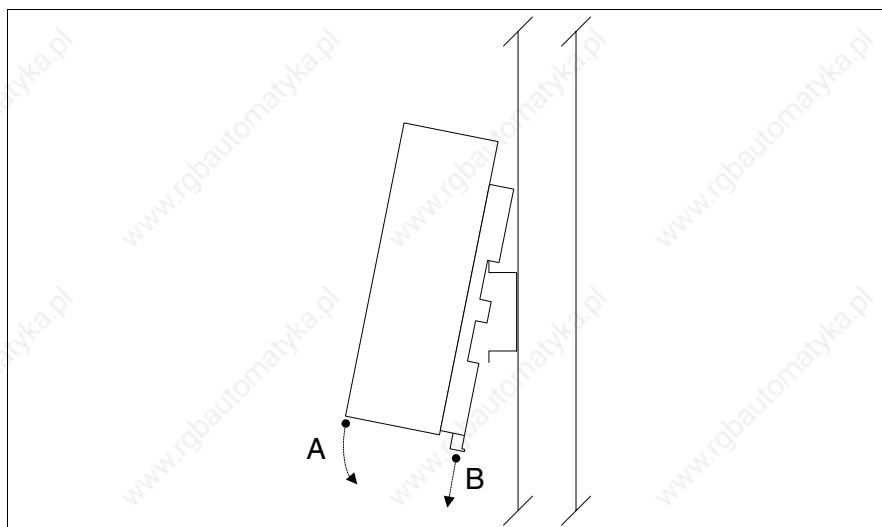

- Once the mounting plate has been attached,
- Hook the upper part of the plate onto the DIN rail.
- Press the device in the direction indicated. (Arrow A)
- To make it easier to hook on, pull the spring-clip in the direction indicated. (Arrow B)

Fixing the device to the back cover:

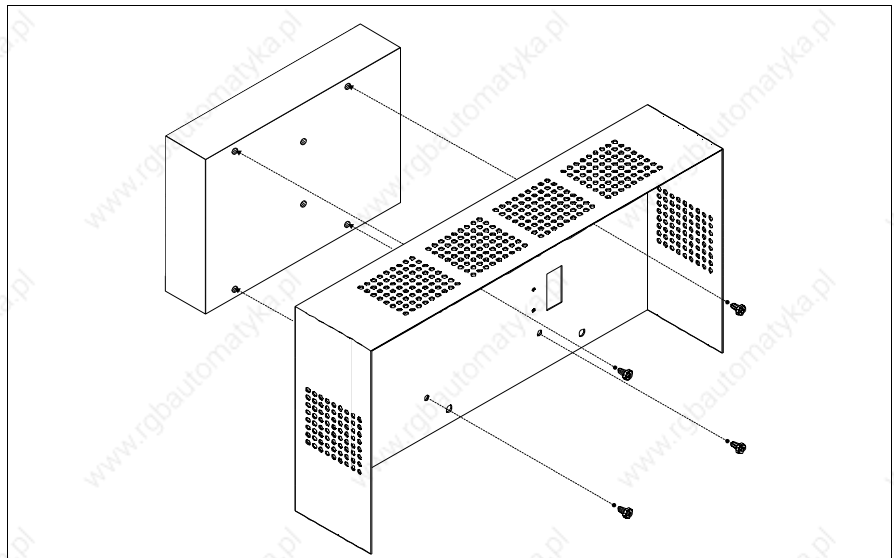
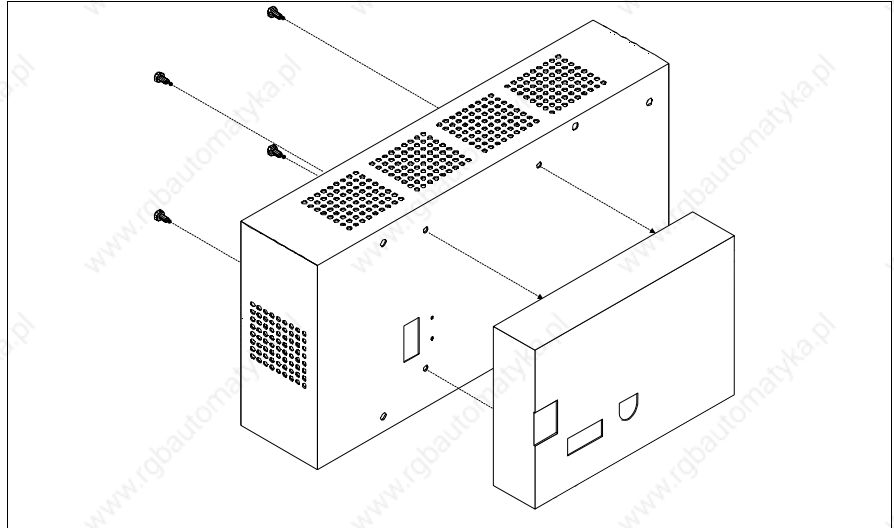

- Check that the VT power supply is not connected.
- Remove the back cover.
- Attach the device as illustrated above using the appropriate screws supplied and making sure the direction is correct.
- Replace the back cover.
- Reconnect the VT power supply.

! The above illustrations refer to VT320W; the procedure is basically the same for all those products that can be fixed to the back cover (see Page 33-2).

20 key serial keyboard

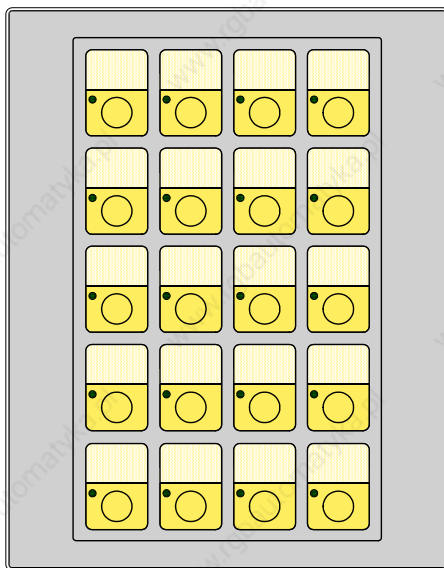

The following table lists the principal technical characteristics of the product in question.

Keyboard	
Non-customizable function keys	--
Customizable function keys	20
Function key LEDs	20
Alphanumeric keys	--
Operational keys	--
Operational key LEDs	--
Diagnostic LEDs	--
Technical data	
Power supply	--
Power absorbed at 24Vdc	--
Protection level	IP65 (front-end)
Operating temperature	0..50°C
Storage and transportation temperature	-20..+60°C
Humidity (non-condensing)	85%
Weight	550gr
Dimensions	
External W x H x D [mm]	148 x188 x 27
Cut-out W x H [mm]	114 x 174

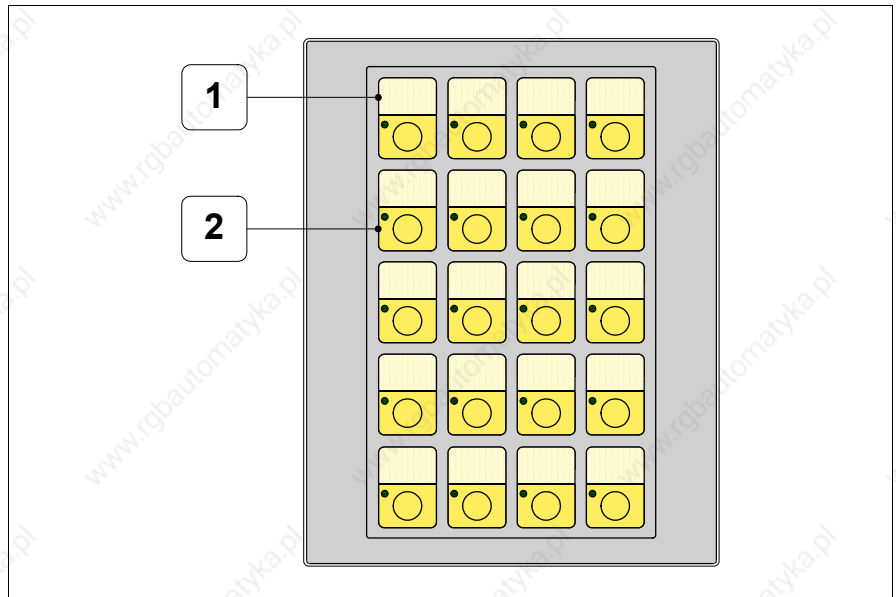
Front view:

Key	Function
1	Labels for customizing F-keys
2	F-keys

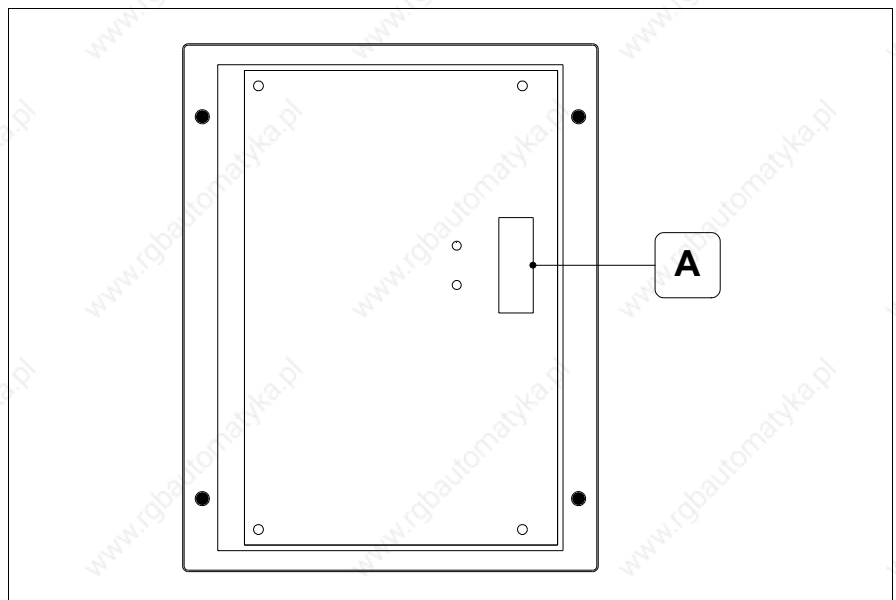
Rear view:

Position	Function
A	Point for connecting to VT by means of a shielded flat cable (Max. length 300mm)

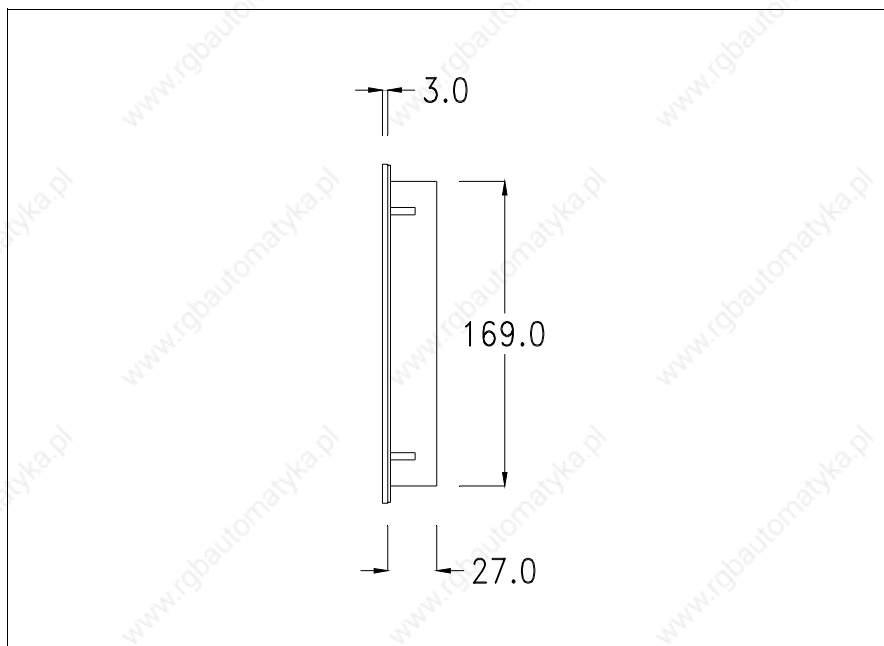
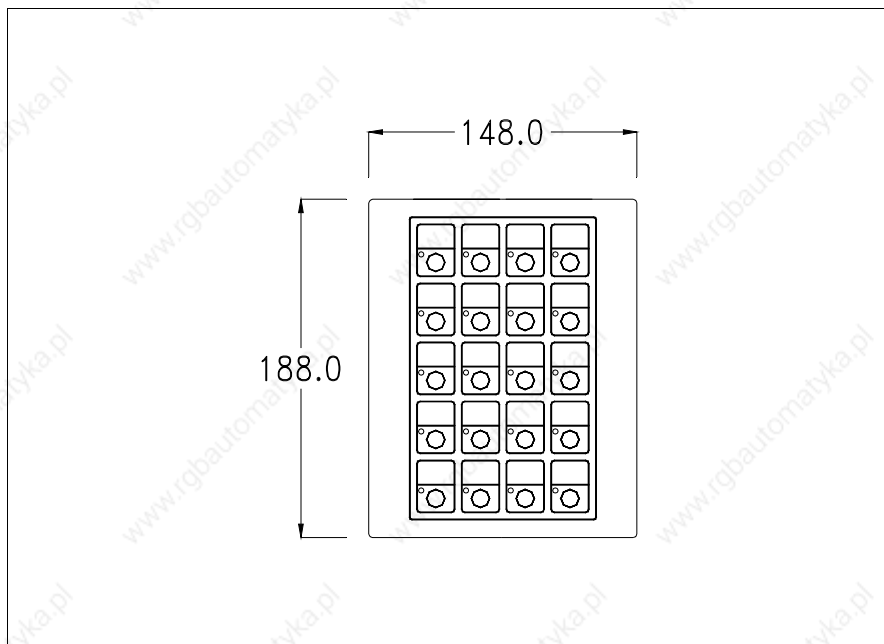
Dimensions and Cut-out:

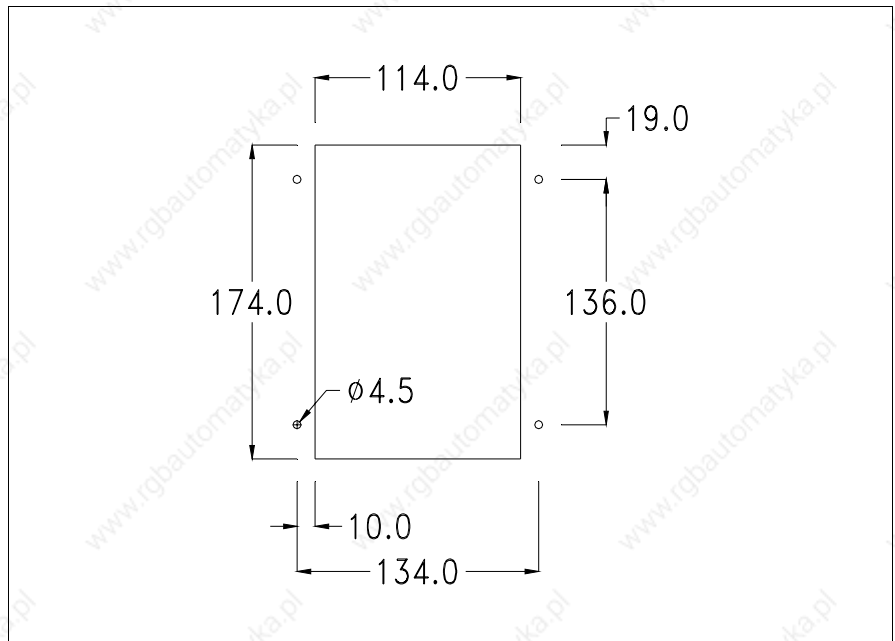

To fix the sealing gasket and secure the VT to the container see “Chapter 29 -> Mounting the terminal within the container”.

Connection with cable:

The serial keyboard accessory is connected directly to the auxiliary port (see “Chapter 5 -> Standard series rear view”) of VT150W by means of a shielded flat cable, no external power being necessary. The maximum length of the cable is 300 mm.

The explanation of the connection method applies to all terminals with this accessory (See Page 33-2).

! Care must be exercised in making these connections: using the accessories provided and following the wiring instructions set out below.

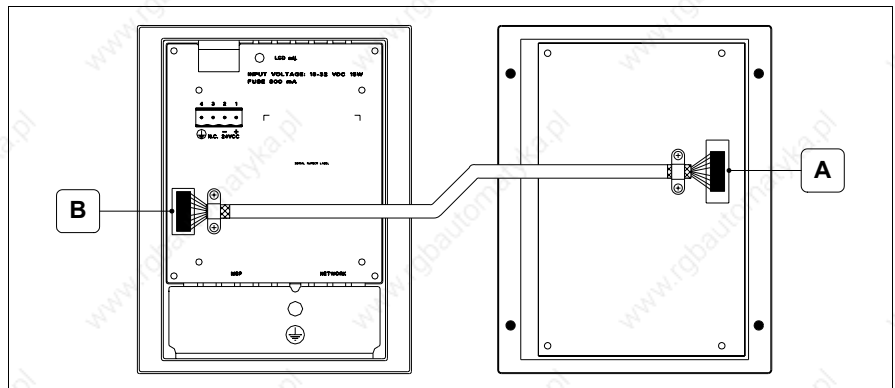

When supplied the cable will already be fixed to the keyboard at point A, leaving point B to be connected at the other end.

Procedure for connecting to point B:

- Check that the power supply is not connected.
- Take off the back cover of the VT (see “Chapter 5 -> Standard series rear view”).
- Open the pre-cut for mounting the connector on the cover by pressing in the metal plate and remove it (see “Chapter 5 -> Standard series rear view” point B).
- Replace the back cover of the VT.
- Insert the cable connector into the VT (see “Chapter 5 -> Standard series rear view” point B).
- Secure the cable to the VT by means of the collar and screws provided.

⚠ It is essential that the metal collar pressing on the shield of the connecting cable make direct contact with the metal cover of the VT. If this does not happen, there could be problems due to disturbances deriving from the work environment.

- Reconnect the power supply to the VT.

**Blank
keyboard**

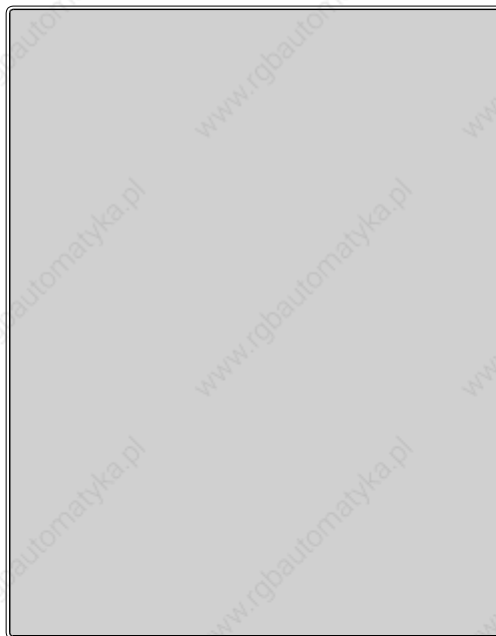

The following table lists the principal technical characteristics of the product in question.

Technical data	
Power supply	--
Power absorbed at 24Vdc	--
Protection level	IP65 (front-end)
Operating temperature	0..50°C
Storage and transportation temperature	-20..+60°C
Humidity (non-condensing)	85%
Weight	100gr
Dimensions	
External W x H x D [mm]	148 x188
Cut-out W x H [mm]	114 x 174

Front view:

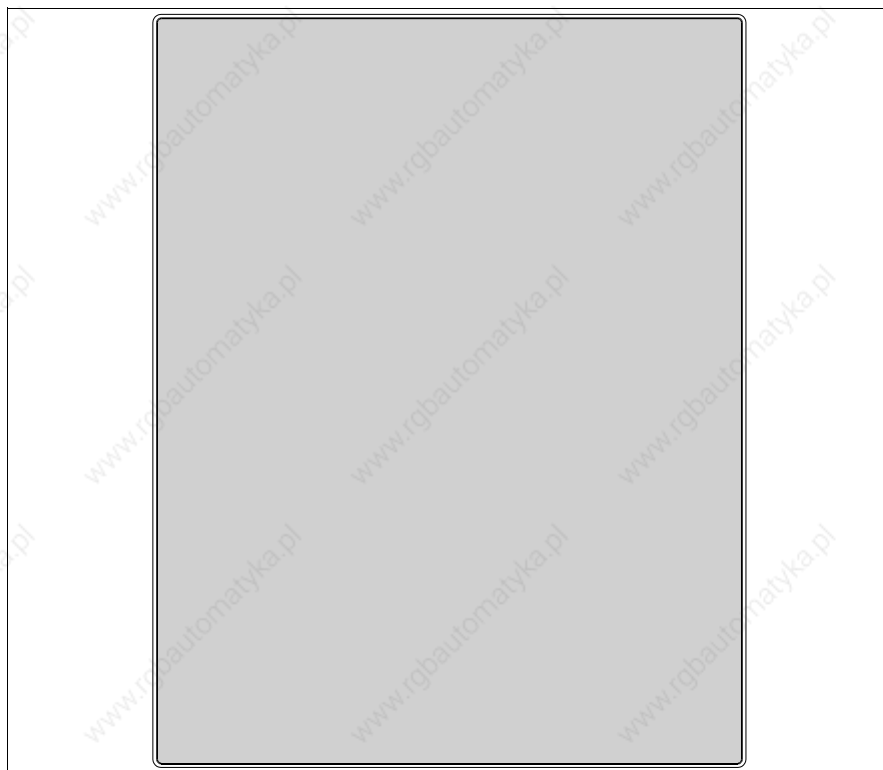

The blank keyboard has no keys.

This accessory allows the user to fit and wire buttons. Any kind of key-pad can be used.

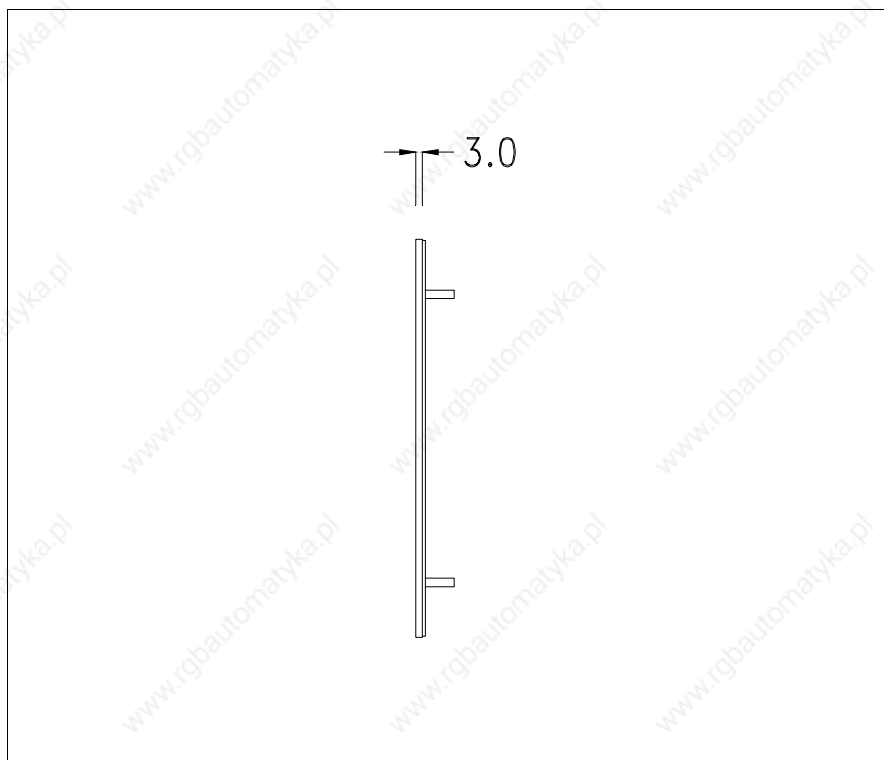
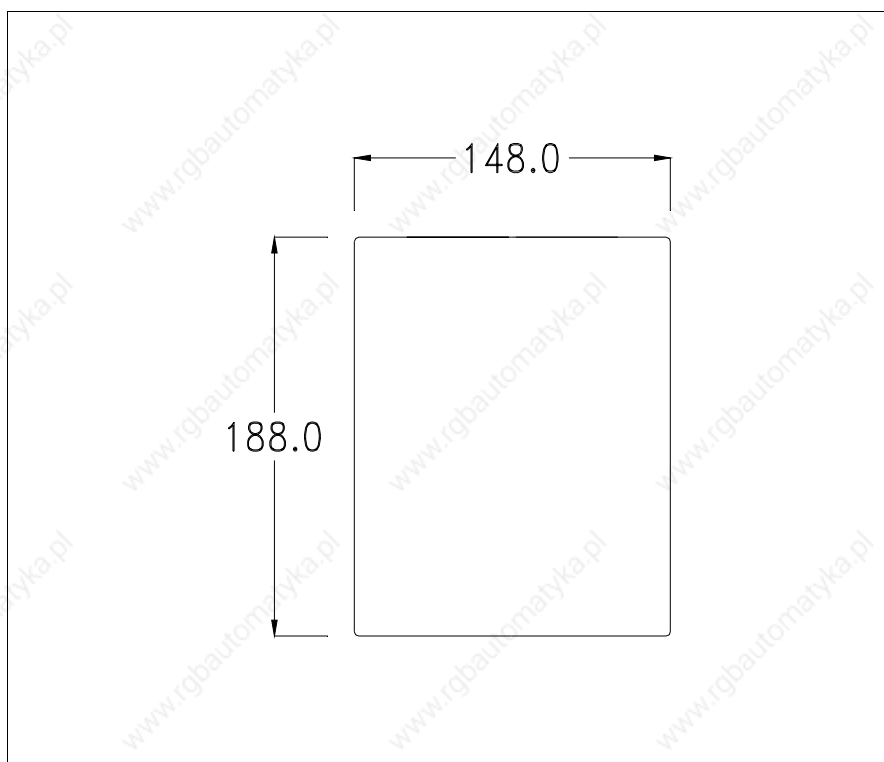
Dimensions and Cut-out:

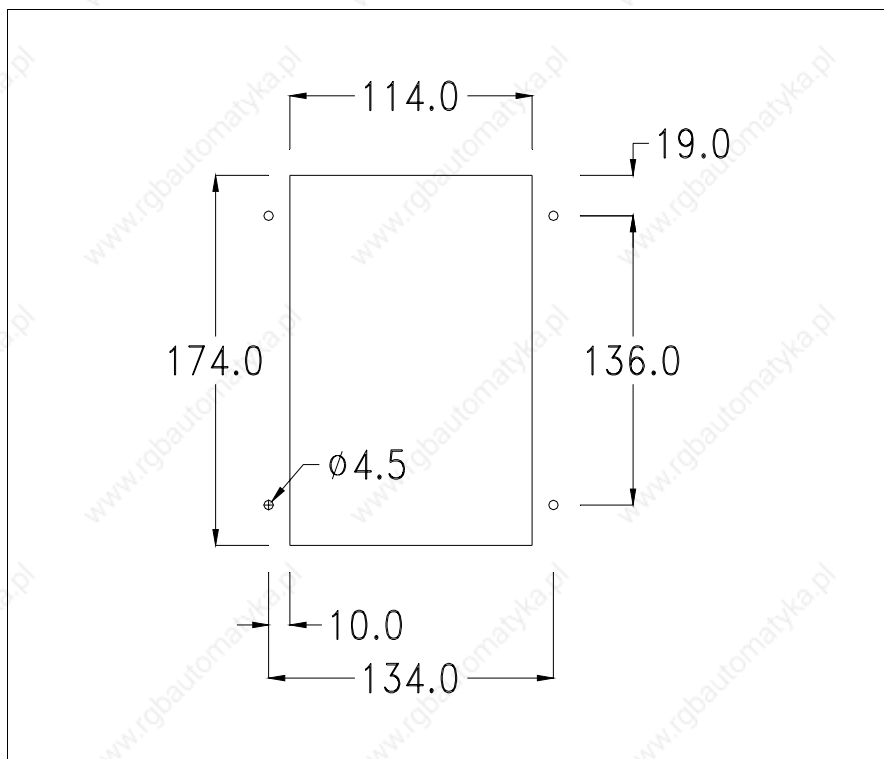

To fix the sealing gasket and secure the VT to the container see “Chapter 29
-> Mounting the terminal within the container“.

Chapter 34 Network connection

Contents	Page
Profibus-DP	34-3
Profibus-DP (ESA profile): VT operation	34-4
Profibus-DP (ESA profile): Configuration software	34-4
Profibus-DP (ESA profile): Logical diagram	34-5
Profibus-DP (ESA profile): Physical diagram	34-6
Profibus-DP (Standard): VT operation	34-6
Profibus-DP (Standard): Configuration software	34-6
Profibus-DP (Standard): Logical diagram	34-7
Profibus-DP (Standard): Physical diagram	34-7
Profibus-DP: Connection	34-8
Interbus-S	34-10
Interbus-S: VT operation	34-10
Interbus-S: Configuration software	34-10
Interbus-S: Logical diagram	34-11
Interbus-S: Physical diagram	34-12
Interbus-S: Connection	34-12
ESA-Net	34-14
ESA-Net: VT operation	34-14
ESA-Net: Connecting the terminals	34-16
ESA-Net: Configuration software	34-20
ETHERNET	34-21
ETHERNET: VT operation	34-21
ETHERNET: Configuration software	34-21
ETHERNET: Connections	34-22
ETHERNET: Checking the connection	34-23
CAN	34-24

This chapter consists of 28 pages.

Contents	Page
CAN: VT functioning in CAN network	34-24
CAN: Configuration software	34-25
CAN: Connection	34-25

This chapter consists of 28 pages.

VT terminals can be connected, using the appropriate optional cards, integrated or external, in a network with other devices. The networks available are Profibus-DP, Interbus-S, ESA-Net, Ethernet and CAN.

Profibus-DP

A VT equipped with a network card can be connected within a Profibus-DP network as a slave (a passive station that can only transmit data after receiving a request from an active station). The PLCs and the network configurator, on the other hand, are masters (active network stations able to transmit information without receiving a request).

VT terminals have two ways of exchanging data with the network master: one called ESA Profile and the other known as Standard Profile. In practice the difference lies in the size of the I/O area: with ESA Profile the I/O area is 32bytes + 32bytes and is handled by a FB (Function Block) (not available on all devices) that has the task of allowing the VT read and write access to all the data areas of the device; the Standard profile can use an I/O area of up to 128bytes + 128bytes, corresponding to the maximum data area dimensions visible to the VT.

A network can contain more than one master and more than one slave, while there can only be one configurator.

The slave address of the VT must coincide with the network configuration.

It can be set using VTWIN if using a VT with an integrated network card, or by means of a Dip-Switch if using a VT with a supplementary network card.

The VT can work at a maximum speed of 12 Mbaud and it automatically assumes the speed of the network as determined by the network master.

Table 34.1: Setting of VT network address.

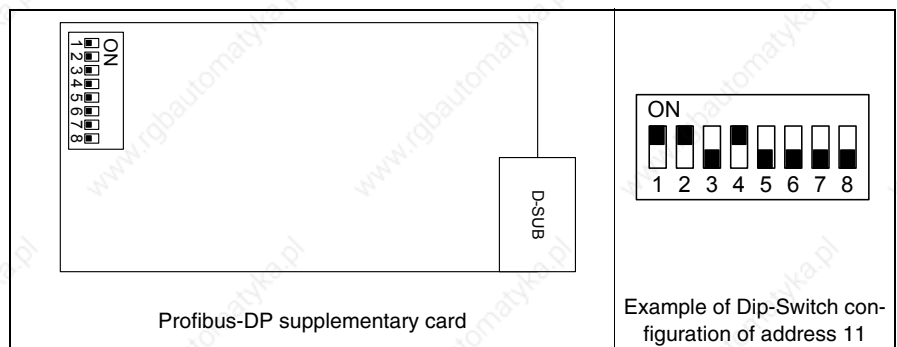

Table 34.2: Meaning of the Dip-Switches

Dip-Switch	Binary value	Dip-Switch	Binary value
1	1	5	16
2	2	6	32
3	4	7	64
4	8	8	128

Profibus-DP (ESA profile): VT operation

The slave VTs are seen generally as dedicated areas of memory in the PLC's I/O area, or alternatively in other data areas made accessible by the configurator of the master, which are used by the PLC and VT to exchange data. The size of the I/O area of each VT participating in the network is defined by the user with a 4 to 16 word limit (8-32byte).

Note that the greater are the dimensions of the I/O area the faster the handling of the information, though this also means a greater effort on the part of the CPU of the PLC and thus an increase in the scanning time.

Profibus-DP (ESA profile): Configuration software

There are 4 types of software that play a part in configuring the network:

- VTWIN
- FB
- File with extension GSD
- Configuration software for network master

These types of software require parameters that coincide.

VTWIN:

The parameters that must be set in the VTWIN project of every terminal connected in the network are:

- Size (in words of the I/O area)
- Timeout for testing the connection between the VT and PLC.
- Address of terminal.

FB:

This is a program supplied by ESA to be loaded into the PLC. This program is used to check the network parameters set and the data exchange. It varies according to the type of PLC (make and model). Besides the parameters which we have just seen in VTWIN, the incoming FB requires other information related to the PLC that will be hosting it.

The necessary user information is contained on the disk "VT-PROFIBUS Installation SW" supplied along with the Profibus-DP option.

File with extension GSD (dedicated to ESA profile):

This file is supplied by ESA; it allows the configuration software of the network master to recognize the VT.

Network master configuration software:

This software is supplied by the producer of the network master.

Profibus-DP (ESA profile): Logical diagram

Below is a logical diagram of the VT <-> Profibus-DP (ESA profile) connections. The diagram indicates how and at what level the FBs supplied by ESA interact with the system. The FB INIT takes care of the initial configuration of the system (input and output areas, etc.), while the FB DRIVER takes care of the data exchange between the PLC memory and the VTs, and viceversa. The number of FB calls within the PLC must be equal to the number of VTs connected in the system.

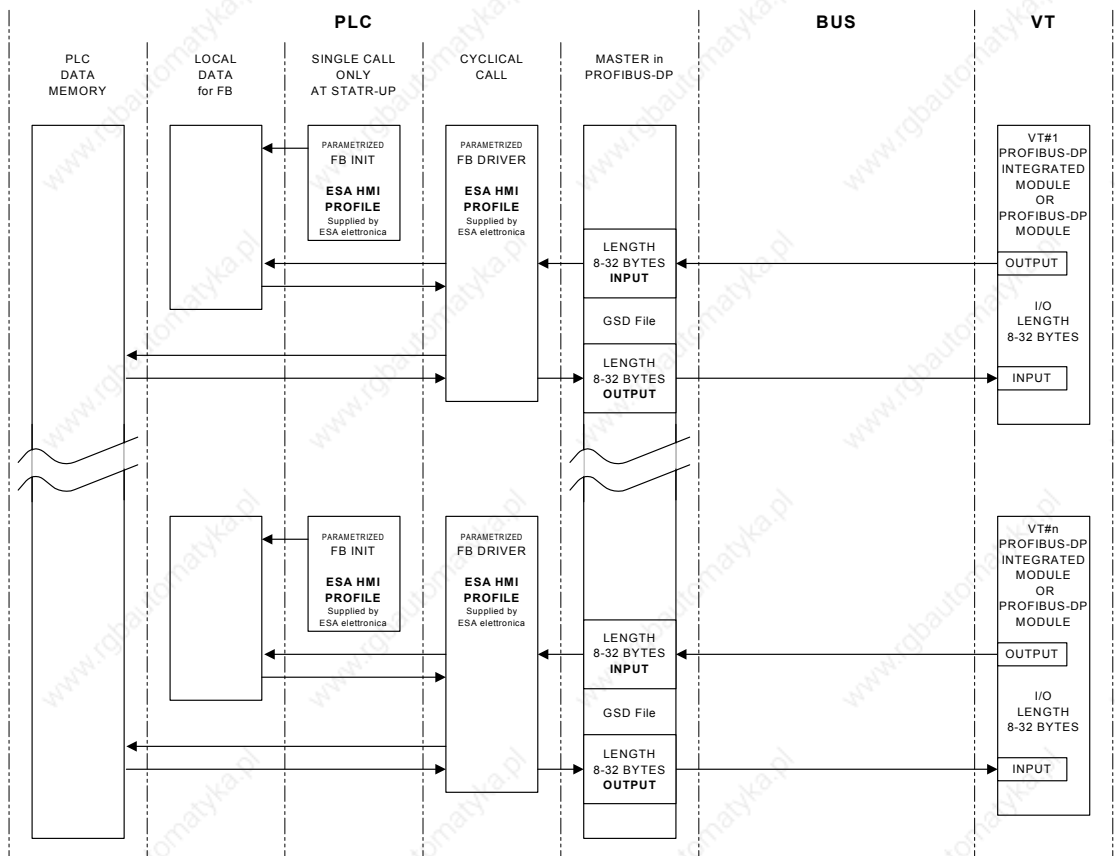

**Profibus-DP
(ESA profile):
Physical
diagram**

The following figure represents the physical form of the VT <-> Profibus-DP connection.

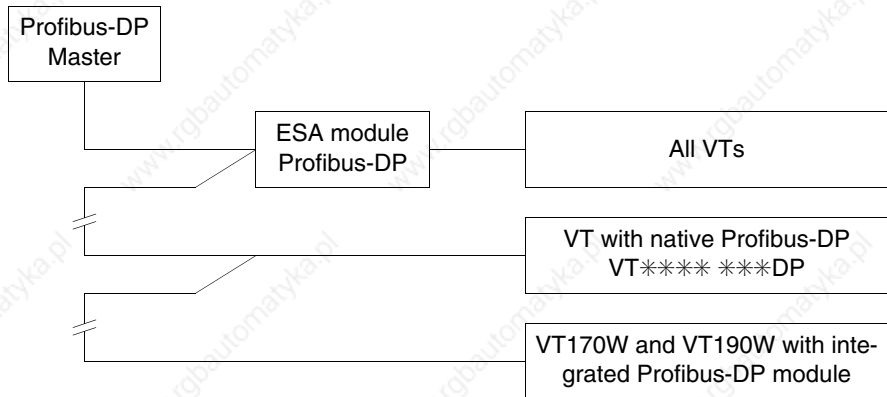

**Profibus-DP
(Standard): VT
operation**

The slave VTs are seen generally as dedicated areas of memory in the PLC's I/O area, or alternatively in other data areas made accessible by the configurator of the master, which are used by the PLC and VT to exchange data. The size of the I/O area of each VT participating in the network is defined by the user with a 4 to 64 word limit (8-128byte).

**Profibus-DP
(Standard):
Configuration
software**

There are 3 types of software that play a part in configuring the network:

- VTWIN
- File with extension GSD
- Configuration software for network master

These types of software require parameters that coincide.

VTWIN:

The parameters that must be set in the VTWIN project of every terminal connected in the network are:

- Size (in words of the I/O area)
- Timeout for testing the connection between the VT and PLC.
- Address of terminal.

File with extension GSD (dedicated to Standard profile):

This file is supplied by ESA; it allows the configuration software of the network master to recognize the VT.

Network master configuration software:

This software is supplied by the producer of the network master.

**Profibus-DP (Standard):
Logical diagram**

Below is a logical diagram of the VT <-> Profibus-DP (Standard) connections.

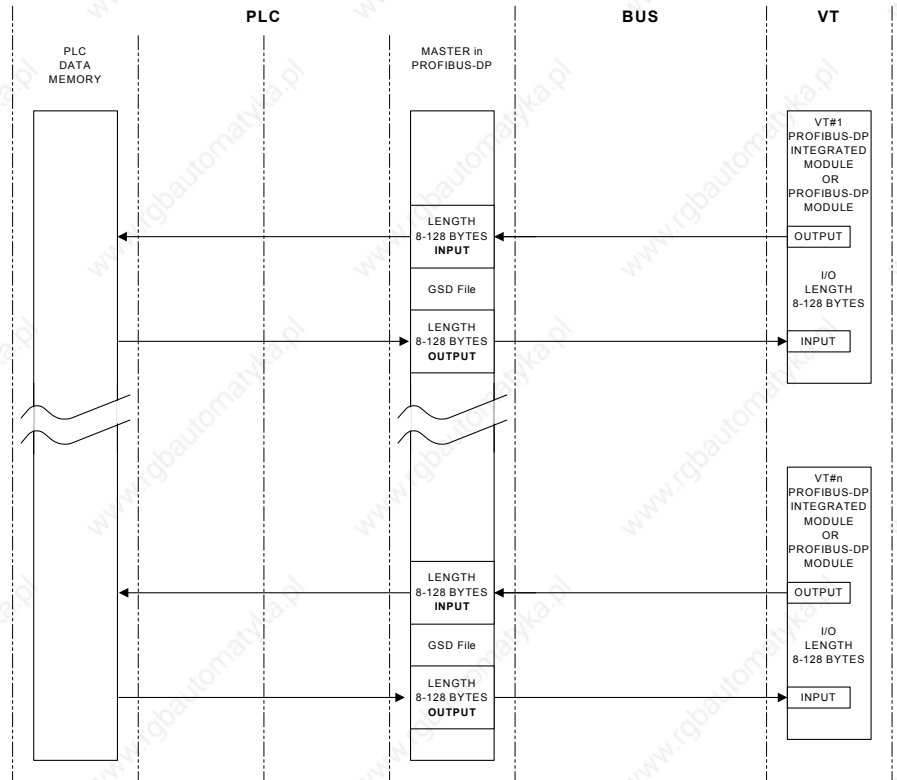

**Profibus-DP (Standard):
Physical diagram**

Below is a physical diagram of the VT <-> Profibus-DP connections.

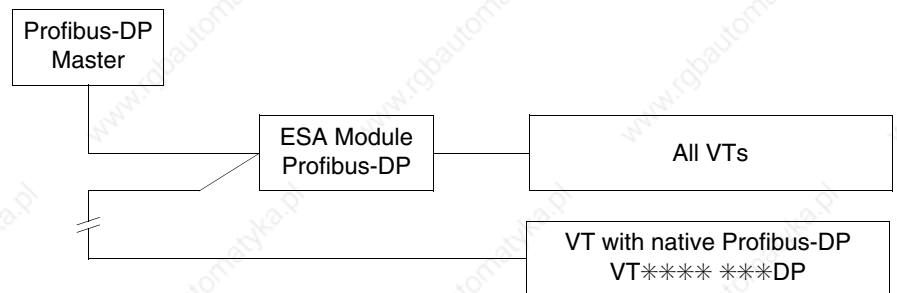

**Profibus-DP:
Connection**

Below is a diagram of the connections of devices in Profibus-DP network.

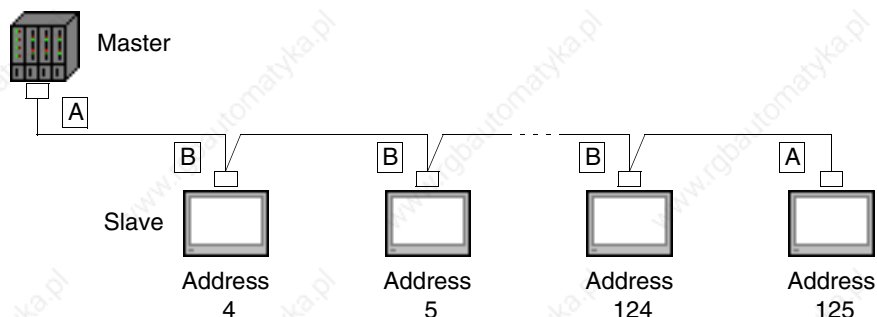

As can be seen from the above diagram the connections for devices at either end of the line (A) are different from the internally positioned ones (B). Indeed, the connectors at A have inside them the termination resistances of the line. There follow the types of connection existing within the connectors.

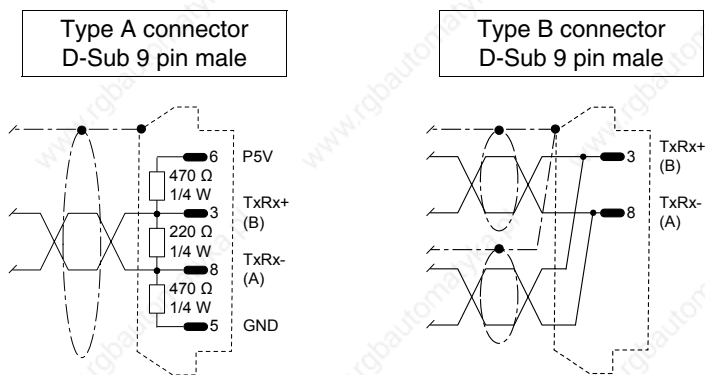

Use the materials listed in the table below when making connection cables.

Table 34.3: Cables

Maker/Distributor	Type	Web
Belden	3079A PROFIBUS Cable	www.belden.com
Siemens	Simatic Net Profibus FC6X91 830-0E11 10	www.siemens.com
Intercond	1DR 22X 02R	www.intercond.com
	1DR 22X 02P	

For further details contact the retailer and/or visit the appropriate WEB site.

Table 34.4: Connectors.

Maker/Distributor	Type	Web
Siemens	6ES7972-0BA10-0XA0	www.siemens.com
	6ES7972-0BB10-0XA0	
	6ES7972-0BA40-0XA0	
	6ES7972-0BB40-0XA0	
	6GK1500-0EA00	
Erni	103 648	www.erni.com
	103 658	
	103 663	
	103 649	
	103 659	
	104 329	
	104 577	
	104 322	

For further details contact the retailer and/or visit the appropriate WEB site.

Interbus-S

A VT equipped with a network card can be connected within a network as a slave (a passive station that can only transmit data after receiving a request from an active station). The master communication card, generally inserted in a PLC station, transmits and receives information from the slaves. There can be more than one slave connected to a single master in a network.

Interbus-S: VT operation

The slave VTs are seen generally as dedicated areas of memory in the PLC's I/O area, or alternatively in other data areas made accessible by the configurator of the master, which are used by the PLC and VT to exchange data. The size of the I/O area of each VT participating in the network is 4 words (8byte).

Interbus-S: Configuration software

There are 3 types of software that play a part in configuring the network:

- VTWIN
- FB
- Configuration software for network master

These types of software require parameters that coincide.

VTWIN:

The parameters that must be set in the VTWIN project of every terminal connected in the network are:

- Timeout for testing the connection between the VT and PLC.

FB:

This is a program supplied by ESA to be loaded into the PLC. This program is used to check the network parameters set and the data exchange. It varies according to the type of PLC (make and model). Besides the parameters which we have just seen in VTWIN, the incoming FB requires other information related to the PLC that will be hosting it. This information is contained in a text file on the disk entitled "VT-INTERBUS Installation SW".

Network master configuration software:

This software is supplied by the producer of the network master.

Interbus-S: Logical diagram

Below is a logical diagram of the VT <-> Interbus-S connections. The diagram indicates how and at what level the FBs supplied by ESA interact with the system. The FB INIT takes care of the initial configuration of the system (input and output areas, keys area, etc.), while the FB DRIVER takes care of the data exchange between the PLC memory and the VTs, and viceversa. The number of FB calls within the PLC must be equal to the number of VTs connected in the system.

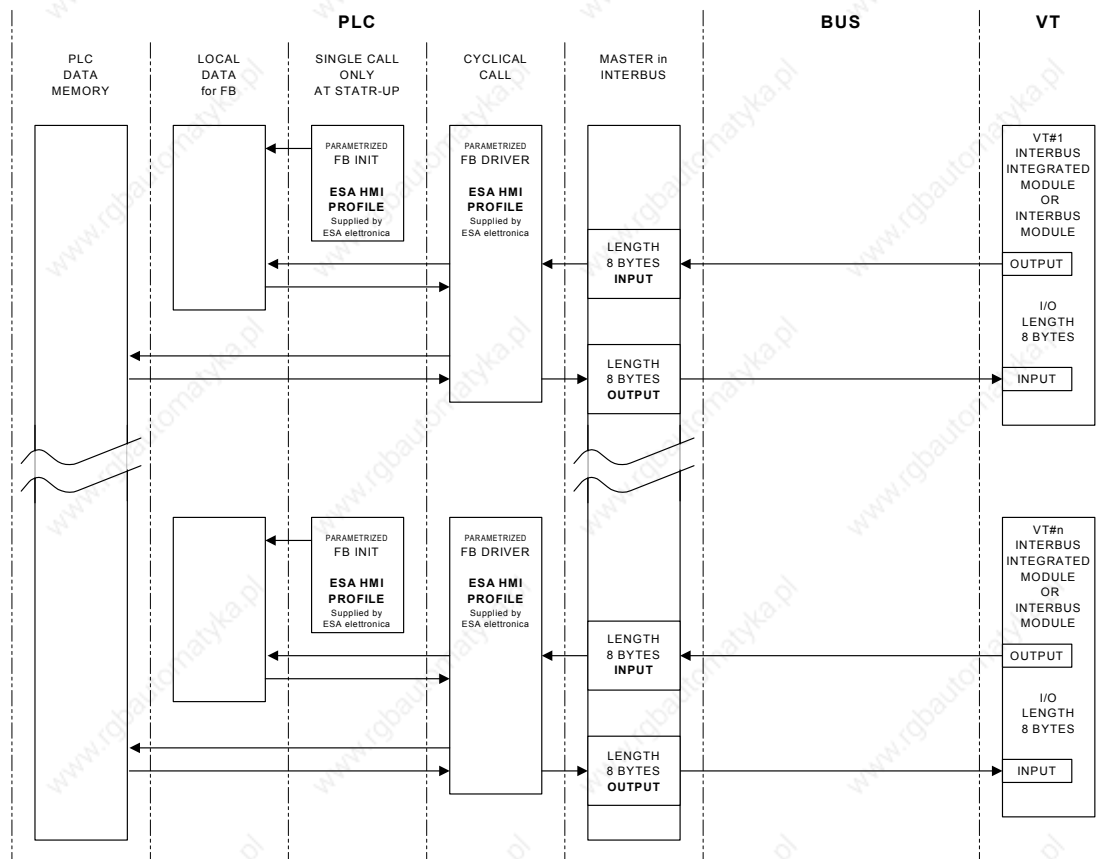

**Interbus-S:
Physical
diagram**

Below is a physical diagram of the VT <-> Interbus-S connections.

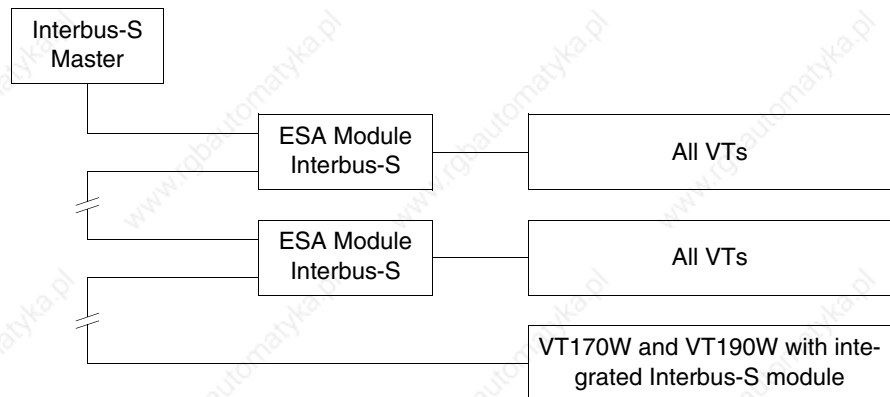
**Interbus-S:
Connection**

Below is a diagram of the connections between the VTs and the devices in Interbus-S network.

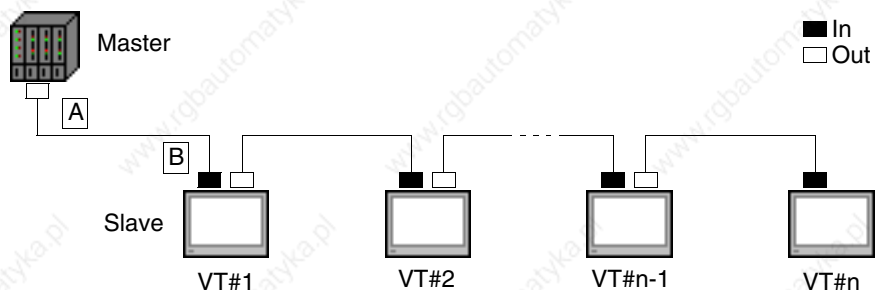

Parameter n stands for the maximum number of terminals that can be connected in the network, which depends on the size of the memory available in the master device for the input and output of process data. Each VT connected occupies 64 bits for the data input area and 64 bits for the process data output; thus

$$n = \frac{\text{I/O area of master device}}{64 \text{ bit}}$$

Below we list the connection cables required.

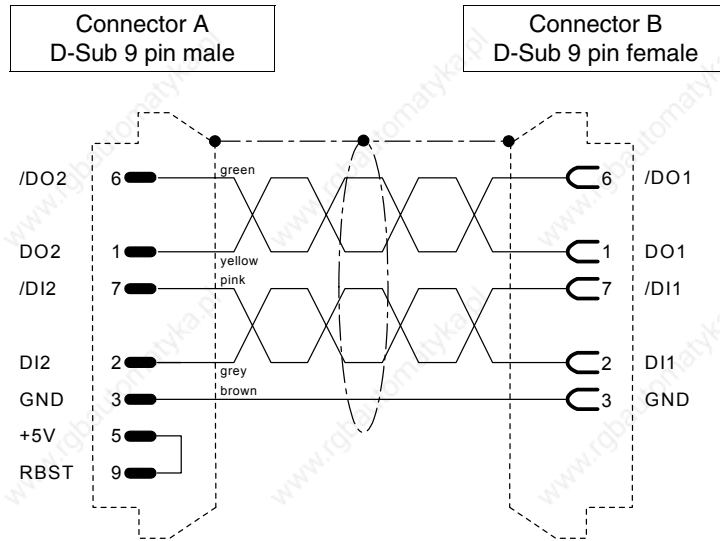

Use the materials listed in the table below when making connection cables.

Table 34.5: Cables

Maker/Distributor	Type	Web
Belden	3120A INTERBUS Cable	www.belden.com
Phoenix	27 18 28 0	www.phoenixcontact.com

For further details contact the retailer and/or visit the appropriate WEB site.

Table 34.6: Connectors.

Maker/Distributor	Type	Web
Phoenix	27 58 47 3	www.phoenixcontact.com
	27 58 48 6	
Erni	103 650	www.erni.com
	103 651	
	103 660	
	103 661	
	104 319	

For further details contact the retailer and/or visit the appropriate WEB site.

ESA-Net

All VT terminals can be connected in an ESA-Net network as *Network Clients* or as *Network Servers* (see technical characteristics of individual terminals). The network Client can only ask other terminals in the network for information (variables); while the network Server makes information (variables) available to other terminals in the network.

ESA-Net: VT operation

To help clarify the concept of ESA-Net, we offer the data-flow diagram below showing how a terminal assumes the function of client, server and server/client.

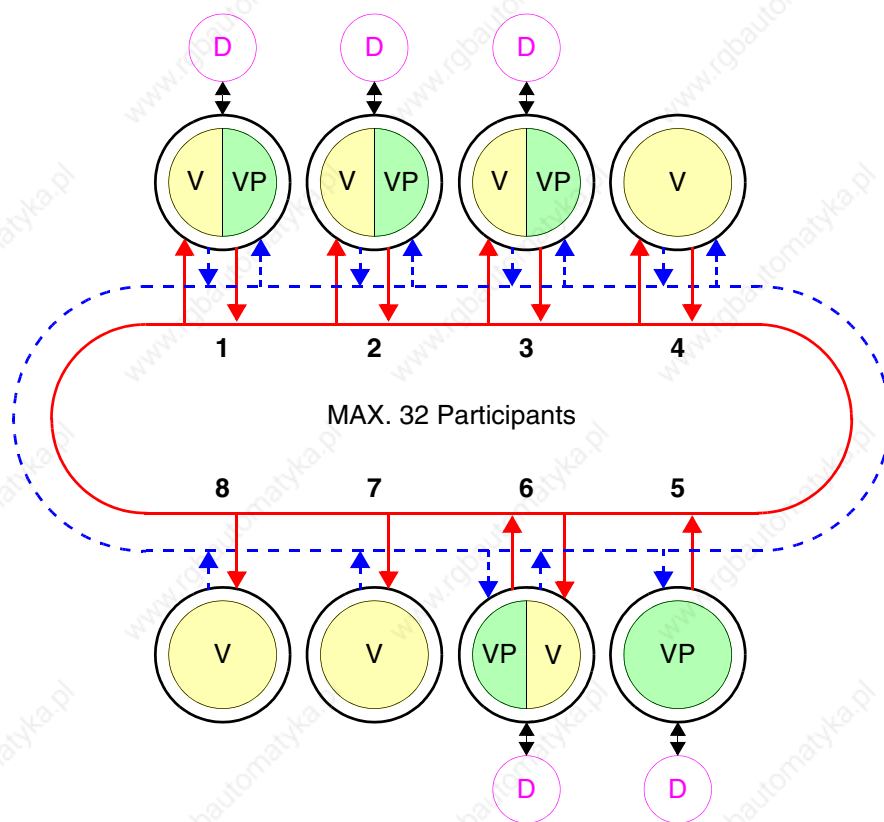

In the ESA-Net network the server terminal is the one that makes all or some of the variables available to the other terminals; these variables are called *Public Variables*.

⚠ The maximum length of public objects is 60 Bytes; excess lengths will be truncated. To avoid this, we suggest more than one object with the appropriate lengths (with a length of 120 Bytes use two objects of 60 Bytes).

▲ The maximum number of public objects is 128, making a total of 1024 Bytes.

The client terminal is the one that uses the public variables made available by the server terminal. The terminal that uses public variables and, in its turn, makes others available is known as the server/client. Generally, the client terminal has no device of any kind connected.

The example in the figure shows eight terminals connected, of which:

1	->	Server/Client	->	V/VP	->	Device
2	->	Server/Client	->	V/VP	->	Device
3	->	Server/Client	->	V/VP	->	Device
4	->	Client	->	V		
5	->	Server	->	VP	->	Device
6	->	Server/Client	->	V/VP	->	Device
7	->	Client	->	V		
8	->	Client	->	V		

The area colored green (VP) represents the public variables, the area colored yellow (V) represents the variables; the device is indicated schematically in violet (D). The two central rings, one represented by a continuous red line indicates the VT's response to a request (the dotted lined traced in blue indicates the request for information).

A network can have more than one server, more than one client and more than one server/clients, the total being 32 terminals.

The network participants must each have a different address; the address of the terminal is configured using the VTWIN (see Software Manual).

A terminal can be connected to the network either using the communication standard RS485 and the MSP and ASP (default) serial ports or, alternatively, using an RS485 serial module (optional) - (see "Chapter 33 -> Video terminal accessories").

▲ To avoid any problems, the device to be connected to the VT must be connected using the MSP port; the ESA-NET network must therefore be connected over the ASP port or the field network. If the VT is to be connected only to the ESA-NET network, the MSP can also be used.

The VT can operate at a speed of from 38400 to 187500Baud; all participants in the network must be set to the same transmission speed.

**ESA-Net:
Connecting
the terminals**

Since serial communications are highly subject to disturbances, the following advice should be followed to reduce as much as possible such problems:

- It is absolutely necessary to use a fully shielded twisted serial cable, with a pair of conductors having a minimum section of 0.22 mm² and a characteristic impedance of 120 Ohms.
- It is absolutely necessary to use a fully shielded connector.
- The termination resistances must be placed exclusively at the physical extremes of the ESA-NET network.
- Insert the polarization resistances of the appropriate value (typically 470 Ohms).
- The shield of the cable must be soldered or mechanically connected to the metal shells of the connectors that are connected subsequently to the VTs in the network.

 **The VT serial connection cables must be laid in separate raceways from the power supply cables.**

 **The VT serial connection cables must be laid in separate raceways from the power cables and from all the devices that may, in general, be sources of disturbance (servo drives, inverters, etc...).**

The table below shows the three connectors that can be used (MSP - ASP - Field network) for ESA-NET network connections alongside the various types of wiring according to position held within the network.

 **The VT connected in the network with a connector incorporating three resistances must never be switched off while the other participants in the network are still on. Should this happen, the effect of the polarization resistances will be negated and there is a possibility that communication errors will occur.**

MSP - Connection: type A

25-pin connector with polarization and termination resistances.

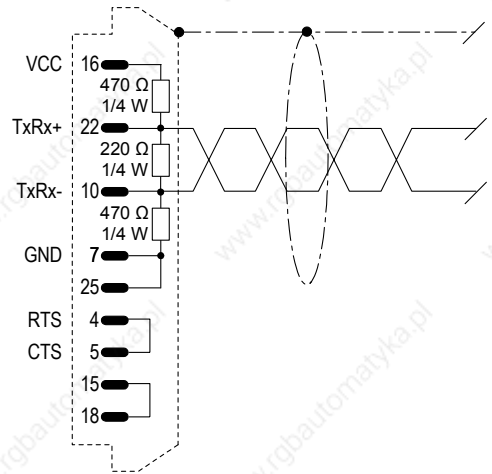
**MSP - Connection: type B**

25-pin connector with termination resistances.

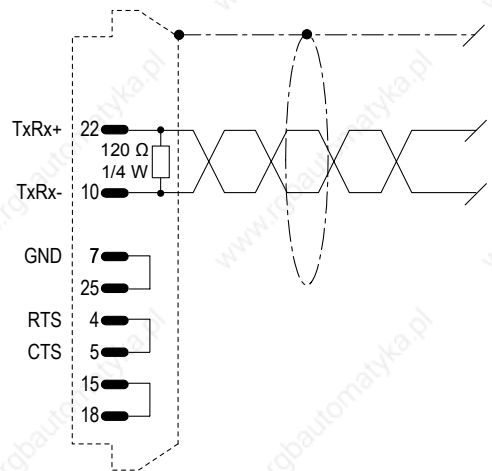
**MSP - Connection: type C**

25-pin connector.

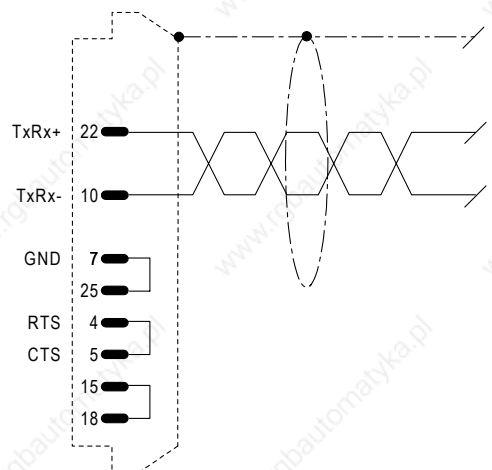

ASP - Connection: type D

15-pin connector with polarization and termination resistances.

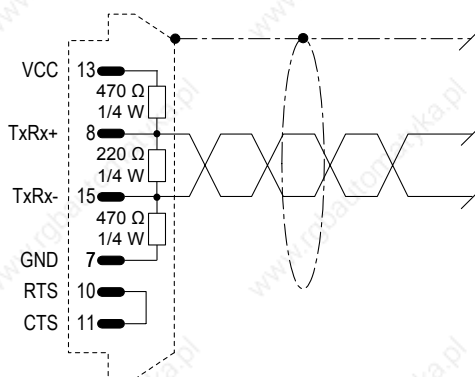
**ASP - Connection: type E**

15-pin connector with termination resistances.

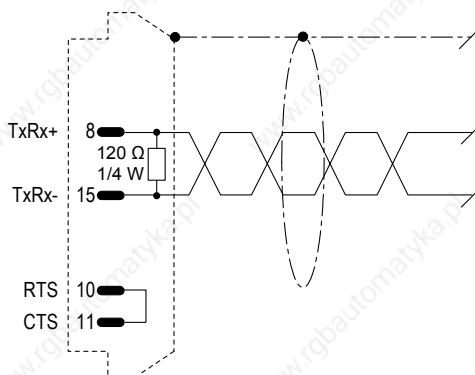
**ASP - Connection: type F**

15-pin connector.

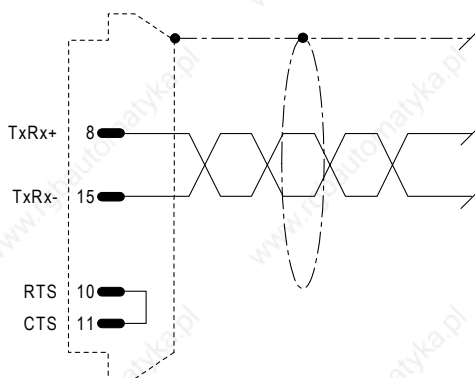
**Field network - Connection: type G**

9-pin connector with termination resistances.

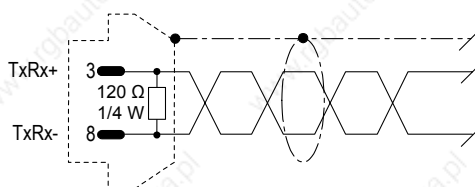
**Field network - Connection: type H**

9-pin connector.

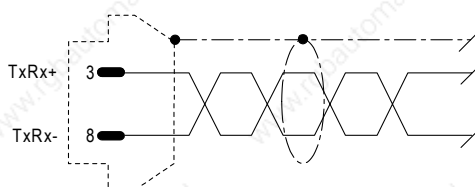

There follows a table to use when making the ESA-NET network cable. To use this table proceed as follows:

- the layout of the VTs to be connected in the network;
- define the port to be used for the network connection of each VT;
- identify which VTs are physically at the extremes of the network;
- specify which of the terminals at the extremes of the network will be first and which last.

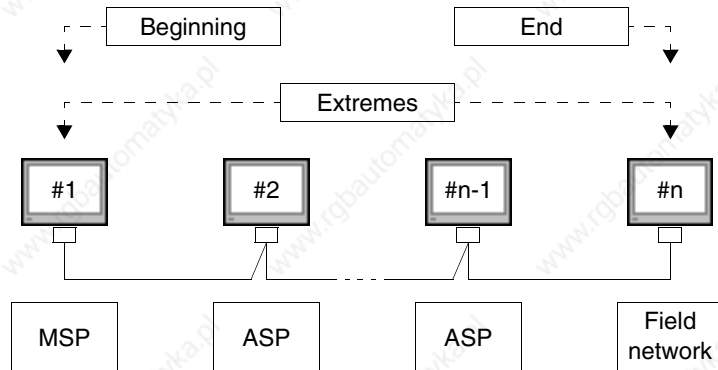

⚠ If, for any reason, the extremes are connected by a Field network connector, one of the intermediate VT connections must still be type A or D (depending on which connector is available).

Table 34.7: Construction of ESA-NET cable.

Connector	Position	Wiring							
		A	B	C	D	E	F	G	H
MSP 25-pin	Initial	●	--	--	--	--	--	--	--
	Final	--	●	--	--	--	--	--	--
	Intermediate	--	--	●	--	--	--	--	--
ASP 15-pin	Initial	--	--	--	●	--	--	--	--
	Final	--	--	--	--	●	--	--	--
	Intermediate	--	--	--	--	--	●	--	--
Field network 9-pin	Initial	--	--	--	--	--	--	●	--
	Final	--	--	--	--	--	--	●	--
	Intermediate	--	--	--	--	--	--	--	●

The following page shows the cable needed for the connection as in the figure using 3 VT terminals.

VT1 connection using
25 pin **MSP**

VT2 connection using
15 pin **ASP**

Connection using
9 pin
RS485 serial module
(For this option see "Chapter 33 ->
RS485 Serial module")

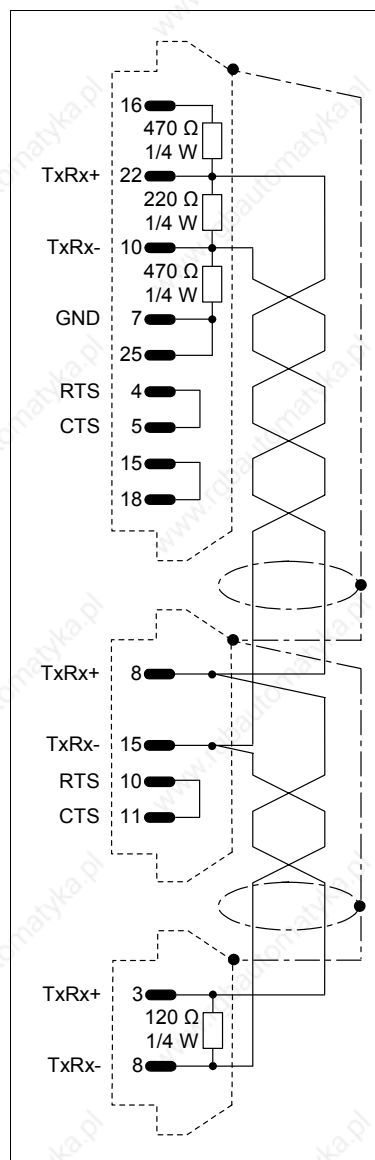

ESA-Net: Configuration software

There is only 1 type of software used in configuring this network:

- VTWIN

This software requires that you set parameters that coincide one with the other.

VTWIN:

The parameters that need to be set in the VTWIN project of each terminal connected in the network are:

- Terminal's network address

ETHERNET

VT terminals equipped with the right interface can be connected in a network with other devices functioning by means of Transfer Control Protocol/Internet Protocol (TCP/IP).

The advantage of the Ethernet connection lies in the high speed of data exchange it gives, (from 10Mbit/s to 100Mbit/s depending on the device connected); secondly cabling is simplified – indeed, the VT does not need to be connected directly to the device but they can be interconnected using a network concentrator; in addition, the number of possible network participants is so high as to be practically limitless.

**ETHERNET:
VT operation**

The VTs communicate with the devices in a network by means of an exchange of information on the form of small packages of data that are managed by the TCP communication protocol. This splits up the information and recomposes it once it arrives at its destination and it is responsible for checking that all the information has arrived at the destination. The IP protocol, on the other hand, is responsible for directing the information sent to the right addressee. These protocols, TCP and IP, always work closely together to ensure that the exchange of information functions correctly.

**ETHERNET:
Configuration
software**

There are two types of software that come into play when configuring this network:

- VTWIN
- Software for configuring the device

These softwares require the setting of parameters that depend on the type of network to which the terminal is connected.

VTWIN:

The parameters that need to be set in the VTWIN project of each terminal connected in network are as follows:

- IP Address
- Subnet Mask
- Any other parameters depending on the device connected



Equal IP addresses are not valid.

Software for configuring the device:

This software is supplied by the maker of the device.

ETHERNET: Connections

The figure below shows two examples of connections: the first example shows a connection between a VT and a device using a direct connection, while the second example shows a connection between VT and device using a company network.

Example of direct connection between VT and Device.

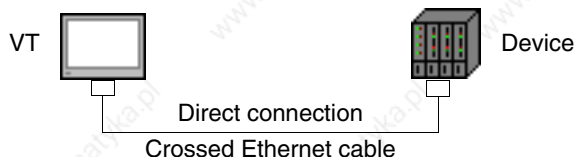

The layout in the diagram shows a crossed Ethernet network cable to be used for direct connection between the VT and the device without using a company network connection.

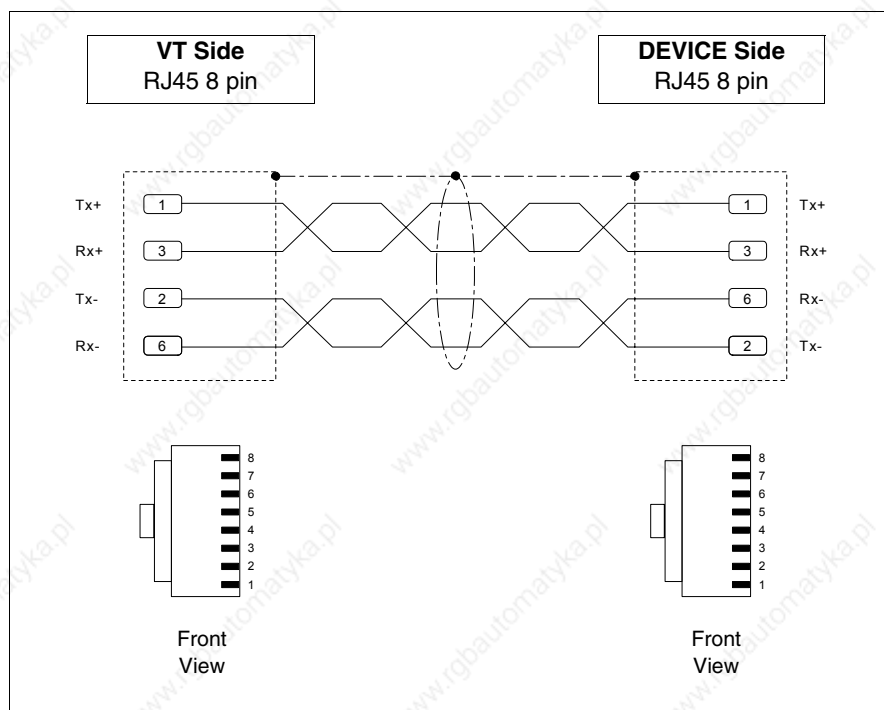

⚠ NOTE: In this example we are not in a network context with other devices so the IP address can be arbitrary.

The first three numbers of the IP address assigned must be the same as those of the device with which it is to be connected, the fourth number must be different. Example VT - 192.168.100.1, Device - 192.168.100.5

The other parameters remain those preset.

Example of connection between VT and device using a company network.

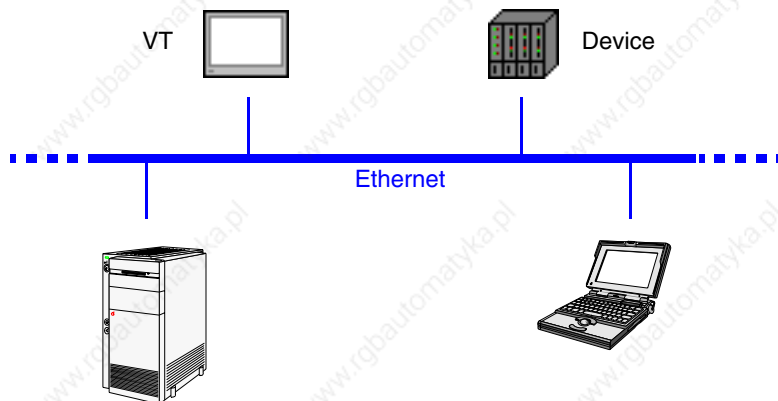

The connection to the network uses an Ethernet Standard cable.

⚠ NOTE: All the parameters that need to be introduced depend on the configuration of the network to which the connection is made. You are, therefore, advised to contact the network administrator.

ETHERNET: Checking the connection

If considered necessary, it is possible to check that the system is working properly by running the command PING on a PC in the network.

Go to the prompt of the PC commands and type ping followed by the IP address assigned to the VT and/or the device and confirm with Enter (E.g. ping 192.168.100.5).

If the connection and the settings have been executed correctly, response strings will appear that contain the IP address requested. If, on the other hand, what appears are strings indicating failure of the request this means that there are connection problems; in this case the whole procedure including the connection cable must be checked.

CAN

VT terminals equipped with the appropriate interface can be connected in a network with other devices by means of a CAN (Controller Area Network) protocol.

CAN terminals correspond to CIA DS 102 Version 2.0 (CAN Physical Layer for Industrial Applications) specifications.

The CAN network differs from other types of network in its low cost, high level performance in difficult electrical conditions, exceptional ability to respond in real time and operational simplicity.

This type of network has a master/slave structure. The master device takes care of initializing and configuring the slave stations, and further with controlling the communication state of the devices in the network. The slave devices are concerned exclusively with exchange of information. To be able to communicate, the slave devices must be initialized (operational state) and parameterized by the master device.

The VT can work at a speed ranging from 10kbit/s to 1000kbit/s.

**CAN: VT
functioning in
CAN network**

The VTs communicate with the devices using logical channels to which there correspond virtual communication lines which are independent of one another and definable using certain parameters.

Logical channels can be of one of two types:

- SDO (Service data object)
- PDO (Process data object)

SDO channels concern themselves with the exchange of parameters for setting, configuring and other information regarding the setting of the device. PDO channels, on the other hand, concern themselves exclusively with exchanging information related to the process underway.

PDO channels have priority over SDO channels.

It is possible to define the identifiers and lines of communication for all SDOs and PDOs by using the TX and RX parameters; admissible values run from 1 to 65535.

The network participants must each have a different address; the address of the terminal is configured using VTWIN (see Software Manual).

CAN: Configuration software

There is only one type of software that can effect the configuration of this network:

- VTWIN

This software requires the setting of parameters that coincide with one another.

The parameters that have to be set in the VTWIN project of every terminal connected in the network are:

- Network address of the terminal.
- SDO
- PDO

CAN: Connection

The figure below shows the connection of VT with devices in a CAN network, in a master VT and slave formation.

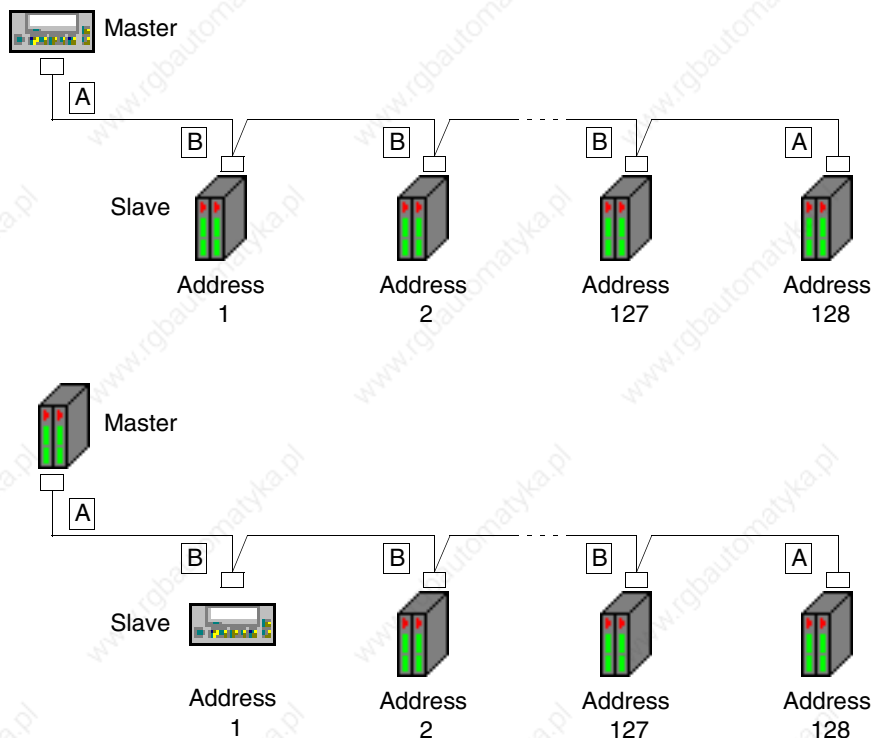

Theoretically the network admits 128 devices, but the real limit depends on how many logical channels are activated. The maximum number of channels is 64 SDO and 64 PDO.

Example:

Suppose each device possesses 2 SDOs and 3 PDOs. If all are activated, the maximum number of the devices that can be connected is 21, i.e. the overall number of channels admissible divided by the number of PDO channels for each device (because the PDO channels, being more numerous, determine the limit).

$$\text{Max. participants} = \frac{\text{Max. of channels allowed}}{\text{Channels activated}} = \frac{64}{3}$$

As can be seen from the figure above, the connections for the devices at the ends of the line (A) are different from the internal ones (B). Indeed, the A connectors require cabling with a termination resistance for the line.

The VT terminals are already internally equipped with a termination resistance, so in the first case (VT master) the resistance on the connector can be omitted by using an integrated resistance. (See chapter on terminal to be connected).

⚠ VTxxxH terminal cables always have terminations.

There follow diagrams of the types of connection.

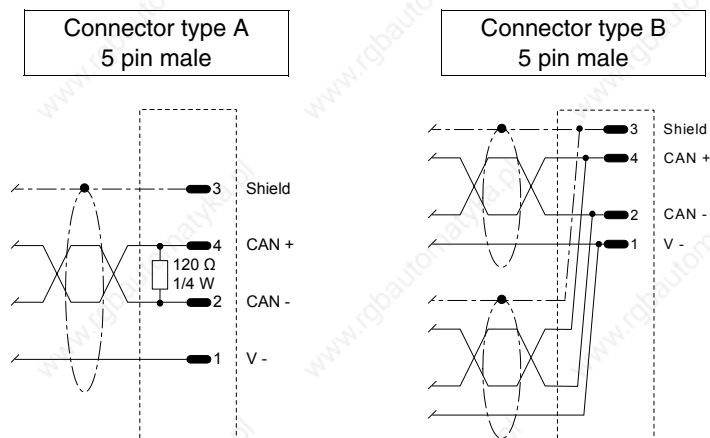

The recommended connection applies only to VTxxxH terminals.

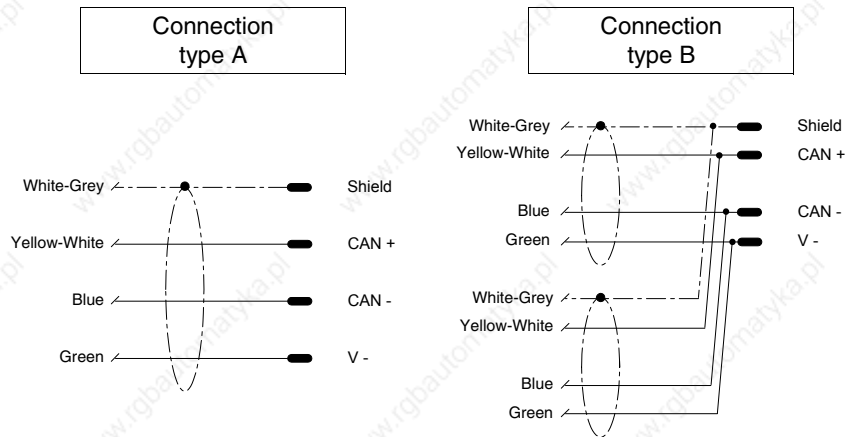



The connection cable is already terminated on the VT side.

Chapter 35 Operation of terminal with keyboard

Contents	Page
Changing value of variable field	35-2
Total change	35-3
Partial change	35-3
Examples of varying fields	35-3
Displaying messages	35-8
Information messages	35-8
VT50 info-messages	35-8
VT60 info-messages	35-9
VT150W - VT160W info-messages	35-10
VT170W info-messages	35-10
VT190W info-messages	35-11
VT300W - VT310W - VT320W info-messages	35-12
VT330W info-messages	35-12
ISA-1A alarms	35-16
VT170W alarms	35-17
VT190W alarms	35-19
VT300W - VT310W - VT320W alarms	35-20
VT330W alarms	35-20
ISA-1A alarm history buffer	35-24
VT170W history buffer	35-25
VT190W history buffer	35-26
VT300W - VT310W - VT320W history buffer	35-26
VT330W history buffer	35-26
Help messages	35-29

This chapter consists of 30 pages.

The contents of this chapter apply to all the VT terminals of the same family that have a keyboard. As the  of the various models differ in certain details, the following explanations will indicate, for each , the respective model.

The way a key functions changes according to the type of field to be varied.

⚠ Throughout the present chapter, when referring to the number of rows and the number of characters that can be used in the terminal, we assume native fonts are being used; when Windows-based fonts are used (in the case of graphics terminals only), the equivalent screen area in pixels should be considered (see Software Manual “Chapter 6 -> Project language”).

Changing value of variable field

To be able to carry out a change in any editable variable field, the cursor must first be positioned over the field involved by using

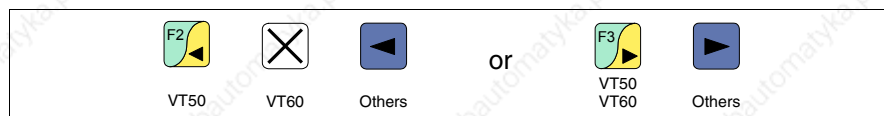

and then pressing

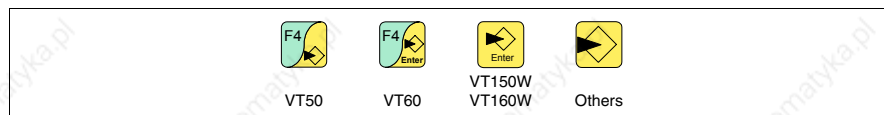

which enables the introduction of the new value.

The edit mode can be quit in two ways: either by saving after completing the input of a value and pressing

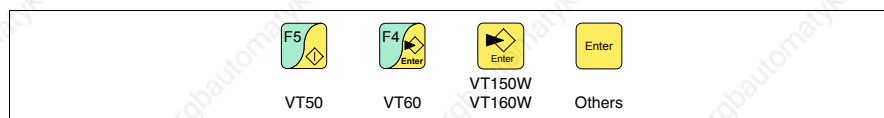

or at any given moment without saving by pressing

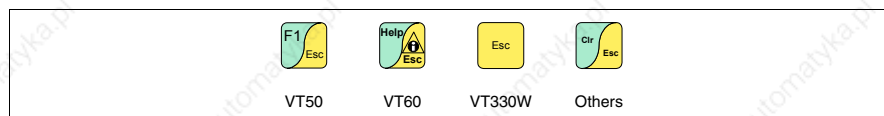

or automatically when the “Input timeout” (see Software Manual) elapses.

The VT offers the following ways of changing a field:

- Total change
- Partial change

Total change

This is the default mode adopted by the VT when enabling a change in a field: numerical and alphanumeric fields behave differently.

Numerical fields:

The cursor flashes on the rightmost digit of the field. When the first digit is introduced the rest of the field goes to zero, while the successive introductions make the digits shift to the left.

Alphanumeric field (ASCII):

The cursor flashes on the leftmost digit of the field. When the new string is introduced sequentially the cursor moves one character to the right.

Partial change

With the edit mode enabled, pressing

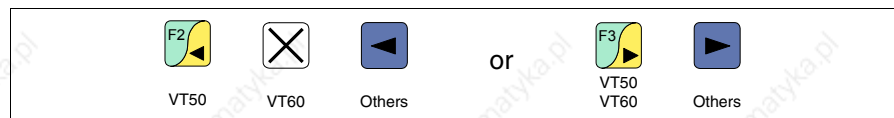

and then inputting a digit or character or pressing

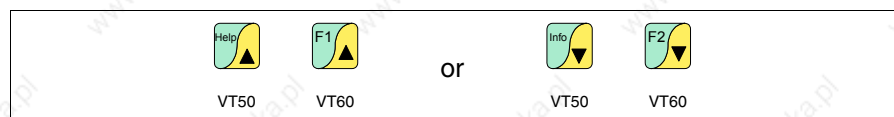

enables the change of only that digit or character pointed to by the cursor; to change the adjacent digits or characters the cursor must be positioned manually (the figure above applies only to VT50 and VT60).

Examples of varying fields

The examples below are offered to clarify how this works. For the sake of simplicity we have chosen a single product, VT170W, but conceptually what is said applies to all VTs, irrespective of what is written on the .

Changing the value of a decimal numerical field:

The following example demonstrates the variation (total change) of field 1 from 9999 to -1234.





Sample page	
Field 1	999

Edit mode is enabled and the cursor flashes on the rightmost digit of the data (least significant digit).

Sample page	
Field 1	000

Press  to enter the first digit of the new value; the field assumes the value 1.

Sample page	
Field 1	-123

Press    to complete the new value; press  to attribute a sign and  to confirm the change.

Changing the value of a floating point numerical field:

The procedure for changing a floating point numerical field is as for a decimal numerical field, except that a decimal point can be inserted anywhere in the field. The following example shows a variation (total change) in field 2 from 10.3256 to 321.65.



Sample page	
Field 2	10.3256

Edit mode is enabled and the cursor flashes on the rightmost digit of the data (least significant digit).



Sample page	
Field 2	000000

Press  to enter the first digit of the new value; the field assumes the value 3.



Sample page	
Field 2	000032

Press   to complete the whole numbers in the field.

Sample page	
Field 2	000321.





Press  +  to introduce the decimal point.

Sample page	
Field 2	0321.6

Press   to complete the introduction of the new value.

Press  to confirm the change.

Changing the value of a hexadecimal numerical field:

A hexadecimal digit can assume not only numerical values from 0 to 9 but also the letters A-B-C-D-E-F; thus for this type of field the numerical  and  can be used to enter the letters A-B-C and D-E-F respectively by pressing the same key  more than once. All the other  from 2 to 9 have only a numerical significance. The following example illustrates the variation (total change mode) of field 3 from 1A3F to B23C.



Sample page	
Field 3	1A3

Edit mode is enabled and the cursor flashes on the rightmost digit of the data (least significant digit).

Sample page	
Field 3	000

Press  three times to enter the first digit of the new value; the field assumes in sequence the values 0, A and B.

Sample page	
Field 3	B23

Press  , then press  4 times to complete the new value;

Press  to confirm the change.

The following example illustrates the variation (partial change) of field 3 from B23C to BABA.

Sample page	
Field 3	B23

Edit mode is enabled and the cursor flashes on the rightmost digit of the data (least significant digit).

Sample page	
field 3	B23C

Position the cursor on the second digit by pressing twice .



```

Sample page
field 3      BABC
  
```

press  twice to change the digit to the value A.



```

Sample page
field 3      BABC
  
```

Position the cursor on the third digit by pressing  and press  three times to change the digit to the value B.

```

Sample page
field 3      BAB
  
```

Position the cursor on the last digit by pressing ; press  twice to change the digit to the value A. Press  to confirm the change.

Changing the value of an alphanumeric (ASCII) numerical field:

The following example illustrates the changing of field 4 from MOTOR 1 to VALVE 3.5.

```

Sample page
Field 4
MOTOR 1
  
```

Edit mode is enabled and the cursor flashes on the leftmost digit.





```

Sample page
Field 4
MOTOR 1
  
```

Press  once to enter the first character of the new value.



```

Sample page
Field 4
VALTOR 1
  
```



The cursor's movement by one character to the right happens automatically if the same  is not pressed within a second or if a different alphanumeric  is pressed; it is always possible to reposition it by pressing  or .

Entering [A] as the second character will cause the cursor to move automatically.





Sample page
Field 4
VALVE 1

Press  3 times,  once and  twice to complete word VALVE.

Sample page
Field 4
VALVE 

Press  to leave a space in the field and then  4 times.

Sample page
Field 4
VALVE 3.

Press  +  to enter the character [.]; press  4 times to complete the new value; press  to confirm the change.

Changing the value of a dynamic text field:

The following example illustrates the variation of field 5 that can assume 4 different states to which the following 4 symbolic texts correspond: SETUP, STOP, MANUAL, AUTOMATIC.

Let us assume that SETUP is the starting value and MANUAL the final one.



Sample page
Field 5
SETUP

Edit mode is enabled and the cursor flashes on the leftmost digit.

Sample page
Field 5
STOP

The first time  is pressed the field assumes the value STOP.

Sample page
Field 5
MANUAL

The next time  is pressed the field assumes the desired value, that is MANUAL. Press  to confirm the change.

Displaying messages

The VT can display three types of message: *Information messages*, *ISA-1A Alarms* (in the case of terminals accepting them) and *Help messages* (HELP pages). The information and alarm messages can only be displayed if, using VTWIN, the programmer has already prepared the list of messages assigned to areas of memory in the device.

Which type of message is used is at the discretion of the programmer.

Information messages

When an event occurs which has an information message assigned to it the LEDs of the following keys start flashing:

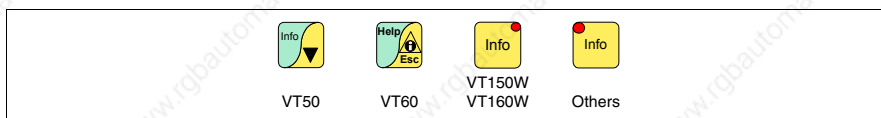

! Terminals VT50 and VT60 do not have LEDs, so there is no way of understanding when an information message is present. You are advised to define the priority of the messages with regard to the page using the *Exchange area* "Chapter 37 -> Command area" (see also Software Manual).

Information messages can be seen only when the event triggering them is still present. When you press

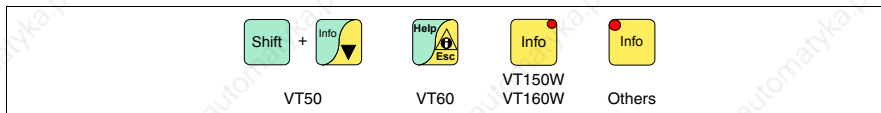

you enter display mode, indicated by a fixed LED light (where terminals have them), which is so structured as to allow one page for each message, that page have the following format (formats vary according to the type of VT).

The VT can provide an automatic sequential display of information messages on command from the device (see "Chapter 37 -> Command area").

VT50 info-messages

Format:

- Two rows of 20 characters for the text of the message.

Example with two messages.

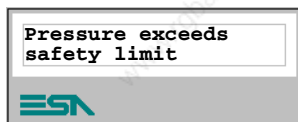

First message

When you press  the next message is displayed

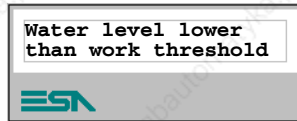

Second message

When you press  the first message is displayed again:

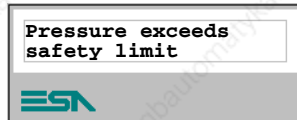

First message

VT60 info-messages

Format:

- Four rows of 20 characters for the text of the message.

Example with two messages.

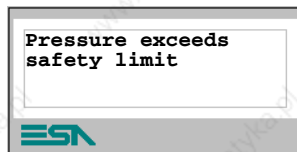

First message

When you press  the next message is displayed:

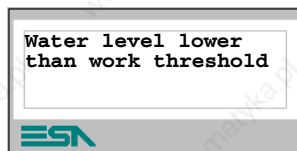

Second message

When you press  the first message is displayed again.



First message

VT150W - VT160W info-messages

Format:

- Two rows of 20 characters for the text of the message.
- One row for any data field (which in that particular situation could indicate a safety or warning limit value).
- The first display is indicated by two characters [**] on the far right of the third line of the display. These symbols are not present if the message appeared when the display mode for information messages was accessed on a previous occasion.

Example with two messages.

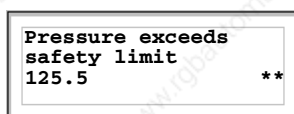

First message



When you press  the next message is displayed:

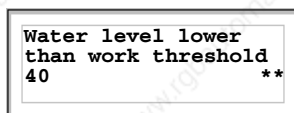

Second message



When you press  the first message is displayed again:

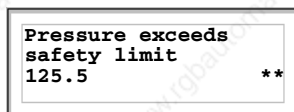

First message

VT170W info-messages

Format:

- Two rows of 20 characters for the text of the message.
- One row for any data field (which in that particular situation could indicate a safety or warning limit value).
- One row for the date and time the signal occurred.
- The first display is indicated by two characters [**] on the far right of the third line of the display. These symbols are not present if the message appeared when the display mode for information messages was accessed on a previous occasion.

Example with two messages.

```

Pressure exceeds
safety limit      **
125.5
01/07/1998 10:45

```

First message

When you press  the next message is displayed:

```

Water level lower
than work threshold **
40
01/07/1998 10:46

```

Second message

When you press  the first message is displayed again:

```

Pressure exceeds
a limit          **
125.5
01/07/1998 10:45

```

First message

VT190W info-messages

Format:

- Two rows of 40 characters for the text of the message.
- One row for any data field (which in that particular situation could indicate a safety or warning limit value).
- One row for the date and time the signal occurred.
- The first display is indicated by two characters [**] on the far right of the third line of the display. These symbols are not present if the message appeared the last time the display mode for information messages was accessed.

Example with two messages.

```

The pressure in the tank exceeds
first warning limit      **
125.5
01/07/1998 10:45

```

First message

When you press  the next message is displayed:

```

The water level is lower than the
threshold enabling work to proceed **
40
01/07/1998 10:46

```

Second message

When you press  the first message is displayed again:

```

The pressure in the tank exceeds
first warning limit
125.5
01/07/1998 10:45

```

First message

**VT300W -
VT310W -
VT320W
info-messages**



Format:

- Five rows of 30 characters with character height of X1 or two rows of 15 with character height of X2 for the text of the message (VT300W - VT310W).
- Five rows of 36 characters with character height of X1 or two rows of 18 with character height of X2 for the text of the message (VT320W).
- One row for any data field (which in that particular situation could indicate a safety or warning limit value).
- One row for the date and time the signal occurred.
- The first display is indicated by a closed envelope [✉] at the top left of the display. This symbol is not present if the message appeared the last time the display mode for information messages was accessed.

Example with two messages (VT310W).



	Pressure exceeds safety limit 125.5 01-07-1998 10:45a	HELP	PgDn
---	--	------	------

First
message

When you press  +  the second page containing the second message appears. NB: having already appeared before, this message is not accompanied by a closed envelope:

Temperature exceeds safety limit 1700 01-07-1998 10:55a	HELP	PgUp
--	------	------

Second
message

When you press  +  the previous page is displayed again.

Example with three messages (VT310W and VT320W).

	Pressure exceeds safety limit 125.5 01-07-1998 10:45a HELP	Up	First message
	Temperature exceeds safety limit 1700 01-07-1998 10:55a HELP	Down	





When you press  you select the second message displayed as the current message (the black bar indicates message has been selected). NB: having already appeared before, this message is not accompanied by a closed envelope:

	Pressure exceeds safety limit 125.5 01-07-1998 10:45a HELP	Up	First message
	Temperature exceeds safety limit 1700 01-07-1998 10:55a HELP	Down	



When you press  again you select the third message displayed as the current message:

	Temperature exceeds safety limit 1700 01-07-1998 10:55a HELP	PgUp	Second message
	Water level under minimum level -10 01-07-1998 11:00a HELP	Down	

When you press  +  the previous page appears containing the first and second messages:



	Pressure exceeds safety limit 125.5 01-07-1998 10:45a HELP	Up	First message
	Temperature exceeds safety limit 1700 01-07-1998 10:55a HELP	Down PgDn	Second message

VT330W info-messages

Format:



- Four rows of 70 characters x1 high or two rows of 35 characters of double height (x2) for the text of the message.
- One row for any data field (which in that particular situation could indicate a safety or warning limit value).
- One row for the date and time the signal occurred.
- The first display is indicated by a closed envelope [✉] at the top left of the display. This symbol is not present if the message appeared the last time the display mode for information messages was accessed.

Example with five messages:



	Pressure exceeds safety limit 125.5 01-07-1998 10:45a	First message
	Temperature exceeds safety limit 1700 01-07-1998 10:55a	Second message
	Water level below min. -10 01-07-1998 11:00a	Third message
	The level of gas saturation in the boiler room has reached the first warning level 345 01-07-1998 19:00a	Fourth message



When you press  you select the second message displayed as the current message (the black bar indicates message has been selected). NB: hav-

ing already appeared before, this message is not accompanied by a closed envelope:

	Pressure esxceeds safety limit 125.5 01-07-1998 10:45a	First message
	Temperature exceeds safety limit 1700 01-07-1998 10:55a	Second message
	Water level below min. -10 01-07-1998 11:00a	Third message
	The level of gas saturation in the boiler room has reached the first warning level 345 01-07-1998 19:00a	Fourth message



When you press  again you select the third message displayed as the current message:



	Pressure esxceeds safety limit 125.5 01-07-1998 10:45a	First message
	Temperature exceeds safety limit 1700 01-07-1998 10:55a	Second message
	Water level below min. -10 01-07-1998 11:00a	Third message
	The level of gas saturation in the boiler room has reached the first warning level 345 01-07-1998 19:00a	Fourth message

When you press  +  the next page containing the fifth message appears

Water pump stoppage	01-07-1998 19:45a

Fifth
message

When you press  +  the previous page returns containing the first four messages:

	Pressure exceeds safety limit 125.5 01-07-1998 10:45a
	Temperature exceeds safety limit 1700 01-07-1998 10:55a
	Water level below min. -10 01-07-1998 11:00a
	The level of gas saturation in the boiler room has reached the first warning level 345 01-07-1998 19:00a

First
message

Second
message

Third
message

Fourth
message

ISA-1A alarms

When an event occurs to which an alarm has been assigned, the following LEDs begin to flash:

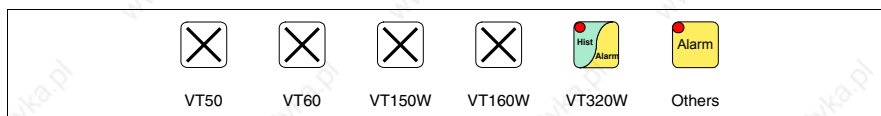

ISA alarms are displayed from the time when the event triggering the alarm occurs (Event in) until there is an individual acknowledgment operation using

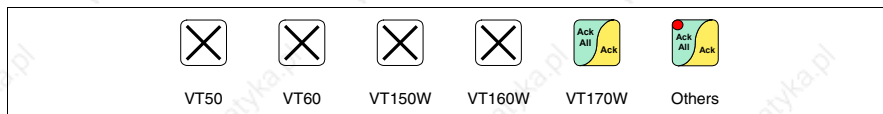

or the global acknowledgment operation using



(Event acknowledged) and the triggering event is no longer present (Event out).

By “acknowledgment” we mean the confirmation on the part of the plant or machine operator of having taken note of the alarm message.

For further details on how *ISA-1A Alarms* work see Software Manual.

When you press

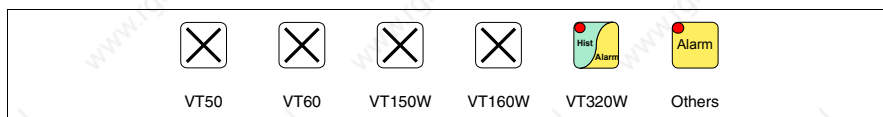

you enter display mode, signaled by the fixed light LED of that coming on, where the first page has the format set out below (the format changes according to the type of VT).

When you press again you enter the second page whose format is set out below (valid only for VT170W and VT190W).

The VT can provide an automatic sequential display of information messages on command from the device (see “Chapter 37 -> Command area”).

VT170W alarms

The first page has the following format:

- Numerical identification of the ISA-1A alarm.
- Two rows of 20 characters for the text of the message.
- One row for any data field (which in that particular situation could indicate a safety or warning limit value).
- Indication in the bottom right-hand corner of the display of:
 - Event appeared but not acknowledged; indicated by [!]
 - Event appeared, present and acknowledged; indicated by [*]
 - Event disappeared and not acknowledged; indicated by[#]

The second page has the following format:

- Numerical identification of the ISA-1A alarm.
- One row starting with the character [>] for the date and time of the appearance of the event (Event appears).
- One row starting with:
 - the character [#] for the date and time of the Event acknowledged but still present.
 - the character [<] for the date and time of the Event disappeared but not acknowledged.

Example with two alarms.

```
Alarm n. 420
Pressure over the
maximum limit
150.0 !
```

First page of the first alarm

The character [!] indicates that the alarm has not yet been acknowledged.

The acknowledgment operation, pressing , changes the character signalling the status of the event to [*]:



```
Alarm n. 420
Pressure over the
maximum limit
150.0 *
```

First page of the first alarm

When you press  the second page appears:

```
Alarm n. 420
>01-07-1998 11:32a
#01-07-1998 11:38a
```

Second page of the first alarm

When you press  or  the first page is appears again; by pressing  again you quit display mode for the ISA-1A alarms.

If, while displaying the first page of the alarm, you pressing , the next alarm message appears:

```
Alarm n. 470
Water level lower
than stop threshold
10 #
```

First page of the second alarm

When you press  the second page appears:

```
Alarm n. 470
>01-07-1998 11:32a
<01-07-1998 11:37a
```

Second page of the second alarm

The character [<] followed by the date and time, indicates that the event triggering the alarm disappeared before the acknowledgment operation.

VT190W alarms

The first page has the following format:

- Numerical identification of the ISA-1A alarm.
- Two rows of 40 characters for the text of the message.
- One row for any data field (which in that particular situation could indicate a safety or warning limit value).
- Indication in the bottom right-hand corner of the display of:
 - Event in but not acknowledged; indicated by [!]
 - Event in, present and acknowledged; indicated by [*]
 - Event out and not acknowledged; indicated by [#]

The second page has the following format:

- Numerical identification of the ISA-1A alarm.
- One row starting with the character [>] for the date and time of the appearance of the event (Event in).
- One row starting with:
 - the character [#] for the date and time of the Event acknowledged but still present.
 - the character [<] for the date and time of the Event out but not acknowledged.

Example with two alarms.

```
Alarm n. 420
The pressure in the tank exceeds
the maximum limit
150.0
```

First page of the first alarm

If character [!] indicates that the alarm has not yet been acknowledged; this is emphasized by the LED of  flashing; by pressing this key, the alarm is acknowledged and the character indicating the status of the event changes to [*] and the LED goes out.



```
Alarm n. 420
The pressure in the tank exceeds
the maximum limit
150.0 *
```

First page of the first alarm

When you press  the second page appears:

```
Alarm n. 420
>01-07-1998 11:32a
#01-07-1998 11:38a
```

Second page of the first alarm

When you press  or , the first page appears again; by pressing  again you quit display mode of the ISA-1A alarms.

If, while displaying the first page of the alarm, you press , the next alarm message appears

```
Alarm n. 470
Water level is lower than
the threshold stopping the process
10 #
```

First page of the second alarm

When you press  the second page appears:

```
Alarm n. 420
>01-07-1998 11:32a
<01-07-1998 11:37a
```



Second page of the second alarm

The character [`<`] followed by the date and time, indicates that the event triggering the alarm disappeared before the acknowledgment operation.

VT300W - VT310W - VT320W alarms

The page has the following format:



- Numerical identification of the ISA-1A alarm.
- Four rows of 30 characters with character height of X1 or two rows of 15 with character height of X2 for the text of the message (VT300 - VT310W).
- Four rows of 36 characters with character height of X1 or two rows of 18 with character height of X2 for the text of the message (VT320W).
- One row for any data field (which in that particular situation could indicate a safety or warning limit value).
- One row starting with the character [`>`] for the date and time of the appearance of the event.

- One row starting with:
 - the character [#] for the date and time of the Event acknowledged but still present.
 - the character [<] for the date and time of the Event out but not acknowledged.
- Symbols indicating status of the alarm
 - Event in but not acknowledged []
 - Event appeared, present and acknowledged []
 - Event out and not acknowledged []

Example with three alarms (VT300W).



	The pressure in the tank is over the max. limit	
0001	150.0 >01-07-1998 11:32a	HELP PgDn

First alarm

When you press  +  the second page appears containing the second alarm. Note that the second alarm is accompanied by the character [<] followed by the date and time, indicating that the event triggering the alarm disappeared before the acknowledgment operation. All this is also emphasized by the appropriate symbol.



	Water level is lower than the threshold for stopping the process	PgUp
0032	10 >01-07-1998 11:32a <01-07-1998 11:37a	HELP PgDn



Second alarm

When you press  +  the next page appears containing the third alarm. Note that the second alarm is accompanied by the character [#] followed by the date and time, indicating that the event triggering the alarm is present and acknowledged. All this is also emphasized by the appropriate symbol.

	Temperature over the safety limit	PgUp
0006	1600 >01-07-1998 12:28p #01-07-1998 12:29p	HELP



Third alarm

When you press  +  the previous page appears again.
Example with three alarms (VT310W and VT320W).

	The pressure in the tank is over the maximum limit		
0001	150.0 >01-07-1998 11:32a	HELP	Up
	Water level is lower than the threshold stopping the process		Down
0032	10 >01-07-1998 11:32a <01-07-1998 11:37a	HELP	PgDn



First alarm
Second alarm

When you press  you select the second alarm as the current alarm. Note that the second alarm is accompanied by the character [**<**] followed by the date and time, indicating that the event triggering the alarm disappeared before the acknowledgment operation. All this is also emphasized by the appropriate symbol.



	The pressure in the tank is over the maximum limit		
0001	150.0 >01-07-1998 11:32a	HELP	Up
	Water level lower than the threshold for stopping the process		Down
0032	10 >01-07-1998 11:32a <01-07-1998 11:37a	HELP	PgDn



First alarm
Second alarm

When you press  again you select the third alarm as the current alarm.

	Water level lower than the threshold for stopping the process		PgUp
0032	10 >01-07-1998 11:32a <01-07-1998 11:37a	HELP	Up
	Temperature over the safety limit		Down
0006	1600 >01-07-1998 12:28p #01-07-1998 12:29p	HELP	



Second alarm
Third alarm

When you press  +  the previous page appears containing the first and second alarms. Note that the second alarm is accompanied by the character [#] followed by the date and time, indicating that the event triggering the alarm is present and acknowledged. All this is also emphasized by the appropriate symbol.



 0001	<p>The pressure in the tank is over the maximum limit</p> <p>150.0</p> <p>>01-07-1998 11:32a</p> <p>HELP</p>	<p>Up</p>	<p>First alarm</p>
 0032	<p>Water level is lower than the threshold stopping the process</p> <p>10</p> <p>>01-07-1998 11:32a</p> <p><01-07-1998 11:37a</p> <p>HELP</p>	<p>Down</p> <p>PgDn</p>	

VT330W alarms

The page has the following format:

- Numeric identification of the ISA-1A alarm.
- Four rows of 70 characters of x1 dimension or alternatively two rows of 35 double-size (x2) characters for the message text.
- One row for any data field (which in that particular situation could indicate a safety or warning limit value).
- One row starting with the character [>] for the date and time of the appearance of the event (Event in).
- One row starting with:
 - the character [#] for the date and time of the Event acknowledged but still present.
 - the character [<] for the date and time of the Event out but not acknowledged.
- Graphic indication of the status of the alarm:
 - Event in and not acknowledged []
 - Event in, present and acknowledged []
 - Event out and not acknowledged. []

Example with five alarms:

	Pressure in tank is over safety limit	First alarm
0001	150.0 >01-07-1998 11:32a	
	Water level is lower than stop threshold of the process	Second alarm
0032	10 >01-07-1998 11:32a <01-07-1998 11:37a	
	Temperature over safety limit	Third alarm
0006	1600 >01-07-1998 12:28p #01-07-1998 12:29p	





When you press  you select the second alarm as the current alarm. Note that the second alarm is accompanied by the character [**<**] followed by the date and time, indicating that the triggering event of the alarm disappeared before being acknowledged. The situation as a whole is highlighted by the appropriate alarm status symbol. Third alarm is accompanied by the character [**#**] followed by the date and time, indicating that the triggering event of the alarm is present and has been acknowledged. The situation as a whole is highlighted by the appropriate alarm status symbol.

ISA-1A alarm history buffer

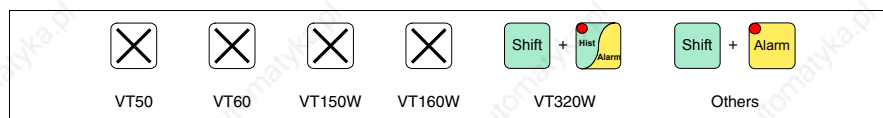
When an event occurs to which an alarm has been assigned the terminal registers it chronologically in an area of the internal memory called the *Alarm history buffer*. If, while displaying the first page of the alarm, you press , or at any point



you enter display mode, signaled by the fixed light LED of that  coming on.

When you press  again you enter the second page whose format is set out below (valid only for VT170W and VT190W).

The VT can provide an automatic sequential display of information messages on command from the device (see “Chapter 37 -> Command area”).

The buffer of the *Alarm history* can be emptied (the elimination of all the messages registered) only by means of a command from the device (see

“Chapter 37 -> Command area“).

 **Once the buffer is full, new alarms are no longer registered. You are advised to consult the chapter *Status area of the VT* “Chapter 37 -> Status area for the terminal“ (see also *Software Manual*) to be able to tell when the buffer is full.**

The format is similar to that of the alarms except that a character [H] is added in front of the number of the alarm (see the formats of the various products).

VT170W history buffer

Example with two alarms.



```
H - Alarm n. 420
Pressure over the
maximum limit
150.0
```

First page of history buffer of the first alarm

When you press  the second page appears:

```
H - Alarm n. 420
>01-07-1998 11:32a
#01-07-1998 11:38a
<01-07-1998 11:52a
```

Second page of history buffer of the first alarm

When you press  or  the first page appears again; by pressing  again you quit the display mode for the history buffer.

If, while displaying the first page of the history buffer, you press  the next message is displayed:

```
H - Alarm n. 470
Water level lower
than stop threshold
10
```

First page of history buffer of the second alarm

When you press  the second page appears:

```
H - Alarm n. 470
>01-07-1998 11:32a
#01-07-1998 11:47a
<01-07-1998 11:37a
```

Second page of the second alarm

VT190W history buffer

Example with two alarms.



```
H - Alarm n. 420
Pressure in the tank exceeds
the maximum limit
150.0
```

First page of the history buffer of the first alarm

When you press  the second page appears:

```
H - Alarm n. 420
>01-07-1998 11:32a
#01-07-1998 11:38a
<01-07-1998 11:52a
```

Second page of the history buffer of the first alarm

When you press  or  the first page is appears again; by pressing  again you quit display mode of the history buffer.

If, while displaying the first page, you press , the next history buffer is displayed:

```
H - Alarm n. 470
Water level lower than
threshold stopping process
10
```

First page of the history buffer of the second alarm

When you press  the second page appears:

```
H - Alarm n. 470
>01-07-1998 11:32a
#01-07-1998 11:47a
<01-07-1998 11:37a
```



Second page of the history buffer of the second alarm

VT300W - VT310W - VT320W history buffer

Example with three alarms VT300W.

H	Pressure in the tank over maximum limit	
0001	150.0 >01-07-1998 11:32a <01-07-1998 11:33a #01-07-1998 11:55a	

First
alarm

When you press  +  the next page appears containing the following alarm:

H 0032	Water level is lower than the threshold stopping the process 10 >01-07-1998 11:32a <01-07-1998 11:37a #01-07-1998 11:40a	PgUp	First alarm
		Up	
H 0006	Temperature over the safety limit 1600 >01-07-1998 12:28p <01-07-1998 12:29p #01-07-1998 12:29p	Down	Second alarm
		PgDn	

When you press  +  the previous page now appears containing the first and second alarms:

H 0001	Pressure in the tank is over maximum limit 150.0 >01-07-1998 11:32a <01-07-1998 11:33a #01-07-1998 11:55a		First alarm
		Up	
H 0032	Water level is lower than the threshold for stopping the process 10 >01-07-1998 11:32a <01-07-1998 11:37a #01-07-1998 11:40a	Down	Second alarm
		PgDn	

When you press  you quit display mode for the history buffer.

VT330W history buffer

Example with three alarms.

H 0001	Pressure in the tank is over the safety limit 150.0 >01-07-1998 11:32a <01-07-1998 11:33a #01-07-1998 11:35a		First alarm
H 0032	Water level below the threshold level stopping the processo 10 >01-07-1998 11:32a <01-07-1998 11:37a #01-07-1998 11:40a		Second alarm
H 0006	Temperature over safety limit 1600 >01-07-1998 12:28p <01-07-1998 12:29p #01-07-1998 12:29p		Third alarm

When you press  you quit display mode for the history buffer.

Help messages

When there is a help message the LED of the following keys flashes

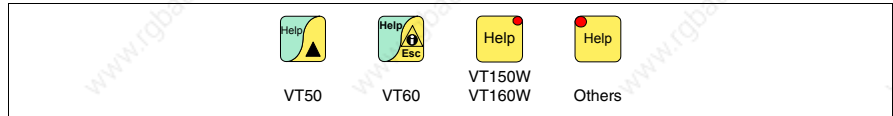

 **Terminals VT50 and VT60 have no LEDs, so there is no way of knowing when a help message is present.**

Help messages can be assigned to project pages, to information messages and to ISA alarms, giving additional information relevant to the operation underway. Help messages have no particular format and can be freely created by the programmer using the entire screen.

When you press

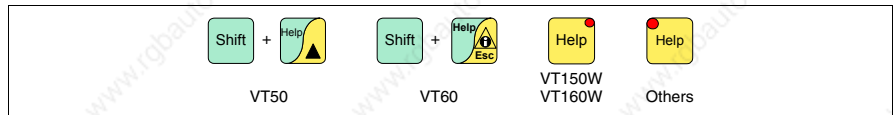

you enter display mode, indicated by the fixed light of the LED (in the case of those terminals that have it). When you press

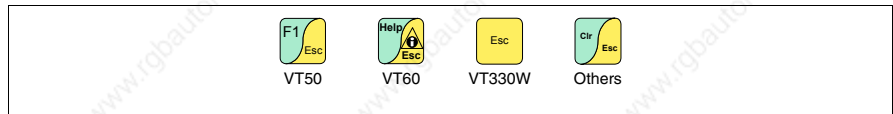

you quit display mode for help messages and return to the previous display mode.

Chapter 36 Operation of terminal with touch screen

Contents	Page
Changing value of variable field	36-2
Total change	36-3
Partial change	36-3
Examples of varying fields	36-3
Displaying messages	36-19
Information messages	36-19
VT5xxH - VT1x5/505/515/525/555/56xW info-msgs	36-20
Vertical VT1x5W info-messages	36-21
VT575W - VT580W- VT585W - VT585WB info-messages	36-22
VT595W info-messages	36-24
ISA-1A alarms	36-24
VT525H - VT1x5/515/525/555/56xW alarms	36-25
Vertical VT1x5W alarms	36-27
VT575W - VT580W - VT585W - VT585WB alarms	36-29
VT595W alarms	36-30
ISA-1A alarm history buffer	36-31
VT525H - VT1x5/515/525/555/56xW history buffer	36-32
Vertical VT1x5W history buffer	36-32
VT575W - VT580W - VT585W - VT585WB history buffer	36-33
VT595W history buffer	36-33
Help messages	36-33
Help and information messages relating to alarms	36-34
Help messages relating to project pages	36-35

This chapter consists of 36 pages.

The contents of this chapter apply to all the VT terminals of the same family that have a touch screen.

! Throughout the present chapter, when referring to the number of rows and the number of characters that can be used in the terminal, we assume native fonts are being used; when Windows-based fonts are used (in the case of graphics terminals only), the equivalent screen area in pixels should be considered (see Software Manual “Chapter 6 -> Project language”).

Changing value of variable field

To be able to carry out a change in any editable variable field you must touch the chosen field on the display and a page appears offering the  needed to modify the field.

The edit mode is quit by pressing the appropriate  (see “Table 36.1, Chapter 36 -> Keys displayed used for settings .”) after setting the value, or automatically when the “input timeout” (see Software Manual) elapses, whereby the variation is quit.

Table 36.1: Keys displayed used for settings (Part 1 of 2).





Keys	Function
	The function assumed depends on the type of field to be set. Increases/decreases the value, the digit, the character.
	The function assumed depends on the type of field to be set. Increases/decreases the value, the digit, the character.
	The function assumed depends on the type of field to be set. Increases/decreases the value. Allows you to move between digits or characters of the field.
	The function assumed depends on the type of field to be set. Increases/decreases the value. Allows you to move between digits or characters of the field
	Confirms the setting of a field. (For the sake of simplicity called Enter)
ESC	Quits the setting of a field.
+/-	Changes the sign when the field permits.
.	Inserts the decimal point when the field permits.
0..9/a	Numerical and alphanumeric keys.

Table 36.1: Keys displayed used for settings (Part 2 of 2).

Keys	Function
SHIFT	In the case of an alphanumeric key allows the letter to be inserted.

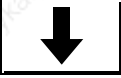
The VT offers the following ways of changing a field:

- Total change
- Partial change

Total change

This is the default mode adopted by the VT when enabling a change in a numerical field.

Numerical fields:

The cursor flashes on the rightmost digit of the field. When the first digit is introduced the rest of the field goes to zero, while the successive introductions make the digits shift to the left.

Partial change

With the edit mode enabled, the change of the individual digit or character being pointed to by the cursor is enabled by pressing the arrow  and then entering a digit, or by means of increasing the character (see “Table 36.1, Chapter 36 -> Keys displayed used for settings .”). To change the adjacent digits or characters the cursor has to be positioned manually.

Examples of varying fields

The examples below are offered to clarify how this works. For the sake of simplicity we have chosen a single product, VT555W, but conceptually what is said applies to all the products of the same family.

Changing the value of a decimal numerical field:

The following example demonstrates the variation (total change) of field 1 from 9999 to -1234.

Sample page

Field 1 9999

Touch the display field [9999]

9999

0	1	2	3	ESC
.	4	5	6	←
+/-	7	8	9	↶

Edit mode is enabled; the cursor moves to the right-most digit of the data (least significant digit).

0001

0	1	2	3	ESC
.	4	5	6	←
+/-	7	8	9	↶

Press the  [1] to enter the first digit of the new value; the field assumes the value 1.

-1234				
0	1	2	3	ESC
.	4	5	6	←
+/-	7	8	9	↶

Press [2] [3] [4] to complete the entering of the new value; press [+/-] to attribute a sign and Enter to confirm.

Changing the value of a floating point numerical field:

The procedure for changing a floating point numerical field is as for a decimal numerical field, except that a decimal point can be inserted anywhere in the field. The following example shows a variation (total change) in field 2 from 10.3256 to 321.65.

Sample page
Field 2 10.3256

Touch the display field [10.3256]

10.3256

0	1	2	3	ESC
.	4	5	6	←
+/-	7	8	9	↶

Edit mode is enabled; the cursor moves to the right-most digit of the data (least significant digit).

000003

0	1	2	3	ESC
.	4	5	6	←
+/-	7	8	9	↶

Press the  [3] to enter the first digit of the new value; the field assumes the value 3.

0000321

0	1	2	3	ESC
.	4	5	6	←
+/-	7	8	9	↶

Press [2] and then [1] to complete the whole field.

000321_				
0	1	2	3	ESC
.	4	5	6	←
+/-	7	8	9	↵

Press [.] to insert the decimal point.

0321.65				
0	1	2	3	ESC
.	4	5	6	←
+/-	7	8	9	↵

Press [6] and then [5] to complete the entering of the new value; press Enter to confirm the variation.

Changing the value of a hexadecimal numerical field:

A hexadecimal digit can assume not only numerical values from 0 to 9 but also the letters A-B-C-D-E-F; thus for this type of field the numerical 0 and 1 can be used to enter the letters A-B-C and D-E-F respectively by pressing the same key more than once. All the other from 2 to 9 have only a numerical significance. The following example illustrates the variation (total change mode) of field 3 from 1A3F to B23C.

Sample page

Field 3 1A3F

Touch the display field [1A3F]

1A3F

0	1/a	2/b	3/c	ESC
	4/d	5/e	6/f	←
SHIFT	7	8	9	↵

Edit mode is enabled; the cursor moves to the rightmost digit of the data (least significant digit).

000B

0	1/a	2/b	3/c	ESC
	4/d	5/e	6/f	←
SHIFT	7	8	9	↵

Press [SHIFT] + [2/b] to enter the first digit of the new value.

B23C				
0	1/a	2/b	3/c	ESC
	4/d	5/e	6/f	←
SHIFT	7	8	9	↶

Press [2/b] [3/c] and [SHIFT] + [3/c] to complete the entering of the new value; press Enter to confirm.

The following example shows the variation (partial change) of Field 3 from B23C to BABA.

Sample page
Field 3 B23C

Touch the display field [B23C]

B23C				
0	1/a	2/b	3/c	ESC
	4/d	5/e	6/f	←
SHIFT	7	8	9	↶

Edit mode is enabled; the cursor moves to the right-most digit of the data (least significant digit).

B23C				
0	1/a	2/b	3/c	ESC
	4/d	5/e	6/f	←
SHIFT	7	8	9	↶

Position the cursor on the second digit by pressing the  [\leftarrow] twice.

BA3C				
0	1/a	2/b	3/c	ESC
	4/d	5/e	6/f	←
SHIFT	7	8	9	↶

Press [SHIFT] + [1/a] to enter the digit of the new value.

BABC				
0	1/a	2/b	3/c	ESC
	4/d	5/e	6/f	←
SHIFT	7	8	9	↵

Press [SHIFT] + [2/b] to enter the third digit of the new value.

BABA				
0	1/a	2/b	3/c	ESC
	4/d	5/e	6/f	←
SHIFT	7	8	9	↵

Press [SHIFT] + [1/a] to enter the last digit of the new value; press Enter to confirm the value.

Varying the value of alphanumeric (ASCII) field:

The following example shows the changing of Field 4 from MOTOR 1 to VALVE 3.5.

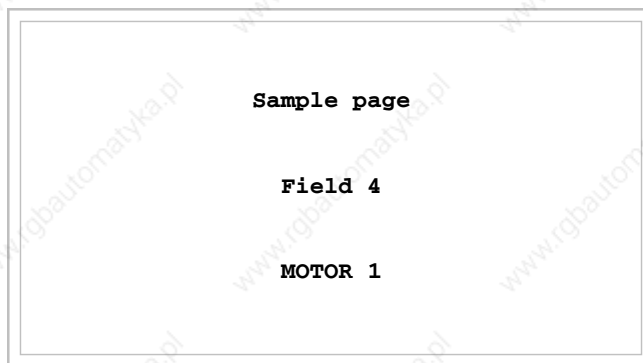

Touch the display field [MOTOR 1]

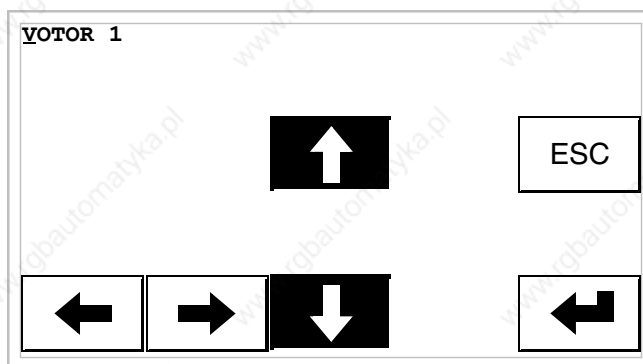

Press [↑] or [↓] to poll all the characters of the table of the font assigned (see Software Manual); halt at the character [V].

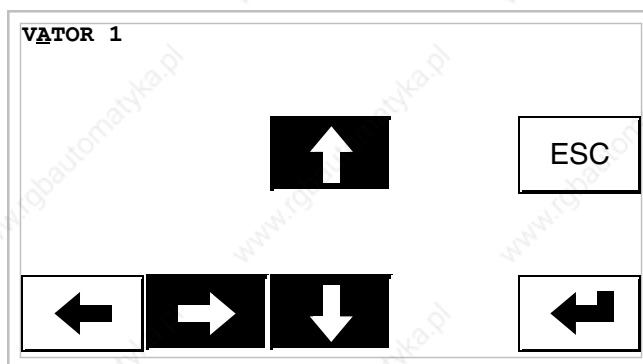

Press [->] to move to the next character, then press [↑] or [↓] to poll all the characters until reaching the character [A].

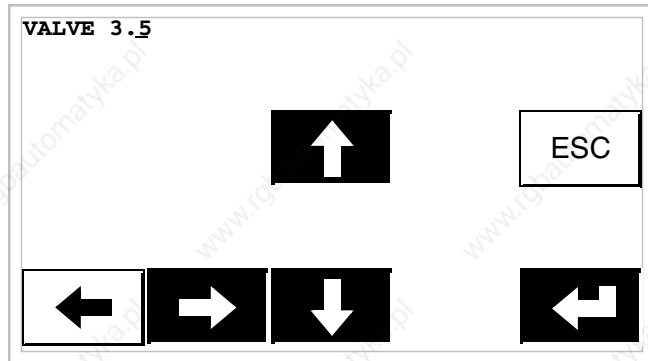

Repeat the operations until the word is finished;
press Enter to confirm.

Changing the value of a dynamic text field:

The following example illustrates the variation of field 5 that can assume 4 different states to which the following 4 symbolic texts correspond: SETUP, STOP, MANUAL, AUTOMATIC.

Let us assume that SETUP is the starting value and MANUAL the final one.



Touch the display field [SETUP]

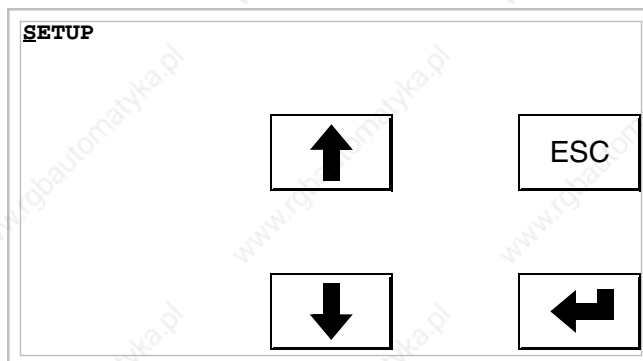

Edit mode is enabled; the cursor moves to the leftmost digit of the data.

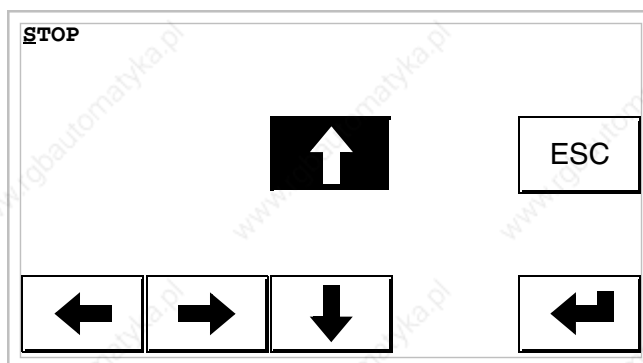

The first time [↑] is pressed the field assumes the value STOP.

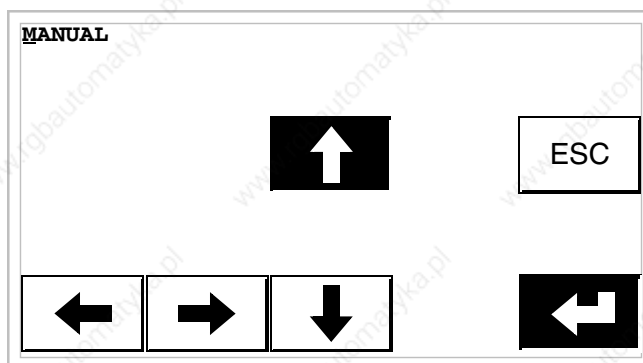

The next time [↑] is pressed the field assumes the value MANUAL; press Enter to confirm.

Changing the value of a symbolic field:

The following example shows the variation of Field 6 that can assume 4 different states to which are assigned the following 4 images:



Let us assume as a starting value ▲ and as a final value ▼

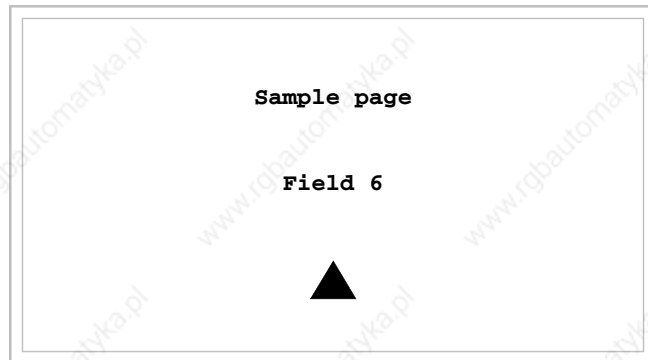

Touch the display field [▲]

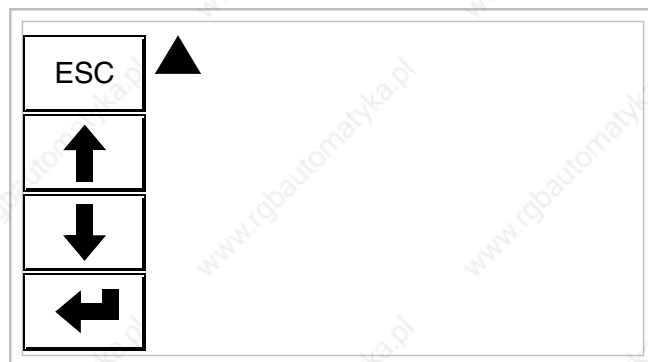

Edit mode is enabled.

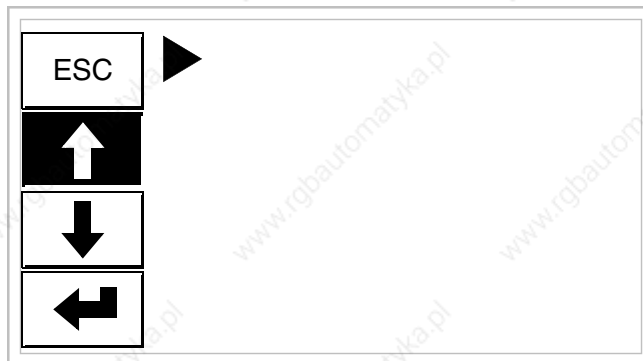

The first time [▲] is pressed the field assumes the value ►.

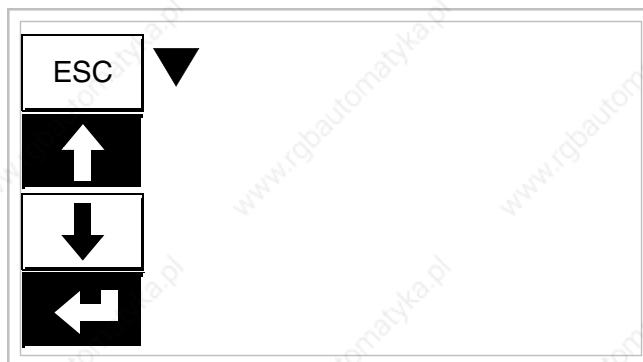

The next time [▲] is pressed the field assumes the value ▼; press Enter to confirm.

Varying the value of a binary field:

The following example illustrates the variation (total change) of Field 7 from 1010 to 1111.



Touch the display field [1010]

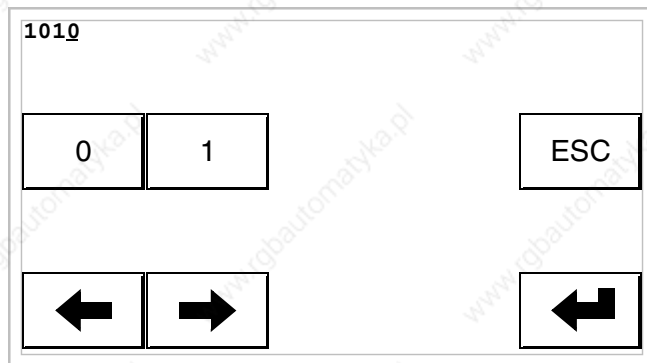

Edit mode is enabled; the cursor moves to the right-most digit of the data (least significant digit).

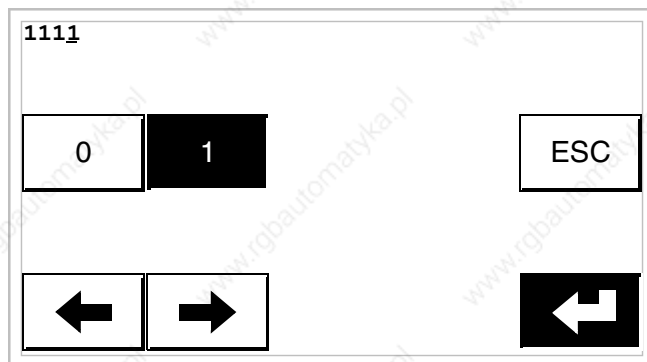

Press [1] 4 times to enter the new value; press Enter to confirm.

Changing the value of a bar data:

The following example illustrates the variation of Field 8 that is to be changed from a value of 100 to a value of 50.

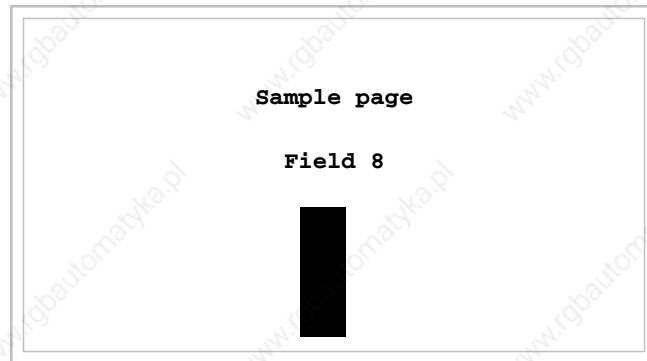

Touch the display field [BAR]

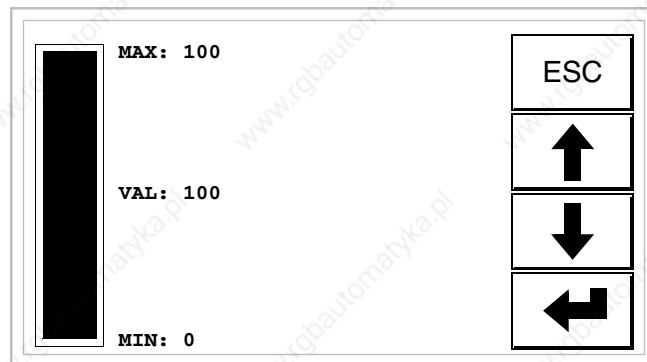

Edit mode is enabled.

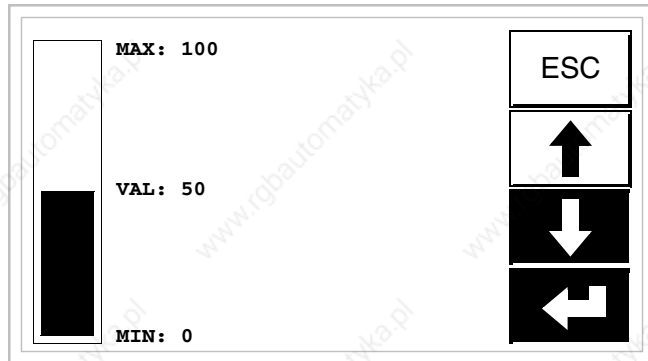

Press [v] to vary the value; take it to 50; press Enter to confirm.

Displaying messages

The VT can display three types of message: *Information messages*, *ISA-1A Alarms* (in the case of terminals accepting them) and *Help messages* (HELP pages). The information and alarm messages can only be displayed if, using VTWIN, the programmer has already prepared the list of messages assigned to areas of memory in the device.

Which type of message is used is at the discretion of the programmer.

Information messages

When an event occurs which has an information message assigned to it the display shows

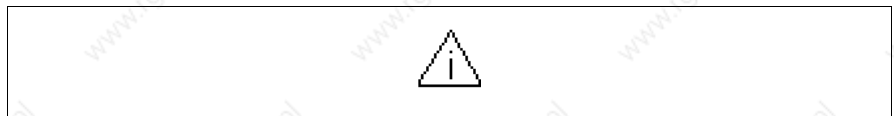

! Note that the symbol is a triangle containing the character [i].

Information messages are only displayable so long as the event triggering them is present. When the above symbol is touched on the screen you enter display mode, where there is a page containing two messages with the following format (the format changes according to the VT).

**Vertical
VT1x5W
info-messages**

Format:

- Five rows of 21 characters with character height of X1 or three rows of 10 with character height of X2 for the text of the message.
- One row for any data field (which in that particular situation could indicate a safety or warning limit value).
- One row for the date and time the signal occurred.
- The first display is indicated by a closed envelope [✉] at the top left of the display. This symbol is not present if the message appeared the last time the display mode for information messages was accessed.

Example with two messages:

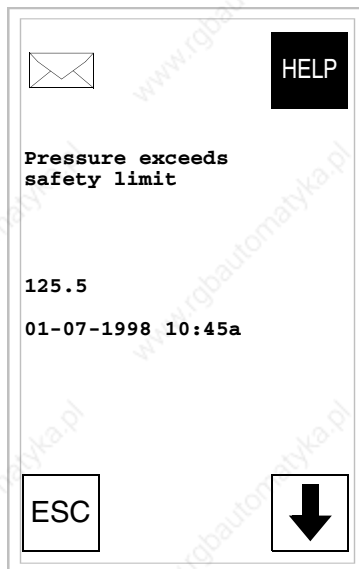

First
message

By pressing [↓] the next page containing the second message appears. NB: having already appeared before, this second message is not accompanied by a closed envelope.

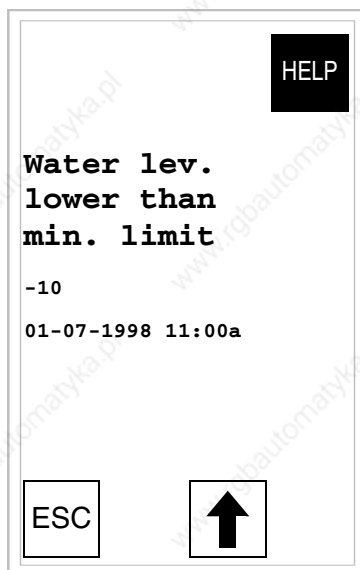

Second message



By pressing [↑] the previous page returns containing the first and first messages.

**VT575W -
VT580W-
VT585W -
VT585WB
info-messages**

Format:

- Four rows of 70 characters x1 high or two rows of 35 characters of double height (x2) for the text of the message.
- One row for any data field (which in that particular situation could indicate a safety or warning limit value).
- One row for the date and time the signal occurred.
- The first display is indicated by a closed envelope [✉] at the top left of the display. This symbol is not present if the message appeared the last time the display mode for information messages was accessed.

Example with five messages:

	Pressure exceeds safety limit 125.5 01-07-1998 10:45a	
	Temperature exceeds safety limit 1700 01-07-1998 10:55a HELP	<input type="button" value="ESC"/>
	Water level below min. -10 01-07-1998 11:00a HELP	
	The level of gas saturation in the boiler room has reached the first warning level 345 01-07-1998 19:00a	<input type="button" value="↓"/>

First message

Second message

Third message

Fourth message

By pressing [↓] the next page containing the fifth message appears.

	Water pump stoppage 01-07-1998 19:45a	<input type="button" value="↑"/>
		<input type="button" value="ESC"/>

Fifth message

By pressing [↑] the previous page returns containing the first four messages.

VT595W info-messages

Format:

- Four rows of 89 characters x1 high or two rows of 44 characters of double height (x2) for the text of the message.
- One row for any data field (which in that particular situation could indicate a safety or warning limit value).
- One row for the date and time the signal occurred.
- The first display is indicated by a closed envelope [✉] at the top left of the display. This symbol is not present if the message appeared the last time the display mode for information messages was accessed.

Example with five messages:

✉	Pressure exceeds safety limit 125.5 01-09-1998 10:45a		First message
	Temperature exceeds safety limit 1700 01-07-1998 10:55a HELP	ESC	Second message
✉	Water level below min. -10 01-07-1998 11:00a HELP		Third message
	The level of gas saturation in the boiler room has reached the first warning level 345 01-07-1998 09:00a		Fourth message
	Water pump stoppage 01-07-1998 10:45a		Fifth message

NB: having already appeared before, the second, fourth and fifth messages are not accompanied by a closed envelope.

ISA-1A alarms

When an event occurs to which an alarm has been assigned the screen shows.



 **Note that the symbol is a triangle containing the character [i].**

ISA alarms are displayed from the time when the event triggering the alarm occurs (Event in) until there is an individual acknowledgment operation - touching the symbol on the screen related to the alarm to be acknowledged (Event acknowledged) - and the triggering event is no longer present (Event out).

By “acknowledgment” we mean the confirmation on the part of the plant or machine operator of having taken note of the alarm message.

For further details on how *ISA-1A Alarms* work see Software Manual.

When the symbol on the screen is touched you enter display mode, where each page contains up to two alarms whose format is set out below.



The VT can provide an automatic sequential display of information messages on command from the device (see “Chapter 37 -> Command area”).

**VT525H -
VT1x5/515/525
/555/56xW
alarms**



The page has the following format:

- Numerical identification of the ISA-1A alarm.
- Four rows of 30 characters with character height of X1 or two rows of 15 with character height of X2 for the text of the message.
- One row for any data field (which in that particular situation could indicate a safety or warning limit value).
- One row starting with the character [>] for the date and time of the appearance of the event (Event in).
- One row starting with:
 - the character [#] for the date and time of the Event acknowledged but still present.
 - the character [<] for the date and time of the Event out but not acknowledged.
- Graphic indication of the status of the alarm:
 - Event in and not acknowledged [▲]
 - Event in, present and acknowledged [▲]
 - Event out and not acknowledged. [▲]

Examples with three alarms:

0001	 The pressure in the tank exceeds the max. limit 150.0 >01-07-1998 11:32a HELP	ESC	First alarm
0032	 Water level is lower than the stop threshold of the process 10 >01-07-1998 11:32a <01-07-1998 11:37a HELP		Second alarm

When you press [↓] the next page appears containing the third alarm. Note that the second alarm is accompanied by the character [<] followed by the date and time, indicating that the event triggering the alarm disappeared before the acknowledgment operation. All this is also emphasized by the appropriate symbol.

0006	 Temperature over the safety limit 1600 >01-07-1998 12:28p #01-07-1998 12:29p HELP		Third alarm

When you press [↑] the first page appears. Note that the third alarm is accompanied by the character [#] followed by the date and time, indicating that the event triggering the alarm is present and acknowledged. All this is also emphasized by the appropriate symbol.

Vertical VT1x5W alarms

The page has the following format:

- Numerical identification of the ISA-1A alarm.
- Five rows of 21 characters with character height of X1 or three rows of 10 with character height of X2 for the text of the message.
- One row for any data field (which in that particular situation could indicate a safety or warning limit value).
- One row starting with the character [>] for the date and time of the appearance of the event (Event in).
- One row starting with:
 - the character [#] for the date and time of the Event acknowledged but still present.
 - the character [<] for the date and time of the Event out but not acknowledged.
- Graphic indication of the status of the alarm:
 - Event in and not acknowledged [▲]
 - Event in, present and acknowledged [▲▲]
 - Event out and not acknowledged. [▲]

Examples with three alarms:

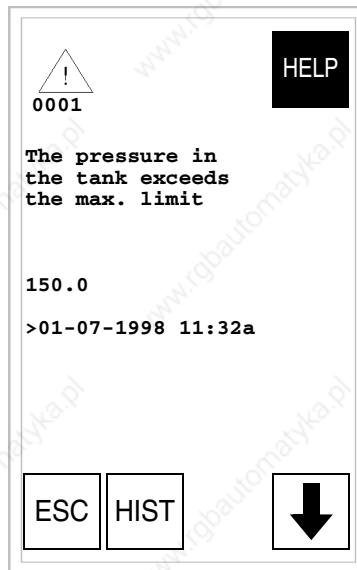

First
alarm

When you press [▼] the next page appears containing the second alarm. Note that the second alarm is accompanied by the character [<] followed by the date and time, indicating that the event triggering the alarm disappeared before the acknowledgment operation. All this is also emphasized by the appropriate symbol.

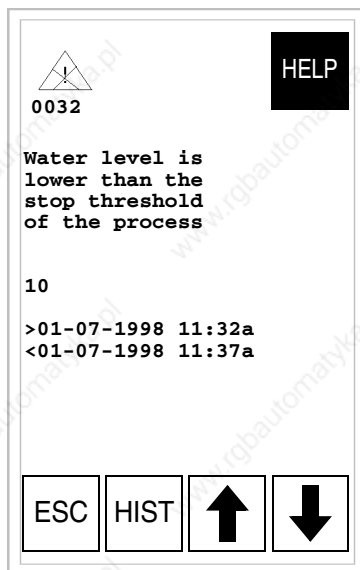

Second alarm

When you press [↑] the first page appears. When you press [↓] the next page appears containing the third alarm. Note that the second alarm is accompanied by the character [<] followed by the date and time, indicating that the event triggering the alarm disappeared before the acknowledgment operation. All this is also emphasized by the appropriate symbol.

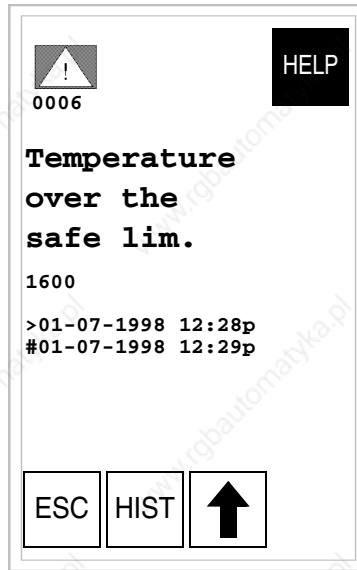

Third
alarm



When you press [] the second page appears.

**VT575W -
VT580W -
VT585W -
VT585WB
alarms**

The page has the following format:

- Numeric identification of the ISA-1A alarm.
- Four rows of 70 characters of x1 dimension or alternatively two rows of 35 double-size (x2) characters for the message text.
- One row for any data field (which in that particular situation could indicate a safety or warning limit value).
- One row starting with the character [>] for the date and time of the appearance of the event (Event in).
- One row starting with:
 - the character [#] for the date and time of the Event acknowledged but still present.
 - the character [<] for the date and time of the Event out but not acknowledged.
- Graphic indication of the status of the alarm:
 - Event in and not acknowledged []
 - Event in, present and acknowledged []
 - Event out and not acknowledged. []

Example with three alarms:

	Pressure in tank is over safety limit		
0001	150.0 >01-07-1998 11:32a	HELP	
	Water level is lower than stop threshold of the process		ESC
0032	10 >01-07-1998 11:32a <01-07-1998 11:37a	HELP	
	Temperature over safety limit		HIST
0006	1600 >01-07-1998 12:28p #01-07-1998 12:29p	HELP	

First alarm



Second alarm

Third alarm



Note that the second alarm is accompanied by the character [**<**] followed by the date and time, indicating that the triggering event of the alarm disappeared before being acknowledged. The situation as a whole is highlighted by the appropriate alarm status symbol. Third alarm is accompanied by the character [**#**] followed by the date and time, indicating that the triggering event of the alarm is present and has been acknowledged. The situation as a whole is highlighted by the appropriate alarm status symbol.

VT595W alarms

The page has the following format:

- Numeric identification of the ISA-1A alarm.
- Four rows of 89 characters of x1 dimension or alternatively two rows of 44 double-size (x2) characters for the message text.
- One row for any data field (which in that particular situation could indicate a safety or warning limit value).
- One row starting with the character [**>**] for the date and time of the appearance of the event (Event in).
- One row starting with:
 - the character [**#**] for the date and time of the Event acknowledged but still present.
 - the character [**<**] for the date and time of the Event out but not acknowledged.
- Graphic indication of the status of the alarm:
 - Event in and not acknowledged [
 - Event in, present and acknowledged [
 - Event out and not acknowledged. [

Example with three alarms:

	Pressure in tank is over safety limit 0001 150.0 >01-07-1998 11:32a HELP		First alarm
	Water level is lower than stop threshold of the process 0032 10 >01-07-1998 11:32a <01-07-1998 11:37a HELP	ESC	Second alarm
	Temperature over safety limit 0006 1600 >01-07-1998 12:28p #01-07-1998 12:29p HELP		Third alarm

Note that the second alarm is accompanied by the character [`<`] followed by the date and time, indicating that the triggering event of the alarm disappeared before being acknowledged. The situation as a whole is highlighted by the appropriate alarm status symbol. Third alarm is accompanied by the character [`#`] followed by the date and time, indicating that the triggering event of the alarm is present and has been acknowledged. The situation as a whole is highlighted by the appropriate alarm status symbol.

ISA-1A alarm history buffer

When an event occurs to which an alarm has been assigned the terminal registers it chronologically in an area of the internal memory called the *Alarm history buffer*. If, while displaying the alarm page, you touch the  HIST on the screen, you access the history buffer.

The VT can provide an automatic sequential display of information messages on command from the device (see “Chapter 37 -> Command area”).

The buffer of the *Alarm history* can be emptied (the elimination of all the messages registered) only by means of a command from the device (see “Chapter 37 -> Command area”).

 **Once the buffer is full, new alarms are no longer registered. You are advised to consult the chapter *Status area of the VT* “Chapter 37 -> Status area for the terminal” (see also *Software Manual*) to be able to tell when the buffer is full.**

The format is similar to that of the alarms except that a character [H] is added in front of the number of the alarm (see the formats of the various products).

**VT525H -
VT1x5/515/525
/555/56xW
history buffer**

Example with two alarms.

H 0001	Pressure in the tank over the maximum limit 150.0 >01-07-1998 11:32a <01-07-1998 11:33a #01-07-1998 11:55a	ESC	First alarm
H 0032	Water level is lower than the threshold stopping the process 10 >01-07-1998 11:32a <01-07-1998 11:37a #01-07-1998 11:40a		Second alarm

When ESC is pressed you return to the display mode for alarms.

**Vertical
VT1x5W
history buffer**

Example with one alarm.

H 0001 The pressure in the tank exceeds the max. limit 150.0 >01-07-1998 11:32a <01-07-1998 11:33a #01-07-1998 11:55a ESC	First alarm
--	----------------

When ESC is pressed you return to the display mode for alarm.

**VT575W -
VT580W -
VT585W -
VT585WB
history buffer**

Example with three alarms.

H 0001	Pressure in the tank is over the safety limit 150.0 >01-07-1998 11:32a <01-07-1998 11:33a #01-07-1998 11:35a		First alarm
H 0032	Water level below the threshold level stopping the processo 10 >01-07-1998 11:32a <01-07-1998 11:37a #01-07-1998 11:40a	<input type="checkbox"/> ESC	Second alarm
H 0006	Temperature over safety limit 1600 >01-07-1998 12:28p <01-07-1998 12:29p #01-07-1998 12:29p		Third alarm

By pressing the ESC you return to the alarm display.

**VT595W
history buffer**

Example with three alarms.

H 0001	Pressure in tank is over safety limit 150.0 >01-07-1998 11:32a HELP		First alarm
H 0032	Water level is lower than stop threshold of the process 10 >01-07-1998 11:32a <01-07-1998 11:37a HELP	<input type="checkbox"/> ESC	Second alarm
H 0006	Temperature over safety limit 1600 >01-07-1998 12:28p #01-07-1998 12:29p HELP		Third alarm

By pressing the ESC you return to the alarm display.

**Help
messages**

Help messages can be assigned to project pages, to information messages and to ISA alarms, giving additional information relevant to the operation underway. Help messages have no particular format and can be freely created by the programmer using the entire screen.

To explain the way the help messages work, it is necessary to divide them into two categories: on the one hand messages related to alarms and to information messages, on the other hand help messages related to pages.

Help and information messages relating to alarms

If, when you are in a context of displaying alarms or information messages, there is a help message present, the word HELP appears. If you touch the alarm or the message accompanying the word HELP the help message is displayed. Touching the  ESC on the screen takes you back to the previous screenful.

The length of the message can be:

- VT155W -> up to 34 (characters) x 16 (rows)
- VT155W Vertical -> up to 21 (characters) x 24 (rows)
- VT185W -> up to 34 (characters) x 16 (rows)
- VT185W Vertical -> up to 21 (characters) x 24 (rows)
- VT505H -> up to 34 (characters) x 16 (rows)
- VT505W -> up to 34 (characters) x 16 (rows)
- VT515W -> up to 34 (characters) x 16 (rows)
- VT525H -> up to 34 (characters) x 16 (rows)
- VT525W -> up to 34 (characters) x 16 (rows)
- VT555W -> up to 34 (characters) x 16 (rows)
- VT56xW -> up to 34 (characters) x 16 (rows)
- VT575W -> up to 74 (characters) x 16 (rows)
- VT580W -> up to 74 (characters) x 16 (rows)
- VT585W -> up to 74 (characters) x 16 (rows)
- VT585WB -> up to 74 (characters) x 16 (rows)
- VT595W -> up to 93 (characters) x 16 (rows)

Help messages relating to project pages

As far as project pages are concerned, it is the programmer's responsibility to insert the necessary to access the help page (see Software Manual). If this is not done, there will be no way of telling if the page contains a help message.

The length of the message can be:

- VT155W -> up to 34 (characters) x 16 (rows)
- VT155W Vertical -> up to 21 (characters) x 24 (rows)
- VT185W -> up to 34 (characters) x 16 (rows)
- VT185W Vertical -> up to 21 (characters) x 24 (rows)
- VT505H -> up to 34 (characters) x 16 (rows)
- VT505W -> up to 34 (characters) x 16 (rows)
- VT515W -> up to 34 (characters) x 16 (rows)
- VT525H -> up to 40 (characters) x 16 (rows)
- VT525W -> up to 40 (characters) x 16 (rows)
- VT555W -> up to 40 (characters) x 16 (rows)
- VT56xW -> up to 40 (characters) x 16 (rows)
- VT575W -> up to 80 (characters) x 16 (rows)
- VT580W -> up to 80 (characters) x 16 (rows)
- VT585W -> up to 80 (characters) x 16 (rows)
- VT585WB -> up to 80 (characters) x 16 (rows)
- VT595W -> up to 100 (characters) x 16 (rows)

Chapter 37 Data exchange area

Contents	Page
Status area for the terminal	37-3
Status area for internal LEDs	37-8
Status area for external LEDs	37-12
Status area for recipes	37-14
Status area for internal keys	37-15
Status area for external keys	37-23
Status area for internal keys (Real Time)	37-25
Status area for external keys (Real Time)	37-25
Status area for printer	37-26
Status area for trends	37-28
Command response area	37-29
Command area external LEDs (fixed light)	37-30
Command area external LEDs (blinking light)	37-31
Command area internal red LEDs (fixed light)	37-32
Command area internal red LEDs (blinking light)	37-33
Command area internal green LEDs (fixed light)	37-34
Command area internal green LEDs (blinking light)	37-35
Command area	37-36

This chapter consists of 54 pages.

By *Communication* we mean the exchange of information that occurs between the VT and the device connected to it. Information can be exchanged using *Variables* or *Exchange Areas* (see Software Manual for more detailed explanation).

The *Exchange Areas* are divided into:

- Area for Messages:
 - Information messages
 - Alarms
- Status Areas:
 - Status area for the terminal
 - Status area for internal LEDs
 - Status area for external LEDs
 - Status area for recipes
 - Status area for internal keys
 - Status area for external keys
 - Status area for internal keys (Real Time)
 - Status area for external keys (Real Time)
 - Status area for printer
 - Trend status area
 - Command response area
- Command Areas
 - Command area external LEDs (fixed light)
 - Command area external LEDs (blinking light)
 - Command area internal red LEDs (fixed light)
 - Command area internal red LEDs (blinking light)
 - Command area internal green LEDs (fixed light)
 - Command area internal green LEDs (blinking light)
 - Area for Commands

As the *Area for Messages* does not depend on the type of VT, but is completely configurable using VTWIN, it will no longer be mentioned in this chapter.



For the detailed meaning of the various areas see Software Manual.

Status area for the terminal

The significance of this area depends on the type of VT used:

- With a keyboard
- With a touch screen.

This area consists of 4 fixed words (numbered from 0 to 3).

- With a keyboard:

NO. OF WORD	NAME OF WORD
0	STATUS WORD
1	SEQUENCE IDENTIFIER
2	PAGE IDENTIFIER
3	FIELD IDENTIFIER

- With a touch screen:

NO. OF WORD	NAME OF WORD
0	STATUS WORD
1	--
2	PAGE IDENTIFIER
3	CONTEXT IDENTIFIER

-- : not used

The tables appearing below refer to VTs with a keyboard.

- 37.1: Meaning of bits of Word 0 - Status word
- 37.2: Meaning of value contained in the Word 1 - Sequence Identifier
- 37.3: Meaning of value contained in the Word 2 - Page Identifier
- 37.4: Meaning of value contained in the Word 3 - Field Identifier

The tables appearing below refer to VTs with a touch screen.

- 37.5: Meaning of bits of Word 0 - Status word
- 37.6: Meaning of value contained in the Word 1
- 37.7: Meaning of value contained in the Word 2 - Page Identifier
- 37.8: Meaning of value contained in the Word 3 - Context Identifier

Table 37.1: Meaning of bits of Word 0 - Status word

WORD 0 MEANING OF THE BIT	BIT NUMBER																
	VT 50	VT 60	VT 150 W	VT 160 W	VT 170 W	VT 190 W	VT 300 W	VT 310 W	VT 320 W	VT 330 W							
WATCHDOG Always at Status1	0	0	0	0	0	0	0	0	0	0							
EDIT MODE Status 1 when il terminal is in mode for changing fields	1	1	1	1	1	1	1	1	1	1							
MESSAGES PRESENT Status 1 so long as there is a message to display	2	2	2	2	--	--	--	--	--	--							
MESSAGE PENDING Status 1 so long as there is a message "in" but not yet consulted	3	3	3	3	--	--	--	--	--	--							
ISA ALARM MESSAGES PRESENT Status 1 so long as there is an alarm message to display	--	--	--	--	2	2	2	2	2	2							
ISA ALARM MESSAGES PENDING Status 1 so long as there is an ISA alarm "in" but not yet acknowledged	--	--	--	--	3	3	3	3	3	3							
COMMAND NOT VALID Status 1 when the last command sent by the device has not been carried out	4	4	4	4	4	4	4	4	4	4							
ALARM HISTORY BUFFER 80% FULL Status 1 when the alarm history buffer is 80% full and therefore close to saturation	--	--	--	--	5	5	5	5	5	5							
ALARM HISTORY BUFFER FULL Status 1 when the alarm history buffer is full and can hold no more alarms	--	--	--	--	6	6	6	6	6	6							
MACRO FUNCTION ACTIVE Status 1 when the VT is processing a macro function	--	--	7	7	7	7	7	7	7	7							
BATTERY FLAT Status 1 when the battery is near its minimum level for maintaining the data in the RAM memory	--	--	--	--	8	8	8	8	8	8							

-- : not present

Table 37.2: Meaning of value contained in the Word 1 - Sequence Identifier

WORD 1 MEANING OF THE VALUE	USED																
	VT 50	VT 60	VT 150 W	VT 160 W	VT 170 W	VT 190 W	VT 300 W	VT 310 W	VT 320 W	VT 330 W							
SEQUENCE IDENTIFIER Contains a value other than zero if in Project Page context, but contains zero if in any other context	●	●	●	●	●	●	●	●	●	●							

Table 37.3: Meaning of value contained in the Word 2 - Page Identifier

WORD 2 MEANING OF THE VALUE	USED / VALUE CONTAINED													
	VT 50	VT 60	VT 150 W	VT 160 W	VT 170 W	VT 190 W	VT 300 W	VT 310 W	VT 320 W	VT 330 W				
NUMBER OF PAGE BEING DISPLAYED In Project Page context contains the value of the page being displayed, while contains the identifying value of the context if in another context (Word 1 = 0)	●	●	●	●	●	●	●	●	●	●				
INFORMATION MESSAGES	0	0	0	0	0	0	0	0	0	0				
SEQUENCE DIRECTORY	1	1	1	1	1	1	1	1	1	1				
PAGE DIRECTORY	--	--	--	--	--	--	--	--	--	--				
DRIVER SERVICE PAGES	2	2	2	2	2	2	2	2	2	2				
HELP MESSAGES FOR PROJECT PAGES	--	--	3	3	3	3	3	3	3	3				
HELP MESSAGES FOR ISA ALARMS	--	--	--	--	4	4	4	4	4	4				
ISA ALARMS	--	--	--	--	5	5	5	5	5	5				
RECIPE DIRECTORY	--	--	--	--	6	6	6	6	6	6				
HELP MESSAGES FOR INFORMATION MESSAGES	--	--	7	7	7	7	7	7	7	7				
ALARM HISTORY BUFFER	--	--	--	--	8	8	8	8	8	8				
PROJECT INFORMATION	3	3	--	--	9	9	--	--	--	--				
SETTING CLOCK	--	--	--	--	10	10	--	--	--	--				
SYSTEM MESSAGES ASSIGNED TO RECIPES	--	--	--	--	11	11	--	--	--	--				
SYSTEM MESSAGES ASSIGNED TO PASSWORDS	--	--	--	--	12	12	--	--	--	--				

-- : not present

Table 37.4: Meaning of value contained in the Word 3 - Field Identifier

WORD 3 MEANING OF THE VALUE	USED													
	VT 50	VT 60	VT 150 W	VT 160 W	VT 170 W	VT 190 W	VT 300 W	VT 310 W	VT 320 W	VT 330 W				
POSITION OF THE CURSOR Contains a value identifying the field where the cursor is located when in Project Page context, while containing 0 if in any other context	●	●	●	●	●	●	●	●	●	●				

Table 37.5: Meaning of bits of Word 0 - Status word

WORD 0 MEANING OF THE BIT	BIT NUMBER																
	VT 155 W	VT 185 W	VT 505 H	VT 505 W	VT 515 W	VT 525 H	VT 525 W	VT 555 W	VT 56x W	VT 575 W	VT 580 W	VT 585 W	VT 585 WB	VT 595 W			
WATCHDOG Always at Status1	0	0	0	0	0	0	0	0	0	0	0	0	0	0			
EDIT MODE Status 1 when il terminal is in mode for changing fields	1	1	1	1	1	1	1	1	1	1	1	1	1	1			
MESSAGES PRESENT Status 1 so long as there is a message to display	--	--	--	--	--	--	--	--	--	--	--	--	--	--			
MESSAGE PENDING Status 1 so long as there is a message "in" but not yet consulted	--	--	--	--	--	--	--	--	--	--	--	--	--	--			
ISA ALARM MESSAGES PRESENT Status 1 so long as there is an alarm message to display	2	2	--	--	2	2	2	2	2	2	2	2	2	2			
ISA ALARM MESSAGES PENDING Status 1 so long as there is an ISA alarm "in" but not yet acknowledged	3	3	--	--	3	3	3	3	3	3	3	3	3	3			
COMMAND NOT VALID Status 1 when the last command sent by the device has not been carried out	4	4	4	4	4	4	4	4	4	4	4	4	4	4			
ALARM HISTORY BUFFER 80% FULL Status 1 when the alarm history buffer is 80% full and therefore close to saturation	5	5	--	--	5	5	5	5	5	5	5	5	5	5			
ALARM HISTORY BUFFER FULL Status 1 when the alarm history buffer is full and can hold no more alarms	6	6	--	--	6	6	6	6	6	6	6	6	6	6			
MACRO FUNCTION ACTIVE Status 1 when the VT is processing a macro function	7	7	7	7	7	7	7	7	7	7	7	7	7	7			
BATTERY FLAT Status 1 when the battery is near its minimum level for maintaining the data in the RAM memory	--	--	--	--	--	--	--	8	8	--	--	8	--	--			

-- : not present

Table 37.6: Meaning of value contained in the Word 1

WORD 1 MEANING OF THE VALUE	USED																
	VT 155 W	VT 185 W	VT 505 H	VT 505 W	VT 515 W	VT 525 H	VT 525 W	VT 555 W	VT 56x W	VT 575 W	VT 580 H	VT 585 W	VT 585 WB				
--	--	--	--	--	--	--	--	--	--	--	--	--	--				

-- : not used

Table 37.7: Meaning of value contained in the Word 2 - Page Identifier

WORD 2 MEANING OF THE VALUE	USED																
	VT 155 W	VT 185 W	VT 505 H	VT 505 W	VT 515 W	VT 525 H	VT 525 W	VT 555 W	VT 56x W	VT 575 W	VT 580 W	VT 585 W	VT 585 WB	VT 595 W			
NUMBER OF PAGE BEING DISPLAYED Contains a value other than zero if in Project Page context, but contains zero if in any other context	●	●	●	●	●	●	●	●	●	●	●	●	●	●			

Table 37.8: Meaning of value contained in the Word 3 - Context Identifier

WORD 3 MEANING OF THE VALUE	USED / VALUE CONTAINED																
	VT 155 W	VT 185 W	VT 505 H	VT 505 W	VT 515 W	VT 525 H	VT 525 W	VT 555 W	VT 56x W	VT 575 W	VT 580 W	VT 585 W	VT 585 WB	VT 595 W			
CONTEXT IDENTIFIER Contains the identifying value of the context if the context is not Project Page (Word 2 = 0)	●	●	●	●	●	●	●	●	●	●	●	●	●	●			
INFORMATION MESSAGES	0	0	0	0	0	0	0	0	0	0	0	0	0	0			
SEQUENCE DIRECTORY	--	--	--	--	--	--	--	--	--	--	--	--	--	--			
PAGE DIRECTORY	1	1	1	1	1	1	1	1	1	1	1	1	1	1			
DRIVER SERVICE PAGES	2	2	2	2	2	2	2	2	2	2	2	2	2	2			
HELP MESSAGES FOR PROJECT PAGES	3	3	3	3	3	3	3	3	3	3	3	3	3	3			
HELP MESSAGES FOR ISA ALARMS	4	4	--	--	4	4	4	4	4	4	4	4	4	4			
ISA ALARMS	5	5	--	--	5	5	5	5	5	5	5	5	5	5			
RECIPE DIRECTORY	6	6	6	6	6	6	6	6	6	6	6	6	6	6			
HELP MESSAGES FOR INFORMATION MESSAGES	7	7	7	7	7	7	7	7	7	7	7	7	7	7			
ALARM HISTORY BUFFER	8	8	--	--	8	8	8	8	8	8	8	8	8	8			
PROJECT INFORMATION	--	--	--	--	--	--	--	--	--	--	--	--	--	--			
SETTING CLOCK	--	--	--	--	--	--	--	--	--	--	--	--	--	--			
SYSTEM MESSAGES ASSIGNED TO RECIPES	--	--	--	--	--	--	--	--	--	--	--	--	--	--			
SYSTEM MESSAGES ASSIGNED TO PASSWORDS	--	--	--	--	--	--	--	--	--	--	--	--	--	--			

-- : not present

**Status area for
internal LEDs**

This area consists of a maximum of 4 words (numbered from 0 to 3).

NO. OF WORD	NAME OF WORD
0	STATUS WORD for GREEN LEDS
1	STATUS WORD for GREEN LEDS
2	STATUS WORD for RED LEDS
3	STATUS WORD for RED LEDS

Table 37.9: Meaning of the Bits of the Status Word for the Green LEDs

WORD 0 NUMBER OF THE BIT	MEANING OF THE BIT															
	VT 50	VT 60	VT 150 W	VT 160 W	VT 170 W	VT 190 W	VT 300 W	VT 310 W	VT 320 W	VT 330 W						
0	--	--	F1	F1	F1	F1	F1	F1	F1	--						
1	--	--	F2	F2	F2	F2	F2	F2	F2	--						
2	--	--	F3	F3	F3	F3	F3	F3	F3	--						
3	--	--	F4	F4	F4	F4	F4	F4	F4	--						
4	--	--	F5	F5	F5	F5	F5	F5	F5	--						
5	--	--	--	--	F6	F6	F6	F6	F6	--						
6	--	--	--	--	F7	F7	F7	F7	F7	--						
7	--	--	--	--	F8	F8	F8	F8	F8	--						
8	--	--	--	--	F9	F9	F9	F9	F9	--						
9	--	--	--	--	F10	F10	F10	F10	F10	--						
10	--	--	--	--	F11	F11	F11	F11	F11	--						
11	--	--	--	--	F12	F12	F12	F12	F12	--						
12	--	--	--	--	--	F13	F13	F13	F13	F13						
13	--	--	--	--	--	F14	F14	F14	F14	F14						
14	--	--	--	--	--	F15	F15	F15	F15	F15						
15	--	--	--	--	--	F16	F16	F16	F16	F16						

-- : not present

Table 37.10: Meaning of the Bits of the Status Word for Green LEDs

WORD 1 NUMBER OF THE BIT	MEANING OF THE BIT													
	VT 50	VT 60	VT 150 W	VT 160 W	VT 170 W	VT 190 W	VT 300 W	VT 310 W	VT 320 W	VT 330 W				
0	--	--	--	--	--	F17	F17	F17	F17	F17				
1	--	--	--	--	--	F18	F18	F18	F18	F18				
2	--	--	--	--	--	F19	F19	F19	F19	F19				
3	--	--	--	--	--	F20	F20	F20	F20	F20				
4	--	--	--	--	--	F21	F21	F21	F21	F21				
5	--	--	--	--	--	F22	F22	--	F22	F22				
6	--	--	--	--	--	F23	F23	--	F23	F23				
7	--	--	--	--	--	F24	F24	--	F24	F24				
8	--	--	--	--	--	--	--	--	F25	F25				
9	--	--	--	--	--	--	--	--	F26	F26				
10	--	--	--	--	--	--	--	--	F27	F27				
11	--	--	--	--	--	--	--	--	F28	F28				
12	--	--	--	--	--	--	--	--	--	--				
13	--	--	--	--	--	--	--	--	--	--				
14	--	--	--	--	--	--	--	--	--	--				
15	--	--	--	--	--	--	--	--	--	--				

-- : not present

Table 37.11: Meaning of the Bits of the Status Word for Red LEDs

WORD 2 NUMBER OF THE BIT	MEANING OF THE BIT																				
	VT 50	VT 60	VT 150 W	VT 160 W	VT 170 W	VT 190 W	VT 300 W	VT 310 W	VT 320 W	VT 330 W											
0	--	--	--	--	F1	F1	F1	F1	F1	--											
1	--	--	--	--	F2	F2	F2	F2	F2	--											
2	--	--	--	--	F3	F3	F3	F3	F3	--											
3	--	--	--	--	F4	F4	F4	F4	F4	--											
4	--	--	--	--	F5	F5	F5	F5	F5	--											
5	--	--	--	--	F6	F6	F6	F6	F6	--											
6	--	--	--	--	F7	F7	F7	F7	F7	--											
7	--	--	--	--	F8	F8	F8	F8	F8	--											
8	--	--	--	--	F9	F9	F9	F9	F9	--											
9	--	--	--	--	F10	F10	F10	F10	F10	--											
10	--	--	--	--	F11	F11	F11	F11	F11	--											
11	--	--	--	--	F12	F12	F12	--	F12	--											
12	--	--	--	--	--	F13	F13	--	F13	--											
13	--	--	--	--	--	F14	F14	--	F14	--											
14	--	--	--	--	--	F15	F15	--	F15	--											
15	--	--	--	--	--	F16	F16	--	F16	--											

-- : not present

Table 37.12: Meaning of the Bits of the Status Word for Red LEDs

WORD 3 NUMBER OF THE BIT	MEANING OF THE BIT																		
	VT 50	VT 60	VT 150 W	VT 160 W	VT 170 W	VT 190 W	VT 300 W	VT 310 W	VT 320 W	VT 330 W									
0	--	--	--	--	--	F17	F17	--	F17	--									
1	--	--	--	--	--	F18	F18	--	F18	--									
2	--	--	--	--	--	F19	F19	--	--	--									
3	--	--	--	--	--	F20	F20	--	--	--									
4	--	--	--	--	--	F21	F21	--	--	--									
5	--	--	--	--	--	F22	F22	--	--	--									
6	--	--	--	--	--	--	--	--	--	--									
7	--	--	--	--	--	--	--	--	--	--									
8	--	--	--	--	--	--	--	--	--	--									
9	--	--	--	--	--	--	--	--	--	--									
10	--	--	--	--	--	--	--	--	--	--									
11	--	--	--	--	--	--	--	--	--	--									
12	--	--	--	--	--	--	--	--	--	--									
13	--	--	--	--	--	--	--	--	--	--									
14	--	--	--	--	--	--	--	--	--	--									
15	--	--	--	--	--	--	--	--	--	--									

-- : not present

Status area for external LEDs

This area consists of 2 fixed words (numbered from 0 to 1).

NO. OF WORD	NAME OF WORD
0	STATUS WORD
1	STATUS WORD

Table 37.13: Meaning of the Bits of the Status Word for External LEDs

WORD 0 MEANING OF THE BIT	NUMBER OF THE BIT			
	VT150W + VT100MT1000	VT160W	VT300W - VT310W - VT320W + VT100MT1000	
E1	0	0	0	
E2	1	1	1	
E3	2	2	2	
E4	3	3	3	
E5	4	4	4	
E6	5	5	5	
E7	6	6	6	
E8	7	7	7	
E9	8	8	8	
E10	9	9	9	
E11	10	10	10	
E12	11	11	11	
E13	12	12	12	
E14	13	13	13	
E15	14	14	14	
E16	15	15	15	

-- : not present

Table 37.14: Meaning of the Bits of the Status Word for External LEDs

WORD 1 MEANING OF THE BIT	NUMBER OF THE BIT			
	VT150W + VT100MT1000	VT160W	VT300W - VT310W - VT320W + VT100MT1000	
E17	0	0	0	
E18	1	1	1	
E19	2	--	2	
E20	3	--	3	
E21	--	--	--	
E22	--	--	--	
E23	--	--	--	
E24	--	--	--	
E25	--	--	--	
E26	--	--	--	
E27	--	--	--	
E28	--	--	--	
E29	--	--	--	
E30	--	--	--	
E31	--	--	--	
E32	--	--	--	

-- : not present

Status area for recipes This area consists of 1 word (numbered 0).

NO. OF WORD	NAME OF WORD
0	STATUS WORD for RECIPES

Table 37.15: Meaning of the Bits of the Status Word for Recipes

WORD 0 MEANING OF THE BIT	NUMBER OF THE BIT															
	VT 50	VT 60	VT 150 W	VT 160 W	VT 170 W	VT 190 W	VT 300 W	VT 310 W	VT 320 W	VT 330 W						
TIMEOUT FOR RECIPE TRANSFER Status 1 when the terminal does not respond in the expected time	--	--	--	--	13	13	13	13	13	13						
TRANSFER OVER Status 1 when the terminal has sent all the relevant data	--	--	--	--	14	14	14	14	14	14						
TRANSFER REQUEST Status 1 when the terminal wants to start to transfer	--	--	--	--	15	15	15	15	15	15						

-- : not present

Table 37.16: Meaning of the Bits of the Status Word for Recipes

WORD 0 MEANING OF THE BIT	NUMBER OF THE BIT																	
	VT 155 W	VT 185 W	VT 505 H	VT 505 W	VT 515 W	VT 155 W	VT 185 W	VT 505 H	VT 505 W	VT 525 H	VT 525 W	VT 555 W	VT 56x W	VT 575 W	VT 580 W	VT 585 W	VT 585 WB	VT 595 W
TIMEOUT FOR RECIPE TRANSFER Status 1 when the terminal does not respond in the expected time	13	13	13	13	13	13	13	13	13	13	13	13	13	13	13	13	13	13
TRANSFER OVER Status 1 when the terminal has sent all the relevant data	14	14	14	14	14	14	14	14	14	14	14	14	14	14	14	14	14	14
TRANSFER REQUEST Status 1 when the terminal wants to start to transfer	15	15	15	15	15	15	15	15	15	15	15	15	15	15	15	15	15	15

-- : not present

Status area for internal keys

The significance of this area depends on the type of VT used:

- With a keyboard
- With a touch screen.

With a keyboard: this area consists of a maximum of 6 words (numbered from 0 to 5).

NO. OF WORD	NAME OF WORD
0	OPERATIVE KEYS STATUS
1	OPERATIVE KEYS STATUS
2	OPERATIVE KEYS STATUS
3	OPERATIVE KEYS STATUS
4	FUNCTION KEYS STATUS
5	FUNCTION KEYS STATUS

With a touch screen: this area consists of 1 word.

NO. OF WORD	NAME OF WORD
0	FUNCTION KEYS STATUS

The tables appearing below refer to VTs with a keyboard.

- 37.17: Meaning of the Bits of the Status Word for Internal Keys (Word 0)
- 37.18: Meaning of the Bits of the Status Word for Internal Keys (Word 1)
- 37.19: Meaning of the Bits of the Status Word for Internal Keys (Word 2)
- 37.20: Meaning of the Bits of the Status Word for Internal Keys (Word 3)
- 37.21: Meaning of the Bits of the Status Word for Internal Keys (Word 4)
- 37.22: Meaning of the Bits of the Status Word for Internal Keys (Word 5)



The tables appearing below refer to VTs with a touch screen.

37.17: Meaning of the Bits of the Status Word for Internal Keys (Word 0)

The keys enclosed in a box with a bold border put the related bit at 1 when

pressed with .

 **The above is valid for VT50 and VT60. In the case of other terminals the bits relating to the function keys are always the same. The bit of the SHIFT key must also be tested (Word 0 - Bit 15).**

The bit relating to the  key is set at 1 only if pressed at the same time as another key (e.g.  + ).

The Handshake bit is put at 1 by the VT each time one or more keys are pressed; the device can put it at 0 in order to find out when the VT is going to write.

Table 37.17: Meaning of the Bits of the Status Word for Internal Keys (Word 0)

BIT	WORD 0															
	Shift	VT50	VT60	VT150W	VT160W	VT170W	VT190W	VT300W	VT310W	VT320W	VT330W					
0		HAND SHAKE	HAND SHAKE	HAND SHAKE	HAND SHAKE	HAND SHAKE	HAND SHAKE	HAND SHAKE	HAND SHAKE	HAND SHAKE	HAND SHAKE					
1																
2			--													
3																
4																
5				--	--											
6																
7																
8																
9																
10				--	--											
11				--	--											
12			--													
13				--	--											
14				--	--	--	--			--						
15		--	--													

-- : not used

Table 37.18: Meaning of the Bits of the Status Word for Internal Keys (Word 1)

BIT	WORD 1														
	Shift	VT50	VT60	VT150W	VT160W	VT170W	VT190W	VT300W	VT310W	VT320W	VT330W				
0		n.p.	n.p.												
1		n.p.	n.p.												
2		n.p.	n.p.												
3		n.p.	n.p.												
4		n.p.	n.p.												
5		n.p.	n.p.												
6		n.p.	n.p.												
7		n.p.	n.p.												
8		n.p.	n.p.									--			
9		n.p.	n.p.									--			
10		n.p.	n.p.	--	--	--	--	--	--	--	--	--			
11		n.p.	n.p.	--	--	--	--	--	--	--	--	--			
12		n.p.	n.p.	--	--	--	--	--	--	--	--	--			
13		n.p.	n.p.	--	--	--	--	--	--	--	--	--			
14		n.p.	n.p.	--	--	--	--	--	--	--	--	--			
15		n.p.	n.p.	--	--	--	--	--	--	--	--	--			

-- : not used

n.p. : not present

Table 37.19: Meaning of the Bits of the Status Word for Internal Keys (Word 2)

BIT	WORD 2													
	Shift	VT50	VT60	VT150W	VT160W	VT170W	VT190W	VT300W	VT310W	VT320W	VT330W			
0		n.p.	n.p.											
1		n.p.	n.p.											
2		n.p.	n.p.											
3		n.p.	n.p.											
4		n.p.	n.p.											
5		n.p.	n.p.	--	--									
6		n.p.	n.p.	--	--									
7		n.p.	n.p.	--	--									
8		n.p.	n.p.	--	--									
9		n.p.	n.p.	--	--									
10		n.p.	n.p.	--	--						--			
11		n.p.	n.p.	--	--						--			
12		n.p.	n.p.	--	--	--					--			
13		n.p.	n.p.	--	--	--					--			
14		n.p.	n.p.	--	--	--					--			
15		n.p.	n.p.	--	--	--					--			

-- : not used

n.p. : not present

Table 37.20: Meaning of the Bits of the Status Word for Internal Keys (Word 3)

BIT	WORD 3													
	Shift	VT50	VT60	VT150W	VT160W	VT170W	VT190W	VT300W	VT310W	VT320W	VT330W			
0		n.p.	n.p.	n.p.	n.p.	n.p.								
1		n.p.	n.p.	n.p.	n.p.	n.p.								
2		n.p.	n.p.	n.p.	n.p.	n.p.								
3		n.p.	n.p.	n.p.	n.p.	n.p.								
4		n.p.	n.p.	n.p.	n.p.	n.p.								
5		n.p.	n.p.	n.p.	n.p.	n.p.			--					
6		n.p.	n.p.	n.p.	n.p.	n.p.			--					
7		n.p.	n.p.	n.p.	n.p.	n.p.			--					
8		n.p.	n.p.	n.p.	n.p.	n.p.	--	--	--					
9		n.p.	n.p.	n.p.	n.p.	n.p.	--	--	--					
10		n.p.	n.p.	n.p.	n.p.	n.p.	--	--	--					
11		n.p.	n.p.	n.p.	n.p.	n.p.	--	--	--					
12		n.p.	n.p.	n.p.	n.p.	n.p.	--	--	--	--				
13		n.p.	n.p.	n.p.	n.p.	n.p.	--	--	--	--	--			
14		n.p.	n.p.	n.p.	n.p.	n.p.	--	--	--	--	--			
15		n.p.	n.p.	n.p.	n.p.	n.p.	--	--	--	--	--			

-- : not used

n.p. : not present

Table 37.21: Meaning of the Bits of the Status Word for Internal Keys (Word 4)

BIT	WORD 4														
	Shift	VT50	VT60	VT150W	VT160W	VT170W	VT190W	VT300W	VT310W	VT320W	VT330W				
0		n.p.	n.p.	n.p.	n.p.	n.p.	n.p.	n.p.	n.p.	n.p.	F1				
1		n.p.	n.p.	n.p.	n.p.	n.p.	n.p.	n.p.	n.p.	n.p.	F2				
2		n.p.	n.p.	n.p.	n.p.	n.p.	n.p.	n.p.	n.p.	n.p.	F3				
3		n.p.	n.p.	n.p.	n.p.	n.p.	n.p.	n.p.	n.p.	n.p.	F4				
4		n.p.	n.p.	n.p.	n.p.	n.p.	n.p.	n.p.	n.p.	n.p.	F5				
5		n.p.	n.p.	n.p.	n.p.	n.p.	n.p.	n.p.	n.p.	n.p.	F6				
6		n.p.	n.p.	n.p.	n.p.	n.p.	n.p.	n.p.	n.p.	n.p.	F7				
7		n.p.	n.p.	n.p.	n.p.	n.p.	n.p.	n.p.	n.p.	n.p.	F8				
8		n.p.	n.p.	n.p.	n.p.	n.p.	n.p.	n.p.	n.p.	n.p.	F9				
9		n.p.	n.p.	n.p.	n.p.	n.p.	n.p.	n.p.	n.p.	n.p.	F10				
10		n.p.	n.p.	n.p.	n.p.	n.p.	n.p.	n.p.	n.p.	n.p.	F11				
11		n.p.	n.p.	n.p.	n.p.	n.p.	n.p.	n.p.	n.p.	n.p.	F12				
12		n.p.	n.p.	n.p.	n.p.	n.p.	n.p.	n.p.	n.p.	n.p.	F13				
13		n.p.	n.p.	n.p.	n.p.	n.p.	n.p.	n.p.	n.p.	n.p.	F14				
14		n.p.	n.p.	n.p.	n.p.	n.p.	n.p.	n.p.	n.p.	n.p.	F15				
15		n.p.	n.p.	n.p.	n.p.	n.p.	n.p.	n.p.	n.p.	n.p.	F16				

-- : not used

n.p. : not present

Table 37.22: Meaning of the Bits of the Status Word for Internal Keys (Word 5)

BIT	WORD 5												
	Shift	VT50	VT60	VT150W	VT160W	VT170W	VT190W	VT300W	VT310W	VT320W	VT330W		
0		n.p.	n.p.	n.p.	n.p.	n.p.	n.p.	n.p.	n.p.	n.p.	F17		
1		n.p.	n.p.	n.p.	n.p.	n.p.	n.p.	n.p.	n.p.	n.p.	F18		
2		n.p.	n.p.	n.p.	n.p.	n.p.	n.p.	n.p.	n.p.	n.p.	F19		
3		n.p.	n.p.	n.p.	n.p.	n.p.	n.p.	n.p.	n.p.	n.p.	F20		
4		n.p.	n.p.	n.p.	n.p.	n.p.	n.p.	n.p.	n.p.	n.p.	F21		
5		n.p.	n.p.	n.p.	n.p.	n.p.	n.p.	n.p.	n.p.	n.p.	F22		
6		n.p.	n.p.	n.p.	n.p.	n.p.	n.p.	n.p.	n.p.	n.p.	F23		
7		n.p.	n.p.	n.p.	n.p.	n.p.	n.p.	n.p.	n.p.	n.p.	F24		
8		n.p.	n.p.	n.p.	n.p.	n.p.	n.p.	n.p.	n.p.	n.p.	F25		
9		n.p.	n.p.	n.p.	n.p.	n.p.	n.p.	n.p.	n.p.	n.p.	F26		
10		n.p.	n.p.	n.p.	n.p.	n.p.	n.p.	n.p.	n.p.	n.p.	F27		
11		n.p.	n.p.	n.p.	n.p.	n.p.	n.p.	n.p.	n.p.	n.p.	F28		
12		n.p.	n.p.	n.p.	n.p.	n.p.	n.p.	n.p.	n.p.	n.p.	--		
13		n.p.	n.p.	n.p.	n.p.	n.p.	n.p.	n.p.	n.p.	n.p.	--		
14		n.p.	n.p.	n.p.	n.p.	n.p.	n.p.	n.p.	n.p.	n.p.	--		
15		n.p.	n.p.	n.p.	n.p.	n.p.	n.p.	n.p.	n.p.	n.p.	--		

-- : not used

n.p. : not present

Table 37.23: Meaning of the Bits of the Status Word for Internal Keys (Word 0)

BIT	WORD 0					
	VT505H	VT52H				
0	HAND SHAKE	HAND SHAKE				
1	F1	F1				
2	F2	F2				
3	F3	F3				
4	F4	F4				
5	F5	F5				
6	F6	F6				
7	F7	F7				
8	F8	F8				
9	F9	F9				
10	F10	F10				
11	--	--				
12	--	--				
13	--	--				
14	--	--				
15	--	--				

-- : not used n.p. : non presente

Status area for external keys

This area consists of a maximum of 2 words (numbered from 0 to 1).

NO. OF WORD	NAME OF WORD
0	STATUS WORD for EXTERNAL KEYS
1	STATUS WORD for EXTERNAL KEYS

Table 37.24: Meaning of the Bits of the Status Word for External Keys

WORD 0 MEANING OF BIT	NUMBER OF THE BIT			
	VT150W + VT100MT1000	VT160W	VT300W - VT310W - VT320W + VT100MT1000	
E1	0	0	0	
E2	1	1	1	
E3	2	2	2	
E4	3	3	3	
E5	4	4	4	
E6	5	5	5	
E7	6	6	6	
E8	7	7	7	
E9	8	8	8	
E10	9	9	9	
E11	10	10	10	
E12	11	11	11	
E13	12	12	12	
E14	13	13	13	
E15	14	14	14	
E16	15	15	15	

-- : not present

Table 37.25: Meaning of the Bits of the Status Word for External Keys

WORD 1 MEANING OF BIT	NUMBER OF THE BIT			
	VT150W + VT100MT1000	VT160W	VT300W - VT310W - VT320W + VT100MT1000	
E17	0	0	0	
E18	1	1	1	
E19	2	--	2	
E20	3	--	3	
E21	--	--	--	
E22	--	--	--	
E23	--	--	--	
E24	--	--	--	
E25	--	--	--	
E26	--	--	--	
E27	--	--	--	
E28	--	--	--	
E29	--	--	--	
E30	--	--	--	
E31	--	--	--	
E32	--	--	--	

-- : not present

Status area for internal keys (Real Time)

The significance of this area depends on the type of VT used:

- With a keyboard
- With a touch screen.

With a keyboard: this area consists of a maximum of 6 words (numbered from 0 to 5).



WORD NUMBER	NAME OF WORD
0	OPERATIVE KEYS STATUS (Real Time)
1	OPERATIVE KEYS STATUS (Real Time)
2	OPERATIVE KEYS STATUS (Real Time)
3	OPERATIVE KEYS STATUS (Real Time)
4	FUNCTION KEYS STATUS (Real Time)
5	FUNCTION KEYS STATUS (Real Time)

With a touch screen: this area consists of 1 word.

WORD NUMBER	NAME OF WORD
0	FUNCTION KEYS STATUS (Real Time)

The keys surrounded by a bold border set the corresponding bit at 1 when pressed together with .

⚠ The above is valid for VT50 and VT60. In the case of other terminals the bits relating to the function keys are always the same. The bit of the SHIFT key must also be tested (Word 0 - Bit 15).

The bit relating to the  key is set at 1 only if pressed at the same time as another key (e.g.  + ).

The Handshake bit is set at 1 by the VT whenever one or more keys are pressed; it is set at 0 when no key is pressed.

For details concerning these Status words, see Page 37-15.

Status area for external keys (Real Time)

This area consists of a maximum of 2 words (numbered from 0 to 1).

WORD NUMBER	NAME OF WORD
0	STATUS WORD FOR EXTERN. KEYS (Real Time)
1	STATUS WORD FOR EXTERN. KEYS (Real Time)

For details concerning these Status words, see Page 37-23.

Status area for printer

This area consists of 2 words (numbered from 0 to 1).

NO. OF WORD	NAME OF WORD
0	STATUS WORD for ASP
1	STATUS WORD for LPT

Table 37.26: Meaning of the Bits of the Status Word for ASP

WORD 0 MEANING OF THE BIT	NUMBER OF THE BIT																								
	VT 50	VT 60	VT 150 W	VT 160 W	VT 170 W	VT 190 W	VT 300 W	VT 310 W	VT 320 W	VT 330 W	VT 155 W	VT 185 W	VT 505 H	VT 505 W	VT 515 W	VT 525 H	VT 525 W	VT 555 W	VT 56x W	VT 575 W	VT 580 W	VT 585 W	VT 585 WB	VT 595 W	
STAMPANTE NOT ON LINE Status 1 when one of the bits from 3 to 8 is set at 1.	n.p.	n.p.	n.p.	n.p.	0	0	0	0	0	0	0	0	n.p.	n.p.	n.p.	0	0	0	0	0	0	0	0	0	0
TIMEOUT Status 1 when the printer is OFFLINE, not connected, lacks paper or when there is any communication problem follow the command to print.	n.p.	n.p.	n.p.	n.p.	1	1	1	1	1	1	1	1	n.p.	n.p.	n.p.	1	1	1	1	1	1	1	1	1	1
--	n.p.	n.p.	n.p.	n.p.	--	--	--	--	--	--	--	--	n.p.	n.p.	n.p.	--	--	--	--	--	--	--	--	--	--
REPORT PRINTING IN PROGRESS Status 1 as long as the function lasts	n.p.	n.p.	n.p.	n.p.	3	3	3	3	3	3	3	3	n.p.	n.p.	n.p.	3	3	3	3	3	3	3	3	3	3
DIRECT PRINTING OF THE INFORMATION MESSAGE IN PROGRESS Status 1 as long as the function lasts	n.p.	n.p.	n.p.	n.p.	4	4	4	4	4	4	4	4	n.p.	n.p.	n.p.	4	4	4	4	4	4	4	4	4	4
DIRECT PRINTING OF THE ISA ALARME IN PROGRESS Status 1 as long as the function lasts	n.p.	n.p.	n.p.	n.p.	5	5	5	5	5	5	5	5	n.p.	n.p.	n.p.	5	5	5	5	5	5	5	5	5	5
PRINTING OF ALARM HISTORY BUFFER IN PROGRESS Status 1 as long as the function lasts	n.p.	n.p.	n.p.	n.p.	6	6	6	6	6	6	6	6	n.p.	n.p.	n.p.	6	6	6	6	6	6	6	6	6	6
HARDCOPY IN PROGRESS Status 1 as long as the function lasts	n.p.	n.p.	n.p.	n.p.	7	7	7	7	7	7	7	7	n.p.	n.p.	n.p.	7	7	7	7	7	7	7	7	7	7
FORM-FEED IN PROGRESS Status 1 as long as the function lasts	n.p.	n.p.	n.p.	n.p.	8	8	8	8	8	8	8	8	n.p.	n.p.	n.p.	8	8	8	8	8	8	8	8	8	8

-- : non used

n.p. : not present

Table 37.27: Meaning of the Bits of the Status Word for LPT

WORD 1 MEANING OF THE BIT	NUMBER OF THE BIT																							
	VT 50	VT 60	VT 150 W	VT 160 W	VT 170 W	VT 190 W	VT 300 W	VT 310 W	VT 320 W	VT 330 W	VT 155 W	VT 185 W	VT 505 H	VT 505 W	VT 515 W	VT 525 H	VT 525 W	VT 555 W	VT 56x W	VT 575 W	VT 580 W	VT 585 W	VT 585 WB	VT 595 W
STAMPANTE NOT ON LINE Status 1 when one of the bits from 3 to 8 is set at 1.	n.p.	n.p.	n.p.	n.p.	0	0	0	0	0	0	n.p.	n.p.	n.p.	n.p.	n.p.	n.p.	n.p.	0	0	0	0	0	0	0
TIMEOUT Status 1 when the printer is OFFLINE, not connected, lacks paper or when there is any communication problem follow the command to print.	n.p.	n.p.	n.p.	n.p.	1	1	1	1	1	1	n.p.	n.p.	n.p.	n.p.	n.p.	n.p.	n.p.	1	1	1	1	1	1	1
--	n.p.	n.p.	n.p.	n.p.	--	--	--	--	--	--	n.p.	n.p.	n.p.	n.p.	n.p.	n.p.	n.p.	--	--	--	--	--	--	--
REPORT PRINTING IN PROGRESS Status 1 as long as the function lasts	n.p.	n.p.	n.p.	n.p.	3	3	3	3	3	3	n.p.	n.p.	n.p.	n.p.	n.p.	n.p.	n.p.	3	3	3	3	3	3	3
DIRECT PRINTING OF THE INFORMATION MESSAGE IN PROGRESS Status 1 as long as the function lasts	n.p.	n.p.	n.p.	n.p.	4	4	4	4	4	4	n.p.	n.p.	n.p.	n.p.	n.p.	n.p.	n.p.	4	4	4	4	4	4	4
DIRECT PRINTING OF THE ISA ALARME IN PROGRESS Status 1 as long as the function lasts	n.p.	n.p.	n.p.	n.p.	5	5	5	5	5	5	n.p.	n.p.	n.p.	n.p.	n.p.	n.p.	n.p.	5	5	5	5	5	5	5
PRINTING OF ALARM HISTORY BUFFER IN PROGRESS Status 1 as long as the function lasts	n.p.	n.p.	n.p.	n.p.	6	6	6	6	6	6	n.p.	n.p.	n.p.	n.p.	n.p.	n.p.	n.p.	6	6	6	6	6	6	6
HARDCOPY IN PROGRESS Status 1 as long as the function lasts	n.p.	n.p.	n.p.	n.p.	7	7	7	7	7	7	n.p.	n.p.	n.p.	n.p.	n.p.	n.p.	n.p.	7	7	7	7	7	7	7
FORM-FEED IN PROGRESS Status 1 as long as the function lasts	n.p.	n.p.	n.p.	n.p.	8	8	8	8	8	8	n.p.	n.p.	n.p.	n.p.	n.p.	n.p.	n.p.	8	8	8	8	8	8	8

-- : non used

n.p. : not present

Status area for trends This area consists of 1 word.

WORD NUMBER	NAME OF WORD
0	TREND STATUS WORD

Table 37.28: Meaning of bits of Trend Status Word

WORD 0 MEANING OF BIT	NUMBER OF THE BIT																								
	VT 50	VT 60	VT 150 W	VT 160 W	VT 170 W	VT 190 W	VT 300 W	VT 310 W	VT 320 W	VT 330 W	VT 155 W	VT 185 W	VT 505 H	VT 505 W	VT 515 W	VT 525 H	VT 525 W	VT 555 W	VT 56x W	VT 575 W	VT 580 W	VT 585 W	VT 585 WB	VT 585 W	
TREND NUMBER 1 BUFFER FULL Status 1 when the buffer is full.	n.p.	--	--	--	--	--	0	0	0	0	--	0	--	--	--	--	--	0	0	0	0	0	0	0	0
TREND NUMBER 2 BUFFER FULL Status 1 when the buffer is full.	n.p.	--	--	--	--	--	1	1	1	1	--	1	--	--	--	--	--	1	1	1	1	1	1	1	1
TREND NUMBER 3 BUFFER FULL Status 1 when the buffer is full.	n.p.	--	--	--	--	--	2	2	2	2	--	2	--	--	--	--	--	2	2	2	2	2	2	2	2
TREND NUMBER 4 BUFFER FULL Status 1 when the buffer is full.	n.p.	--	--	--	--	--	3	3	3	3	--	3	--	--	--	--	--	3	3	3	3	3	3	3	3
TREND NUMBER 5 BUFFER FULL Status 1 when the buffer is full.	n.p.	--	--	--	--	--	4	4	4	4	--	4	--	--	--	--	--	4	4	4	4	4	4	4	4
TREND NUMBER 6 BUFFER FULL Status 1 when the buffer is full.	n.p.	--	--	--	--	--	5	5	5	5	--	5	--	--	--	--	--	5	5	5	5	5	5	5	5
TREND NUMBER 7 BUFFER FULL Status 1 when the buffer is full.	n.p.	--	--	--	--	--	6	6	6	6	--	6	--	--	--	--	--	6	6	6	6	6	6	6	6
TREND NUMBER 8 BUFFER FULL Status 1 when the buffer is full.	n.p.	--	--	--	--	--	7	7	7	7	--	7	--	--	--	--	--	7	7	7	7	7	7	7	7
TREND NUMBER 9 BUFFER FULL Status 1 when the buffer is full.	n.p.	--	--	--	--	--	8	8	8	8	--	8	--	--	--	--	--	8	8	8	8	8	8	8	8
TREND NUMBER 10 BUFFER FULL Status 1 when the buffer is full.	n.p.	--	--	--	--	--	9	9	9	9	--	9	--	--	--	--	--	9	9	9	9	9	9	9	9
TREND NUMBER 11 BUFFER FULL Status 1 when the buffer is full.	n.p.	--	--	--	--	--	10	10	10	10	--	10	--	--	--	--	--	10	10	10	10	10	10	10	10
TREND NUMBER 12 BUFFER FULL Status 1 when the buffer is full.	n.p.	--	--	--	--	--	11	11	11	11	--	11	--	--	--	--	--	11	11	11	11	11	11	11	11
TREND NUMBER 13 BUFFER FULL Status 1 when the buffer is full.	n.p.	--	--	--	--	--	12	12	12	12	--	12	--	--	--	--	--	12	12	12	12	12	12	12	12
TREND NUMBER 14 BUFFER FULL Status 1 when the buffer is full.	n.p.	--	--	--	--	--	13	13	13	13	--	13	--	--	--	--	--	13	13	13	13	13	13	13	13
TREND NUMBER 15 BUFFER FULL Status 1 when the buffer is full.	n.p.	--	--	--	--	--	14	14	14	14	--	14	--	--	--	--	--	14	14	14	14	14	14	14	14
TREND NUMBER 16 BUFFER FULL Status 1 when the buffer is full.	n.p.	--	--	--	--	--	15	15	15	15	--	15	--	--	--	--	--	15	15	15	15	15	15	15	15

-- : not used

n.p. : not present

**Command
response area**

This area consists of 4 fixed words (numbered from 0 to 3).

NO. OF WORD	NAME OF WORD
0	COMMAND
1	PARAMETER 1
2	PARAMETER 2
3	PARAMETER 3

Below are listed commands with their responses:

COMMAND 14: Reads current time	
Word	Value/Meaning
0	14
1	HH -> Hours in BCD MM -> Minutes in BCD
2	SS -> Seconds in BCD Not used
3	Not used

COMMAND 15: Reads current date	
Word	Value/Meaning
0	15
1	GG -> Day in BCD MMM -> Month in BCD
2	AAAA -> Year in BCD
3	DOW -> Day of the week (0=Sunday) Not Used

For examples of the use of this area see Software Manual.

**Command
area external
LEDs (fixed
light)**

This area consists of 2 fixed words (numbered from 0 to 1).

WORD NUMBER	NAME OF WORD
0	WORD COMMANDING EXTERNAL LEDS
1	WORD COMMANDING EXTERNAL LEDS

Table 37.29: Meaning of Bits of Word Commanding External LEDs (fixed light)

WORD 0 MEANING OF BIT	BIT NUMBER			
	VT150W + VT100MT1000	VT160W	VT300W - VT310W - VT320W + VT100MT1000	
E1	0	0	0	
E2	1	1	1	
E3	2	2	2	
E4	3	3	3	
E5	4	4	4	
E6	5	5	5	
E7	6	6	6	
E8	7	7	7	
E9	8	8	8	
E10	9	9	9	
E11	10	10	10	
E12	11	11	11	
E13	12	12	12	
E14	13	13	13	
E15	14	14	14	
E16	15	15	15	

-- : not present

Table 37.30: Meaning of Bits of Word Commanding External LEDs (fixed light)

WORD 1 MEANING OF BIT	BIT NUMBER			
	VT150W + VT100MT1000	VT160W	VT300W - VT310W - VT320W + VT100MT1000	
E17	0	0	0	
E18	1	1	1	
E19	2	--	2	
E20	3	--	3	
E21	--	--	--	
E22	--	--	--	
E23	--	--	--	
E24	--	--	--	
E25	--	--	--	
E26	--	--	--	
E27	--	--	--	
E28	--	--	--	
E29	--	--	--	
E30	--	--	--	
E31	--	--	--	
E32	--	--	--	

-- : not present

**Command
area external
LEDs (blinking
light)**

This area consists of 2 fixed words (numbered from 0 to 1).

NO. OF WORD	NAME OF WORD
0	WORD COMMANDING EXTERNAL LEDS
1	WORD COMMANDING EXTERNAL LEDS

For details concerning status words, see Page 37-30.

**Command
area internal
red LEDs
(fixed light)**

This area consists of up to 2 words (numbered from 0 to 1).

WORD NUMBER	NAME OF WORD
0	WORD COMMANDING RED LEDS
1	WORD COMMANDING RED LEDS

Table 37.31: Meaning of Bits of Word Commanding internal red LEDs (fixed light)

WORD 0 BIT NUMBER	MEANING OF BIT																					
	VT 50	VT 60	VT 150 W	VT 160 W	VT 170 W	VT 190 W	VT 300 W	VT 310 W	VT 320 W	VT 330 W												
0	--	--	--	--	F1	F1	F1	F1	F1	F1	--											
1	--	--	--	--	F2	F2	F2	F2	F2	F2	--											
2	--	--	--	--	F3	F3	F3	F3	F3	F3	--											
3	--	--	--	--	F4	F4	F4	F4	F4	F4	--											
4	--	--	--	--	F5	F5	F5	F5	F5	F5	--											
5	--	--	--	--	F6	F6	F6	F6	F6	F6	--											
6	--	--	--	--	F7	F7	F7	F7	F7	F7	--											
7	--	--	--	--	F8	F8	F8	F8	F8	F8	--											
8	--	--	--	--	F9	F9	F9	F9	F9	F9	--											
9	--	--	--	--	F10	F10	F10	F10	F10	F10	--											
10	--	--	--	--	F11	F11	F11	F11	F11	F11	--											
11	--	--	--	--	F12	F12	F12	--	F12	--												
12	--	--	--	--	--	F13	F13	--	F13	--												
13	--	--	--	--	--	F14	F14	--	F14	--												
14	--	--	--	--	--	F15	F15	--	F15	--												
15	--	--	--	--	--	F16	F16	--	F16	--												

-- : not present

Table 37.32: Meaning of Bits of Word Commanding internal red LEDs (fixed light)

WORD 1 BIT NUMBER	MEANING OF BIT																				
	VT 50	VT 60	VT 150 W	VT 160 W	VT 170 W	VT 190 W	VT 300 W	VT 310 W	VT 320 W	VT 330 W											
0	--	--	--	--	--	F17	F17	--	F17	--											
1	--	--	--	--	--	F18	F18	--	F18	--											
2	--	--	--	--	--	F19	F19	--	--	--											
3	--	--	--	--	--	F20	F20	--	--	--											
4	--	--	--	--	--	F21	F21	--	--	--											
5	--	--	--	--	--	F22	F22	--	--	--											
6	--	--	--	--	--	--	--	--	--	--											
7	--	--	--	--	--	--	--	--	--	--											
8	--	--	--	--	--	--	--	--	--	--											
9	--	--	--	--	--	--	--	--	--	--											
10	--	--	--	--	--	--	--	--	--	--											
11	--	--	--	--	--	--	--	--	--	--											
12	--	--	--	--	--	--	--	--	--	--											
13	--	--	--	--	--	--	--	--	--	--											
14	--	--	--	--	--	--	--	--	--	--											
15	--	--	--	--	--	--	--	--	--	--											

-- : not present

**Command
area internal
red LEDs
(blinking light)**

This area consists of up to 2 words (numbered from 0 to 1).

NO. OF WORD	NAME OF WORD
0	WORD COMMANDING RED LEDs
1	WORD COMMANDING RED LEDs

For details concerning status words, see Pages 22-28.

**Command
area internal
green LEDs
(fixed light)**

This area consists of up to 2 words (numbered from 0 to 1).

NO. OF WORD	NAME OF WORD
0	WORD COMMANDING GREEN LEDS
1	WORD COMMANDING GREEN LEDS

Table 37.33: Meaning of Bits of Word Commanding internal green LEDs (fixed light)

WORD 0 BIT NUMBER	MEANING OF BIT																				
	VT 50	VT 60	VT 150 W	VT 160 W	VT 170 W	VT 190 W	VT 300 W	VT 310 W	VT 320 W	VT 330 W											
0	--	--	F1	F1	F1	F1	F1	F1	F1	F1	--										
1	--	--	F2	F2	F2	F2	F2	F2	F2	F2	--										
2	--	--	F3	F3	F3	F3	F3	F3	F3	F3	--										
3	--	--	F4	F4	F4	F4	F4	F4	F4	F4	--										
4	--	--	F5	F5	F5	F5	F5	F5	F5	F5	--										
5	--	--	--	--	F6	F6	F6	F6	F6	F6	--										
6	--	--	--	--	F7	F7	F7	F7	F7	F7	--										
7	--	--	--	--	F8	F8	F8	F8	F8	F8	--										
8	--	--	--	--	F9	F9	F9	F9	F9	F9	--										
9	--	--	--	--	F10	F10	F10	F10	F10	F10	--										
10	--	--	--	--	F11	F11	F11	F11	F11	F11	--										
11	--	--	--	--	F12	F12	F12	F12	F12	F12	--										
12	--	--	--	--	--	F13	F13	F13	F13	F13	F13										
13	--	--	--	--	--	F14	F14	F14	F14	F14	F14										
14	--	--	--	--	--	F15	F15	F15	F15	F15	F15										
15	--	--	--	--	--	F16	F16	F16	F16	F16	F16										

-- : not present

Table 37.34: Meaning of Bits of Word Commanding internal green LEDs (fixed light)

WORD 1 BIT NUMBER	MEANING OF BIT															
	VT 50	VT 60	VT 150 W	VT 160 W	VT 170 W	VT 190 W	VT 300 W	VT 310 W	VT 320 W	VT 330 W						
0	--	--	--	--	--	F17	F17	F17	F17	F17						
1	--	--	--	--	--	F18	F18	F18	F18	F18						
2	--	--	--	--	--	F19	F19	F19	F19	F19						
3	--	--	--	--	--	F20	F20	F20	F20	F20						
4	--	--	--	--	--	F21	F21	F21	F21	F21						
5	--	--	--	--	--	F22	F22	--	F22	F22						
6	--	--	--	--	--	F23	F23	--	F23	F23						
7	--	--	--	--	--	F24	F24	--	F24	F24						
8	--	--	--	--	--	--	--	--	F25	F25						
9	--	--	--	--	--	--	--	--	F26	F26						
10	--	--	--	--	--	--	--	--	F27	F27						
11	--	--	--	--	--	--	--	--	F28	F28						
12	--	--	--	--	--	--	--	--	--	--						
13	--	--	--	--	--	--	--	--	--	--						
14	--	--	--	--	--	--	--	--	--	--						
15	--	--	--	--	--	--	--	--	--	--						

-- : not present

**Command
area internal
green LEDs
(blinking light)**

This area consists of up to 2 words (numbered from 0 to 1).

NO. OF WORD	NAME OF WORD
0	WORD COMMANDING GREEN LEDES
1	WORD COMMANDING GREEN LEDES

For details concerning status words, see Page 37-34.

Command area

This area consists of 4 fixed words (numbered from 0 to 3).

NO. OF WORD	NAME OF WORD
0	COMMAND
1	PARAMETER 1
2	PARAMETER 2
3	PARAMETER 3

Table 37.35: List of commands available (Part 1 of 4)

COMMAND CODE	PARAMS.			DESCRIPTION	VT	VT	VT	VT	VT	VT	VT	VT	VT	VT	VT	VT	VT	VT	VT	VT	VT	VT	VT						
	1	2	3		50	60	150 W	160 W	170 W	190 W	300 W	310 W	320 W	330 W	155 W	185 W	505 H	505 W	515 W	525 H	525 W	555 W	56x W	575 W	580 W	585 W	585 WB	595 W	
01	--	●	●	●	Forces sequence	●	●	●	●	●	●	●	●	●	--	--	--	--	--	--	--	--	--	--	--	--	--	--	
02	--	●	●	--	Forces page	●	●	●	●	●	●	●	●	●	●	●	●	●	●	●	●	●	●	●	●	●	●	●	●
03	--	●	--	--	Forces current field	●	●	●	●	●	●	●	●	●	--	--	--	--	--	--	--	--	--	--	--	--	--	--	
04	--	●	--	--	Bit-structured protection mask	●	●	●	●	●	●	●	●	●	●	●	●	●	●	●	●	●	●	●	●	●	●	●	●
05	--	●	--	--	Forces system context	●	●	●	●	●	●	●	●	●	●	●	●	●	●	●	●	●	●	●	●	●	●	●	●
06	--	●	--	--	Sets auto-scroll for messages	●	●	●	●	--	--	--	--	--	--	--	--	--	--	--	--	--	--	--	--	--	--	--	
07	--	●	--	--	Sets current language	●	●	●	●	●	●	●	●	●	●	●	●	●	●	●	●	●	●	●	●	●	●	●	●
08	--	●	--	--	Priority of messages	●	●	●	●	--	--	--	--	--	●	●	●	●	●	●	●	--	--	--	--	--	--	--	
09	--	●	--	--	Operation of messages	●	●	●	●	●	●	●	●	●	●	●	●	●	●	●	●	●	●	●	●	●	●	●	●
10	--	●	--	--	Sets auto-scroll time for information messages	●	●	●	●	●	●	●	●	●	●	●	●	●	●	●	●	●	●	●	●	●	●	●	●
11	--	●	--	--	Sets auto-scroll time for ISA alarms	--	--	--	--	●	●	●	●	●	●	●	--	--	●	●	●	●	●	●	●	●	●	●	●

-- : not present r : response

Table 37.35: List of commands available (Part 3 of 4)

COMMAND CODE		PARAMS.			DESCRIPTION	VT	VT	VT	VT	VT	VT	VT	VT	VT	VT	VT	VT	VT	VT	VT	VT	VT	VT	VT	VT	VT		
		1	2	3		50	60	150 W	160 W	170 W	190 W	300 W	310 W	320 W	330 W	155 W	185 W	505 H	505 W	515 W	525 H	525 W	555 W	56x W	575 W	580 W	585 W	585 WB
26	--	●	●	--	Command: read and write pipeline	--	--	--	--	●	●	●	●	●	--	--	--	--	--	--	●	●	●	●	●	●	●	●
27	--	●	--	--	Deletes trend from VT buffer	--	--	--	--	--	●	●	●	●	--	●	--	--	--	--	●	●	●	●	●	●	●	●
28	--	●	--	--	Reads trend on command	--	--	--	--	--	●	●	●	●	--	●	--	--	--	--	●	●	●	●	●	●	●	●
29	--	●	●	--	Stop trend	--	--	--	--	--	●	●	●	●	--	●	--	--	--	--	●	●	●	●	●	●	●	●
30	--	●	●	--	Start trend	--	--	--	--	--	●	●	●	●	--	●	--	--	--	--	●	●	●	●	●	●	●	●
31	--	●	●	--	Command: internal red LEDs	--	--	--	--	●	●	●	●	●	--	--	--	--	--	--	--	--	--	--	--	--	--	--
32	--	●	●	--	Command: flashing of internal red LEDs	--	--	--	--	●	●	●	●	●	--	--	--	--	--	--	--	--	--	--	--	--	--	--
33	--	●	●	--	Command: external LEDs	--	--	●	●	--	--	●	●	●	--	--	--	--	--	--	--	--	--	--	--	--	--	--
34	--	●	●	--	Command: flashing of external LEDs	--	--	●	●	--	--	●	●	●	--	--	--	--	--	--	--	--	--	--	--	--	--	--
35	--	●	--	--	Report printing	--	--	--	--	●	●	●	●	●	●	●	--	--	--	●	●	●	●	●	●	●	●	●
36	--	●	●	--	Printing of the ISA alarms history buffer	--	--	--	--	●	●	●	●	●	●	●	--	--	--	●	●	●	●	●	●	●	●	●
37	--	●	--	--	Hardcopy	--	--	--	--	●	●	--	--	--	--	--	--	--	--	--	--	--	--	--	--	--	--	--
38	--	●	--	--	Form-feed	--	--	--	--	●	●	●	●	●	●	●	--	--	--	●	●	●	●	●	●	●	●	●
39	--	●	--	--	Zeroes number of print pages	--	--	--	--	●	●	●	●	●	●	●	--	--	--	●	●	●	●	●	●	●	●	●

-- : not present

r : response

Table 37.35: List of commands available (Part 4 of 4)

COMMAND CODE	PARAMS.			DESCRIPTION	VT	VT	VT	VT	VT	VT	VT	VT	VT	VT	VT	VT	VT	VT	VT	VT	VT	VT	VT	VT	VT			
	1	2	3		50	60	150 W	160 W	170 W	190 W	300 W	310 W	320 W	330 W	155 W	185 W	505 H	505 W	515 W	525 H	525 W	555 W	56x W	575 W	580 W	585 W	585 WB	595 W
40	--	●	●	--	Command makes internal green LEDs light up flashing	--	--	●	●	●	●	●	●	--	--	--	--	--	--	--	--	--	--	--	--	--	--	
41	--	●	●	--	Command makes internal red LEDs light up flashing	--	--	--	--	●	●	●	●	--	--	--	--	--	--	--	--	--	--	--	--	--	--	--
42	--	●	●	--	Command makes external LEDs light up flashing	--	--	●	●	--	--	●	●	●	--	--	--	--	--	--	--	--	--	--	--	--	--	--
43	--	--	--	--	Acknowledgment of all alarms together	--	--	--	--	●	●	●	●	●	●	●	--	--	●	●	●	●	●	●	●	●	●	●
44	--	●	●	--	Force transfer mode	--	--	--	--	--	--	--	--	--	--	--	--	--	--	--	--	--	--	●	●	●	●	●
45	--	--	--	--	Saving the alarm history buffer and trend buffers	--	--	--	--	--	--	--	--	--	●	●	--	--	●	●	●	--	--	●	●	--	●	●
46	--	--	--	--	Command for operating working of touch screen	--	--	--	--	--	--	--	--	--	--	--	●	--	--	●	--	--	--	--	--	--	--	--
48	--	--	--	--	Copy recipes into the remanent memory	--	--	--	--	--	--	--	--	--	--	--	--	--	--	--	--	--	--	●	●	--	●	●
--	--	--	--	--		--	--	--	--	--	--	--	--	--	--	--	--	--	--	--	--	--	--	--	--	--	--	
--	--	--	--	--		--	--	--	--	--	--	--	--	--	--	--	--	--	--	--	--	--	--	--	--	--	--	--
--	--	--	--	--		--	--	--	--	--	--	--	--	--	--	--	--	--	--	--	--	--	--	--	--	--	--	--

-- : not present r : response

We list below the commands in detail; unless otherwise indicated all the parameter values are expressed in binary.

COMMAND 01: Forces sequence	
Word	Value/Meaning
0	1
1	Sequence identifier Indicates the number of the sequence that must be displayed. If the value is zero the current sequence is restored; this serves to quit a system page and restore the project page context.
2	Page identifier Indicates the page number of the sequence that must be displayed. If the value is zero or a value that is not valid, the first page of the sequence is displayed.
3	Page control The parameter has 2 identifiers, one for each byte. The high byte (more significant) contains the CURRENT FIELD, that is, the field in the page on which the cursor must be positioned. If the value is zero or a value that is not valid, the current field is the first in the page. The low byte (less significant) contains the BIT-STRUCTURED PROTECTION MASK to be used to protect the fields.

COMMAND 02: Forces page	
Word	Value/Meaning
0	2
1	Page identifier Indicates the page number of the sequence that must be displayed. If the value is zero or a value that is not valid, the first page of the sequence is displayed.
2	Page control The parameter has 2 identifiers, one for each byte. The high byte (more significant) contains the CURRENT FIELD, that is, the field in the page on which the cursor must be positioned. If the value is zero or a value that is not valid, the current field is the first in the page. The low byte (less significant) contains the BIT-STRUCTURED PROTECTION MASK to be used to protect the fields.
3	Not used

COMMAND 03: Forces current field	
Word	Value/Meaning
0	3
1	Page control The parameter has 2 identifiers, one for each byte. The high byte (more significant) contains the CURRENT FIELD, that is, the field in the page on which the cursor must be positioned. If the value is zero or a value that is not valid, the current field is the first in the page. The low byte (less significant) contains the BIT-STRUCTURED PROTECTION MASK to be used to protect the fields.
2	Not used
3	Not used

COMMAND 04: Forces bit-structured protection mask	
Word	Value/Meaning
0	4
1	Bit-structured mask Uses the 8 bits of the low byte (least significant). logic state "1" activates the protection that stops the field being varied.
2	Not used
3	Not used

COMMAND 05: Forces system context	
Word	Value/Meaning
0	5
1	Context identifier Indicates which context to set. Possible contexts are:
	VT50/60
	0 INFORMATION MESSAGES
	1 SEQUENCE DIRECTORY
	2 DRIVER
	3 HELP FOR PROJECT PAGES
	4 PROJECT INFORMATION
	VT150/160/170/190/300/310/320/330/155/185/505/515/525/555/56x/575/580/585/585B/595
	0 INFORMATION MESSAGES
	1 SEQUENCE DIRECTORY (PAGES*)
	2 DRIVER
	3 HELP FOR PROJECT PAGES
	4 HELP FOR ISA ALARMS
5 ISA ALARMS	
6 RECIPE DIRECTORY	
7 HELP FOR INFORMATION MESSAGES	
8 ALARM HISTORY	
9 PROJECT INFORMATION	
10 SET CLOCK	
11 SYSTEM MESSAGES ASSIGNED TO RECIPES	
12 SYSTEM MESSAGES ASSIGNED TO PASSWORDS	
2	Not used
3	Not used

(* Only in the case of Touch Screen

COMMAND 06: Sets autoscroll for messages	
Word	Value/Meaning
0	6
1	Setting autoscroll Logic state "1" or other than zero activates the function. Logic state "0" deactivates the function.
2	Not used
3	Not used

COMMAND 07: Sets current language	
Word	Value/Meaning
0	7
1	Language identifier The number of the new current language depends on the way the project is set.
2	Not used
3	Not used

COMMAND 08: Set the priority for messages	
Word	Value/Meaning
0	8
1	Setting priority for messages Logic state "1" or other than zero activates the function. Logic state "0" deactivates the function.
2	Not used
3	Not used

COMMAND 09: Operation of messages	
Word	Value/Meaning
0	9
1	Bit command Contains activation/deactivation bits of functions as described below:
	VT50/60
	0 OFF/ON INFORMATION MESSAGE AUTOSCROLL
	1 OFF/ON PRIORITY TO INFORMATION MESSAGES
	VT150/160
	0 --
	1 --
	2 OFF/ON BUZZER WHEN KEY IS PRESSED
	3 --
	4 OFF/ON CONTINUOUS BUZZER
	5 OFF/ON INFORMATION MESSAGE AUTOSCROLL
	6 OFF/ON PRIORITY TO DISPLAY OF INFORMATION MESSAGES
	7 OFF/ON INTERMITTENT BUZZER IN PRESENCE OF INFORMATION MESSAGE
	VT170/190/300/310/320/330/155/185/505/515/525/555/56x/575/580/585/585B/595
	0 OFF/ON ISA ALARMS AUTOSCROLL
1 OFF/ON PRIORITY TO DISPLAY OF ISA ALARMS	
2 OFF/ON BUZZER WHEN KEY IS PRESSED (AT A TOUCH*)	
3 OFF/ON INTERMITTENT BUZZER IN PRESENCE OF INFORMATION MESSAGE	
4 OFF/ON CONTINUOUS BUZZER	
5 OFF/ON INFORMATION MESSAGE AUTOSCROLL	
2	--
3	--

(*) Only in the case of Touch Screen

COMMAND 10: Set time for autoscroll of INFORMATION MESSAGES	
Word	Value/Meaning
0	10
1	Time of autoscroll Value in secs. (1-60) indicating time to elapse before display of next INFORMATION MESSAGE page.
2	Not used
3	Not used

COMMAND 11: Set time for autoscroll of alarm messages	
Word	Value/Meaning
0	11
1	Time of autoscroll Value in secs. (1-60) indicating time to elapse before display of next ALARM MESSAGE page.
2	Not used
3	Not used

COMMAND 12: Set time for after which lamp switches off	
Word	Value/Meaning
0	12 Makes it possible to set the idle time of the terminal after which the display lamp switches off. By idle time we mean no pressing of the keys for a certain time. In the case of touch screens, it means no pressing of touch screen buttons/keys.
1	Waiting time Value in minutes (1-30) indicating the time to pass before the display lamp goes off; the value 0 deactivates the function.
2	Not used
3	Not used

COMMAND 13: Set idle time-out for keys in edit mode	
Word	Value/Meaning
0	13 Sets the time after which you pass automatically from edit to display mode following the last key-touch.
1	Idle time Value in minutes from 1 to 30 A value equal to zero disables this function.
2	Not used
3	Not used

COMMAND 14: Reads current time	
Word	Value/Meaning
0	14 Copies time read by internal clock into response function area.
1	Not used
2	Not used
3	Not used

COMMAND 15: Reads current date	
Word	Value/Meaning
0	15
1	Not used
2	Not used
3	Not used

COMMAND 16: Sets current time		
Word	Value/Meaning	
0	16 Updates terminal clock with values sent by device.	
1	HH -> Hours in BCD	MM -> Minutes in BCD
2	SS -> Seconds in BCD	Not used
3	Not used	

COMMAND 17: Sets current date		
Word	Value/Meaning	
0	17	
1	GG -> Day in BCD	MMM -> Month in BCD
2	AAAA -> Year in BCD	
3	DOW -> Day of the week (0=Sunday)	Not Used

COMMAND 18 : Read trend from device buffer	
Word	Value/Meaning
0	18 Acquires the samples in the buffer of the device as a block.
1	Number of the buffer
2	Not used
3	Not used

COMMAND 19: Empty ISA alarms history buffer	
Word	Value/Meaning
0	19 Makes it possible to eliminate all records of ISA alarms from history buffer.
1	Not used
2	Not used
3	Not used

COMMAND 20: Synchronization of recipe transfer	
Word	Value/Meaning
0	20 Makes it possible to tell the device that a recipe transfer is to start. The device must respond to the VT before transmission can begin.
1	Bit commands Contains the response bits to the RECIPE STATUS AREA 13 TIMEOUT confirms to the VT timeout of transmission 14 ENDTX confirms to the VT end of transmission 15 STARTTX confirms to the VT beginning of transmission
2	Not used
3	Not used

COMMAND 21: Request for a recipe		
Word	Value/Meaning	
0	21 Sends the VT request to transfer a recipe to its memory. Parameters 1 and 2 contain the 4-character code (name) of the recipe. Logic state "0" of bit 4 of VT STATUS word (in VT STATUS AREA) indicates that the code requested is present in the data memory of the VT, while logic state "1" indicates the absence of the code. With the code present transmission starts in SYNCHRONIZED or UNSYNCHRONIZED mode as determined by the project.	
1	Character 1	Character 2
2	Character 3	Character 4
3	Not Used	

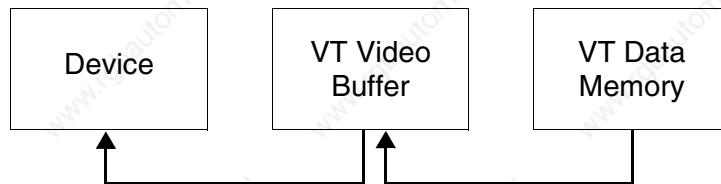

COMMAND 22: Sends recipe to VT without overwriting		
Word	Value/Meaning	
0	22 Makes it possible to send the VT a recipe with a new code for it to be saved in the data memory only if code is absent. Parameters 1 and 2 contain the 4-character code (name) of the recipe. Logic state "0" of bit 4 of VT STATUS word (in VT STATUS AREA) indicates that the code requested is present in the data memory of the VT, while logic state "1" indicates the absence of the code. With the code absent the VT starts transmitting and then saving the data.	
1	Character 1	Character 2
2	Character 3	Character 4
3	Not Used	



The recipe code in the VT must be 4 characters long



You are advised to use this command associated with command 48 (valid for VT575W, VT580W, VT585WB, VT595W) otherwise the recipes will be lost when the VT is switched off.

COMMAND 23: Sends recipe to the VT by overwriting	
Word	Value/Meaning
0	23 Makes it possible to send the VT a recipe with a news code to save it in the data memory without checking the existence of the code. Parameters 1 and 2 contain the 4-character code (name) of the recipe. Logic state "0" of bit 4 of VT STATUS word (in VT STATUS AREA) indicates that the command was carried out correctly, while logic state "1" indicates an incorrect command.
1	Character 1
2	Character 3
3	Not Used

 **The recipe code in the VT must be 4 characters long**

 **You are advised to use this command associated with command 48 (valid for VT575W, VT580W, VT585WB, VT595W) otherwise the recipes will be lost when the VT is switched off.**

COMMAND 24: Command: internal green LEDs																																																																																																																																																																																																						
Word	Value/Meaning																																																																																																																																																																																																					
0	24 Makes it possible to switch on and off the green LEDs internal to the VT and corresponding to the bits of the words of parameters 1 and 2.																																																																																																																																																																																																					
1	<table border="1"> <thead> <tr> <th rowspan="2">BIT</th> <th colspan="10">TYPE of VT</th> </tr> <tr> <th>150</th> <th>160</th> <th>170</th> <th>190</th> <th>300</th> <th>310</th> <th>320</th> <th>330</th> <th></th> <th></th> </tr> </thead> <tbody> <tr><td>0</td><td>F1</td><td>F1</td><td>F1</td><td>F1</td><td>F1</td><td>F1</td><td>F1</td><td>--</td><td></td><td></td></tr> <tr><td>1</td><td>F2</td><td>F2</td><td>F2</td><td>F2</td><td>F2</td><td>F2</td><td>F2</td><td>--</td><td></td><td></td></tr> <tr><td>2</td><td>F3</td><td>F3</td><td>F3</td><td>F3</td><td>F3</td><td>F3</td><td>F3</td><td>--</td><td></td><td></td></tr> <tr><td>3</td><td>F4</td><td>F4</td><td>F4</td><td>F4</td><td>F4</td><td>F4</td><td>F4</td><td>--</td><td></td><td></td></tr> <tr><td>4</td><td>F5</td><td>F5</td><td>F5</td><td>F5</td><td>F5</td><td>F5</td><td>F5</td><td>--</td><td></td><td></td></tr> <tr><td>5</td><td>--</td><td>--</td><td>F6</td><td>F6</td><td>F6</td><td>F6</td><td>F6</td><td>--</td><td></td><td></td></tr> <tr><td>6</td><td>--</td><td>--</td><td>F7</td><td>F7</td><td>F7</td><td>F7</td><td>F7</td><td>--</td><td></td><td></td></tr> <tr><td>7</td><td>--</td><td>--</td><td>F8</td><td>F8</td><td>F8</td><td>F8</td><td>F8</td><td>--</td><td></td><td></td></tr> <tr><td>8</td><td>--</td><td>--</td><td>F9</td><td>F9</td><td>F9</td><td>F9</td><td>F9</td><td>--</td><td></td><td></td></tr> <tr><td>9</td><td>--</td><td>--</td><td>F10</td><td>F10</td><td>F10</td><td>F10</td><td>F10</td><td>--</td><td></td><td></td></tr> <tr><td>10</td><td>--</td><td>--</td><td>F11</td><td>F11</td><td>F11</td><td>F11</td><td>F11</td><td>--</td><td></td><td></td></tr> <tr><td>11</td><td>--</td><td>--</td><td>F12</td><td>F12</td><td>F12</td><td>F12</td><td>F12</td><td>--</td><td></td><td></td></tr> <tr><td>12</td><td>--</td><td>--</td><td>--</td><td>F13</td><td>F13</td><td>F13</td><td>F13</td><td>F13</td><td></td><td></td></tr> <tr><td>13</td><td>--</td><td>--</td><td>--</td><td>F14</td><td>F14</td><td>F14</td><td>F14</td><td>F14</td><td></td><td></td></tr> <tr><td>14</td><td>--</td><td>--</td><td>--</td><td>F15</td><td>F15</td><td>F15</td><td>F15</td><td>F15</td><td></td><td></td></tr> <tr><td>15</td><td>--</td><td>--</td><td>--</td><td>F16</td><td>F16</td><td>F16</td><td>F16</td><td>F16</td><td></td><td></td></tr> </tbody> </table>	BIT	TYPE of VT										150	160	170	190	300	310	320	330			0	F1	F1	F1	F1	F1	F1	F1	--			1	F2	F2	F2	F2	F2	F2	F2	--			2	F3	F3	F3	F3	F3	F3	F3	--			3	F4	F4	F4	F4	F4	F4	F4	--			4	F5	F5	F5	F5	F5	F5	F5	--			5	--	--	F6	F6	F6	F6	F6	--			6	--	--	F7	F7	F7	F7	F7	--			7	--	--	F8	F8	F8	F8	F8	--			8	--	--	F9	F9	F9	F9	F9	--			9	--	--	F10	F10	F10	F10	F10	--			10	--	--	F11	F11	F11	F11	F11	--			11	--	--	F12	F12	F12	F12	F12	--			12	--	--	--	F13	F13	F13	F13	F13			13	--	--	--	F14	F14	F14	F14	F14			14	--	--	--	F15	F15	F15	F15	F15			15	--	--	--	F16	F16	F16	F16	F16		
	BIT		TYPE of VT																																																																																																																																																																																																			
		150	160	170	190	300	310	320	330																																																																																																																																																																																													
	0	F1	F1	F1	F1	F1	F1	F1	--																																																																																																																																																																																													
	1	F2	F2	F2	F2	F2	F2	F2	--																																																																																																																																																																																													
	2	F3	F3	F3	F3	F3	F3	F3	--																																																																																																																																																																																													
	3	F4	F4	F4	F4	F4	F4	F4	--																																																																																																																																																																																													
	4	F5	F5	F5	F5	F5	F5	F5	--																																																																																																																																																																																													
	5	--	--	F6	F6	F6	F6	F6	--																																																																																																																																																																																													
	6	--	--	F7	F7	F7	F7	F7	--																																																																																																																																																																																													
	7	--	--	F8	F8	F8	F8	F8	--																																																																																																																																																																																													
	8	--	--	F9	F9	F9	F9	F9	--																																																																																																																																																																																													
	9	--	--	F10	F10	F10	F10	F10	--																																																																																																																																																																																													
	10	--	--	F11	F11	F11	F11	F11	--																																																																																																																																																																																													
	11	--	--	F12	F12	F12	F12	F12	--																																																																																																																																																																																													
	12	--	--	--	F13	F13	F13	F13	F13																																																																																																																																																																																													
13	--	--	--	F14	F14	F14	F14	F14																																																																																																																																																																																														
14	--	--	--	F15	F15	F15	F15	F15																																																																																																																																																																																														
15	--	--	--	F16	F16	F16	F16	F16																																																																																																																																																																																														
2	<table border="1"> <thead> <tr> <th rowspan="2">BIT</th> <th colspan="10">TYPE of VT</th> </tr> <tr> <th>150</th> <th>160</th> <th>170</th> <th>190</th> <th>300</th> <th>310</th> <th>320</th> <th>330</th> <th></th> <th></th> </tr> </thead> <tbody> <tr><td>0</td><td>--</td><td>--</td><td>--</td><td>F17</td><td>F17</td><td>F17</td><td>F17</td><td>F17</td><td></td><td></td></tr> <tr><td>1</td><td>--</td><td>--</td><td>--</td><td>F18</td><td>F18</td><td>F18</td><td>F18</td><td>F18</td><td></td><td></td></tr> <tr><td>2</td><td>--</td><td>--</td><td>--</td><td>F19</td><td>F19</td><td>F19</td><td>F19</td><td>F19</td><td></td><td></td></tr> <tr><td>3</td><td>--</td><td>--</td><td>--</td><td>F20</td><td>F20</td><td>F20</td><td>F20</td><td>F20</td><td></td><td></td></tr> <tr><td>4</td><td>--</td><td>--</td><td>--</td><td>F21</td><td>F21</td><td>F21</td><td>F21</td><td>F21</td><td></td><td></td></tr> <tr><td>5</td><td>--</td><td>--</td><td>--</td><td>F22</td><td>F22</td><td>--</td><td>F22</td><td>F22</td><td></td><td></td></tr> <tr><td>6</td><td>--</td><td>--</td><td>--</td><td>F23</td><td>F23</td><td>--</td><td>F23</td><td>F23</td><td></td><td></td></tr> <tr><td>7</td><td>--</td><td>--</td><td>--</td><td>F24</td><td>F24</td><td>--</td><td>F24</td><td>F24</td><td></td><td></td></tr> <tr><td>8</td><td>--</td><td>--</td><td>--</td><td>--</td><td>--</td><td>--</td><td>F25</td><td>F25</td><td></td><td></td></tr> <tr><td>9</td><td>--</td><td>--</td><td>--</td><td>--</td><td>--</td><td>--</td><td>F26</td><td>F26</td><td></td><td></td></tr> <tr><td>10</td><td>--</td><td>--</td><td>--</td><td>--</td><td>--</td><td>--</td><td>F27</td><td>F27</td><td></td><td></td></tr> <tr><td>11</td><td>--</td><td>--</td><td>--</td><td>--</td><td>--</td><td>--</td><td>F28</td><td>F28</td><td></td><td></td></tr> <tr><td>12</td><td>--</td><td>--</td><td>--</td><td>--</td><td>--</td><td>--</td><td>--</td><td>--</td><td></td><td></td></tr> <tr><td>13</td><td>--</td><td>--</td><td>--</td><td>--</td><td>--</td><td>--</td><td>--</td><td>--</td><td></td><td></td></tr> <tr><td>14</td><td>--</td><td>--</td><td>--</td><td>--</td><td>--</td><td>--</td><td>--</td><td>--</td><td></td><td></td></tr> <tr><td>15</td><td>--</td><td>--</td><td>--</td><td>--</td><td>--</td><td>--</td><td>--</td><td>--</td><td></td><td></td></tr> </tbody> </table>	BIT	TYPE of VT										150	160	170	190	300	310	320	330			0	--	--	--	F17	F17	F17	F17	F17			1	--	--	--	F18	F18	F18	F18	F18			2	--	--	--	F19	F19	F19	F19	F19			3	--	--	--	F20	F20	F20	F20	F20			4	--	--	--	F21	F21	F21	F21	F21			5	--	--	--	F22	F22	--	F22	F22			6	--	--	--	F23	F23	--	F23	F23			7	--	--	--	F24	F24	--	F24	F24			8	--	--	--	--	--	--	F25	F25			9	--	--	--	--	--	--	F26	F26			10	--	--	--	--	--	--	F27	F27			11	--	--	--	--	--	--	F28	F28			12	--	--	--	--	--	--	--	--			13	--	--	--	--	--	--	--	--			14	--	--	--	--	--	--	--	--			15	--	--	--	--	--	--	--	--		
	BIT		TYPE of VT																																																																																																																																																																																																			
		150	160	170	190	300	310	320	330																																																																																																																																																																																													
	0	--	--	--	F17	F17	F17	F17	F17																																																																																																																																																																																													
	1	--	--	--	F18	F18	F18	F18	F18																																																																																																																																																																																													
	2	--	--	--	F19	F19	F19	F19	F19																																																																																																																																																																																													
	3	--	--	--	F20	F20	F20	F20	F20																																																																																																																																																																																													
	4	--	--	--	F21	F21	F21	F21	F21																																																																																																																																																																																													
	5	--	--	--	F22	F22	--	F22	F22																																																																																																																																																																																													
	6	--	--	--	F23	F23	--	F23	F23																																																																																																																																																																																													
	7	--	--	--	F24	F24	--	F24	F24																																																																																																																																																																																													
	8	--	--	--	--	--	--	F25	F25																																																																																																																																																																																													
	9	--	--	--	--	--	--	F26	F26																																																																																																																																																																																													
	10	--	--	--	--	--	--	F27	F27																																																																																																																																																																																													
	11	--	--	--	--	--	--	F28	F28																																																																																																																																																																																													
	12	--	--	--	--	--	--	--	--																																																																																																																																																																																													
13	--	--	--	--	--	--	--	--																																																																																																																																																																																														
14	--	--	--	--	--	--	--	--																																																																																																																																																																																														
15	--	--	--	--	--	--	--	--																																																																																																																																																																																														
3	Not Used																																																																																																																																																																																																					

--: not used

COMMAND 25:		Command: flashing internal green LEDs									
Word	Value/Meaning										
0	25 Makes it possible to activate or deactivate the flashing of the green LEDs internal to VT and corresponding to the bits of the words of parameters 1 and 2. The LED must previously have been switched on using the command 24										
1	BIT	TYPE of VT									
		150	160	170	190	300	310	320	330		
	0	F1	F1	F1	F1	F1	F1	F1	--		
	1	F2	F2	F2	F2	F2	F2	F2	--		
	2	F3	F3	F3	F3	F3	F3	F3	--		
	3	F4	F4	F4	F4	F4	F4	F4	--		
	4	F5	F5	F5	F5	F5	F5	F5	--		
	5	--	--	F6	F6	F6	F6	F6	--		
	6	--	--	F7	F7	F7	F7	F7	--		
	7	--	--	F8	F8	F8	F8	F8	--		
	8	--	--	F9	F9	F9	F9	F9	--		
	9	--	--	F10	F10	F10	F10	F10	--		
	10	--	--	F11	F11	F11	F11	F11	--		
	11	--	--	F12	F12	F12	F12	F12	--		
	12	--	--	--	F13	F13	F13	F13	F13		
	13	--	--	--	F14	F14	F14	F14	F14		
	14	--	--	--	F15	F15	F15	F15	F15		
15	--	--	--	F16	F16	F16	F16	F16			
2	BIT	TYPE of VT									
		150	160	170	190	300	310	320	330		
	0	--	--	--	F17	F17	F17	F17	F17		
	1	--	--	--	F18	F18	F18	F18	F18		
	2	--	--	--	F19	F19	F19	F19	F19		
	3	--	--	--	F20	F20	F20	F20	F20		
	4	--	--	--	F21	F21	F21	F21	F21		
	5	--	--	--	F22	F22	--	F22	F22		
	6	--	--	--	F23	F23	--	F23	F23		
	7	--	--	--	F24	F24	--	F24	F24		
	8	--	--	--	--	--	--	F25	F25		
	9	--	--	--	--	--	--	F26	F26		
	10	--	--	--	--	--	--	F27	F27		
	11	--	--	--	--	--	--	F28	F28		
	12	--	--	--	--	--	--	F17	--		
	13	--	--	--	--	--	--	F18	--		
	14	--	--	--	--	--	--	F19	--		
15	--	--	--	--	--	--	F20	--			
3	Not Used										

-- : not used

COMMAND 26 :		Read and write pipeline
Word	Value/Meaning	
0	26 Reads and writes the pipeline specified.	
1	Number of the pipeline	
2	Not used	
3	Not used	

COMMAND 27 :		Delete trend from VT buffer
Word	Value/Meaning	
0	27 Deletes the readings in the VT buffer.	
1	Number of the buffer	
2	Not used	
3	Not used	

COMMAND 28 : Read trend on command	
Word	Value/Meaning
0	28 With each command sent acquires a reading from the buffer of the device.
1	Number of the buffer
2	Not used
3	Not used

COMMAND 29 : Stop trend	
Word	Value/Meaning
0	29 Stops the reading of the channel corresponding to the trend buffer defined in parameter 1. The command only applies to trends in Single Automatic Sampling mode.
1	Buffer number
2	Not used
3	Not used

COMMAND 30 : Start trend	
Word	Value/Meaning
0	30 Starts the reading of the channel corresponding to the trend buffer defined in parameter 1. The command only applies to trends in Single Automatic Sampling mode.
1	Buffer number
2	Not used
3	Not used

COMMAND 31:		Command: internal red LEDs								
Word	Value/Meaning									
0	31 Makes it possible to switch on and off the red LEDs internal to the VT and corresponding to the bits of the words of parameters 1 and 2.									
1	BIT	TYPE of VT								
		170	190	300	310	320	330			
	0	F1	F1	F1	F1	F1	--			
	1	F2	F2	F2	F2	F2	--			
	2	F3	F3	F3	F3	F3	--			
	3	F4	F4	F4	F4	F4	--			
	4	F5	F5	F5	F5	F5	--			
	5	F6	F6	F6	F6	F6	--			
	6	F7	F7	F7	F7	F7	--			
	7	F8	F8	F8	F8	F8	--			
	8	F9	F9	F9	F9	F9	--			
	9	F10	F10	F10	F10	F10	--			
	10	F11	F11	F11	F11	F11	--			
	11	F12	F12	F12	--	F12	--			
	12	--	F13	F13	--	F13	--			
	13	--	F14	F14	--	F14	--			
14	--	F15	F15	--	F15	--				
15	--	F16	F16	--	F16	--				
2	BIT	TYPE of VT								
		170	190	300	310	320	330			
	0	--	F17	F17	--	F17	--			
	1	--	F18	F18	--	F18	--			
	2	--	F19	F19	--	--	--			
	3	--	F20	F20	--	--	--			
	4	--	F21	F21	--	--	--			
	5	--	F22	F22	--	--	--			
	6	--	--		--	--	--			
	7	--	--		--	--	--			
	8	--	--	--	--	--	--			
	9	--	--	--	--	--	--			
	10	--	--	--	--	--	--			
	11	--	--	--	--	--	--			
	12	--	--	--	--	--	--			
	13	--	--	--	--	--	--			
14	--	--	--	--	--	--				
15	--	--	--	--	--	--				
3	Not Used									

-- : not used

COMMAND 32:		Command: flashing of internal red LEDs							
Word	Value/Meaning								
0	32 Makes it possible to activate or deactivate the flashing of the red LEDs internal to VT and corresponding to the bits of the words of parameters 1 and 2. The LED must previously have been switched on using the command 31								
1	BIT	TYPE of VT							
	0	170	190	300	310	320	330		
	1	F1	F1	F1	F1	F1	--		
	2	F2	F2	F2	F2	F2	--		
	3	F3	F3	F3	F3	F3	--		
	4	F4	F4	F4	F4	F4	--		
	5	F5	F5	F5	F5	F5	--		
	6	F6	F6	F6	F6	F6	--		
	7	F7	F7	F7	F7	F7	--		
	8	F8	F8	F8	F8	F8	--		
	9	F9	F9	F9	F9	F9	--		
	10	F10	F10	F10	F10	F10	--		
	11	F11	F11	F11	F11	F11	--		
	12	F12	F12	F12	--	F12	--		
	13	--	F13	F13	--	F13	--		
	14	--	F14	F14	--	F14	--		
	15	--	F15	F15	--	F15	--		
2	BIT	TYPE of VT							
	0	170	190	300	310	320	330		
	1	--	F17	F17	--	F17	--		
	2	--	F18	F18	--	F18	--		
	3	--	F19	F19	--	--	--		
	4	--	F20	F20	--	--	--		
	5	--	F21	F21	--	--	--		
	6	--	F22	F22	--	--	--		
	7	--	--	--	--	--	--		
	8	--	--	--	--	--	--		
	9	--	--	--	--	--	--		
	10	--	--	--	--	--	--		
	11	--	--	--	--	--	--		
	12	--	--	--	--	--	--		
	13	--	--	--	--	--	--		
	14	--	--	--	--	--	--		
	15	--	--	--	--	--	--		
3	Not Used								

-- : Not used

COMAND 33 :		Command: external LEDs						
Word	Value/Meaning							
0	33 Makes it possible to switch on and off the LEDs external to the VT and corresponding to the bits of the words of parameters 1 and 2.							
1	BIT	TYPE of VT						
		150 + VT100MT1000	160	300-310-320 + VT100MT1000				
	0	E1	E1	E1				
	1	E2	E2	E2				
	2	E3	E3	E3				
	3	E4	E4	E4				
	4	E5	E5	E5				
	5	E6	E6	E6				
	6	E7	E7	E7				
	7	E8	E8	E8				
	8	E9	E9	E9				
	9	E10	E10	E10				
	10	E11	E11	E11				
	11	E12	E12	E12				
	12	E13	E13	E13				
	13	E14	E14	E14				
	14	E15	E15	E15				
15	E16	E16	E16					
2	BIT	TYPE of VT						
		150 + VT100MT1000	160	300-310-320 + VT100MT1000				
	0	E17	E17	E17				
	1	E18	E18	E18				
	2	E19	--	E19				
	3	E20	--	E20				
	4	--	--	--				
	5	--	--	--				
	6	--	--	--				
	7	--	--	--				
	8	--	--	--				
	9	--	--	--				
	10	--	--	--				
	11	--	--	--				
	12	--	--	--				
	13	--	--	--				
	14	--	--	--				
15	--	--	--					
3	Not Used							

-- : not used

COMMAND 34:		Command: flashing of external LEDs						
Word	Value/Meaning							
0	34 Makes it possible to activate or deactivate the LEDs internal to VT and corresponding to the bits of the words of parameters 1 and 2. The LED must previously have been switched on using the command 33							
1	BIT	TYPE of VT						
		150 + VT100MT1000	160	300-310-320 + VT100MT1000				
	0	E1	E1	E1				
	1	E2	E2	E2				
	2	E3	E3	E3				
	3	E4	E4	E4				
	4	E5	E5	E5				
	5	E6	E6	E6				
	6	E7	E7	E7				
	7	E8	E8	E8				
	8	E9	E9	E9				
	9	E10	E10	E10				
	10	E11	E11	E11				
	11	E12	E12	E12				
	12	E13	E13	E13				
	13	E14	E14	E14				
	14	E15	E15	E15				
15	E16	E16	E16					
2	BIT	TYPE of VT						
		150 + VT100MT1000	160	300-310-320 + VT100MT1000				
	0	E17	E17	E17				
	1	E18	E18	E18				
	2	E19	--	E19				
	3	E20	--	E20				
	4	--	--	--				
	5	--	--	--				
	6	--	--	--				
	7	--	--	--				
	8	--	--	--				
	9	--	--	--				
	10	--	--	--				
	11	--	--	--				
	12	--	--	--				
	13	--	--	--				
	14	--	--	--				
15	--	--	--					
3	Not Used							

-- : not used

COMMAND 35: Prints report	
Word	Value/Meaning
0	35 Makes it possible to print the report indicated numerically in parameter 1.
1	Number of the report to print
2	Not used
3	Not used

COMMAND 36: Print ISA alarms history buffer	
Word	Value/Meaning
0	36 Makes it possible to print the ISA alarm message history buffer
1	Not used
2	Not used
3	Not used

COMMAND 37: Hardcopy	
Word	Value/Meaning
0	37 Makes it possible to reproduce the page being displayed on the printer
1	Print mode 0 TEXT MODE
2	Not used
3	Not used

COMMAND 38: Form-Feed	
Word	Value/Meaning
0	38 Makes it possible to send the printer the command feed the sheet.
1	Choice of VT port for communication with printer 0 ASP 15 LPT
2	Not used
3	Not used

COMMAND 39: Reset print sheet counter to zero	
Word	Value/Meaning
0	39 Makes it possible to reset print sheet counter to zero and therefore start from sheet 1 again.
1	Not used
2	Not used
3	Not used

COMMAND 40 : Command makes internal green LEDs light up flashing	
Word	Value/Meaning
0	40 Lights up internal green VT LEDs corresponding to the bits of the words of parameters 1 and 2, uniting in a single command both commands 24 and 25.
1	See Command 24 or 25
2	See Command 24 or 25
3	Not used

COMMAND 41 : Command makes internal red LEDs light up flashing	
Word	Value/Meaning
0	41 Lights up red internal VT LEDs corresponding to the bits of the words of parameters 1 and 2, uniting in a single command both commands 31 and 32.
1	See Command 31 o 32
2	See Command 31 o 32
3	Not used

COMMAND 42 :		Command makes internal LEDs light up flashing
Word	Value/Meaning	
0	42 Lights up internal VT LEDs corresponding to the bits of the words of parameters 1 and 2, uniting in a single command both commands 33 and 34.	
1	See Command 33 or 34	
2	See Command 33 or 34	
3	Not used	

COMMAND 43 :		Acknowledgement of all alarms together
Word	Value/Meaning	
0	43 Tacita tutti gli allarmi presenti.	
1	Not used	
2	Not used	
3	Not used	

COMMAND 44 :		Force transfer mode
Word	Value/Meaning	
0	44 In the VT activate the transfer mode of the project (project, firmware and recipes), directly selecting the source and the transmission speed.	
1	Select source for transfer Allows the selection of the source from which to receive/transmit the project. The possible choices are: 0 MSP 1 ASP 2 Memory Card	
2	Select the transmission speed Allows the selection of the speed of transfer when the source selected is MSP or ASP; this parameter is not considered with other sources. The possible choices are: 0 300 bit/sec 1 600 bit/sec 2 1200 bit/sec 3 2400 bit/sec 4 4800 bit/sec 5 9600 bit/sec 6 19200 bit/sec 7 38400 bit/sec 8 57600 bit/sec 9 115200 bit/sec	
3	Not used	

COMMAND 45 :		Saving the alarm history buffer and/or trend buffers
Word	Value/Meaning	
0	45 Makes it possible to save all the ISA alarm registrations from the history buffer and/or save all trend buffers permanently.	
1	Not used	
2	Not used	
3	Not used	

COMMAND 46 :		Command for operating working of touch screen
Word	Value/Meaning	
0	46 With this the touch screen can be activated or deactivated. When the touch screen is deactivated pressure on the glass remains without effect.	
1	Select operation The choices possible are: 0 Not active (no pressure detected) 1 Active	
2	Not used	
3	Not used	

COMMAND 48 : Copy recipes into the remanent memory	
Word	Value/Meaning
0	48 This allows all the recipes in the volatile memory to be copied into the remanent memory (Flash).
1	Not used
2	Not used
3	Not used



You are advised to use this command associated with command 22 and/or 23 otherwise the recipes will be lost when the VT is switched off.

Chapter 38 Communication protocols

Contents	Page
List of protocols	38-2

This chapter consists of 2 pages.

Our VT terminals can be connected to most devices on the market, thanks to specially designed communication protocols that act as an interface between the VT and the Device.

List of protocols

A list exists showing which devices the VT can communicate with and including further technical information that may be useful to the programmer.

This list is included on the cd-rom VTWIN KIT.

Chapter 39 Free terminal protocol

Contents	Page
Free terminal protocol	39-2
Editing parameters for VT50	39-3
Editing parameters for VT60	39-4
Editing parameters for VT150/160W	39-5
Free terminal control characters	39-6
Key codes for VT50	39-9
Key codes for VT60	39-9
Key codes for VT150/160W	39-10
Code of External keys for MT1000 and VT160W	39-13
Free terminal in Network	39-14
Example of handling	39-16

This chapter consists of 18 pages.

Our VT terminals can be connected with the majority of devices on the market, but, given the considerable number and variety of these devices, it may happen that one is incompatible. To meet the needs of those using an incompatible device, we have created a special driver called *Free terminal*.

Free terminal protocol

The operator terminal has a type of driver called *Free terminal* that makes it possible to communicate with any type of intelligent device not supported by the standard drivers supplied. This driver requires that the device manage the VT terminal in all its functions; this happens by sending control characters that the VT interprets and then sending characters to be displayed. When a is pressed, the VT sends the device the value of that such that the device recognizes and, if necessary, uses it.

The free terminal protocol also allows you to create a network of up to 31 terminals (01 -> 31); the connection must be made using serial RS485 (see "Chapter 34 -> Network connection").

To transfer the driver to the VT, the terminal must be set up for reception (see "Setting up for reception" of the various terminals) before proceeding to transfer (see Software Manual).

Once the transfer has been completed the VT displays the following page

VT-50 TERMINAL Vx.xx



All the examples quoted in this chapter refer to VT50.





This means that the transfer has been effected properly and that the VT is ready to communicate with the device.

The transfer of the free terminal automatically sets the serial communication parameters with pre-established values:

VT address -> 00
Speed -> 9600 Baud
Parity -> N
Data bits -> 8
Stop bits -> 2

The above page remains in vision so long as the device connected does not command it to be canceled and takes over control. The connecting cable is the same as that used for the transfer (see "Chapter 30 -> PC <-> VT connection").

Editing parameters for VT50

These values can be changed by pressing  +  (standard protocol) or  +  +  (ver.3.0 protocol); the screen shows:

VT Address: 00
[Up] [Down] [Enter]

Changes params.



Baud Rate: 9600
[Up] [Down] [Enter]

Changes params.







Param: PN,8db,2sb
[Up] [Down] [Enter]

Changes params.



VT-50 TERMINAL Vx.xx

**Editing
parameters for
VT60**

These values can be changed by pressing  +  (standard protocol) or  +  +  (ver.3.0 protocol); the screen shows:

VT Address: 00

[Up] [Down] [Enter]

Changes params



Baud Rate: 9600

[Up] [Down] [Enter]

Changes params







Param: PN,8db,2sb

[Up] [Down] [Enter]

Changes params

VT-60 TERMINAL Vx.xx
READY

Editing parameters for VT150/160W

These values can be changed by pressing twice  (standard protocol) or  +  +  (ver.3.0 protocol); the screen shows:

VT Address: 00

[Up] [Down] [Enter]

Changes params



Baude Rate: 9600

[Up] [Down] [Enter]

Changes params



Param: PN,8db,2sb

[Up] [Down] [Enter]

Changes params



VT-xxx TERMINAL Vx.xx
READY

Free terminal control characters

The VT uses a set of characters that, sent correctly, function as a *command* and enable the VT to carry out certain operations.

For the *command* to be recognized as such it must be preceded by the control character <ESC> and followed by the control character <EOT>.



The maximum length of a command string is 32 characters.

The tables below list the control characters to be used and the commands.

Table 39.1: Control characters of Free Terminal

Character	Code		Meaning	Effect
	Decimal	Ascii		
<BS>	8	␣	Back Space	Takes the cursor one space back on the same line, canceling the character
<CR>	13	␣	Carriage Return	Takes the cursor to the beginning of the following line
<LF>	10	␣	Line Feed	Takes the cursor to the next line leaving it in the same position
<ESC>	27	+	Escape	Signals the beginning of a command
<EOT>	4	◆	End Of Text	Signals the end of a command



If sent several times in succession the character <EOT> can be used to un-block the VT terminal in the event that the sending of erroneous commands has destabilized the terminal.

Table 39.2: Command characters (Part 1 of 3)

Command	Parameters	Effect
<ESC>Y<EOT>	--	Checks the connection between VT and device. If the connection is right the terminal replies with the string OK.
<ESC>C<EOT>	--	Clears display, taking the cursor to position 0,0 (top left-hand angle).
<ESC>Ayyxx<EOT>	yy = 0...Rows - 1 (0...3) xx = 0...Columns - 1 (0...19)	Takes the cursor to the co-ordinates yy,xx.
<ESC>Bss<EOT>	ss = 00 ->Off 01 ->Blinking (Default)	Changes the status of the cursor: off/blinking.

*If present on/in the terminal

**Applies only to VT150W and VT160W

Table 39.2: Command characters (Part 2 of 3)

Command	Parameters	Effect
<ESC>Fddxx<EOT>	dd = 00 -> Up 01 -> Right 02 -> Down 03 -> Left xx = No. of moves	Moves the cursor relatively with regard to the current position.
<ESC>Z<EOT>	--	Clears display, taking the cursor to position 0,0 (top left-hand angle), switch off all LEDs* and the buzzer*.
<ESC>Ess<EOT>	ss = 00 ->Echo disabled (Default) 01 ->Echo enabled	Displays the code of the key that has been pressed (if above 20Hex)
<ESC>X<EOT>	--	Re-initialize the terminal (equivalent to switching off and switching on again).**
<ESC>Pbbpp<EOT>	bb = 00 -> 300 01 -> 600 02 -> 1200 03 -> 2400 04 -> 4800 05 -> 9600 (Default) 06 -> 19200 07 -> 38400 08 -> 57600 09 -> 115200 pp = 00 -> EVEN, 7, 1 01 -> EVEN, 7, 2 02 -> EVEN, 8, 1 03 -> EVEN, 8, 2 04 -> ODD, 7, 1 05 -> ODD, 7, 2 06 -> ODD, 8, 1 07 -> ODD, 8, 2 08 -> NONE, 7, 1 09 -> NONE, 7, 2 10 -> NONE, 8, 1 11 -> NONE, 8, 2 (Default)	Setting serial communication parameters.  When you use the command <ESC>Pbbpp<EOT> to configure the serial port with parameters different from the current ones, you must also reconfigure the device connected with the same values as the VT, otherwise it will not be possible to communicate. When the communication port is configured by commands rather than a keyboard, this configuration does not remain resident in the VT.

*If present on/in the terminal

**Applies only to VT150W and VT160W

Table 39.2: Command characters (Part 3 of 3)

Command	Parameters	Effect
<ESC>Lxxss<EOT>	xx = 01 -> F1 02 -> F2 03 -> F3 04 -> F4 05 -> F5 06 -> Info 07 -> Help 08 -> E1 09 -> E2 10 -> E3 11 -> E4 12 -> E5 13 -> E6 14 -> E7 15 -> E8 16 -> E9 17 -> E10 18 -> E11 19 -> E12 20 -> E13 21 -> E14 22 -> E15 23 -> E16 24 -> E17 25 -> E18 26 -> E19 only MT1000 27 -> E20 only MT1000 99 -> All ss = 00 -> Off (Default) 01 -> On 02 -> Flashing	Commands the state of the LEDs associated with the internal and external keys.**
<ESC>Saabb<EOT>	aa = 00 -> When keys are pressed 01 -> Intermittent bb = 00 -> Disabled (Default) 01 -> Enabled	Commands the state of the buzzer in the terminal.**
<ESC>Kmm<EOT>	mm = 00 -> Numeric mode (Default) 01 -> ASCII mode	Setting of the keyboard operation mode.**

*If present on/in the terminal

**Applies only to VT150W and VT160W

Key codes for VT50











As already mentioned, when the  are pressed the VT sends a hexadecimal code to the connected device. The table below lists the association between code and .

Table 39.3: Association between keys and hexadecimal codes

Key	Hexadecimal code	
	Only key	Shift + 
	09	14
	04	15
	02	16
	0B	17
	0D	18
	01	12
	03	10

Key codes for VT60









As already mentioned, when the  are pressed the VT sends a hexadecimal code to the connected device. The table below lists the association between code and .

Table 39.4: Association between keys and hexadecimal codes

Key	Hexadecimal code	
	Only key	Shift + 
	01	14
	03	15
	02	16
	0D	17
	09	12

**Key codes for
VT150/160W**











As already mentioned, when the  are pressed the VT sends a hexadecimal code to the connected device. The code depends on the the mode set for the keyboard; whether Numeric or ASCII. The former sends the code related to the numbers on the keys; the second sends the code of the alphabetical characters. The default setting is Numeric, but this can be changed by sending the command K (see Page 39-6). The table below lists the association between code and .

Table 39.5: Association between keys (Numeric mode) and hexadecimal codes (Part 1 of 2)

Key	Hexadecimal code	
	Only key	shift + 
	81	86
	82	87
	83	88
	84	89
	85	8A
	0C	0C
	0B	0B
	01	05
	03	06
	04	04
	02	02
	20	2E
	27	0A
	0D	Reinitializa- tion of VT
	30	30

Table 39.5: Association between keys (Numeric mode) and hexadecimal codes (Part 2 of 2)

Key	Hexadecimal code	
	Only key	shift + <input type="text"/>
	31	31
	32	32
	33	33
	34	34
	35	35
	36	36
	37	37
	38	38
	39	39

In ASCII mode the code relating to the first, second or third letter respectively is sent when the keys F1, F2, or F3 are pressed followed by the key containing the alphanumeric characters.

Example.









Pressing  +  sends the code relating to the letter “S”.

Table 39.6: Association between keys (Ascii mode) and hexadecimal codes (Part 1 of 3)

Key	Hexadecimal code				
	Only key	shift + <input type="text"/>	 + <input type="text"/>	 + <input type="text"/>	 + <input type="text"/>
	--	86	--	--	--
	--	87	--	--	--
	--	88	--	--	--



-- : Send no code

Table 39.6: Association between keys (Ascii mode) and hexadecimal codes (Part 2 of 3)

Key	Hexadecimal code				
	Only key	shift +	+	+	+
	84	89	84	84	84
	85	8A	85	85	85
	0C	0C	0C	0C	0C
	0B	0B	0B	0B	0B
	01	05	01	01	01
	03	06	03	03	03
	04	04	04	04	04
	02	02	02	02	02
	20	2E	20	20	20
	27	0A	27	27	27
	0D	Reinitializa- tion of VT	0D	0D	0D
	30	30	41	42	43
	31	31	44	45	46
	32	32	47	48	49
	33	33	4A	4B	4C
	34	34	4D	4E	4F
	35	35	50	51	52
	36	36	53	54	55

-- : Send no code

Table 39.6: Association between keys (Ascii mode) and hexadecimal codes (Part 3 of 3)

Key	Hexadecimal code				
	Only key	shift +	F6 F1 +	F7 F2 +	F8 F3 +
	37	37	56	57	58
	38	38	59	5A	2D
	39	39	2B	2F	3D

-- : Send no code

Code of External keys for MT1000 and VT160W

The table below lists the association between code and .

Table 39.7: Association between MT1000 keys and hexadecimal codes





















Hexadecimal code				
A0	A1	A2	A3	
				
A4	A5	A6	A7	
				
A8	A9	AA	AB	
				
AC	AD	AE	AF	
				
B0	B1	B2	B3	
				

Table 39.8: Association between VT160 keys and hexadecimal codes



Free terminal in Network

Using the *Free terminal* protocol the VT can be connected in a RS485 linked network to enable a master device to show information to or request information from the various connected terminals.

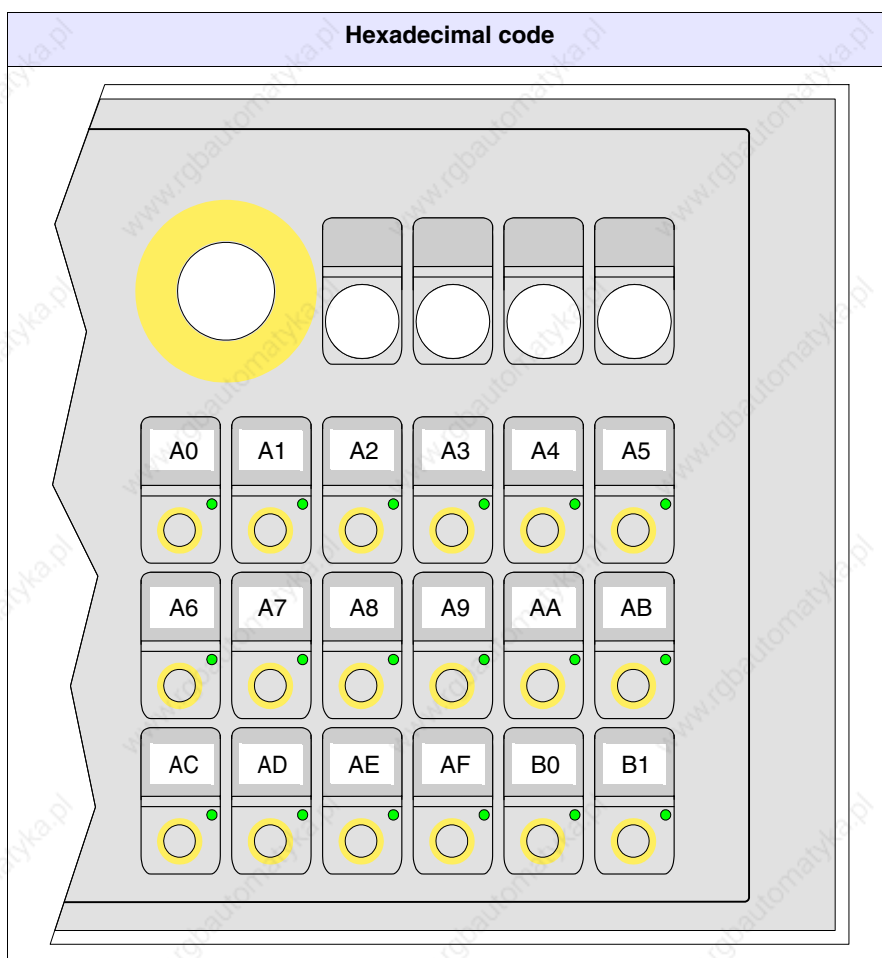
Each connected terminal in this network must have been loaded with the *Free terminal* protocol and must have a different network address from any of the other addresses in the network (01 -> 31). If the address is 00, the terminal is not considered to be a participant in the network.



To change the network address see Page 39-3.

Once the terminal has been connected to the network (with an address other than 00) and switched on, the VT terminal's behavior is different from that seen in the previous paragraphs. The VT will not respond to any command unless it has been addressed. Addressing a terminal means that from that moment on the master device will communicate exclusively with that ter-

minal. Let us imagine the rotating selector with 31 positions from 0 to 31, the position of the selector indicates which terminal to communicate with.

After being addressed, the terminal will respond to all commands, as if it were directly connected to the device, the other will ignore any instruction passing through the network.

Even the sending of $\square\square$ by the VT is different: when a \square is pressed, its hexadecimal code is no longer sent automatically to the device, but is stored in a buffer (Max 64 $\square\square$) that the master device must ask. These keys are then not sent altogether but one \square at a time.

For example, of the VT buffer contained 3 ,  and , then the VT would respond to the first request with "0301" (3 $\square\square$ in the buffer, the first having the code 01Hex). The response to the second request would be "0203" (2 $\square\square$, code 03Hex); the response to the third request would be "0102" (1 \square , code 09Hex). In order to communicate that there are no keys in its buffer, the VT will respond to any further request with "0000".

There follows a list of permissible commands.

Table 39.9: Command characters with terminal in network.

Command	Parameters	Effect
<ESC>Ixx<EOT>	xx = 01...31	Addresses a terminal to communicate with
<ESC>T<EOT>	xx = Number of keys in buffer yy = Hex. code of key sent	Asks VT for keys from its internal buffer. The VT's response is xxyy in Ascii format.
<ESC>Dkkmm<EOT>	kk = 00 ->Never sends any key (Default) 01 ->Transmits the key only when the VT is addressed or when it has the address 00 mm = 00 -> Always saves the key in the VT's internal buffer (Default) 01 ->Saves the key in the VT's internal buffer only when the VT is addressed	Modifies the mode of saving and sending keys of a VT within the network.

Example of handling

Let us suppose we have a VT50 that has to display the text “GOOD MORNING OPERATOR” centered on the display and, when  is pressed is canceled and replaced by the word “READY” justified top left.

There are various ways of proceeding, each leading to the same result; what follows is just one example.

Prepare the VT50 for communication by using *Free Terminal*. To do this, transfer the appropriate driver (see Page 39-2) and set the various communication parameters (see Page 39-3). Once the settings have been completed the following page appears

VT-50 TERMINAL Vx.xx

First check that the VT communicates with the device. Send the following string.

<ESC>Y<EOT>

If communication has been correctly established, the VT responds with the following message.

<OK>

At this point the device must interpret the response and control begins.

First cancel the display. Send the following string.

<ESC>C<EOT>

The display is cleared and the cursor goes automatically to the top left corner with the 0,0 (y,x) co-ordinate.

-

Position the cursor at co-ordinate 0,5 (y,x). Send the following string.

<ESC>A0005<EOT>

Now the display looks like this:



Send the first part of the text to be displayed “GOOD MORNING”. Send the following string.

GOOD MORNING

The display now shows

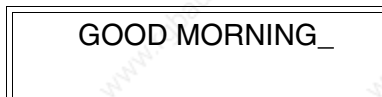

Position the cursor on the co-ordinate 1,5 (y,x). Send the following string.

<ESC>A0105<EOT>

The display now shows

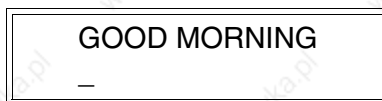

Send the rest of the text to be displayed: “OPERATOR”. Send the following string.

OPERATOR

The display now shows



At this point the device must be set up to control the keys when pressed;

when  is pressed the VT responds with the following character.

<CR>

The device must interpret and send the string for canceling the text. Send the following string.

`<ESC>C<EOT>`

The display is now cleared and the cursor positioned automatically in the top left corner with the coordinate 0,0 (y,x)



Now send the text to be displayed "READY". Send the following string.

`READY`

The display now shows

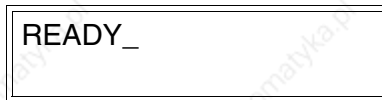

The above represents only a simple example of how to use the *Free Terminal*.

Chapter 40 Connection cables

Contents	Page
General notes	40-4
Connecting the cable shield	40-5
MSP<->ASP conversion	40-7
ELECTREX NETWORK ANALYZER	40-8
ABB DRIVE	40-8
ALLEN-BRADLEY DRIVE	40-9
ATLAS COPCO DRIVE	40-10
BERGER-LAHR DRIVE	40-11
CONTROL TECHNIQUES DRIVE	40-11
DANFOSS DRIVE	40-12
ELAU DRIVE	40-13
EUROTHERM DRIVE	40-14
EVER DRIVE	40-15
FANUC ROBOTICS DRIVE	40-15
FAGOR DRIVE	40-16
GALIL DRIVE	40-17
GE DRIVE	40-17
HITACHI DRIVE	40-17
KEB DRIVE	40-18
INDRAMAT DRIVE	40-19
LENZE DRIVE	40-19
OMRON DRIVE	40-21
OSAI DRIVE	40-21
PANASONIC DRIVE	40-21
PARKER AUTOMATION DRIVE	40-22
ROBOX DRIVE	40-23

This chapter consists of 84 pages.

Contents	Page
S.B.C. DRIVE	40-24
SEW-EURODRIVE DRIVE	40-25
SIEI DRIVE	40-26
SIEMENS DRIVE	40-26
STÖBER DRIVE	40-27
TDE MACNO DRIVE	40-27
TELEMECANIQUE DRIVE	40-28
TRIO MOTION DRIVE	40-28
DATALOGIC BARCODE READER	40-29
ABB PLC	40-30
AEG MODICON PLC	40-33
ALLEN-BRADLEY PLC	40-34
ALTUS PLC	40-38
ATOS PLC	40-39
BECKHOFF PLC	40-40
BOSCH PLC	40-42
B&R AUTOMATION PLC	40-42
CROUZET RPX PLC	40-42
FOXBORO PLC	40-43
FUJI PLC	40-43
GE FANUC PLC	40-44
GEFRAN PLC	40-45
LG PLC	40-52
HITACHI PLC	40-46
IDEC IZUMI PLC	40-48
KLÖCKNER MOELLER PLC	40-49
KEYENCE PLC	40-50
KOYO PLC	40-50
KUHNKE PLC	40-52

This chapter consists of 84 pages.

Contents	Page
MATSUSHITA-NAIS PLC	40-54
MICROLINK PLC	40-56
MITSUBISHI PLC	40-56
OMRON PLC	40-58
SAIA PLC	40-60
SATT CONTROL PLC	40-64
SCHLEICHER PLC	40-65
SIEMENS PLC	40-66
SPRECHER+SCHUH PLC	40-69
SQUARE-D PLC	40-69
TELEMECANIQUE PLC	40-70
TEXAS INSTRUMENTS PLC	40-74
TOSHIBA PLC	40-76
HBM BALANCE SCALES	40-77
ASCON THERMOREGULATOR	40-78
GEFRAN THERMOREGULATOR	40-78
HENGSTLER THERMOREGULATOR	40-79
WEST THERMOREGULATOR	40-80
Cable information summary	40-81

This chapter consists of 84 pages.

All VTs communicate with other devices using serial port communication. In this chapter you will find information on all the cables used to connect with various devices together with their order codes.

 **Those cables marked NOT CODED are not supplied by ESA elettronica but listed here nonetheless to make it easier for the user to make them.**

General notes

Serial communications are highly susceptible to disturbances, so, in order to limit as much as possible the influence of these disturbances good quality shielded cables must be used.

The table below lists the characteristics of the cable to be used for serial connection.

Specifications of serial connection cable	
Direct current resistance	Max. 151 Ohm/Km
Capacity coupling	Max. 29pF/m
Shielding	> 80% or total

 **Particular care should be taken in the choice and lay-out of cables, specially with regard to the VT <-> Device connection serial cable.**

Always:

- Find the shortest route
- Lay disturbed cables separately

 **Disconnect the power supply before connecting or disconnecting the communication cables so as to avoid possible damage to the VT and/or the connected device.**

Connecting the cable shield

It is essential for the interface cables between the VT and the Device be correctly shielded in order to ensure that serial communication occurs free from all types of external interference. For this reason all the cables listed in this manual absolutely must be shielded cables and the “D-sub” connectors both on the VT side and the Device side must have metal or conductive plastic shells.

The diagram below shows the correct way of connecting the shield.

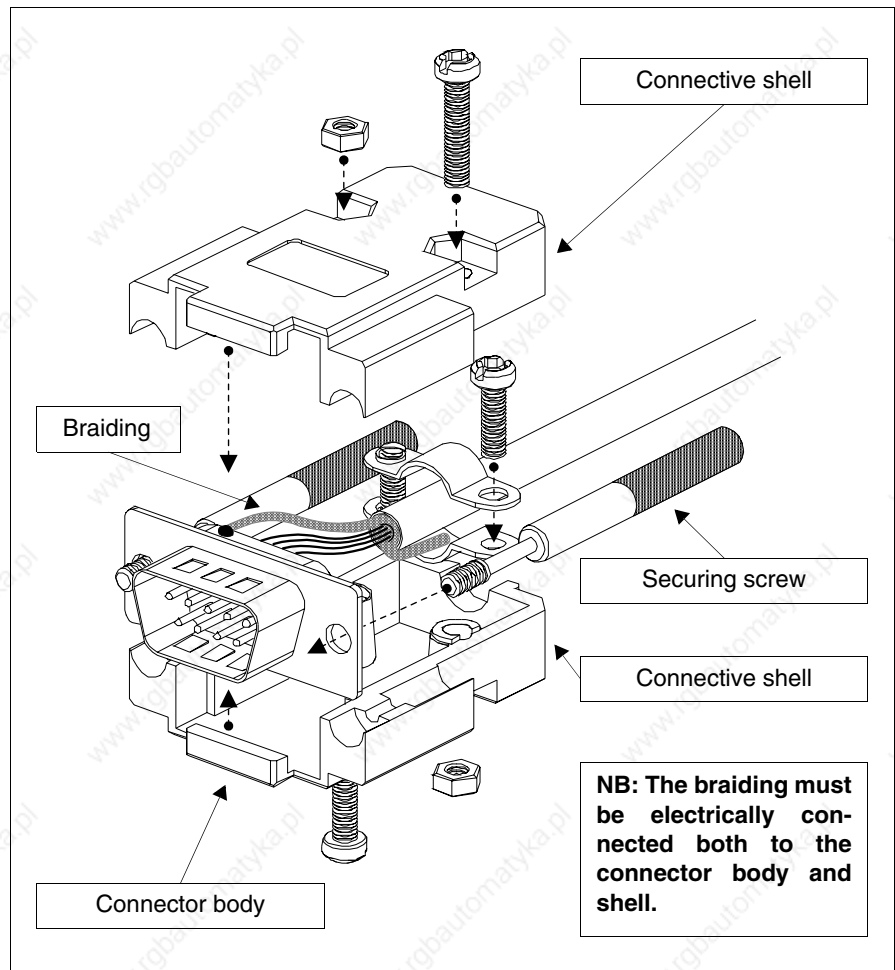

The interface cable braiding must be electrically connected both to the shell and the body of the connector at both ends of the cable.

If the connection operation cannot be carried out at the Device side due to the particular type of serial connector, the braiding will have to be taken outside the connector and connected to the earth terminal.

This operation must also be carried out if the body of the Device’s serial connector, although of a standard type, is not electrically connected to the

earth terminal of the PLC itself.

Note that in this situation the shield must still be connected both to the shell and the body of the connector.

Certain cable diagrams show the pin connections of the shield signals on the Device side: in these cases, not only does the above apply but the shield must also be connected to them.

In any event the shield must never be connected on the VT side (pin 1).

⚠ Earth potentials obtained from DIN guides, structural elements of the machines, electrical cabinet doors etc. are not admissible and it is a good idea to avoid unipotential earth bars which receive earth connections from loads such as inverters, drives, stepper motors and, generally speaking, any type of load which could be a source of strong disturbance.

⚠ The Device-VT serial communication cable must be single piece. Terminal-type joins and PLUG+SOCKET arrangements are inadmissible. Should the installation system in question necessitate that breaks be made (although this is inadvisable) it will be ABSOLUTELY necessary to implement the following:

- Use D-SUB (Db9, Db15 o DB25) connectors with metal or conductive plastic shells.
- Connect the serial cable shield in accordance with the instructions on this page.
- Limit the number of breaks to those absolutely unavoidable.

Failure to observe these instructions could prejudice the compatibility of the VT-PLC system with the EMC standards currently in force.

MSP<->ASP conversion

The cables referred to in this chapter are designed to be connected to the MSP port of the VT terminal; if you need to use a coded on the ASP port, it will be necessary to use the adapters listed below.

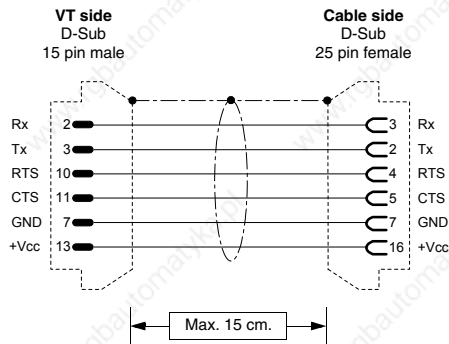

**Order code:
NOT CODED**

Conversion from MSP to ASP

(RS232)

(See "Chapter 40 -> Connecting the cable shield")

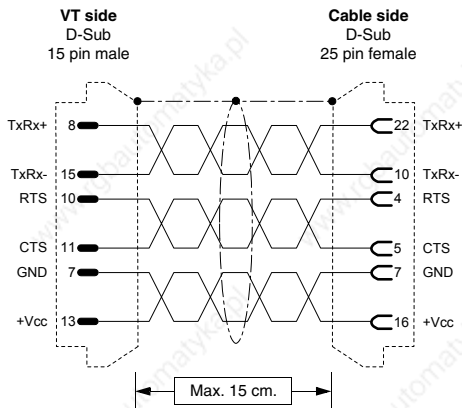

**Order code:
NOT CODED**

Conversion from MSP to ASP

(RS485)

(See "Chapter 40 -> Connecting the cable shield")

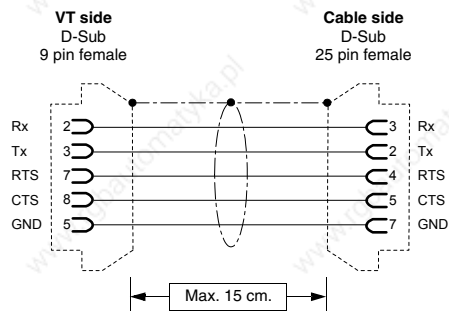

**Order code:
NOT CODED**

Conversion from MSP to ASP-9

(RS232)

(See "Chapter 40 -> Connecting the cable shield")

ELECTREX NETWORK ANALYZER

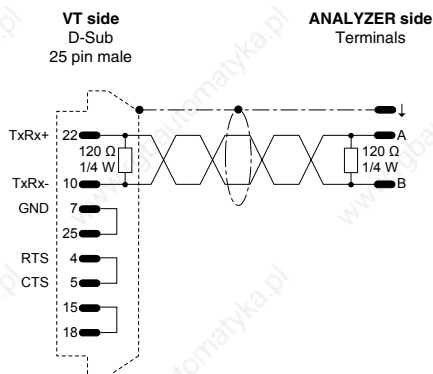

Order code:
NOT CODED

DEPT-485

(RS485)

(See "Chapter 40 -> Connecting the cable shield")

JUMPER SETTINGS

Data Format



Dip-switch 4

ABB DRIVE

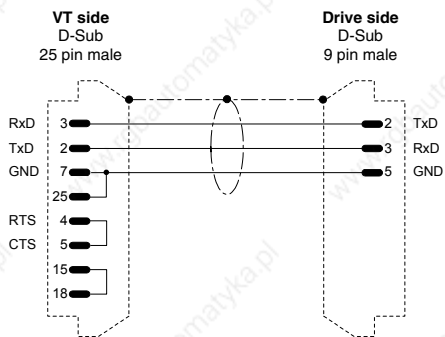

Order code:
NOT CODED

INDAX - TRIAX - PENTAX

(RS232)

NOTE: The length of the cable must not exceed 3 meters with a transmission speed of 38400 Baud.

(See "Chapter 40 -> Connecting the cable shield")

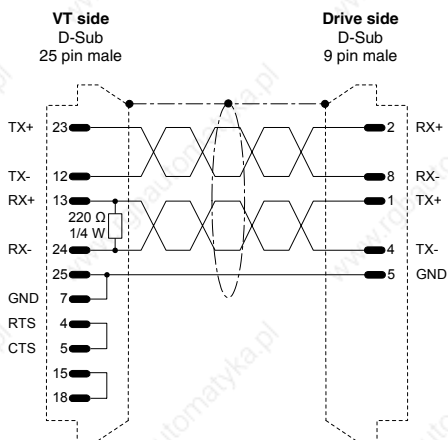

Order code:
NOT CODED

INDAX - TRIAX - PENTAX

(RS422)

(See "Chapter 40 -> Connecting the cable shield")

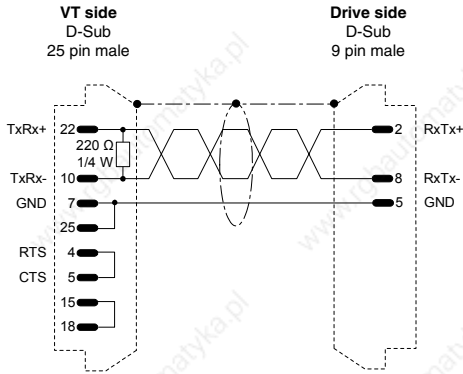

**Order code:
NOT CODED**

INDAX - TRIAX - PENTAX
(RS485)
(See "Chapter 40 -> Connecting the cable shield")

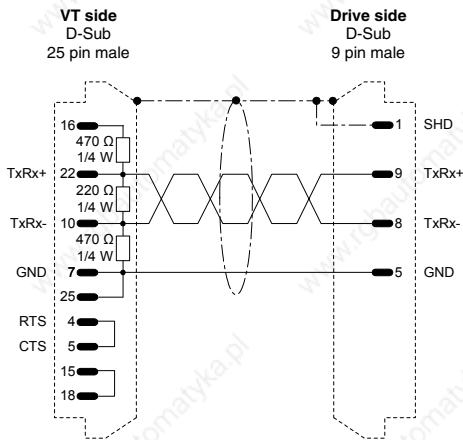

**Order code:
NOT CODED**

BIVECTOR Series 300
(RS485)
(See "Chapter 40 -> Connecting the cable shield")

ALLEN-BRADLEY DRIVE

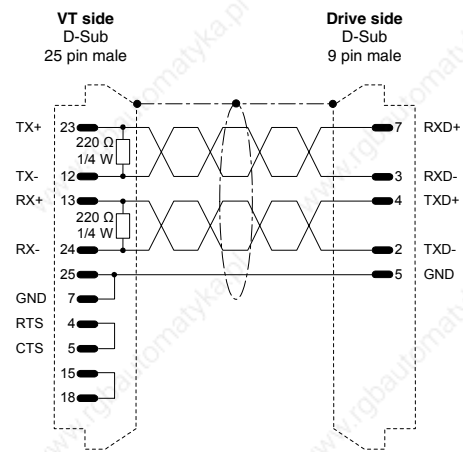

**Order code:
NOT CODED**

IMC S CLASS
(RS422)
ATTENTION!!! Valid only for MSP
(See "Chapter 40 -> Connecting the cable shield")

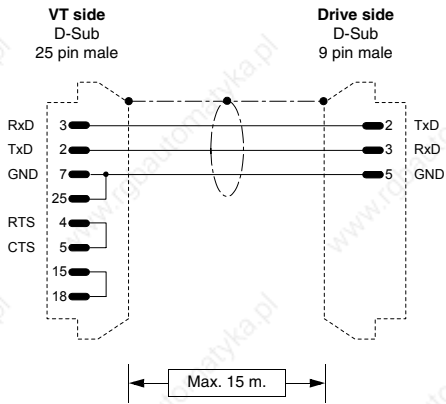

Order code:
NOT CODED

IMC S CLASS
(RS232)
ATTENTION!!! Valid only for MSP
(See "Chapter 40 -> Connecting the cable shield")

ATLAS COPCO DRIVE

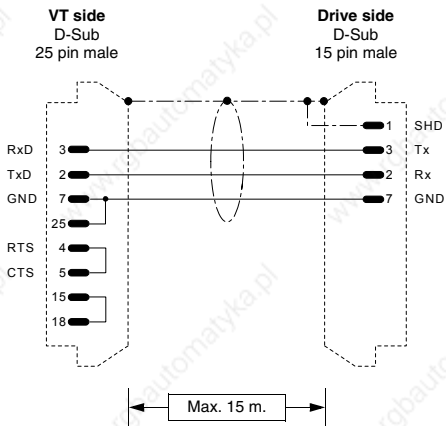

Order code:
NOT CODED

Series DMC
(RS232)
N.B.: On the device set protocol **Computer Mode** with the aid of **ATLAS DMC User's manual**.
(See "Chapter 40 -> Connecting the cable shield")

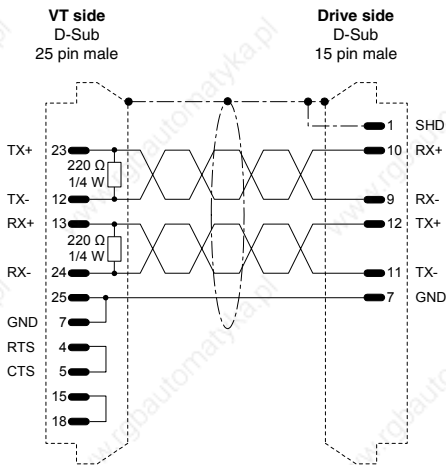

Order code:
NOT CODED

Series DMC
(RS422)
N.B.: On the device set protocol **Computer Mode** with the aid of **ATLAS DMC User's manual**.
(See "Chapter 40 -> Connecting the cable shield")

BERGER-LAHR DRIVE

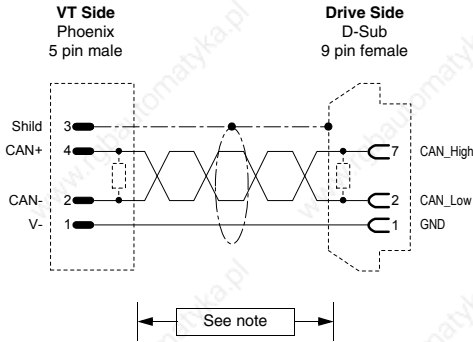

**Order code:
NOT CODED**

Twin Line

Card CAN-C required

(CAN)

For the VT side cable termination see "Chapter 34 -> CAN: Connection".

For the DRIVE side cable termination see Drive manual TLC53x.

NOTE: The max. length of the cable depends on the transmission speed.

Transmission speed (kbit/s)	Length (m.)
100	500
1000	40

(See "Chapter 40 -> Connecting the cable shield")

CONTROL TECHNIQUES DRIVE

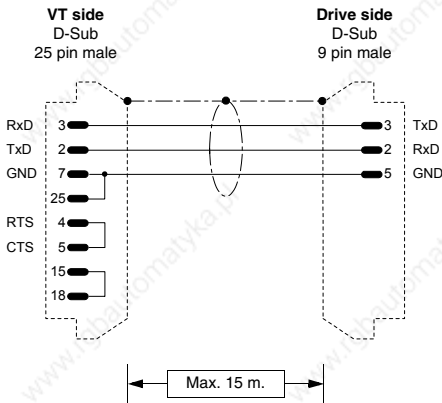

**Order code:
NOT CODED**

Unidrive

(RS232)

Communication card UD71 required

Set parameter 0.32 = ANSI2

(See "Chapter 40 -> Connecting the cable shield")

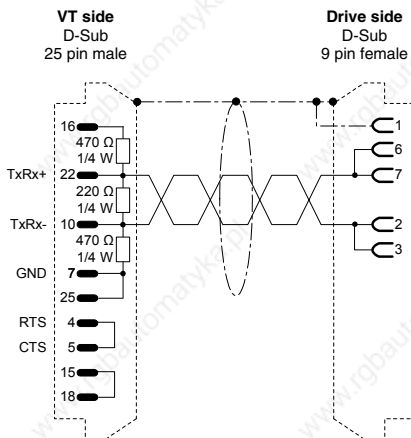

**Order code:
NOT CODED**

Unidrive

(RS485)

Communication card UD71 or UD70 required

UD71:

Set parameter 0.32 = ANSI2

UD70:

Set parameter 17.06 = 5 (ANSI2)

Set parameter 17.05 = (Serial address)

Set parameter 17.07 = (Baud rate)

(See "Chapter 40 -> Connecting the cable shield")

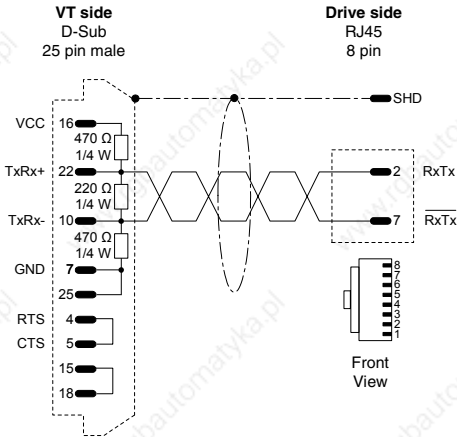

Order code:
CVPLC33102

Commander SE - CTNET
(RS485)

Set parameter 41 = ANSI
Set parameter 42 = (Baud rate)
Set parameter 43 = (Address)

(See "Chapter 40 -> Connecting the cable shield")

DANFOSS DRIVE

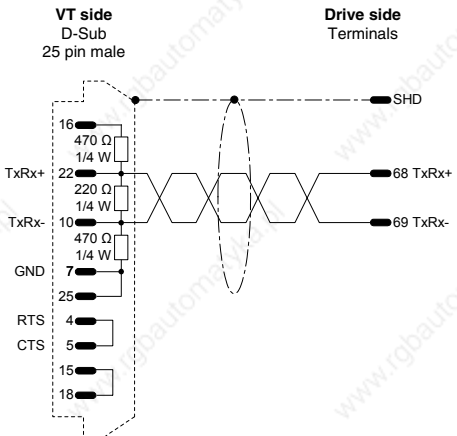

Order code:
NOT CODED

VLT2800/5000/6000
(RS485)

(See "Chapter 40 -> Connecting the cable shield")

ELAU DRIVE

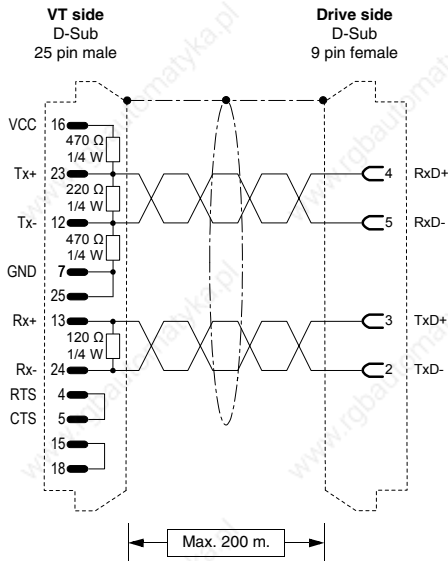

**Order code:
NOT CODED**

Max-4

(RS422)

See notes to follow.

(See "Chapter 40 -> Connecting the cable shield")

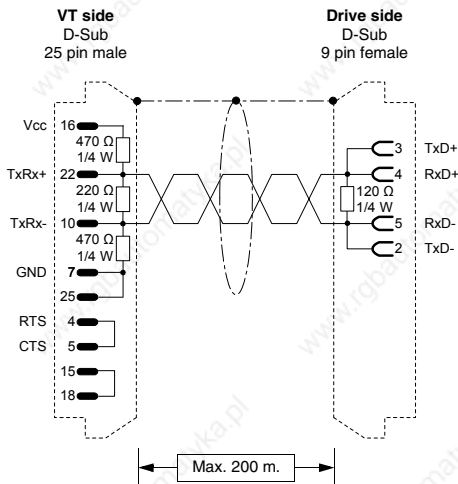

**Order code:
NOT CODED**

Max-4

(RS485)

See notes to follow.

(See "Chapter 40 -> Connecting the cable shield")

Communication between a VTxxxW device and ELAU Max-4 devices can be established by using the ModBus Master Slow Peripherals protocol and a communication speed between 9600 and 38400 baud.

You can use either a 4-wire RS422 or a 2-wire RS485 connection. In the latter case it is essential to use the ELAU ModBus_v001001.lib library or a later version. Using the RS485 connection allows you to connect more than one ELAU device to the same VT port.

The Function-Block prepared by ELAU makes available 4 data arrays, whose length can be defined by the user, for communication with the VT .

Characteristics of the arrays:

Name	Type of data	Notes
....B0000	Bit (read / write)	The VT accesses this data area in both read and write
....B0001	Bit (read only)	The VT cannot access this data area
....W3000	Word (read only)	The VT accesses this data area by selecting the option Input Register as data area of the variable in the VT . Warning: The programmer must check that the change of the data field of the VT page does not get enabled. If the change of the data field is enabled the equivalent address in ArrayW4000 will be overwritten.
....W4000	Word (read / write)	The VT accesses this data area in both read and write by selecting the option Word as data area.

N.B. :

- Defining the length of the arrays in the programming SW, ELAU puts the number 1 for the first element of the array; this implies the existence of an offset of 1 between the address of the array element and the address specified in the VT variable. E.g.: if, using the VT, you want to read and edit the element at single word 20 of the array ...W4000, number 19 will have to be specified as the address of the VT variable.
- To have retentive data in the ELAU device, the relevant array must be declared as VAR_RETAIN.
- Check that the ModBus address assigned in the configuration of the device in VTWIN corresponds to the value assigned to the parameter Modbus_SlaveNr of the ELAU Function Block.

EUROTHERM DRIVE

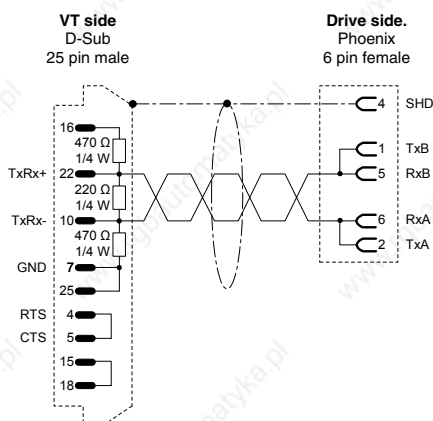

Order code:
NOT CODED

Series 605

(RS485)

Requires 584SV/605 communication card

WARNING!!! For Hardware configuration refer to manual "RS485 Communication Interface - HA463560 Issue 1" remembering that Dip-Switch SW1 DIP1 must be set at OFF and if it is the last in the chain DIP2 is set at ON (Terminated).

For Software configuration refer to the same manual, remembering that the protocol DBUS RTU must be selected.

(See "Chapter 40 -> Connecting the cable shield")

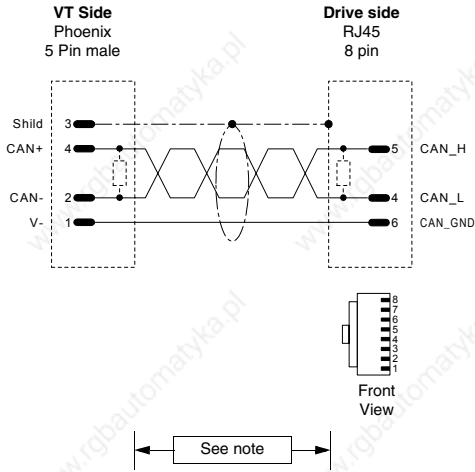

**Order code:
NOT CODED**

631CAN - 635CAN - 637CAN
(CAN)

For the VT side cable termination see "Chapter 34 -> CAN: Connection".

For the DRIVE side cable termination use the appropriate accessory "BUS termination plug" (see Drive manual) in connector X20/21.

NOTE: The max. length of the cable depends on the transmission speed.

Transmission speed (kbit/s)	Length (m.)
20	800
50	600
125	500
250	250
500	100
1000	25

(See "Chapter 40 -> Connecting the cable shield")

EVER DRIVE

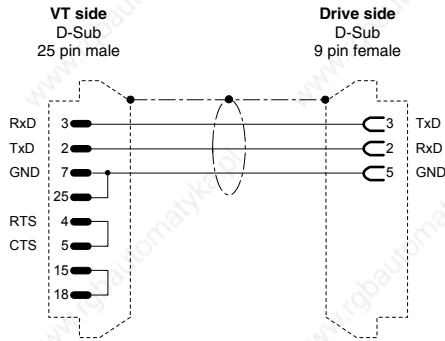

**Order code:
NOT CODED**

Ever MPP14-01
(RS232)

(See "Chapter 40 -> Connecting the cable shield")

FANUC ROBOTICS DRIVE

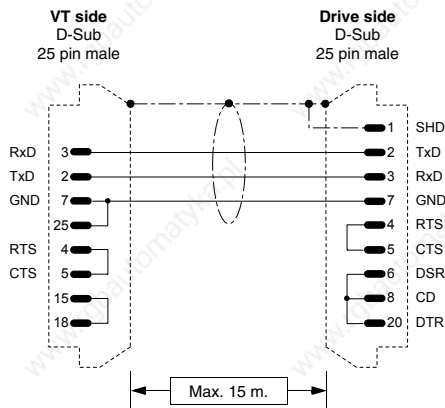

**Order code:
NOT CODED**

R-J controllers
(RS232)

(See "Chapter 40 -> Connecting the cable shield")

FAGOR DRIVE

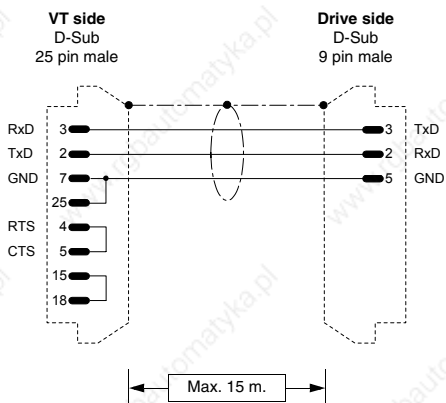

**Order code:
NOT CODED**

DNC PROTOCOL
(RS232)
(See "Chapter 40 -> Connecting the cable shield")

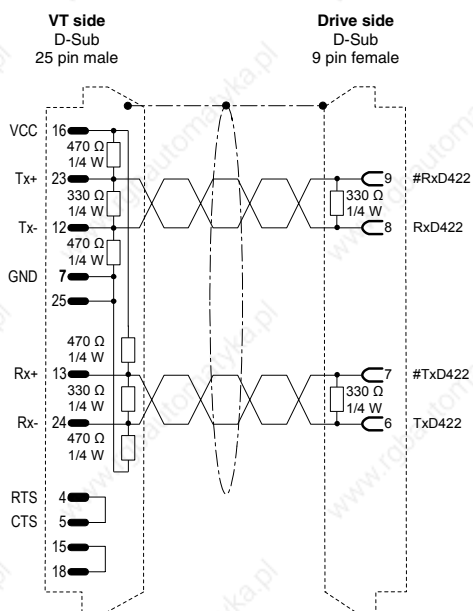

**Order code:
NOT CODED**

DNC PROTOCOL
(RS422)
(See "Chapter 40 -> Connecting the cable shield")

GALIL DRIVE

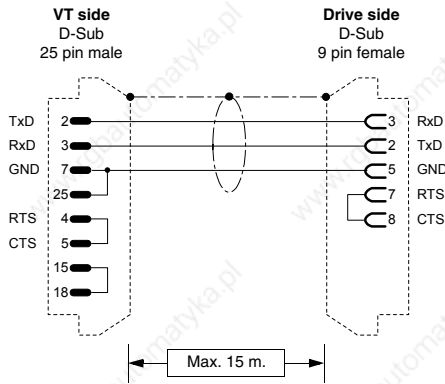

Order code:
NOT CODED

Série DMC 2x00
(RS232)
(See "Chapter 40 -> Connecting the cable shield")

GE DRIVE

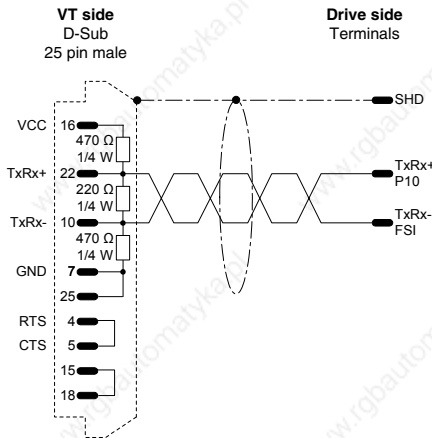

Order code:
NOT CODED

VAT-23D
(RS485)
(See "Chapter 40 -> Connecting the cable shield")

HITACHI DRIVE

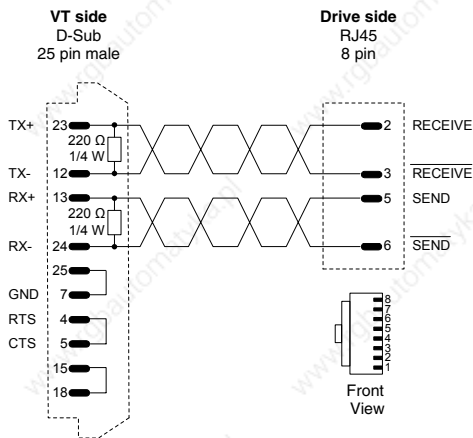

Order code:
NOT CODED

L-100
(RS422)
(See "Chapter 40 -> Connecting the cable shield")

KEB DRIVE

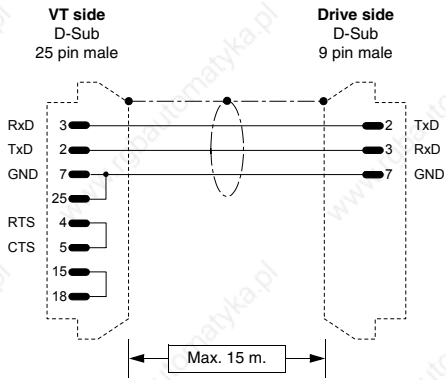

**Order code:
NOT CODED**

Combivert F4C - F4S
(RS232)
(See "Chapter 40 -> Connecting the cable shield")

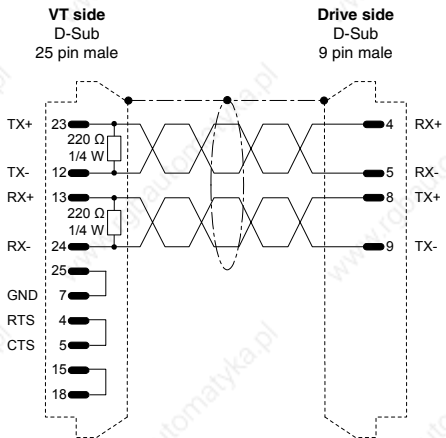

**Order code:
NOT CODED**

Combivert F4C - F4S
(RS422)
(See "Chapter 40 -> Connecting the cable shield")

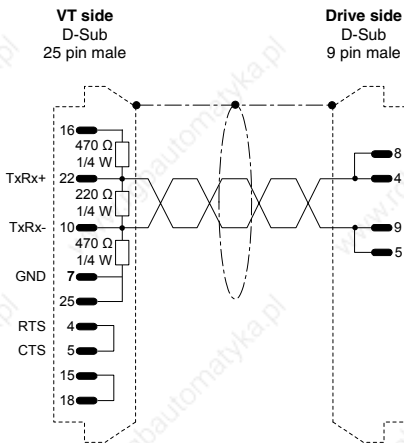

**Order code:
NOT CODED**

Combivert F4C - F4S
(RS485)
(See "Chapter 40 -> Connecting the cable shield")

INDRAMAT DRIVE

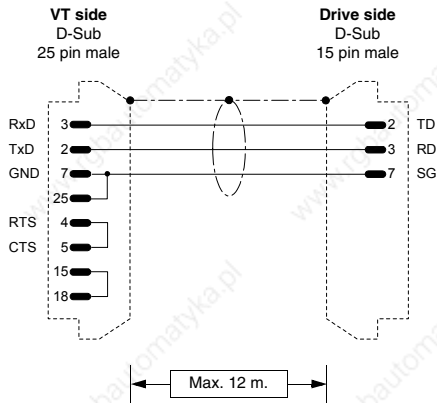

Order code:
NOT CODED

PCCR0-GP1
(RS232)

SERIAL PORT 1 connection requires no parametrization, while the TYPE parameter like ASCII HOST needs to be set for SERIAL PORT 2. The MODE parameter must be set as RS232.

(See "Chapter 40 -> Connecting the cable shield")

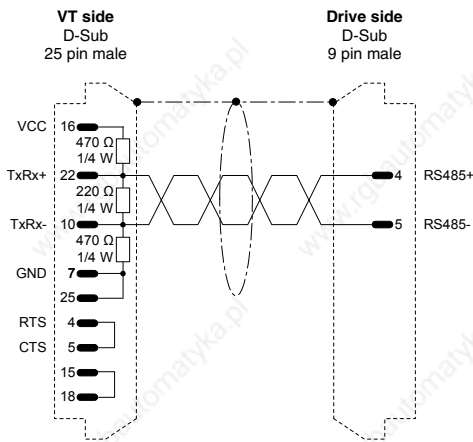

Order code:
NOT CODED

PCCR0-GP1
(RS485)

SERIAL PORT 1 connection requires no parametrization, while the TYPE parameter like ASCII HOST needs to be set for SERIAL PORT 2. The MODE parameter must be set as RS485.

(See "Chapter 40 -> Connecting the cable shield")

LENZE DRIVE

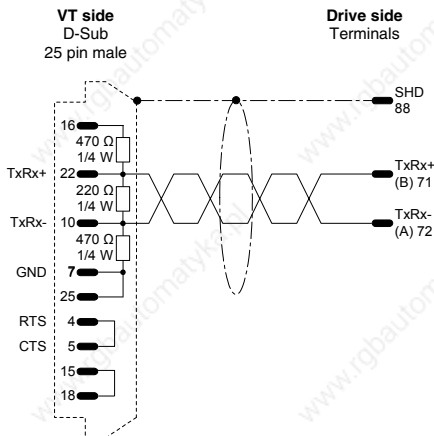

Order code:
NOT CODED

Series 82x
(RS485)

(See "Chapter 40 -> Connecting the cable shield")

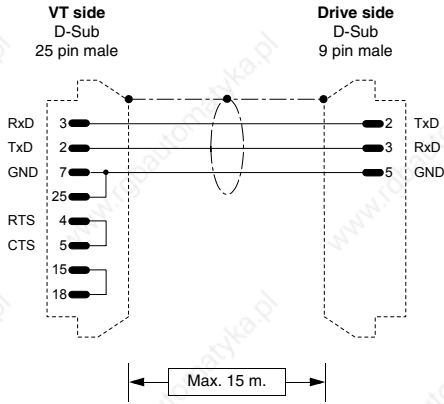

**Order code:
NOT CODED**

Series 82x
(RS232)
(See "Chapter 40 -> Connecting the cable shield")

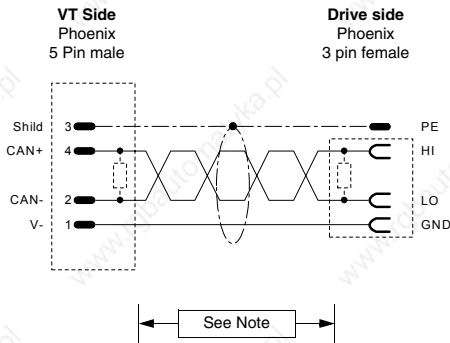

**Order code:
NOT CODED**

Series 93xx
(CAN)
For the VT side cable termination see "Chapter 34 -> CAN: Connection".
For the DRIVE side cable termination use the related resistance (120Ohms, supplied with the device) between the HI and LO terminals in the X4 connector (see also Drive manual).
NOTE: The length depends on the type of cable.

Length (m)	Type of cable	Resistance (Ohm/Km)	Capacity (nF/Km)
=<300	LIYCY 2x2x0.5 mmq	=<40	=<130
=<1000	CYPIMF 2x2x0.5 mmq	=<40	=<60

(See "Chapter 40 -> Connecting the cable shield")

LUST DRIVE

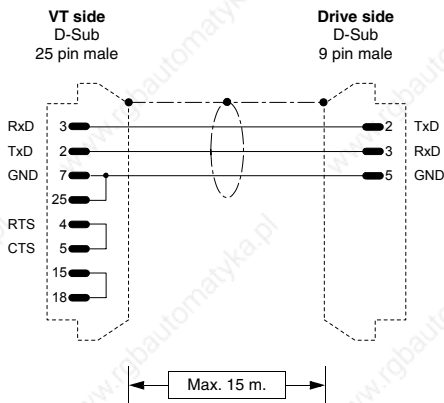

**Order code:
NOT CODED**

C-Line Drive
(RS232)
(See "Chapter 40 -> Connecting the cable shield")

OMRON DRIVE

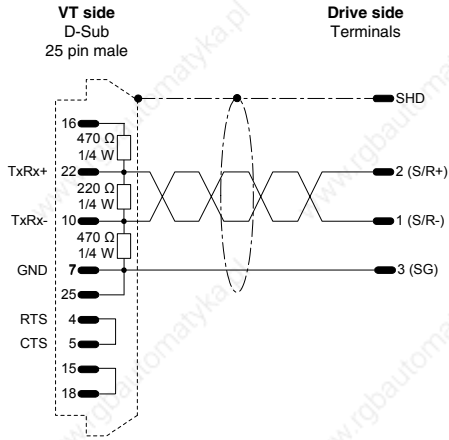

**Order code:
NOT CODED**

3G3EV

Card PJVOP485 required

(RS485)

MODBUS RTU STANDARD PROTOCOL

(See "Chapter 40 -> Connecting the cable shield")

OSAI DRIVE

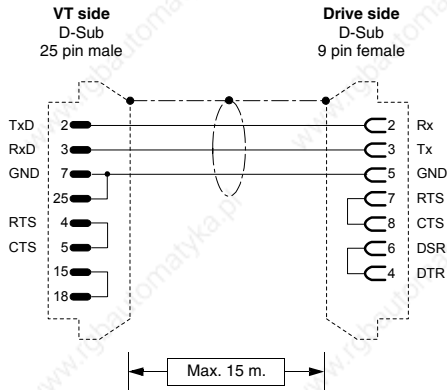

**Order code:
NOT CODED**

10 Series GP

(RS232)

See "Chapter 40 -> Connecting the cable shield")

PANASONIC DRIVE

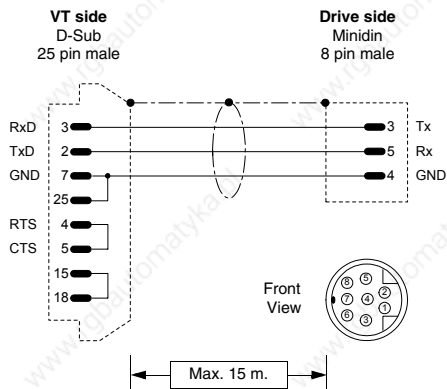

**Order code:
NOT CODED**

MSS*XP Series

(RS232)

(See "Chapter 40 -> Connecting the cable shield")

PARKER AUTOMATION DRIVE

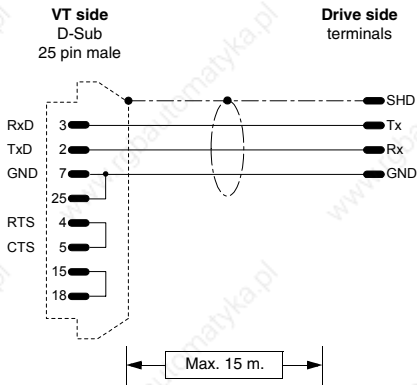

**Order code:
NOT CODED**

6000/ZETA Controller
COM1 serial port

(RS232)

(See "Chapter 40 -> Connecting the cable shield")

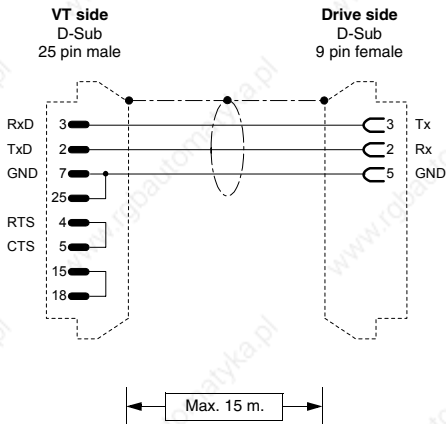

**Order code:
NOT CODED**

COMPUMOTOR 6K

(RS232)

Dip-Switch SW1:

- 1 -> OFF
- 2 -> OFF
- 3 -> OFF
- 4 -> OFF
- 5 -> OFF
- 6 -> OFF
- 7 -> OFF
- 8 -> OFF

WARNING!!! For Hardware configuration refer to manual "6K Series Hardware Installation Guide".

(See "Chapter 40 -> Connecting the cable shield")

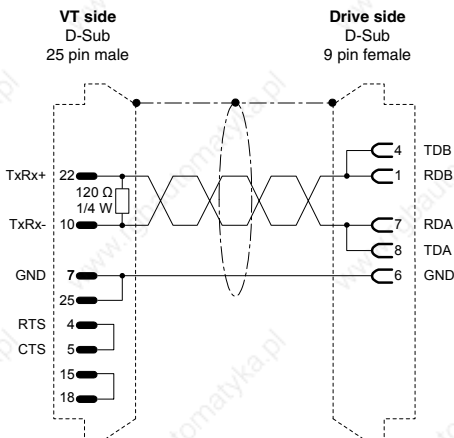

**Order code:
NOT CODED**

COMPUMOTOR 6K

(RS485)

Dip-Switch SW1:

- 1 -> OFF (ON - Only if the last node)
- 2 -> OFF (ON - Only if the last node)
- 3 -> OFF
- 4 -> OFF
- 5 -> OFF
- 6 -> OFF
- 7 -> OFF
- 8 -> OFF

WARNING!!! For Hardware configuration refer to manual "6K Series Hardware Installation Guide".

(See "Chapter 40 -> Connecting the cable shield")

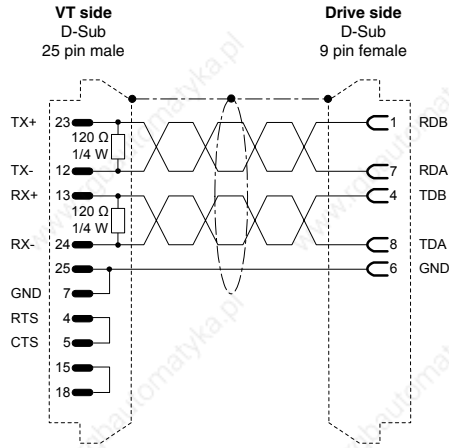

**Order code:
NOT CODED**

COMPUMOTOR 6K
(RS422)

Dip-Switch SW1:
 11 -> OFF (ON - Only if the last node)
 2 -> OFF (ON - Only if the last node)
 3 -> OFF
 4 -> OFF
 5 -> OFF
 6 -> OFF
 7 -> OFF
 8 -> OFF

WARNING!!! For Hardware configuration refer to manual "6K Series Hardware Installation Guide".

(See "Chapter 40 -> Connecting the cable shield")

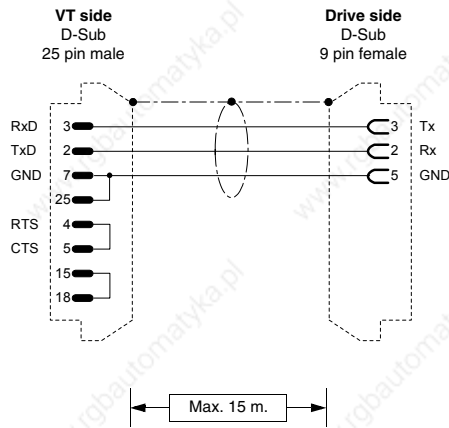

**Order code:
NOT CODED**

GT6/GV6 Controller
(RS232)

(See "Chapter 40 -> Connecting the cable shield")

ROBOX DRIVE

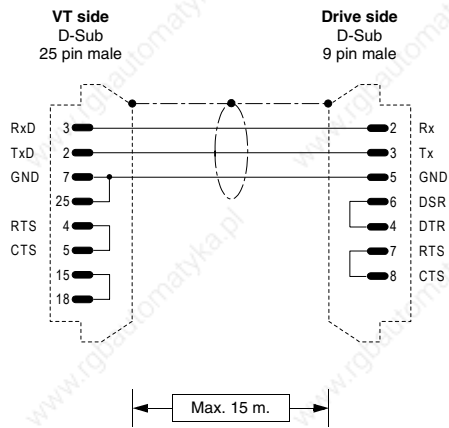

**Order code:
NOT CODED**

RBXE/RBXM
Serial ports: P.SER1 - P.SER2
(RS232)

See "Chapter 40 -> Connecting the cable shield")

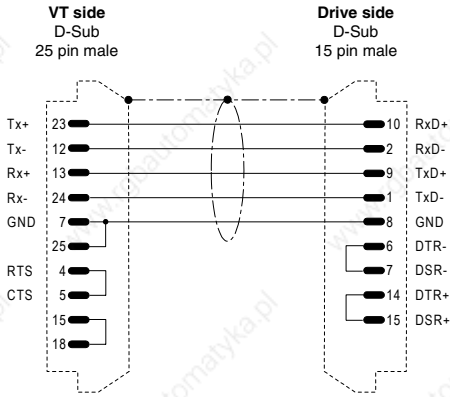

**Order code:
NOT CODED**

RBXE/RBXM
Serial ports: P.SER3 - P.SER4
(RS422)
See "Chapter 40 -> Connecting the cable shield"

S.B.C. DRIVE

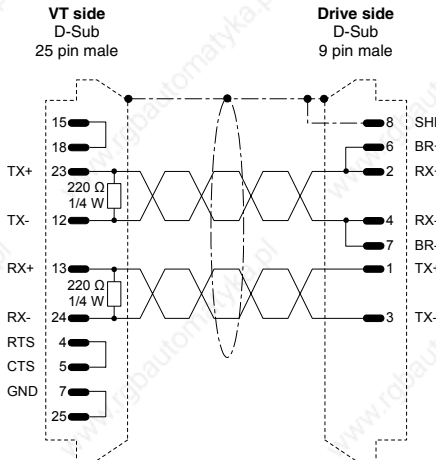

**Order code:
NOT CODED**

HPD 2 - 5 - 8 - 16
(RS422)
Device address: 0...31
(See "Chapter 40 -> Connecting the cable shield")

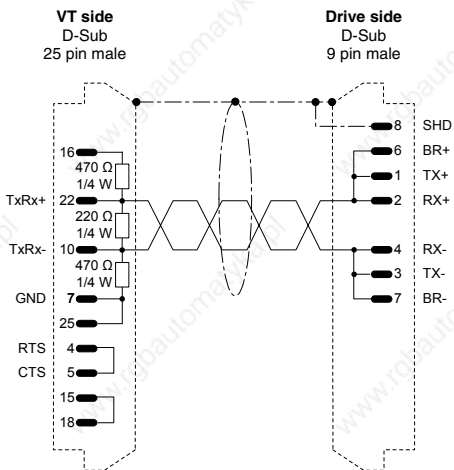

**Order code:
NOT CODED**

HPD 2 - 5 - 8 - 16
(RS485)
Device address: 0...31
(See "Chapter 40 -> Connecting the cable shield")

SEW-EURODRIVE DRIVE

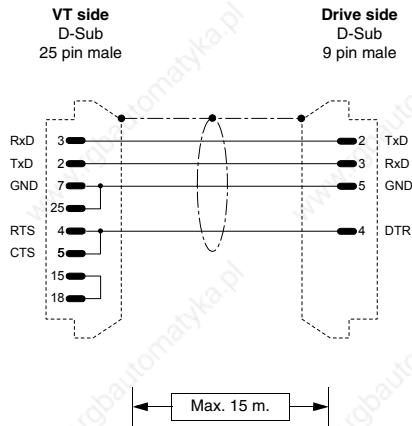

Order code:
NOT CODED

MOVIDYN
(RS232)

Communication card SEW-EURODRIVE USS21A required

N.B: Not valid for terminals VT50 and VT60.
(See "Chapter 40 -> Connecting the cable shield")

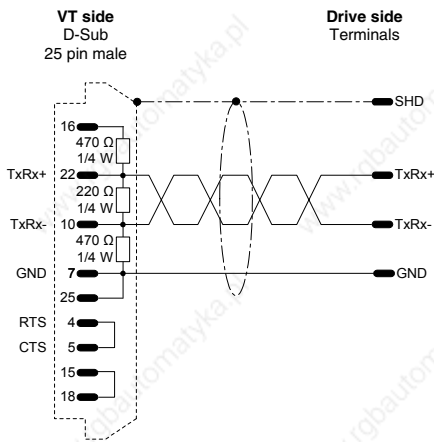

Order code:
NOT CODED

MOVIDYN
(RS485)

Communication card SEW-EURODRIVE USS21A required

(See "Chapter 40 -> Connecting the cable shield")

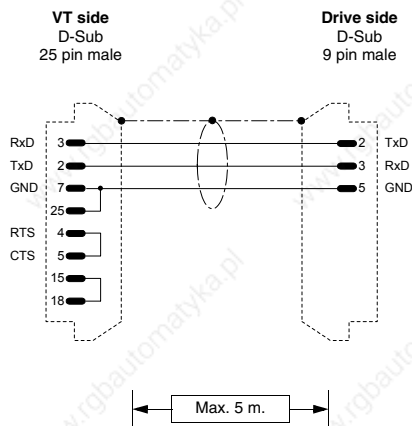

Order code:
NOT CODED

MOVITRAC - MOVIDRIVE
(RS232)

Communication card SEW-EURODRIVE USS21A required

(See "Chapter 40 -> Connecting the cable shield")

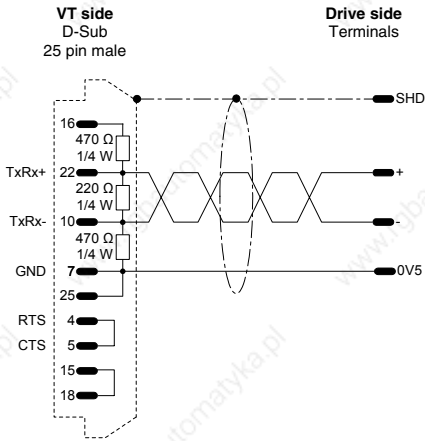

**Order code:
NOT CODED**

MOVITRAC - MOVIDRIVE
(RS485)

Communication card SEW-EURODRIVE USS21A required
(See "Chapter 40 -> Connecting the cable shield")

SIEI DRIVE

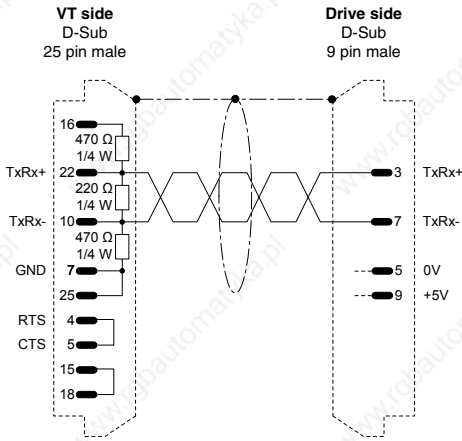

**Order code:
NOT CODED**

SLINK 3
(RS485)

WARNING!!!
If the jumpers S18 and S19 on the regulator card are in position A (serial line galvanically isolated from the regulator section), pin 5 and 9 must be connected to the power unit.
(See "Chapter 40 -> Connecting the cable shield")

SIEMENS DRIVE

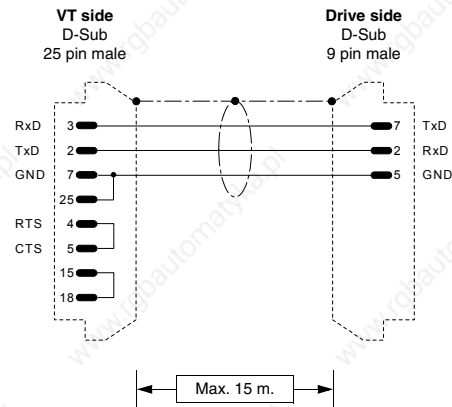

**Order code:
NOT CODED**

SIMOVERT
(RS232)

(See "Chapter 40 -> Connecting the cable shield")

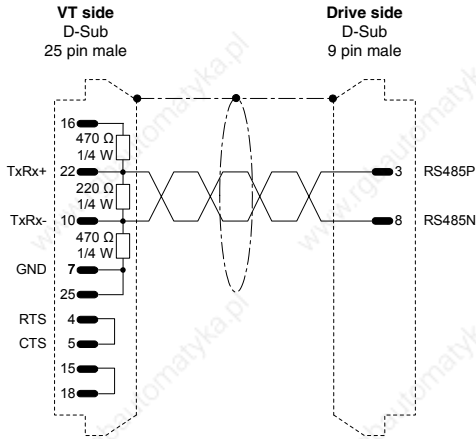

**Order code:
NOT CODED**

SIMOVERT
(RS485)
(See "Chapter 40 -> Connecting the cable shield")

STÖBER DRIVE

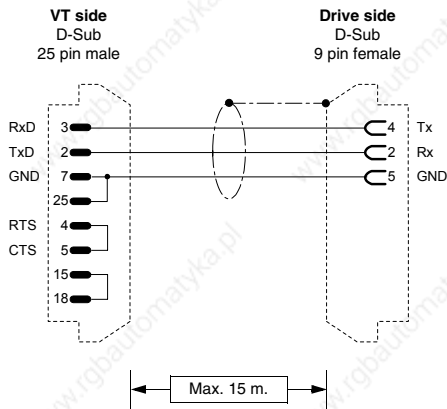

**Order code:
NOT CODED**

FAS / FDS / SDS 4000
(RS232)
(See "Chapter 40 -> Connecting the cable shield")

TDE MACNO DRIVE

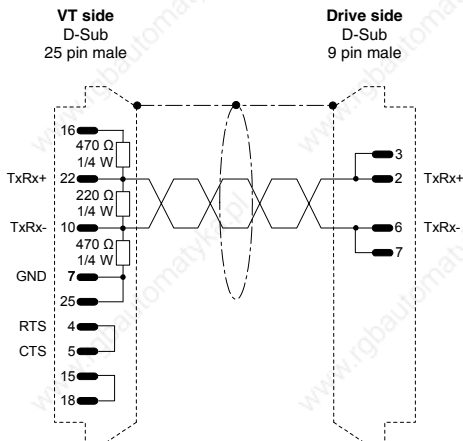

**Order code:
NOT CODED**

DMBL Series
(RS485)
(See "Chapter 40 -> Connecting the cable shield")

TELEMECANIQUE DRIVE

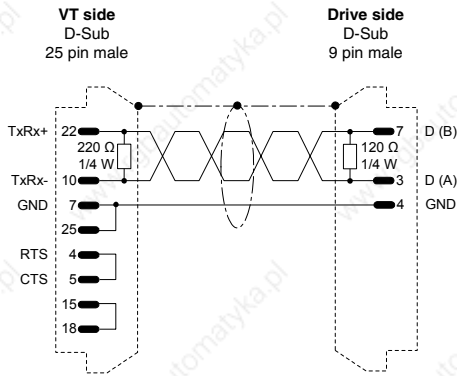

**Order code:
NOT CODED**

ALTIVAR 58
(RS485)
(See "Chapter 40 -> Connecting the cable shield")

TRIO MOTION DRIVE

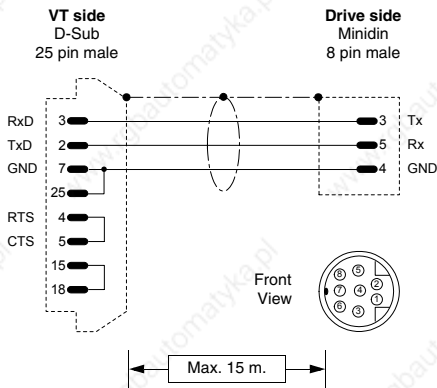

**Order code:
NOT CODED**

TRIO MOTION Modbus
(RS232)
(See "Chapter 40 -> Connecting the cable shield")

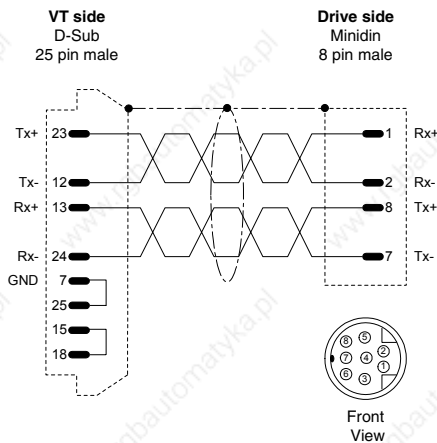

**Order code:
NOT CODED**

TRIO MOTION Modbus
(RS422)
(See "Chapter 40 -> Connecting the cable shield")

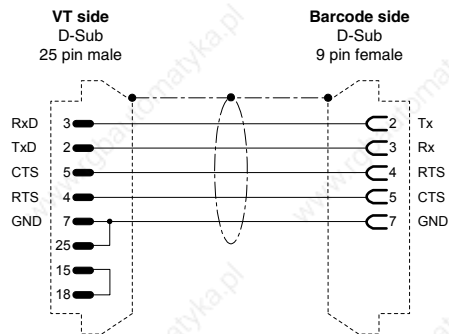
DATALOGIC BARCODE READER

**Order code:
NOT CODED**

DL-910

(RS232)

(See "Chapter 40 -> Connecting the cable shield")

ABB PLC

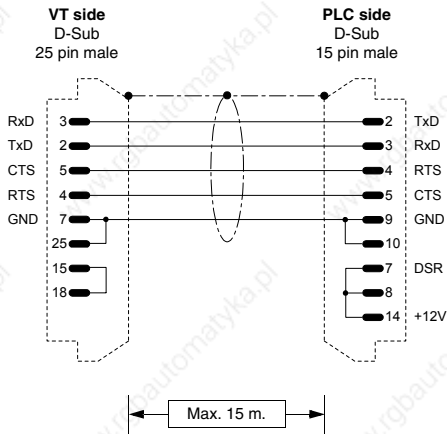

Order code:
CVPLC03102

T200 (KP60)

(RS232)

(See "Chapter 40 -> Connecting the cable shield")

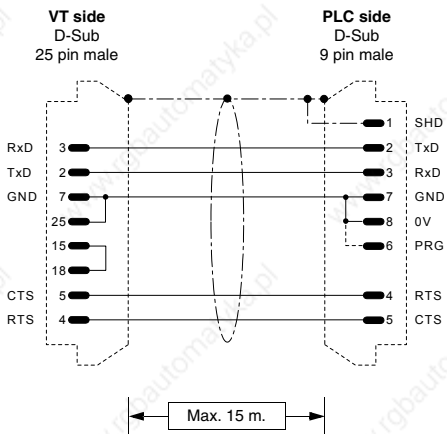

Order code:
CVPLC14102

CS31 (KR31 / KT31 / KR91 / KT92 / KT93 / KT94 / KT95)
T200 (KP62)

(RS232)

This note only applies to protocol of CS31 series 90 (non direct). Once the VT has been connected to and disconnected from the CS31, the PLC remains in MONITOR mode and the programming software no longer functions properly. To get the PLC back to normal functioning, use the programming S/W to access the "PLC commun.2" menu and select the "3 terminal emulation" option and press the "CTRL" and "W" keys together. At the end the PLC responds by offering the prompt sign ">".

NOTE ON DIRECT PROTOCOL: You can select the communication speed of 19200 Baud in the PLC by connecting pins #6, #7 and #8 (see fig.). This speed is handled by CS31 only if the library module **CE 19_2COM1** is loaded.

NOTE: the cable supplied by ESA does not have the connection represented by the dotted line.

(See "Chapter 40 -> Connecting the cable shield")

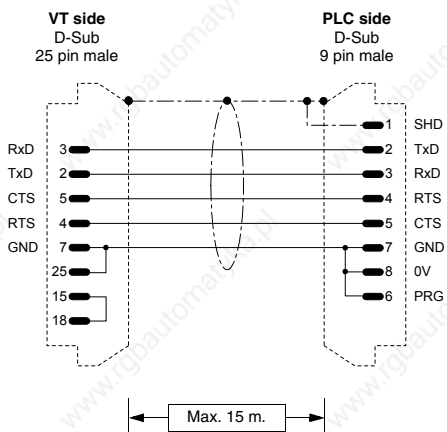

Order code:
CVPLC14202

CS31 (KR31 / KT31)

(RS232)

MODBUS RTU STANDARD PROTOCOL

(See "Chapter 40 -> Connecting the cable shield")

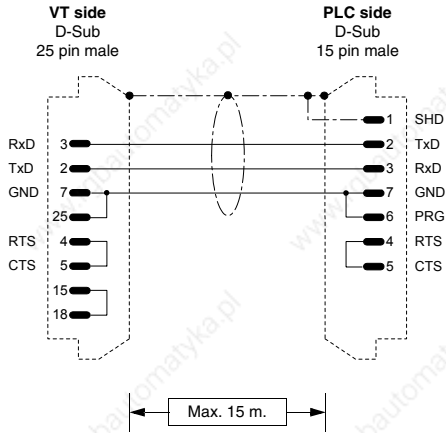

Order code:
CVPLC14302

CS31 (07KP92 R101)
MODBUS RTU Communication module, COM3 and COM4 ports
(RS232)

STANDARD MODBUS RTU PROTOCOL

(See "Chapter 40 -> Connecting the cable shield")

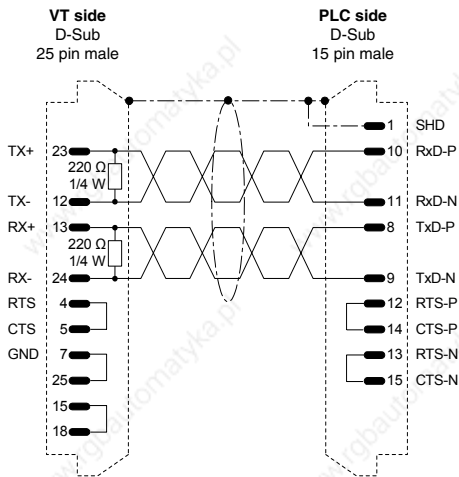

Order code:
CVPLC14402

CS31 (07KP92 R101)
MODBUS RTU Communication module, COM3 and COM4 ports
(RS422)

STANDARD MODBUS RTU PROTOCOL

(See "Chapter 40 -> Connecting the cable shield")

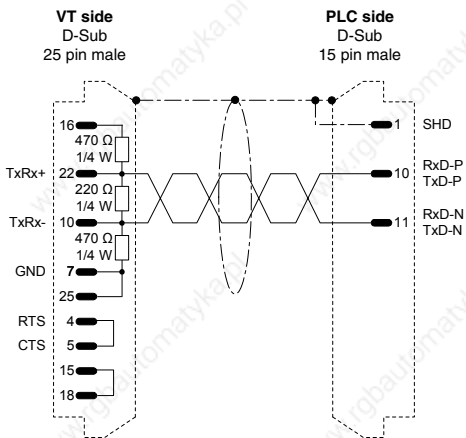

Order code:
CVPLC14502

CS31 (07KP92 R101)
MODBUS RTU Communication module, COM3 and COM4 ports
(RS485)

STANDARD MODBUS RTU PROTOCOL

(See "Chapter 40 -> Connecting the cable shield")

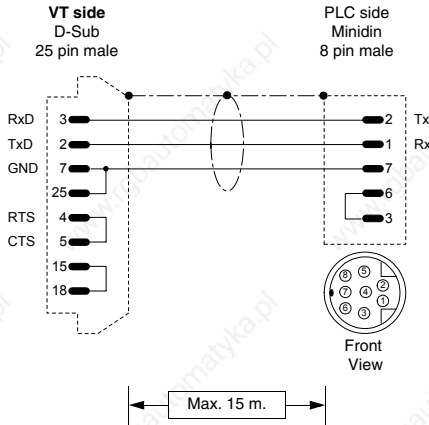

Order code:
CVPLC14602

CS31 Series 40&50

(See "Chapter 40 -> Connecting the cable shield")

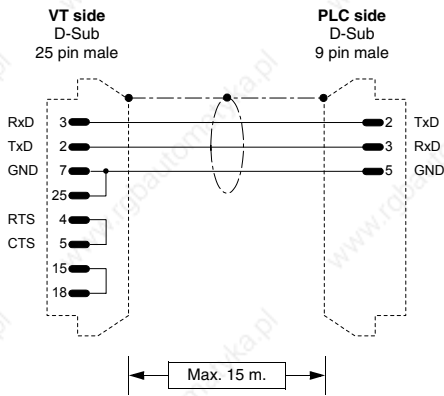

Order code:
CVPLC21202

AC70

(RS232)

(See "Chapter 40 -> Connecting the cable shield")

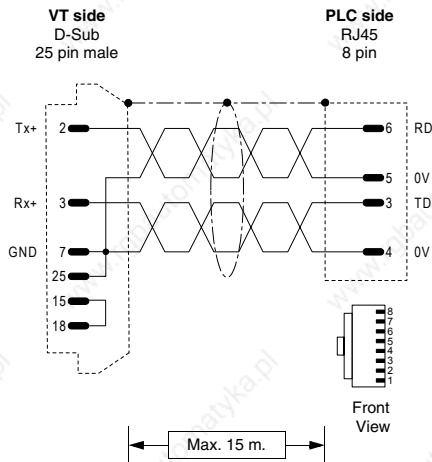

Order code:
CVPLC14802

ACS210

(RS232)

(See "Chapter 40 -> Connecting the cable shield")

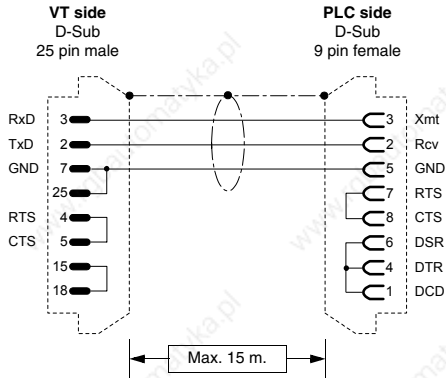

Order code:
CVPLC06402

AC450
(RS232)
(See "Chapter 40 -> Connecting the cable shield")

AEG MODICON PLC

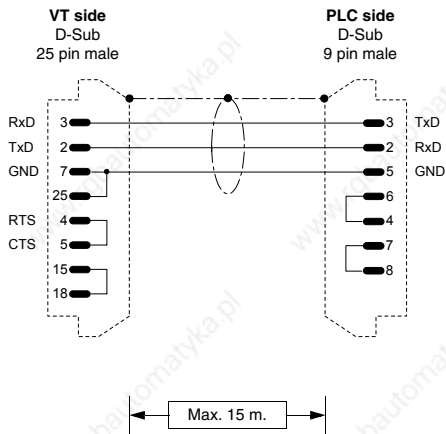

Order code:
CVPLC17102

COMPACT, A120, A250
Port 1 - Port 2
(RS232)
(See "Chapter 40 -> Connecting the cable shield")

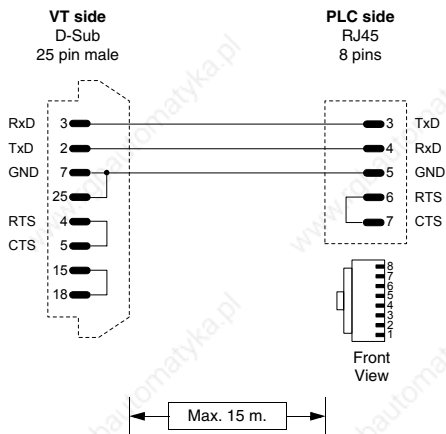

Order code:
CVPLC17202

MICRO
(RS232)
(See "Chapter 40 -> Connecting the cable shield")

ALLEN-BRADLEY PLC

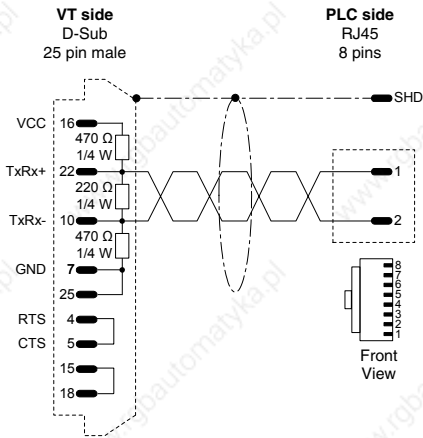

**Order code:
CVPLC07112**

SLC 500 CPU 5/02 5/03
(RS485)
Address of VT : 1...31
Address of PLC : 1...31

Screen side SLC500 connected to earth terminal of PLC power unit

WARNING !!!
See warnings regarding VT <-> SLC500 connection.

N.B: Open Integer file for at least two elements

Example:
N7:0
N7:1

(See "Chapter 40 -> Connecting the cable shield")



CONNECTION TO BE AVOIDED!!! Avoid connections like that shown in the figure below. The DH485 (data highway) port of CPUs 5/02 - 5/03 is not protected against peaks caused by outside disturbances; these could lead to serial port DH485 of SLC500 being damaged.

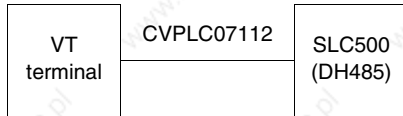

Below are listed those types of connection that are recommended.

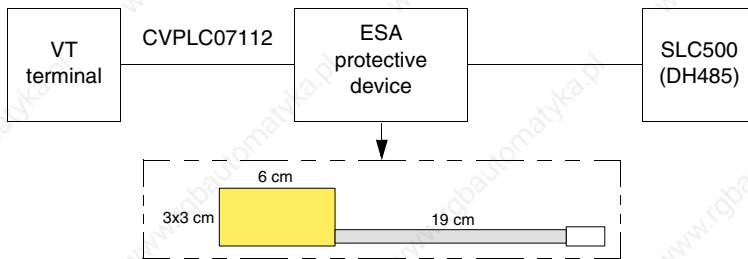

Order code for device: CVPLC07502

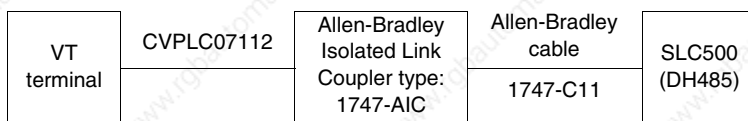

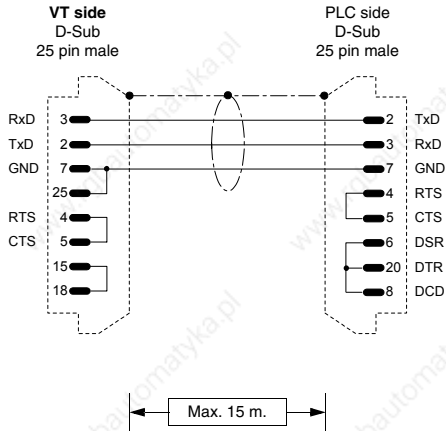

**Order code:
CVPLC07202**

PLC 5 /11/20/30/40/40L/60/60L

(RS232)

"CH0" SERIAL PORT SET

Channel 0 : SYSTEM (Point-to-point)
 Diag. File : 0
 Remote Mode Change : DISABLED
 Baud Rate : 19.2K
 Stop Bits : 1
 Parity : NONE
 Control Line : NO HANDSHAKING
 Duplicate Detect : OFF
 ACK Timeout (20 ms.) : 50
 Error Detect : BCC
 NAK Receive : 3
 DF1 ENQS : 3

N.B: Open Integer file for at least two elements

Example:

N7:0
 N7:1

(See "Chapter 40 -> Connecting the cable shield")

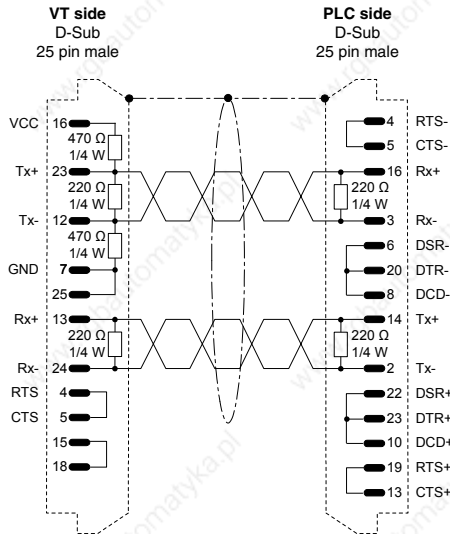

**Order code:
CVPLC07302**

PLC 5 /11/20/30/40/40L/60/60L

(RS422)

"CH0" SERIAL PORT SET

Channel 0 : SYSTEM (Point-to-point)
 Diag. File : 0
 Remote Mode Change : DISABLED
 Baud Rate : 19.2K
 Stop Bits : 1
 Parity : NONE
 Control Line : NO HANDSHAKING
 Duplicate Detect : OFF
 ACK Timeout (20 ms.) : 50
 Error Detect : BCC
 NAK Receive : 3
 DF1 ENQS : 3

N.B: Open Integer file for at least two elements

Example:

N7:0
 N7:1

(See "Chapter 40 -> Connecting the cable shield")

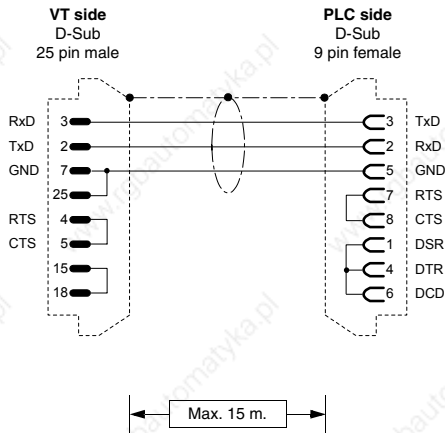
**Order code:**
CVPLC07402

SLC 500 CPU 5/03 5/04 5/05
MICROLOGIX CPU5550
ControlLogix

(RS232)

"CH0" SERIAL PORT SET
DF1 full duplex mode
Baud rate : 19200
Duplicate Detect : DISABLED
ACK timeout : 50
Parity : NONE
Control Line : NO HANDSHAKING
Error detect : BCC
NAK retries : 3
ENQ retries : 3
Embedded responses : ENABLED

N.B: Open Integer file for at least two elements

Example:
N7:0
N7:1

N.B. Programming SW necessary for Allen-Bradley V4.00 and all after

(See "Chapter 40 -> Connecting the cable shield")

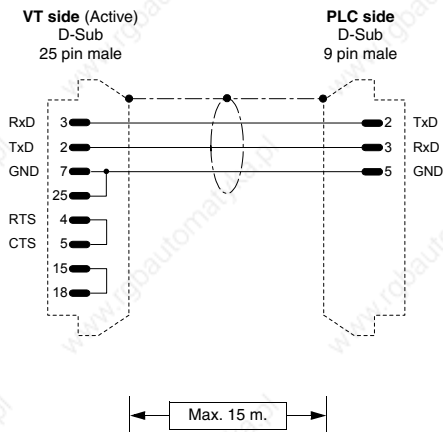
**Order code:**
CVPLC07602**MICROLOGIX CPU1000, 1200 and 1500**

(RS232)

MICROLOGIX SERIAL PORT SET
DF1 full duplex mode (MICRO)
Baud rate : 9600
ACK timeout : 50
Parity : NONE
Error detect : CRC
NAK retries : 3
ENQ retries : 3
Embedded responses : ENABLED
Duplicate packed detect : NO

N.B: Open Integer file for at least two elements

Example:
N7:0
N7:1

The Db 9 pin male connector must be connected to the A-B 1761-CBL-PM02, SER, A cable of the MICROLOGIX PLC.

(See "Chapter 40 -> Connecting the cable shield")

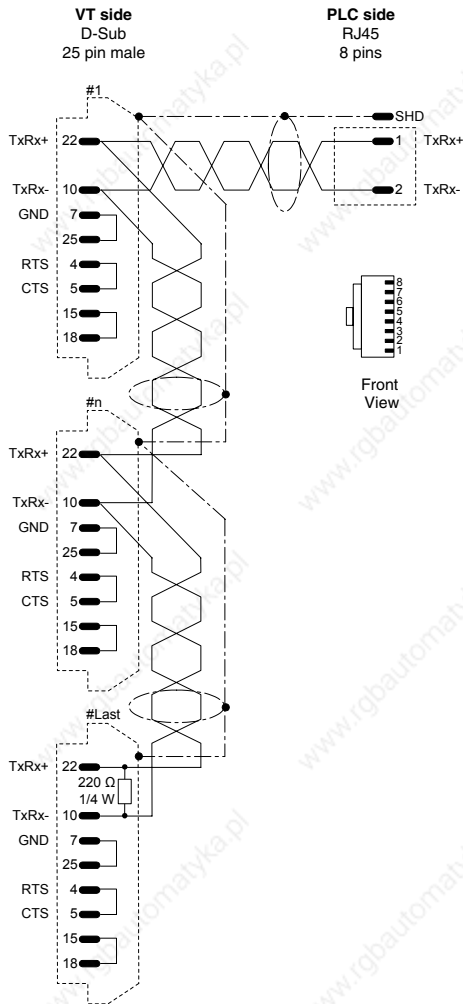

Order code:
NOT CODED

SLC 500 CPU 5/02 5/03
(RS485)

Cable valid for several VTs connected to a single PLC.

Address of VT : 1...31
Address of PLC : 1...31

N.B: Open Integer file for at least two elements

Example:
N7:0
N7:1

NOTE:

If using the 1747 AIC module, use the cable without the RJ45 connector employing the terminals.

1 -> 5 (A)
2 -> 4 (B)
GND -> 2 (SHLD)

(See "Chapter 40 -> Connecting the cable shield")



Example of the construction of a cable for connecting several VTs to a single PLC.

ALTUS PLC

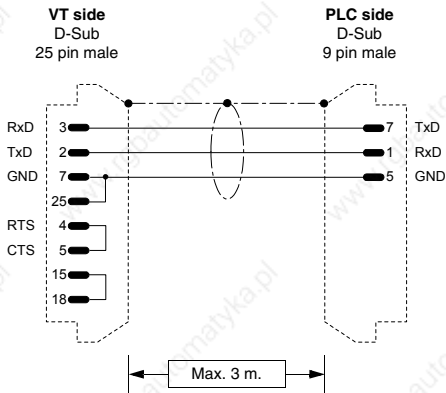

Order code:
CVPLC27102

ALNET-1
(RS232)
(See "Chapter 40 -> Connecting the cable shield")

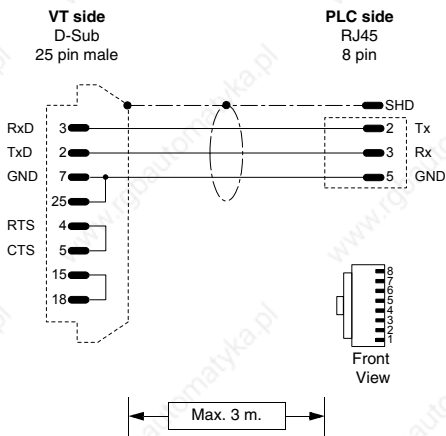

Order code:
CVPLC27202

ALNET-1
(RS232)
(See "Chapter 40 -> Connecting the cable shield")

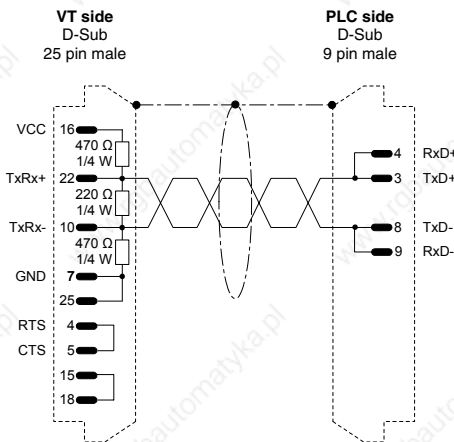

Order code:
CVPLC027302

ALNET-1
(RS485)
(See "Chapter 40 -> Connecting the cable shield")

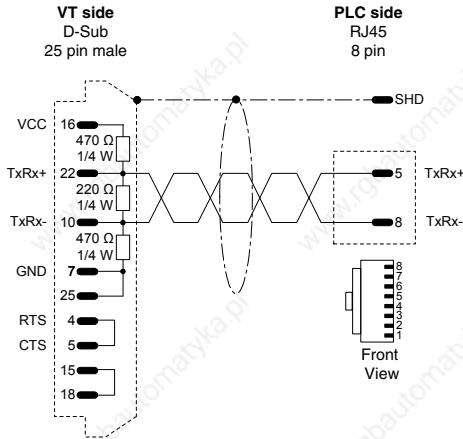

Order code:
CVPLC27202

ALNET-1
(RS485)
(See "Chapter 40 -> Connecting the cable shield")

ATOS PLC

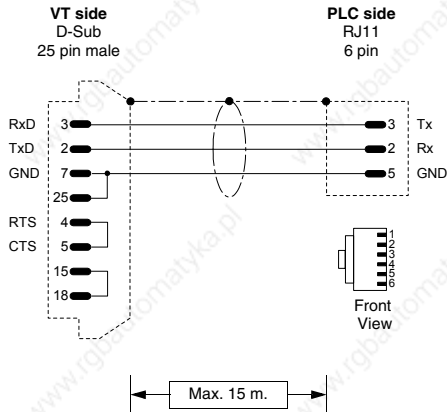

Order code:
CVPLC29102

MPC1600, MPC2002, MPC4004
(RS232)
(See "Chapter 40 -> Connecting the cable shield")

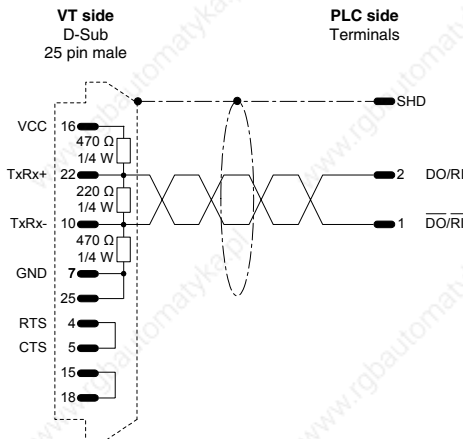

Order code:
CVPLC29202

MPC1600, MPC2002, MPC4004
(RS485)
(See "Chapter 40 -> Connecting the cable shield")

BECKHOFF PLC

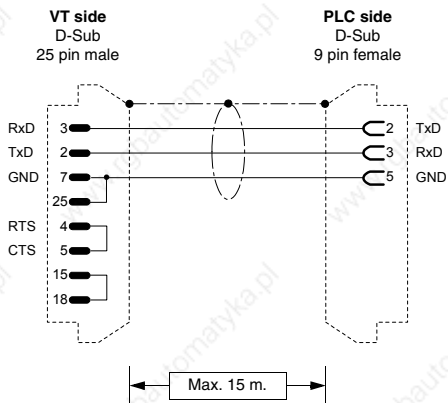

Order code:
CVPLC28102

BX3100

(RS232)

COM1 Port

(See "Chapter 40 -> Connecting the cable shield")

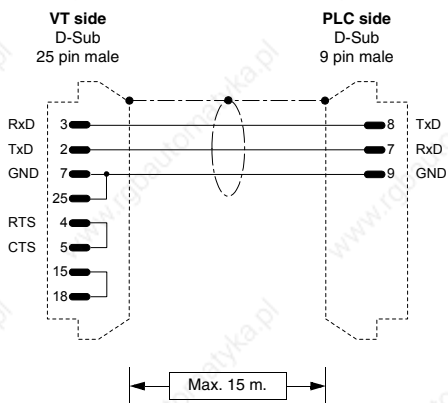

Order code:
CVPLC28202

BX3100

(RS232)

COM2 Port

(See "Chapter 40 -> Connecting the cable shield")

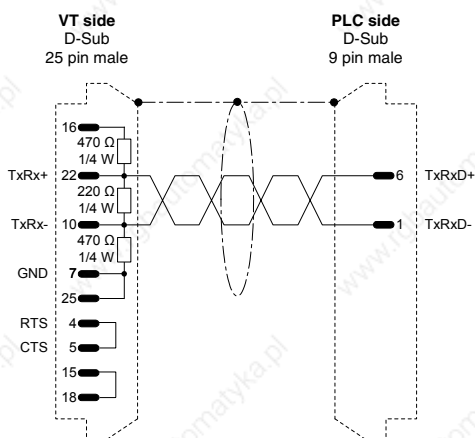

Order code:
CVPLC28302

BX3100

(RS485)

COM2 Port

Terminations are not needed on cables of less than 5 meters and a transmission speed of less than 19200 Baud.

(See "Chapter 40 -> Connecting the cable shield")

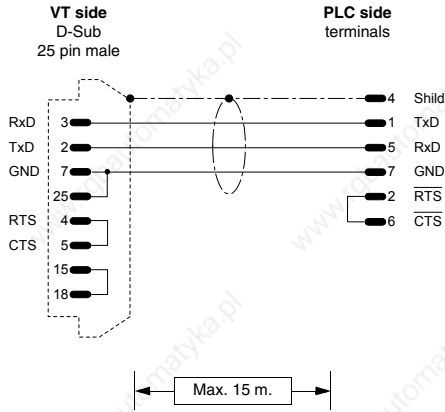

Order code:
CVPLC28402

KL6001
(RS232)
(See "Chapter 40 -> Connecting the cable shield")

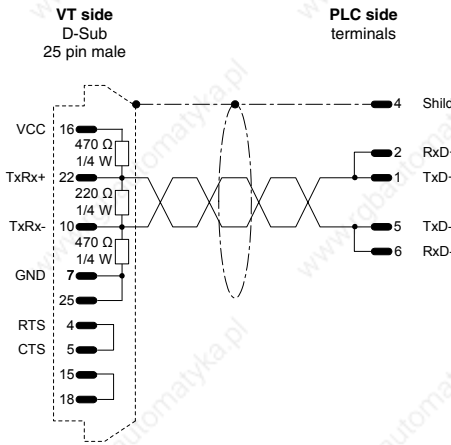

Order code:
CVPLC28502

KL6021
(RS485)
Terminations are not needed on cables of less than 5 meters and a transmission speed of less than 19200 Baud.
(See "Chapter 40 -> Connecting the cable shield")

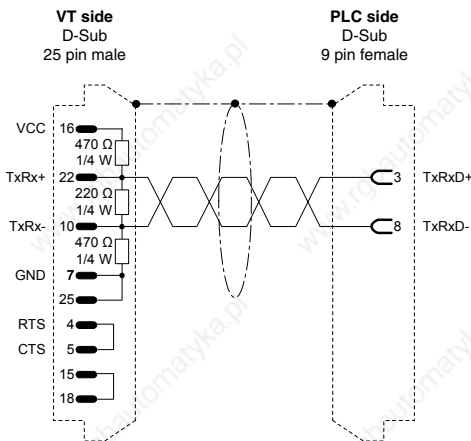

Order code:
CVPLC28602

BC7300/BK7300
(RS485)
Terminations are not needed on cables of less than 5 meters and a transmission speed of less than 19200 Baud.
(See "Chapter 40 -> Connecting the cable shield")

BOSCH PLC

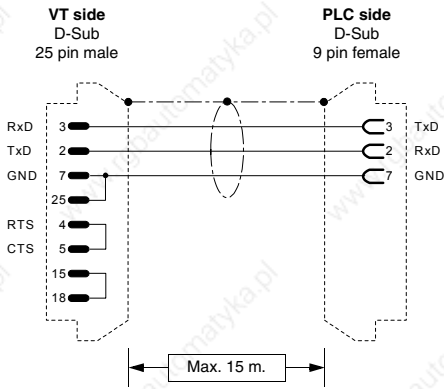

Order code:
CVPLC24102

CL150
(RS232)
(See "Chapter 40 -> Connecting the cable shield")

B&R AUTOMATION PLC

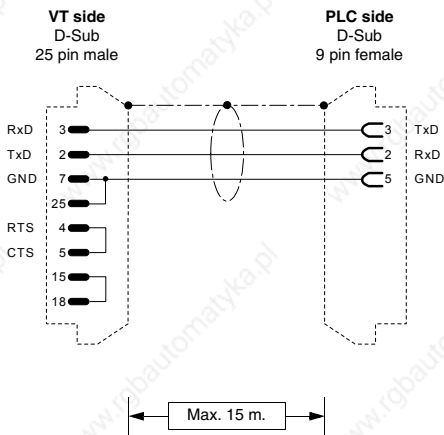

Order code:
CVPLC25102

NET2000
(RS232)
(See "Chapter 40 -> Connecting the cable shield")

CROUZET RPX PLC

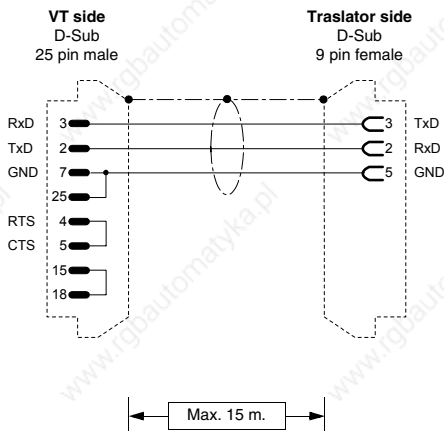

Order code:
CVPLC20102

RPX 10 - 20 - 30
Using CROUZET 88 750 309 translator
(RS232)
(See "Chapter 40 -> Connecting the cable shield")

FOXBORO PLC

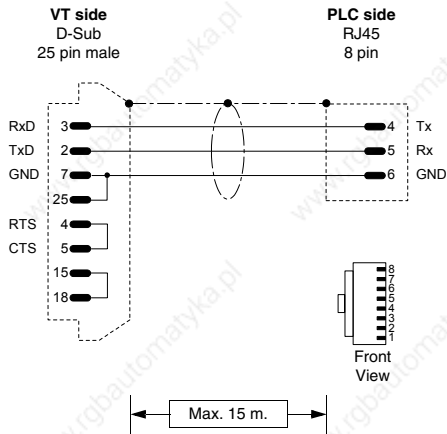

Order code:
CVPLC30102

RTU20

(RS232)

(See "Chapter 40 -> Connecting the cable shield")

FUJI PLC

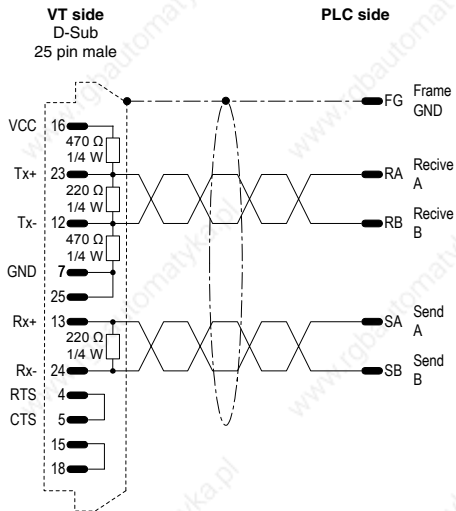

Order code:
CVPLC26102

Micrex-F F705

Needs RS4 communication card.

NOTE:

To insert the termination resistances move the relevant switch to the ON position.

(RS422)

(See "Chapter 40 -> Connecting the cable shield")

GE FANUC PLC

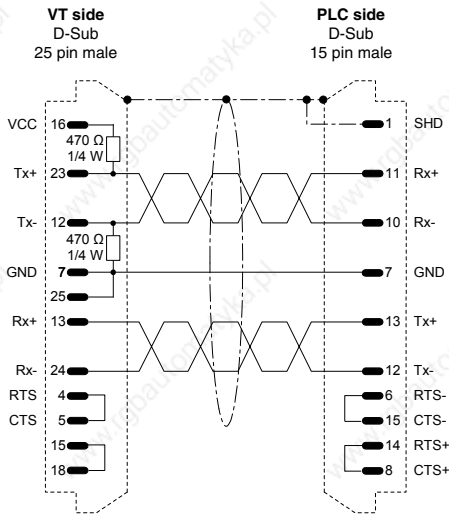

Order code:
CVPLC09102

Series 90 and 90 MICRO
directly in the CPU programming connector

Versamax
using port 2
(RS422)

(See "Chapter 40 -> Connecting the cable shield")

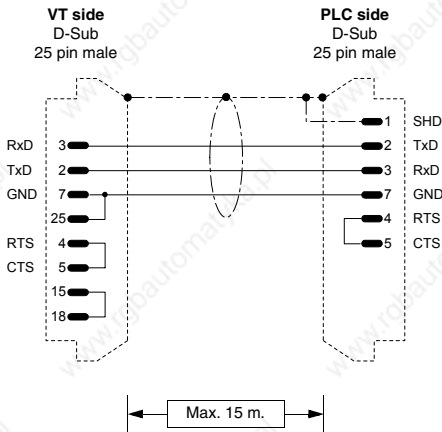

Order code:
CVPLC09202

Series 90
Using GE FANUC CMM311 interface port 1 - port 2

(RS232)

CONFIGURATION OF CMM311:

- SNP only
- SNP Enable : Yes
- SNP Mode : Slave
- Interface : RS232 (port1 / port2)
- Data Rate : 19200
- Timeout : Long
- Parity : Odd
- Stop bits : 1
- Flow control : None
- TurnA delay : None

(See "Chapter 40 -> Connecting the cable shield")

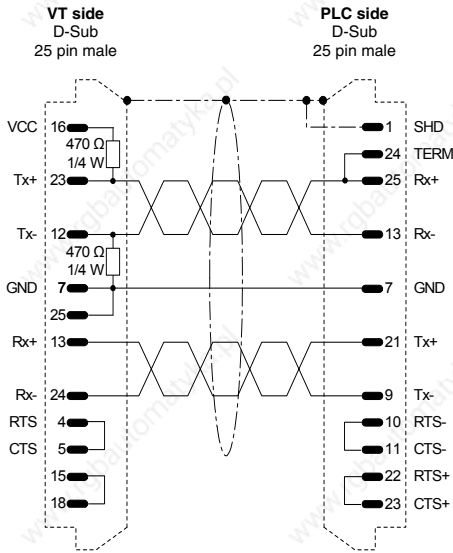

Order code:
CVPLC09302

Series 90
Using GE FANUC CMM311 interface

(RS422)

CONFIGURATION OF CMM311:
 SNP only : Yes
 SNP Enable : Yes
 SNP Mode : Slave
 Interface : RS422 (solo port2)
 Data Rate : 19200
 Timeout : Long
 Parity : Odd
 Stop bits : 1
 Flow control : None
 TurnA delay : None

(See "Chapter 40 -> Connecting the cable shield")

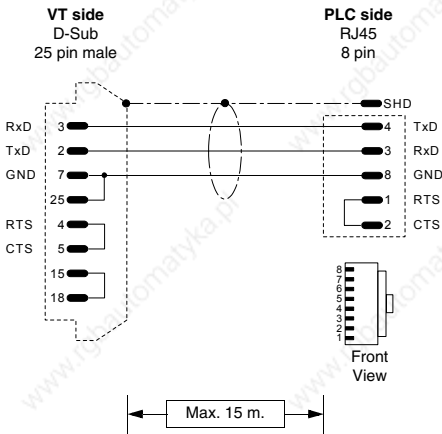

Order code:
CVPLC09402

Versamax
using port 1

(RS232)

(See "Chapter 40 -> Connecting the cable shield")

GEFRAN PLC

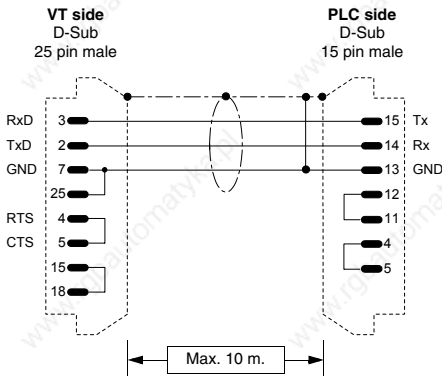

Order code:
CVPLC23102

Series MPS-NS

(RS232)

(See "Chapter 40 -> Connecting the cable shield")

HITACHI PLC

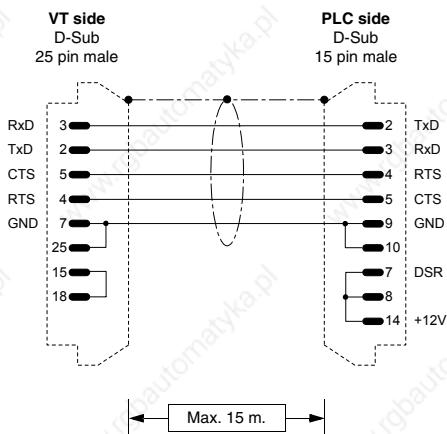

Order code:
CVPLC03102

Series H, 02H
(RS232)
(See "Chapter 40 -> Connecting the cable shield")

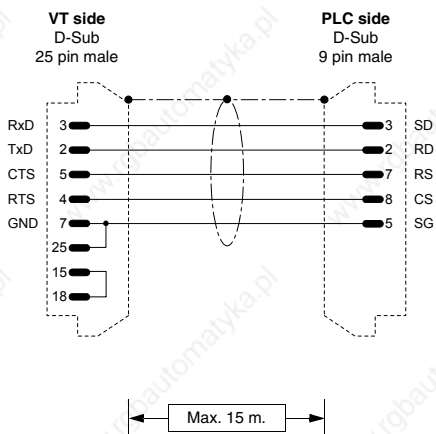

Order code:
CVPLC03202

Series EM CPU CPM - E3
(RS232)
WARNING!!
Switch ext. to COM2
Switch n2 int. to ON
(See "Chapter 40 -> Connecting the cable shield")

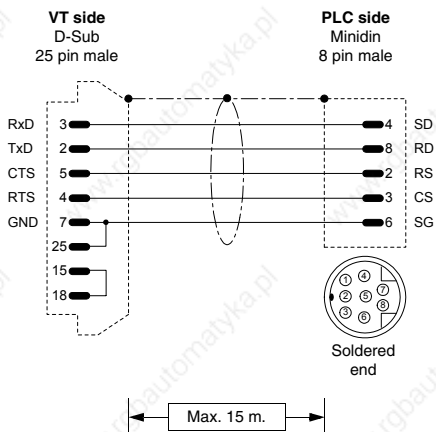

Order code:
CVPLC03302

Series EC
(RS232)
WARNING!!
Switch ext. to COM2
Areas T, C (time, counters) read only
(See "Chapter 40 -> Connecting the cable shield")

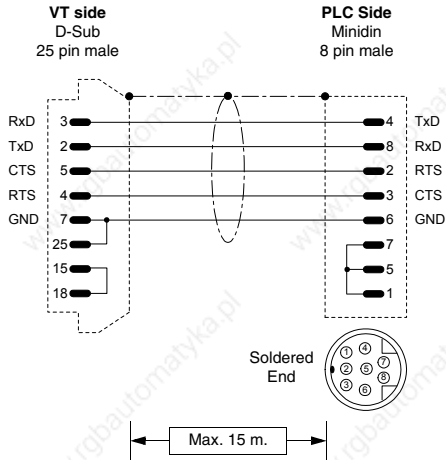

**Order code:
CVPLC03402**

Series H CPU22-02 HC
(RS232)

COM2

(See "Chapter 40 -> Connecting the cable shield")

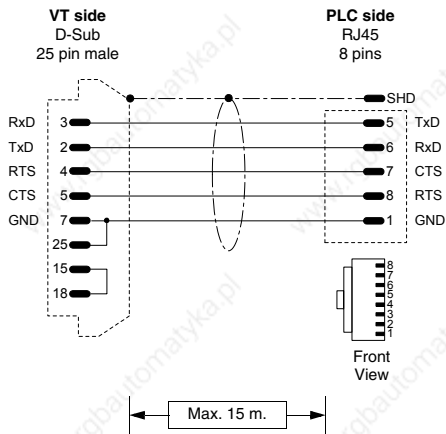

**Order code:
CVPLC03502**

Series EH150
(RS232)

NOTE:
127 PLCs connectable in Hitachi network with 2 Links (0-63 stations per Link).

LUMP:

Parameter	Default	Values	Notes
L	FF	01,02 or FF	Address of Link number.
U	FF	00-63 or FF	Address of network node (as indicated by the network card rotary switches).
M	00	00-63	Address of network node with connection using COMM-H additional serial cards.
P	00	00-63	Address of network node with connection using COMM-H additional serial cards.

TM:

Parameter	Default	Values	Notes
TM	4	4-F	Timeout for the reply to an enquiry.

(See "Chapter 40 -> Connecting the cable shield")

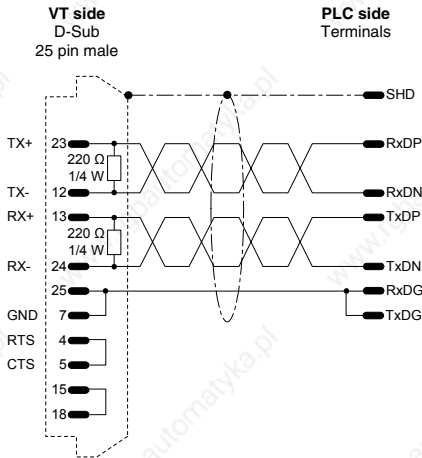

Order code:
CVPLC03602

COMM H

(RS422)

(See "Chapter 40 -> Connecting the cable shield")

IDEC IZUMI PLC

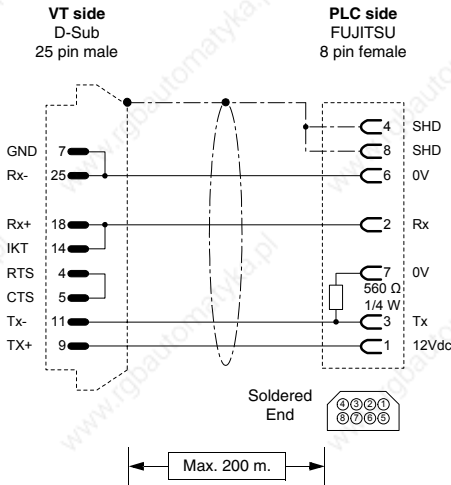

Order code:
CVPLC19102

CPU FA2 - FA2J

In the CPU programming connector (Programmer's Port).

(Current loop).

(See "Chapter 40 -> Connecting the cable shield")

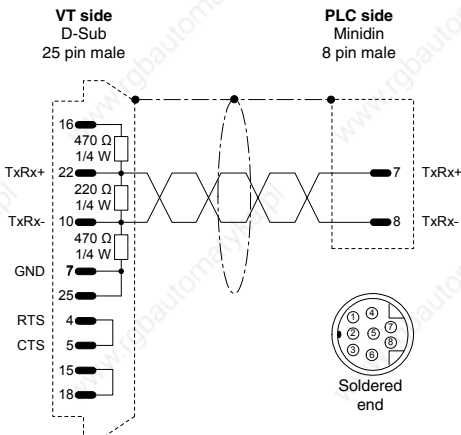

Order code:
CVPLC19302

IZUMI Micro3

(See "Chapter 40 -> Connecting the cable shield")

KLÖCKNER MOELLER PLC

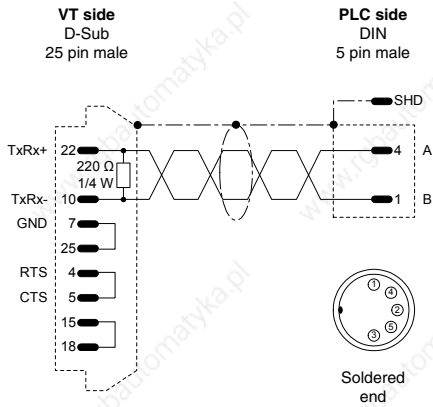

Order code:
CVPLC12112

PS306
(RS485)

N.B. Make sure that the two insertion jumpers of the interface termination resistances located in the RS485 hatch (visible on the front part of the PLC) are hooked up (see PLC manual).

(See "Chapter 40 -> Connecting the cable shield")

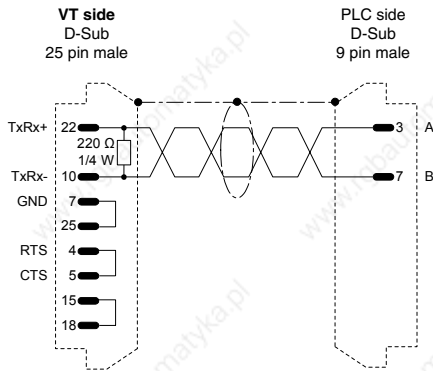

Order code:
CVPLC12212

PS316/PS416-CPU400
(RS485)

N.B. Make sure that the two insertion jumpers of the interface termination resistances located in the RS485 hatch (visible on the front part of the PLC) are hooked up (see PLC manual).

(See "Chapter 40 -> Connecting the cable shield")

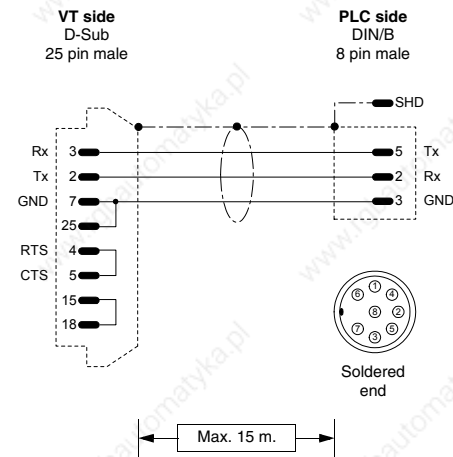

Order code:
CVPLC12302

PS4-141-MM1
PS4-201-MM1
PS4-341-MM1
(RS232)

(See "Chapter 40 -> Connecting the cable shield")

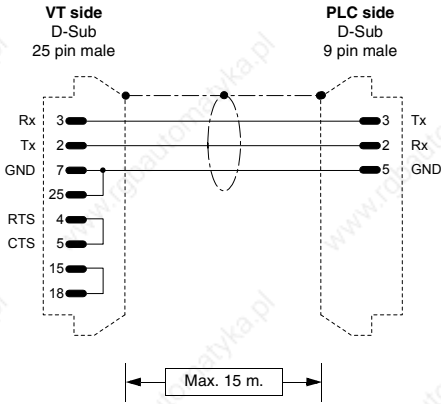

Order code:
CVPLC12402

PS416-CPU40
(RS232)
(See "Chapter 40 -> Connecting the cable shield")

KEYENCE PLC

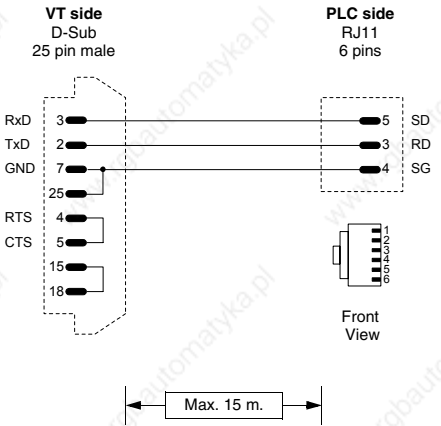

Order code:
CVPLC15102

Series KV10-16-24-40
(RS232)

KOYO PLC

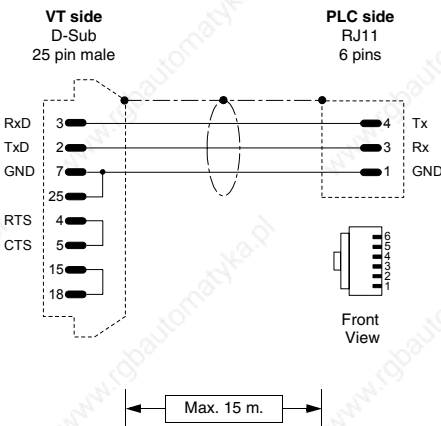

Order code:
CVPLC32102

DL 240 CPU Port
(RS232)
(See "Chapter 40 -> Connecting the cable shield")

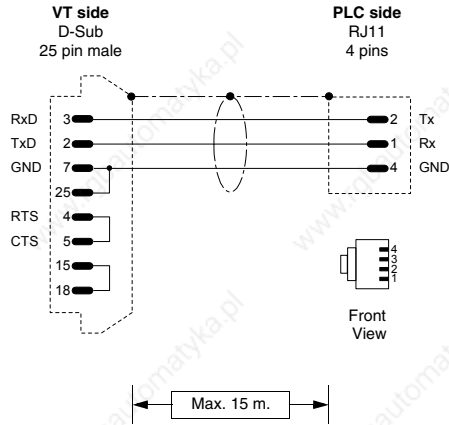

Order code:
CVPLC32202

DL 340 CPU Port
(RS232)
(See "Chapter 40 -> Connecting the cable shield")

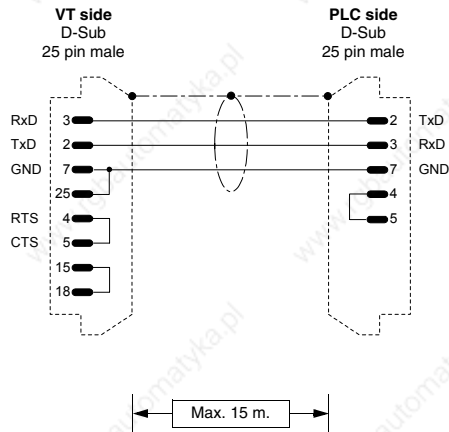

Order code:
CVPLC32302

DL 405 DCM, DL 405 CPU Port, DL 305 DCU
(RS232)
(See "Chapter 40 -> Connecting the cable shield")

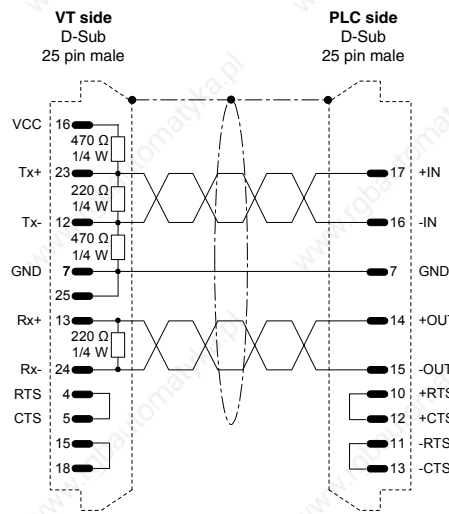

Order code:
CVPLC32402

DL 405 DCM, DL 305 DCU
(RS422)
(See "Chapter 40 -> Connecting the cable shield")

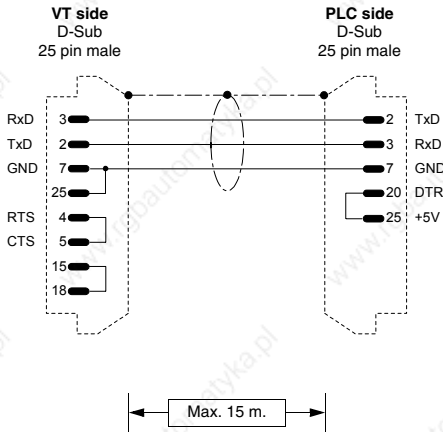

Order code:
CVPLC32502

DL 305 DCU
(RS232)
(See "Chapter 40 -> Connecting the cable shield")

KUHNKE PLC

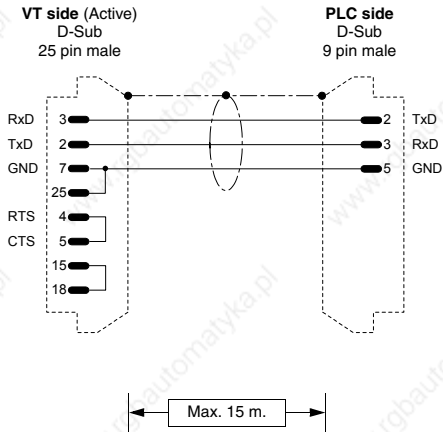

Order code:
CVPLC07602

KUBES
(RS232)
(See "Chapter 40 -> Connecting the cable shield")

LG PLC

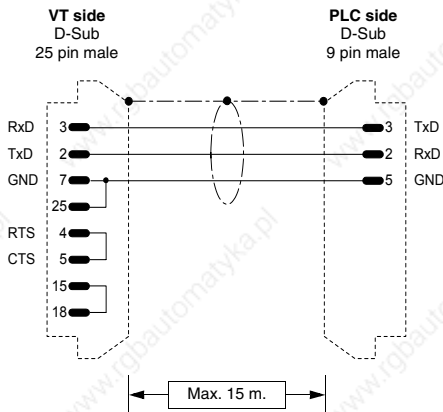

Order code:
CVPLC21102

K30 / K500 / K1000
(RS232)
(See "Chapter 40 -> Connecting the cable shield")

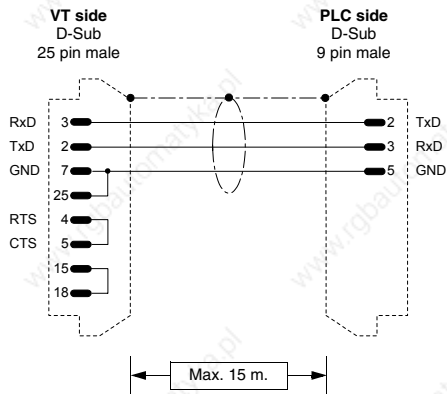

Order code:
CVPLC21202

K10
(RS232)

The 9 pin male Db must be connected to the GOLDSTAR cable of the K10 PLC.
(See "Chapter 40 -> Connecting the cable shield")

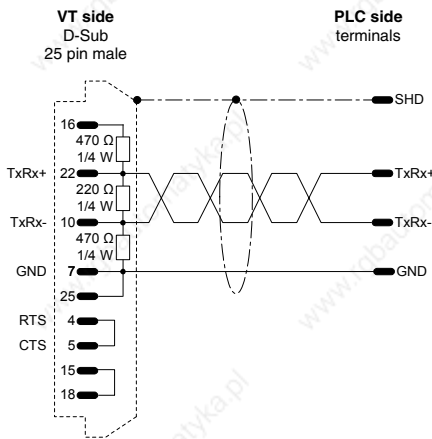

Order code:
CVPLC21302

Series MK
(RS485)

(See "Chapter 40 -> Connecting the cable shield")

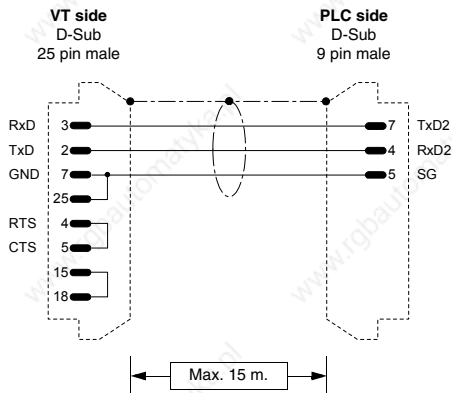

Order code:
CVPLC21402

Master K1205
(RS232)

Dip-Switch:
1 -> OFF (ROM MODE)
2 -> ON (BUILT-IN CNET)

(See "Chapter 40 -> Connecting the cable shield")

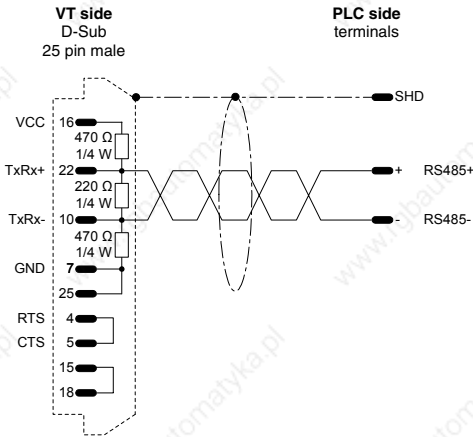

Order code:
CVPLC21502

Master K1205
(RS485)
(See "Chapter 40 -> Connecting the cable shield")

MATSUSHITA-NAIS PLC

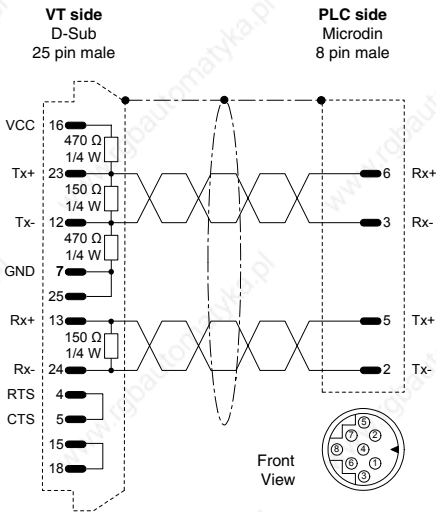

Order code:
CVPLC16102

Series FP-1
Directly in the CPU programming connector
(RS422)

NOTA:
If you wish to use the AFP1523 cable it will be necessary to create an adaptor cable that on the VT side uses a 25 pin male D-Sub with the pins arranged as in the figure, on the PLC side a 15 pin male D-Sub connector that must be wired as follows:

Microdin ->	D-Sub
6 Rx+	-> 15
3 Rx-	-> 7
5 Tx+	-> 14
2 Tx -	-> 12

(See "Chapter 40 -> Connecting the cable shield")

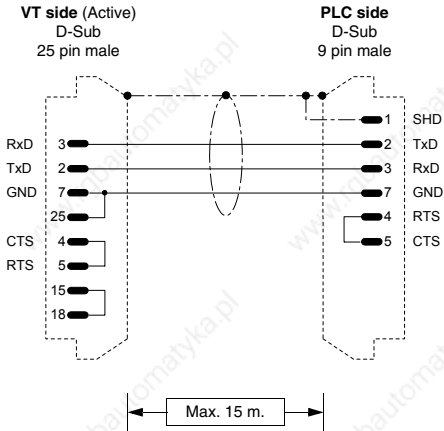

Order code:
CVPLC16202

Series FP-1 / FP-M
Using the optional serial interface of the PLC

(RS232)

RS232C: RS232C SERIAL PORT SET
 Port Selection : COMPTR LNK
 RS232C Send Form
 Data Length : 8 BIT
 Parity CHK : WITH, ODD
 Stop Bit : 1 BIT
 Terminator : CR
 Header : NO STX
 RS232C Baudrate : 1(9600 bps)
 RS232C Modem : DISABLED
 Connection : DISABLED
 Computer Link Station number (1-32) : 1

(See "Chapter 40 -> Connecting the cable shield")

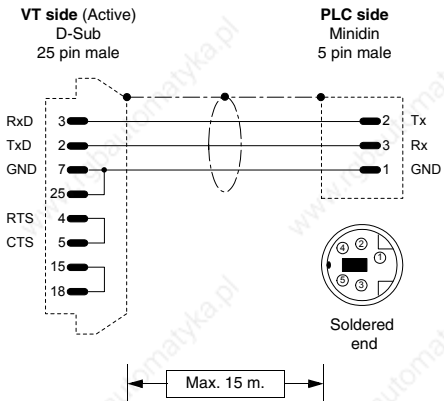

Order code:
CVPLC16302

Series FP-M/FP-0/FP-2
In the programming connector of the CPU (Programmer's Port).

(RS-232)

(See "Chapter 40 -> Connecting the cable shield")

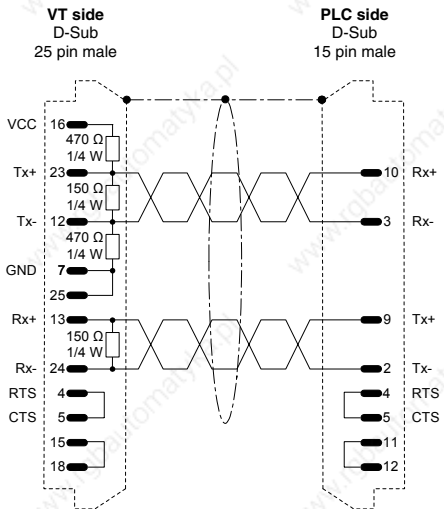

Order code:
CVPLC16402

Series FP-3
Direct in the programming connector of the CPU

(RS422)

(See "Chapter 40 -> Connecting the cable shield")

MICROLINK PLC

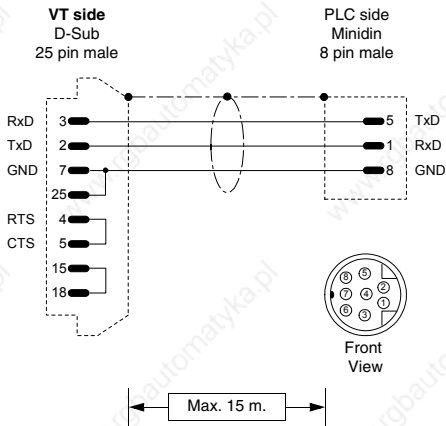

Order code:
CVPLC31102

ML-14
(RS232)
(See "Chapter 40 -> Connecting the cable shield")

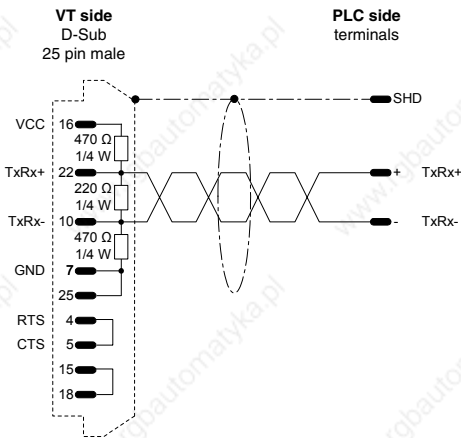

Order code:
CVPLC31202

ML-14
(RS485)
(See "Chapter 40 -> Connecting the cable shield")

MITSUBISHI PLC

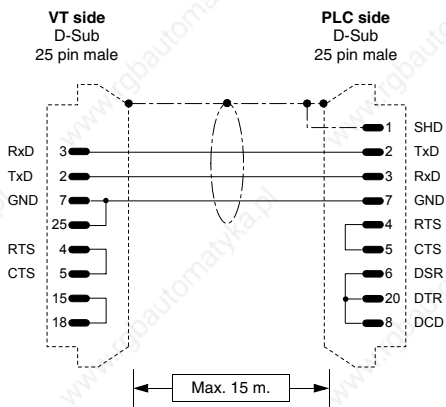

Order code:
CVPLC05102

Series Fx
Using Computer-Link
(RS232)
Jump-connect the **LG** and **GF** terminals on the PLC terminal block
(See "Chapter 40 -> Connecting the cable shield")

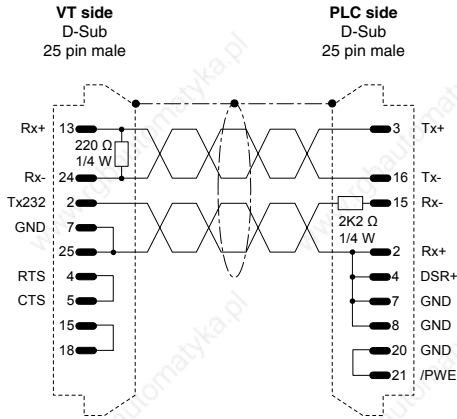

Order code:
CVPLC05202

Series Fx
(See "Chapter 40 -> Connecting the cable shield")

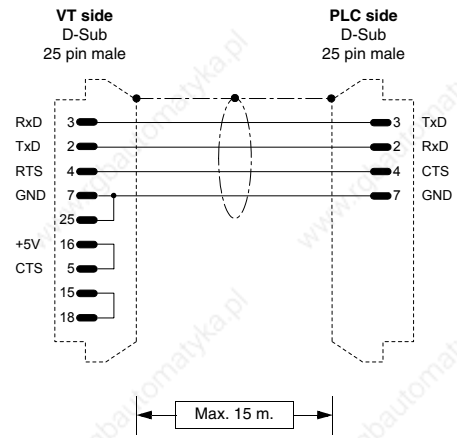

Order code:
CVPLC05302

Series A
(CPU port)
Using the MITSUBISHI SC-05 converter for long distances

Jump-connect the **LG** and **GF** terminals on the PLC terminal block

(See "Chapter 40 -> Connecting the cable shield")

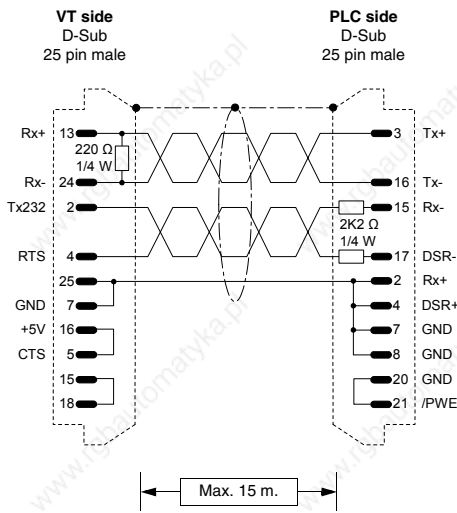

Order code:
CVPLC05402

Series A
(RS232)
Directly in the CPU programming connector

Jump-connect the **LG** and **GF** terminals on the PLC terminal block

(See "Chapter 40 -> Connecting the cable shield")

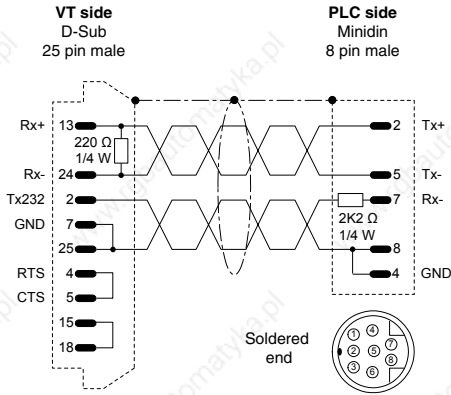

Order code:
CVPLC05502

Series Fx0 - Fx0 N - Fx2 N
Directly in the CPU programming connector
(RS-232/422 Hybrid)

(See "Chapter 40 -> Connecting the cable shield")

OMRON PLC

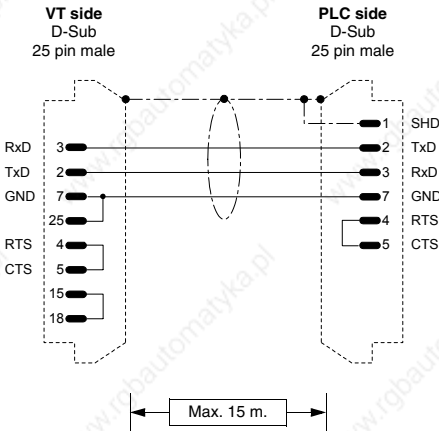

Order code:
CVPLC02102

Using interface 3G2A6-LK201-EV1 and OMRON series H C200H-LK201

(RS232)

Jump-connect the **GR** and **LG** terminals on the PLC terminal block

(See "Chapter 40 -> Connecting the cable shield")

JUMPER SETTINGS C200H-LK201

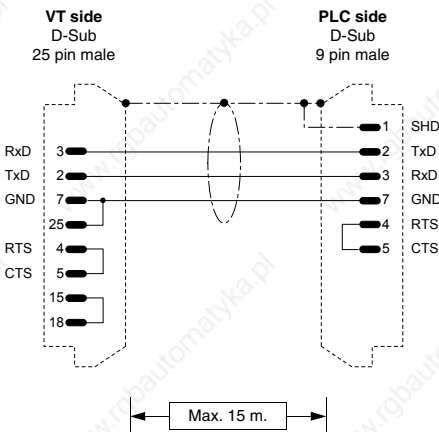
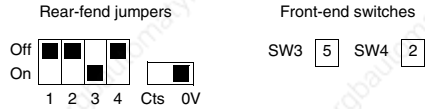

Order code:
CVPLC02202

Series H
Compact family C20H / C28H C40H / C60H

(RS232)

Jump-connect the **GR** and **LG** terminals on the PLC terminal block

(See "Chapter 40 -> Connecting the cable shield")

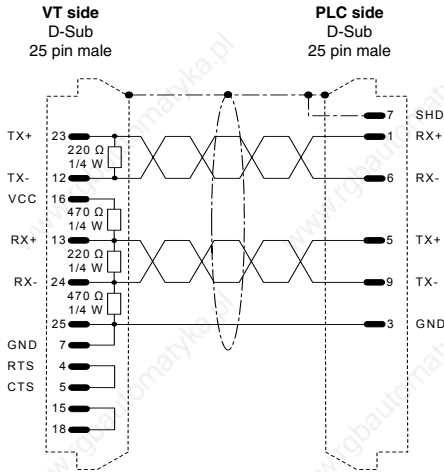

**Order code:
CVPLC02302**

Series H C200H using interface LK202
(RS422)

Jump-connect the **GR** and **LG** terminals on the PLC terminal block
(See "Chapter 40 -> Connecting the cable shield")

JUMPER SETTINGS C200H-LK201

Rear-end jumpers Front-end switches

On - SW3 5 SW4 2
Off Z

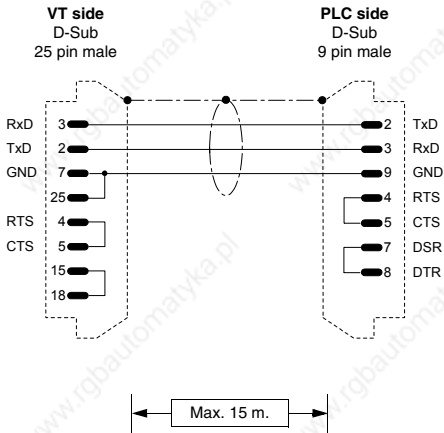

**Order code:
CVPLC02402**

**Series H
Series CS1
CQM1 CPU 21-E and above
CVM1 and C200HS/ HE/HG/HX/Hα (integrated serial)
CPM1 Using interface CPM1-CIF01
CPM2A/2C**
(RS232)

Jump-connect the **GR** and **LG** terminals on the PLC terminal block
(See "Chapter 40 -> Connecting the cable shield")

JUMPER SETTINGS CPM1-CIF01

HOST
NT

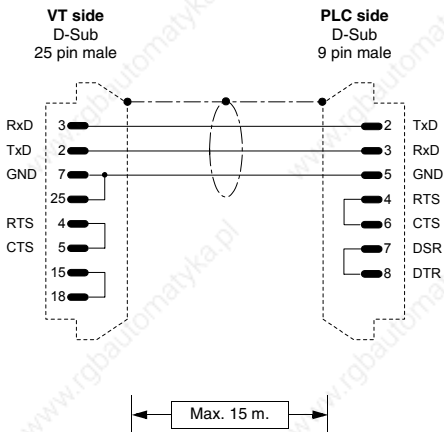

**Order code:
CVPLC02502**

**Series H
CQM1 Using interface CQM1-CIF02**
(RS232)

Jump-connect the **LG** and **GF** terminals on the PLC terminal block
(See "Chapter 40 -> Connecting the cable shield")

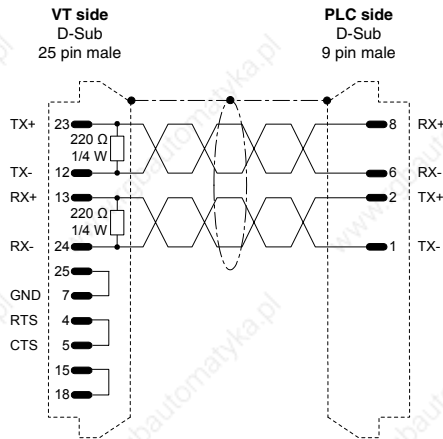

Order code:
CVPLC02602

CVM1

(RS422)

Jump-connect the **LG** and **GF** terminals on the PLC terminal block

(See "Chapter 40 -> Connecting the cable shield")

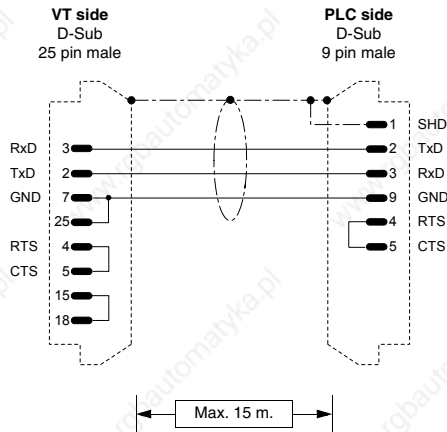

Order code:
CVPLC02502

CJ1G

(RS232)

(See "Chapter 40 -> Connecting the cable shield")

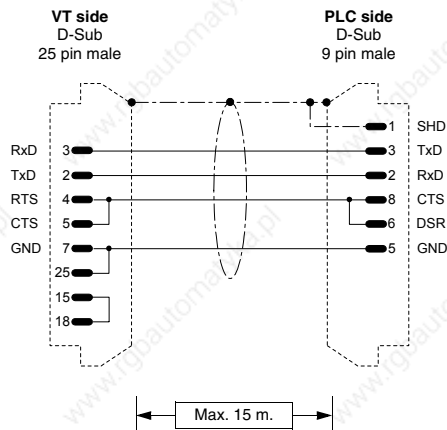
SAIA PLC

Order code:
CVPLC04102

Series PCD2 / 4
in the programming connector of the CPU (PGU port)

(RS232)

(See "Chapter 40 -> Connecting the cable shield")

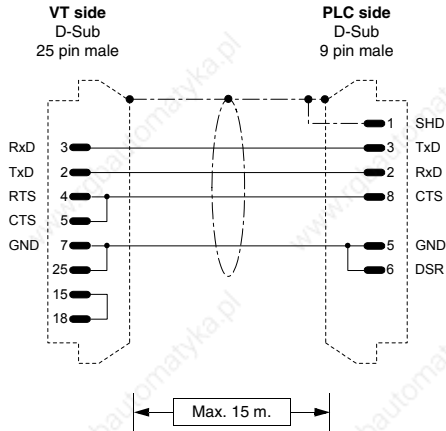

Order code:
CVPLC04202

S-BUS series PCD1 / 2 / 4
in the programming connector of the CPU (PGU port)
(RS232)

PLC Address: 0...255

NOTE: Configure the Number of the S-BUS station inside the PLC using the SAIA programming software.
(See "Chapter 40 -> Connecting the cable shield")

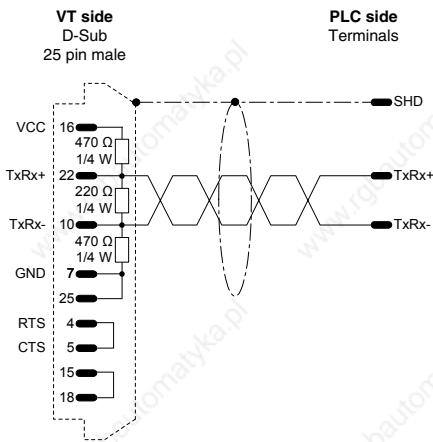

Order code:
NOT CODED

S-BUS series PCD1 / 2 / 4
Connection to terminal block
(RS485)

PLC address: 0...255

SASI 1 (1=first interf., 2=second interf., etc.)
999
;TEXT 999 "UART:9600,0,0,0;MODE:SS1; DIAG:F260,R500"

NOTE: Configure the Number of the S-BUS station inside the PLC using the SAIA programming software.
(See "Chapter 40 -> Connecting the cable shield")

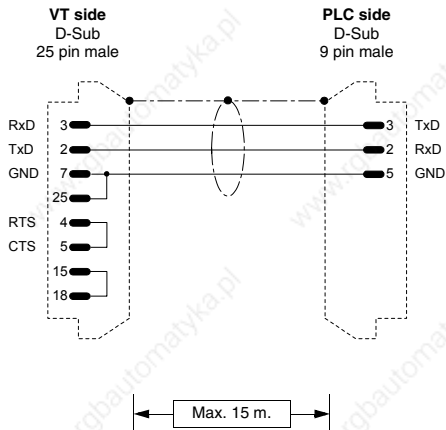

Order code:
NOT CODED

PCD2 / 4
in the programming connector of the CPU (PGU port) with port initialization
(RS232)

This connection is useful in the event that the PLC does not go in RUN with the VT terminal connected. In this case, you also need to initialize the PGU port with the instructions:

SASI 0
999
; TEXT 999 "UART:9600,7,E,1;MODE:SD0; DIAG:F260,R500"

In this way, if you send the PLC in RUN using the SAIA utility S/W, the ERROR light switches on, but this is normal. To switch the light off, just remove the instruction "**SASI 0**" when the PLC is connected with the utility S/W.
(See "Chapter 40 -> Connecting the cable shield")

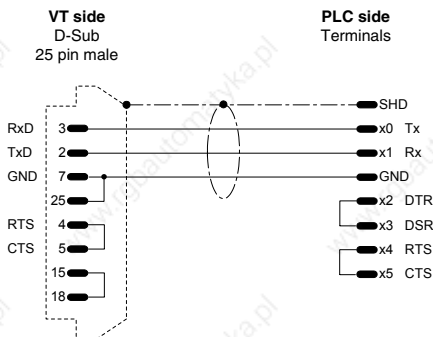

**Order code:
NOT CODED**

Additional PCD4 interface to BUS
(RS232)

NB: To make the terminal function with the additional interface of the SAIA PCD PLC, the following setting must be observed:

SASI 1 (1=first interf., 2=second interf., etc.)
999
;TEXT 999
"UART:9600,7,E,1;MODE:SD0;DIAG:F260,R500;RBUF:255;TBUF:255"

(See "Chapter 40 -> Connecting the cable shield")

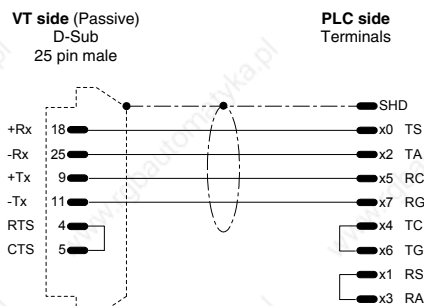

**Order code:
NOT CODED**

Additional PCD4 interface to BUS
(Current loop)

NB: To make the terminal function with the additional interface of the SAIA PCD PLC, the following setting must be observed:

SASI 1 (1=first interf., 2=second interf., etc.)
999
;TEXT 999
"UART:9600,7,E,1;MODE:SD0;DIAG:F260,R500;RBUF:255;TBUF:255"

(See "Chapter 40 -> Connecting the cable shield")

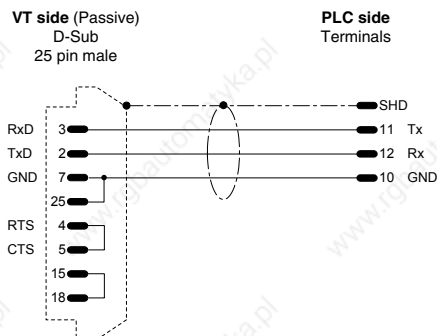
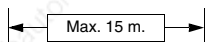

**Order code:
NOT CODED**

PCD2 serial interface 1 module PCD7/F120
(RS232)

NB: To make the terminal function with the additional interface of the SAIA PCD PLC, the following setting must be observed:

SASI 1 (1=first interf., 2=second interf., etc.)
999
;TEXT 999
"UART:9600,7,E,1;MODE:SD0;DIAG:F260,R500;RBUF:255;TBUF:255"

(See "Chapter 40 -> Connecting the cable shield")

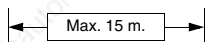

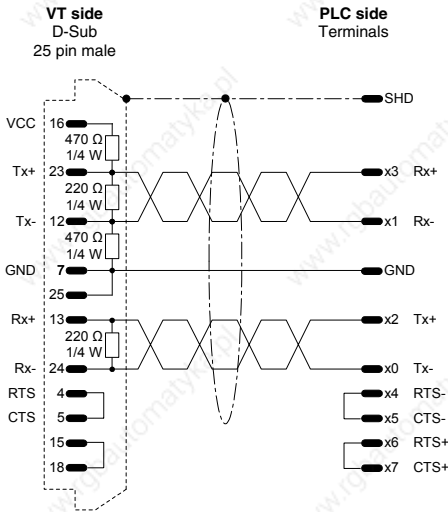

**Order code:
NOT CODED**

Additional PCD4 interface to BUS module BUS C130
(RS422)

NB: To make the terminal function with the additional interface of the SAIA PCD PLC, the following setting must be observed:

SASI 1 (1=first interf., 2=second interf., etc.)
999
;TEXT 999
"UART:9600,7,E,1;MODE:SD0;DIAG:F260,R500;RBUF:255;TBUF:255"

(See "Chapter 40 -> Connecting the cable shield")

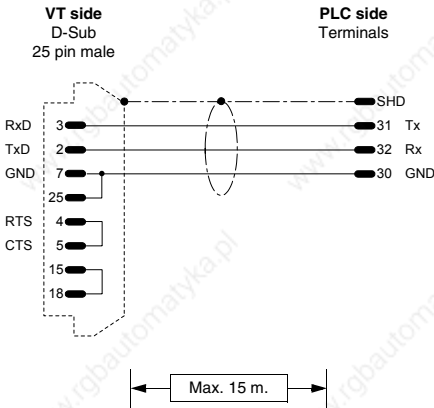

**Order code:
NOT CODED**

PCD2 serial interface 2 module PCD2/F520
(RS232)

NB: To make the terminal function with the additional interface of the SAIA PCD PLC, the following setting must be observed:

SASI 1 (1=first interf., 2=second interf., etc.)
999
;TEXT 999
"UART:9600,7,E,1;MODE:SD0;DIAG:F260,R500;RBUF:255;TBUF:255"

(See "Chapter 40 -> Connecting the cable shield")

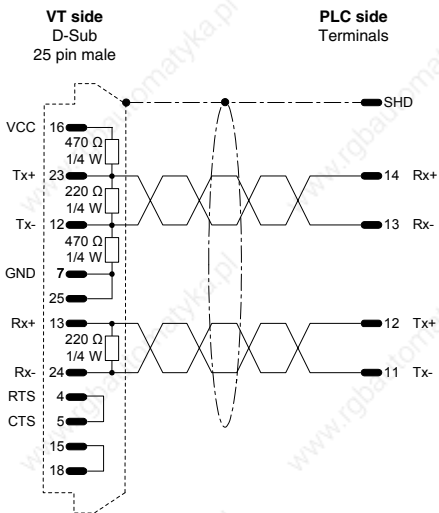

**Order code:
NOT CODED**

PCD2 serial interface 1 module PCD7/F110
(RS422)

B: To make the terminal function with the additional interface of the SAIA PCD PLC, the following setting must be observed:

SASI 1 (1=first interf., 2=second interf., etc.)
999
;TEXT 999
"UART:9600,7,E,1;MODE:SD0;DIAG:F260,R500;RBUF:255;TBUF:255"

NB: Insert the interface termination resistances (See SAIA manual).

(See "Chapter 40 -> Connecting the cable shield")

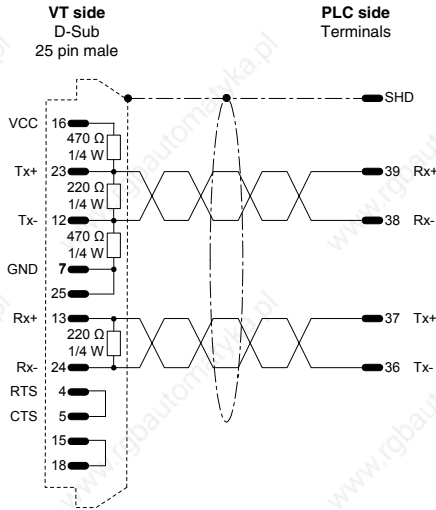

**Order code:
NOT CODED**

PCD2 serial interface 3 module PCD2/F520
(RS422)

B: To make the terminal function with the additional interface of the SAIA PCD PLC, the following setting must be observed:

SASI 1 (1=first interf., 2=second interf., etc.)
999
;TEXT 999
"UART:9600,7,E,1;MODE:SD0;DIAG:F260,R500;RBUF:255;TBUF:255"

NB: Insert the interface termination resistances (See SAIA manual).
(See "Chapter 40 -> Connecting the cable shield")

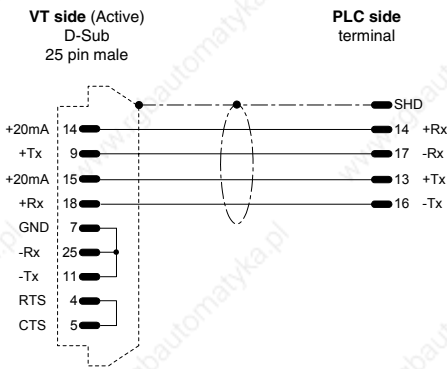

**Order code:
NOT CODED**

PCD2 interface to module TTY - 20mA (PCD7/F130)
(Current loop)

(See "Chapter 40 -> Connecting the cable shield")

SATT CONTROL PLC

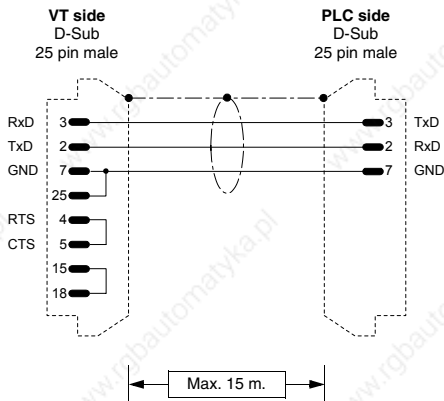

**Order code:
CVPLC18102**

Series 31-90
(RS232)

PLC serial port configuration:

Channel Configuration no.:	B
COMLI:	C
Master / Slave (M / S):	S
Identity (1..247):	1
ASCII / Binary (A / B):	B
Baudrate (110...19200):	9600
Number of data bits:	8
Number of stop bits:	1
Parity (O / E / N):	O
Error counters to register (RX/N):	N
Number of ACIA-errors:	12
Number of BCC-errors:	8
Number of other errors:	4

(See "Chapter 40 -> Connecting the cable shield")

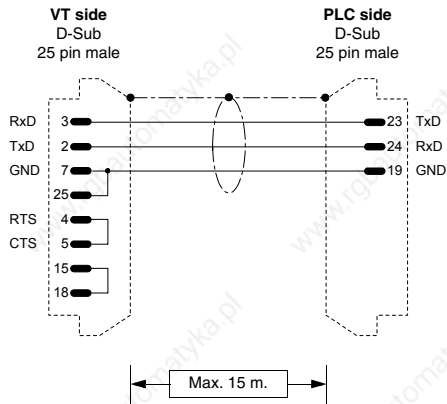

Order code:
CVPLC18202

Series 115

(RS232)

Connection to VDU-port.

Possible connection also to PLC PRINTER-port.

In this case configure the COMLI 1-port as CHA2 with the appropriate software programming utility of the PLC

CPLC serial port configuration:

Channel Configuration no.:	B
COMLI:	C
Master / Slave (M / S):	S
Identity (1..247):	1
ASCII / Binary (A / B):	B
Baudrate (110...19200):	9600
Number of data bits:	8
Number of stop bits:	1
Parity (O / E / N):	O
Error counters to register (RX/N):	N
Number of ACIA-errors:	12
Number of BCC-errors:	8
Number of other errors:	4

(See "Chapter 40 -> Connecting the cable shield")

SCHLEICHER PLC

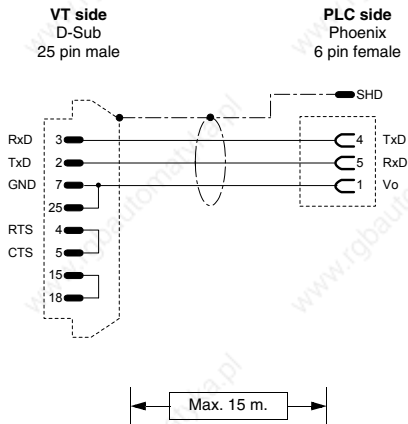

Order code:
CVPLC08102

CPU-10, CPU20 serial interface COM2

(RS232)

(See "Chapter 40 -> Connecting the cable shield")

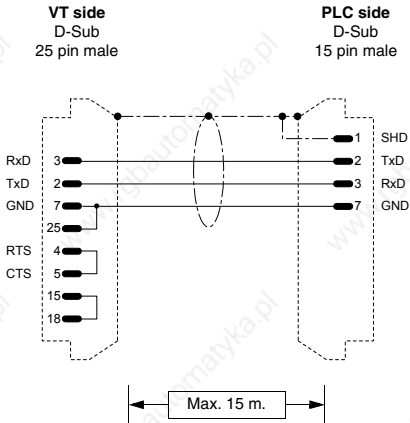

Order code:
CVPLC08202

Series F
Connection PGU
(RS232)

N.B: Declare in the PLC program the type of port used.
(See "Chapter 40 -> Connecting the cable shield")

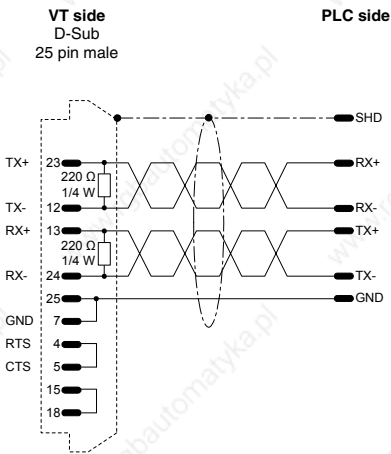

Order code:
CVPLC08302

Series F
Connection FCS
(RS422)

N.B: Declare in the PLC program the type of port used.
(See "Chapter 40 -> Connecting the cable shield")

SIEMENS PLC

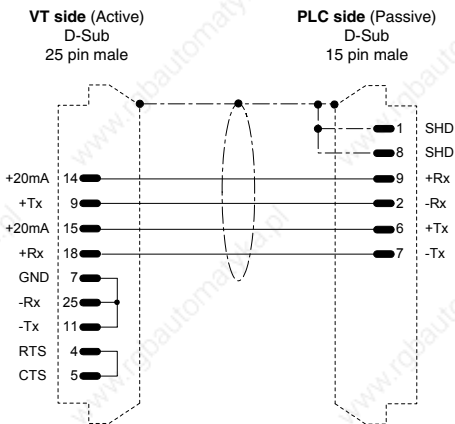

Order code:
CVPLC01202

SIMATIC S5
CPU 90...135
FAP CPU 944 / 945
(Current loop - CPU programming port)

(See "Chapter 40 -> Connecting the cable shield")

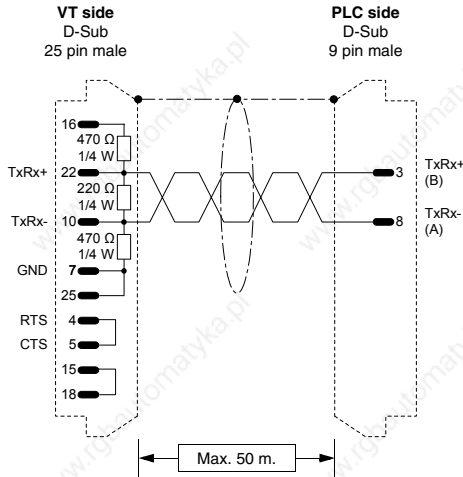

**Order code:
CVPLC01402**

SIMATIC S7

(RS485)

SIMATIC S7 200
Address of CPU = 1 - 126

SIMATIC S7 300, S7 400 MPI
Address of VT: 1...31
Address of PLC: 1...31

To have simultaneous communication between the PLC S7 programming package and the VT, it is advisable to use the SIEMENS 6ES7972-0BB20-OXAO passing connector.

N.B.: Max. 50m without repeater

(See "Chapter 40 -> Connecting the cable shield")

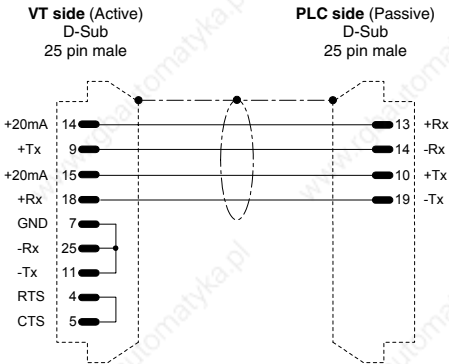

**Order code:
CVPLC01502**

**SIMATIC S5
FAP CPU 928B
module TTY 6ES5 752-0AA12**

(Current loop)

(See "Chapter 40 -> Connecting the cable shield")

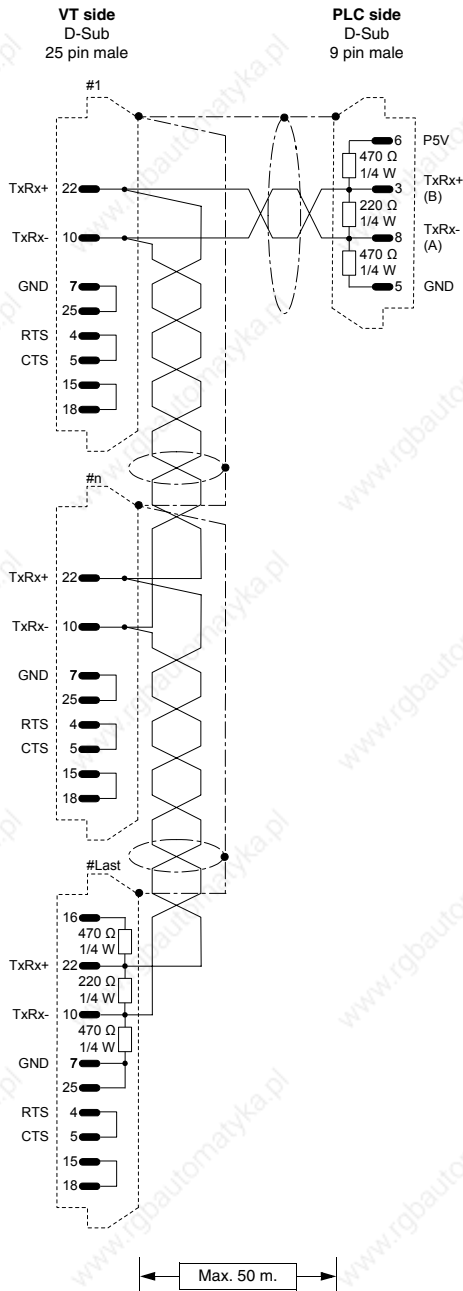

**Order code:
NOT CODED**

SIMATIC S7

(RS485)

SIMATIC S7 200
Address of CPU = 1 - 126

SIMATIC S7 300, S7 400 MPI
Address of VT: 1...31
Address of PLC: 1...31

Instead of using a 9 pin connector and integrating the resistances, the following Siemens connectors can be used with resistances already integrated and insertable with a sliding switch:

SIEMENS 6ES7972-0BA10-0XA0
SIEMENS 6ES7972-0BA40-0XA0
SIEMENS 6GK1500-0EA00

For simultaneous communication between the programming package, the PLC S7 and the VT, you are advised to use the following Siemens passing connectors with resistances already integrated and insertable with a sliding switch:

SIEMENS 6ES7972-0BB10-0XA0
SIEMENS 6ES7972-0BB40-0XA0

N.B.: Maximum length without repeater - 50m.

(See "Chapter 40 -> Connecting the cable shield")

SPRECHER+SCHUH PLC

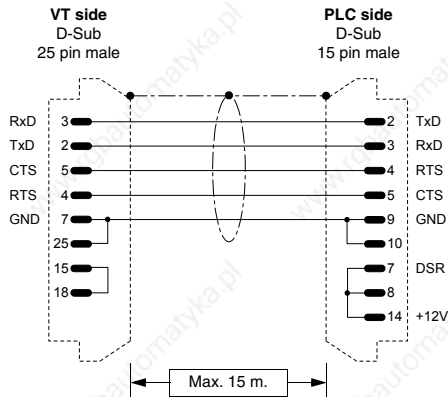

Order code:
CVPLC03102

(RS232)

(See "Chapter 40 -> Connecting the cable shield")

SQUARE-D PLC

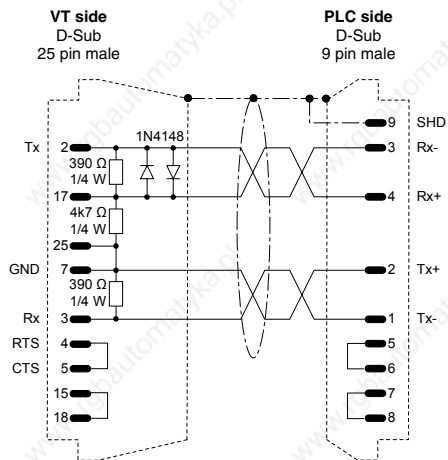

Order code:
CVPLC13102

Series 400, 500, 600

(RS422)

(See "Chapter 40 -> Connecting the cable shield")

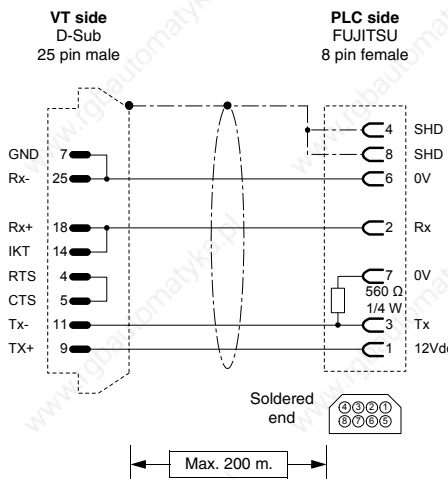

Order code:
CVPLC19102

Series 50
In the CPU programming connector
(Programmer's Port).

(Current loop).

(See "Chapter 40 -> Connecting the cable shield")

TELEMECANIQUE PLC

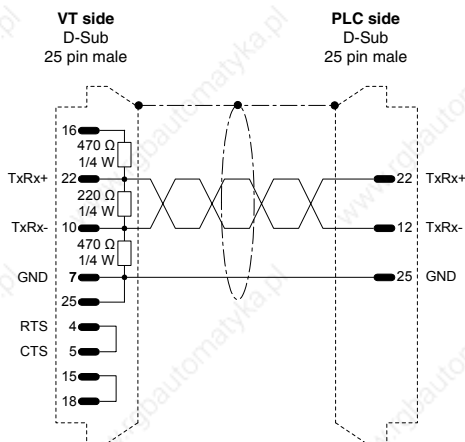

Order code:
CVPLC11002

TSX47 UNITELWAY module TSXSXM21
Port Ch.1
(RS485)

Point to point connection.

Address of VT: 4...31
Address of PLC (N): 0, 4...31
Address of PLC module: 0...254

(See "Chapter 40 -> Connecting the cable shield")

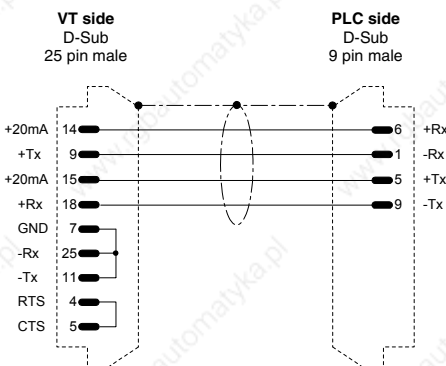

Order code:
CVPLC11102

TSX17/20 using CVPLC1Q102 translator

(Current loop)

(See "Chapter 40 -> Connecting the cable shield")

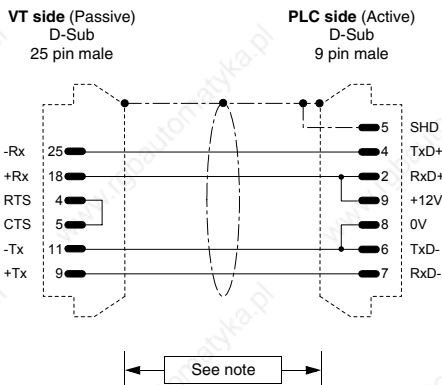

Order code:
CVPLC11202

TSX47 - 67 - 87 - 107

(Current loop)

NOTE: The max length of the cable depends on which version of the Telemecanique CPU hardware is being used. With versions of hardware coded lower than V3 (E.g. CPU 47/11, 47/20) the length of the cable is limited to 3 meters given that the serial port of the CPU is not optoisolated !!! In this case, whenever you need to create a cable longer than 3 meters, it is advisable to employ a Telemecanique device like XBT Z 9011 or 9012 to guarantee the galvanic isolation of the serial line. Failure to adopt such a device can cause damage to the CPU's serial port !!!

If the CPU is of a hardware version coded higher than V3 (E.g.. CPU 47/411, 47/425 etc.) the max length of the cable relates to the particular characteristics of the interface in Current loop (max 1000 meters) even without employing the optoisolating device mentioned above, in so far as the CPUs have an internal circuitry created to guarantee the optoisolation of the line.

(See "Chapter 40 -> Connecting the cable shield")

See note

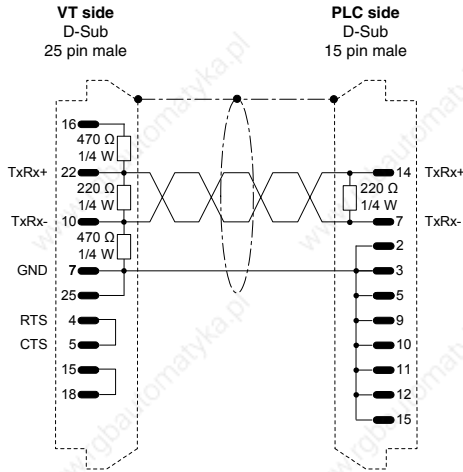

**Order code:
CVPLC11602**

TSX17 UNITELWAY
(RS485)

Point to point connection.

Address of VT: 4...31
Address of PLC (N): 0
Address of PLC module: 254

(See "Chapter 40 -> Connecting the cable shield")

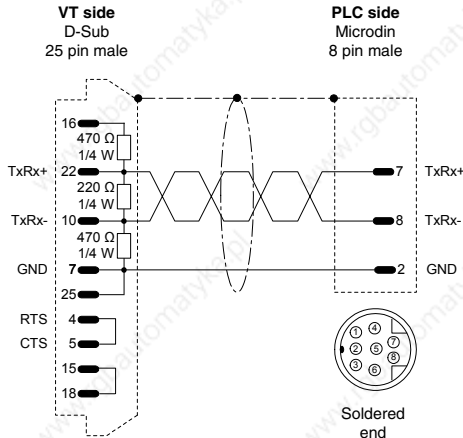

**Order code:
CVPLC11702**

TSX07 / 37 / 57 UNITELWAY
Twido (Porta MODBUS)

(RS485)

Point to point connection.

Address of VT: 4...31
Address of PLC (N): 0
Address of PLC module: 254

(See "Chapter 40 -> Connecting the cable shield")

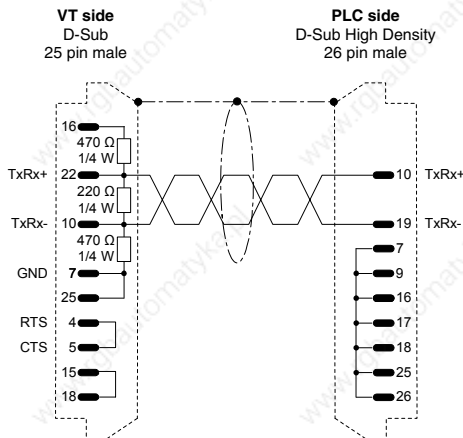

**Order code:
CVPLC11802**

TSX47 UNITELWAY
UNITELWAY port

(RS485)

Point to point connection.

Address of VT: 4...31
Address of PLC (N): 0
Address of PLC module: 254

(See "Chapter 40 -> Connecting the cable shield")

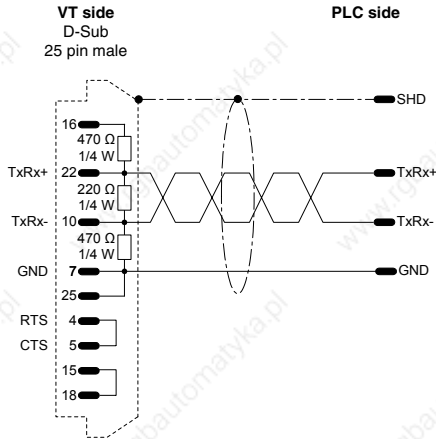

**Order code:
NOT CODED**

TSX07 ... 87 UNITELWAY
(RS485)

Point to point connection.
Address of VT: 4...31
Address of PLC (N): 0
Address of PLC module: 254

(See "Chapter 40 -> Connecting the cable shield")

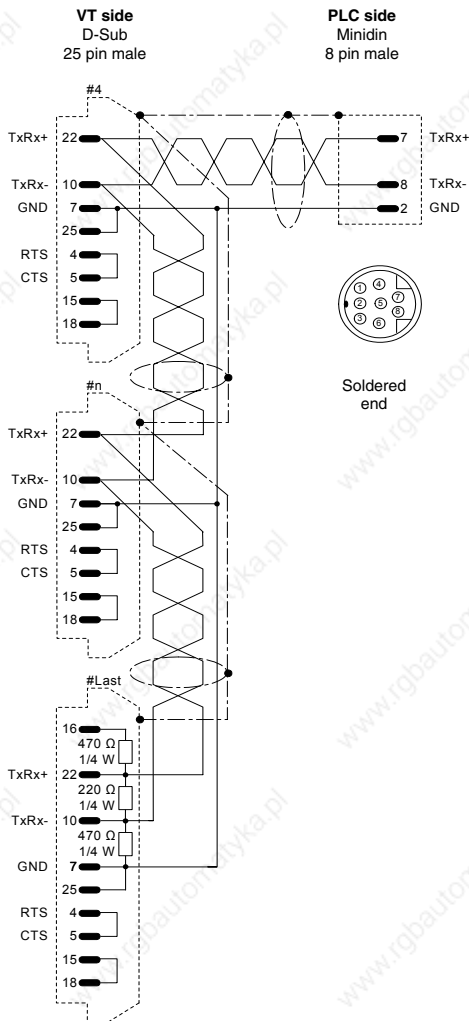

**Order code:
NOT CODED**

TSX07 / 37 UNITELWAY
(RS485)

Cable valid for several VTs connected to a single Master PLC.

Address of VT: 4...31
Address of PLC (N): 0
Address of PLC module: 254

(See "Chapter 40 -> Connecting the cable shield")

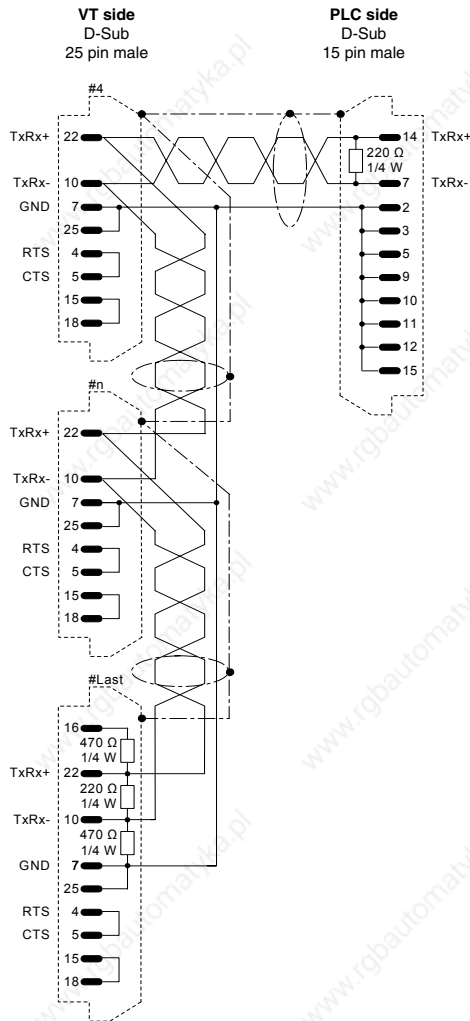

Order code:
NOT CODED

TSX17 UNITELWAY

(RS485)

Cable valid for several VTs connected to a single Master PLC.

Address of VT: 4...31
 Address of PLC (N): 0
 Address of PLC module: 254

(See "Chapter 40 -> Connecting the cable shield")

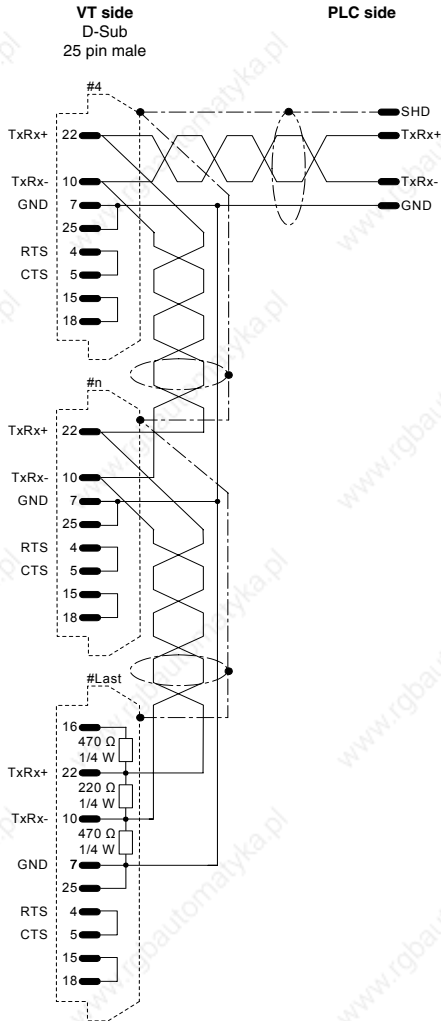

**Order code:
NOT CODED**

TSX07 ... 87 UNITELWAY

(RS485)

Address of VT: 4...31
Address of PLC (N): 0, 4...31
Address of PLC module: 0...254

To have more than one PLC in the network, one PLC must be configured as network Master and the others as Slaves.
To be able to configure a PLC as a Slave it is necessary that:

- In the case of PLCs TSX07 and TSX37 use programming software to parameterize the PLC as Slave, assigning the chosen address and jump-connecting pins 2 and 6 on the connector connecting to the network.
- In the case of PLCs TSX17, TSX47, TSX67 and TSX87 refer to the PLC manual to see which pins to jump-connect on the network connector to assign the chosen Slave address.

(See "Chapter 40 -> Connecting the cable shield")

TEXAS INSTRUMENTS PLC

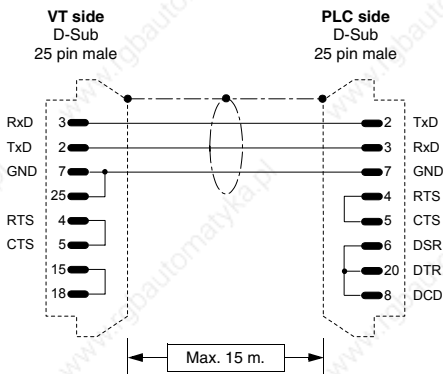

**Order code:
CVPLC06102**

Series 400 CPU 435
Series 500 CPU 520 - 530
Series 505 CPU 525 - 535

(RS232)

NB : In the case of CPU 435, set the protocol in ASCII mode (AUX function of TISOFT version 1.2 and upwards).

Connection with module DCM (405 series)

(See "Chapter 40 -> Connecting the cable shield")

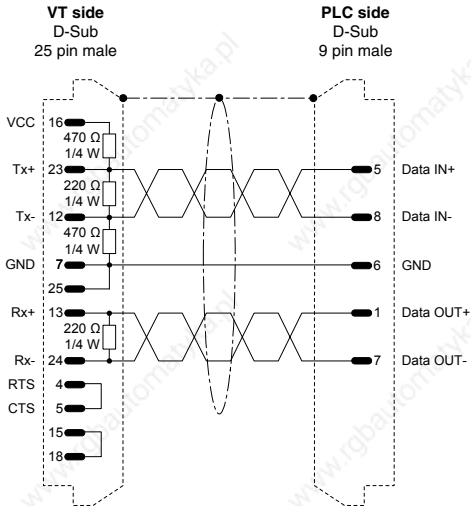

Order code:
CVPLC06202

Series 500 CPU 520 - 530
Series 505 CPU 525 - 535 - 545 (*)

(RS422)

(*) Valid only in the case of CPU 545 with hardware version 545-1101. In the case of CPU 545 with hardware version coded higher, see **CVPLC06502 cable**.

(See "Chapter 40 -> Connecting the cable shield")

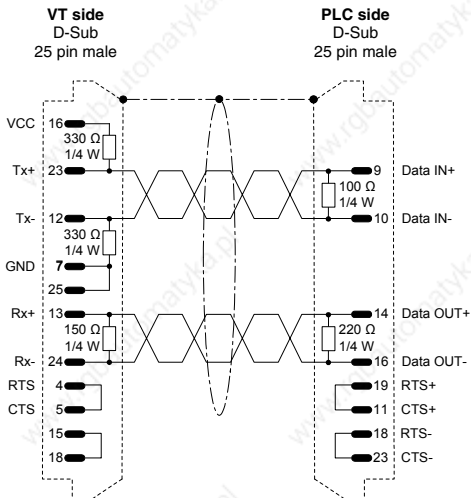

Order code:
CVPLC06302

Series 400 CPU 435

(RS422)

NB: Set the protocol in ASCII mode (AUX function of TISOFT from version 1.2 upwards).

(See "Chapter 40 -> Connecting the cable shield")

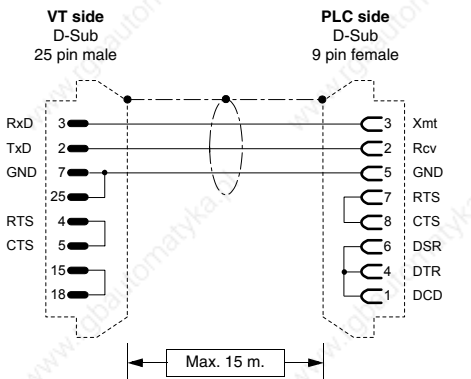

Order code:
CVPLC06402

Series 505 CPU 545 - 555

(RS232)

NB: In the case of CPU 555, if connected to port 2, remove the jumper between pins 7 and 8 on the PLC side.

(See "Chapter 40 -> Connecting the cable shield")

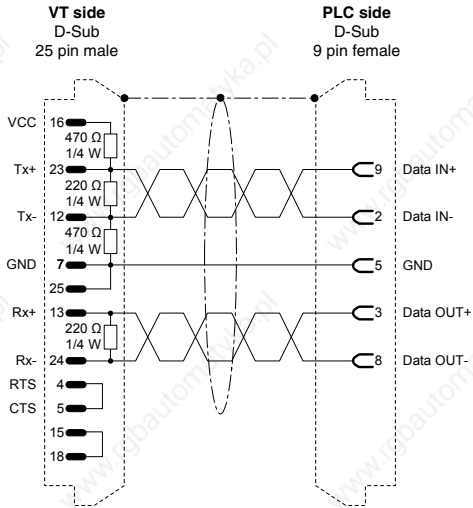

Order code:
CVPLC06502

Series 505 CPU 545 (*) - 555
(RS422)

(*) Valid only in the case of CPU 545 with hardware versions 545-1102, 545-1103 and 545-1104. In the case of CPU 545 with lower hardware version see cable **CVPLC06202**.

(See "Chapter 40 -> Connecting the cable shield")

TOSHIBA PLC

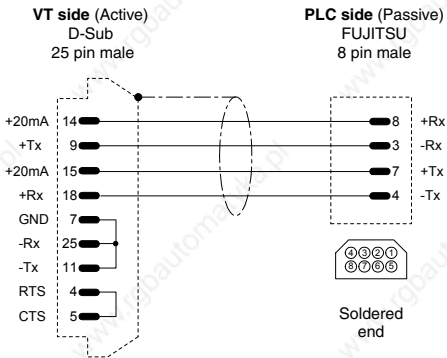

Order code:
CVPLC10102

(EX 100) CPU M20 - M40
In the CPU programming connector
(Programmer's Port).

(Current loop).

(See "Chapter 40 -> Connecting the cable shield")

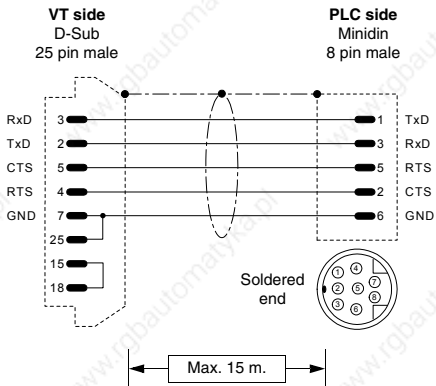

Order code:
CVPLC10212

Series T1
(RS232)

(See "Chapter 40 -> Connecting the cable shield")

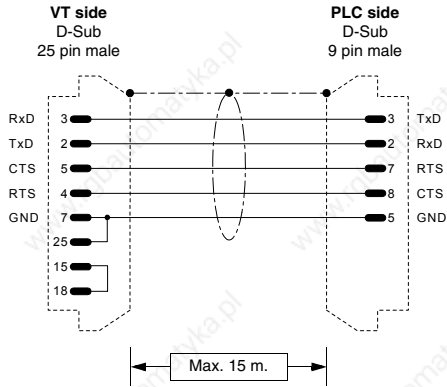

Order code:
CVPLC10222

Series T2/T3
(RS232)
(See "Chapter 40 -> Connecting the cable shield")

HBM BALANCE SCALES

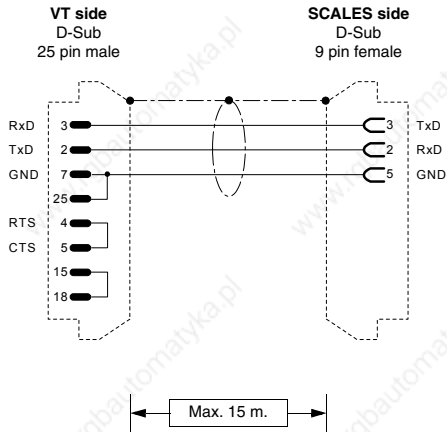

Order code:
NOT CODED

WE2110
(RS232)
(See "Chapter 40 -> Connecting the cable shield")

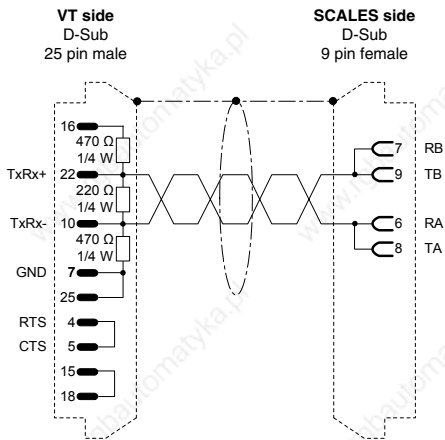

Order code:
NOT CODED

WE2110
(RS485)
(See "Chapter 40 -> Connecting the cable shield")

ASCON THERMOREGULATOR

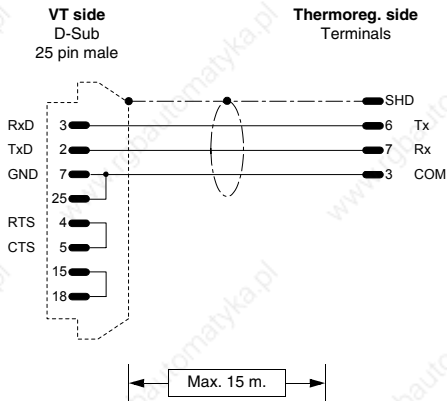

Order code:
NOT CODED

XS-XP-XN-XC-XT-XF

(RS232)

Connection with module ASCON ALS/3/232

(See "Chapter 40 -> Connecting the cable shield")

GEFRAN THERMOREGULATOR

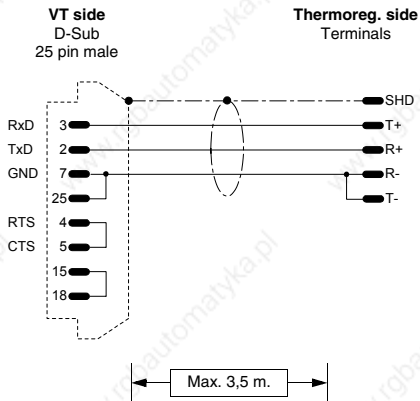

Order code:
NOT CODED

800/1600/1800

(RS232)

(See "Chapter 40 -> Connecting the cable shield")

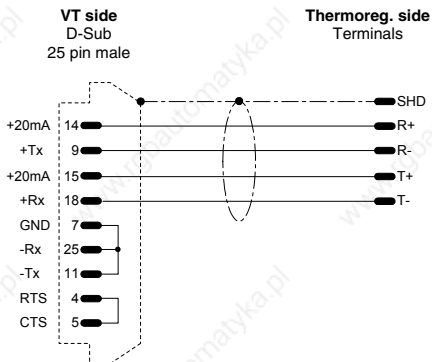

Order code:
NOT CODED

800/1600/1800

(Current loop)

(See "Chapter 40 -> Connecting the cable shield")

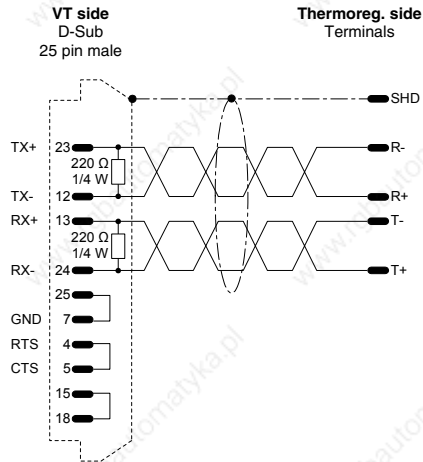

**Order code:
NOT CODED**

800/1600/1800
(RS422)
(See "Chapter 40 -> Connecting the cable shield")

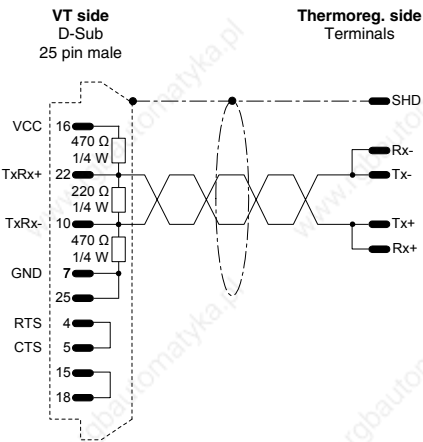

**Order code:
NOT CODED**

800/1600/1800
(RS485)
Only applies to protocol of Modbus (Ser.p = 1)
(See "Chapter 40 -> Connecting the cable shield")

HENGSTLER THERMOREGULATOR

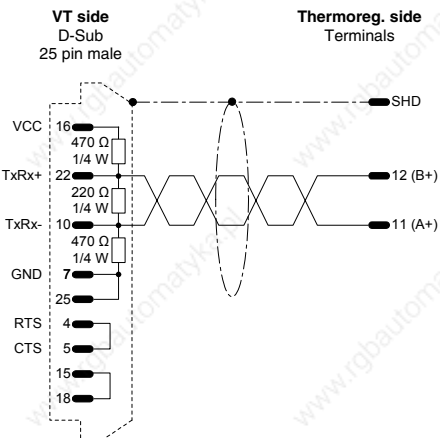

**Order code:
NOT CODED**

901/906
(RS485)
(See "Chapter 40 -> Connecting the cable shield")

WEST THERMOREGULATOR

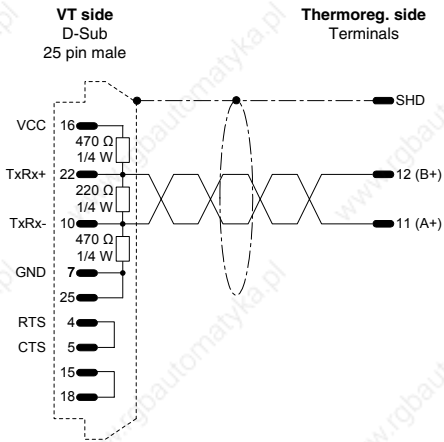

**Order code:
NOT CODED**

6100/6600
(RS485)
(See "Chapter 40 -> Connecting the cable shield")

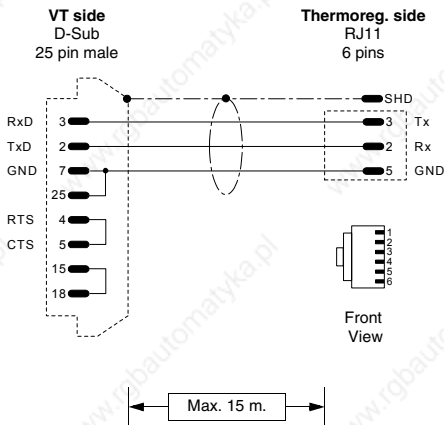

**Order code:
NOT CODED**

MLC9000 Intrabus
(RS232)
(See "Chapter 40 -> Connecting the cable shield")

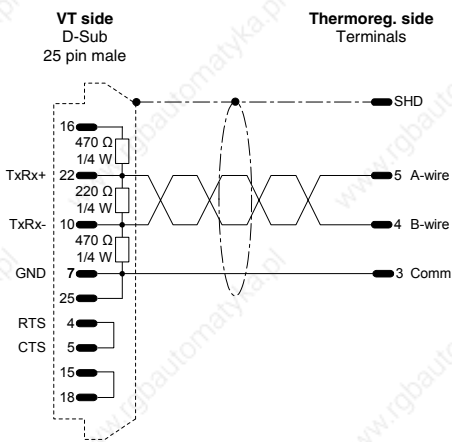

**Order code:
NOT CODED**

MLC9000 Modbus
(RS485)
(See "Chapter 40 -> Connecting the cable shield")

Cable information summary

The table below lists all the cables mentioned in the chapter together with their order codes and a description of the type of device with which it can be used.

Table 40.1: Cable information list (Part 1 of 3)

Producer	Code	Description	RS
ABB	CVPLC03102	T200 (KP60)	232
	CVPLC14102	CS31 (KR31 / KT31/91/92/93/94/95) T200 (KP62)	232
	CVPLC14202	CS31 (KR31 / KT31) RTU MODBUS PROTOCOL	232
	CVPLC14302	CS31 (07KP92 R101) RTU MODBUS PROTOCOL	232
	CVPLC14402	CS31 (07KP92 R101) RTU MODBUS PROTOCOL	422
	CVPLC14502	CS31 (07KP92 R101) RTU MODBUS PROTOCOL	485
	CVPLC14602	CS31 (Series 40 & 50)	232
	CVPLC21202	AC70	232
	CVPLC14802	ACS210	232
	CVPLC06402	AC450	232
AEG MODICON	CVPLC17102	COMPACT / A120 / A250	232
	CVPLC17202	MICRO	232
ALLEN-BRADLEY	CVPLC07112	SLC500 CPU 5/02 5/03	485
	CVPLC07202	PLC5 /11/20/30/40/40L/60/60L	232
	CVPLC07302	PLC5 /11/20/30/40/40L/60/60L	422
	CVPLC07402	SLC500 5/03-04-05 Micrologix CPU5550 ControlLogix	232
	CVPLC07502	Protection device for DH485	485
	CVPLC07602	MICROLOGIX CPU1000, 1200 and 1500	232
ALTUS	CVPLC27102	ALNET-1	232
	CVPLC27202	ALNET-1	232
	CVPLC27302	ALNET-1	485
	CVPLC27402	ALNET-1	485
ATOS	CVPLC29102	MPC1600, MPC2002, MPC4004	232
	CVPLC29202	MPC1600, MPC2002, MPC4004	485
BECKHOFF	CVPLC28102	BX3100 COM1 Port	232
	CVPLC28202	BX3100 COM2 Port	232
	CVPLC28302	BX3100 COM2 Port	485
	CVPLC28402	KL6001	232
	CVPLC28502	KL6021	485
	CVPLC28602	BC7300/BK7300	485
BOSCH	CVPLC24102	CL150	232
B&R AUTOMATION	CVPLC25102	NET2000	232
CONTROL TECHNIQUES	CVPLC33102	Commander SE - CTNET	485
CROUZET	CVPLC20102	RPX 10-20-30	232
FOXBORO	CVPLC30102	RTU20	232

C.L.: Current loop

Table 40.1: Cable information list (Part 2 of 3)

Producer	Code	Description	RS
FUJI	CVPLC26102	Micrex-F F705	422
GE FANUC	CVPLC09102	CPU 90-90 MICRO - VERSAMAX PORT 2	422
	CVPLC09202	Series 90 - CMM311 PORT1	232
	CVPLC09302	Series 90 - CMM311 PORT2	422
	CVPLC09402	VERSAMAX PORT1	232
GEFRAN	CVPLC23102	Series MPS-NS	232
HITACHI	CVPLC03102	H, 02H	232
	CVPLC03202	EM CPU CPM - E3	232
	CVPLC03302	EC	232
	CVPLC03402	H, CPU22-02HC	232
	CVPLC03502	Series EH150	232
	CVPLC03602	COMM H	422
IDEC IZUMI	CVPLC19102	FA2-FA2J	C.L.
	CVPLC19302	Series MICRO 3	485
KLÖCKNER MOELLER	CVPLC12112	PS306	485
	CVPLC12212	PS316 / PS416-CPU400	485
	CVPLC12302	PS4-141-MM1 / PS4-201-MM1 / PS4-341-MM1	232
	CVPLC12402	PS416-CPU400	232
KEYENCE	CVPLC15102	KV10-16-24-40	232
KOYO	CVPLC32102	DL 240 CPU Port	232
	CVPLC32202	DL 340 CPU Port	232
	CVPLC32302	DL 405 DCM, DL 405 CPU Port, DL 305 DCU	232
	CVPLC32402	DL 405 DCM, DL 305 DCU	422
	CVPLC32502	DL 305 DCU	232
KUHNKE	CVPLC07602	KUBES	232
LG	CVPLC21102	K30 - K500 - K1000	232
	CVPLC21202	K10	232
	CVPLC21302	Series MK	485
	CVPLC21402	Master K1205	232
	CVPLC21502	Master K1205	485
MATSUSHITA-NAIS	CVPLC16102	FP-1	422
	CVPLC16202	FP-1 / FP-M	232
	CVPLC16302	FP-M / FP-0 / FP-2	232
	CVPLC16402	FP-3	422
MICROLINK	CVPLC31102	ML-14	232
	CVPLC31202	ML-14	485
mitsubishi	CVPLC05102	Series FX	232
	CVPLC05202	Series FX	232

C.L.: Current loop

Table 40.1: Cable information list (Part 3 of 3)

Producer	Code	Description	RS
	CVPLC05302	Series A + MITSUBISHI SC-05 adaptor	232
	CVPLC05402	Series A	232
	CVPLC05502	Series Fx0 - Fx0 N - Fx2 N	232
OMRON	CVPLC02102	C200H LK201 3G2A6 LK201 EV1	232
	CVPLC02202	C20-28-40-60H	232
	CVPLC02302	C200H LK202	422
	CVPLC02402	Serie H, CQM1, CVM1, Serie CS1, Serie C200H..	232
	CVPLC02502	CQM1CIF02	232
	CVPLC02602	CVM1	422
	CVPLC02802	CJ1C	232
SAIA	CVPLC04102	CPU PCD2/4	232
	CVPLC04202	S-BUS CPU PCD1/2/4	232
SATT CONTROL	CVPLC18102	Series 31 - 90	232
	CVPLC18202	Series 115	232
SCHLEICHER	CVPLC08102	CPU-10 / CPU-20 COM2	232
	CVPLC08202	Series F connection PGU	232
	CVPLC08302	Series F connection FCS	422
SIEMENS	CVPLC01202	S5 AG90 ... 135 FAP S5 944/945	C.L.
	CVPLC01402	S7 200/300/400	485
	CVPLC01502	FAP S5 928B	C.L.
SPRECHER+SCHUH	CVPLC03102	SPRECHER + SCHUH	232
SQUARE-D	CVPLC13102	Series 400 / 500 / 600	422
	CVPLC19102	Series 50	C.L.
TELEMECANIQUE	CVPLC1Q102	Adaptor PLC TSX17 RS485 - C.L. (Supplied by ESA)	C.L.
	CVPLC11002	TSX47 UNITELWAY module TSXS2M21	485
	CVPLC11102	CVPLC1Q102	C.L.
	CVPLC11202	TSX47-67-87-107	C.L.
	CVPLC11602	TSX17 UNITELWAY	485
	CVPLC11702	TSX07/37/57 UNITELWAY - Twido	485
	CVPLC11802	TSX47 UNITELWAY	485
TEXAS INSTRUMENTS	CVPLC06102	Series 405-500	232
	CVPLC06202	Series 500-505	422
	CVPLC06302	Series 400	422
	CVPLC06402	Series 505 CPU 545 - 555 PORT 1	232
	CVPLC06502	Series 505 CPU 555 PORT 2	422
TOSHIBA	CVPLC10102	M20-40-EX	C.L.
	CVPLC10112	Series T1	232
	CVPLC10222	Series T2/T3	232

C.L.: Current loop

Chapter 41 Resistance to chemical substances

Contents	Page
Chemical substances	41-2
Cleaning the VT	41-7
Case for terminals VT, H Series	41-7

This chapter consists of 8 pages.

All our VTs are built to withstand the effects of the more common chemical substances encountered in industrial and non-industrial environments. Each element of the VT that could be exposed to these substances (epoxy coating, keyboard membrane, screen surface, touch screen and gaskets), is tested to determine its degree of resistance.

The type of test is not the same for each component but changes according to the testing authority. Below is an example of a test (carried out by Alcatel Bell).

The test procedure was as follows:

A 2 cm ball of cotton wool was immersed in the test substance and then placed on the keyboard. Two cotton wool balls with different substances were placed separately on each keyboard; this was then put in a Petri dish and kept at a temperature of 25°C for an hour; after this, the keyboard was washed in water and dried.

The keyboard was observed and the results classified as follows:

- A - No visible deterioration
- B - Very slight deterioration
- C - Some deterioration
- D - Gross damage visible

 **The substances not appearing in the table were not tested, so there is no information regarding their effect.**

Chemical substances

The table shown below lists all the substances used for the test with their various results.

 **The table must nevertheless be considered an approximate guide regard chemical substances: no tests have been carried out on a completely assembled terminal.**

 **The following table DOES NOT show any test carried out on the plastic case of terminals VT, H series. For further information, see Page 41-7**

Table 41.1: Chemical resistance data sheet (Part 1 of 5)

Substance		Parts of the VT						Accessories	Resistance
		Epoxy powder coating ³	Matt keyboard surface ²	Transparent keyboard surface ¹	Touch screen ²	Protective-glass	Gaskets	Protective ² film	
1,1,1-Trichlorethylene	NS	--	>24h	--	>24h	--	--	>24h	☺
Acetaldehyde	NS	--	>24h	--	>24h	--	--	>24h	☺
Acetic acid	10%	3Y	--	--	--	--	--	--	☺
	20%	3Y	--	--	--	--	--	--	☺
	<50%	--	>24h	--	>24h	--	--	>24h	☺
Acetone	NS	O	>24h	--	>24h	>8h	F	>24h	☺
Acetyl	NS	--	--	--	--	--	E	--	☹
Acid solutions	LC	--	--	--	--	--	E	--	☺
	HC	--	--	--	--	--	F	--	☹
Ajax	NS	--	>24h ⁴	--	>24h ⁴	--	--	--	☺
Aliphatic hydrocarbons	NS	--	>24h	--	>24h	--	--	>24h	☺
Alkaline solutions	LC	--	--	--	--	--	E	--	☺
	HC	--	--	--	--	--	F	--	☹
Ammonia	NS	--	--	--	--	--	E	--	☺
	<2%	--	>24h	--	>24h	--	--	>24h	☺
	5%	--	--	--	--	>24h	--	--	☺
	10%	3Y	--	--	--	--	--	--	☺
	35%	3Y	--	--	--	--	--	--	☺
Ariel	NS	--	>24h ⁴	--	>24h ⁴	--	--	--	☺
Benzene	NS	S	--	A	>24h	--	--	>24h	☹
Benzylalcohol	NS	--	O	--	O	--	--	O	☹
Bichromate	NS	--	--	--	>24h	--	--	>24h	☺
Blown castor oil	NS	--	--	--	>24h	--	--	--	☺
Carbon dioxide	NS	--	--	--	--	--	E	--	☺
Castor oil	NS	--	>24h	--	>24h	--	--	>24h	☺
Caustic soda	<2%	--	>24h	--	>24h	--	--	>24h	☺
	10%	--	--	--	--	>24h	--	--	☺
	50%	--	--	B	--	--	--	--	☹
Caustic solution	CO	--	O	--	O	--	--	O	☹
Chloric acid	NS	--	--	A	--	--	--	--	☺
Chlorine	NS	--	--	--	--	--	G	--	☹

Legend:
A - No visible degradation, B - Very slight degradation, C - Slight degradation, D - Damage visible or gross, E - Unlimited use, F - Limited use, G - Use inadvisable, S - The surface melts, X - The surface blisters, O - The surface is destroyed, CO - Concentrated, HC - High concentration, LC - Low concentration, SA - Saturated, NS - Not specified, h - Hour(s), M - Month(s), Y - Year(s), ☺ - All the elements tested resist all the substances, ☹ - At least one of the elements tested may be damaged by the substances in question, ☹ - All the elements tested may be damaged by the substances in question, -- Not tested.

Notes:
1 - According to Alcatel Bell tests, 2 - According to DIN42115 Parts 2, 3 standards - According to raw material producers, 4 - Tested at 50°C

Table 41.1: Chemical resistance data sheet (Part 2 of 5)

Substance		Parts of the VT						Accessories	Resistance
		Epoxy powder coating ³	Matt keyboard surface ²	Transparent keyboard surface ¹	Touch screen ²	Protective-glass	Gaskets	Protective ² film	
Chromic acid	10%	6M	--	--	--	--	--	--	☹
	20%	6M	--	--	--	--	--	--	☹
Citric acid	5%	3Y	--	--	--	--	--	--	☺
Coca Cola	NS	--	--	A	--	--	--	--	☺
Cooking salt solution	NS	--	--	--	--	--	E	--	☺
Copper sulphate	10%	3Y	--	--	--	--	--	--	☺
Crude oil	NS	3Y	--	--	--	--	--	--	☺
Cutting oil	NS	--	>24h	--	>24h	--	--	>24h	☺
Cyclohexanol	NS	--	>24h	--	>24h	--	--	>24h	☺
Detergent	NS	--	--	A	--	--	--	--	☺
Diesel fuel	NS	--	>24h	A	>24h	--	--	>24h	☺
Diethyle ether	NS	--	>24h	--	>24h	--	--	>24h	☺
Dioxan	NS	--	>24h	--	>24h	--	--	>24h	☺
Domestos	NS	--	>24h ⁴	--	>24h ⁴	--	--	--	☺
Downey	NS	--	>24h ⁴	--	>24h ⁴	--	--	--	☺
Edible oil	NS	3Y	--	--	--	--	--	--	☺
Essence of turpentine substitute	NS	3Y	--	--	--	--	--	--	☺
Ethanol	NS	--	--	A	>24h	>24h	E	>24h	☺
	96%	3Y	--	--	--	--	--	--	☺
Ethanol denat.	NS	1M	--	--	--	--	--	--	☹
Ethylacetate	NS	--	>24h	--	>24h	--	--	>24h	☺
Ethylene glycol	NS	O	--	A	--	--	--	--	☹
Fantastic	NS	--	>24h ⁴	--	>24h ⁴	--	--	--	☺
Formaldehyde	NS	--	--	A	--	--	--	--	☺
	35Vol.	3Y	--	--	--	--	--	--	☺
	37%	--	>24h	--	--	--	--	--	☺
	42%	--	>24h	--	--	--	--	--	☺
Formic acid	5%	3Y	--	--	--	--	--	--	☺
	10%	3Y	--	--	--	--	--	--	☺
	<50%	--	>24h	--	>24h	--	--	>24h	☺
Formula 409	NS	--	>24h ⁴	--	>24h ⁴	--	--	--	☺
Gasoline/petrol	NS	3Y	--	A	>24h	>24h	F	>24h	☹
Glacial acetic acid	NS	--	--	--	<1h	--	--	<1h	☹

Legend:
A - No visible degradation, B - Very slight degradation, C - Slight degradation, D - Damage visible or gross, E - Unlimited use, F - Limited use, G - Use inadvisable, S - The surface melts, X - The surface blisters, O - The surface is destroyed, CO - Concentrated, HC - High concentration, LC - Low concentration, SA - Saturated, NS - Not specified, h - Hour(s), M - Month(s), Y - Year(s), ☺ - All the elements tested resist all the substances, ☹ - At least one of the elements tested may be damaged by the substances in question, -- Not tested.

Notes:
1 - According to Alcatel Bell tests, 2 - According to DIN42115 Parts 2, 3 standards - According to raw material producers, 4 - Tested at 50°C

Table 41.1: Chemical resistance data sheet (Part 3 of 5)

Substance		Parts of the VT						Accessories	Resistance
		Epoxy powder coating ³	Matt keyboard surface ²	Transparent keyboard surface ¹	Touch screen ²	Protective-glass	Gaskets	Protective ² film	
Glycerine	NS	--	>24h	--	>24h	--	E	>24h	☺
Glycol	NS	--	--	--	--	--	E	--	☺
Grape juice	NS	--	>24h ⁴	--	>24h ⁴	--	--	--	☺
Gumption	NS	--	>24h ⁴	--	>24h ⁴	--	--	--	☺
High pressure steam (at >100°C)	NS	--	O	--	O	--	G	O	☹
Hydraulic fluids	NS	--	--	--	--	--	F	--	☹
Hydrochloric acid	<10%	--	>24h	--	>24h	--	G	>24h	☹
	10%	3Y	--	--	--	--	--	--	☺
	20%	3Y	--	--	--	--	--	--	☺
Hydrogen peroxide	<25%	--	--	--	>24h	--	--	>24h	☺
	30%	--	--	A	--	--	--	--	☺
	40Vol.	6M	--	--	--	--	--	--	☹
Isopropanol	NS	S	>24h	A	>24h	--	--	>24h	☹
Jet Dry	NS	--	>24h ⁴	--	>24h ⁴	--	--	--	☺
Lactic acid	5%	3Y	--	--	--	--	--	--	☺
Lemon juice	NS	--	B ⁴	--	B ⁴	--	--	--	☹
Lenor	NS	--	>24h ⁴	--	>24h ⁴	--	--	>24h	☺
Linseed oil	NS	3Y	>24h	--	>24h	--	--	>24h	☺
Liquid allum	NS	--	--	--	--	--	E	--	☺
Methane	NS	--	--	--	--	--	F	>24h	☹
Methanol	NS	--	>24h	A	>24h	--	F	--	☹
Methyl ethyl ketone	NS	--	>24h	--	>24h	--	--	>24h	☺
Methylene Chloride	NS	1M	O	--	O	--	G	O	☹
Milk	NS	--	>24h ⁴	--	>24h ⁴	--	--	--	☺
Mineral acids	CO	--	O	--	O	--	--	O	☹
Mineral oil 0-180	NS	--	--	A	--	--	E	--	☺
Mustard	NS	--	>24h ⁴	--	>24h ⁴	--	--	--	☺
n-Butanol	NS	S	--	--	--	--	--	--	☹
Nitrate of ammonia	SA	3Y	--	--	--	--	--	--	☺
Nitric acid	<10%	--	>24h	D	>24h	--	G	>24h	☹
	10%	3Y	--	--	--	--	--	--	☺
	20%	3Y	--	--	--	--	--	--	☺
	50%	1M	--	--	--	--	--	--	☹

Legend:
A - No visible degradation, B - Very slight degradation, C - Slight degradation, D - Damage visible or gross, E - Unlimited use, F - Limited use, G - Use inadvisable, S - The surface melts, X - The surface blisters, O - The surface is destroyed, CO - Concentrated, HC - High concentration, LC - Low concentration, SA - Saturated, NS - Not specified, h - Hour(s), M - Month(s), Y - Year(s), ☺ - All the elements tested resist all the substances, ☹ - At least one of the elements tested may be damaged by the substances in question, -- Not tested.

Notes:
1 - According to Alcatel Bell tests, 2 - According to DIN42115 Parts 2, 3 standards - According to raw material producers, 4 - Tested at 50°C

Table 41.1: Chemical resistance data sheet (Part 4 of 5)

Substance		Parts of the VT						Accessories	Resistance
		Epoxy powder coating ³	Matt keyboard surface ²	Transparent keyboard surface ¹	Touch screen ²	Protective-glass	Gaskets	Protective ² film	
Nitrocellulose solvents	NS	--	--	--	--	--	G	--	☹
Oil	NS	--	--	--	--	--	E	--	☺
Oleic acid	NS	3Y	--	--	--	--	--	--	☺
Paraffin oil	NS	3Y	>24h	--	>24h	--	--	>24h	☺
Perchloroethylene	NS	--	--	--	>24h	--	G	>24h	☹
Persil	NS	--	>24h ⁴	--	>24h ⁴	--	--	--	☺
Phosphoric acid	10%	3Y	--	--	--	--	--	--	☺
	20%	3Y	--	--	--	--	--	--	☺
	50%	3Y	--	--	--	--	--	--	☺
	<30%	--	>24h	--	>24h	--	--	>24h	☺
Photographic chemicals	NS	--	--	--	--	--	E	--	☺
Potassium carbonate	NS	--	>24h	--	>24h	--	--	>24h	☺
Potassium ferrocyanide	NS	--	>24h	--	>24h	--	--	>24h	☺
Potassium hydroxide	10%	3Y	--	--	--	--	--	--	☺
	20%	3Y	--	--	--	--	--	--	☺
Sea water	NS	--	--	--	--	--	E	--	☺
Sebacic acid	SA	3Y	--	--	--	--	--	--	☺
Silicon grease	NS	--	--	--	--	--	E	--	☺
Silicon oil	NS	--	--	--	>24h	--	E	>24h	☺
Skydrol	NS	6M	--	--	--	--	--	--	☹
Sodium carbonate	SA	--	>24h	--	--	--	--	--	☺
Sodium chloride	3%	3Y	--	--	--	--	--	--	☺
Sodium hydroxide	20%	3Y	--	--	--	--	--	--	☺
Sodium hypochloride	NS	--	>24h	--	--	--	--	--	☺
	10%	6M	>24h	--	--	--	--	--	☹
	<20%	--	--	--	>24h	--	--	>24h	☺
Softner	NS	--	>24h	--	>24h	--	--	--	☺
Sulphuric acid	<10%	--	--	--	--	--	--	>24h	☺
	10%	3Y	--	--	>24h	>24h	--	--	☺
	28%	3Y	--	A	--	--	--	--	☺
	50%	6M	--	--	--	--	--	--	☹
	CO	--	--	--	--	--	G	--	☹
Tartaric acid	SA	3Y	--	--	--	--	--	--	☺

Legend:
A - No visible degradation, B - Very slight degradation, C - Slight degradation, D - Damage visible or gross, E - Unlimited use, F - Limited use, G - Use inadvisable, S - The surface melts, X - The surface blisters, O - The surface is destroyed, CO - Concentrated, HC - High concentration, LC - Low concentration, SA - Saturated, NS - Not specified, h - Hour(s), M - Month(s), Y - Year(s), ☺ - All the elements tested resist all the substances, ☹ - At least one of the elements tested may be damaged by the substances in question, -- Not tested.

Notes:
1 - According to Alcatel Bell tests, 2 - According to DIN42115 Parts 2, 3 standards - According to raw material producers, 4 - Tested at 50°C

Table 41.1: Chemical resistance data sheet (Part 5 of 5)

Substance		Parts of the VT						Accessories	Resistance
		Epoxy powder coating ³	Matt keyboard surface ²	Transparent keyboard surface ¹	Touch screen ²	Protective-glass	Gaskets	Protective ² film	
Teepol	NS	3Y	--	--	--	--	--	--	☺
Toluene	NS	3Y	>24h	A	>24h	--	G	>24h	☺
Tomato juice	NS	--	B ⁴	--	B ⁴	--	--	--	☹
Tomato sauce	NS	--	B ⁴	--	B ⁴	--	--	--	☹
Top Job	NS	--	>24h ⁴	--	>24h ⁴	--	--	--	☺
Trichloroethylene	NS	S	--	--	>24h	--	G	>24h	☺
Turpentine oil	NS	--	>24h	--	--	--	F	--	☹
Turpentine substitute	NS	--	--	--	>24h	--	--	>24h	☺
Vaseline	NS	--	--	--	--	--	F	--	☹
Vim	NS	--	>24h ⁴	--	>24h ⁴	--	--	--	☺
Vinegar	NS	--	--	D	--	--	--	--	☹
Vortex	NS	--	>24h ⁴	--	>24h ⁴	--	--	--	☺
Washing powders	NS	--	>24h	--	>24h	--	E	>24h	☺
Water	NS	--	>24h	--	--	--	E	--	☺
White spirit	NS	3Y	--	A	--	--	--	--	☺
Windex	NS	--	>24h ⁴	--	>24h ⁴	--	--	--	☺
Wisk	NS	--	>24h ⁴	--	>24h ⁴	--	--	--	☺
Wood oil	NS	--	--	--	--	--	F	--	☹
Xilene	NS	1Y	>24h	--	>24h	--	--	--	☺

Legend:
A - No visible degradation, B - Very slight degradation, C - Slight degradation, D - Damage visible or gross, E - Unlimited use, F - Limited use, G - Use inadvisable, S - The surface melts, X - The surface blisters, O - The surface is destroyed, CO - Concentrated, HC - High concentration, LC - Low concentration, SA - Saturated, NS - Not specified, h - Hour(s), M - Month(s), Y - Year(s), ☺ - All the elements tested resist all the substances, ☹ - At least one of the elements tested may be damaged by the substances in question, ☹ - All the elements tested may be damaged by the substances in question, -- Not tested.

Notes:
1 - According to Alcatel Bell tests, 2 - According to DIN42115 Parts 2, 3 standards - According to raw material producers, 4 - Tested at 50°C

Cleaning the VT

For cleaning the VT we recommend Denaturalised Ethyl Alcohol. Should this be insufficient for removing the impurity making it necessary to use other products, consult the tables above.



This information DOES NOT apply for terminals VT, H series. Use water instead of alcohol, or non aggressive detergents.

Case for terminals VT, H Series

The producer of the raw materials used to manufacture the case does not supply detailed information regarding the tests performed and the concentration of substances used during the tests. The information below is the supplier's original text.

Chemical resistance of certain material is dependent on the environmental conditions where the material is actually used. Therefore, it should be understood that the various usage parameters involved in and actual applications, e.g., chemical exposure duration, chemical type, loading, service temperature, stress, outdoor exposure, etc., may alter the performance significantly. Another important factor affecting the chemical resistance is the type of thermoplastic resin. Amorphous polymers tend to be more susceptible to chemical attack than crystalline polymers.

Resins are generally stable to water, weak acid and mineral oil. Mechanical properties and surface appearance, however, can be deteriorated if a molded part is exposed to hot water, strong acid, alkalis, Ketones and aromatic hydrocarbons, etc.

Chemical	Effect
Acids	Stable under common conditions of concentration and temperature.
Alcohols	Stable at low concentration. Unstable at high concentration and elevated temperature.
Alkalis	Stable at low concentration. Unstable at high concentration and elevated temperature.
Detergents and Cleaner	Stable except strong alkaline materials.
Aromatic Hydrocarbons	Solvents should not be used.
Ketons, Toluene, Xylene	Cause severe damage.
Silicon oil	Stable.

⚠ Make sure the plastic shell does not come into contact with any oils containing paraffin chlorurate or active nitrogen. These substances may change the mechanical qualities of the product.

Chapter 42 Technical support

Contents	Page
International Customer Care	42-2
International Product Returns	42-2

This chapter consists of a total of 4 pages.

**International
Customer
Care**

The International Customer Care service can be contacted by:

Telephone: ++39-031757400

Fax: ++39-031751777

E-Mail: customer.care@esahmi.com

Web site: <http://www.esahmi.com>

**International
Product
Returns**

Should it be necessary to return the VT terminal for repair:

- Contact our International Customer Care service to authorize the return.
- Fill in all parts of the form to accompany the product.

Our International Customer Care service will supply all the necessary information for returning a an item.

!!! IMPORTANT NOTE !!!**ESA elettronica S.p.A. will accept:**

- goods carriage free / freight prepaid (transport at customer's cost).
- goods carriage forward / freight collect (transport paid by ESA) **only with the prior authorization of the company.**

ESA elettronica S.p.A. will reject:

- any returned goods carriage forward where there has been no prior authorization.

It is not necessary to send connectors, cables and accessories (unless they are thought to be linked to the problem indicated).

Thank you for your kind co-operation.



REPAIRS RETURN FORM

NOTE: Please complete form in BLOCK CAPITALS.

Product: **S/N:** - -

Customer details (must be filled in)

Compiled by:

Company :

Full address : Post Code:

Town : County:

Tel. no. : Fax:

Contact person (where different from above)

Name :

Tel. no. : Fax:

Information regarding problem (must be filled in)

Device connected:

Detailed description of the problem and the circumstances under which it occurs:

.....
.....
.....
.....
.....
.....
.....
.....
.....
.....

Notes:

.....
.....
.....
.....
.....

Customer Care worker contacted:

Date of compilation:/...../..... Signature:

