



# SA1U Heavy-duty Photoelectric Sensor

## Features

- Four sensing methods:
  - Through-beam
  - Polarized retro-reflective
  - Diffuse
  - Background suppression
- Up to 50m sensing range
- Universal voltage type: 24 to 240V AC / 12 to 240V DC
- DC voltage type: 12 - 24V DC
- IP67
- Adjustable time delay: 0.1 to 5 seconds
- Operation and stable LED indicators
- NO/NC relay output, 3A
- Interference prevention allows two units to be mounted in close proximity (polarized retro-reflective, diffuse and background suppression)
- Spring-up terminal block structure enables easy wiring

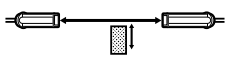
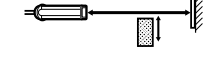
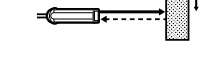
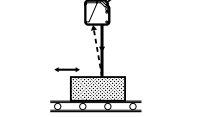

## Part Numbers

Sensing Method	Detectable Object	Sensing Range	Power Voltage	Control Output	Included Accessories	Time Delay Functions	Part Numbers
Through-beam 	Opaque	50m max.	24 to 240V AC (50/60Hz) 12 to 240V DC	Relay contact SPDT 250V AC/3A, 30V DC/3A (resistive load)	Sensitivity control screwdriver Mounting bracket Gland, gland washer Gland gaskets*	Without	SA1U-T50M
			12 to 24V DC	NPN/PNP open collector		With	SA1U-T50MT
Polarized Retro-reflective 	Opaque Mirror surface	7m max.	24 to 240V AC (50/60Hz) 12 to 240V DC	Relay contact SPDT 250V AC/3A, 30V DC/3A (resistive load)	Sensitivity control screwdriver Reflector (IAC-R5) Mounting bracket Gland, gland washer Gland gaskets*	Without	SA1U-P07M
			12 to 24V DC	NPN/PNP open collector		With	SA1U-P07MT
Diffuse 	Opaque Transparent	1m max.	24 to 240V AC (50/60Hz) 12 to 240V DC	Relay contact SPDT 250V AC/3A, 30V DC/3A (resistive load)	Sensitivity control screwdriver Mounting bracket Gland, gland washer Gland gaskets*	Without	SA1U-D01M
			12 to 24V DC	NPN/PNP open collector		With	SA1U-D01MT
Background Suppression 	Opaque	2m max.	24 to 240V AC (50/60Hz) 12 to 240V DC	Relay contact SPDT 250V AC/3A, 30V DC/3A (resistive load)	Sensitivity control screwdriver Mounting bracket Gland, gland washer Gland gaskets*	Without	SA1U-B02M
			12 to 24V DC	NPN/PNP open collector		With	SA1U-B02MT

\*Two different-size gland gaskets are supplied. Select according to the cable diameter.

Small hole gasket: cable diameter ø8 to ø9 mm

Large hole gasket: cable diameter ø9 to ø10 mm

## Specifications

### Universal Voltage

Sensing Method	Through-beam	Polarized Retro-reflective	Diffuse	Background Suppression
Part Number	SA1U-T50M, SA1U-T50MT	SA1U-P07M, SA1U-P07MT	SA1U-D01M, SA1U-D01MT	SA1U-B02M, SA1U-B02MT
Power Voltage	24 to 240V AC (21.6 to 264V AC) 50/60Hz, 12 to 240V DC (10.8 to 264V DC)			
Power Consumption	Projector: 3 VA maximum Receiver: 3 VA maximum		3 VA maximum	
Control Output	Relay contact SPDT, switching capacity: 250V AC/3A (resistive load), 30V DC/3A (resistive load) Electrical life (minimum operations): 100,000 (NO contact), 50,000 (NC contact) Mechanical life (minimum operations): 50,000,000			
Minimum Applicable Load	5V DC, 10 mA minimum (reference value)			
Response Time	20 ms maximum			
Insulation Resistance	Between power and output terminals: 20 MΩ minimum (500V DC megger)			
Dielectric Strength	Between power and output terminals: 1500V AC, 1 minute, Between output terminals: 750V AC, 1 minute			
Weight (approx.)	Projector: 115g, Receiver: 130g		130g	

**DC Power Type**

Sensing Method	Through-Beam	Polarized Retro-reflective	Diffuse	Background Suppression
Part Number	SA1U-T50MW SA1U-T50MWT	SA1U-P07MW SA1U-P07MWT	SA1U-D01MW SA1U-D01MWT	SA1U-B02MW SA1U-B02MWT
Power Voltage	12 to 24V DC (10 to 30V DC) ripple rate 10% p-p maximum			
Current Draw	Projector: 20mA max Receiver: 25mA max	30mA maximum		
Control Output	Type	NPN, PNP open collector (dual output)		
	Load Current	NPN: 100 mA maximum, PNP: 100mA maximum		
	Applied Voltage	30V DC maximum		
	Voltage Drop	NPN: 2.4V maximum, PNP: 2.4V maximum		
Response Time	1 ms maximum			
Insulation Resistance	Between live and dead parts: 20MΩ minimum (500V DC megger)			
Dielectric Strength	Between live and dead parts: 1000V AC, 1 minute			
Weight (approx.)	Projector: 105g, Receiver: 110g	110g		

**General Specifications**

Sensing Method	Through-beam	Polarized Retro-reflective	Diffuse	Background Suppression
Sensing Distance	50m maximum	0.2 to 7m (when using supplied reflector IAC-R5)	1m maximum (200 × 200mm white matte paper)	0.2 to 2m (200 × 200 mm white matte paper)
Preset Distance		—		0.4 to 2m (200 × 200 mm white matte paper)
Detectable Object	Opaque	Opaque/Mirror surface	Opaque/Transparent	Opaque
Hysteresis	—	—	20% of sensing distance max.	15% of sensing distance max.
Operation Mode	Light ON or Dark ON (mode selector)			
Control Output	[Projector]Power LED: Green [Receiver] Operation LED: Yellow Stable LED: Green	Operation LED: Yellow Stable LED: Green		Operation LED: Yellow
Light Emitting Element	Infrared LED (870nm)	Red LED (660 nm)	Infrared LED (870 nm)	
Sensitivity Adjustment	1-turn control knob			8-turn control knob
Extraneous Light Immunity	Sunlight: 10,000 lux maximum, Incandescent lamp: 5,000 lux maximum			
Vibration Resistance	Damage limits: 10 to 55Hz, amplitude 1.5mm, 30 minutes in each axis			
Shock Resistance	Damage limits: 500 m/s <sup>2</sup> (50G), 3 shocks each in 6 axes 3 consecutive times			
Operating Temperature	-25 to +60°C (no freezing), storage temperature: -40 to +70°C			
Operating Humidity	35 to 85% RH (no condensation), storage humidity: 35 to 85% RH			
Connection Method	Terminal block with M3 spring-up terminals			
Applicable Cable	Outside diameter ø8 to ø10 mm (core 0.3 to 0.75mm <sup>2</sup> )			
Cable Extension	Extendable up to 100m with a cable of 0.3mm <sup>2</sup> minimum			
Housing Material	PBT (indicator cover: PC)			
Lens Material	PC/PET	PMMA	PC/PET	
Degree of Protection	IP67 (IEC/EN60529)			

**Time Delay Specifications**

Sensing Method	Through-beam	Polarized Retro-reflective	Diffuse	Background Suppression
Part Number	SA1U-T50MT	SA1U-P07MT	SA1U-D01MT	SA1U-B02MT
Time Range	0.1 to 5.0 sec (adjusted with a 1-turn control knob)			
Time Delay Function	One shot, ON delay, OFF delay, and normal (no time delay operation) modes			
Temperature Effect of Time Delay	±10% maximum of the time delay at 20°C temperature rise within the operating temperature range			
Repetitive Accuracy of Time Delay	±1.0% maximum of the time delay for repetitive inputs at 10 seconds or more			

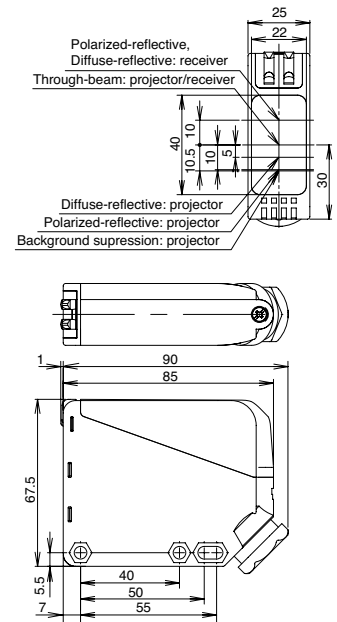
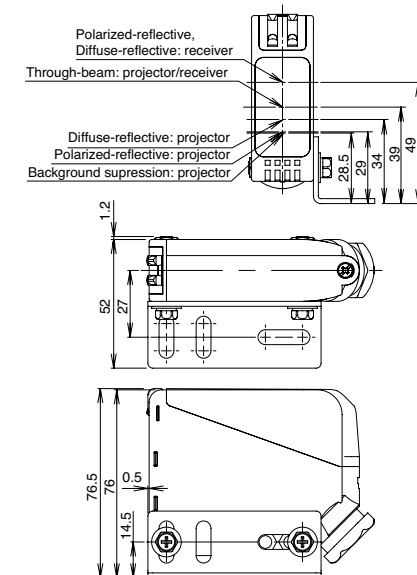
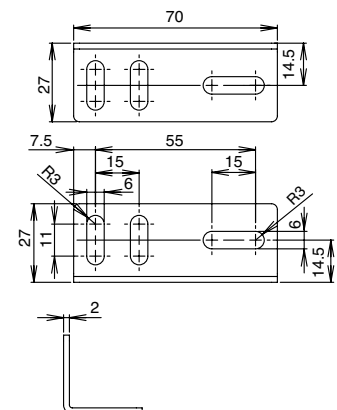
**Dimensions (mm)**
**SA1U**

**SA1U with Mounting Bracket**

**Mounting Bracket**

# Models

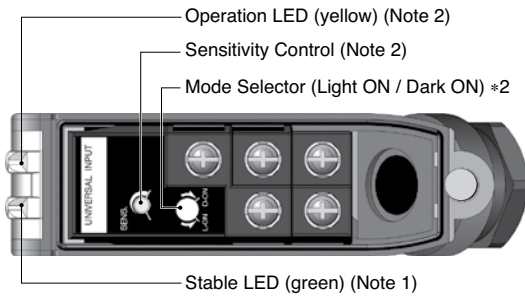
## Without Time Delay

SA1U-T50M  
SA1U-P07M  
SA1U-D01M



SA1U-B02M

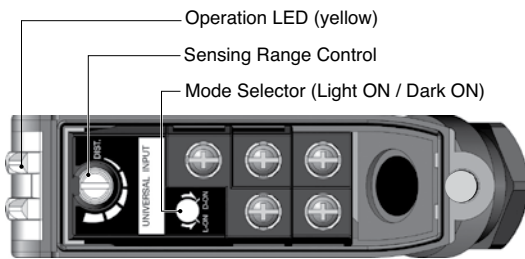

\*1: Power LED for through-beam projector  
\*2: Not available on through-beam projector

## Output Circuit / Connection Diagram

### Universal Voltage Type

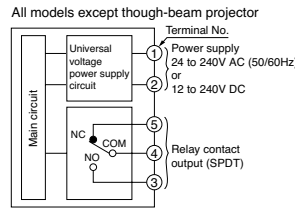

### DC Voltage Type

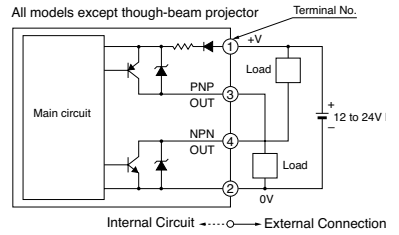

### Though-beam projector

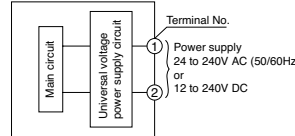

### Though-beam projector

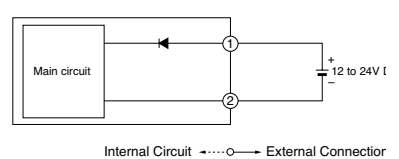

## Terminal Arrangement

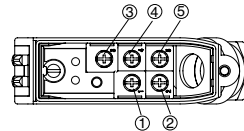

## Operation Chart

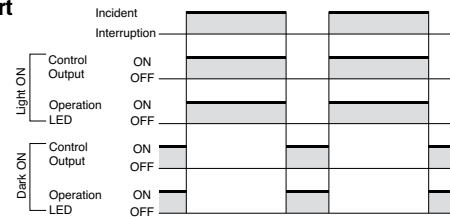

## With Time Delay

SA1U-T50MT  
SA1U-P07MT  
SA1U-D01MT

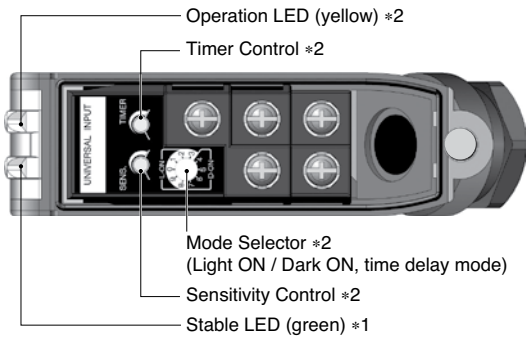

SA1U-B02MT

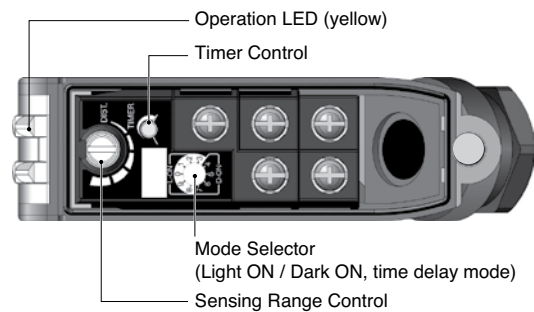

\*1: Power LED for through-beam projector  
\*2: Not available on through-beam projector

## Output Circuit / Connection Diagram

See the "Output Circuit / Connection Diagram" diagram above.

## Terminal Arrangement

See the "Terminal Arrangement" diagram above.

## Operation Chart

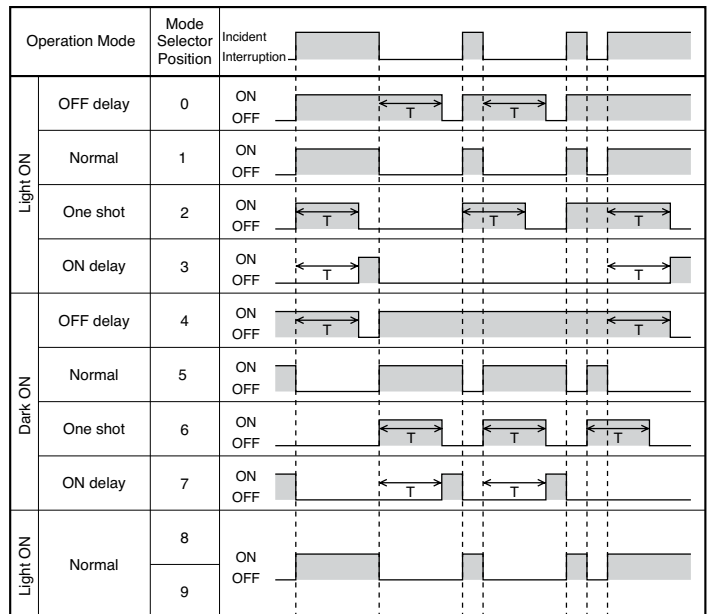

## Characteristics (Typical)

### Through-beam SA1U-T50M

Excess Gain  
(transparency 1% ND filter is used)

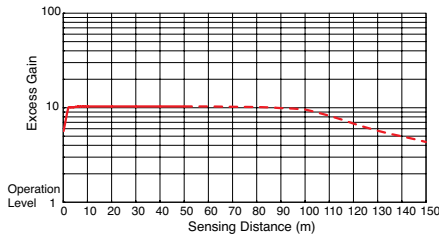

Lateral Displacement  
(transparency 2.8% ND filter is used)

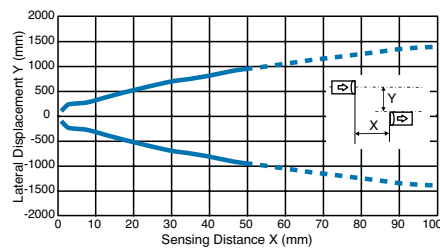

Angle

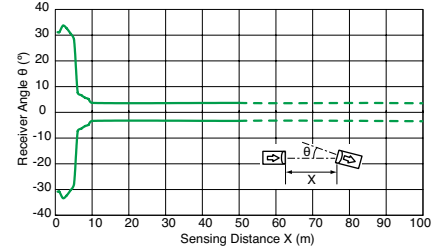

### Polarized Retro-reflective SA1U-P07M

Excess Gain

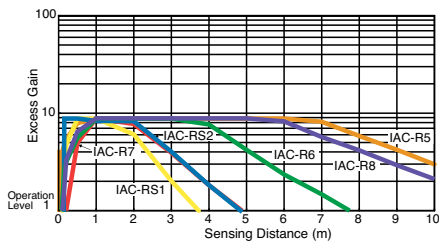

Lateral Displacement

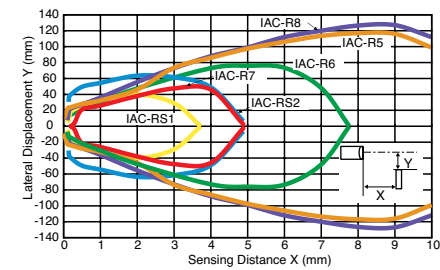

Angle

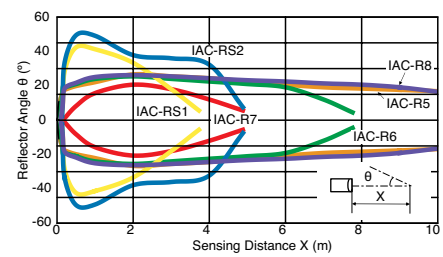

### Diffuse SA1U-D01M

Excess Gain

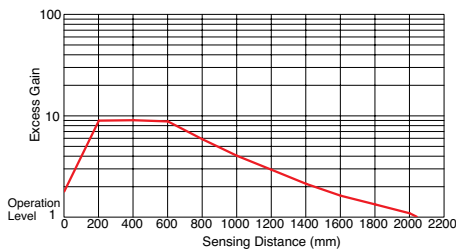

Lateral Displacement

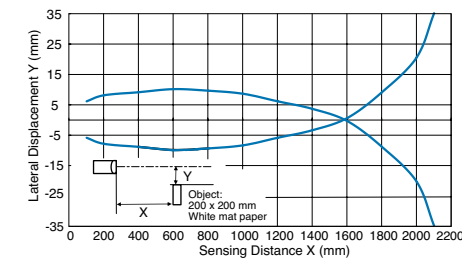

Object Size vs. Sensing Distance

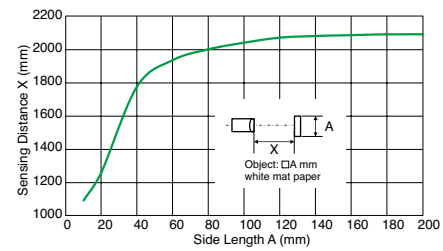

### Background Suppression SA1U-B02M

Lateral Displacement (preset 1m)

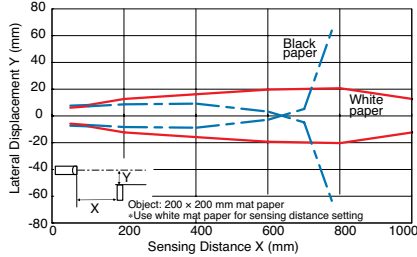

Lateral Displacement (preset 2m)

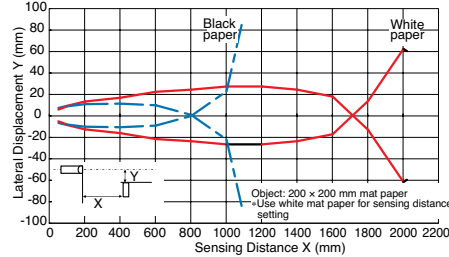

Light Beam Diameter

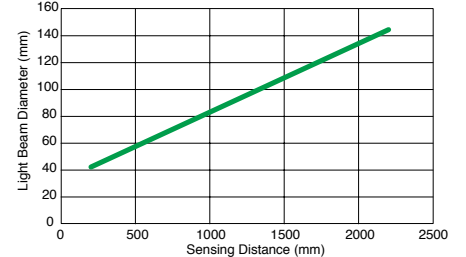

Sensing Distance vs. Hysteresis

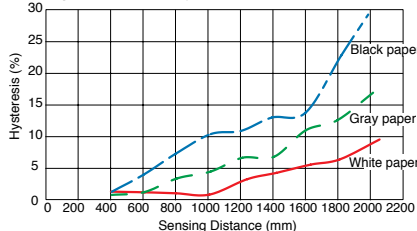

Control Knob vs. Sensing Distance

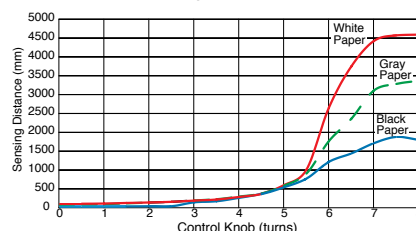

Colored Matte Paper and Other Materials

