

## Photomicrosensor (Transmissive) EE-SX1161-W11

**⚠ Be sure to read Precautions on page 24.**

### ■ Dimensions

**Note:** All units are in millimeters unless otherwise indicated.

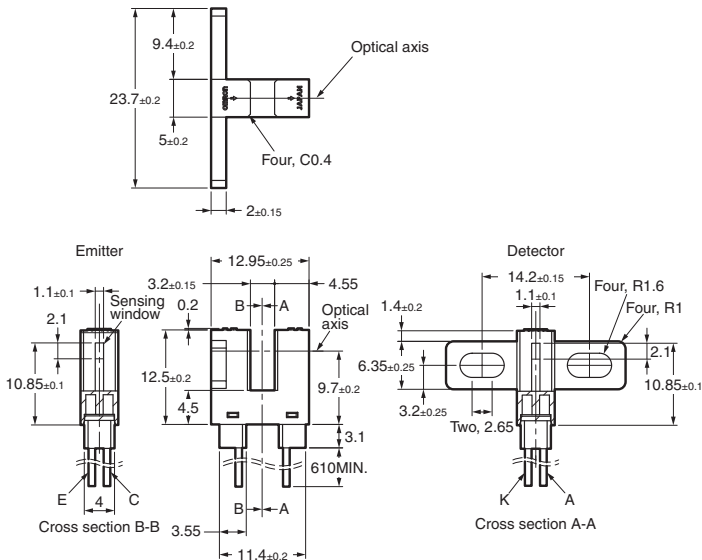

### Internal Circuit

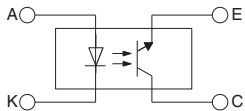

Unless otherwise specified, the tolerances are as shown below.

Terminal No.	Color	Name
A	Red	Anode
K	Black	Cathode
C	White	Collector
E	Green	Emitter

Dimensions	Tolerance
3 mm max.	±0.3
3 < mm ≤ 6	±0.375
6 < mm ≤ 10	±0.45
10 < mm ≤ 18	±0.55
18 < mm ≤ 30	±0.65

### ■ Electrical and Optical Characteristics (Ta = 25°C)

Item	Symbol	Value	Condition
Emitter	Forward voltage	$V_F$	1.2 V typ., 1.5 V max.
	Reverse current	$I_R$	0.01 $\mu$ A typ., 10 $\mu$ A max.
	Peak emission wavelength	$\lambda_P$	940 nm typ.
Detector	Light current	$I_L$	0.625 mA min.
	Dark current	$I_D$	2 nA typ., 200 nA max.
	Leakage current	$I_{LEAK}$	---
	Collector-Emitter saturated voltage	$V_{CE(sat)}$	0.15 V typ., 0.4 V max.
	Peak spectral sensitivity wavelength	$\lambda_P$	850 nm typ.
Rising time	$t_r$	4 $\mu$ s typ.	$V_{CC} = 5$ V, $R_L = 100 \Omega$ , $I_L = 5$ mA
Falling time	$t_f$	4 $\mu$ s typ.	$V_{CC} = 5$ V, $R_L = 100 \Omega$ , $I_L = 5$ mA

### ■ Features

- Dust-proof model.
- Pre-wired Sensors (AWG28).
- Solder-less lead wire connection to increase reliability.

### ■ Absolute Maximum Ratings (Ta = 25°C)

Item	Symbol	Rated value
Emitter	Forward current	$I_F$
	Pulse forward current	$I_{FP}$
	Reverse voltage	$V_R$
Detector	Collector-Emitter voltage	$V_{CEO}$
	Emitter-Collector voltage	$V_{ECO}$
	Collector current	$I_C$
	Collector dissipation	$P_C$
Ambient temperature	Operating	$T_{opr}$
	Storage	$T_{stg}$

- Note:**
1. Refer to the temperature rating chart if the ambient temperature exceeds 25°C.
  2. The pulse width is 10  $\mu$ s maximum with a frequency of 100 Hz.
  3. If you mount the Sensor with screws, use M3 screws, and flat washers and use a tightening torque of 0.5 N·m max.

Engineering Data

Forward Current vs. Collector Dissipation Temperature Rating

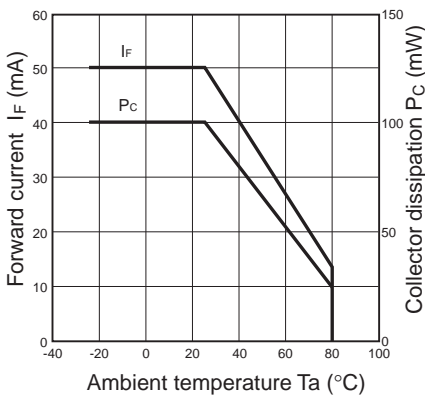

Forward Current vs. Forward Voltage Characteristics (Typical)

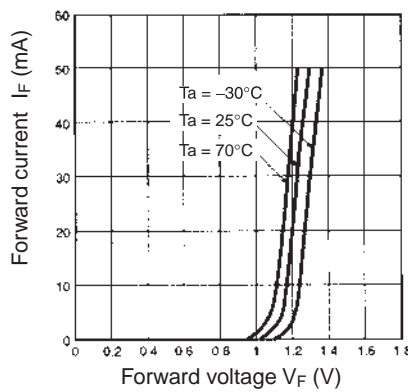

Light Current vs. Forward Current Characteristics (Typical)

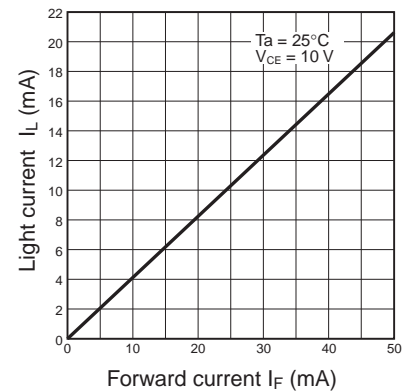

Light Current vs. Collector-Emitter Voltage Characteristics (Typical)

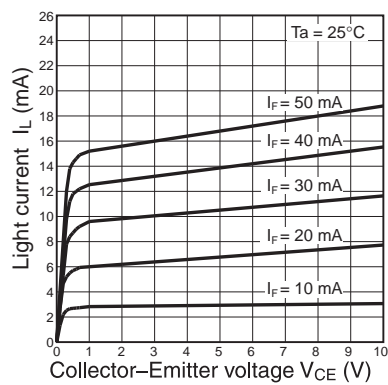

Relative Light Current vs. Ambient Temperature Characteristics (Typical)

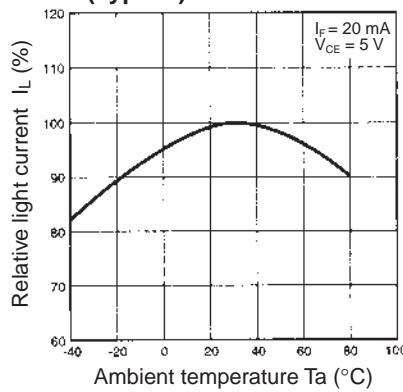

Dark Current vs. Ambient Temperature Characteristics (Typical)

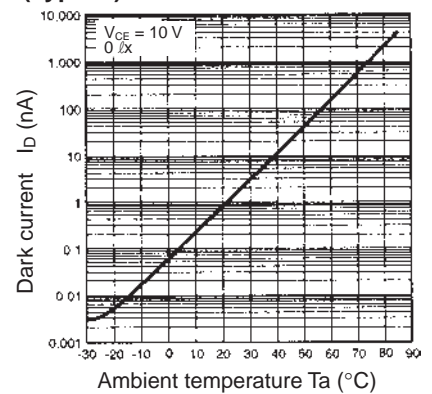

Response Time vs. Load Resistance Characteristics (Typical)

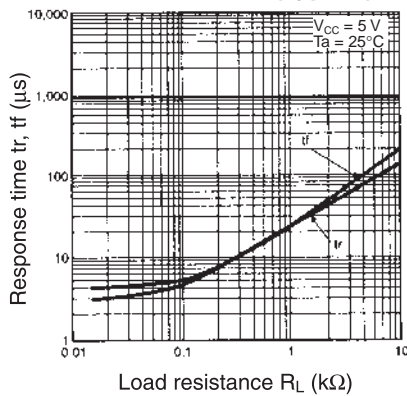

Sensing Position Characteristics (Typical)

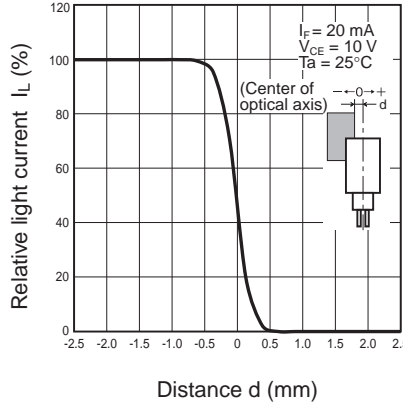

Sensing Position Characteristics (Typical)

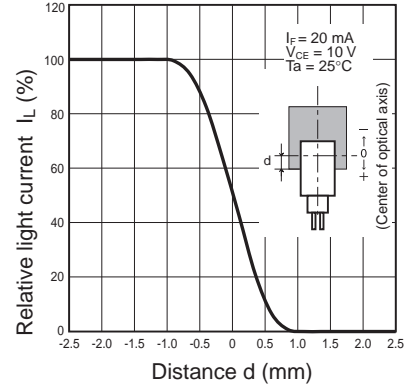

Response Time Measurement Circuit

