

# Monitoring Relays

## 1-Phase True RMS AC/DC Over or Under Voltage

### Types DUB01, PUB01



DUB01



PUB01

- TRMS AC/DC over or under voltage monitoring relays
- Selection of measuring range by DIP-switches
- Measuring ranges from 0.1 to 500 V AC/DC
- Adjustable voltage on relative scale
- Adjustable hysteresis on relative scale
- Adjustable delay function (0.1 to 30 s)
- Programmable latching or inhibit at set level
- Output: 8 A SPDT relay N.D. or N.E. selectable
- For mounting on DIN-rail in accordance with DIN/EN 50 022 (DUB01) or plug-in module (PUB01)
- 22.5 mm Euronorm housing (DUB01) or 36 mm plug-in module (PUB01)
- LED indication for relay, alarm and power supply ON

### Product Description

DUB01 and PUB01 are precise TRMS AC/DC over or under voltage (selectable by DIP-switch) monitoring relays. Owing to the built-in latch function, the ON-position of the relay output can be

maintained. Inhibit function can be used to avoid relay operation when not desired (maintenance, transitions). The LED's indicate the state of the alarm and the output relay.

### Ordering Key

**DUB 01 C B23 10V**

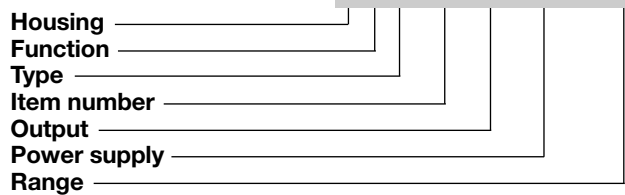

### Type Selection

Mounting	Output	Measuring range	Supply: 24 to 48 VAC/DC	Supply: 115/230 VAC
DIN-rail	SPDT	0.1 to 10 V AC/DC 2 to 500 V AC/DC	DUB 01 C D48 10V DUB 01 C D48 500V	DUB 01 C B23 10V DUB 01 C B23 500V
Plug-in	SPDT	0.1 to 10 V AC/DC 2 to 500 V AC/DC	PUB 01 C D48 10V PUB 01 C D48 500V	PUB 01 C B23 10V PUB 01 C B23 500V

### Input Specifications

Input (voltage level)	Terminals	Contact input	Terminals
DUB01	Terminals Y1, Y2	DUB01	Terminals Z1, Y1
PUB01	Terminals 5, 7	PUB01	Terminals 8, 9
<b>Measuring ranges</b>	<b>Int. resist.</b>	Disabled	> 10 kΩ
Direct	<b>Max. volt.</b>	Enabled	< 500 Ω
Selectable by DIP-switches		Latch disable	> 500 ms
<b>..10V:</b>			
0.1 to 1 V AC/DC	>200 kΩ		
0.2 to 2 V AC/DC	>200 kΩ		
0.5 to 5 V AC/DC	>200 kΩ		
1 to 10 V AC/DC	>200 kΩ		
Max. voltage for 1 s			
200 V			
<b>..500V:</b>			
2 to 20 V AC/DC	>500 kΩ		
5 to 50 V AC/DC	>500 kΩ		
20 to 200 V AC/DC	>500 kΩ		
50 to 500 V AC/DC	>500 kΩ		
Max. voltage for 1 s			
1000 V			
<b>Note:</b>			
The input voltage cannot raise over 300 VAC/DC with respect to ground (PUB01 only)			



## Output Specifications

<b>Output</b> Rated insulation voltage	SPDT relay 250 VAC
<b>Contact ratings</b> (AgSnO <sub>2</sub> ) Resistive loads AC 1 DC 12 Small inductive loads AC 15 DC 13	μ 8 A @ 250 VAC 5 A @ 24 VDC 2.5 A @ 250 VAC 2.5 A @ 24 VDC
<b>Mechanical life</b>	≥ 30 x 10 <sup>6</sup> operations
<b>Electrical life</b>	≥ 10 <sup>5</sup> operations (at 8 A, 250 V, cos φ = 1)
<b>Operating frequency</b>	≤ 7200 operations/h
<b>Dielectric strength</b> Dielectric voltage Rated impulse withstand volt.	≥ 2 kVAC (rms) 4 kV (1.2/50 μs)

## Supply Specifications

<b>Power supply</b> Rated operational voltage through terminals: A1, A2 or A3, A2 (DUB01) 2, 10 or 11, 10 (PUB01)  D48:  B23:	Overvoltage cat. III (IEC 60664, IEC 60038)  24 to 48 VAC/DC ± 15% 45 to 65 Hz, insulated 115/230 VAC ± 15% 45 to 65 Hz, insulated
<b>Dielectric voltage</b> Supply to input Supply to output Input to output	<b>DC supply</b> <b>AC supply</b> 2 kV            4 kV 4 kV            4 kV 4 kV            4 kV
<b>Rated operational power</b> AC DC	4 VA 3 W

## General Specifications

<b>Power ON delay</b>	1 s ± 0.5 s or 6 s ± 0.5 s
<b>Reaction time</b>  Alarm ON delay Alarm OFF delay	(input signal variation from -20% to +20% or from +20% to -20% of set value) < 100 ms < 100 ms
<b>Accuracy</b> Temperature drift Delay ON alarm Repeatability	(15 min warm-up time) ± 1000 ppm/°C ± 10% on set value ± 50 ms ± 0.5% on full-scale
<b>Indication for</b> Power supply ON Alarm ON  Output relay ON	LED, green LED, red (flashing 2 Hz during delay time) LED, yellow
<b>Environment</b> Degree of protection Pollution degree Operating temperature Storage temperature	IP 20 3 (DUB01), 2 (PUB01) -20 to 60°C, R.H. < 95% -30 to 80°C, R.H. < 95%
<b>Housing</b> Dimensions            DUB01 PUB01  Material	22.5 x 80 x 99.5 mm 36 x 80 x 94 mm PA66 or Noryl
<b>Weight</b>	Approx. 150 g
<b>Screw terminals</b> Tightening torque	Max. 0.5 Nm acc. to IEC 60947
<b>Product standard</b>	EN 60255-6
<b>Approvals</b>	UL, CSA
<b>CE Marking</b>  EMC Immunity  Emissions	L.V. Directive 2006/95/EC EMC Directive 2004/108/EC  According to EN 60255-26 According to EN 61000-6-2 According to EN 60255-26 According to EN 61000-6-3

## Mode of Operation

DUB01 and PUB01 monitor both AC and DC over or under voltage.

### Example 1

(no connection between terminals Z1, Y1 or 8, 9 - latch function disabled)

The relay operates when the measured value exceeds (or drops below) the set level for more than the set delay time.

It releases when the voltage

drops below (or exceeds) the set level (see hysteresis setting), or when power supply is interrupted.

### Example 2

(connection between terminals Z1, Y1 or 8, 9 - latch function enabled)

The relay operates and latches in operating position when the measured value exceeds (or drops below) the set level for more than

the set delay time.

Provided that the voltage has dropped below (or has exceeded) the set point (see hysteresis setting) the relay releases when the interconnection between terminals Z1, Y1 or 8, 9 is interrupted, or power supply is interrupted as well.

The red LED flashes until the delay time has expired or the measured value has dropped below the set point (see hysteresis setting).

### Note

When the inhibit contact is opened, if the input signal is already in alarm position, the delay time needs to elapse before relay activation.

## Function/Range/Level and Time Delay Setting

Adjust the input range setting the DIP switches 1 and 2 as shown below.

Select the desired function setting the DIP switches 3 to 6 as shown below.

To access the DIP switches open the grey plastic cover as shown below.

**Selection of level and time delay:**

**Upper knob:** Setting of hysteresis on relative scale: 0 to 30% on set value.

**Centre knob:** Voltage level setting on relative scale: 10 to 110% on full scale.

**Lower knob:** Setting of delay on alarm time on absolute scale (0.1 to 30 s).

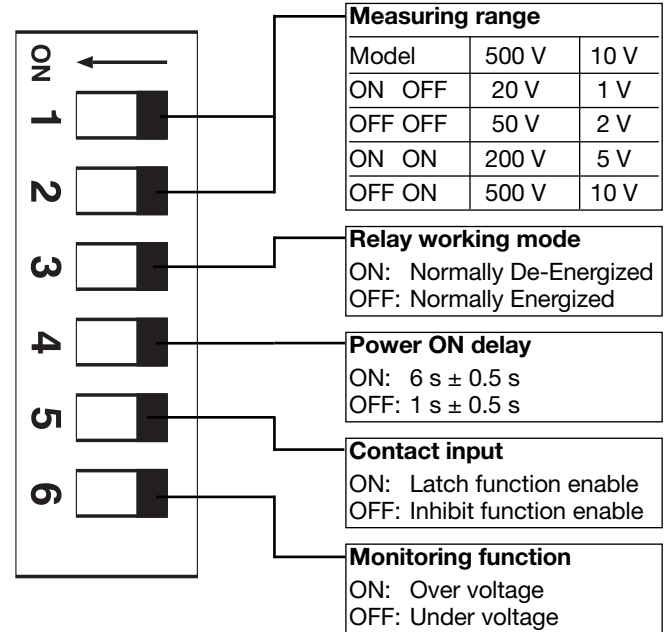
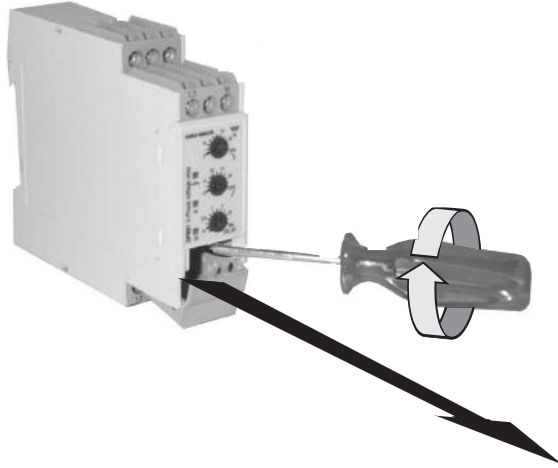

## Operation Diagrams

### Over voltage - N.D. relay

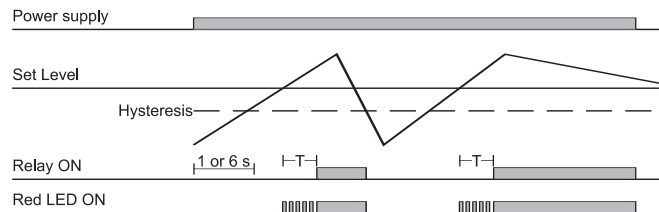

### Under voltage - Latch function - N.D. relay

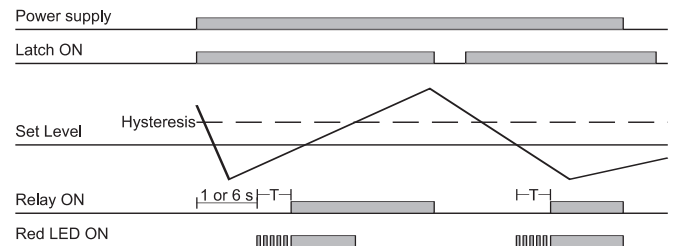

### Under voltage - N.D. relay

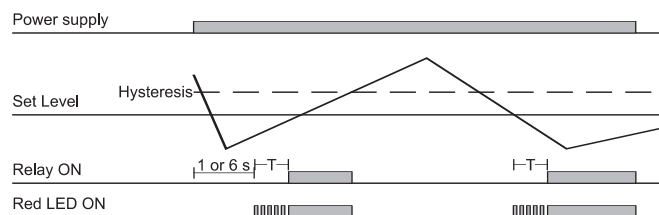

### Over voltage - Inhibit function - N.D. relay

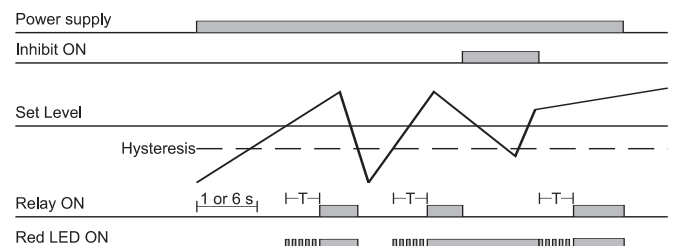

## Wiring Diagrams

Example 1

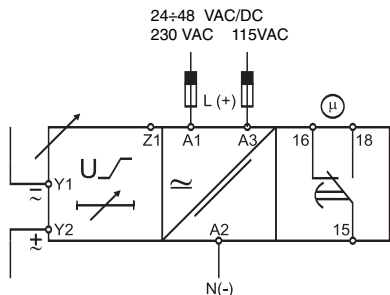

Example 2

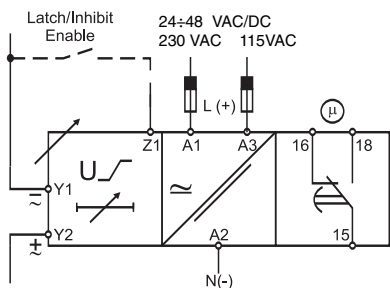

DUB01

Example 2

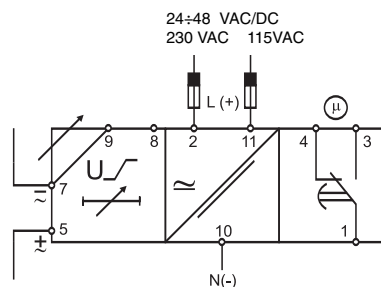

PUB01

## Dimensions

DIN-rail

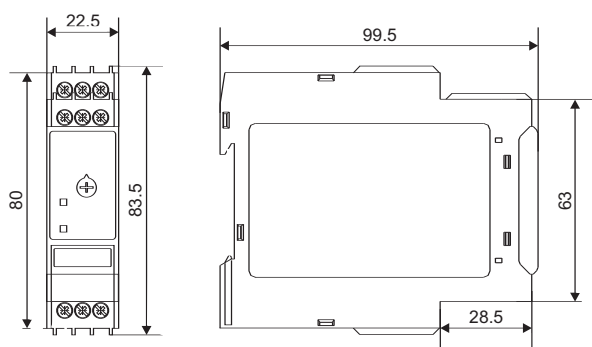

Plug-in

