

tyco / *Electronics*

The Technology Company



AMP

Hollow Shaft Resolver

Tyco Electronics

Growing to meet your electronic component and system needs

Tyco Electronics, the largest division of Tyco International Ltd., was established in September 1999 when Tyco merged with Elcon Products, Raychem and AMP, all acquired earlier the same year. Combined with further acquisitions such as the Electromechanical Components division of Siemens, the Electronic OEM division of Thomas & Betts, Critchley and others, Tyco Electronics is now the world's largest passive component supplier, with product ranges in 21 passive and active product segments.

Recently, our capabilities expanded considerably with the acquisition of the Power Systems division of Lucent Technologies. This allows Tyco Electronics to offer you high-quality AC-DC and DC-DC power solutions for a broad range of applications, from small power modules for laptop computers to very large stand-alone systems capable of handling up to 10,000 amperes.

Today, in addition to power systems, our product portfolio encompasses connector systems and application tooling, active and passive fiberoptic devices, wireless components (including ICs, radar sensors and complete communications systems), heat shrink products, PolySwitch circuit protection devices, magnetic components, wire and cable systems, touchscreens, PC boards and backplanes, relays, sensors, electronic modules, battery packs, terminal blocks and switches. Our goal is to be the market leader in each of these segments.

A significant result of our continued growth and a real benefit to our customers is that Tyco Electronics' technology leadership has become even stronger. Our expertise and synergies in materials science, product design and process engineering, coupled with our network of well-trained application engineers and sales representatives, allows us not only to provide superior customer service, but also to better assist you in making your next generation of products successful.

Call us – we're ready to help.



Tyco Electronics AMP @online

Internet Homepage: <http://www.tycoelectronics.com>
<http://www.amp.com>

Electronic Catalog in the Internet: <http://connect.amp.com>

To be close to our customers worldwide is an essential part of our success. The Tyco Electronics AMP Website is more than merely an Internet-guide. It is an innovative and interactive source for application tips, product update and technical information. This Website is available in eight languages. With our StepSearch-Software you can easily surf through all of our product lines.

Product Information Center (PIC)

You can rely on our PIC Team's support.

Our experienced staff is an additional information source, and the team has been particularly trained to answer your technical questions.

To reach our PIC, please contact your local Tyco Electronics AMP company.



Product and Machine Literature

Product and machine literature quick and easy by fax.

A wide range of products also requires an extensive literature stock. We can provide you with brochures, catalogs and flyers for every product program of your interest.

Our catalog service team supports you in selecting and ordering the appropriate catalog. To get product and application tooling catalogs quickly and easily, please contact your local Tyco Electronics company.

Content

	Page
General Description	2
General Terms	3
Overview of Standard Types	4
Hollow Shaft Resolver Size 15	5
Technical Data	5
Dimensioned drawing	6
V23401-D1001-B1..	7
V23401-D1008-B1.. 3-speed	10
V23401-D1009-B1.. with low output impedance	13
V23401-S1001-B1..	16
Hollow Shaft Resolver Size 21	19
Technical Data	19
Dimensioned drawing	20
V23401-T1002-B1.. / V23401-H1002-B1.. 3-speed	22
V23401-T1005-B1.. / V23401-H1005-B1..	25
V23401-T1009-B1.. / V23401-H1009-B1.. with low output impedance	28
V23401-T2001-B2.. / V23401-H2001-B2..	31
V23401-T2009-B2.. / V23401-H2009-B2.. with low output impedance	34
V23401-T2010-B2.. / V23401-H2010-B2.. 3-speed	37
V23401-T2014-B2.. / V23401-H2014-B2.. 4-speed	40
V23401-T2015-B2.. / V23401-H2015-B2.. 2-speed	43
V23401-U1016-B1..	46
V23401-U2017-B2..	49
V23401-U2020-B2.. 3-speed	52

Hollow Shaft Resolver

General Description

The use of sensors for determining angles increases with progressive automation. The hollow shaft resolver has long won its own steady position on the market and can nowadays be found in many modern, high-precision control systems.

Due to its design, the hollow shaft resolver boasts of a service life above average. Reliability as well as high precision and low space requirements supplement its favorable characteristics. It remains fully operable even under extreme environmental conditions.

Essentially, the resolver mechanically consists of a stationary stator and a movable rotor. Electrically it consists of a transformer for supplying the rotor with power and a second transformer for determining angles.

The first transformer has a concentric design and is functionally independent of angle values. The second, angle-dependent transformer is made of a stator winding and a rotor winding. The windings of these two transformer components are designed such that the number of windings in the grooves correspond to the values of a sinoid.

Negative values are realized by reversing the direction of the winding. The stator coils consist of two similar windings that are fitted in a relative position to each other rotated by 90° .

If the rotor winding is energized, a sinusoidal magnetic flux is created that induces voltages in the stator coils as a function of the relative angular position of the rotor and stator. The amplitudes of the two voltages correspond to the sine or cosine. Thus, using a suitable evaluation circuit, it is possible to obtain the absolute angle data.

The term used for the basic version is a resolver with one pair of poles (1-speed-resolver).

The number of pairs of poles indicates how often the sine distribution of the rotor and stator windings is repeated during one revolution. The higher the number of pairs of poles, the higher the mechanical precision of the resolver. The location deviation of the radial offset increases. With multiple pairs of poles, the absolute angle data are lost, but a higher resolution is possible after digital conversion of the resolver-signals.

Operational diagram

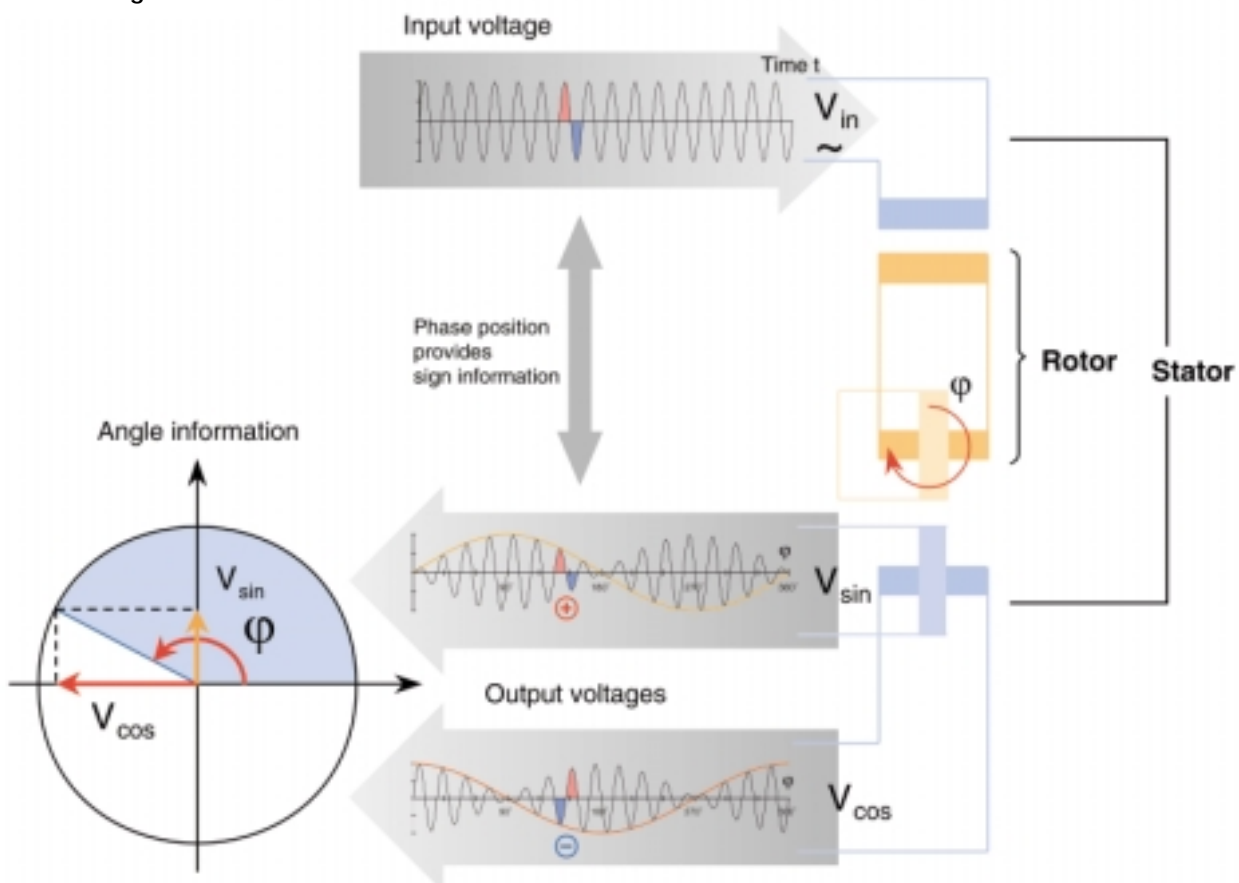

ECLO380-J

Hollow Shaft Resolver



General Terms

Pairs of poles p (speed)

The number of electrical sine and cosine cycles per mechanical revolution.

Residual voltage V_{residual}

The residual voltage is the actual value of the voltage remaining when V_{S1-S3} or V_{S2-S4} takes on the nominal value of zero.

$$V_{\text{residual}} < 0.7 \% \text{ of } r_T \cdot V_{R1-R2}$$

Angle error spread $\Delta\phi$

The angle error spread is the deviation (unit: arcmin = ') of the angle represented by the electrical signals from the corresponding actual mechanical angle.

$$\Delta\phi = \phi_{\text{el}} - \phi_{\text{mech}} \cdot p \quad \text{with } p = \text{pairs of poles}$$

Applicable definition: the angle error spread lies within $\pm n$ arc minutes in any angular position of the specified band.

DC resistance values

The ohmic resistance values are based on an ambient temperature of 22 °C and change with temperature by 0.39 % / K.

Phase shift ψ

The phase shift ψ is the lag between the input signal and output signal.

Transformation ratio r_T

The transformation ratio r_T is the ratio between the input voltage and the maximum output voltage.

$$\begin{aligned} r_T &= V_{S1-S3 \text{ max}} / V_{R1-R2} \\ &= V_{S2-S4 \text{ max}} / V_{R1-R2} \end{aligned}$$

Impedance values Z_{RO} ; Z_{RS} ; Z_{SO} ; Z_{SS}

The impedance values are the ac resistance values and depend on the frequency. Especially Z_{SO} is the value relevant for the output capability of the resolver, while Z_{RS} is decisive for the load on the energizing signal source.

Hollow Shaft Resolver

Overview of Standard Types

Size	Pairs of poles (speed)	Housing material	Angular error range	± 4'	± 6'	± 7'	± 8'	± 10'	± 15'	± 20'	Trans-formation ratio	Notes	
			Ordering number	..33	..10	..02	..09	..01	..22	..14			
15	1	CrNi-steel	V23401-D1001-B1..			X		X	X	X	0.5		
	3	CrNi-steel	V23401-D1008-B1..			X		X	X	X	0.5	3-speed	
	1	CrNi-steel	V23401-D1009-B1..			X		X	X	X	0.5	with low output impedance	
	1	CrMo-steel	V23401-S1001-B1..		X		X	X	X		0.5		
21	3	Aluminum CrNi-steel	V23401-T1002-B1.. V23401-H1002-B1..			X		X	X	X	0.5	3-speed	
	1	Aluminum CrNi-steel	V23401-T1005-B1.. V23401-H1005-B1..			X		X	X	X	0.5		
	1	Aluminum CrNi-steel	V23401-T1009-B1.. V23401-H1009-B1..			X		X	X	X	0.5	with low output impedance	
	1	Aluminum CrNi-steel	V23401-T2001-B2.. V23401-H2001-B2..			X		X	X	X	0.5		
	1	Aluminum CrNi-steel	V23401-T2009-B2.. V23401-H2009-B2..			X		X	X	X	0.5	with low output impedance	
	3	Aluminum CrNi-steel	V23401-T2010-B2.. V23401-H2010-B2..			X		X	X	X	0.46	3-speed	
	4	Aluminum CrNi-steel	V23401-T2014-B2.. V23401-H2014-B2..			X		X	X	X	0.46	4-speed	
	2	Aluminum CrNi-steel	V23401-T2015-B2.. V23401-H2015-B2..			X		X	X	X	0.5	2-speed	
	1	CrMo-steel	V23401-U1016-B1..	X	X		X	X				0.5	
	1	CrMo-steel	V23401-U2017-B2..	X		X		X				0.5	
3	CrMo-steel	V23401-U2020-B2..		X		X	X				0.46	3-speed	

Transfer function	
<p>Function</p> $V_{S1-S3} = +\Gamma_T \cdot V_{R1-R2} \cdot \cos(p \cdot \alpha)$ $V_{S2-S4} = +\Gamma_T \cdot V_{R1-R2} \cdot \sin(p \cdot \alpha)$ <p>p = pairs of poles</p> <p>This function applies to the clockwise rotation of the rotor when looking at the (grooveless) transformer component from the top.</p>	<div style="display: flex; justify-content: space-between;"> <div style="text-align: left;"> <p>Input</p> <p>V_{R1-R2}</p> <p>(red / white) (yellow / white resp. black / white)</p> </div> <div style="text-align: center;"> <p>Transformer Section</p> <p>Resolver Section</p> <p>Rotor</p> <p>Stator</p> <p>α</p> </div> <div style="text-align: right;"> <p>Output</p> <p>(yellow) V_{S2-S4}</p> <p>(blue)</p> <p>(red)</p> <p>(black) V_{S1-S3}</p> </div> </div> <p style="text-align: right; font-size: small;">ECL0379-G</p>

Electrical and thermal limits	
<p>High-voltage test</p> <p>Windings to housing</p> <p>Windings to each other</p>	<p>250 V_{AC}, 50 Hz</p> <p>250 V_{AC}, 50 Hz</p>
<p>Insulation resistance</p> <p>Windings to housing and windings to each other</p>	<p>$R_{insulation} > 50 \text{ M}\Omega$ at 500 V_{DC}</p>
<p>Operating temperature range</p>	<p>-55 °C ... +150 °C</p>

Mechanical data	
<p>Weight</p> <p>V23401-D...</p> <p>V23401-S...</p>	<p>approx. 90 g</p> <p>approx. 90 g</p>
<p>Momentum of inertia of the rotor</p>	<p>approx. 20 g · cm²</p>
<p>Maximum rational speed</p>	<p>20 000 rpm</p>
<p>Maximum angular acceleration</p>	<p>150 000 rad/s²</p>
<p>Torsional strength of rotor components</p>	<p>0.25 Nm</p>
<p>Shock resistance (11 ms sine)</p>	<p>1000 m/s²</p>
<p>Vibration fatigue limit (0 ... 2 kHz)</p>	<p>200 m/s²</p>
<p>Permissible radial runout (see Dimensioned drawing: Note 1)</p>	<p>0.075 mm</p>
<p>Permissible axial offset (see Dimensioned drawing: Note 2)</p>	<p>± 0.25 mm</p>

Size 15

Dimensioned drawing

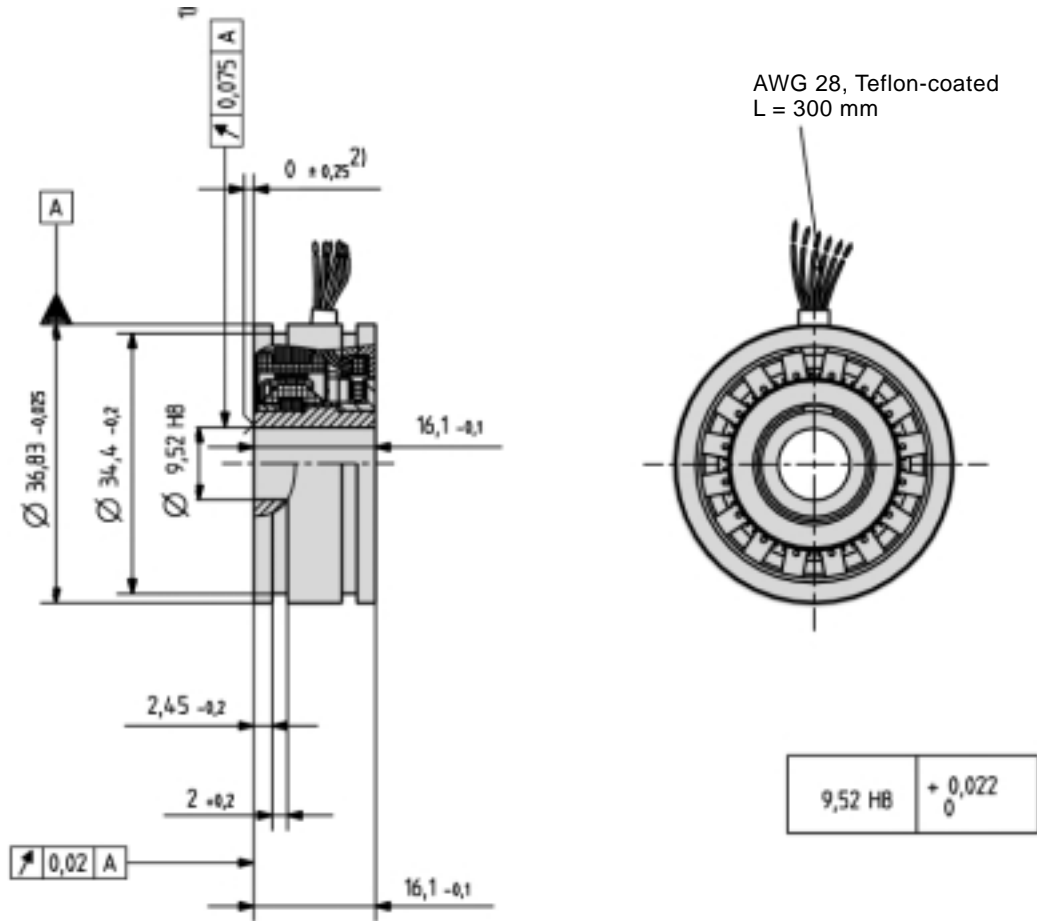

- 1) Total runout when installed
- 2) Axial offset

Housing CrNi-steel

Electrical error / Ordering information

<p>Angular error spread $\Delta\phi$ $\pm 20'$ $\pm 15'$ $\pm 10'$ $\pm 7'$</p>	<p>Ordering code V23401-D1001-B114 V23401-D1001-B122 V23401-D1001-B101 V23401-D1001-B102</p>
<p>Residual voltage V_{residual}</p>	<p>25 mV at $V_{R1-R2} = 7\text{ V}$</p>

Electrical data at 22 °C.

Transfer function

Pairs of poles p $p = 1$

Transformation ratio r_T

$$r_T = V_{S1-S3 \text{ max}} / V_{R1-R2}$$

$$= V_{S2-S4 \text{ max}} / V_{R1-R2}$$

= 0.5 \pm 10 % within 4 ... 20 kHz
 = 0.5 \pm 5 % at 5 kHz

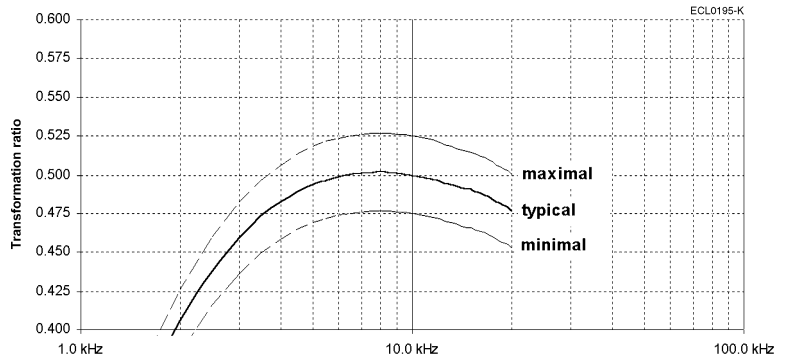

Phase shift ψ

$$V_{R1-R2}(t) = V_{R1-R2 \text{ max}} \cdot \sin(2 \cdot \pi \cdot f \cdot t)$$

$$V_{S1-S3}(t) = V_{S1-S3 \text{ max}} \cdot \sin(2 \cdot \pi \cdot f \cdot t - \psi)$$

for $-90^\circ < \alpha < +90^\circ$

Tolerance: $\pm 5^\circ$

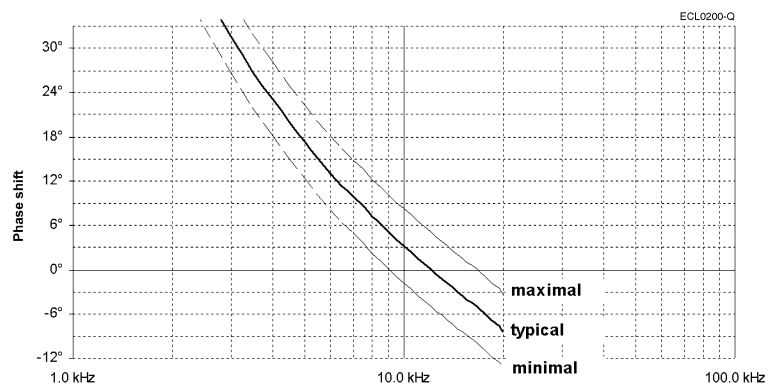

Size 15

Resistance, impedance and operating parameters

Input voltage V_{R1-R2}, typical	$2 V_{rms} \dots 10 V_{rms}$
Frequency f, typical	$4 \text{ kHz} \dots 20 \text{ kHz}$

When choosing the values of these parameters take into account power dissipation, max. ambient temperature and the heat dissipation. Including self heating a maximum operating temperature of 150 °C must not be exceeded. Generally a power dissipation of $P \leq 0.3 \text{ W}$ is not critical.

Input current I

The adjacent figure applies to $V_{R1-R2} = 7 \text{ V}$.

For other input voltages, the input current changes follows as:

$$I = I_{\text{Figure}} \cdot V_{R1-R2} / 7 \text{ V}$$

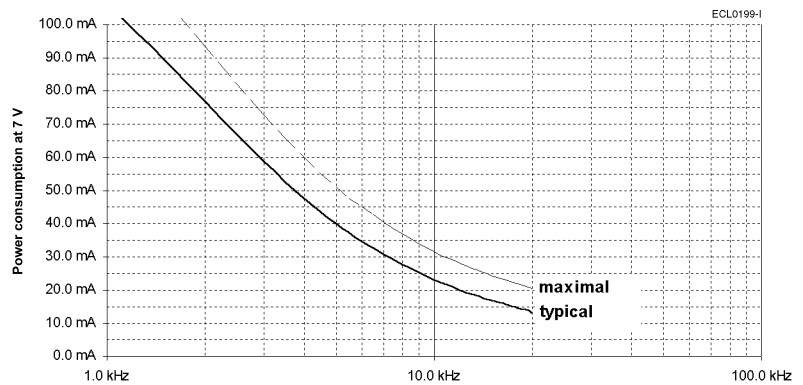

Power consumption P

The adjacent figure applies to $V_{R1-R2} = 7 \text{ V}$.

For other input voltages, the power consumption changes follows as:

$$P = P_{\text{Figure}} \cdot (V_{R1-R2} / 7 \text{ V})^2$$

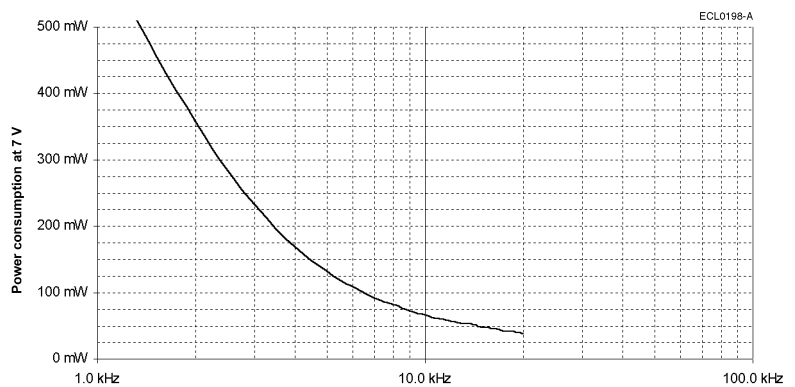

Size 15

Resistance, impedance and operating parameters (continued)

DC resistance

The ohmic resistance values are based on an ambient temperature of 22 °C and change with temperature by 0.39 % / K

$R_{R1-R2} = 46 \Omega$
 $R_{S1-S3} = R_{S2-S4} = 63 \Omega$
 Tolerance: $\pm 10 \%$

Input impedance

Tolerance: $\pm 15 \%$

Z_{RO} ... Impedance between R1 and R2 with open outputs

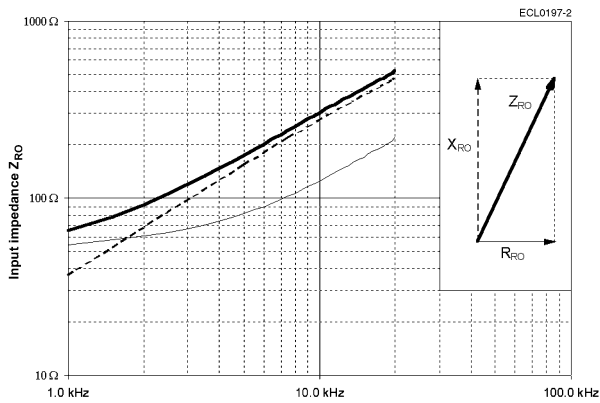

Tolerance: $\pm 15 \%$

Z_{RS} ... Impedance between R1 and R2 with short circuits between S1 and S3 as well as between S2 and S4

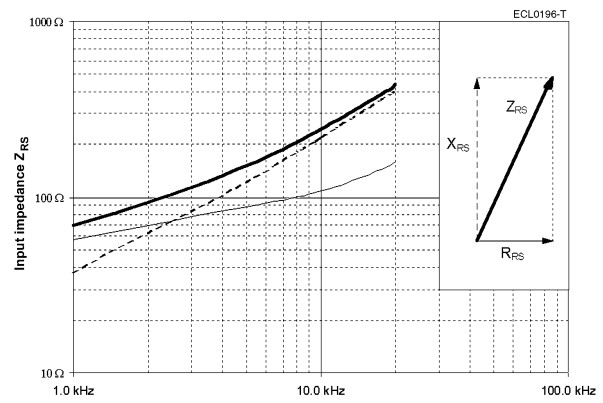

Output impedance

Tolerance: $\pm 15 \%$

Z_{SO} ... Impedance between S2 and S4 in a position of 0° (minimal coupling) with open outputs

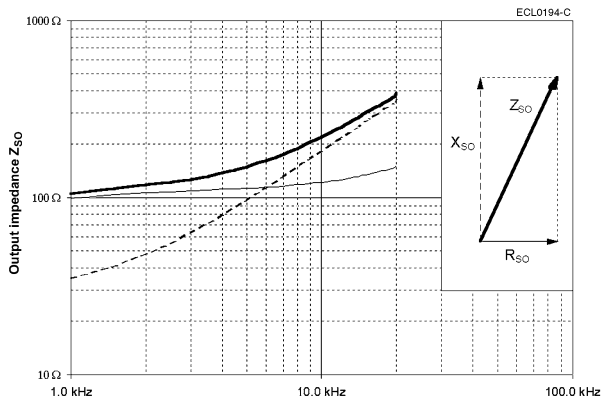

Tolerance: $\pm 15 \%$

Z_{SS} ... Impedance between S1 and S3 in a position of 0° (max. coupling) with short circuits between R1 and R2

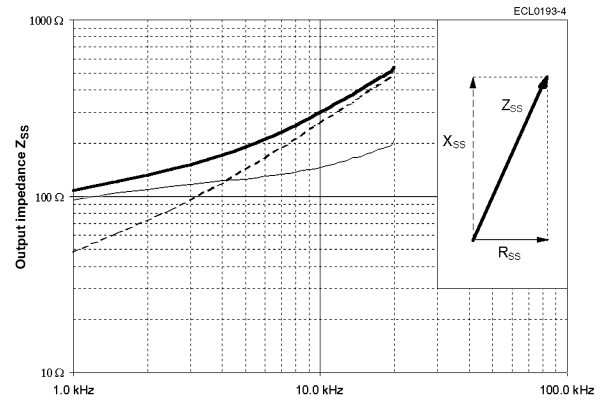

Inductance L

$L = X / (2 \cdot \pi \cdot f)$
 at $f = 10 \text{ kHz}$

$L_{RO} = 4.4 \text{ mH}$
 $L_{SS} = 4.1 \text{ mH}$

Size 15

Housing

CrNi-steel

Electrical error / Ordering information

Angular error spread $\Delta\phi$
 $\pm 20'$
 $\pm 15'$
 $\pm 10'$
 $\pm 7'$

Ordering code
 V23401-D1008-B114
 V23401-D1008-B122
 V23401-D1008-B101
 V23401-D1008-B102

Residual voltage V_{residual}

14 mV at $V_{R1-R2} = 4 V$

Electrical data at 22 °C.

Transfer function

Pairs of poles p

p = 3

Transformation ratio r_T

$$r_T = \frac{V_{S1-S3 \text{ max}}}{V_{R1-R2}}$$

$$= \frac{V_{S2-S4 \text{ max}}}{V_{R1-R2}}$$

= 0.5 ± 10 % within 5 ... 20 kHz
 = 0.5 ± 5 % at 10 kHz

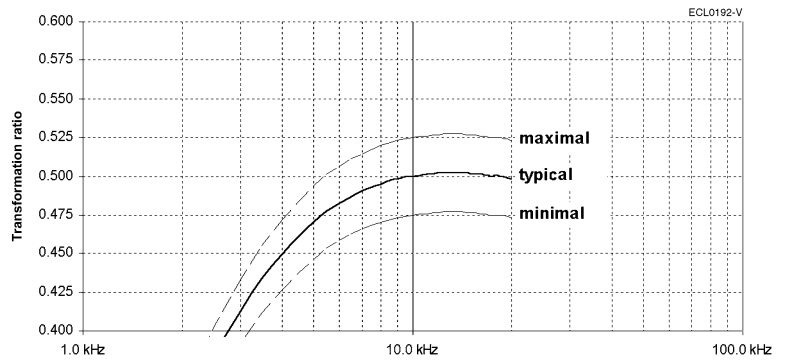

Phase shift ψ

$$V_{R1-R2}(t) = V_{R1-R2 \text{ max}} \cdot \sin(2 \cdot \pi \cdot f \cdot t)$$

$$V_{S1-S3}(t) = V_{S1-S3 \text{ max}} \cdot \sin(2 \cdot \pi \cdot f \cdot t - \psi)$$

for $-90^\circ < \alpha < +90^\circ$

Tolerance: ± 5°

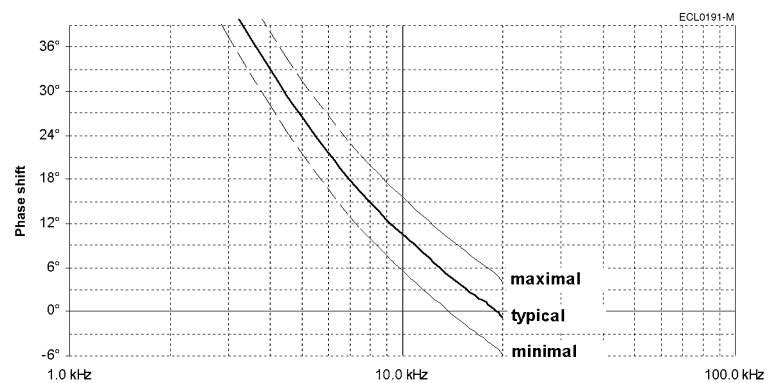

Size 15

Resistance, impedance and operating parameters

Input voltage V_{R1-R2}, typical	$2 V_{rms} \dots 8 V_{rms}$
Frequency f, typical	5 kHz ... 20 kHz

When choosing the values of these parameters take into account power dissipation, max. ambient temperature and the heat dissipation. Including self heating a maximum operating temperature of 150 °C must not be exceeded. Generally a power dissipation of $P \leq 0.3 \text{ W}$ is not critical.

Input current I

The adjacent figure applies to $V_{R1-R2} = 4 \text{ V}$.

For other input voltages, the input current changes follows as:

$$I = I_{\text{Figure}} \cdot V_{R1-R2} / 4 \text{ V}$$

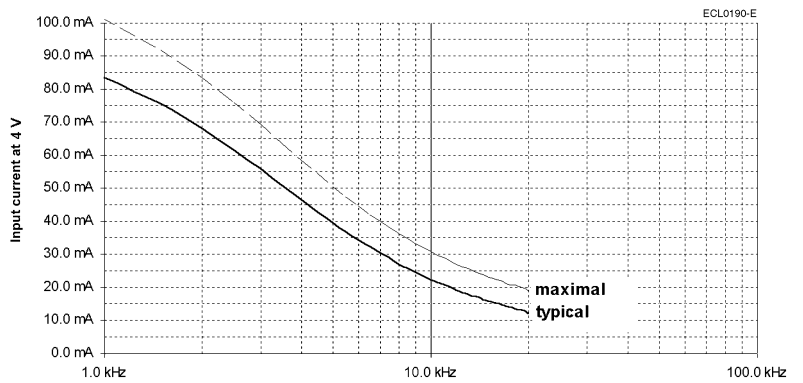

Power consumption P

The adjacent figure applies to $V_{R1-R2} = 4 \text{ V}$.

For other input voltages, the power consumption changes follows as:

$$P = P_{\text{Figure}} \cdot (V_{R1-R2} / 4 \text{ V})^2$$

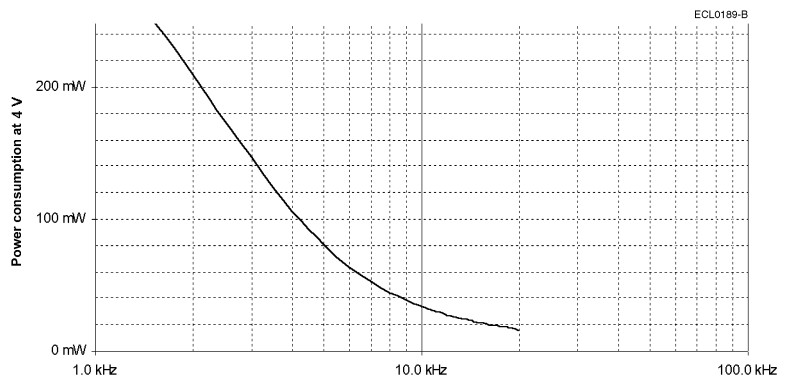

Resistance, impedance and operating parameters (continued)

DC resistance

The ohmic resistance values are based on an ambient temperature of 22 °C and change with temperature by 0.39 % / K

$R_{R1-R2} = 33 \Omega$
 $R_{S1-S3} = R_{S2-S4} = 70 \Omega$
 Tolerance: $\pm 10 \%$

Input impedance

Tolerance: $\pm 15 \%$

Z_{RO} ... Impedance between R1 and R2 with open outputs

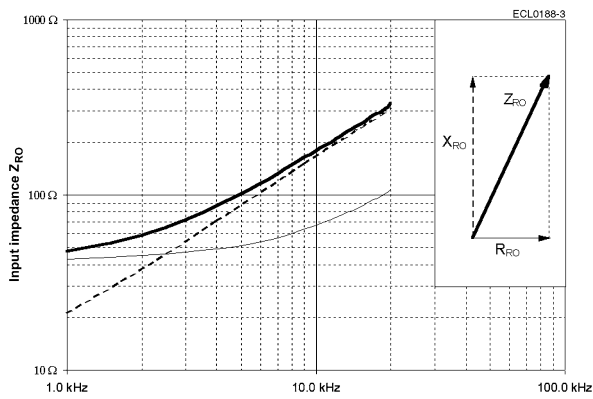

Tolerance: $\pm 15 \%$

Z_{RS} ... Impedance between R1 and R2 with short circuits between S1 and S3 as well as between S2 and S4

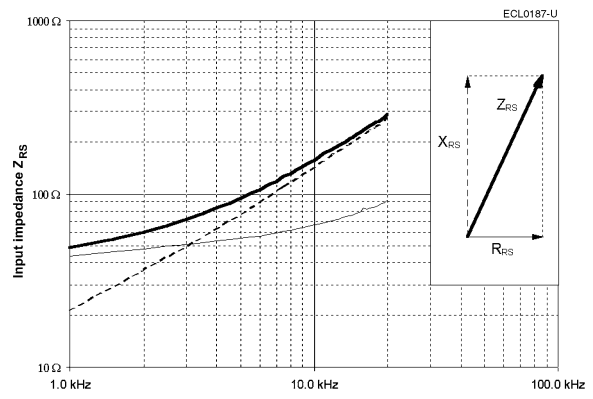

Output impedance

Tolerance: $\pm 15 \%$

Z_{SO} ... Impedance between S2 and S4 in a position of 0° (minimal coupling) with open outputs

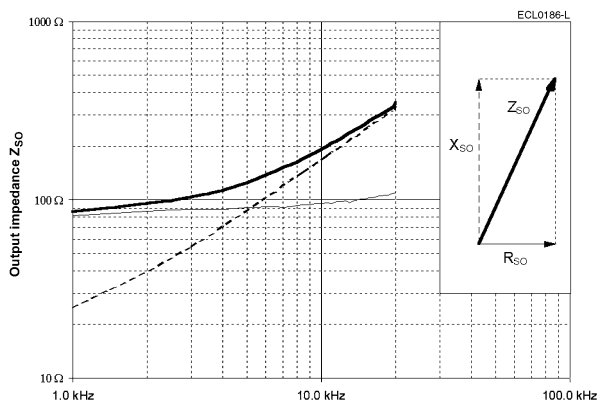

Tolerance: $\pm 15 \%$

Z_{SS} ... Impedance between S1 and S3 in a position of 0° (max. coupling) with short circuits between R1 and R2

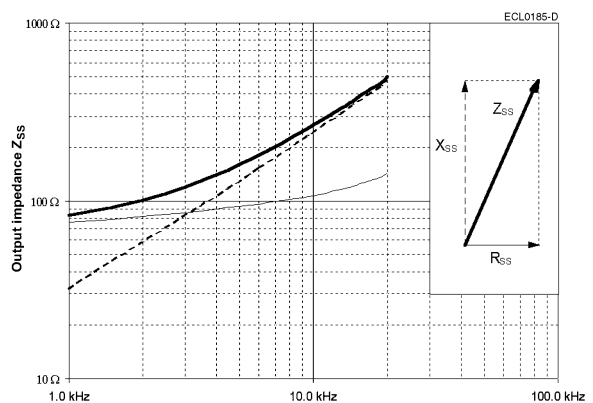

Inductance L

$L = X / (2 \cdot \pi \cdot f)$
 at $f = 10 \text{ kHz}$

$L_{RO} = 2.6 \text{ mH}$
 $L_{SS} = 3.9 \text{ mH}$

Housing

CrNi-steel

Electrical error / Ordering information

Angular error spread $\Delta\phi$

- $\pm 20'$
- $\pm 15'$
- $\pm 10'$
- $\pm 7'$

Ordering code

- V23401-D1009-B114
- V23401-D1009-B122
- V23401-D1009-B101
- V23401-D1009-B102

Residual voltage V_{residual}

14 mV at $V_{R1-R2} = 4 \text{ V}$

Electrical data at 22 °C.

Transfer function

Pairs of poles p

$p = 1$

Transformation ratio r_T

$$r_T = \frac{V_{S1-S3 \text{ max}}}{V_{R1-R2}}$$

$$= \frac{V_{S2-S4 \text{ max}}}{V_{R1-R2}}$$

- = $0.5 \pm 10 \%$ within 4 ... 20 kHz
- = $0.5 \pm 5 \%$ at 5 kHz

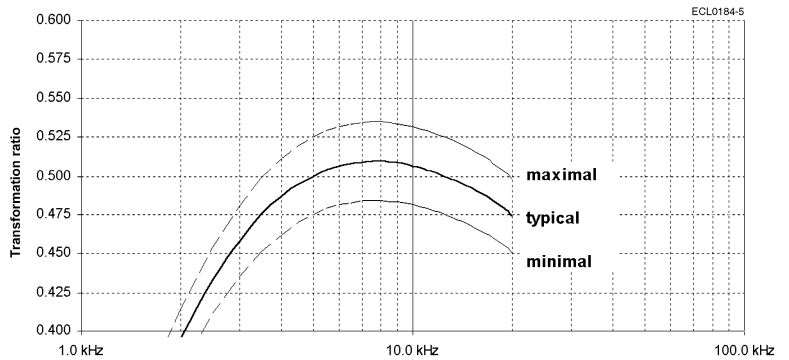

Phase shift ψ

$$V_{R1-R2}(t) = V_{R1-R2 \text{ max}} \cdot \sin(2 \cdot \pi \cdot f \cdot t)$$

$$V_{S1-S3}(t) = V_{S1-S3 \text{ max}} \cdot \sin(2 \cdot \pi \cdot f \cdot t - \psi)$$

for $-90^\circ < \alpha < +90^\circ$

Tolerance: $\pm 5^\circ$

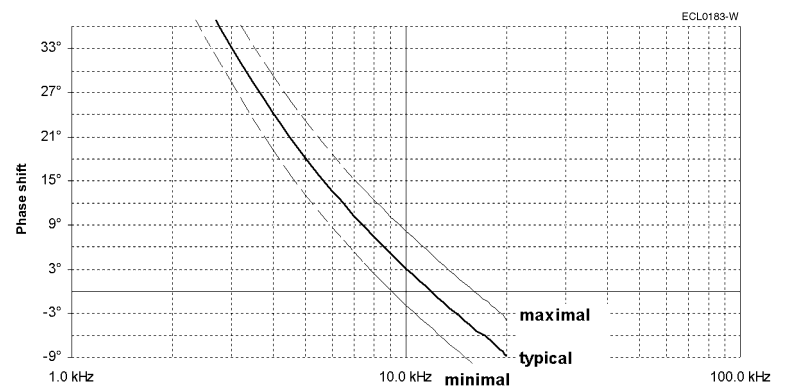

Size 15

Resistance, impedance and operating parameters

Input voltage V_{R1-R2}, typical	$2 V_{rms} \dots 8 V_{rms}$
Frequency f, typical	4 kHz ... 20 kHz

When choosing the values of these parameters take into account power dissipation, max. ambient temperature and the heat dissipation. Including self heating a maximum operating temperature of 150 °C must not be exceeded. Generally a power dissipation of $P \leq 0.3 \text{ W}$ is not critical.

Input current I

The adjacent figure applies to $V_{R1-R2} = 4 \text{ V}$.

For other input voltages, the input current changes follows as:

$$I = I_{\text{Figure}} \cdot V_{R1-R2} / 4 \text{ V}$$

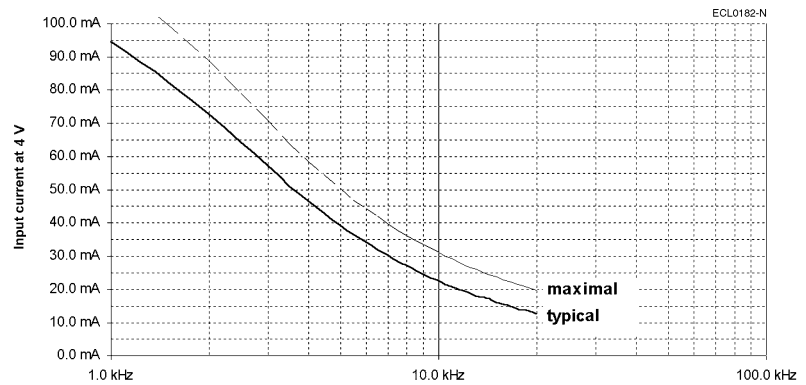

Power consumption P

The adjacent figure applies to $V_{R1-R2} = 4 \text{ V}$.

For other input voltages, the power consumption changes follows as:

$$P = P_{\text{Figure}} \cdot (V_{R1-R2} / 4 \text{ V})^2$$

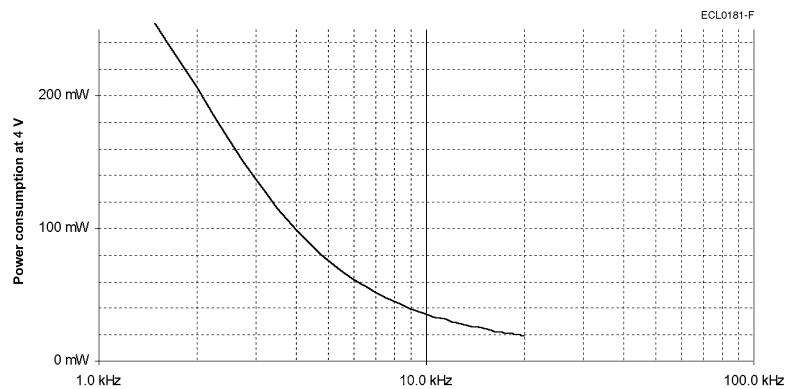

Size 15

Resistance, impedance and operating parameters (continued)

DC resistance

The ohmic resistance values are based on an ambient temperature of 22 °C and change with temperature by 0.39 % / K

$R_{R1-R2} = 31 \Omega$
 $R_{S1-S3} = R_{S2-S4} = 28 \Omega$
Tolerance: $\pm 10 \%$

Input impedance

Tolerance: $\pm 15 \%$

Z_{RO} ... Impedance between R1 and R2 with open outputs

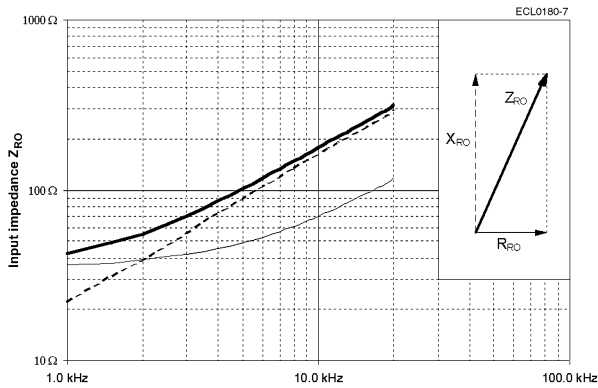

Tolerance: $\pm 15 \%$

Z_{RS} ... Impedance between R1 and R2 with short circuits between S1 and S3 as well as between S2 and S4

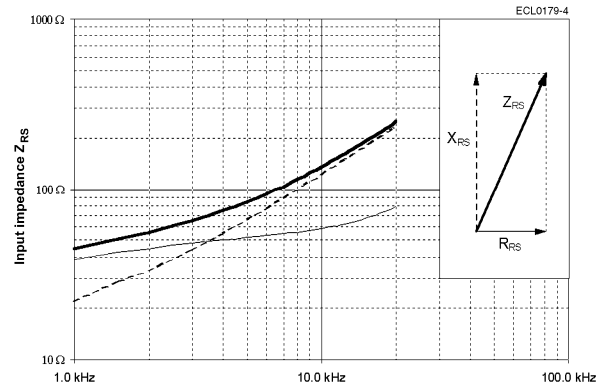

Output impedance

Tolerance: $\pm 15 \%$

Z_{SO} ... Impedance between S2 and S4 in a position of 0° (minimal coupling) with open outputs

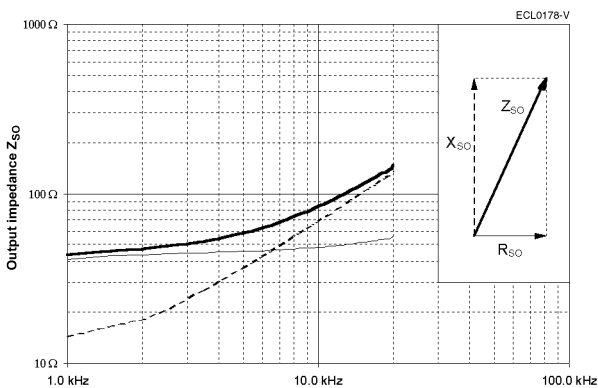

Tolerance: $\pm 15 \%$

Z_{SS} ... Impedance between S1 and S3 in a position of 0° (max. coupling) with short circuits between R1 and R2

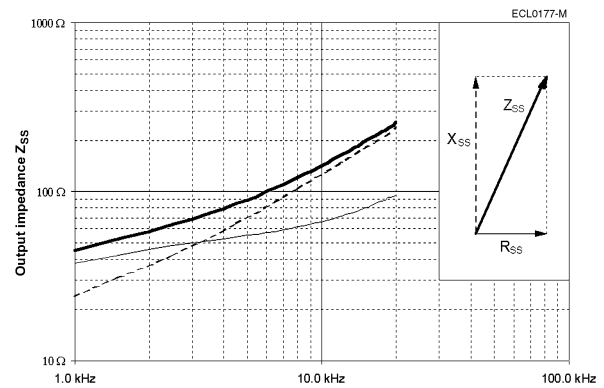

Inductance L

$L = X / (2 \cdot \pi \cdot f)$
at $f = 10 \text{ kHz}$

$L_{RO} = 2.6 \text{ mH}$
 $L_{SS} = 2.0 \text{ mH}$

Size 15

Housing CrMo-steel

Electrical error / Ordering information

Angular error spread $\Delta\phi$ $\pm 15'$ $\pm 10'$ $\pm 8'$ $\pm 6'$	Ordering code V23401-S1001-B122 V23401-S1001-B101 V23401-S1001-B109 V23401-S1001-B110
Residual voltage V_{residual}	25 mV at $V_{R1-R2} = 7 \text{ V}$

Electrical data at 22 °C.

Transfer function

Pairs of poles p $p = 1$

Transformation ratio r_T

$$r_T = \frac{V_{S1-S3 \text{ max}}}{V_{R1-R2}}$$

$$= \frac{V_{S2-S4 \text{ max}}}{V_{R1-R2}}$$

$= 0.5 \pm 10 \% \text{ within } 4 \dots 20 \text{ kHz}$
 $= 0.5 \pm 5 \% \text{ at } 5 \text{ kHz}$

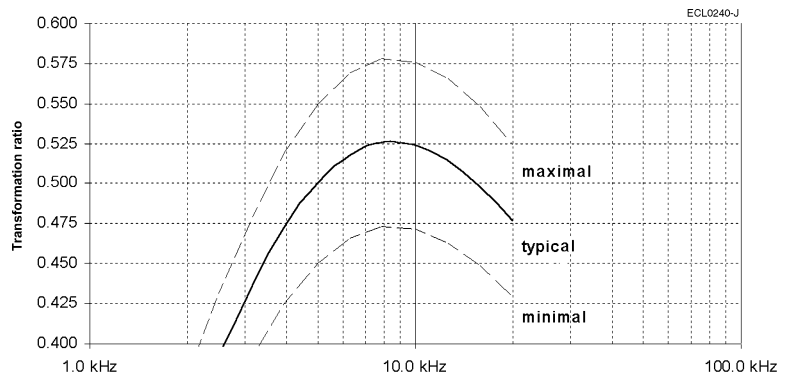

Phase shift ψ

$$V_{R1-R2}(t) = V_{R1-R2 \text{ max}} \cdot \sin(2 \cdot \pi \cdot f \cdot t)$$

$$V_{S1-S3}(t) = V_{S1-S3 \text{ max}} \cdot \sin(2 \cdot \pi \cdot f \cdot t - \psi)$$

for $-90^\circ < \alpha < +90^\circ$

Tolerance: $\pm 5^\circ$

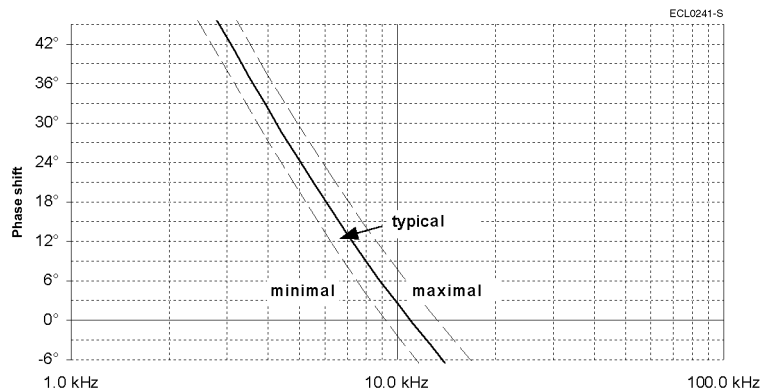

Size 15

Resistance, impedance and operating parameters

Input voltage V_{R1-R2}, typical	$2 V_{rms} \dots 10 V_{rms}$	When choosing the values of these parameters take into account power dissipation, max. ambient temperature and the heat dissipation. Including self heating a maximum operating temperature of 150 °C must not be exceeded. Generally a power dissipation of $P \leq 0.3 W$ is not critical.
Frequency f, typical	4 kHz ... 20 kHz	

Input current I

The adjacent figure applies to $V_{R1-R2} = 7 V$.

For other input voltages, the input current changes follows as:

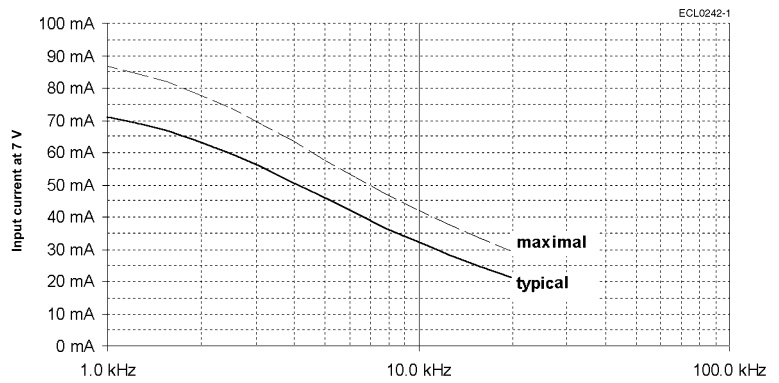
$$I = I_{Figure} \cdot V_{R1-R2} / 7 V$$

Power consumption P

The adjacent figure applies to $V_{R1-R2} = 7 V$.

For other input voltages, the power consumption changes follows as:

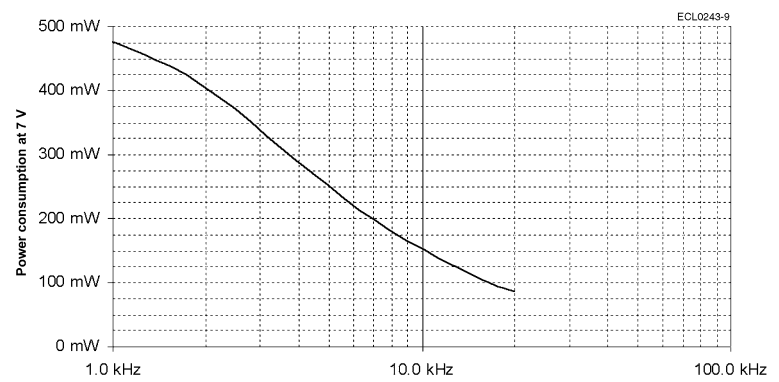
$$P = P_{Figure} \cdot (V_{R1-R2} / 7 V)^2$$

Resistance, impedance and operating parameters (continued)

DC resistance

The ohmic resistance values are based on an ambient temperature of 22 °C and change with temperature by 0.39 % / K

$R_{R1-R2} = 82 \Omega$
 $R_{S1-S3} = R_{S2-S4} = 68 \Omega$
 Tolerance: $\pm 10 \%$

Input impedance

Tolerance: $\pm 15 \%$

Z_{RO} ... Impedance between R1 and R2 with open outputs

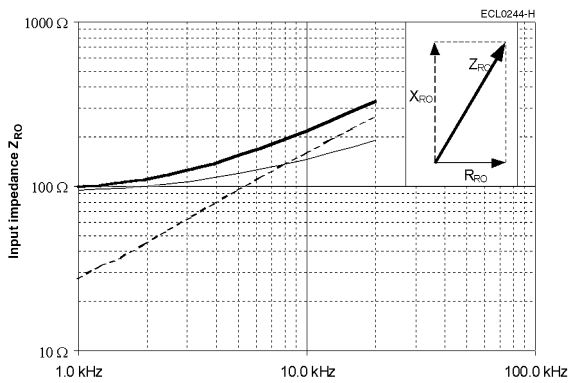

Tolerance: $\pm 15 \%$

Z_{RS} ... Impedance between R1 and R2 with short circuits between S1 and S3 as well as between S2 and S4

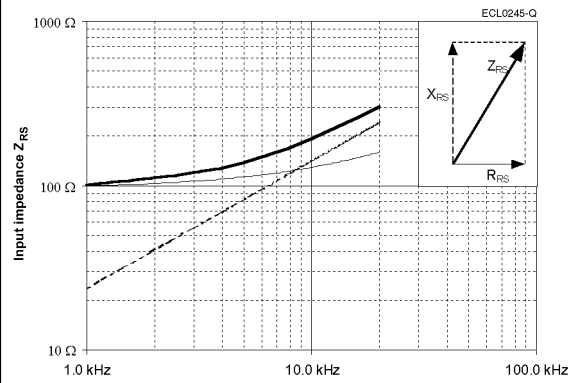

Output impedance

Tolerance: $\pm 15 \%$

Z_{SO} ... Impedance between S2 and S4 in a position of 0° (minimal coupling) with open outputs

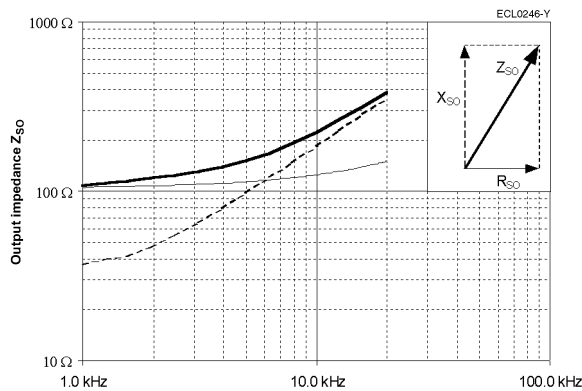

Tolerance: $\pm 15 \%$

Z_{SS} ... Impedance between S1 and S3 in a position of 0° (max. coupling) with short circuits between R1 and R2

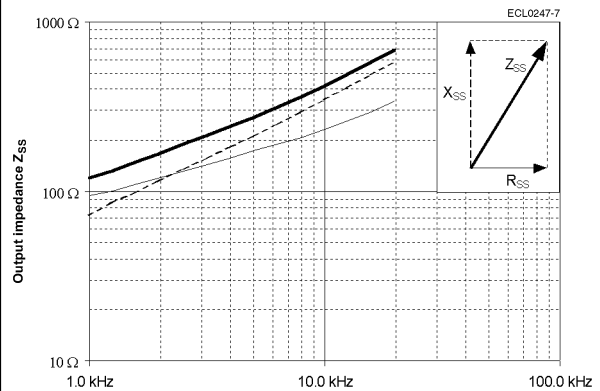

Inductance L

$L = X / (2 \cdot \pi \cdot f)$
 at $f = 5 \text{ kHz}$

$L_{RO} = 2.5 \text{ mH}$
 $L_{SS} = 5.8 \text{ mH}$

Transfer function				
<p>Function</p> $V_{S1-S3} = +\Gamma_T \cdot V_{R1-R2} \cdot \cos(p \cdot \alpha)$ $V_{S2-S4} = +\Gamma_T \cdot V_{R1-R2} \cdot \sin(p \cdot \alpha)$ <p>p = pairs of poles</p> <p>This function applies to the clockwise rotation of the rotor when looking at the (grooveless) transformer component from the top.</p>	<table border="0" style="width: 100%;"> <tr> <td style="text-align: left; vertical-align: top;">Input</td> <td style="text-align: center; vertical-align: top;"> </td> <td style="text-align: right; vertical-align: top;">Output</td> </tr> </table> <p style="text-align: right; font-size: small;">ECL0379-G</p>	Input		Output
Input		Output		

Electrical and thermal limits	
High-voltage test Windings to housing Windings to each other	500 V _{AC} , 50 Hz 250 V _{AC} , 50 Hz
Insulation resistance Windings to housing and windings to each other	$R_{insulation} > 50 \text{ M}\Omega$ at 500 V _{DC}
Operating temperature range	-55 °C ... +150 °C

Mechanical data	
Weight V23401-T 10... V23401-H 10... V23401-U 10... V23401-T 20... V23401-H 20... V23401-U 20...	approx. 240 g approx. 290 g approx. 290 g approx. 210 g approx. 260 g approx. 260 g
Momentum of inertia of the rotor	approx. 200 g · cm ²
Maximum rational speed	20 000 rpm
Maximum angular acceleration	64 000 rad/s ²
Torsional strength of rotor components	1 Nm
Shock resistance (11 ms sine)	1000 m/s ²
Vibration fatigue limit (0 ... 2 kHz)	200 m/s ²
Permissible radial runout (see Dimensioned drawing: Note 1)	0.075 mm
Permissible axial offset (see Dimensioned drawing: Note 2)	± 0.5 mm

Dimensioned drawing

V23401-T1... / H1... / U1...

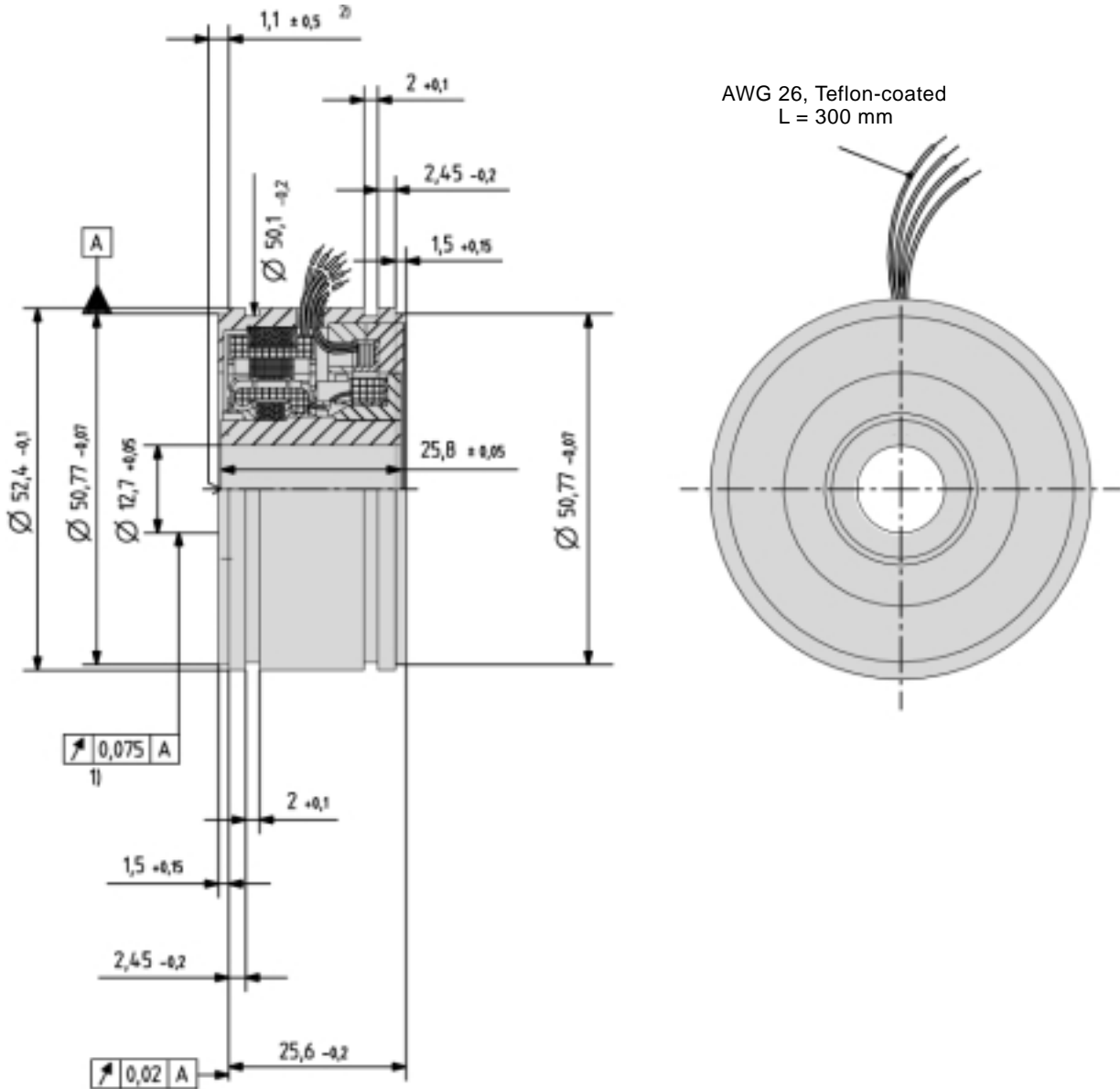

- 1) Total runout when installed
- 2) Axial offset

Dimensioned drawing

V23401-T2... / H2... / U2...

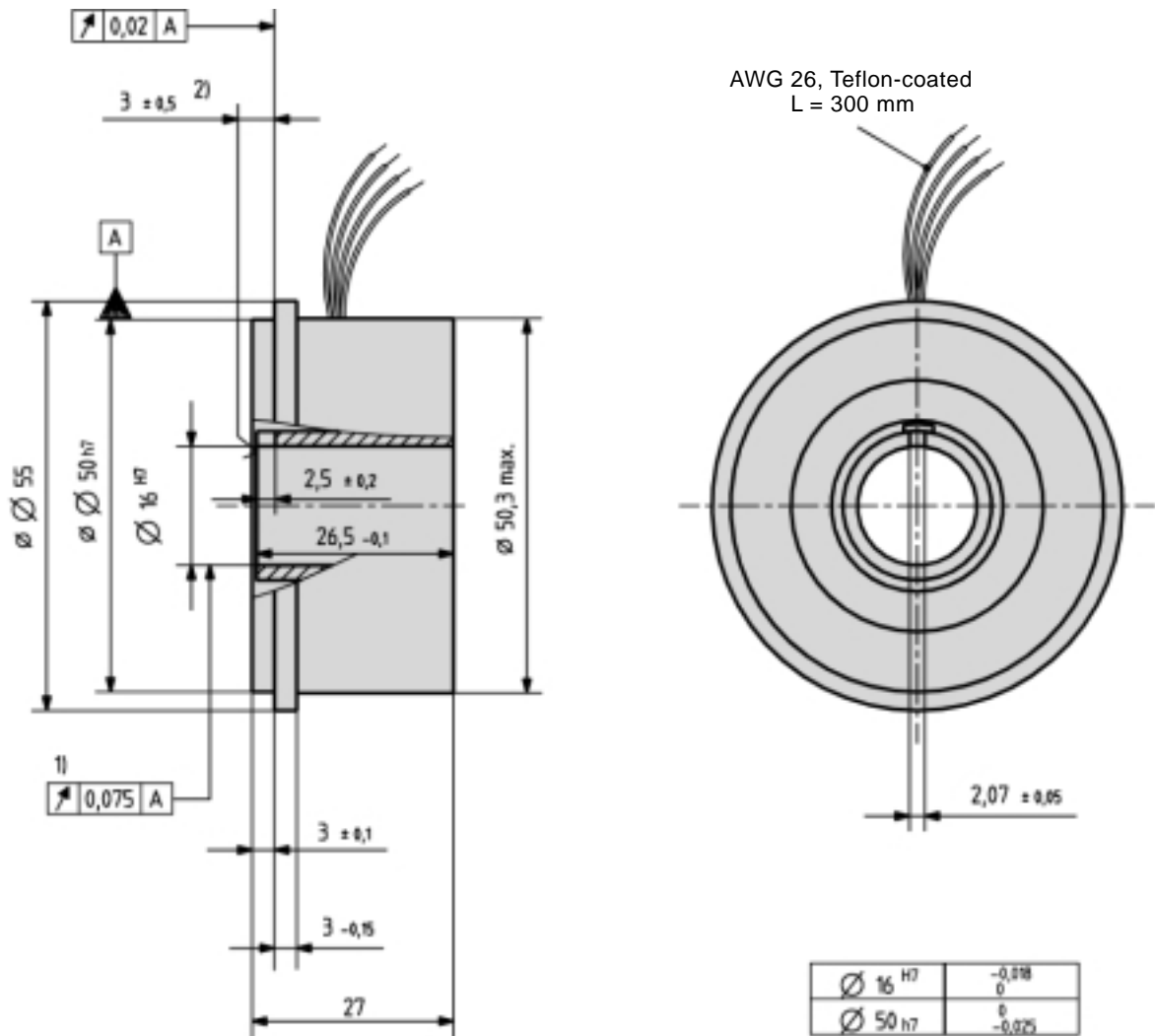

- 1) Total runout when installed
- 2) Axial offset

Housing	Aluminum	V23401-T 1002-B1..
	CrNi-steel	V23401-H1002-B1..

Electrical error / Ordering information

Angular error spread $\Delta\phi$	Ordering code	
	Aluminum housing	CrNi-steel housing
	$\pm 20'$	V23401-T1002-B114
	$\pm 15'$	V23401-T1002-B122
	$\pm 10'$	V23401-T1002-B101
$\pm 7'$	V23401-T1002-B102	V23401-H1002-B102
Residual voltage V_{residual}	25 mV at $V_{R1-R2} = 7 \text{ V}$	

Electrical data at 22 °C.

Transfer function

Pairs of poles p	$p = 3$
<p>Transformation ratio r_T</p> $r_T = V_{S1-S3 \text{ max}} / V_{R1-R2}$ $= V_{S2-S4 \text{ max}} / V_{R1-R2}$ <p>$= 0.5 \pm 10 \% \text{ within } 3 \dots 20 \text{ kHz}$ $= 0.5 \pm 5 \% \text{ at } 5 \text{ kHz}$</p>	
<p>Phase shift ψ</p> $V_{R1-R2}(t) = V_{R1-R2 \text{ max}} \cdot \sin(2 \cdot \pi \cdot f \cdot t)$ $V_{S1-S3}(t) = V_{S1-S3 \text{ max}} \cdot \sin(2 \cdot \pi \cdot f \cdot t - \psi)$ <p>for $-90^\circ < \alpha < +90^\circ$</p> <p>Tolerance: $\pm 5^\circ$</p>	

Resistance, impedance and operating parameters

Input voltage V_{R1-R2}, typical	$4 V_{rms} \dots 10 V_{rms}$	When choosing the values of these parameters take into account power dissipation, max. ambient temperature and the heat dissipation. Including self heating a maximum operating temperature of 150 °C must not be exceeded. Generally a power dissipation of $P \leq 0.5 W$ is not critical.
Frequency f, typical	3 kHz ... 15 kHz	

Input current I

The adjacent figure applies to $V_{R1-R2} = 7 V$.

For other input voltages, the input current changes follows as:

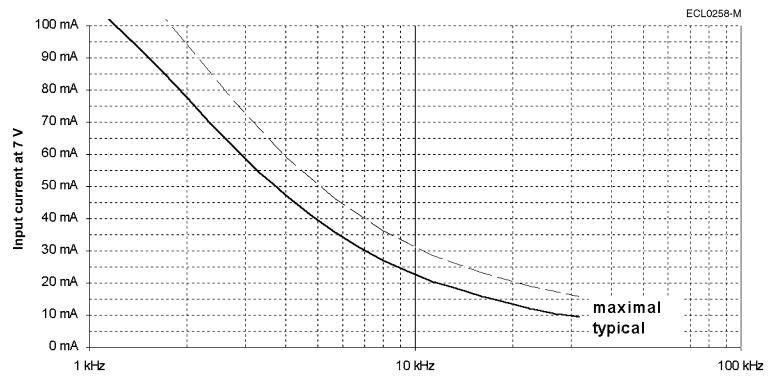
$$I = I_{Figure} \cdot V_{R1-R2} / 7 V$$

Power consumption P

The adjacent figure applies to $V_{R1-R2} = 7 V$.

For other input voltages, the power consumption changes follows as:

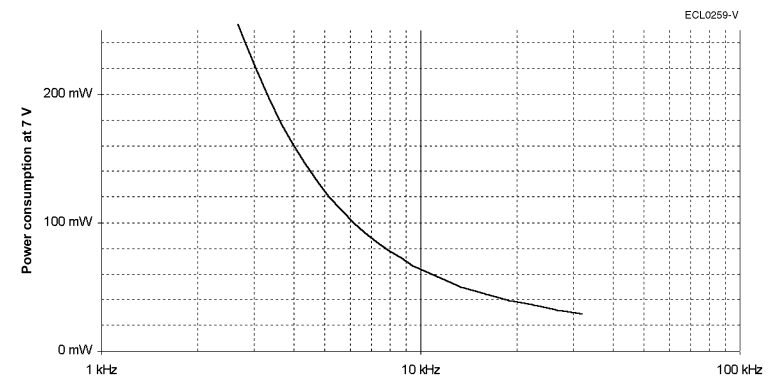
$$P = P_{Figure} \cdot (V_{R1-R2} / 7 V)^2$$

Resistance, impedance and operating parameters (continued)

DC resistance

The ohmic resistance values are based on an ambient temperature of 22 °C and change with temperature by 0.39 % / K

$R_{R1-R2} = 39 \Omega$
 $R_{S1-S3} = R_{S2-S4} = 94 \Omega$
 Tolerance: $\pm 10 \%$

Input impedance

Tolerance: $\pm 15 \%$

Z_{RO} ... Impedance between R1 and R2 with open outputs

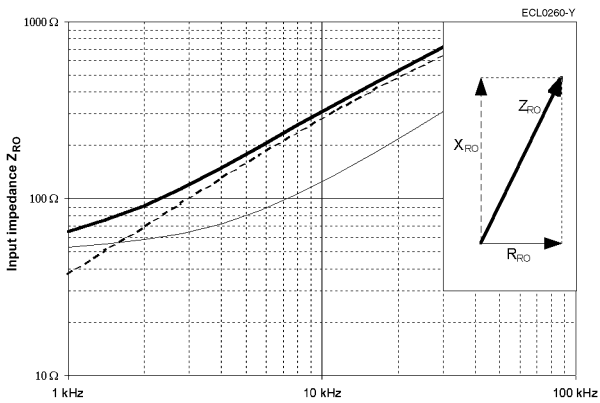

Tolerance: $\pm 15 \%$

Z_{RS} ... Impedance between R1 and R2 with short circuits between S1 and S3 as well as between S2 and S4

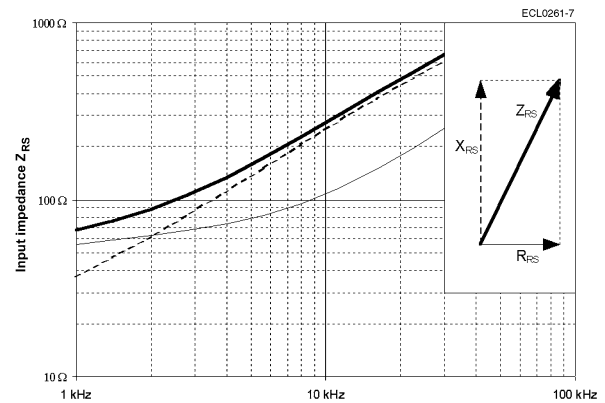

Output impedance

Tolerance: $\pm 15 \%$

Z_{SO} ... Impedance between S2 and S4 in a position of 0° (minimal coupling) with open outputs

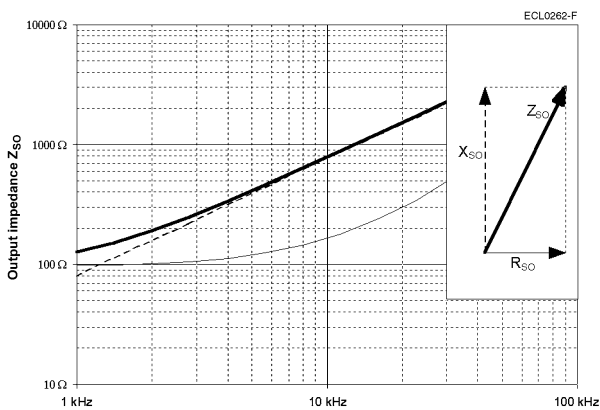

Tolerance: $\pm 15 \%$

Z_{SS} ... Impedance between S1 and S3 in a position of 0° (max. coupling) with short circuits between R1 and R2

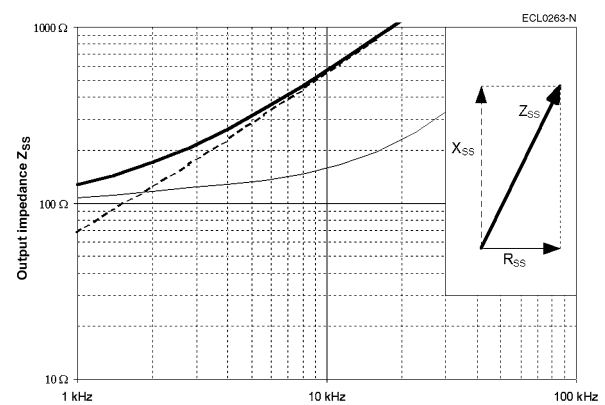

Inductance L

$L = X / (2 \cdot \pi \cdot f)$
 at $f = 8 \text{ kHz}$

$L_{RO} = 4.7 \text{ mH}$
 $L_{SS} = 8.8 \text{ mH}$

Housing	Aluminum	V23401-T 1005-B1..
	CrNi-steel	V23401-H1005-B1..

Electrical error / Ordering information

Angular error spread $\Delta\phi$	Ordering code	
	Aluminum housing	CrNi-steel housing
	$\pm 20'$	V23401-T1005-B114
	$\pm 15'$	V23401-H1005-B114
	$\pm 10'$	V23401-T1005-B122
$\pm 10'$	V23401-H1005-B122	
$\pm 7'$	V23401-T1005-B101	
	V23401-H1005-B101	
	V23401-T1005-B102	
	V23401-H1005-B102	
Residual voltage $V_{residual}$	25 mV at $V_{R1-R2} = 7 V$	

Electrical data at 22 °C.

Transfer function

Pairs of poles p	p = 1
<p>Transformation ratio r_T</p> $r_T = V_{S1-S3 \max} / V_{R1-R2}$ $= V_{S2-S4 \max} / V_{R1-R2}$ <p>= 0.5 ± 10 % within 2 ... 10 kHz = 0.5 ± 5 % at 5 kHz</p>	
<p>Phase shift ψ</p> $V_{R1-R2}(t) = V_{R1-R2 \max} \cdot \sin(2 \cdot \pi \cdot f \cdot t)$ $V_{S1-S3}(t) = V_{S1-S3 \max} \cdot \sin(2 \cdot \pi \cdot f \cdot t - \psi)$ <p>for $-90^\circ < \alpha < +90^\circ$</p> <p>Tolerance: ± 5°</p>	

Resistance, impedance and operating parameters

Input voltage V_{R1-R2}, typical	$4 V_{rms} \dots 12 V_{rms}$
Frequency f, typical	2 kHz ... 10 kHz

When choosing the values of these parameters take into account power dissipation, max. ambient temperature and the heat dissipation. Including self heating a maximum operating temperature of 150 °C must not be exceeded. Generally a power dissipation of $P \leq 0.5 W$ is not critical.

Input current I

The adjacent figure applies to $V_{R1-R2} = 7 V$.

For other input voltages, the input current changes follows as:

$$I = I_{Figure} \cdot V_{R1-R2} / 7 V$$

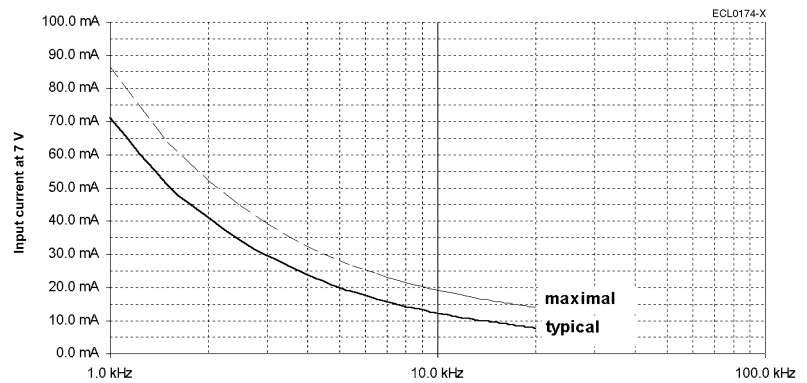

Power consumption P

The adjacent figure applies to $V_{R1-R2} = 7 V$.

For other input voltages, the power consumption changes follows as:

$$P = P_{Figure} \cdot (V_{R1-R2} / 7 V)^2$$

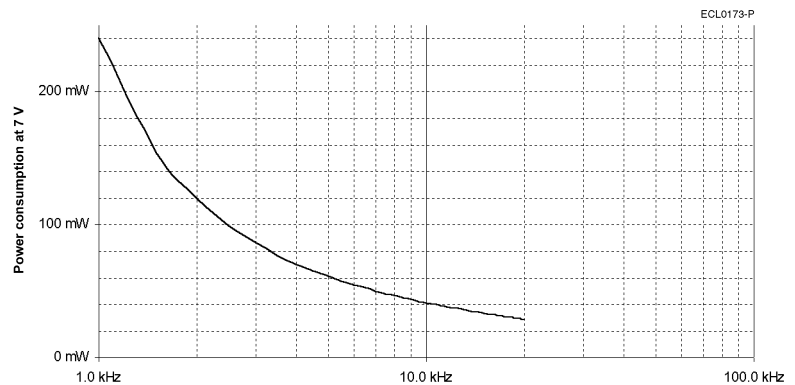

Resistance, impedance and operating parameters (continued)

DC resistance

The ohmic resistance values are based on an ambient temperature of 22 °C and change with temperature by 0.39 % / K

$R_{R1-R2} = 24 \Omega$
 $R_{S1-S3} = R_{S2-S4} = 58 \Omega$
Tolerance: $\pm 10 \%$

Input impedance

Tolerance: $\pm 15 \%$

Z_{RO} ... Impedance between R1 and R2 with open outputs

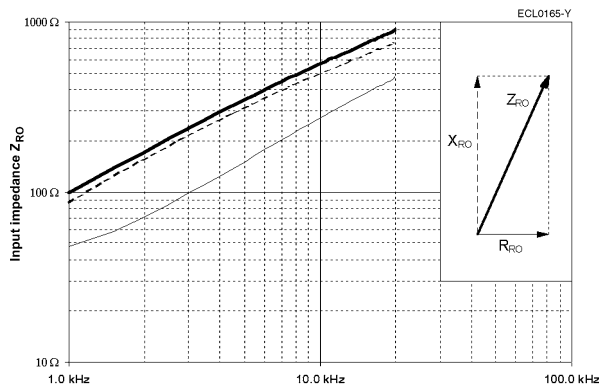

Tolerance: $\pm 15 \%$

Z_{RS} ... Impedance between R1 and R2 with short circuits between S1 and S3 as well as between S2 and S4

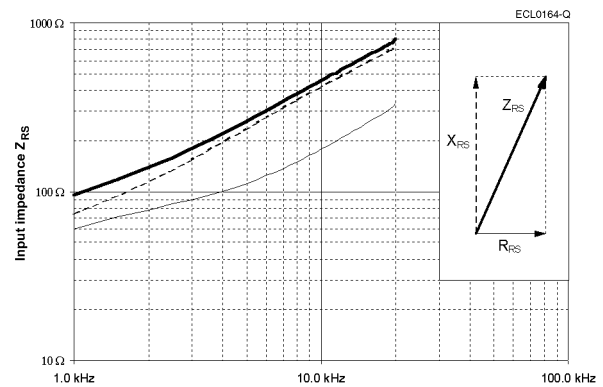

Output impedance

Tolerance: $\pm 15 \%$

Z_{SO} ... Impedance between S2 and S4 in a position of 0° (minimal coupling) with open outputs

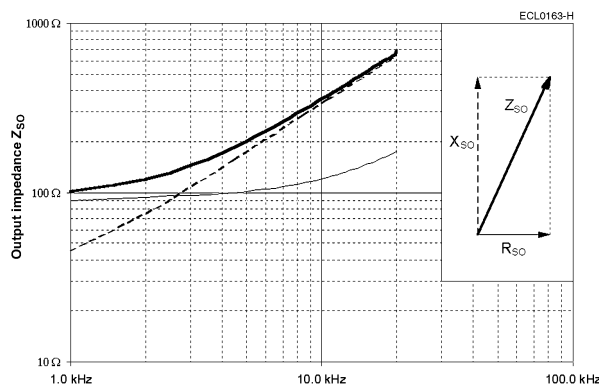

Tolerance: $\pm 15 \%$

Z_{SS} ... Impedance between S1 and S3 in a position of 0° (max. coupling) with short circuits between R1 and R2

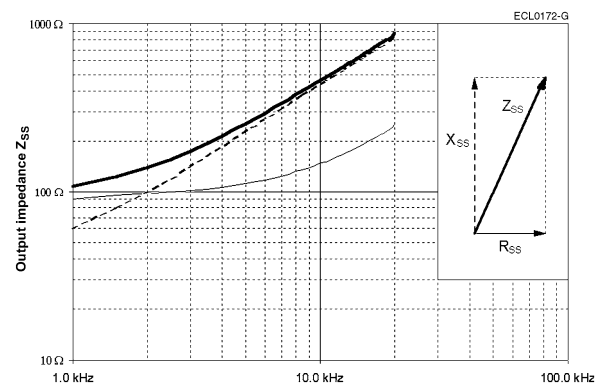

Inductance L

$L = X / (2 \cdot \pi \cdot f)$
at $f = 10 \text{ kHz}$

$L_{RO} = 7.9 \text{ mH}$
 $L_{SS} = 6.9 \text{ mH}$

Housing	Aluminum	V23401-T 1009-B1..
	CrNi-steel	V23401-H1009-B1..

Electrical error / Ordering information

Angular error spread $\Delta\phi$	Ordering code	
	Aluminum housing	CrNi-steel housing
	$\pm 20'$	V23401-T1009-B114
	$\pm 15'$	V23401-H1009-B114
	$\pm 10'$	V23401-T1009-B122
$\pm 10'$	V23401-H1009-B122	
$\pm 7'$	V23401-T1009-B101	
	V23401-H1009-B101	
	V23401-T1009-B102	
	V23401-H1009-B102	
Residual voltage V_{residual}	14 mV at $V_{R1-R2} = 4 \text{ V}$	

Electrical data at 22 °C.

Transfer function

Pairs of poles p	$p = 1$
-------------------------	---------

Transformation ratio r_T

$$r_T = V_{S1-S3 \text{ max}} / V_{R1-R2}$$

$$= V_{S2-S4 \text{ max}} / V_{R1-R2}$$

$= 0.5 \pm 10\%$ within 2 ... 8 kHz
 $= 0.5 \pm 5\%$ at 5 kHz

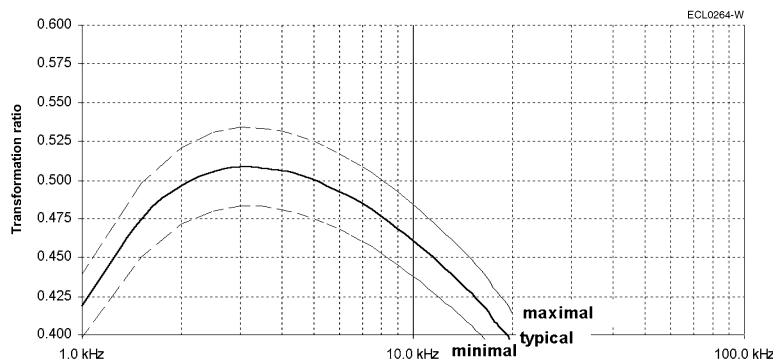

Phase shift ψ

$$V_{R1-R2}(t) = V_{R1-R2 \text{ max}} \cdot \sin(2 \cdot \pi \cdot f \cdot t)$$

$$V_{S1-S3}(t) = V_{S1-S3 \text{ max}} \cdot \sin(2 \cdot \pi \cdot f \cdot t - \psi)$$

for $-90^\circ < \alpha < +90^\circ$

Tolerance: $\pm 5^\circ$

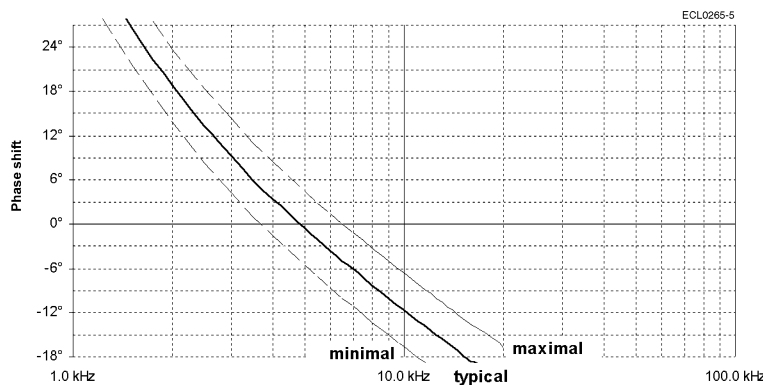

Resistance, impedance and operating parameters

Input voltage V_{R1-R2}, typical	$2 V_{rms} \dots 8 V_{rms}$	When choosing the values of these parameters take into account power dissipation, max. ambient temperature and the heat dissipation. Including self heating a maximum operating temperature of 150 °C must not be exceeded. Generally a power dissipation of $P \leq 0.5 W$ is not critical.
Frequency f, typical	2 kHz ... 10 kHz	

Input current I

The adjacent figure applies to $V_{R1-R2} = 4 V$.

For other input voltages, the input current changes follows as:

$$I = I_{Figure} \cdot V_{R1-R2} / 4 V$$

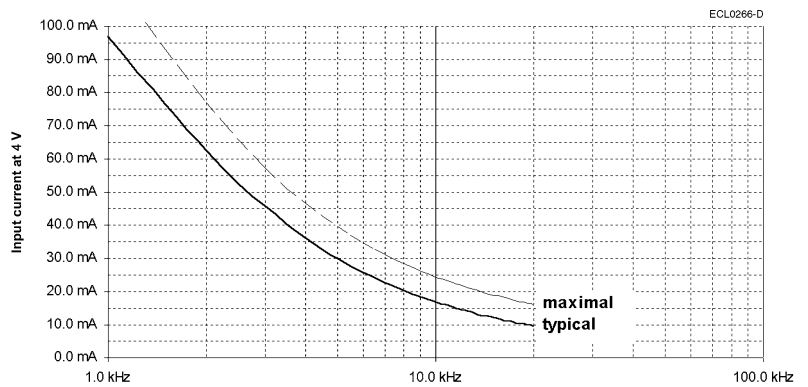

Power consumption P

The adjacent figure applies to $V_{R1-R2} = 4 V$.

For other input voltages, the power consumption changes follows as:

$$P = P_{Figure} \cdot (V_{R1-R2} / 4 V)^2$$

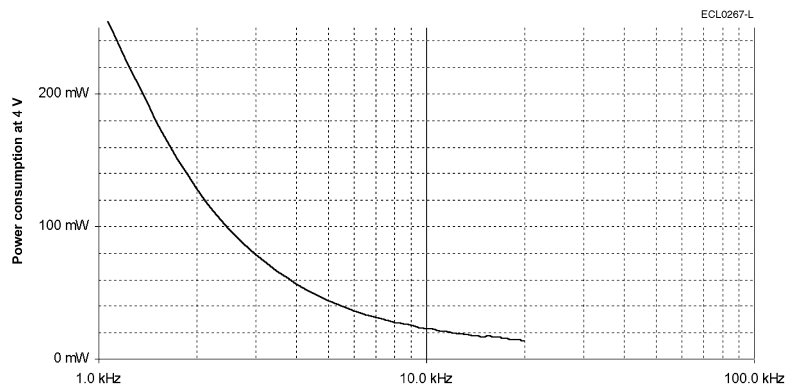

Resistance, impedance and operating parameters (continued)

DC resistance

The ohmic resistance values are based on an ambient temperature of 22 °C and change with temperature by 0.39 % / K

$R_{R1-R2} = 21 \Omega$
 $R_{S1-S3} = R_{S2-S4} = 22 \Omega$
 Tolerance: $\pm 10 \%$

Input impedance

Tolerance: $\pm 15 \%$

Z_{RO} ... Impedance between R1 and R2 with open outputs

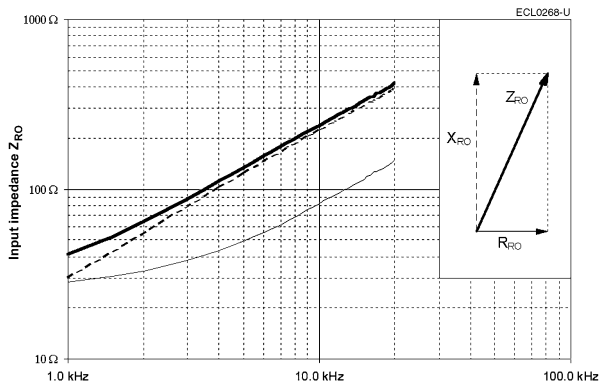

Tolerance: $\pm 15 \%$

Z_{RS} ... Impedance between R1 and R2 with short circuits between S1 and S3 as well as between S2 and S4

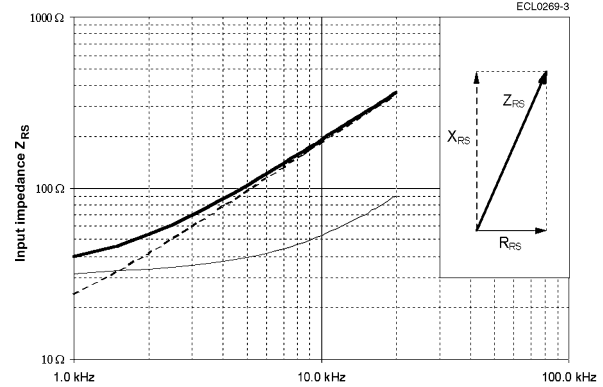

Output impedance

Tolerance: $\pm 15 \%$

Z_{SO} ... Impedance between S2 and S4 in a position of 0° (minimal coupling) with open outputs

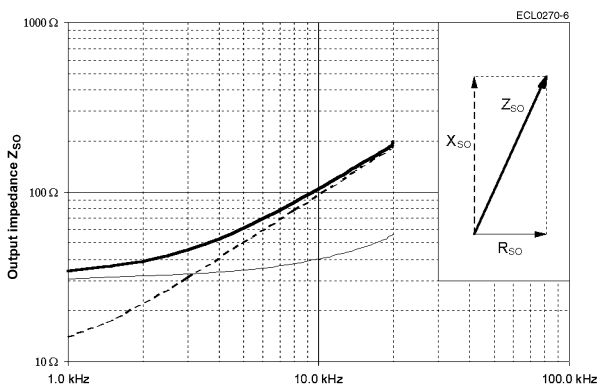

Tolerance: $\pm 15 \%$

Z_{SS} ... Impedance between S1 and S3 in a position of 0° (max. coupling) with short circuits between R1 and R2

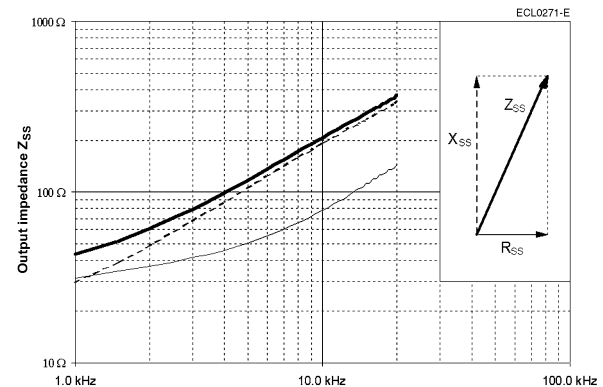

Inductance L

$L = X / (2 \cdot \pi \cdot f)$
 at $f = 10 \text{ kHz}$

$L_{RO} = 3.5 \text{ mH}$
 $L_{SS} = 3.1 \text{ mH}$

Housing	Aluminum	V23401-T 2001-B2..
	CrNi-steel	V23401-H2001-B2..

Electrical error / Ordering information

Angular error spread $\Delta\phi$	Ordering code	
	Aluminum housing	CrNi-steel housing
	$\pm 20'$	V23401-T2001-B214
	$\pm 15'$	V23401-H2001-B214
	$\pm 10'$	V23401-T2001-B222
$\pm 10'$	V23401-H2001-B222	
$\pm 7'$	V23401-T2001-B201	
	V23401-H2001-B201	
	V23401-T2001-B202	
	V23401-H2001-B202	
Residual voltage $V_{residual}$	25 mV at $V_{R1-R2} = 7 V$	

Electrical data at 22 °C.

Transfer function

Pairs of poles p	$p = 1$
<p>Transformation ratio r_T</p> $r_T = V_{S1-S3 \max} / V_{R1-R2}$ $= V_{S2-S4 \max} / V_{R1-R2}$ <p>= 0.5 \pm 10 % within 2 ... 10 kHz = 0.5 \pm 5 % at 5 kHz</p>	
<p>Phase shift ψ</p> $V_{R1-R2}(t) = V_{R1-R2 \max} \cdot \sin(2 \cdot \pi \cdot f \cdot t)$ $V_{S1-S3}(t) = V_{S1-S3 \max} \cdot \sin(2 \cdot \pi \cdot f \cdot t - \psi)$ <p>for $-90^\circ < \alpha < +90^\circ$</p> <p>Tolerance: $\pm 5^\circ$</p>	

Size 21

Resistance, impedance and operating parameters

Input voltage V_{R1-R2}, typical	$4 V_{rms} \dots 12 V_{rms}$
Frequency f, typical	2 kHz ... 10 kHz

When choosing the values of these parameters take into account power dissipation, max. ambient temperature and the heat dissipation. Including self heating a maximum operating temperature of 150 °C must not be exceeded. Generally a power dissipation of $P \leq 0.5 W$ is not critical.

Input current I

The adjacent figure applies to $V_{R1-R2} = 7 V$.

For other input voltages, the input current changes follows as:

$$I = I_{\text{Figure}} \cdot V_{R1-R2} / 7 V$$

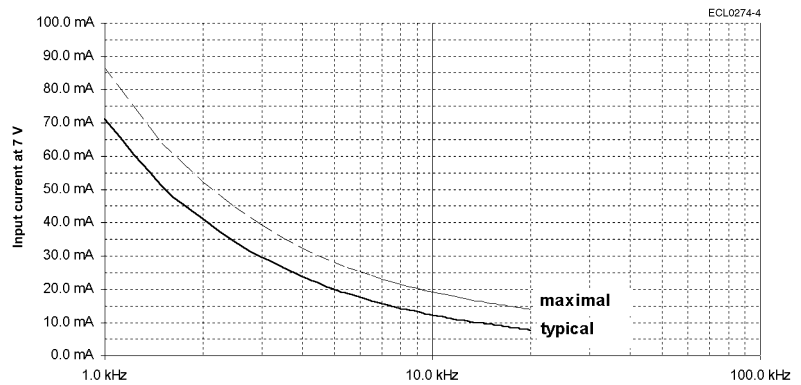

Power consumption P

The adjacent figure applies to $V_{R1-R2} = 7 V$.

For other input voltages, the power consumption changes follows as:

$$P = P_{\text{Figure}} \cdot (V_{R1-R2} / 7 V)^2$$

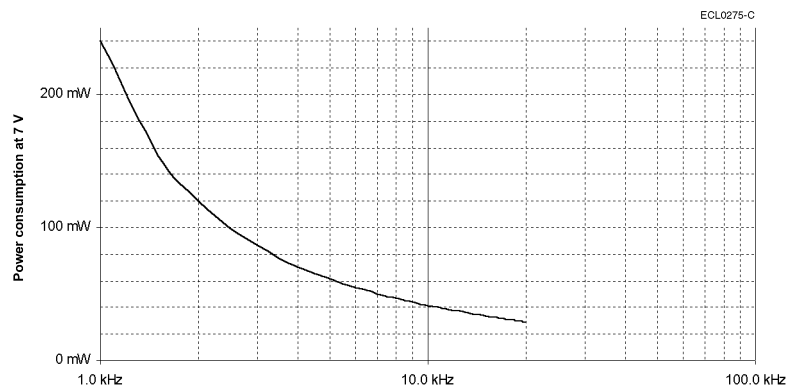

Resistance, impedance and operating parameters (continued)

DC resistance

The ohmic resistance values are based on an ambient temperature of 22 °C and change with temperature by 0.39 % / K

$R_{R1-R2} = 24 \Omega$
 $R_{S1-S3} = R_{S2-S4} = 58 \Omega$
Tolerance: $\pm 10 \%$

Input impedance

Tolerance: $\pm 15 \%$

Z_{RO} ... Impedance between R1 and R2 with open outputs

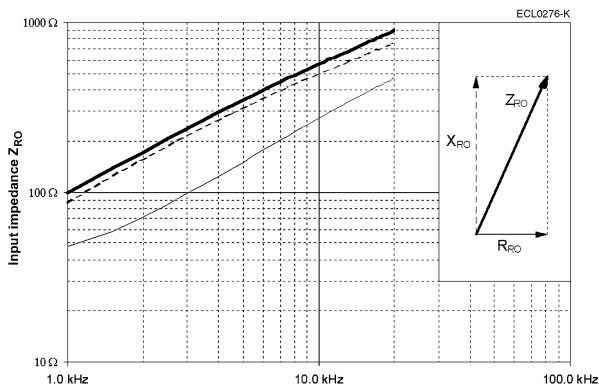

Tolerance: $\pm 15 \%$

Z_{RS} ... Impedance between R1 and R2 with short circuits between S1 and S3 as well as between S2 and S4

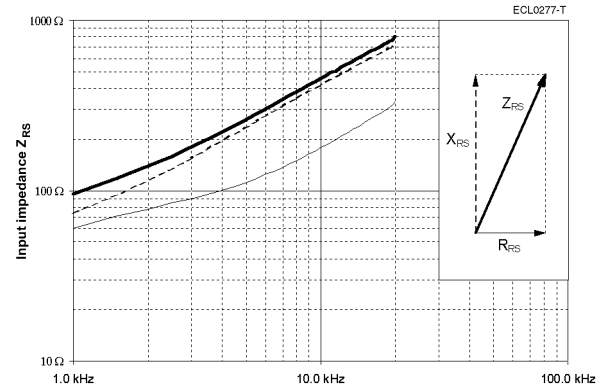

Output impedance

Tolerance: $\pm 15 \%$

Z_{SO} ... Impedance between S2 and S4 in a position of 0° (minimal coupling) with open outputs

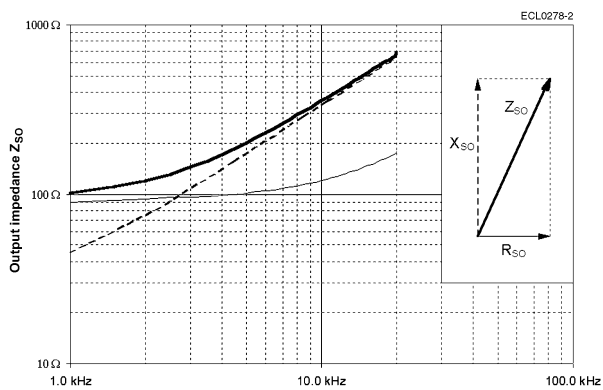

Tolerance: $\pm 15 \%$

Z_{SS} ... Impedance between S1 and S3 in a position of 0° (max. coupling) with short circuits between R1 and R2

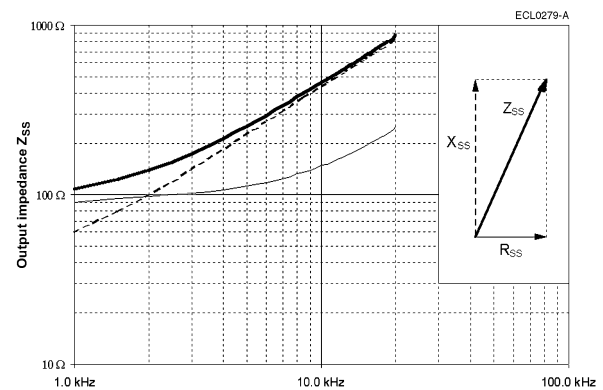

Inductance L

$L = X / (2 \cdot \pi \cdot f)$
at $f = 10 \text{ kHz}$

$L_{RO} = 7.9 \text{ mH}$
 $L_{SS} = 6.9 \text{ mH}$

Housing	Aluminum	V23401-T 2009-B2..
	CrNi-steel	V23401-H 2009-B2..

Electrical error / Ordering information

Angular error spread $\Delta\phi$	Ordering code	
	Aluminum housing	CrNi-steel housing
	$\pm 20'$	V23401-T2009-B214
	$\pm 15'$	V23401-H2009-B214
	$\pm 10'$	V23401-T2009-B222
$\pm 10'$	V23401-H2009-B222	
$\pm 7'$	V23401-T2009-B201	
	V23401-H2009-B201	
	V23401-T2009-B202	
	V23401-H2009-B202	
Residual voltage V_{residual}	14 mV at $V_{R1-R2} = 4 \text{ V}$	

Electrical data at 22 °C.

Transfer function

Pairs of poles p	$p = 1$
<p>Transformation ratio r_T</p> $r_T = V_{S1-S3 \text{ max}} / V_{R1-R2}$ $= V_{S2-S4 \text{ max}} / V_{R1-R2}$ <p>$= 0.5 \pm 10 \% \text{ within } 2 \dots 8 \text{ kHz}$ $= 0.5 \pm 5 \% \text{ at } 5 \text{ kHz}$</p>	
<p>Phase shift ψ</p> $V_{R1-R2}(t) = V_{R1-R2 \text{ max}} \cdot \sin(2 \cdot \pi \cdot f \cdot t)$ $V_{S1-S3}(t) = V_{S1-S3 \text{ max}} \cdot \sin(2 \cdot \pi \cdot f \cdot t - \psi)$ <p>for $-90^\circ < \alpha < +90^\circ$</p> <p>Tolerance: $\pm 5^\circ$</p>	

Resistance, impedance and operating parameters

Input voltage V_{R1-R2}, typical	$2 V_{rms} \dots 8 V_{rms}$
Frequency f, typical	2 kHz ... 10 kHz

When choosing the values of these parameters take into account power dissipation, max. ambient temperature and the heat dissipation. Including self heating a maximum operating temperature of 150 °C must not be exceeded. Generally a power dissipation of $P \leq 0.5 \text{ W}$ is not critical.

Input current I

The adjacent figure applies to $V_{R1-R2} = 4 \text{ V}$.

For other input voltages, the input current changes follows as:

$$I = I_{\text{Figure}} \cdot V_{R1-R2} / 4 \text{ V}$$

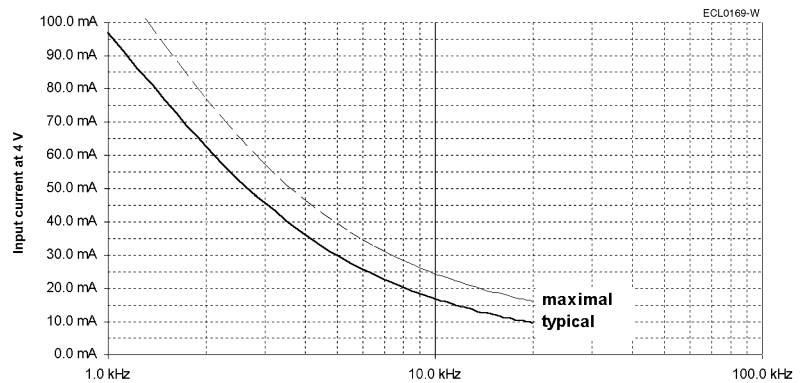

Power consumption P

The adjacent figure applies to $V_{R1-R2} = 4 \text{ V}$.

For other input voltages, the power consumption changes follows as:

$$P = P_{\text{Figure}} \cdot (V_{R1-R2} / 4 \text{ V})^2$$

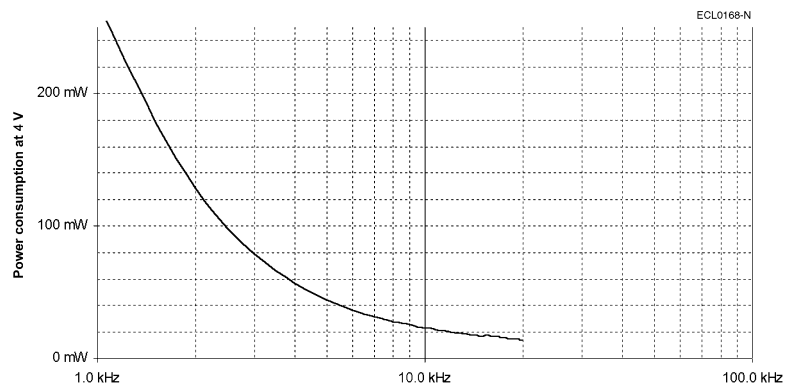

Resistance, impedance and operating parameters (continued)

DC resistance

The ohmic resistance values are based on an ambient temperature of 22 °C and change with temperature by 0.39 % / K

$R_{R1-R2} = 21 \Omega$
 $R_{S1-S3} = R_{S2-S4} = 22 \Omega$
 Tolerance: $\pm 10 \%$

Input impedance

Tolerance: $\pm 15 \%$

Z_{RO} ... Impedance between R1 and R2 with open outputs

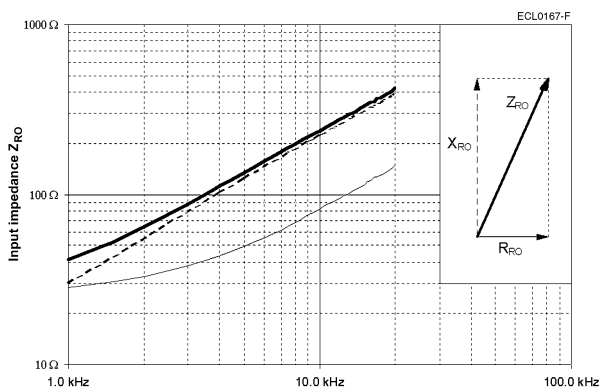

Tolerance: $\pm 15 \%$

Z_{RS} ... Impedance between R1 and R2 with short circuits between S1 and S3 as well as between S2 and S4

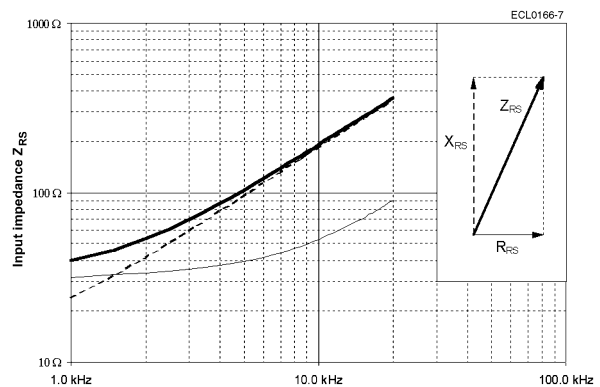

Output impedance

Tolerance: $\pm 15 \%$

Z_{SO} ... Impedance between S2 and S4 in a position of 0° (minimal coupling) with open outputs

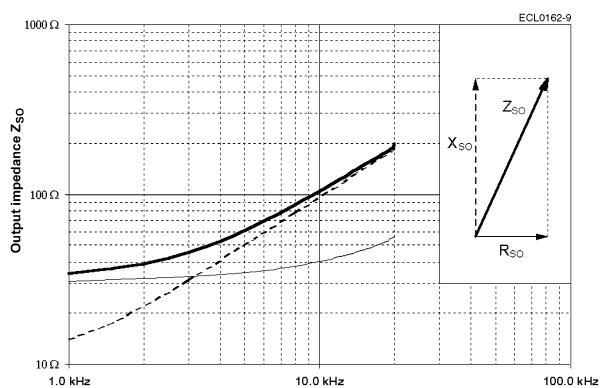

Tolerance: $\pm 15 \%$

Z_{SS} ... Impedance between S1 and S3 in a position of 0° (max. coupling) with short circuits between R1 and R2

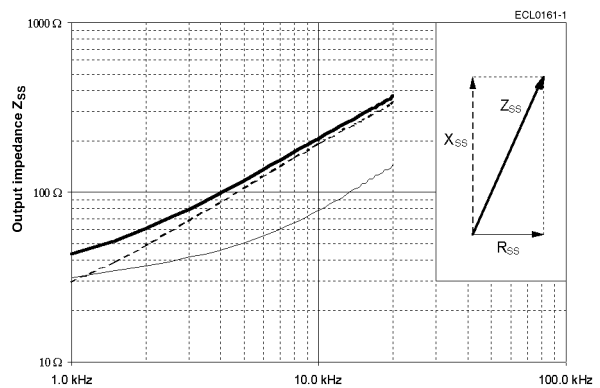

Inductance L

$L = X / (2 \cdot \pi \cdot f)$
 at $f = 10 \text{ kHz}$

$L_{RO} = 3.5 \text{ mH}$
 $L_{SS} = 3.1 \text{ mH}$

Housing	Aluminum	V23401-T 2010-B2..
	CrNi-steel	V23401-H 2010-B2..

Electrical error / Ordering information

Angular error spread $\Delta\phi$	Ordering code	
	Aluminum housing	CrNi-steel housing
	$\pm 20'$	V23401-T2010-B214
	$\pm 15'$	V23401-H2010-B214
	$\pm 10'$	V23401-T2010-B222
$\pm 10'$	V23401-H2010-B222	
$\pm 7'$	V23401-T2010-B201	
	V23401-H2010-B201	
	V23401-T2010-B202	
	V23401-H2010-B202	
Residual voltage V_{residual}	20 mV at $V_{R1-R2} = 6 V$	

Electrical data at 22 °C.

Transfer function

Pairs of poles p	p = 3
<p>Transformation ratio r_T</p> $r_T = V_{S1-S3 \text{ max}} / V_{R1-R2}$ $= V_{S2-S4 \text{ max}} / V_{R1-R2}$ <p>= 0.46 ± 10 % within 3 ... 20 kHz = 0.46 ± 5 % at 6 kHz</p>	
<p>Phase shift ψ</p> $V_{R1-R2}(t) = V_{R1-R2 \text{ max}} \cdot \sin(2 \cdot \pi \cdot f \cdot t)$ $V_{S1-S3}(t) = V_{S1-S3 \text{ max}} \cdot \sin(2 \cdot \pi \cdot f \cdot t - \psi)$ <p>for $-90^\circ < \alpha < +90^\circ$</p> <p>Tolerance: ± 5°</p>	

Resistance, impedance and operating parameters

Input voltage V_{R1-R2}, typical	$2 V_{rms} \dots 10 V_{rms}$
Frequency f, typical	4 kHz ... 15 kHz

When choosing the values of these parameters take into account power dissipation, max. ambient temperature and the heat dissipation. Including self heating a maximum operating temperature of 150 °C must not be exceeded. Generally a power dissipation of $P \leq 0.5 \text{ W}$ is not critical.

Input current I

The adjacent figure applies to $V_{R1-R2} = 6 \text{ V}$.

For other input voltages, the input current changes follows as:

$$I = I_{\text{Figure}} \cdot V_{R1-R2} / 6 \text{ V}$$

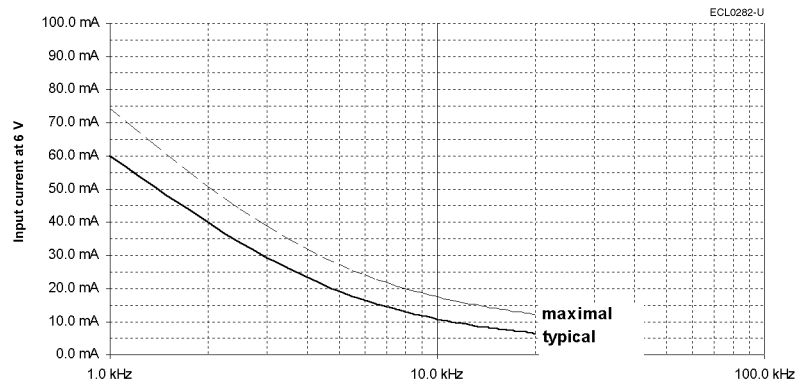

Power consumption P

The adjacent figure applies to $V_{R1-R2} = 6 \text{ V}$.

For other input voltages, the power consumption changes follows as:

$$P = P_{\text{Figure}} \cdot (V_{R1-R2} / 6 \text{ V})^2$$

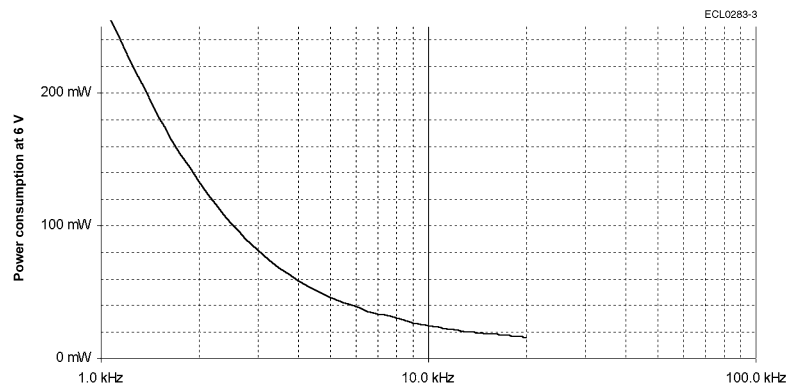

Resistance, impedance and operating parameters (continued)

DC resistance

The ohmic resistance values are based on an ambient temperature of 22 °C and change with temperature by 0.39 % / K

$R_{R1-R2} = 55 \Omega$
 $R_{S1-S3} = R_{S2-S4} = 173 \Omega$
 Tolerance: $\pm 10 \%$

Input impedance

Tolerance: $\pm 15 \%$

Z_{RO} ... Impedance between R1 and R2 with open outputs

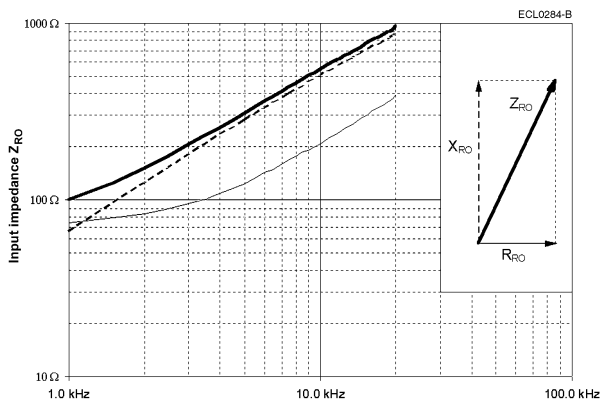

Tolerance: $\pm 15 \%$

Z_{RS} ... Impedance between R1 and R2 with short circuits between S1 and S3 as well as between S2 and S4

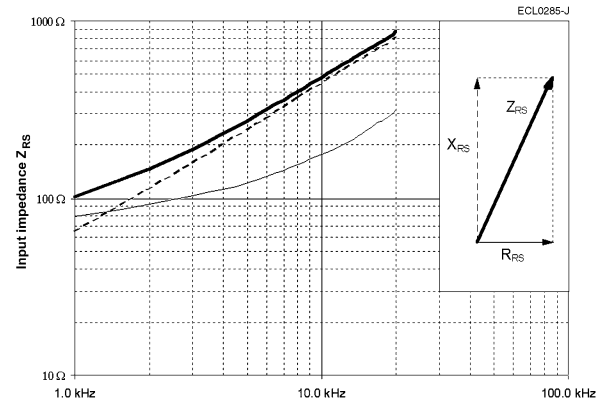

Output impedance

Tolerance: $\pm 15 \%$

Z_{SO} ... Impedance between S2 and S4 in a position of 0° (minimal coupling) with open outputs

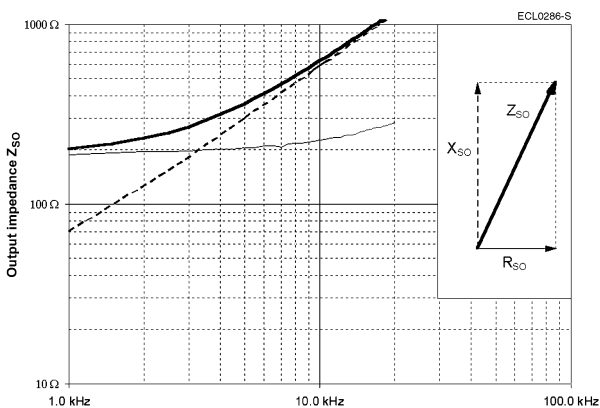

Tolerance: $\pm 15 \%$

Z_{SS} ... Impedance between S1 and S3 in a position of 0° (max. coupling) with short circuits between R1 and R2

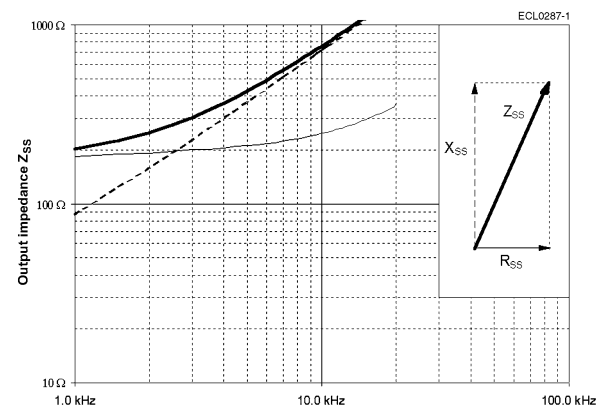

Inductance L

$L = X / (2 \cdot \pi \cdot f)$
 at $f = 10 \text{ kHz}$

$L_{RO} = 8.1 \text{ mH}$
 $L_{SS} = 11.4 \text{ mH}$

Housing	Aluminum	V23401-T2014-B2..
	CrNi-steel	V23401-H2014-B2..

Electrical error / Ordering information

Angular error spread $\Delta\phi$	Ordering code	
	Aluminum housing	CrNi-steel housing
	$\pm 20'$	V23401-T2014-B214
	$\pm 15'$	V23401-H2014-B214
	$\pm 10'$	V23401-T2014-B222
$\pm 10'$	V23401-H2014-B222	
$\pm 7'$	V23401-T2014-B201	
	V23401-H2014-B201	
	V23401-T2014-B202	
	V23401-H2014-B202	
Residual voltage $V_{residual}$	20 mV at $V_{R1-R2} = 6 V$	

Electrical data at 22 °C.

Transfer function

Pairs of poles p	$p = 4$
<p>Transformation ratio r_T</p> $r_T = V_{S1-S3 \max} / V_{R1-R2}$ $= V_{S2-S4 \max} / V_{R1-R2}$ <p>$= 0.46 \pm 10 \% \text{ within } 4 \dots 15 \text{ kHz}$ $= 0.46 \pm 5 \% \text{ at } 6 \text{ kHz}$</p>	
<p>Phase shift ψ</p> $V_{R1-R2}(t) = V_{R1-R2 \max} \cdot \sin(2 \cdot \pi \cdot f \cdot t)$ $V_{S1-S3}(t) = V_{S1-S3 \max} \cdot \sin(2 \cdot \pi \cdot f \cdot t - \psi)$ <p>for $-90^\circ < \alpha < +90^\circ$</p> <p>Tolerance: $\pm 5^\circ$</p>	

Size 21

Resistance, impedance and operating parameters

Input voltage V_{R1-R2}, typical	$2 V_{rms} \dots 10 V_{rms}$
Frequency f, typical	4 kHz ... 15 kHz

When choosing the values of these parameters take into account power dissipation, max. ambient temperature and the heat dissipation. Including self heating a maximum operating temperature of 150 °C must not be exceeded. Generally a power dissipation of $P \leq 0.5 \text{ W}$ is not critical.

Input current I

The adjacent figure applies to $V_{R1-R2} = 6 \text{ V}$.

For other input voltages, the input current changes follows as:

$$I = I_{\text{Figure}} \cdot V_{R1-R2} / 6 \text{ V}$$

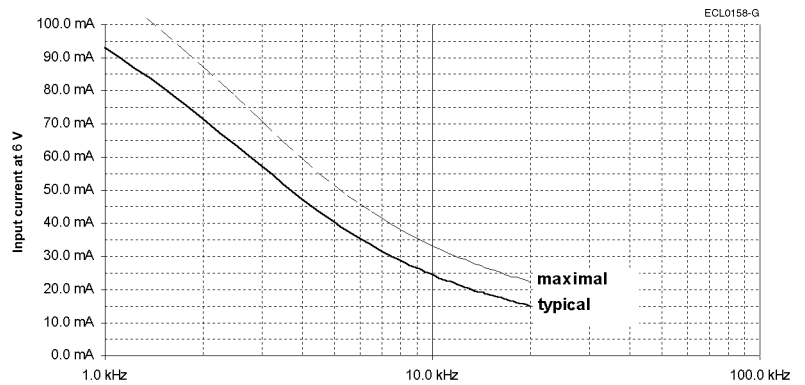

Power consumption P

The adjacent figure applies to $V_{R1-R2} = 6 \text{ V}$.

For other input voltages, the power consumption changes follows as:

$$P = P_{\text{Figure}} \cdot (V_{R1-R2} / 6 \text{ V})^2$$

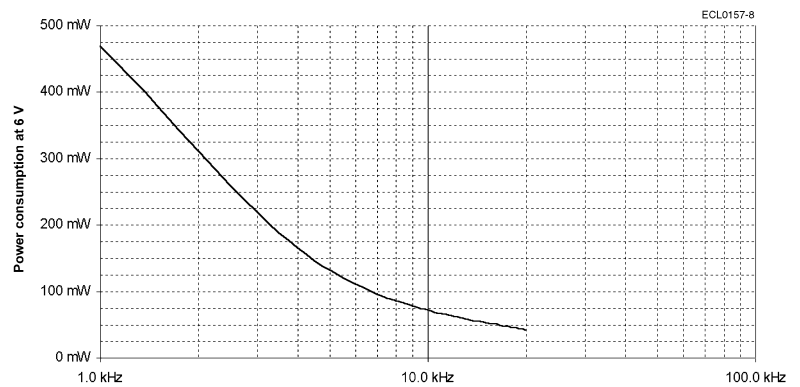

Resistance, impedance and operating parameters (continued)

DC resistance

The ohmic resistance values are based on an ambient temperature of 22 °C and change with temperature by 0.39 % / K

$R_{R1-R2} = 36 \Omega$
 $R_{S1-S3} = R_{S2-S4} = 48 \Omega$
 Tolerance: $\pm 10 \%$

Input impedance

Tolerance: $\pm 15 \%$

Z_{RO} ... Impedance between R1 and R2 with open outputs

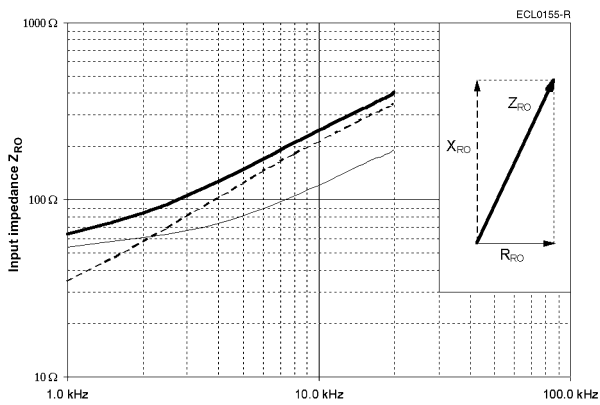

Tolerance: $\pm 15 \%$

Z_{RS} ... Impedance between R1 and R2 with short circuits between S1 and S3 as well as between S2 and S4

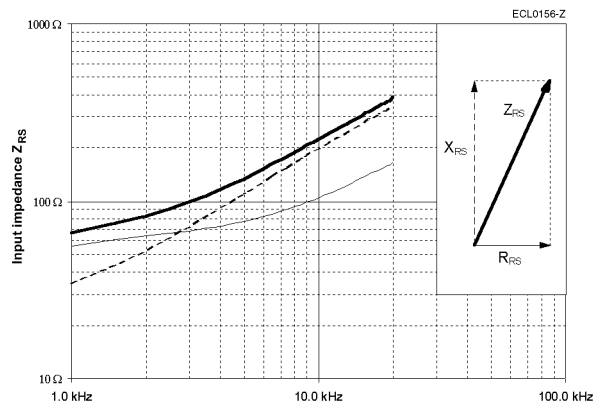

Output impedance

Tolerance: $\pm 15 \%$

Z_{SO} ... Impedance between S2 and S4 in a position of 0° (minimal coupling) with open outputs

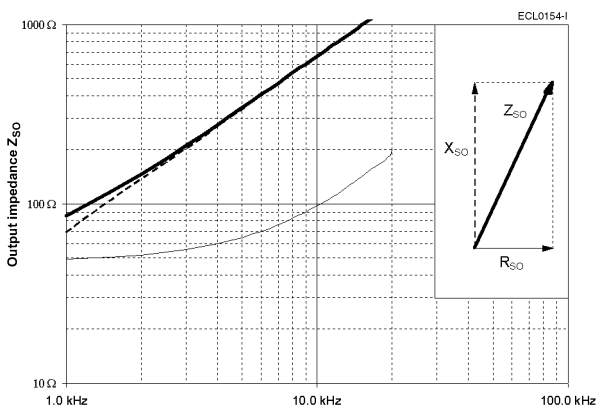

Tolerance: $\pm 15 \%$

Z_{SS} ... Impedance between S1 and S3 in a position of 0° (max. coupling) with short circuits between R1 and R2

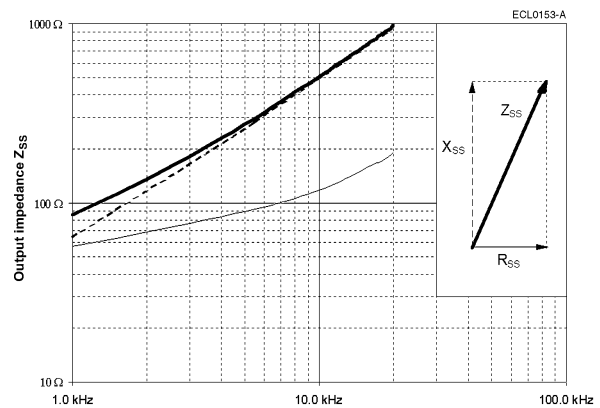

Inductance L

$L = X / (2 \cdot \pi \cdot f)$
 at $f = 10 \text{ kHz}$

$L_{RO} = 3.4 \text{ mH}$
 $L_{SS} = 7.8 \text{ mH}$

Housing	Aluminum	V23401-T 2015-B2..
	CrNi-steel	V23401-H 2015-B2..

Electrical error / Ordering information

Angular error spread $\Delta\phi$	Ordering code	
	Aluminum housing	CrNi-steel housing
	$\pm 20'$	V23401-T2015-B214
	$\pm 15'$	V23401-H2015-B214
	$\pm 10'$	V23401-T2015-B222
$\pm 10'$	V23401-H2015-B222	
$\pm 7'$	V23401-T2015-B201	
	V23401-H2015-B201	
	V23401-T2015-B202	
	V23401-H2015-B202	
Residual voltage V_{residual}	21 mV at $V_{R1-R2} = 6\text{ V}$	

Electrical data at 22 °C.

Transfer function

Pairs of poles p	$p = 2$
<p>Transformation ratio r_T</p> $r_T = V_{S1-S3 \text{ max}} / V_{R1-R2}$ $= V_{S2-S4 \text{ max}} / V_{R1-R2}$ <p>= 0.5 \pm 10 % within 4 ... 20 kHz = 0.5 \pm 5 % at 10 kHz</p>	
<p>Phase shift ψ</p> $V_{R1-R2}(t) = V_{R1-R2 \text{ max}} \cdot \sin(2 \cdot \pi \cdot f \cdot t)$ $V_{S1-S3}(t) = V_{S1-S3 \text{ max}} \cdot \sin(2 \cdot \pi \cdot f \cdot t - \psi)$ <p>for $-90^\circ < \alpha < +90^\circ$</p> <p>Tolerance: $\pm 5^\circ$</p>	

Resistance, impedance and operating parameters

Input voltage V_{R1-R2}, typical	$2 V_{rms} \dots 10 V_{rms}$
Frequency f, typical	4 kHz ... 15 kHz

When choosing the values of these parameters take into account power dissipation, max. ambient temperature and the heat dissipation. Including self heating a maximum operating temperature of 150 °C must not be exceeded. Generally a power dissipation of $P \leq 0.5 \text{ W}$ is not critical.

Input current I

The adjacent figure applies to $V_{R1-R2} = 6 \text{ V}$.

For other input voltages, the input current changes follows as:

$$I = I_{\text{Figure}} \cdot V_{R1-R2} / 6 \text{ V}$$

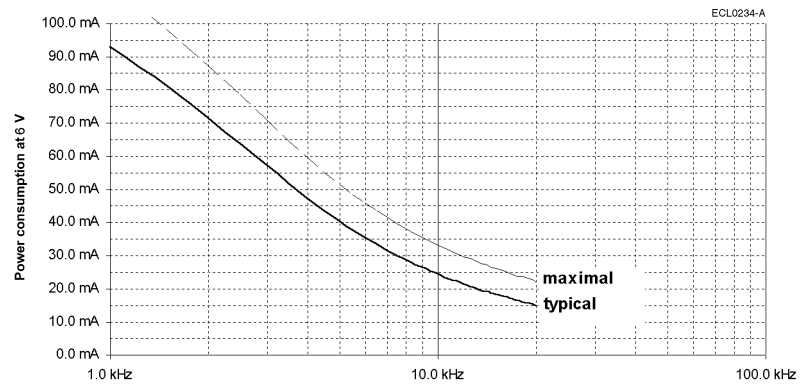

Power consumption P

The adjacent figure applies to $V_{R1-R2} = 6 \text{ V}$.

For other input voltages, the power consumption changes follows as:

$$P = P_{\text{Figure}} \cdot (V_{R1-R2} / 6 \text{ V})^2$$

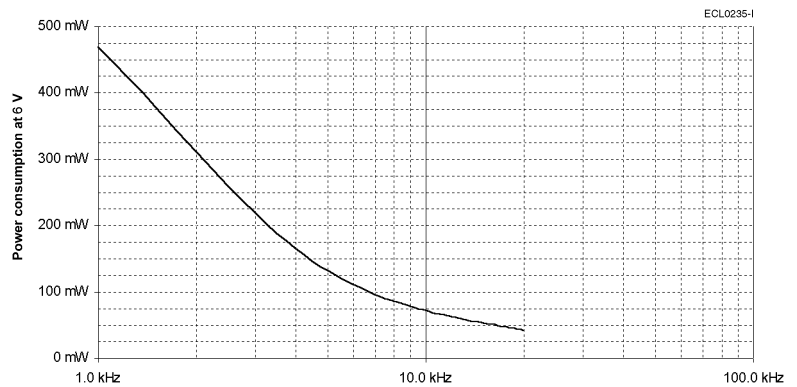

Resistance, impedance and operating parameters (continued)

DC resistance

The ohmic resistance values are based on an ambient temperature of 22 °C and change with temperature by 0.39 % / K

$R_{R1-R2} = 33 \Omega$
 $R_{S1-S3} = R_{S2-S4} = 30 \Omega$
 Tolerance: $\pm 10 \%$

Input impedance

Tolerance: $\pm 15 \%$

Z_{RO} ... Impedance between R1 and R2 with open outputs

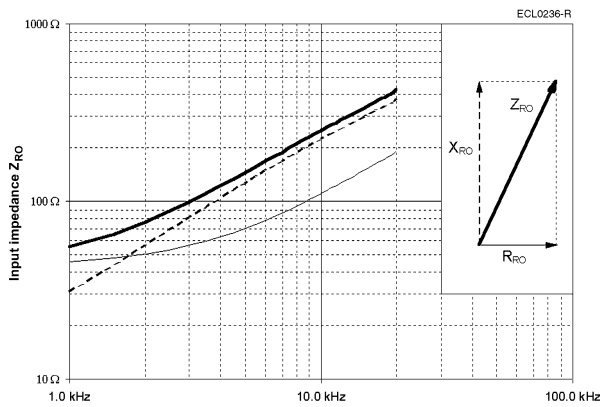

Tolerance: $\pm 15 \%$

Z_{RS} ... Impedance between R1 and R2 with short circuits between S1 and S3 as well as between S2 and S4

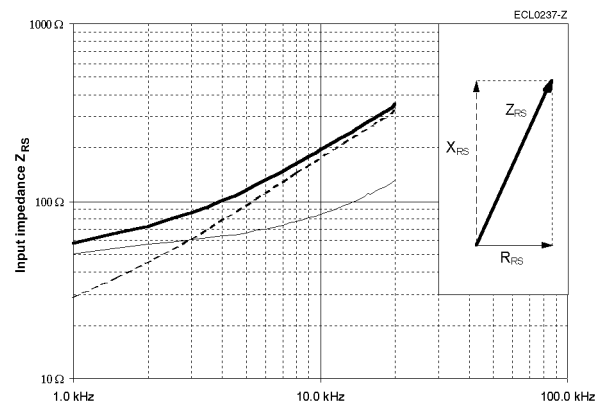

Output impedance

Tolerance: $\pm 15 \%$

Z_{SO} ... Impedance between S2 and S4 in a position of 0° (minimal coupling) with open outputs

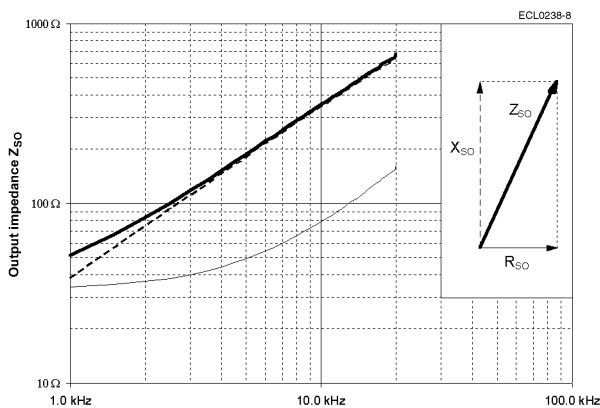

Tolerance: $\pm 15 \%$

Z_{SS} ... Impedance between S1 and S3 in a position of 0° (max. coupling) with short circuits between R1 and R2

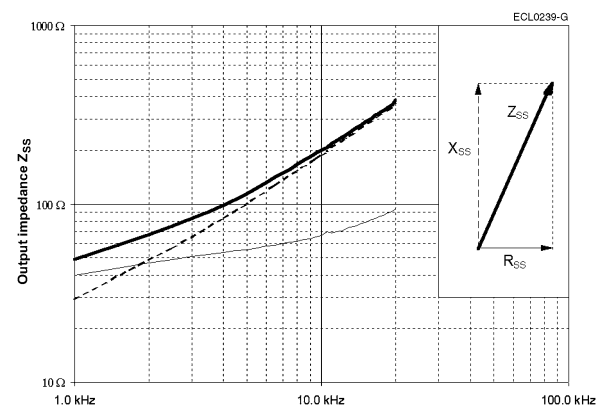

Inductance L

$L = X / (2 \cdot \pi \cdot f)$
 at $f = 10 \text{ kHz}$

$L_{RO} = 3.6 \text{ mH}$
 $L_{SS} = 3.0 \text{ mH}$

Housing CrMo-steel

Electrical error / Ordering information

Angular error spread $\Delta\phi$ $\pm 10'$ $\pm 8'$ $\pm 6'$ $\pm 4'$	Ordering code V23401-U1016-B101 V23401-U1016-B109 V23401-U1016-B110 V23401-U1016-B133
Residual voltage V_{residual}	14 mV at $V_{R1-R2} = 4 \text{ V}$

Electrical data at 22 °C.

Transfer function

Pairs of poles p $p = 1$

Transformation ratio r_T

$$r_T = \frac{V_{S1-S3 \text{ max}}}{V_{R1-R2}}$$

$$= \frac{V_{S2-S4 \text{ max}}}{V_{R1-R2}}$$

$= 0.5 \pm 20 \% \text{ within } 1.5 \dots 10 \text{ kHz}$
 $= 0.5 \pm 10 \% \text{ at } 5 \text{ kHz}$

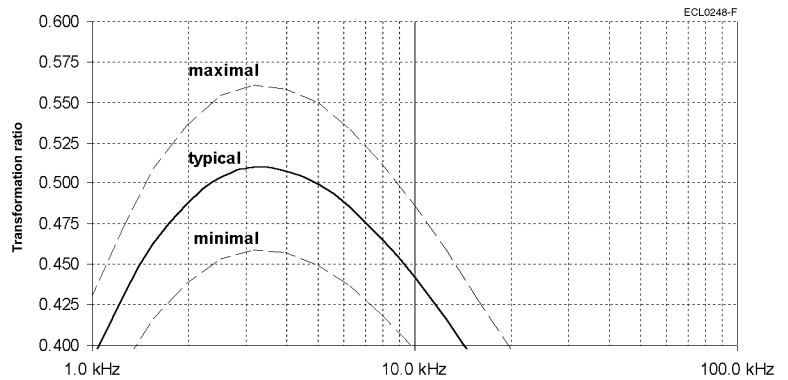

Phase shift ψ

$$V_{R1-R2}(t) = V_{R1-R2 \text{ max}} \cdot \sin(2 \cdot \pi \cdot f \cdot t)$$

$$V_{S1-S3}(t) = V_{S1-S3 \text{ max}} \cdot \sin(2 \cdot \pi \cdot f \cdot t - \psi)$$

for $-90^\circ < \alpha < +90^\circ$

Tolerance: $\pm 5^\circ$

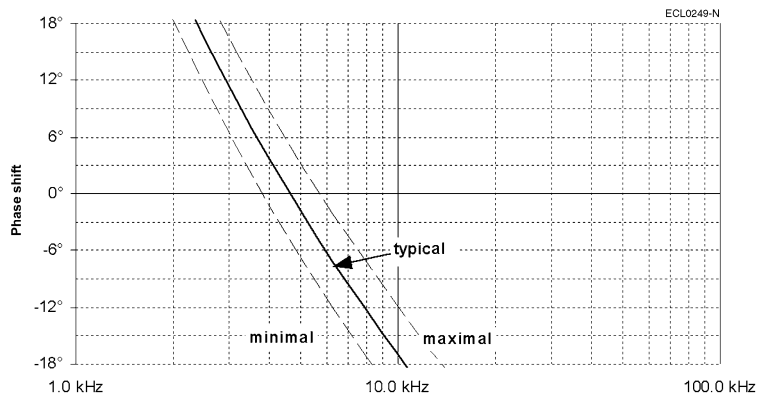

Resistance, impedance and operating parameters

Input voltage V_{R1-R2}, typical	$2 V_{rms} \dots 20 V_{rms}$	When choosing the values of these parameters take into account power dissipation, max. ambient temperature and the heat dissipation. Including self heating a maximum operating temperature of 150 °C must not be exceeded. Generally a power dissipation of $P \leq 0.5 W$ is not critical.
Frequency f, typical	2 kHz ... 10 kHz	

Input current I

The adjacent figure applies to $V_{R1-R2} = 4 V$.

For other input voltages, the input current changes follows as:

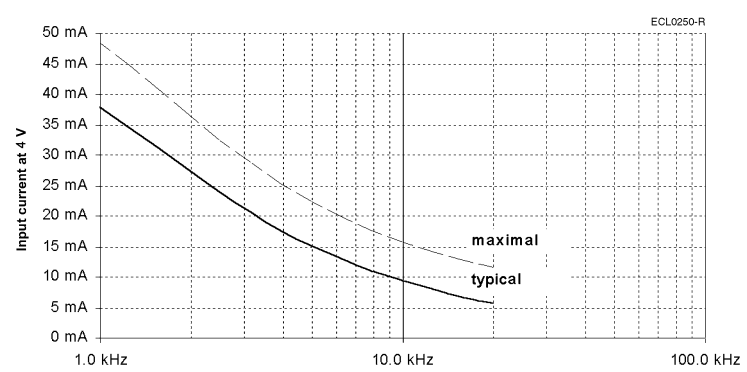
$$I = I_{Figure} \cdot V_{R1-R2} / 4 V$$

Power consumption P

The adjacent figure applies to $V_{R1-R2} = 4 V$.

For other input voltages, the power consumption changes follows as:

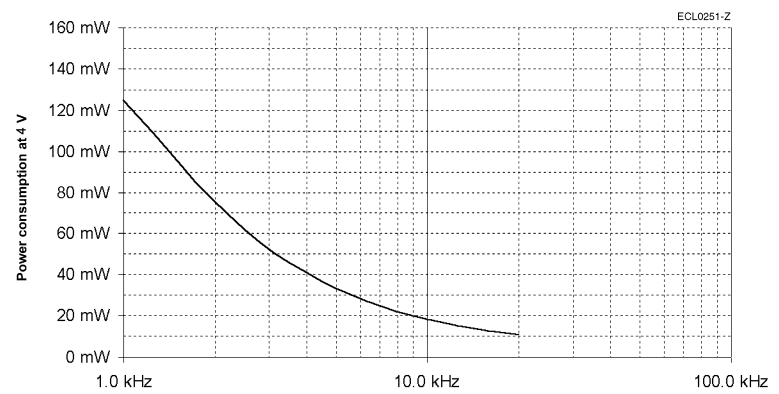
$$P = P_{Figure} \cdot (V_{R1-R2} / 4 V)^2$$

Resistance, impedance and operating parameters (continued)

DC resistance

The ohmic resistance values are based on an ambient temperature of 22 °C and change with temperature by 0.39 % / K

$R_{R1-R2} = 65 \Omega$
 $R_{S1-S3} = R_{S2-S4} = 81 \Omega$
 Tolerance: $\pm 15 \%$

Input impedance

Tolerance: $\pm 20 \%$

Z_{RO} ... Impedance between R1 and R2 with open outputs

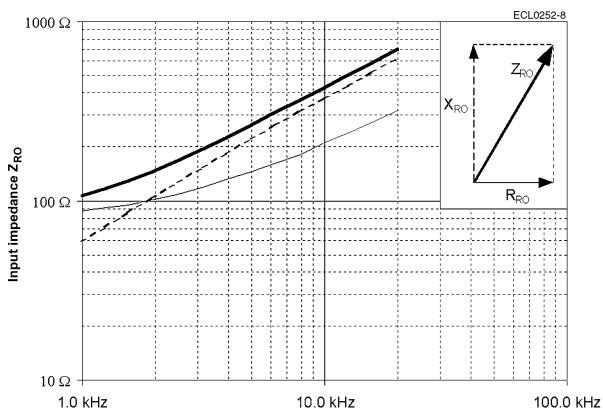

Tolerance: $\pm 20 \%$

Z_{RS} ... Impedance between R1 and R2 with short circuits between S1 and S3 as well as between S2 and S4

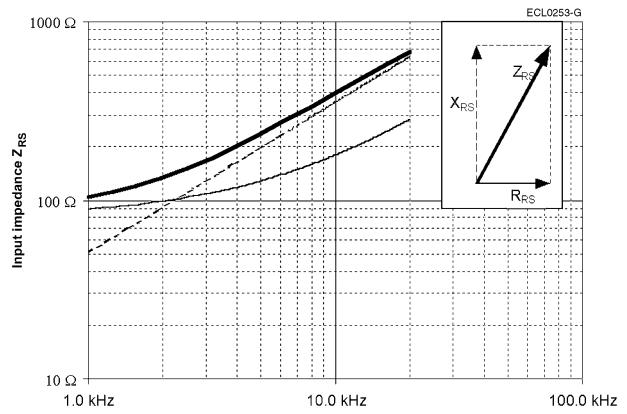

Output impedance

Tolerance: $\pm 20 \%$

Z_{SO} ... Impedance between S2 and S4 in a position of 0° (minimal coupling) with open outputs

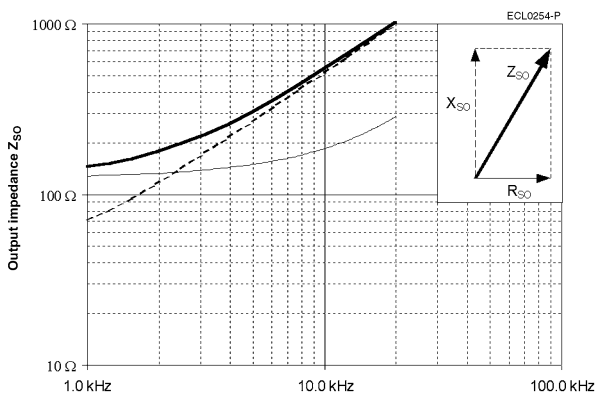

Tolerance: $\pm 20 \%$

Z_{SS} ... Impedance between S1 and S3 in a position of 0° (max. coupling) with short circuits between R1 and R2

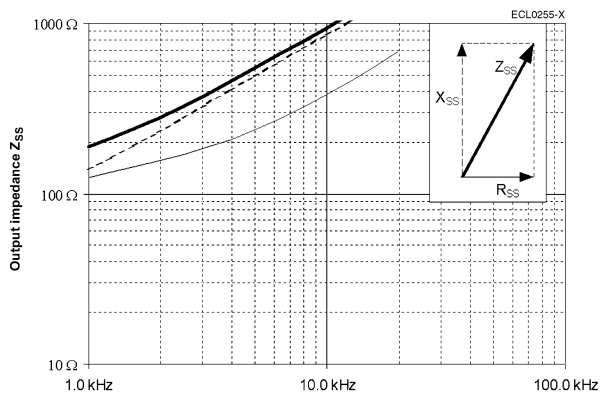

Inductance L

$L = X / (2 \cdot \pi \cdot f)$
 at $f = 5 \text{ kHz}$

$L_{RO} = 6 \text{ mH}$
 $L_{SS} = 13 \text{ mH}$

Housing

CrMo-steel

Electrical error / Ordering information

Angular error spread $\Delta\phi$
 $\pm 10'$
 $\pm 7'$
 $\pm 4'$

Ordering code
 V23401-U2017-B201
 V23401-U2017-B202
 V23401-U2017-B233

Residual voltage V_{residual}

18 mV at $V_{R1-R2} = 5 \text{ V}$

Electrical data at 22 °C.

Transfer function

Pairs of poles p

$p = 1$

Transformation ratio r_T

$$r_T = \frac{V_{S1-S3 \text{ max}}}{V_{R1-R2}}$$

$$= \frac{V_{S2-S4 \text{ max}}}{V_{R1-R2}}$$

$= 0.5 \pm 20 \%$ within 1 ... 10 kHz
 $= 0.5 \pm 10 \%$ at 4 kHz

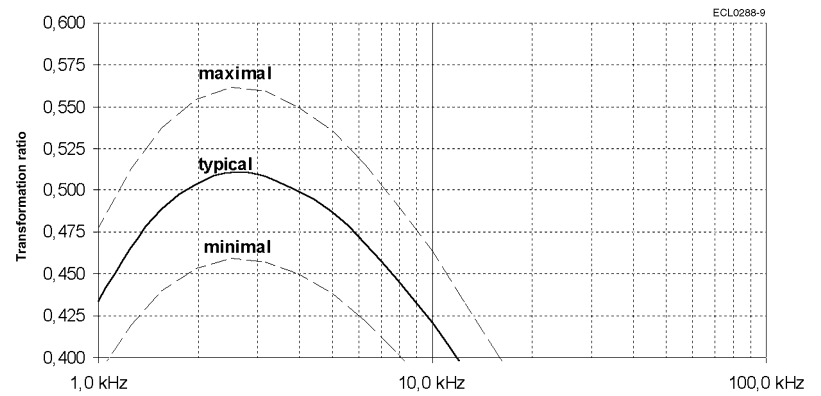

Phase shift ψ

$$V_{R1-R2}(t) = V_{R1-R2 \text{ max}} \cdot \sin(2 \cdot \pi \cdot f \cdot t)$$

$$V_{S1-S3}(t) = V_{S1-S3 \text{ max}} \cdot \sin(2 \cdot \pi \cdot f \cdot t - \psi)$$

for $-90^\circ < \alpha < +90^\circ$

Tolerance: $\pm 5^\circ$

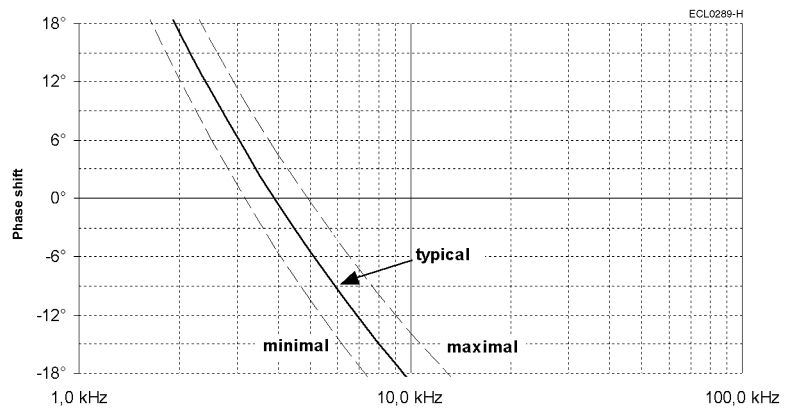

Resistance, impedance and operating parameters

Input voltage V_{R1-R2}, typical	4 V_{rms} ... 20 V_{rms}
Frequency f, typical	2 kHz ... 10 kHz

When choosing the values of these parameters take into account power dissipation, max. ambient temperature and the heat dissipation. Including self heating a maximum operating temperature of 150 °C must not be exceeded. Generally a power dissipation of $P \leq 0.5$ W is not critical.

Input current I

The adjacent figure applies to $V_{R1-R2} = 5$ V.

For other input voltages, the input current changes follows as:

$$I = I_{Figure} \cdot V_{R1-R2} / 5$$

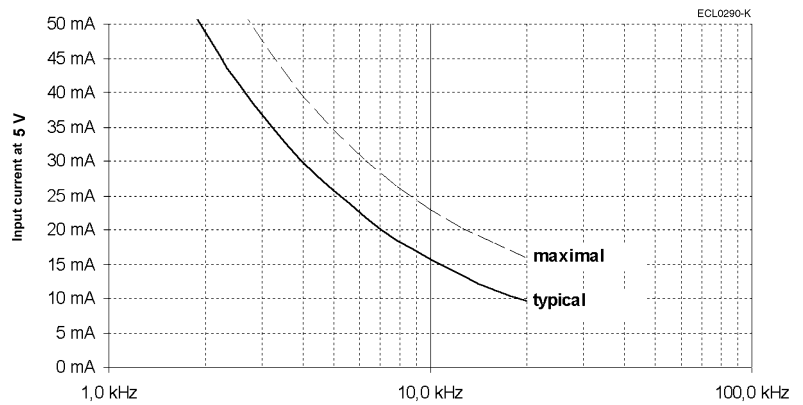

Power consumption P

The adjacent figure applies to $V_{R1-R2} = 5$ V.

For other input voltages, the power consumption changes follows as:

$$P = P_{Figure} \cdot (V_{R1-R2} / 5)^2$$

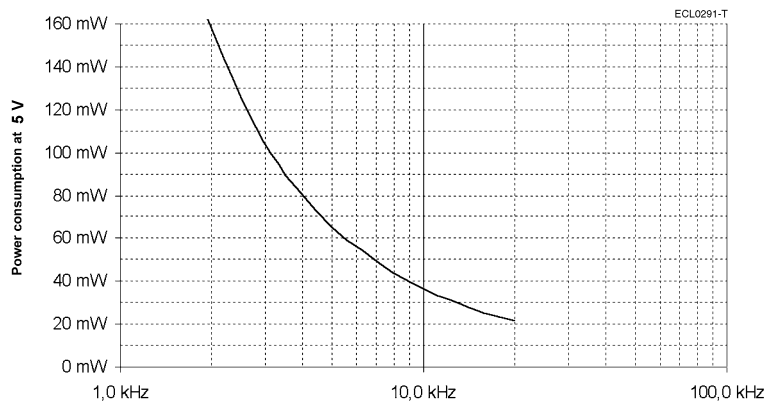

Resistance, impedance and operating parameters (continued)

DC resistance

The ohmic resistance values are based on an ambient temperature of 22 °C and change with temperature by 0.39 % / K

$R_{R1-R2} = 36 \Omega$
 $R_{S1-S3} = R_{S2-S4} = 56 \Omega$
 Tolerance: $\pm 15 \%$

Input impedance

Tolerance: $\pm 20 \%$

Z_{RO} ... Impedance between R1 and R2 with open outputs

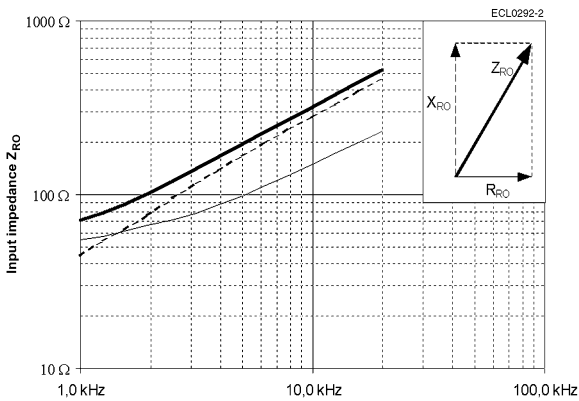

Tolerance: $\pm 20 \%$

Z_{RS} ... Impedance between R1 and R2 with short circuits between S1 and S3 as well as between S2 and S4

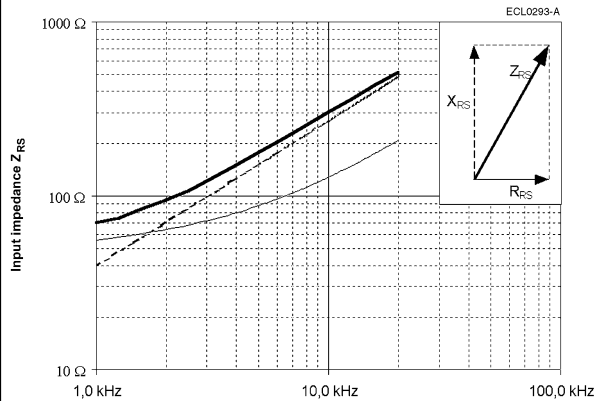

Output impedance

Tolerance: $\pm 20 \%$

Z_{SO} ... Impedance between S2 and S4 in a position of 0° (minimal coupling) with open outputs

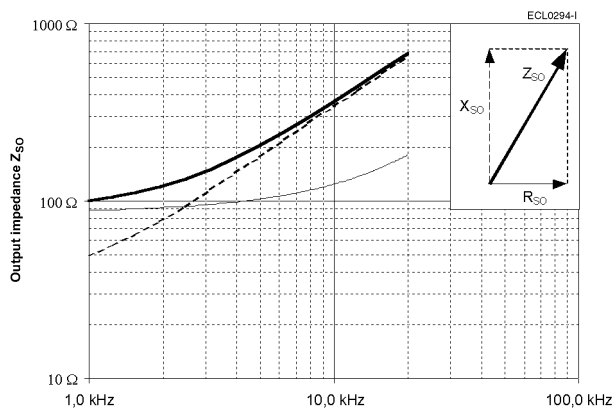

Tolerance: $\pm 20 \%$

Z_{SS} ... Impedance between S1 and S3 in a position of 0° (max. coupling) with short circuits between R1 and R2

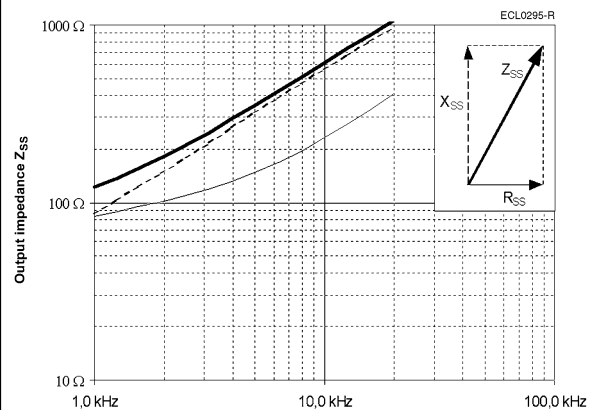

Inductance L

$L = X / (2 \cdot \pi \cdot f)$
 at $f = 4 \text{ kHz}$

$L_{RO} = 5.5 \text{ mH}$
 $L_{SS} = 10.5 \text{ mH}$

Housing

CrMo-steel

Electrical error / Ordering information

Angular error spread $\Delta\phi$
 $\pm 10'$
 $\pm 8'$
 $\pm 6'$

Ordering code
 V23401-U2020-B201
 V23401-U2020-B209
 V23401-U2020-B210

Residual voltage V_{residual}

20 mV at $V_{R1-R2} = 6\text{ V}$

Electrical data at 22 °C.

Transfer function

Pairs of poles p

$p = 3$

Transformation ratio r_T

$$r_T = V_{S1-S3 \text{ max}} / V_{R1-R2}$$

$$= V_{S2-S4 \text{ max}} / V_{R1-R2}$$

$= 0.5 \pm 10\%$ within 3 ... 10 kHz
 $= 0.5 \pm 5\%$ at 6 kHz

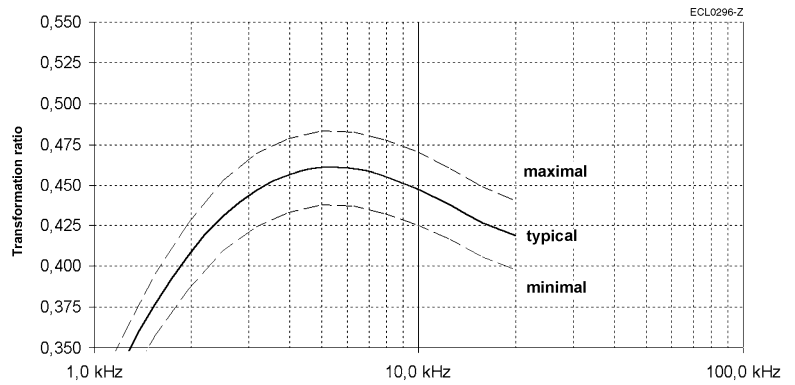

Phase shift ψ

$$V_{R1-R2}(t) = V_{R1-R2 \text{ max}} \cdot \sin(2 \cdot \pi \cdot f \cdot t)$$

$$V_{S1-S3}(t) = V_{S1-S3 \text{ max}} \cdot \sin(2 \cdot \pi \cdot f \cdot t - \psi)$$

for $-90^\circ < \alpha < +90^\circ$

Tolerance: $\pm 5^\circ$

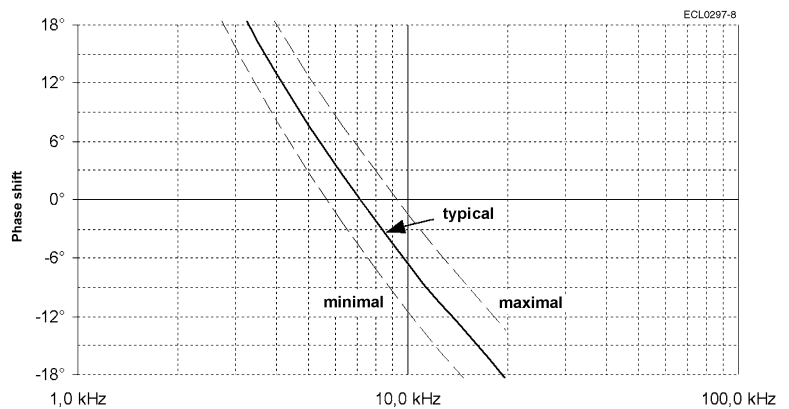

Resistance, impedance and operating parameters

Input voltage V_{R1-R2}, typical	$2 V_{rms} \dots 10 V_{rms}$
Frequency f, typical	4 kHz ... 10 kHz

When choosing the values of these parameters take into account power dissipation, max. ambient temperature and the heat dissipation. Including self heating a maximum operating temperature of 150 °C must not be exceeded. Generally a power dissipation of $P \leq 0.5$ W is not critical.

Input current I

The adjacent figure applies to $V_{R1-R2} = 6$ V.

For other input voltages, the input current changes follows as:

$$I = I_{Figure} \cdot V_{R1-R2} / 6$$

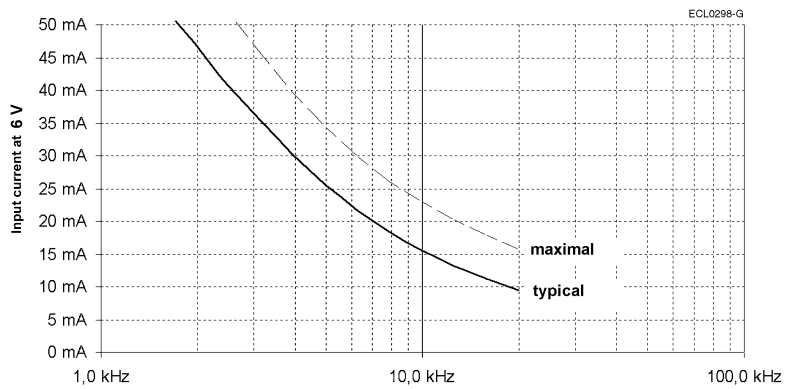

Power consumption P

The adjacent figure applies to $V_{R1-R2} = 6$ V.

For other input voltages, the power consumption changes follows as:

$$P = P_{Figure} \cdot (V_{R1-R2} / 6)^2$$

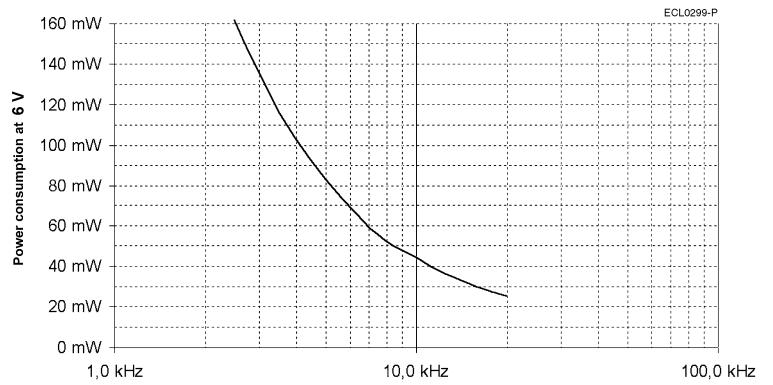

Resistance, impedance and operating parameters (continued)

DC resistance

The ohmic resistance values are based on an ambient temperature of 22 °C and change with temperature by 0.39 % / K

$R_{R1-R2} = 62 \Omega$
 $R_{S1-S3} = R_{S2-S4} = 186 \Omega$
 Tolerance: $\pm 10 \%$

Input impedance

Tolerance: $\pm 15 \%$

Z_{RO} ... Impedance between R1 and R2 with open outputs

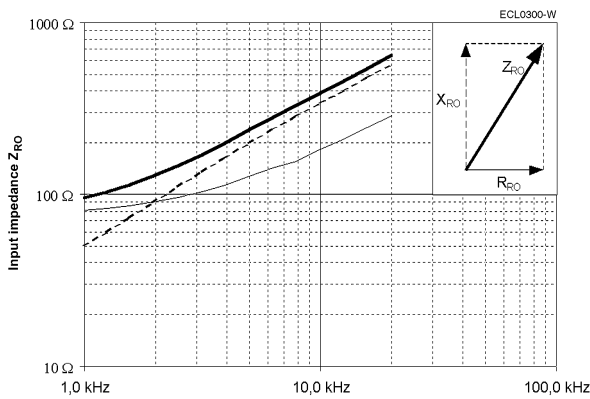

Tolerance: $\pm 15 \%$

Z_{RS} ... Impedance between R1 and R2 with short circuits between S1 and S3 as well as between S2 and S4

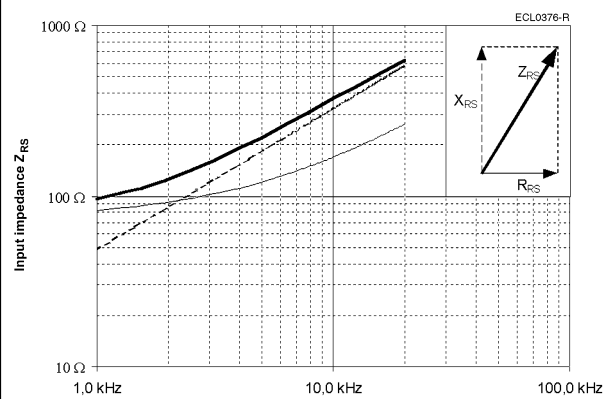

Output impedance

Tolerance: $\pm 15 \%$

Z_{SO} ... Impedance between S2 and S4 in a position of 0° (minimal coupling) with open outputs

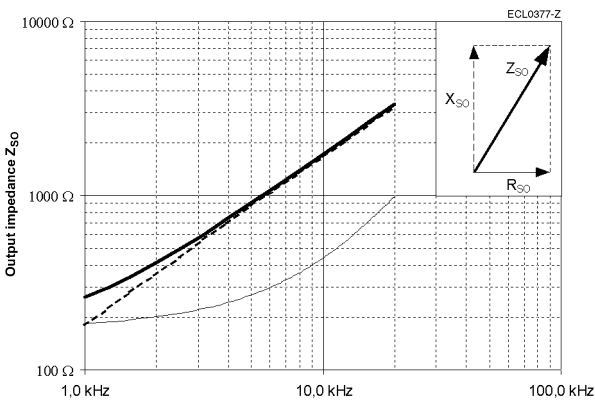

Tolerance: $\pm 15 \%$

Z_{SS} ... Impedance between S1 and S3 in a position of 0° (max. coupling) with short circuits between R1 and R2

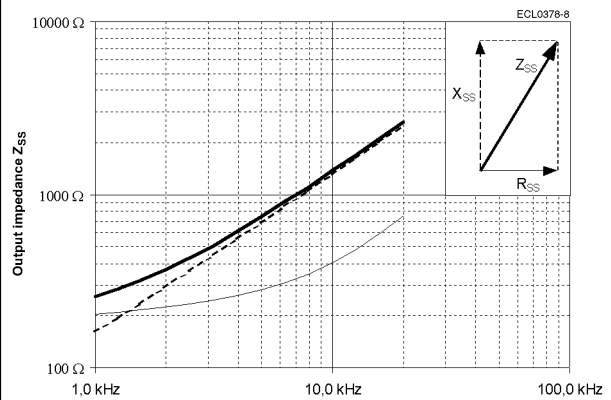

Inductance L

$L = X / (2 \cdot \pi \cdot f)$
 at $f = 6 \text{ kHz}$

$L_{RO} = 4 \text{ mH}$
 $L_{SS} = 14 \text{ mH}$

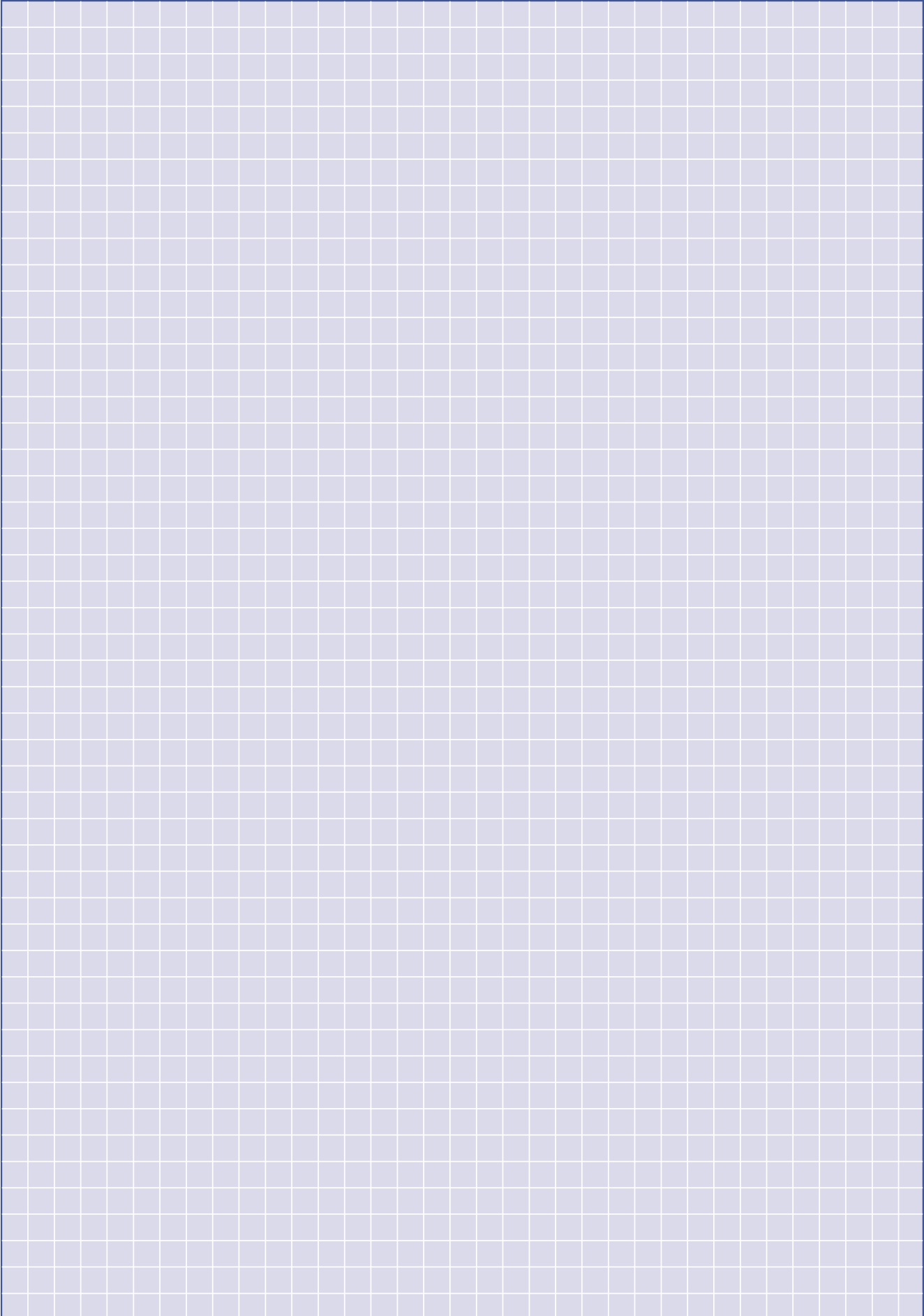

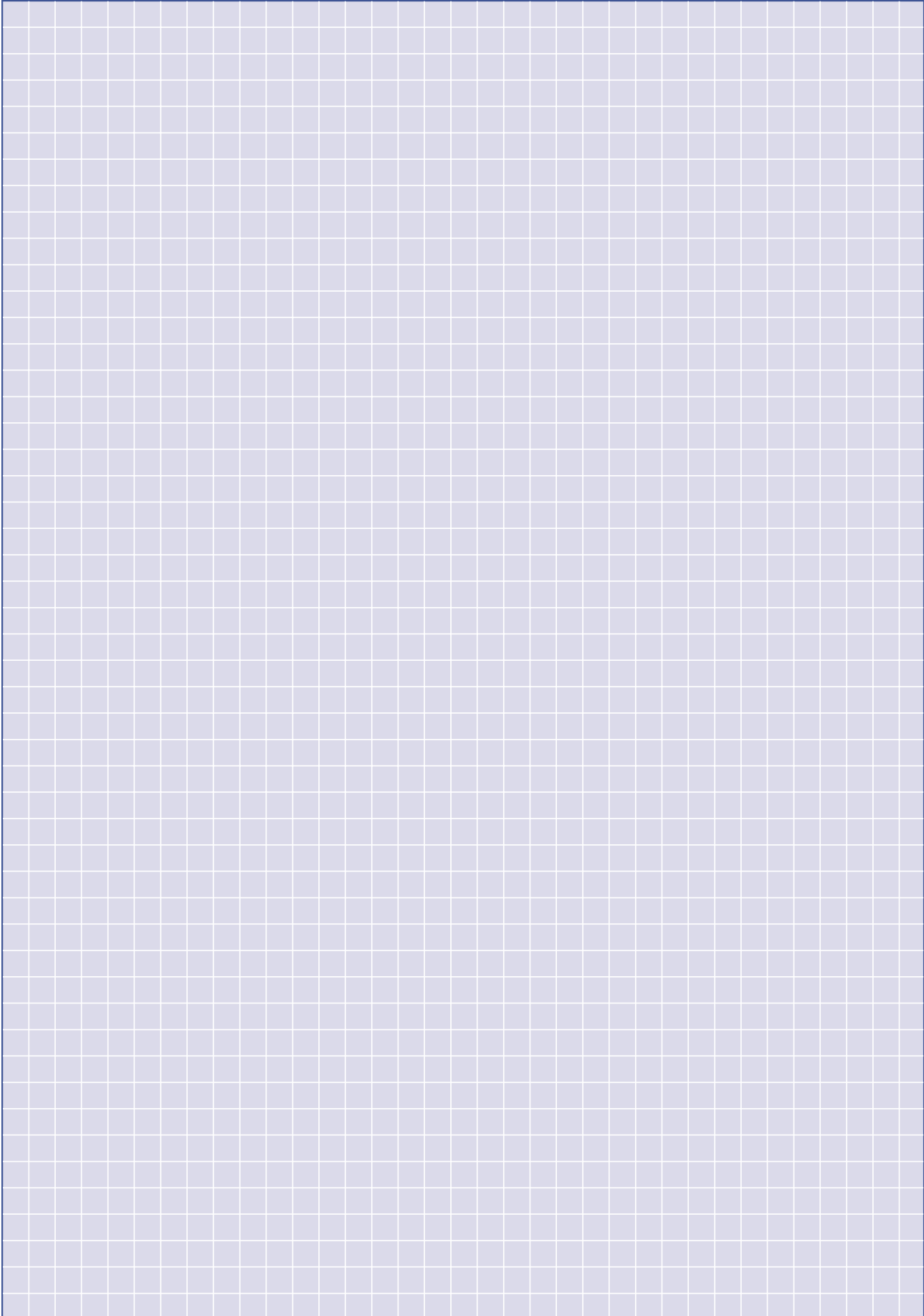

Size 21

Americas

Argentina – Buenos Aires
Phone: +54-1-733-2000
Fax: +54-1-717-0988

Brasil – São Paulo
Phone: +55-11-3611-1311
Fax: +55-11-3611-0397

Canada – Toronto
Phone: +905-475-6222
Fax: +905-474-5520

Chile – Santiago
Phone: +56-2-739-1230
Fax: +56-2-739-1227

Colombia – Bogota
Phone: +57-1-231-9398
Fax: +57-1-240-3769

Mexico – Mexico City
Phone: +52-5-729-0400
Fax: +52-5-361-8545

United States – Harrisburg, PA
Phone: +717-564-0100
Fax: +717-986-7575

Venezuela – Caracas
Phone: +58-2-986-7774
Fax: +58-2-986-9739

For Latin/South American Countries not shown
Phone: +54-11-4733-2015
Fax: +54-11-4733-2083

Asia/Pacific

Australia – Sydney
Phone: +61-2-9840-8200
Fax: +61-2-9899-5649

India – Bangalore
Phone: +91-80-841-0200
Fax: +91-80-841-0210

Indonesia – Jakarta
Phone: +6221-526-7852
Fax: +6221-526-7856

Japan – Kawasaki, Kanagawa
Phone: +81-44-844-8079
Fax: +81-44-844-8733

Korea – Seoul
Phone: +82-2-3274-0535
Fax: +82-2-3274-0524/0531

Malaysia – Selangor
Phone: +60-3-7053055
Fax: +60-3-7053066

New Zealand – Auckland
Phone: +64-9-634-4580
Fax: +64-9-634-4586

Philippines – Makati City
Phone: +632-867-8641
Fax: +632-867-8661

People's Republic of China
Hong Kong
Phone: +852-2735-1628
Fax: +852-2735-0243

Shanghai
Phone: +86-21-6485-0602
Fax: +86-21-6485-0728

Shunde
Phone: +86-765-775-1368
Fax: +86-765-775-2823

Singapore – Singapore
Phone: +65-482-0311
Fax: +65-482-1012

Taiwan – Taipei
Phone: +886-2-2664-9977
Fax: +886-2-2664-9900

Thailand – Bangkok
Phone: +66-2-955-0500
Fax: +66-2-955-0505

Vietnam – Ho Chi Minh City
Phone: +84-8-8232-546/7
Fax: +84-8-8221-443

Europe/Middle East/Africa

Austria – Vienna
Phone: +43-1-90-560-0
Fax: +43-1-90-560-1333

Belgium – Kessel-Lo
Phone: +32-16-352-300
Fax: +32-16-352-352

Bulgaria – Sofia
Phone: +359-2-971-2152
Fax: +359-2-971-2153

Croatia – Zagreb
Phone: +385-1-67-04-46
Fax: +385-1-69-16-04

Czech Republic – Kurim
Phone: +420-5-41-162-111
Fax: +420-5-41-162-223

Denmark – Viby
Phone: +45-86-295-055
Fax: +45-86-295-133

England – Stanmore Middlesex
Phone: +44-181-954-2356
Fax: +44-181-954-6234

Egypt – Cairo
Phone: +20-2-417-76-47
Fax: +20-2-419-23-34

Estonia – Haabneeme
Phone: +372-6205-900
Fax: +372-6205-980

Finland – Helsinki
Phone: +358-9-512-3420
Fax: +358-9-512-34250

France – Cergy-Pontoise Cedex
Phone: +33-1-3420-8888
Fax: +33-1-3420-8600

France Export – St Ouen L'Aumone
Phone: +33-1-3440-7200
Fax: +33-1-3440-7220 or
+33-1-3440-7230

France SIMEL – Gevrey-Chambertin
Phone: +33-3-8058-3200
Fax: +33-3-8034-1015

Germany – Bensheim
Phone: +49-6251-133-0
Fax: +49-6251-133-1600

Germany HTS – Neunkirchen
Phone: +49-2247-305-0
Fax: +49-2247-305-122

Greece – Athens
Phone: +30-1-9370-396/397
Fax: +30-1-9370-655

Hungary – Budapest
Phone: +36-1-289-1000
Fax: +36-1-289-1010

Ireland – Dublin
Phone: +353-1-820-3000
Fax: +353-1-820-9790

Israel – Tel Aviv
Phone: +972-3-649-1482
Fax: +972-3-648-4041

Italy – Collegno (Torino)
Phone: +39-011-4012-111
Fax: +39-011-403-11-16

Lithuania – Vilnius
Phone: +370-2-231-402
Fax: +370-2-231-403

The Netherlands
's-Hertogenbosch
Phone: +31-73-6246-246
Fax: +31-73-6246-935

Norway – Nesbru
Phone: +47-66-77-8899
Fax: +47-66-77-8855

Poland – Warsaw
Phone: +48-22-54-90-888
Fax: +48-22-54-90-880

Portugal – Lisbon
Phone: +351-21-384-58-90
Fax: +351-21-387-71-72

Romania – Bucharest
Phone: +40-1-311-3479 + 3596
Fax: +40-1-312-0574

Russia – Moscow
Phone: +7-095-926-55-06...09
Fax: +7-095-926-55-05

Russia – St. Petersburg
Phone: +7-812-325-30-83
Fax: +7-812-325-32-88

Slovakia – Banská Bystrica
Phone: +421-88-415-20-11/12
Fax: +421-88-415-20-13

Slovenia – Ljubljana
Phone: +386-61-161-3270
Fax: +386-61-161-3240

South Africa – Midrand
Phone: +27-11-314-10-89
Fax: +27-11-314-19-10

Spain – Barcelona
Phone: +34-93-291-0330
Fax: +34-93-201-7879

Sweden – Upplands Väsby
Phone: +46-8-50-72-50-00
Fax: +46-8-50-72-50-01

Switzerland – Steinach
Phone: +41-71-447-0447
Fax: +41-71-447-0444

Turkey – Istanbul
Phone: +90-212-281-8181...3
Fax: +90-212-281-8184

Ukraine – Kiev
Phone: +38-044-238-6908
Fax: +38-044-238-6596



**Tyco Electronics AMP GmbH certified according ISO 9001, QS 9000/VDA 6.1,
ISO 14000 certification is in preparation**

© 2001 Tyco Electronics AMP GmbH · Industrial · Siemensstr. 13 · D-67346 Speyer
Product Information Center: Tel. +49-6251-133-1999, Fax +49-6251-133-1988