

Intellimod™ Module Half Phase IGBT Inverter Output 400 Amperes/1200 Volts

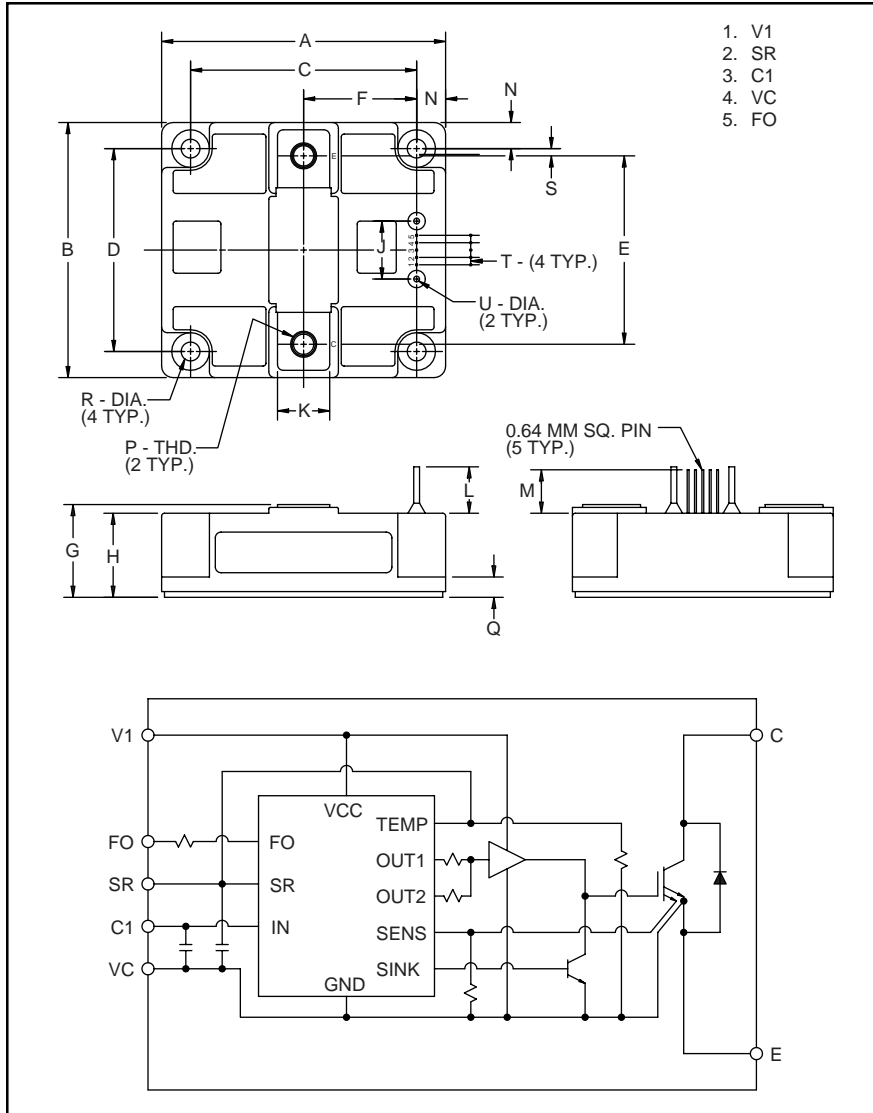

Outline Drawing and Circuit Diagram

Dimensions	Inches	Millimeters
A	3.86	98.0
B	3.46	88.0
C	3.15±0.01	80.0±0.25
D	2.76±0.01	70.0±0.25
E	2.56	65.0
F	1.57	40.0
G	1.34 +0.04/-0.02	34.0 +1.0/-0.5
H	1.16	29.5
J	0.79	20.0
K	0.71	18.0

Dimensions	Inches	Millimeters
L	0.63	16.0
M	0.59	15.0
N	0.35	9.0
P	Metric M8	M8
Q	0.28	7.0
R	0.26 Dia.	Dia. 6.5
S	0.10	2.5
T	0.100	2.54
U	0.08 Dia.	2.0 Dia.



Description:

Powerex Intellimod™ Intelligent Power Modules are isolated base modules designed for power switching applications operating at frequencies to 20kHz. Built-in control circuits provide optimum gate drive and protection for the IGBT and free-wheel diode power devices.

Features:

- Complete Output Power Circuit
- Gate Drive Circuit
- Protection Logic
 - Short Circuit
 - Over Current
 - Over Temperature
 - Under Voltage

Applications:

- Inverters
- UPS
- Motion/Servo Control
- Power Supplies

Ordering Information:

Example: Select the complete part number from the table below -i.e. PM400HSA120 is a 1200V, 400 Ampere Intellimod™ Intelligent Power Module.

Type	Current Rating Amperes	V _{CEs} Volts (x 10)
PM	400	120

PM400HSA120
Intellimod™ Module
Half Phase IGBT Inverter Output
400 Amperes/1200 Volts

Absolute Maximum Ratings, $T_j = 25^\circ\text{C}$ unless otherwise specified

Characteristics	Symbol	PM400HSA120	Units
Power Device Junction Temperature	T_j	-20 to 150	$^\circ\text{C}$
Storage Temperature	T_{stg}	-40 to 125	$^\circ\text{C}$
Case Operating Temperature	T_C	-20 to 100	$^\circ\text{C}$
Mounting Torque, M6 Mounting Screws	—	26	in-lb
Mounting Torque, M8 Main Terminal Screws	—	95	in-lb
Module Weight (Typical)	—	630	Grams
Supply Voltage Protected by OC and SC ($V_D = 13.5 - 16.5\text{V}$, Inverter Part)	$V_{\text{CC(prot.)}}$	800	Volts
Isolation Voltage, AC 1 minute, 60Hz Sinusoidal	V_{RMS}	2500	Volts

Control Sector

Supply Voltage Applied between (V_1-V_C)	V_D	20	Volts
Input Voltage Applied between (C_1-V_C)	V_{CIN}	10	Volts
Fault Output Supply Voltage (Applied between F_O-V_C)	V_{FO}	20	Volts
Fault Output Current	I_{FO}	20	mA

IGBT Inverter Sector

Collector-Emitter Voltage ($V_D = 15\text{V}$, $V_{\text{CIN}} = 5\text{V}$)	V_{CES}	1200	Volts
Collector Current, \pm	I_C	400	Amperes
Peak Collector Current, \pm	I_{CP}	1200	Amperes
Collector Dissipation	P_C	2318	Watts

Electrical and Mechanical Characteristics, $T_j = 25^\circ\text{C}$ unless otherwise specified

Characteristics	Symbol	Test Conditions	Min.	Typ.	Max.	Units
Control Sector						
Over Current Trip Level Inverter Part	OC	$-20^\circ\text{C} \leq T_j \leq 125^\circ\text{C}$	480	650	—	Amperes
Short Circuit Trip Level Inverter Part	SC	$-20^\circ\text{C} \leq T_j \leq 125^\circ\text{C}$	650	930	—	Amperes
Over Current Delay Time	$t_{\text{off(OC)}}$	$V_D = 15\text{V}$	—	5	—	μS
Over Temperature Protection	OT	Trip Level	100	110	120	$^\circ\text{C}$
	OT_R	Reset Level	85	95	105	$^\circ\text{C}$
Supply Circuit Under Voltage Protection	UV	Trip Level	11.5	12.0	12.5	Volts
	UV_R	Reset Level	—	12.5	—	Volts
Supply Voltage	V_D	Applied between V_1-V_C	13.5	15	16.5	Volts
Circuit Current	I_D	$V_D = 15\text{V}$, $V_{\text{CIN}} = 5\text{V}$, V_1-V_C	—	23	30	mA
Input ON Threshold Voltage	$V_{\text{CIN(on)}}$	Applied between C_1-V_C	1.2	1.5	1.8	Volts
Input OFF Threshold Voltage	$V_{\text{CIN(off)}}$	Applied between C_1-V_C	1.7	2.0	2.3	Volts
PWM Input Frequency	f_{PWM}	3- \emptyset Sinusoidal	—	15	20	kHz
Fault Output Current	$I_{\text{FO(H)}}$	$V_D = 15\text{V}$, $V_{\text{FO}} = 15\text{V}$	—	—	0.01	mA
	$I_{\text{FO(L)}}$	$V_D = 15\text{V}$, $V_{\text{FO}} = 15\text{V}$	—	10	15	mA
Minimum Fault Output Pulse Width	t_{FO}	$V_D = 15\text{V}$	1.0	1.8	—	mS
SXR Terminal Output Voltage	V_{SXR}	$T_j \leq 125^\circ\text{C}$, $R_{\text{in}} = 6.8\text{ k}\Omega$	4.5	5.1	5.6	Volts



Powerex, Inc., 200 Hillis Street, Youngwood, Pennsylvania 15697-1800 (724) 925-7272

PM400HSA120
Intellimod™ Module
Half Phase IGBT Inverter Output
400 Amperes/1200 Volts

Electrical and Mechanical Characteristics, $T_j = 25^\circ\text{C}$ unless otherwise specified

Characteristics	Symbol	Test Conditions	Min.	Typ.	Max.	Units
IGBT Inverter Sector						
Collector Cutoff Current	I_{CEX}	$V_{CE} = V_{CES}, T_j = 25^\circ\text{C}$	—	—	1.0	mA
		$V_{CE} = V_{CES}, T_j = 125^\circ\text{C}$	—	—	10	mA
Diode Forward Voltage	V_{FM}	$-I_C = 400\text{A}, V_D = 15\text{V}, V_{CIN} = 5\text{V}$	—	2.5	3.5	Volts
Collector-Emitter Saturation Voltage	$V_{CE(sat)}$	$V_D = 15\text{V}, V_{CIN} = 0\text{V}, I_C = 400\text{A}, T_j = 25^\circ\text{C}, \text{Pulsed}$	—	2.3	3.2	Volts
		$V_D = 15\text{V}, V_{CIN} = 0\text{V}, I_C = 400\text{A}, T_j = 125^\circ\text{C}, \text{Pulsed}$	—	2.1	2.9	Volts
Inductive Load Switching Times	t_{on}	$V_D = 15\text{V}, V_{CIN} = 0 \sim 5\text{V}$ $V_{CC} = 600\text{V}, I_C = 400\text{A}$ $T_j = 125^\circ\text{C}$	0.5	1.4	2.5	μS
	t_{rr}		—	0.2	0.4	μS
	$t_{C(on)}$		—	0.4	1.0	μS
	t_{off}		—	3.0	4.0	μS
	$t_{C(off)}$		—	0.6	1.1	μS

Thermal Characteristics

Characteristic	Symbol	Condition	Min.	Typ.	Max.	Units
Junction to Case Thermal Resistance	$R_{th(j-c)Q}$	Each IGBT	—	—	0.054	$^\circ\text{C/Watt}$
	$R_{th(j-c)D}$	Each FWDi	—	—	0.10	$^\circ\text{C/Watt}$
Contact Thermal Resistance	$R_{th(c-f)}$	Case to Fin Per Module, Thermal Grease Applied	—	—	0.038	$^\circ\text{C/Watt}$

Recommended Conditions for Use

Characteristic	Symbol	Condition	Value	Units
Supply Voltage	V_{CC}	Applied across C1-E2 Terminals	0 ~ 800	Volts
	V_D	Applied between V_1-V_C	15 ± 1.5	Volts
Input ON Voltage	$V_{CIN(on)}$	Applied between C_1-V_C	0 ~ 0.8	Volts
Input OFF Voltage	$V_{CIN(off)}$	Applied between C_1-V_C	$4.0 \sim V_{SXR}$	Volts
PWM Input Frequency	f_{PWM}	Using Application Circuit	5 ~ 20	kHz
Minimum Dead Time	t_{DEAD}	Input Signal	≥ 4.0	μS

PM400HSA120
Intellimod™ Module
Half Phase IGBT Inverter Output
 400 Amperes/1200 Volts

SATURATION VOLTAGE CHARACTERISTICS (TYPICAL)

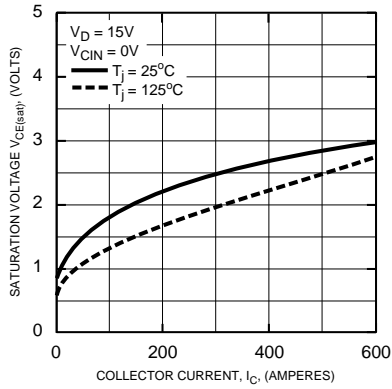

COLLECTOR-EMITTER SATURATION VOLTAGE CHARACTERISTICS (TYPICAL)

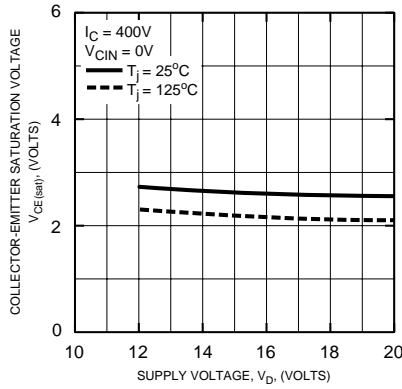

OUTPUT CHARACTERISTICS (TYPICAL)

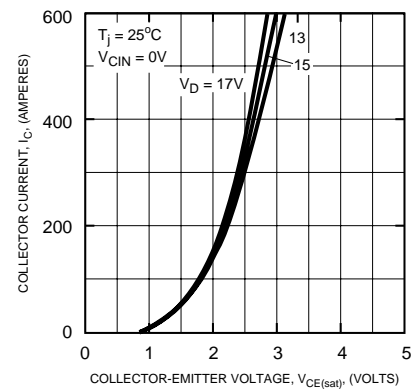

SWITCHING TIME VS. COLLECTOR CURRENT (TYPICAL)

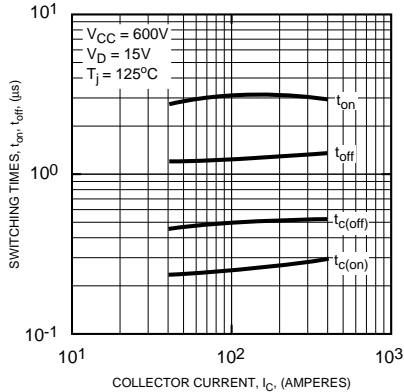

REVERSE RECOVERY CURRENT VS. COLLECTOR CURRENT (TYPICAL)

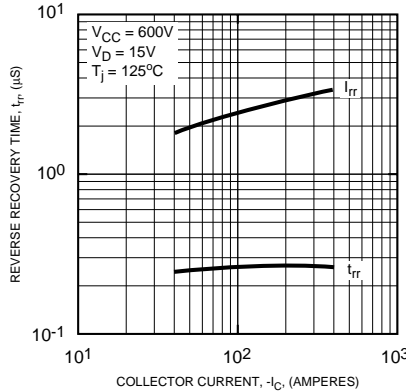

DIODE FORWARD CHARACTERISTICS

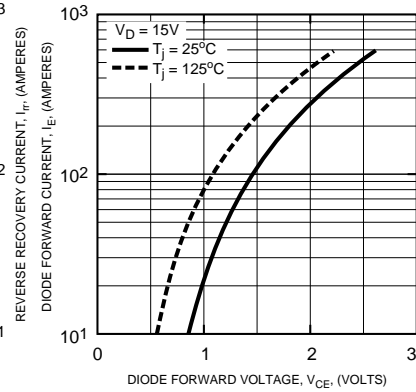

TRANSIENT THERMAL IMPEDANCE CHARACTERISTICS (IGBT)

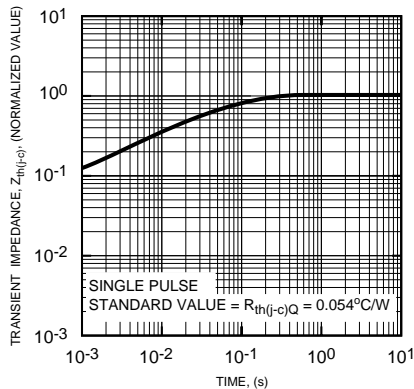

TRANSIENT THERMAL IMPEDANCE CHARACTERISTICS (FWDI)

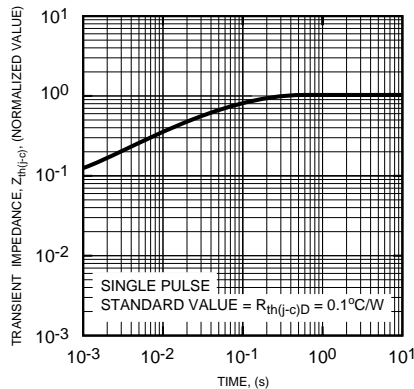

This datasheet has been download from:

www.datasheetcatalog.com

Datasheets for electronics components.