

### IQ251 Controller



#### Description

The IQ251 is a large capacity controller designed for the control of all types of building equipment. It can provide up to 128 I/O points by connecting 8 I/O modules in any combination. The range of I/O modules comprises an 8 analogue plus 8 digital input module, an 8 analogue output module, and an 8 digital output module. IQ system accessory modules may be connected to the input/output channels to provide greater I/O flexibility. They enable the IQ251 to provide sufficient capability for more complex strategies. It can operate either as a stand alone device or as part of a Building Management System. It provides access to all IQ controllers on a single or multi-Lan system using a node controller integrated within the IQ251. The IQ251 also provides the ability to connect any IQ system supervisor or Engineering Tool to the network without the need for a separate node controller.

#### Features

- 1 second cycle time.
- Access to entire network using local supervisor connection.
- Facility for mounting an additional node controller.
- High capacity DDC with PID control loops.
- Stand alone or integrated system operation.
- Up to 8 input/output modules for optimum configuration.
- Up to 96 logs.
- Up to 1000 values per log.
- Compatible with IQ151+ data files.
- Flexible I/O combinations

#### Physical

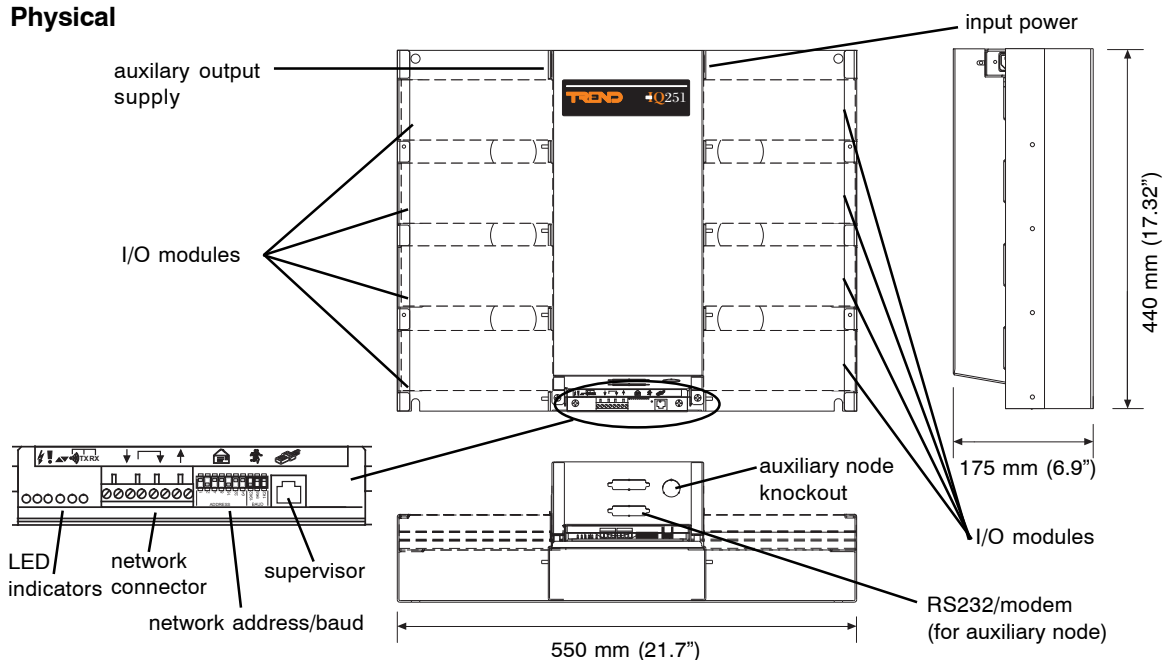

**FUNCTIONALITY**

The IQ Controller's functionality can be divided into three sections, strategy, firmware, and hardware.

**STRATEGY**

The strategy processes inputs according to a set of instructions and then outputs signals which can be used to control equipment.

**Configuration:** The IQ251 uses the standard IQ configuration mode which enables configuration using the network, or using the supervisor port. SET can be used to create a strategy data file (.IQ2) which can then be downloaded to the controller and subsequently uploaded for backup purposes if connected to the controller directly or using the network, or using a modem.

**Modules:** The strategy consists of a number of individual functional blocks known as configuration modules. These blocks can be linked in various combinations to enable equipment to be controlled in accordance with the building's requirements. The table lists the different types of configuration modules and the number of each type available with IQ251.

Module Type	Number	Module Type	Number
Sensor	96	Critical Alarm	4
Sensor type	20	Alarm History	20
Loop	32	IC Comms	16
Function	240	Digital Inputs	96
Logic	240	Fast Sequence	8
Driver	64	Zone	5
Knob	60	Schedule	32
Switch	60	Calendar	20
Sensor log	96	User Password	6
Sequence step	560	Sequence time	1 s
Analogue Nodes	510	Digital Nodes	1012
Display	400	Directory	80
Page	80	Group	10
Route	50	Destination	7
New Alarm Log	300		

Full details of the modules are given in the IQ Configuration Manual and Addendum. The IQ251 contains the normal IQ2 features as described in IQ Configuration Manual Addendum: Engineers Journal (J), I/O Summary (i/o) Loader Issue (R(c), 'c' lower case), Serial Number (R(s), 's' lower case), Supply Frequency Option, Enhanced Logging, Module position, and Strategy Cleardown.

**External Channels:** Because the I/O modules may be fitted in any combination in any of the 8 I/O slots, the channel numbers must be carefully identified. In configuration mode the IQ251 identifies the external channel numbers corresponding to the module number (in the case of sensors or digital inputs) or output channel number (in the case of drivers).

The sensor and digital input modules, and the output channels specified in the driver modules are related to the external channels as shown in the table:

Sensor Channels		Digital Input Channels		Driver Channels	
Sensor Number	External Channel	Dig. Input Number	External Channel	Output Channel	External Channel
S1 to S8	AA1 to AA8	I1 to I8	AD1 to AD8	1 to 8	E1 to E8
S9 to S16	BA1 to BA8	I9 to I16	BD1 to BD8	9 to 16	F1 to F8
S17 to S24	CA1 to CA8	I17 to I24	CD1 to CD8	17 to 24	G1 to G8
S25 to S32	DA1 to DA8	I25 to I32	DD1 to DD8	25 to 32	H1 to H8
S33 to S48	internal only	I33 to I48	internal only	33 to 48	dummy channels
S49 to S56	EA1 to EA8	I49 to I56	ED1 to ED8	49 to 56	A1 to A8
S57 to S64	FA1 to FA8	I57 to I64	FD1 to FD8	57 to 64	B1 to B8
S65 to S72	GA1 to GA8	I65 to I72	GD1 to GD8	65 to 72	C1 to C8
S73 to S80	HA1 to HA8	I73 to I80	HD1 to HD8	73 to 80	D1 to D8
S81 to S96	internal only	I81 to I96	internal only	81 to 96	dummy channels

The external channels are referenced as follows:

[module position],[analogue(A) or digital(D) - input module only],[channel number]

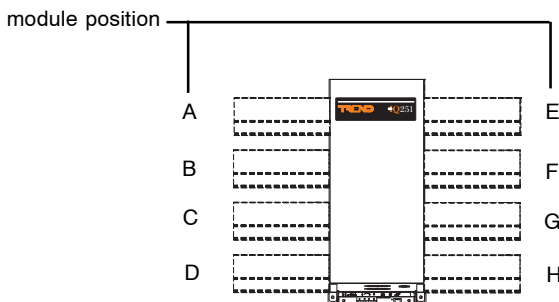

- e.g. BA1 position **B**, Analogue input, channel **1**
- BD1 position **B**, Digital input, channel **1**
- F1 position **F**, output channel **1**
- A7 position **A**, output channel **7**
- GD8 position **G**, Digital input, channel **8**

## FIRMWARE

**Communications:** When operating as part of a Building Management System, the IQ251 will be connected to other devices using the IQ system Network. This means that information within the IQ251 can be accessed using one of the IQ system supervisor programs, or passed to other IQ controllers using inter-controller communications, enabling the sharing of information across the whole system.

When connected to the network the controller can use up to 3 different addresses. One address is for the controller itself (set by front panel switch) the second and third are optional, and are for the locally connected supervisors (supervisor port address), (ndp port address). Thus a locally connected supervisor has its own network address when connected to the network using the controller.

The controller's address is set by a switch, and the supervisor and ndp port addresses are set up in the strategy configuration (address module).

**Battery Status:** The IQ251 has a battery status checking circuit that checks the battery on power up and thereafter every midnight and sets byte 506 bit 0 if the voltage has falls below a threshold value. This bit being set indicates that the battery needs to be changed. It should be used within the strategy to generate an alarm (e.g. critical alarm). The battery should be changed after the first indication. The battery will have a typical life of 10 years at 20 °C (68 °F). It is recommended that the battery is replaced every 5 years.

## HARDWARE

**Unit:** The IQ251 has a metal chassis and a metal front cover. The I/O modules are of aluminium extrusion. The I/O modules are fitted to the controller by snapping off a section in the cover and removing the relevant side plate. The module connector then slides into a socket on the controller. There is an option to fit a 16 terminal earthing (grounding) bar below each I/O module for cable screens (Part/LA102359K). Cable access is using holes in the rear plate, or from top or bottom, cables can be run down the central column behind the controller board. Cleats are fitted to the rear plate to facilitate cable mounting. There is a 25 Way D type knockout on the bottom of the front panel for RS232 connection to an auxiliary node, and a circular knockout for M20 gland or grommet for internetwork, PSTN, ISDN or Lon cables. If required the IQ251 can be fitted in an IP55 metal enclosure (ENCLS).

**Connectors:** Two part connectors are used throughout to facilitate wiring. A busbar is provided for screen termination.

**Power:** 230 Vac 50/60 Hz, 24 Vac 50/60 Hz, or 24 Vdc. The 24 Vac input power must be isolated and can only power 1 controller. The 24 Vdc input power may be earthed (grounded) but polarity must be correct; it can power several controllers in parallel.

**Fusing:** The controller has no replaceable fuses; protection is provided by means of a self-resetting thermally protected transformer. The 24 V ac or dc versions have a 4A replaceable 1¼" fuse fitted in line of input power cable inside the unit and a solid state multifuse. The I/O modules are also individually protected against short circuits.

**Indicators:** LED indicators for receive and transmit network current flow (RX, TX) and network OK (●), also for power (⚡), all I/O channels (▲), and watchdog (Ⓜ). See specification section for details.

**Network:** The network terminals facilitate connection of 2 or 4 wire cables. The standard IQ system node features are included (TX, RX, and network OK, ●), indicators, bypass relay, and network alarm generation). There is also the facility for connection of a supervisor and integral network display panel to the network using the controller without the need for additional node controllers.

*Note that the IQ251 does not have a balanced line transmitter like other IQ2 series controllers and this may result in reduced network resilience.*

**Address/Baud rate switch:** The address on the Lan is set by poles 1 to 7 in range 1, 4 to 9, 11 to 119 and must be unique on the Lan. The baud rate is set by poles 8 to 10 in the range 1k2, 9k6, 19k2 and must match the other nodes on the Lan. The address/baud rate switch may also be used to perform a strategy clear-down; this is done by setting all the address/baud rate poles to zero before power up (see Installation Instructions, TG103483 sheet 4 and IQ Configuration Manual Addendum). For this reason the address should normally be set non-zero.

**Battery Backup:** Details about the strategy configuration, time and date, and logged data are stored in RAM. A plug-in lithium cell provides power to maintain the data in the event of power failure, or the controller being switched off.

**Auxiliary output supply:** There is a 24 Vdc auxiliary output supply provided on the input power board to power external relay modules, sensors, etc. It is thermally protected and can provide a maximum of 500 mA. This will normally be available, but if the IQ251 has a full complement of I/O modules, and an integral comms node fitted the amount of auxiliary power available for other purposes will have to be calculated. The 24 Vdc input power in the IQ251 has 2100 mA available after deduction of current required for main board and network. This has to power I/O modules, integral node, and the 24 Vdc auxiliary output supply.

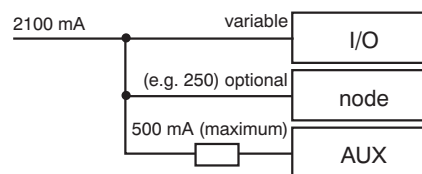

These loads can be calculated as follows:

### Input module

8 digital inputs @ 8 mA per channel  
 8 analogue inputs @ 20 mA per channel (thermistor and voltage inputs can be ignored)  
 Max total for whole I/O module = (8x8)+(20x8) = 224 mA

### Output module

8 analogue outputs @ 20 mA per channel  
 Max total for whole board = 20x8 = 160 mA  
 8 digital outputs @ 24 mA per channel  
 Max total for whole I/O module = 24x8 = 192 mA

Integral Node (e.g. TMN) = 250 mA.

(For consumption of other nodes see the respective data sheet).

For example:

IQ251 with 4 input I/O modules, 2 digital output I/O modules, 2 analogue output I/O modules, an integral NDP, and an MNC. How much current is available from the auxiliary output supply?

### Current consumed:

4 input I/O modules (all analogues are current)	4 x 224 = 896 mA
2 digital output I/O modules	2 x 192 mA = 384 mA
2 analogue output I/O modules (at max).	2 x 160 mA = 320 mA
1 TMN	250 mA
Total	1850 mA
Current available:	2100 - 1850 = 250 mA

**HARDWARE** (continued)

**I/O modules:** The IQ251 has a range of I/O modules which may be fitted in any combination in the 8 I/O slots. The range comprises an 8 analogue and 8 digital input module (EIN), an 8 analogue output module (EAO), and an 8 digital output module (EDO).

**Inputs:** The input channel combination is dependent on the number of input modules fitted. Each EIN module provides 8 analogue, and 8 digital inputs.

Analogue Input (8 identical channels)

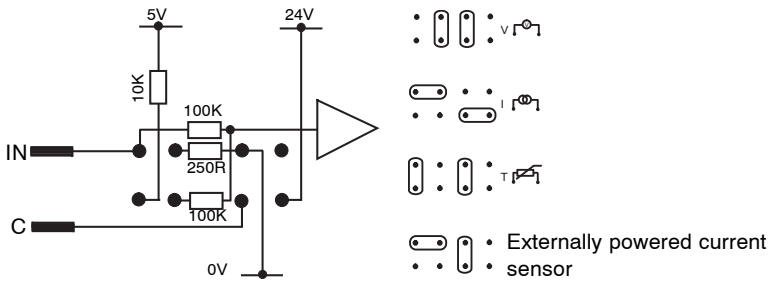

Digital Input (8 identical channels)

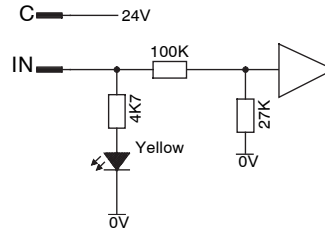

**Outputs:** The output channel combination is dependent on the output modules fitted. There are two different modules; the EDO which provides 8 digital outputs, and the EAO which provides 8 analogue voltage outputs. An IQ system 2VID interface module can be used in conjunction with 2 analogue voltage outputs to provide 2 analogue current outputs.

Digital Output (8 identical channels)

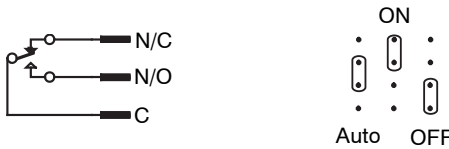

Analogue Voltage Output (8 identical channels)

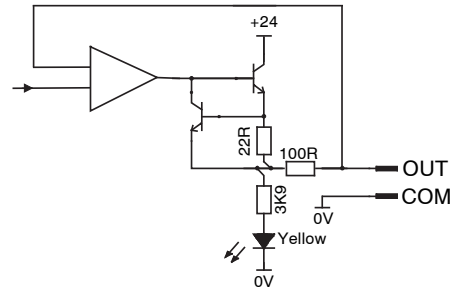

Digital outputs have manual override facilities as indicated above.



**Warning:** High voltage may be present. Isolate elsewhere.

**HARDWARE** (continued)

**Local Supervisor:** The IQ251 has a local supervisor port on the front panel (RJ11). This corresponds to the local supervisor port address provided by the IQ251:

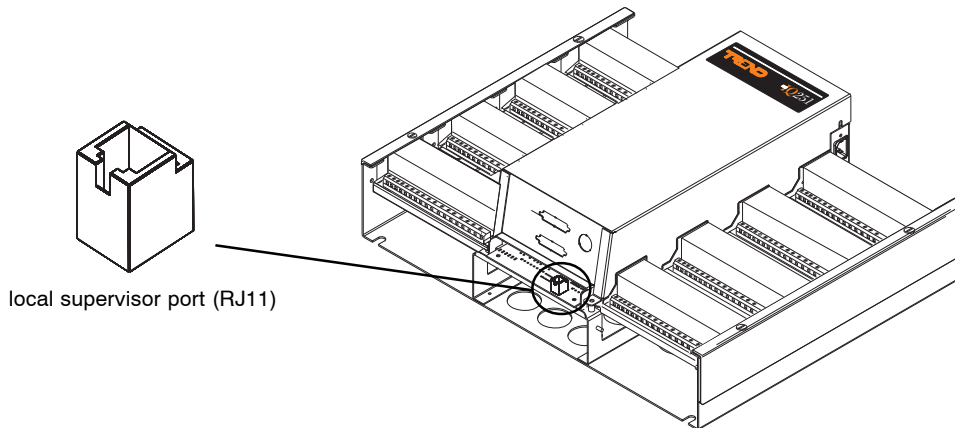

**Supervisor:** A PC running a IQ system Supervisor, Engineering tool, wireless sensor receiver XW/R/IQ, or an IQView can be connected to the network using the controller’s supervisor port without the need for an additional node controller although it does have its own network address. When connected in this way the supervisor will have access to all devices on the network, and will function as if it were connected using its own node controller. A wall mounting display, room display (RD), or smart display unit (SDU) may be connected to the local supervisor port. Both displays monitor and adjust parameters in the local IQ251 only. The RD enables temperature setpoint display and adjustment with options for occupancy override and fan speed adjustment (see order codes section). The SDU enables monitor and adjustment of selected parameters. Only one single device (PC, IQView, RD, SDU, or XW/R/IQ) may be connected to the supervisor port at one time.

The diagram below illustrates the combinations in which local supervisors/engineering tools and displays can be connected.

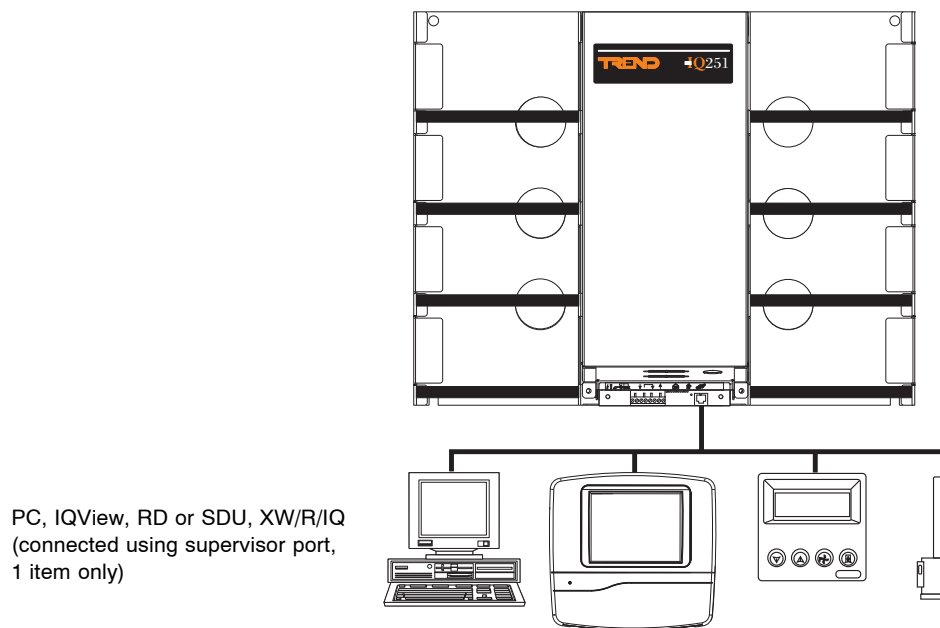

**HARDWARE** (continued)

**Integral Node** :If required an additional node controller (e.g. TMNH, TMNE, CNC2, PNC2, INC2, LINC/FTT) may be fitted inside the IQ251 using the node mounting kit. KIT/NODE/IQ25x.

The mounting kit contains nylon pillars which are screwed into the 4 aluminium threaded inserts on the IQ251. The node card has 4 semi-circular cutouts that fit between the mounting screws; the screws are then tightened to clamp the board. There is a special 24 Vdc power connection (labelled XNC) and a network connector (labelled MNC). The two on-board network links must be removed to enable the network to connect to the node.

*Note that an additional node controller will consume current from the 24 Vdc auxiliary output supply; see auxiliary output supply section above and appropriate node controller data sheet.*

There is a front panel knockout for RS232 to auxiliary node, and a circular knockout for other auxiliary node cables.

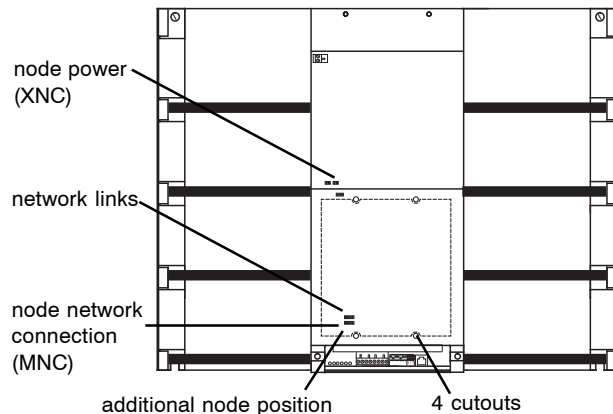
**COMPATIBILITY**

**Supervisors:** 916, IQView.

**Utility software:** SET.

**Controllers:** It can communicate to other IQ system controllers using inter-controller communications.

**Interface:** It can be connected to IQ system interface modules. Check interface module specification to ensure compatibility.

**Local Display:** IQView, SDU,RD.

The IQ Configuration Reference Manual Addendum covers the compatibility between different types of strategy files, and between the IQ251 sensor logs, and supervisors and software tools.

**FIELD MAINTENANCE**

The IQ Controller requires virtually no routine maintenance, however it is recommended that the lithium battery be replaced every 5 years, as explained in the IQ251 Installation Instructions, TG103483.

**INSTALLATION**

The IQ251 Controller is installed in a cabinet or panel using 4 screws and washers. For IQ251/USA, the unit is UL rated as 'UL916, listed open energy management equipment'. The procedure involves:

Mounting the controller in position	Linking analogue input channels
Fitting earthing (grounding) bars (if required)	Fitting link headers (if required)
Routing and tying cables	Setting digital output links (if required)
Fitting I/O modules	Switching On
Connecting I/O	Checking controller
Connecting power, do not switch on	Checking network
Connecting network	Configuring strategy
Connecting auxiliary output supply output (if used)	Checking operation
Isolating and disconnecting I/O	Backing up strategy
Setting network address and baud rate	Closing panel

The installation procedure is covered in the IQ251 Installation Instructions (TG103483). Fitting an integral node is covered by KIT/NODE/IQ25x installation instructions (TG200595)

INSTALLATION

CONNECTIONS

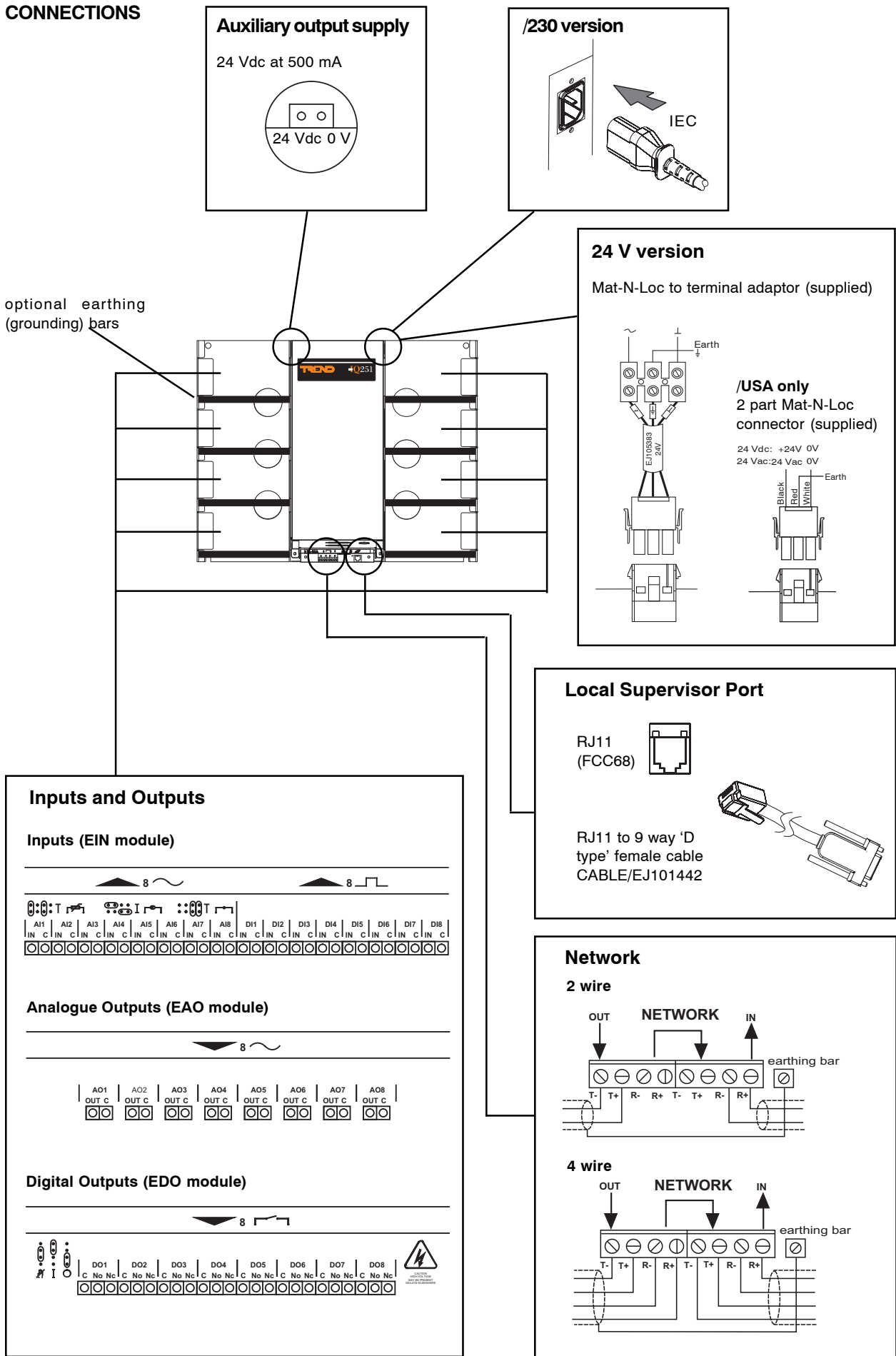

**Auxiliary output supply**

24 Vdc at 500 mA

**/230 version**

IEC

**24 V version**

Mat-N-Loc to terminal adaptor (supplied)

**/USA only**  
2 part Mat-N-Loc connector (supplied)

24 Vdc: +24V 0V  
24 Vac: 24 Vac 0V

**Local Supervisor Port**

RJ11 (FCC68)

RJ11 to 9 way 'D' type' female cable CABLE/EJ101442

**Inputs and Outputs**

**Inputs (EIN module)**

**Analogue Outputs (EAO module)**

**Digital Outputs (EDO module)**

**Network**

**2 wire**

**4 wire**

## DISPOSAL

COSHH (Control of Substances Hazardous to Health - UK Government Regulations 2002) ASSESSMENT FOR DISPOSAL OF IQ251 Controllers. The only part affected is the lithium battery which must be disposed of in a controlled way.

### RECYCLING. ♻️

All plastic and metal parts are recyclable. The printed circuit board may be sent to any PCB recovery contractor to recover some of the components for any metals such as gold and silver.



#### WEEE Directive :

At the end of their useful life the packaging, product, and batteries should be disposed of by a suitable recycling centre.

Do not dispose of with normal household waste.  
Do not burn.



**ORDER CODES**

Non USA versions

**IQ251/[Node]/[Power]**

[Node]		[Power]	
blank	No node	230	230 Vac power supply
TMNH	Node including integral modem	24VAC	24 Vac power supply
TMNE	Node for external modem	24VDC	24 Vdc power supply
CNC2	Node for Trend network		
PNC2	Node for remote printer		
INC2	Node for Trend Internetwork		
LINC/FTT	Node for LonWorks network		

e.g. **IQ251/TMNH/230** Specifies an IQ251 with integral modem node, and 230 Vac input power.

Controller comes complete with input power cable and moulded IEC connector (230 V) or screw terminal adaptor and MAT-N-LOC connector (24 V).

*Note that I/O modules for the IQ251 must be ordered separately, see below*

**USA Versions**

<b>Non USA Order Code</b>	<b>USA Order Code</b>	
<b>IQ251/USA/UL/24VAC</b>	<b>882000000</b>	UL rated IQ251 Controller.
<b>IQ251/TMNH/USA/UL/24VAC</b>	<b>882000010</b>	UL rated IQ251 Controller with TMNH modem.

**I/O Modues**

<b>Non USA Order Code</b>	<b>USA Order Code</b>	
<b>EIN</b>	<b>882000040</b>	I/O module for IQ251 with 8 analogue and 8 digital inputs.
<b>EAO</b>	<b>882000050</b>	I/O module for IQ251 with 8 analogue outputs.
<b>EDO</b>	<b>882000040</b>	I/O module for IQ251 with digital outputs.

**Accessories**

<b>Non USA Order Code</b>	<b>USA Order Code</b>	
<b>PART/LA102359K</b>	not available in USA	Earthing (grounding) bar with mounting screw and nuts and bag of earthing (grounding) screws.
<b>KIT/NODE/IQ25x</b>	<b>882000080</b>	Kit for mounting an auxiliary node card in IQ251 (appropriate node cards listed above; node card must be ordered separately).
<b>ENCLS</b>	not available in USA	600 mm x 600 mm x 210 mm IP55 enclosure.
<b>CABLE/EJ101442</b>	not available in USA	Adaptor cable RJ11 to 9Way D type female for local PC connection.

**ORDER CODES** (continued)**Other Displays**

<b>Non USA Order Code</b>	<b>USA Order Code</b>	
<b>SDU/IQ</b>	not available in USA	Smart Display Unit for wall mounting enabling monitoring and adjustment of parameters.
<b>RD/IQ/K</b>	not available in USA	Room Display Unit for wall mounting, including temperature, setpoint display and adjustment.
<b>RD/IQ/KOS</b>	not available in USA	Room Display Unit for wall mounting, including temperature, setpoint display and adjustment, and occupancy override.
<b>RD/IQ/KOSF</b>	not available in USA	Room Display Unit for wall mounting, including temperature, setpoint display and adjustment, occupancy override, and fan speed adjustment.
<b>SDU/IQ/WSA/USA</b>	882001470	Smart Display Unit for wall mounting enabling monitoring and adjustment of parameters plus wall adaptor plate for US wall boxes.
<b>RD/IQ/K/WSA/USA</b>	882001500	Room Display Unit for wall mounting, including temperature, setpoint display and adjustment plus wall adaptor plate for US wall boxes.
<b>RD/IQ/KOS/WSA/USA</b>	882001240	Room Display Unit for wall mounting, including temperature, setpoint display and adjustment, and occupancy override plus wall adaptor plate for US wall boxes.
<b>RD/IQ/KOSF/WSA/USA</b>	882001550	Room Display Unit for wall mounting, including temperature, setpoint display and adjustment, occupancy override, and fan speed adjustment plus wall adaptor plate for US wall boxes.

## SPECIFICATIONS

### CONTROLLER

#### Electrical

CPU	:68EC020 32 bit processor
CPU speed	:16.67 MHz
Cycle time	:1 s
Memory	:512 kbyte battery-backed SRAM, and 512 kbyte flash.
Input power	
230	:230 Vac, +15% -10%, 50 to 60 Hz
/24VAC	:24 Vac, +25% -10%, 50 to 60 Hz (24 Vac input power must be isolated)
/24VDC	:24 Vdc, +25% -10%, (24 V to 36 Vdc)
Auxiliary output supply	:24 Vdc ±10% 500 mA maximum (typical) dependent on configuration (see auxiliary output supply section for details)
Consumption	:100 VA maximum
Fusing	
/230	:No replaceable fuses required. All protection self resetting.
/24VAC, /24VDC	:4A 1¼" replaceable fuse fitted in line of input power cable inside unit.
Battery backup	:Battery maintains time, and logged data with input powers off for at least 5 years.
Battery	:CR2032, 3 V, or equivalent
Clock accuracy	:30 s per month (typical).
Network	:20 mA serial 2 wire current loop, opto isolated, polarity independent receiver.
Supervisor transmission	:RS232, EIA/TIA/232E, V28
Distance	
Supervisor	:15 m (16 yds)
Network	:Dependent on cable type, see table below.

Cable	1k2 baud	9k6 baud	19k2 baud	No. of Wires
Belden 9182	1000 m (1090 yds)	1000 m (1090 yds)	700 m (765 yds)	2
Belden 9207	1000 m (1090 yds)	1000 m (1090 yds)	500 m (545 yds)	2
<b>IQ system</b> TP/1/1/22/HF/200 (Belden 8761)	1000 m (1090 yds)	700 m (765 yds)	350 m (380 yds)	2
<b>IQ system</b> TP/2/2/22/HF/200 (Belden 8723)	1000 m (1090 yds)	500 m (545 yds)	250 m (270 yds)	4

Baud rate	
Network	:Selectable by switch 1k2, 9k6, or 19k2, set to be the same as other nodes on Lan.
Supervisor	:9k6.
Network addresses	
Controller	:Selectable by switch, 116 nodes addressable (1,4 to 119 excluding 10) set to be unique on Lan.
Supervisor port	:Software selectable, 116 nodes addressable (1, 4 to 119 excluding 10) set to be unique on Lan
NDP port	:Software Selectable, 116 nodes addressable (1,4 to 119 excluding 10) set to be unique on Lan.
Input or Output modules	:8 modules in total. Any module type may be fitted in any position. Module types are:
EIN	:8 analogue and 8 digital inputs
EAO	:8 analogue outputs
EDO	:8 digital outputs





#### Mechanical

Dimensions	:550 mm (21.7") x 440 mm (17.32") x 175 mm (6.9")
Material	
Chassis	:Zinc plated and passivated mild steel
I/O modules	:Extruded aluminium with alocrom finish.
Cover	:Fire retardant moulded ABS.
Protection	:IP20
Weight	:14.5 kg (32 lbs) (fully loaded)
Connector	
I/O modules	:2 part connector, 50 mm (1.97") half pitch
Power	
/230	:IEC plug
/24VAC, /24VDC	:Mat-N-Loc to screw terminal adaptor
Network	:2 part connector with 8 screw terminals for 0.5 to 2.5 mm <sup>2</sup> cross section area (14 to 20 AWG) cable.
Supervisor	:RJ11 (FCC68), 6 pin, for IQ system utility software connected using adaptor cable CABLE/EJ101442.

#### Environmental

EMC	
Emissions	:EN50081-1.
Immunity	:prEN50082-2.
Safety	:EN61010.
Ambient limits	
Storage	:-10 °C (14 °F) to 50 °C (122 °F)
Operating	:0 °C (32 °F) to 45 °C (113 °F)
Humidity	:0 to 90 %RH non-condensing
UL	:(IQ251/USA only). The unit is UL rated as 'UL916, listed open energy management equipment'.

#### Indicator Lamps

PWR 	:(green) ON when input power is connected.
WD 	:(red) ON if controller has a software fault.
I/O 	:(red) Flashes during normal operation.
LAN 	:(green) ON if network is operating. Flashes if prohibited controller network address set (0, 2, 3, >119).
TX	:(yellow) ON if current is flowing from the network transmitter.
RX	:(yellow) ON if current is entering the network receiver.

**SPECIFICATIONS** (continued)**I/O MODULES****All**

Dimensions	:72 mm (2.83") x 202 mm (7.95") x 43 mm (1.69")
Weight	:0.3 kg approx. (0.66 lbs)
Connector	
Main board	:2 part connector, 50 mm (1.97") half pitch
Inputs/Outputs	:2 part connector screw terminals for 0.5 to 2.5 mm <sup>2</sup> cross section area (20 to 14 AWG) cable.
Signal Cable	:Analogue Voltage, Current, Thermistor, or Digital inputs, and Analogue outputs. IQ system TP/1/1/22/HF/200 recommended (Belden 8761)

**8 Analogue, 8 Digital Input Module (/EIN/)**

Analogue inputs	:12 bit resolution (4096 steps). Minimum 60 dB series mode rejection at frequency of input power supply. Linkable for analogue current (I), analogue voltage (V), or thermistor (T)
V	:0 to 10 V input resistance 200 k $\Omega$ , accuracy 50 mV equivalent to $\pm$ 0.5% of span.
I	:0 to 20 mA input resistance 250 $\Omega$ 0.1%, accuracy 0.5 % of span (i.e. 100 $\mu$ A)
T	:Thermistor, bridge resistor 10 k $\Omega$ 0.1%, accuracy 0.5 % of span. Bridge input power 5V.
Digital inputs	:Volt free contact, or 24 Vdc self powered contact. Wetting current 5 mA @ 24 Vdc, count rate 32 Hz max.
Status LED	:(yellow) One per digital input. ON if input is closed

**8 Analogue Output Module (/EAO/)**

Analogue outputs	:8 bit resolution (256 steps). 0 to 10 V with 20 mA current limit, accuracy $\pm$ 50 mV equivalent to $\pm$ 0.5 % span.
Status LED	:(yellow) 1 per channel. Light intensity increases with output voltage.

**8 Digital Output Module (/EDO/)**

Digital outputs	:Single pole change over relay, contacts rated for 240 Vac single phase throughout only 7 A (resistive load), 5 A (inductive, $\cos\phi \geq 0.4$ ), 30 Vdc at 5 A (resistive load), reduce to 2 A for 24 Vdc (inductive load, $T \leq 30$ mS). Arc suppression recommended, see Relay Output Arc suppression Installation Instructions, TG200208). IQ251/USA only: Relay outputs are UL rated up to 30 V.
Status LED	:(yellow) 1 per channel. ON when relay is energised.
Manual override	:Each channel is linkable for ON, OFF, or AUTO.

**Version** This document covers

Firmware	:V3 or greater
Boards	
EIN	:AM101687 v3
EAO	:AM101721 v1.1
EDO	:AM102022 v1.1
CPU	:AM101701 v1
PSU	:AM102060 v2.2

Please send any comments about this or any other Trend technical publication to [techpubs@trendcontrols.com](mailto:techpubs@trendcontrols.com)

© 2008 Honeywell Technologies Sàrl, ECC Division. All rights reserved. Manufactured for and on behalf of the Environmental and Combustion Controls Division of Honeywell Technologies Sàrl, Ecublens, Route du Bois 3, Switzerland by its Authorized Representative, Trend Control Systems Limited.

Trend Control Systems Limited reserves the right to revise this publication from time to time and make changes to the content hereof without obligation to notify any person of such revisions or changes.

**Trend Control Systems Limited**

P.O. Box 34, Horsham, West Sussex, RH12 2YF, UK. Tel:+44 (0)1403 211888 Fax:+44 (0)1403 241608 [www.trend-controls.com](http://www.trend-controls.com)

**Trend Control Systems USA**

6670 185th Avenue NE, Redmond, Washington 98052, USA. Tel: (425)897-3900, Fax: (425)869-8445 [www.trend-controls.com](http://www.trend-controls.com)