

## 8JS three-phase synchronous motors Dynamic precision drives

Modern machine concepts demand compact and powerful motors. The compact AC servo motor series from B&R provides ways for the machine manufacturer to further optimize service and production processes.



## Table of contents

www.rgbautomatyka.pl



<b>System characteristics</b> .....	1588
<b>Product overview</b> .....	1602
<b>Product data sheets</b> .....	1604
<b>Accessories</b> .....	1642



## System characteristics



### 8JS three-phase synchronous motors

B&R's 8JS three-phase synchronous motors have been specially developed for use in high-performance applications. They are now being used to produce consumer goods and products in the plastic, packaging, metal, food and beverage industries and then palletize them with material handling systems. Complete solutions from one source: this requires the right components as well as the right configuration for the application environment. The large selection of available 8JS three-phase synchronous motors makes it possible to easily meet conditions such as reducing the variety of parts, guaranteeing ease of service and maintaining minimum requirements on space.

An optimally configured drive rounds off a successful design. To meet this goal, specialists are available at B&R subsidiaries all over the world who are eager to share their know-how in the area of mechatronics. B&R automation components: the economical combination of mechanics, electronics, technology and innovation.

### Feedback systems specified to meet your needs

The 8JS three-phase synchronous motors are available with different encoder systems. As standard, they are equipped with Heidenhain EnDat encoders. The absolute encoder functions without a battery and is therefore absolutely maintenance free. The 8JS three-phase synchronous motors are also available with resolvers for machines with lower precision and speed requirements.

### Smooth surface

Special surface construction allows the 8JS three-phase synchronous motors to be used in applications for the food and beverage industry. Depressions where liquids could collect were deliberately avoided.

### Connection type

The uniform connection technology, the prefabricated cables and the embedded parameter chip described above allow plug and play operation of the power transmission system. The angled connectors can be swiveled, which provides the maximum amount of flexibility during cabling.

### Advantages of B&R drives for your application:

- **Easy to install**
- **Small installation dimensions**
- **Extremely easy to service**
- **Low costs**

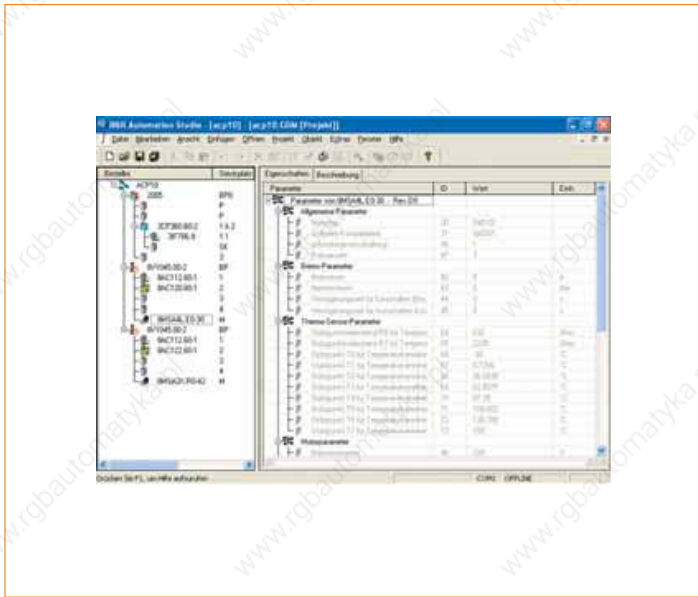

### Embedded parameter chip

All relevant mechanical and electrical information and data is stored in the encoder used for the 8JS three-phase synchronous motors. This means that the user doesn't have to make settings on the servo drive in the field. As soon as the encoder is connected to the servo drive and the power is applied to the electronics, the motor is automatically identified. The motor sends its rated parameters and limit parameters to the servo drive. The drive then automatically determines the current limits and current control parameters required for optimal control of the motor. The user only has to optimize the speed and position controller. The integrated start-up environment in B&R Automation Studio™ provides assistance.

In addition to start-up assistance, routine service work is also made easier and motors can be exchanged without having to take extra time to set parameters.

## System characteristics

### 8JS three-phase synchronous motors

Three-phase synchronous motors from the 8JS series are permanently excited, electronically commutated synchronous motors for applications that require excellent dynamic characteristics and positioning precision as well as compact size and reduced weight.

- NdFeB permanent magnets
- Sinusoidal commutation with EnDat encoder or resolver as feedback unit
- Three-phase winding with star connection
- Compact sizes result in low weight
- Minimum moment of inertia because of favorable rotor construction results in very good dynamic properties
- High overload capability/peak torque
- Optimized torque ripple
- High dynamic torque at high speeds
- Long life-span, all motor parts except for bearings are free of wear
- Power dissipation generated in the stator diverted directly to the flange via the housing
- Preloaded, grooved ball bearings which are sealed on both sides and greased
- Complete motor system with stall torque ranging from 0.48 Nm to 53 Nm
- Connection using two SpeedTEC circular plugs
- Controlled by ACOPOS servo drives (■ 1251) or ACOPOSmulti drive systems (■ 1321)

8JS three-phase synchronous motors are not allowed to be connected directly to the power mains; they are only allowed to be operated in combination with ACOPOS servo drives (■ 1251) or ACOPOSmulti drive systems (■ 1321)!

### Cooling types

#### Cooling type A

8JS three-phase synchronous motors with cooling type A are self-cooling and have a long, slim design. The motors must be installed on the cooling surface (flange).

## Sizes

8JS three-phase synchronous motors are available in six different sizes (2 through 7). They have different dimensions (especially flange dimensions) and power ratings. The various sizes can be differentiated by a number (c) in the model number. The larger the number, the larger the flange dimensions and power rating for the respective motor. (see also order key 1597)

## Overview

Cooling type	Available sizes					
	2	3	4	5	6	7
A	Yes	Yes	Yes	Yes	Yes	Yes

## Lengths

The 8JS three-phase synchronous motors are available in up to five different lengths. They have different power ratings with identical flange dimensions. The various lengths can be differentiated by a number (d) in the model number. (see also order key 1597)

## Overview

Length	Available for size					
	2	3	4	5	6	7
1	---	Yes	---	Yes	---	---
2	Yes	Yes	Yes	Yes	Yes	Yes
3	---	Yes	Yes	---	Yes	Yes
4	Yes	---	Yes	Yes	Yes	Yes
5	---	---	---	---	Yes	---

# System characteristics

## Motor encoder system

The 8JS three-phase synchronous motors are available with EnDat encoders and also with resolvers. The encoder system is listed as part of the model number in the form of a 2-digit code (ee). (see also order key 1597)

## EnDat encoders

### General information

EnDat is a standard developed by Johannes Heidenhain GmbH ([www.heidenhain.de](http://www.heidenhain.de)) that incorporates the advantages of absolute and incremental position measurement and also offers a read/write parameter memory in the encoder. With absolute position measurement (absolute position is read in serially), the homing procedure is usually not required. When necessary, a multi-turn encoder (4096 revolutions) should be installed. To save costs, a single-turn encoder and a reference switch can also be used. In this case, a homing procedure must be carried out. The incremental process allows the short delay times necessary for position measurement on drives with exceptional dynamic properties. With the sinusoidal incremental signal and the fine resolution in the EnDat module, a very high positioning resolution is achieved in spite of the moderate signal frequencies used.

### Technical data

Different types of EnDat encoders can be used depending on the requirements:

Name	E4 <sup>1)</sup>	E5 <sup>1)</sup>	E6 <sup>2)</sup>	E7 <sup>2)</sup>
Encoder type	EnDat single-turn	EnDat multi-turn	EnDat single-turn	EnDat multi-turn
Resolution	512-line	512-line	2048-line	2048-line
Recognizable Revolutions	---	4096	---	4096
Accuracy	±60"	±60"	±20"	±20"
Limit frequency	≥ 200 kHz (-3 dB)	≥ 200 kHz (-3 dB)	≥ 400 kHz (-3 dB)	≥ 400 kHz (-3 dB)
Vibration during operation 55 < f ≤ 2000 Hz	≤ 100 m/s <sup>2</sup>	≤ 100 m/s <sup>2</sup>	≤ 150 m/s <sup>2</sup>	≤ 150 m/s <sup>2</sup>
Shock during operation Length 6 ms	≤ 1000 m/s <sup>2</sup>	≤ 1000 m/s <sup>2</sup>	≤ 1000 m/s <sup>2</sup>	≤ 1000 m/s <sup>2</sup>
Manufacturer	Dr. Johannes Heidenhain GmbH	Dr. Johannes Heidenhain GmbH	Dr. Johannes Heidenhain GmbH	Dr. Johannes Heidenhain GmbH
Internet address	<a href="http://www.heidenhain.de">www.heidenhain.de</a>	<a href="http://www.heidenhain.de">www.heidenhain.de</a>	<a href="http://www.heidenhain.de">www.heidenhain.de</a>	<a href="http://www.heidenhain.de">www.heidenhain.de</a>
Manufacturer's product ID	ECN1113	EQN1125	ECN1313	EQN1325

1) Only available for size 2 and 3 motors.

2) Only available for size 4, 5, 6 and 7 motors.



## Resolvers

### General information

BRX type resolvers are used in the servo motors. These resolvers are fed with a single sinusoidal signal (reference signal) and return two sinusoidal signals as the result. The amplitude of these signals change with the angular position (sine or cosine form).

### Technical data

Name	Order code (ee) R0
Accuracy	± 10 angular minutes
Non-linearity	± 1 angular minute
Vibration during operation	
10 < f ≤ 500 Hz	≤ 100 m/s <sup>2</sup>
Shock during operation	
Length 11 ms	≤ 400 m/s <sup>2</sup>

### Motor options

Depending on the size and length, the 8JS three-phase synchronous motors can be delivered

- With various rated speeds
- With or without oil seal
- With or without holding brake
- With a smooth shaft or a keyed shaft

### Rated speed

The rated speed is listed as part of the model number in the form of a 3-digit code (nnn). The code is equal to the rated speed divided by 100. The respective combination of the other motor options is listed in the form of a 2-digit code (ff) as part of the model number (see section "Determining the order code for motor options (ff)", 1596). (see also order key 1597)

### Oil seal

All 8JS three-phase synchronous motors are available with an optional form A oil seal according to DIN 3760.

When equipped with an oil seal, the motors have IP65 protection according to IEC 60034-5.

Proper lubrication of the oil seal must be guaranteed throughout the entire lifespan of the motor.

## System characteristics

### Holding brake

All 8JS three-phase synchronous motors can be delivered with a holding brake. It is installed directly behind the B-side bearing on the motor and is used to hold the motor shaft when no power is applied to the servo motor.

### Functionality

The holding brake is a spring-loaded brake and is controlled by the ACOPOS servo drive or an ACOPOS-multi inverter module. Based on principle, this type of holding brake exhibits a minimal amount of backlash.

The brake is designed as a holding brake. It is not permitted to be used to for operational braking! If these conditions are met, the brake has a lifespan of approximately 5000000 cycles (opening and closing the brake again is one cycle).

Loaded braking during an emergency stop is permitted - but reduces the lifespan.

The required brake holding torque is determined based on the occurring load torque. If the load torque is not sufficiently known, it is recommended to assume a safety factor of 2.

### Technical data for the standard holding brake

Name	Motor size					
	2	3	4	5	6	7
Holding torque $M_{Br}$ [Nm]	1.42	2.5	5,3	14.5	25	53
Installed load $P_{on}$ [W]	8.4 ± 7%	10.1 ± 7%	12.8 ± 7%	19.5 ± 7%	25.7 ± 7%	35.6 ± 7%
Installed current $I_{on}$ [A]	0.35	0.42	0.53	0.82	1.07	1.48
Installed voltage $U_{on}$ [V]	24 VDC ± 10%	24 VDC ± 10%	24 VDC ± 10%	24 VDC ± 10%	24 VDC ± 10%	24 VDC ± 10%
Activation delay $t_{on}$ [ms]	18	10	15	15	20	35
Release delay $t_{off}$ [ms]	20	25	35	80	105	110
Moment of inertia $J_{Br}$ [kgcm <sup>2</sup> ]	0.011	0.011	0.068	0.173	0.61	1.64
Weight $m_{Br}$ [kg]	0.27	0.35	0.63	1.1	2	2.9

### Design of the shaft end

All 8JS three-phase synchronous motor shafts comply to DIN 748. They can be delivered with a smooth shaft or a keyed shaft.

#### Smooth shaft

A smooth shaft end is used for a force-fit shaft-hub connection that guarantees a zero-play connection between shaft and hub as well as smooth operation. The end of the shaft has a threaded center hole which can be used to remove drive elements.

#### Keyed shaft

The keyed shaft can be used for a form-fit torque transfer with low demands on the shaft-hub connection and for handling torques with a constant direction.

The keyways for the 8JS three-phase synchronous motors conform to keyway form N1 according to DIN 6885-1. Form A shaft keys that conform to DIN6885-1 are used. Balancing motors with keyways is done using the half-key convention according to ISO 1940/1, G6.3.

The end of the shaft has a threaded center hole which can be used to mount drive elements with shaft end disks.

### Load capacity of the shaft end and bearing

The 8JS three-phase synchronous motors are equipped with grooved ball bearings which are sealed on both sides and greased. The radial and axial forces ( $F_r$ ,  $F_a$ ) that occur on the shaft end during operation and installation must be within the specifications listed below. The bearing elements are not permitted to be subject to shocks or impacts! Incorrect handling will cause the lifespan of the bearings to be reduced or the bearing to be damaged.

### Installation

The axial forces  $F_a$  permitted during the installation of gearboxes, pinion gears, couplings, etc. depend on the motor size and can be found in the following table:

Motor size	Permitted axial force $F_a$ [N]	Permitted radial force $F_r$ [N]
2	600	150
3	600	340
4	1400	500
5	1740	830
6	2200	1940
7	3000	2300

### Operation

#### Radial force

The radial force  $F_r$  on the shaft end is made up of the installation forces (e.g. belt tension on pulleys) and operational forces (e.g. load torque on the pinion). The maximum radial force  $F_r$  depends on the shaft end type, bearing type, average speed, position where the radial force is applied and the desired lifespan of the bearings.

#### Axial force, shift in shaft position caused by axial force

The axial force  $F_a$  on the shaft end is made up of the installation forces (e.g. stress caused by installation) and operational forces (e.g. thrust caused by slanted tooth pinions). The maximum axial force  $F_a$  depends on the bearing type and the desired lifespan of the bearings. The fixed bearing is secured on the A flange with a retaining ring. The floating bearing is preloaded on the B flange with a spring in the direction of the A flange. Axial forces in the direction of the B flange can cause the spring bias to be overcome and the shaft is shifted by the amount of axial play in the bearing (approx. 0.1 - 0.2 mm).

## System characteristics

### Determining permissible values for $F_r$ and $F_a$

Information to determine permissible values of  $F_r$  and  $F_a$  can be taken from the motor data for the respective three-phase synchronous motors (see section "8JSA2", 1604 to section "8JSA7", 1636). Permissible values are based on a bearing lifespan of 20,000 h (bearing lifespan calculation based on DIN ISO 281).

Simultaneously loading the shaft end with the maximum values of  $F_r$  and  $F_a$  is not permitted! Contact B&R if this occurs.

### Connection directions

8JS three-phase synchronous motors can be delivered with axial swivel connectors.

### Determining the order code for motor options (ff)

The respective code (ff) for the order key can be found in the following table:

Motor options				Code for order key (ff)
Connection direction	Oil seal	Holding brake	Shaft end	
Angled (swivel connector)	No	No	Smooth	D0
		Normal	Keyed	D1
			Smooth	D2
	Yes	No	Keyed	D3
			Smooth	D6
		Normal	Keyed	D7
		Smooth	D8	
		Keyed	D9	

## Order key

8JS	b	c	d	.	ee	nnn	ff	gg	-	h
-----	---	---	---	---	----	-----	----	----	---	---

### Cooling type (see section "Cooling types", 1590)

A ... self-cooling (no separate surface cooling)

### Size (see section "Sizes", 1591)

Valid values: 2, 3, 4, 5, 6, 7

### Length (see section "Lengths", 1591)

Valid values: 1, 2, 3, 4, 5

### Encoder system (see section "Motor encoder systems", 1592)

E4 ... EnDat single-turn, 512 lines (ECN1113) <sup>1)</sup>

E5 ... EnDat multi-turn, 512 lines (EQN1125), 4,096 revolutions <sup>1)</sup>

E6 ... EnDat single-turn, 2048 lines (ECN1313) <sup>2)</sup>

E7 ... EnDat multi-turn, 2048 lines (EQN1325), 4,096 revolutions <sup>2)</sup>

R0 ... Resolver

<sup>1)</sup> Only available for size 2 and 3 motors.

<sup>2)</sup> Only available for size 4, 5, 6 and 7 motors.

### Motor options (see section "Motor options", 1593, and section "Determining the order code for motor options (ff)", 1596)

nnn .. Rated rotational speed/100; e.g.: 030 corresponds to a rated speed of 3000 min<sup>-1</sup>

### Motor options (see section "Motor options", 1593)

### Special motor options

00 ... No special motor options

### Motor version

Valid values: 0

# System characteristics

## Example order 1

A three-phase synchronous motor (type **8JSA44**) with a rated speed of  $4000 \text{ min}^{-1}$  was selected for an application. The motor should also be equipped with a holding brake, a keyed shaft and a 2048-line EnDat single-turn encoder.

The code (ee) for the encoder system is **E6** (see "EnDat encoder", 1592).

The code (nnn) for a rated speed of  $4000 \text{ min}^{-1}$  is **040**.

The code (ff) for the other options (oil seal, holding brake, keyed shaft and connection direction) is **D3** (see "Motor option key codes (ff)", 1597).

The model number for the required motor is **8JSA44.E6040D300-0**

## Example order 2

A three-phase synchronous motor (type **8JSA54**) with a rated speed of  $5000 \text{ min}^{-1}$  was selected for an application. The motor should also be equipped with a holding brake, a smooth shaft, an oil seal and a 2048 line EnDat multi-turn encoder.

The code (ee) for the encoder system is **E7** (see "Technical data for the EnDat encoder", 1592).

The code (nnn) for a rated speed of  $5000 \text{ min}^{-1}$  is **050**.

The code (ff) for the other options (oil seal, holding brake, keyed shaft and connection direction) is **D8** (see "Motor option key codes (ff)", 1597).

Therefore the model number for the motor required is: **8JSA54.E7050D800-0**

## General motor data

<b>General information</b>	<b>Cooling type A</b>
C-UR-US listed	YES
<b>Electrical characteristics</b>	<b>Cooling type A</b>
Mains input voltage on servo drive	3 x 400 VAC ... 3 x 480 VAC ± 10%
Connection type	SpeedTEC circular connector from Intercontec
Motor connector	Size 1
Encoder connection	Size 1
<b>Thermal characteristics</b>	<b>Cooling type A</b>
Insulation class according to IEC 60034-1	F
Methods of cooling according to IEC 60034-6 (IC code)	Self-cooling No separate surface cooling (IC4A0A0)
Thermal motor protection according to IEC 60034-11	Maximum winding temperature is 155°C (the thermal motor protection in ACOPOS servo drives or in the ACOPOSmulti drive system limits it to 110°C)
<b>Mechanical characteristics</b>	<b>Cooling type A</b>
Vibration severity according to IEC 60034-14	Vibration class A <sup>1)</sup>
Roller bearing, dynamic load ratings and rated lifespan	Based on DIN ISO 281
Shaft End according to DIN 748	Form E
Oil seal according to DIN 3760	Form A
Key and keyway according to DIN 6885-1	Keyway form N1; key form A
Shaft balancing according to ISO 1940/1, G6.3	Half-key arrangement
Mounting flange	IEC 72-1
Shaft end concentricity, coaxial properties and mounting flange plane according to DIN 42955	Tolerance-N
Paint	Polyester powder coating
Name	Mansfield 053-2006 Polyester
Color	similar to RAL 9005 flat
1) Valid for all motors with a shaft height of more than 56 mm	
<b>Operational conditions</b>	<b>Cooling type A</b>
Rating class, operation mode acc. to IEC 60034-1	S1 - continuous operation
Ambient temperature during operation	+5°C to +40°C <sup>2)</sup>
Reduction of the rated current and stall current at temperatures above 40°C	10% per 10°C
Maximum ambient temperature during operation	+50°C <sup>1)</sup>
Relative humidity during operation	5 to 95%, non-condensing
Reduction of the rated current and stall current at installation altitudes	6% at 2000 m
Starting at 1000 m above sea level	17% at 3000 m 30% at 4000 m 55% at 5000 m
Maximum installation altitude	5000 m <sup>2)</sup>
Maximum flange temperature	65°C
Protection Standards according to IEC 60034-5 (IP code)	IP54
With optional oil seal	IP65
Construction and mounting arrangement type according to EN60034-7 (IM code)	Horizontal (IM3001) Vertical, motor hangs on the machine (IM3031) Vertical, motor stands on the machine (IM3011)
1) Continuous operation of the servo motors at ambient temperatures from +40°C to max. +50°C is possible, but results in a shorter lifespan.	
2) Additional requirements are to be arranged with B&R.	
<b>Storage and transport conditions</b>	<b>Cooling type A</b>
Storage temperature	-20 to +60°C
Relative humidity during storage	Max. 90%, non-condensing
Transport temperature	-20 to +60°C
Relative humidity during transport	Max. 90%, non-condensing

# System characteristics

## Terminology and formula symbols

### Connection direction terminology, bearings

#### Angled (swivel connector)

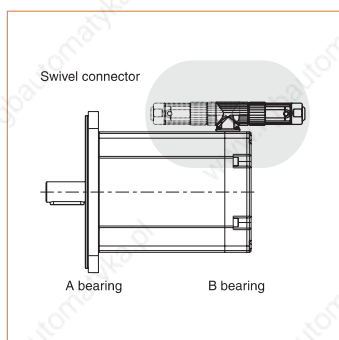

### Definitions for maximum shaft load diagrams

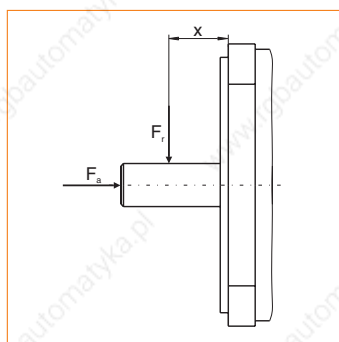

$F_r$  ..... Radial force

$F_a$  ..... Axial force

$x$  ..... Between motor flange and the point the radial force  $F_r$  is applied



## Formula symbols

Term	Character	Device	Description
Rated speed	$n_N$	$\text{min}^{-1}$	Rated motor speed.
Rated torque	$M_N$	Nm	The rated torque is output by the motor ( $n = n_N$ ) when the rated current is being drawn. This is possible for any length of time if the environmental conditions are correct.
Rated power	$P_N$	kW	The rated power is output by the motor when $n = n_N$ . This is possible for any length of time if the environmental conditions are correct.
Rated current	$I_N$	A	The rated current is the effective value for the phase current (current in the motor supply line) when generating the rated torque at the rated speed. This is possible for any length of time if the environmental conditions are correct.
Stall torque	$M_0$	Nm	The "stall torque" is output by the motor at the speed $n_0$ and when the "stall current" is being drawn. This is possible for any length of time if the environmental conditions are correct. The speed $n_0$ must be high enough so that the winding temperature in all windings is uniform and stationary ( $n_0 = 100 \text{ min}^{-1}$ for 8JS three-phase synchronous motors). The continuous torque is reduced while stationary.
Stall current	$I_0$	A	The "stall current" is the effective value of the phase current (current in the motor supply line) for the generation of the "stall torque" at the speed $n_0$ . This is possible for any length of time if the environmental conditions are correct. The speed $n_0$ must be high enough so that the winding temperature in all windings is uniform and stationary ( $n_0 = 100 \text{ min}^{-1}$ for 8JS three-phase synchronous motors). The continuous current is reduced while stationary.
Peak torque	$M_{\text{max}}$	Nm	The peak torque is briefly output by the motor when the peak current is being drawn.
Maximum current	$I_{\text{max}}$	A	The peak current is the effective value of the phase current (current in the motor supply line) for the generation of the peak torque. Only possible for a short time. The peak current is determined by the magnetic circuit. Exceeding this value for a short time can cause irreversible damage (demagnetize the magnet material).
Maximum angular acceleration without brake	$a$	$\text{rad/s}^2$	Maximum acceleration of the motor without load and without brake. Value for the dynamics of the motor (corresponds to $M_{\text{max}} / J$ ).
Maximum speed	$n_{\text{max}}$	$\text{min}^{-1}$	Maximum motor speed. This is a mechanical condition (centrifugal force, bearing wear).
Average speed	$n_{\text{aver}}$	$\text{min}^{-1}$	Average speed for one cycle
Torque constant	$K_T$	$\text{Nm/A}$	The torque constant determines the torque created by the motor with $1 A_{\text{rms}}$ phase current. This value applies at a motor temperature of $20^\circ\text{C}$ . When the temperature increases, the torque constant is reduced (generally to 10%). When the current increases, the torque constant is reduced (generally starting at twice the value of the rated current).
Voltage constant	$K_E$	$\text{V}/1000\text{min}^{-1}$	The voltage constant determines the effective value (phase-phase) of the reverse voltage (EMF) induced by the motor with a speed of $1000 \text{ min}^{-1}$ . This value applies at a motor temperature of $20^\circ\text{C}$ . When the temperature increases, the voltage constant is reduced (generally to 5%). When the current increases, the voltage constant is reduced (generally starting at twice the value of the rated current).
Stator resistance	$R_{2\text{ph}}$	$\Omega$	Resistance measured in ohms between two motor leads (phase-phase) at $20^\circ\text{C}$ winding temperature. On B&R motors, the windings use a star connection.
Stator inductance	$L_{2\text{ph}}$	mH	Winding inductance measured between two motor leads. Stator inductance depends on the rotor position.
Electrical time constant	$t_{\text{el}}$	ms	Corresponds to 1/5 of the time needed for the stator current to stabilize with constant operating conditions.
Thermal time constant	$t_{\text{therm}}$	min	Corresponds to 1/5 of the time needed for the motor temperature to stabilize with constant operating conditions.
Moment of inertia without brake	$J$	$\text{kgcm}^2$	Moment of inertia for the motor without holding brake.
Weight without brake	$m$	kg	Weight of the motor without holding brake.
Moment of inertia of brake	$J_{\text{Br}}$	$\text{kgcm}^2$	Moment of inertia for the built-in holding brake.
Weight of brake	$m_{\text{Br}}$	kg	Weight of the built-in holding brake.
Brake holding torque	$M_{\text{Br}}$	Nm	Minimum torque required to hold the rotor when the brake is activated.
Installed load	$P_{\text{in}}$	W	Installed load for the built-in holding brake.
Installed current	$I_{\text{in}}$	A	Installed current for the built-in holding brake.
Installed voltage	$U_{\text{in}}$	V	Operating voltage for the built-in holding brake.
Activation delay	$t_{\text{on}}$	ms	Delay time required for the holding torque of the brake to be established after the operating voltage has been removed from the holding brake.
Release delay	$t_{\text{off}}$	ms	Delay time required until the holding torque of the holding brake is reduced by 90% (the brake is released) after the operating voltage has been returned to the holding brake.

# Product overview

The technical data listed in this section ( $K_E$ ,  $K_T$ ,  $I_{Nr}$ ,  $I_{or}$ ,  $I_{max}$ ,  $R_{2ph}$ ,  $L_{2ph}$ ,  $t_{el}$ ,  $t_{therm}$ ,  $m$ ,  $J$ ) has a theoretical tolerance range of  $\pm 10\%$ . This is also valid for the speed - torque characteristic curves represented in the following sections.

Motor	8.JSA22.ee080ffg-0	8.JSA24.ee080ffg-0	8.JSA31.ee050ffg-0	8.JSA32.ee030ffg-0	8.JSA32.ee055ffg-0	8.JSA32.ee045ffg-0	8.JSA42.ee035ffg-0	8.JSA43.ee050ffg-0	8.JSA44.ee040ffg-0	8.JSA51.ee045ffg-0
Rated speed $n_N$ [min <sup>-1</sup> ]	8000	8000	5000	3000	5500	4500	3500	5000	4000	4500
Number of poles	6	6	8	8	8	8	10	10	10	10
Rated torque $M_N$ [Nm]	0.7	1.1	1	1.9	1.7	2.3	2.8	3	3.8	3
Rated power $P_N$ [kW]	0.59	0.92	0.52	0.6	0.98	1.08	1.03	1.57	1.59	1.41
Rated current $I_N$ [A]	1.11	1.76	1.18	1.33	1.79	2.13	2.23	3.04	3.16	4.65
Stall torque $M_0$ [Nm] <sup>1)</sup>	0.8	1.41	1.15	2	2	2.8	3.4	4.8	5.9	4.7
Stall current $I_0$ [A]	1.39	2.21	1.37	1.4	2.2	2.6	2.7	4.9	5	7.5
Peak torque $M_{max}$ [Nm]	2.73	4.76	3.88	6.92	7.05	9.96	11.3	16.1	20.2	11.9
Peak current $I_{max}$ [A]	5.6	8.8	5.5	5.7	8.9	10.3	11	19.5	20	22.6
Maximum angular acceleration without brake $a$ [rad/s <sup>2</sup> ]	248182	176296	117576	117288	119492	117177	75333	76667	74815	35000
Maximum speed $n_{max}$ [min <sup>-1</sup> ]	8000	8000	8000	8000	8000	8000	6000	6000	6000	6000
Torque constant $K_T$ [Nm/A]	0.61	0.63	0.85	1.4	0.92	1.1	1.26	0.99	1.19	0.65
Voltage constant $K_E$ [V/1000 min <sup>-1</sup> ]	38.75	40.84	54.45	90.06	58.64	70.16	80.63	63.88	76.45	41.89
Stator resistance $R_{2ph}$ [Ω]	19.4	9	21.4	23.76	10.3	9.01	7.78	2.81	2.8	1.16
Stator inductance $L_{2ph}$ [mH]	35.5	18.7	37.5	46.5	20.1	18.5	26.8	10.8	11.5	5.2
Electrical time constant $t_{el}$ [ms]	1.8	2.1	1.8	2	2	2.1	3.4	3.8	4.1	4.5
Thermal time constant $t_{therm}$ [min]	9	11	14	17	17	20	17	20	24	20
Moment of inertia without brake $J$ [kgcm <sup>2</sup> ]	0.16	0.27	0.33	0.59	0.59	0.85	1.5	2.1	2.7	3.4
Weight without brake $m$ [kg]	1.1	1.66	1.6	2.2	2.2	2.9	3.4	4.35	5.3	4.2
<b>Holding brake</b>										
Moment of inertia for brake $J_{br}$ [kgcm <sup>2</sup> ]	0.01	0.01	0.011	0.011	0.011	0.011	0.068	0.068	0.068	0.173
Weight of brake $m_{br}$ [kg]	0.27	0.27	0.35	0.35	0.35	0.35	0.63	0.63	0.63	1.1
Holding torque of the brake $M_{br}$ [Nm]	1.42	1.42	2.5	2.5	2.5	2.5	6	6	6	14.5
<b>Recommendations</b>										
Cross section for B&R motor cables [mm <sup>2</sup> <sup>2)</sup>	1.5	1.5	1.5	1.5	1.5	1.5	1.5	1.5	1.5	1.5
ACOPOS	≧ 1314	≧ 1314	≧ 1314	≧ 1314	≧ 1314	≧ 1314	≧ 1314	≧ 1314	≧ 1314	≧ 1314
ACOPOSmulti	≧ 1425	≧ 1425	≧ 1425	≧ 1425	≧ 1425	≧ 1425	≧ 1425	≧ 1425	≧ 1425	≧ 1425
ACOPOS servo drive 8Vxxxx.00-x <sup>3)</sup>	1016	1045	1016	1016	1045	1045	1045	1090	1090	1090
ACOPOSmulti inverter module 8BVI... <sup>4)</sup>	0014	0028	0014	0014	0028	0028	0028	0055	0055	0055

1) The values decrease depending on the motor option (see data sheet for details).

2) The B&R motor cables with this cable cross section are produced optimally (cables stripped to the correct length) for the recommended ACOPOS servo drive or the recommended ACOPOSmulti inverter module. B&R motor cables with other cable cross sections can normally be used (within the specified terminal cross section range) and can be obtained from B&R in the desired design upon request.

3) The recommended servo drive is defined for 1.1x the stall current of the motor. If more than double the stall torque is required during the acceleration phase, the next larger servo drive should be selected. This recommendation is only a guideline, a detailed inspection of the corresponding speed - torque characteristic curve can result in deviations of the servo drive size (one size larger or smaller).

4) The recommended ACOPOSmulti inverter module is defined for 1.1x the stall current of the motor. If more than double the stall torque is required during the acceleration phase, the next larger inverter module should be selected. This recommendation is only a guideline, a detailed inspection of the corresponding speed - torque characteristic curve can result in deviations of the inverter module size (one size larger or smaller).

Motor	8JS A52.ee045ffgg-0	8JS A54.ee028ffgg-0	8JS A54.ee050ffgg-0	8JS A62.ee030ffgg-0	8JS A63.ee023ffgg-0	8JS A64.ee030ffgg-0	8JS A65.ee025ffgg-0	8JS A72.ee020ffgg-0	8JS A73.ee024ffgg-0	8JS A74.ee018ffgg-0
Rated speed $n_N$ [min <sup>-1</sup> ]	4500	2750	5000	3000	2250	3000	2500	2000	2400	1800
Number of poles	10	10	10	10	10	10	10	10	10	10
Rated torque $M_N$ [Nm]	5.2	11.3	7.1	9.4	13.9	15.6	19.2	23.6	28.5	39.6
Rated power $P_N$ [kW]	2.45	3.25	3.72	2.95	3.35	4.9	5.03	4.94	7.16	7.46
Rated current $I_N$ [A]	4.4	6.01	6.24	5.84	6.42	9.4	10.38	10.13	13.38	13.94
Stall torque $M_0$ [Nm] <sup>1)</sup>	8.7	14.7	14.1	12.2	17.1	21	25	30	41.6	52.5
Stall current $I_0$ [A]	7.4	7.8	12.5	7.6	7.9	12.8	13.6	13	19.5	18.5
Peak torque $M_{max}$ [Nm]	22	37	37.54	30	42.5	54.1	65.2	79.7	111	142
Peak current $I_{max}$ [A]	22.1	23.3	37.5	22.7	23.6	38.4	40.9	38.9	58.6	55.5
Maximum angular acceleration without brake $a$ [rad/s <sup>2</sup> ]	35484	30833	31283	17647	17562	16906	16300	12262	12065	11833
Maximum speed $n_{max}$ [min <sup>-1</sup> ]	6000	6000	6000	6000	6000	6000	6000	6000	6000	6000
Torque constant $K_T$ [Nm/A]	1.17	1.88	1.13	1.61	2.16	1.66	1.85	2.33	2.13	2.84
Voltage constant $K_E$ [V/1000 min <sup>-1</sup> ]	75.4	120.43	73.3	103.67	138.23	106.81	119.38	149.75	137.18	183.26
Stator resistance $R_{2ph}$ [Ω]	1.45	1.58	0.65	1.65	1.7	0.75	0.73	0.69	0.38	0.47
Stator inductance $L_{2ph}$ [mH]	7.8	9.6	3.5	13.4	14.6	6.2	6.1	10.8	5.9	7.7
Electrical time constant $t_{el}$ [ms]	5.4	6.1	5.4	8.1	8.6	8.3	8.4	15.7	15.5	16.4
Thermal time constant $t_{therm}$ [min]	24	31	31	20	25	30	35	46	53	60
Moment of inertia without brake $J$ [kgcm <sup>2</sup> ]	6.2	12	12	17	24.2	32	40	65	92	120
Weight without brake $m$ [kg]	5.8	9	9	8.9	11.1	13.3	15.4	19.7	26.7	33.6
<b>Holding brake</b>										
Moment of inertia for brake $J_B$ [kgcm <sup>2</sup> ]	0.173	0.173	0.173	0.61	0.61	0.61	0.61	1.64	1.64	1.64
Weight of brake $m_B$ [kg]	1.1	1.1	1.1	2	2	2	2	2.1	2.1	2.1
Holding torque of the brake $M_B$ [Nm]	14.5	14.5	14.5	25	25	25	25	53	53	53
<b>Recommendations</b>										
Cross section for B&R motor cables [mm <sup>2</sup> ] <sup>2)</sup>	1.5	1.5	4	1.5	1.5	4	4	4	4	4
ACOPOS	▮ 1314	▮ 1314	▮ 1315	▮ 1314	▮ 1314	▮ 1315	▮ 1315	▮ 1315	▮ 1315	▮ 1315
ACOPOSmulti	▮ 1425	▮ 1425	▮ 1426	▮ 1425	▮ 1425	▮ 1426	▮ 1426	▮ 1426	▮ 1426	▮ 1426
ACOPOS servo drive 8Vxxx.00-x <sup>3)</sup>	1090	1090	1180	1090	1090	1180	1180	1180	1320	1320
ACOPOSmulti inverter module 8BVI... <sup>4)</sup>	0110	0110	0110	0110	0110	0110	0110	0110	0220	0220

1) The values decrease depending on the motor option (see data sheet for details).

2) The B&R motor cables with this cable cross section are produced optimally (cables stripped to the correct length) for the recommended ACOPOS servo drive or the recommended ACOPOSmulti inverter module. B&R motor cables with other cable cross sections can normally be used (within the specified terminal cross section range) and can be obtained from B&R in the desired design upon request.

3) The recommended servo drive is defined for 1.1x the stall current of the motor. If more than double the stall torque is required during the acceleration phase, the next larger servo drive should be selected. This recommendation is only a guideline, a detailed inspection of the corresponding speed - torque characteristic curve can result in deviations of the servo drive size (one size larger or smaller).

4) The recommended ACOPOSmulti inverter module is defined for 1.1x the stall current of the motor. If more than double the stall torque is required during the acceleration phase, the next larger inverter module should be selected. This recommendation is only a guideline, a detailed inspection of the corresponding speed - torque characteristic curve can result in deviations of the inverter module size (one size larger or smaller).

# 8JSA2



Technical data	8JSA22.ee080ffgg-0	8JSA24.ee080ffgg-0
Rated speed $n_N$ [min <sup>-1</sup> ]	8000	8000
Number of poles	6	6
Rated torque $M_N$ [Nm]	0.7	1.1
Rated power $P_N$ [kW]	0.59	0.92
Rated current $I_N$ [A]	1.11	1.76
Stall torque $M_0$ [Nm] <sup>1)</sup>	0.8	1.41
Stall current $I_0$ [A]	1.39	2.21
Peak torque $M_{max}$ [Nm]	2.73	4.76
Peak current $I_{max}$ [A]	5.6	8.8
Maximum angular acceleration without brake $a$ [rad/s <sup>2</sup> ]	248182	176296
Maximum speed $n_{max}$ [min <sup>-1</sup> ]	8000	8000
Torque constant $K_T$ [Nm/A]	0.61	0.63
Voltage constant $K_E$ [V/1000 min <sup>-1</sup> ]	38.75	40.84
Stator resistance $R_{2ph}$ [ $\Omega$ ]	19.4	9
Stator inductance $L_{2ph}$ [mH]	35.5	18.7
Electrical time constant $t_{el}$ [ms]	1.8	2.1
Thermal time constant $t_{therm}$ [min]	9	11
Moment of inertia without brake $J$ [kgcm <sup>2</sup> ]	0.16	0.27
Weight without brake $m$ [kg]	1.1	1.66
<b>Holding brake</b>		
Moment of inertia for brake $J_{br}$ [kgcm <sup>2</sup> ]	0.01	0.01
Weight of brake $m_{br}$ [kg]	0.27	0.27
Holding torque of the brake $M_{br}$ [Nm]	1.42	1.42
<b>Recommendations</b>		
Cross section for B&R motor cables [mm <sup>2</sup> ] <sup>2)</sup>	1.5	1.5
ACOPOS <sup>3)</sup>	≧ 1314	≧ 1314
ACOPOSmulti	≧ 1425	≧ 1425
ACOPOS servo drive 8Vxxxx.00-x <sup>3)</sup>	1016	1045
ACOPOSmulti inverter module 8BVI... <sup>4)</sup>	0014	0028

1) Flange design: Aluminum, 254 mm x 254 mm x 6.35 mm. The values decrease as follows depending on the motor option (the respective rated values also decrease simultaneously):

- Holding brake: 8JSA22: 0.01 Nm / 8JSA24: 0.05 Nm

- EnDat encoder: No reduction

- Holding brake + EnDat encoder: 8JSA22: 0.02 Nm / 8JSA24: 0.12 N

2) The B&R motor cables with this cable cross section are produced optimally (cables stripped to the correct length) for the recommended ACOPOS servo drive or the recommended ACOPOSmulti inverter module. B&R motor cables with other cable cross sections can also be used (within the specified terminal cross section range) and can be obtained from B&R in the desired design on request.

3) The recommended servo drive is defined for 1.1x the stall current of the motor; if more than 2x the stall torque is required during the acceleration phase, the next larger servo drive should be selected.

This recommendation is only a guideline, detailed inspection of the corresponding speed - torque characteristic curve can result in deviations of the servo drive size (one size larger or smaller).

4) The recommended ACOPOSmulti inverter module is defined for 1.1x the stall current of the motor; if more than double the stall torque is required during the acceleration phase, the next larger inverter module should be selected. This recommendation is only a guideline, detailed inspection of the corresponding speed - torque characteristic curve can result in deviations of the inverter module size (one size larger or smaller).

### Speed-torque characteristic curves with 400 VAC supply voltage

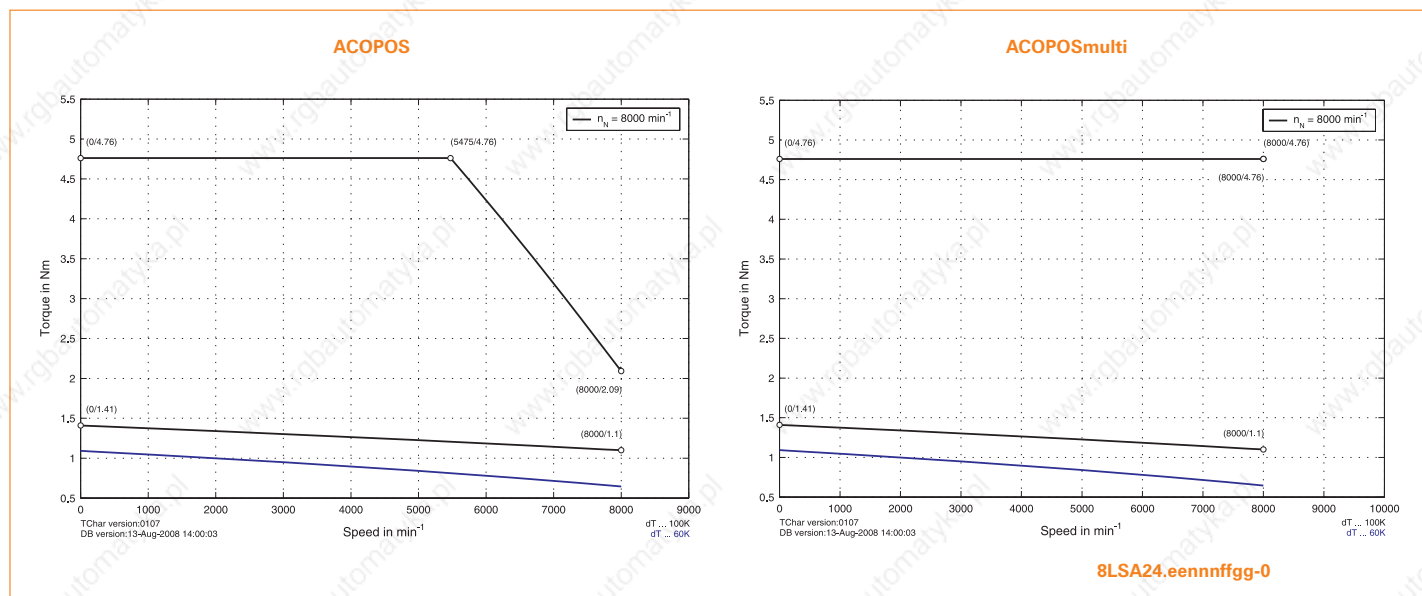
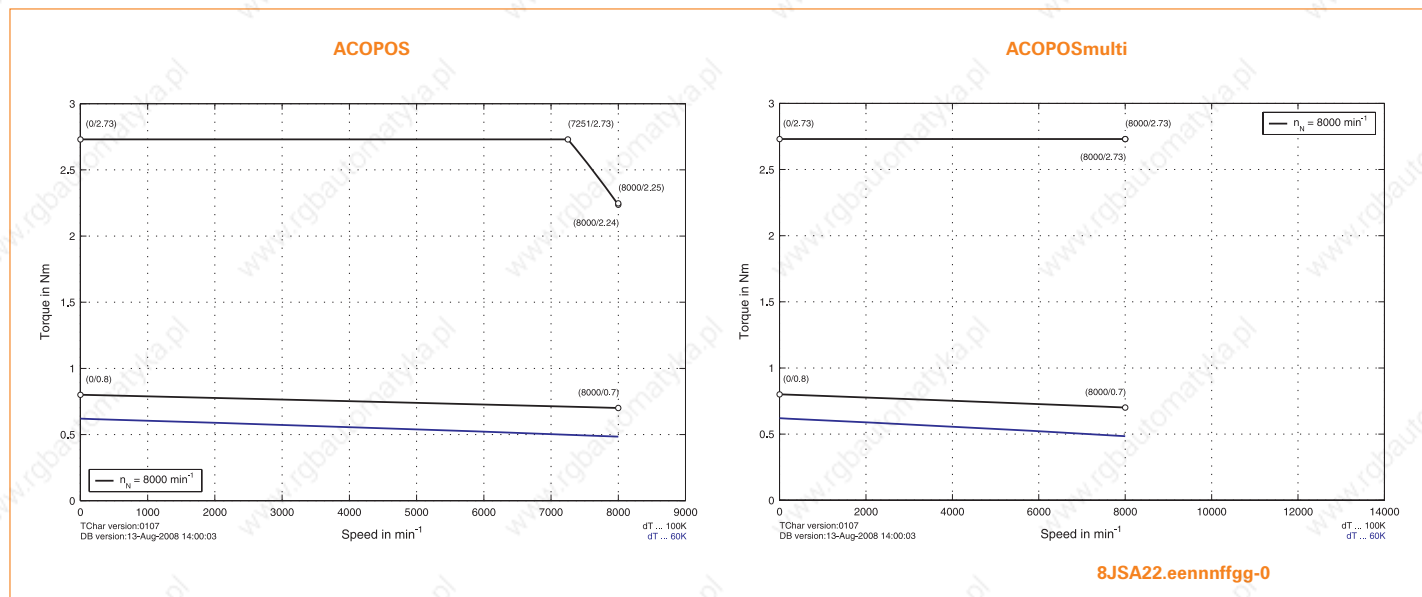

# 8JSA2

## Speed-torque characteristic curves with 230 VAC supply voltage

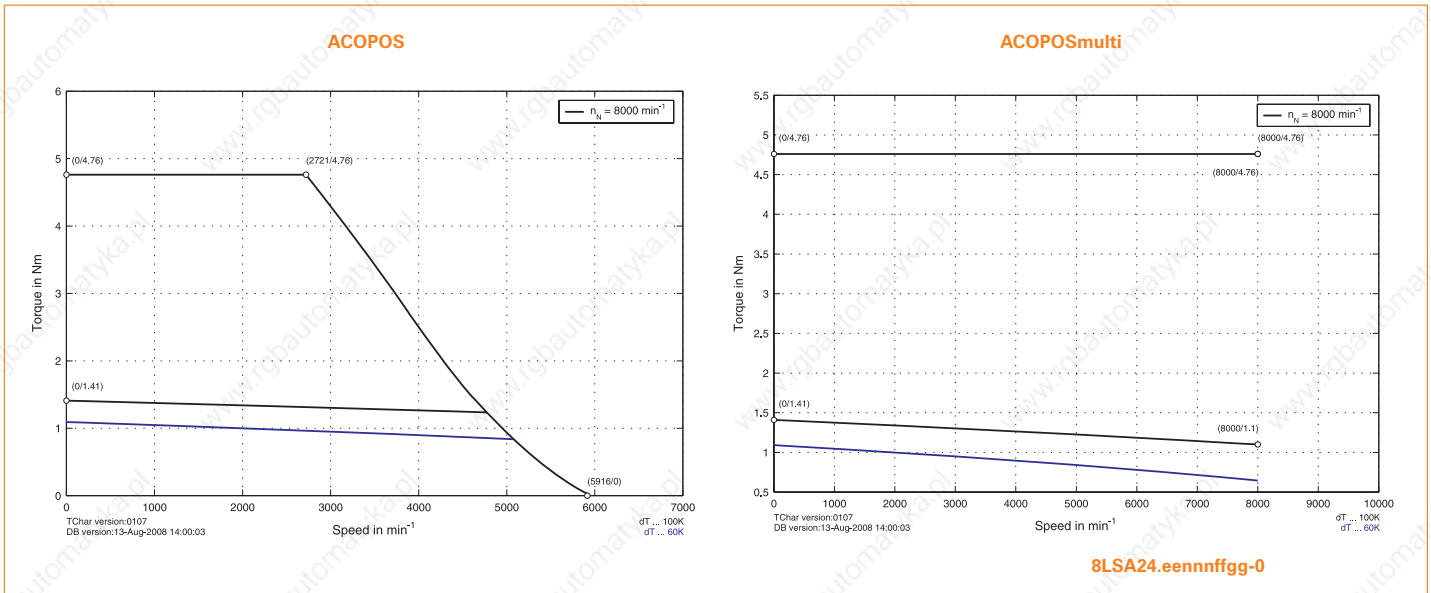
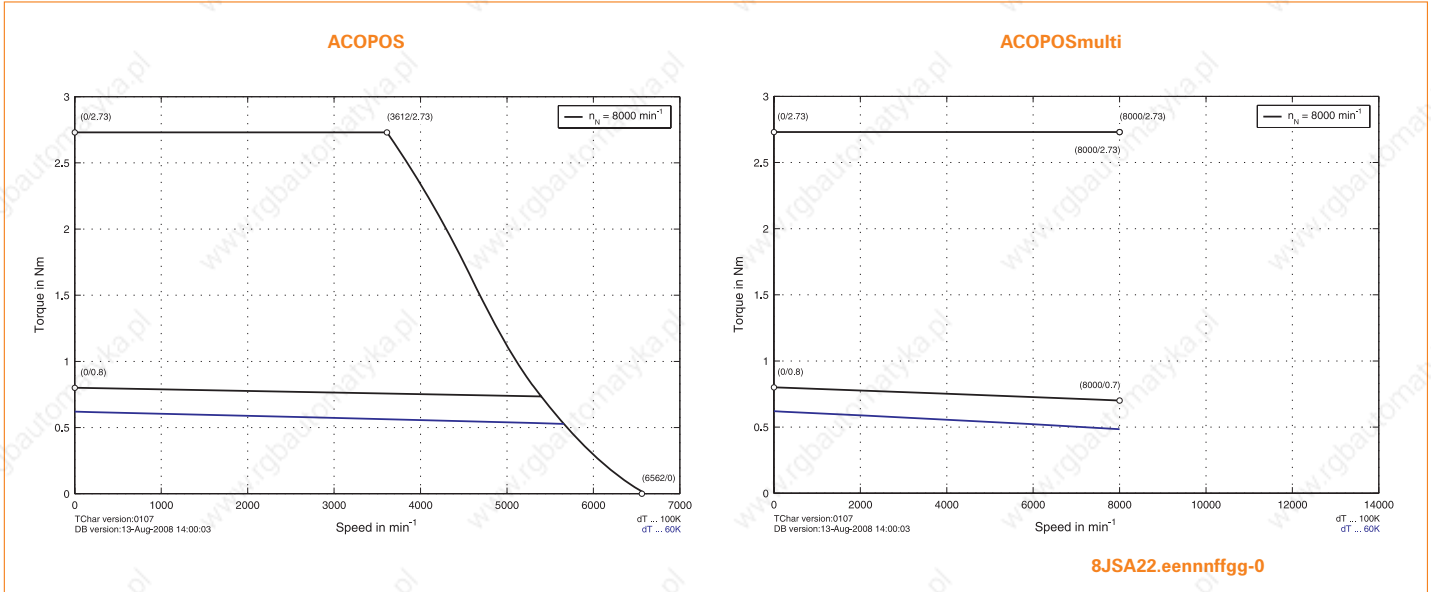

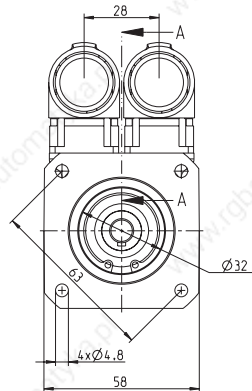
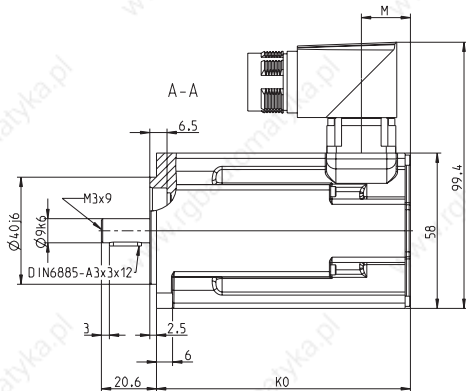

Dimensions

EnDat feedback		Resolver feedback		Extension of $K_0$ depending on the motor option [mm]			
Model number	$K_0$	M	Model number	$K_0$	M	Holding brake	Oil seal
8JSA22.Exnnnffgg-0	95.4	19.3	8JSA22.R0nnnffgg-0	95.4	19.3	34.1	---
8JSA24.Exnnnffgg-0	133.4	19.3	8JSA24.R0nnnffgg-0	133.4	19.3	34.1	---

# 8JSA2

## Maximum shaft load

The values in the diagram below are based on a mechanical lifespan of the bearings of 20,000 operating hours.

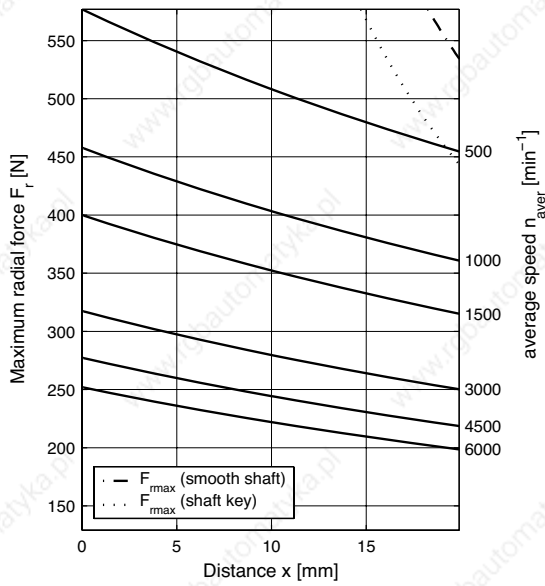

maximum allowed axial force:  $F_{amax} = 53 \text{ N}$

Recommended B&R motor cable		
	The recommended B&R motor cable for a motor depends on the recommended ACOPOS servo drive or ACOPOSmulti inverter module (see "Recommended cable cross section for B&R motor cables [ $\text{mm}^2$ ]" in the table "Technical data")	1604
Recommended B&R encoder cable		
8BCExxxx.1111A-0	ACPMulti EnDat cable, length xxxx m, $10 \times 0.14 \text{ mm}^2 + 2 \times 0.5 \text{ mm}^2$ , EnDat plug 17-pin SpeedTEC socket, servo plug 15-pin DSUB plug, can be used in cable drag chains, UL/CSA listed	1428
8BCRxxxx.1111A-0	ACPMulti Resolver cable, length xxxx m, $3 \times 2 \times 24 \text{ AWG}$ ( $19 \times 0.127$ ), resolver plug 12-pin SpeedTEC socket, servo plug 9-pin DSUB plug, can be used in cable drag chains, UL/CSA listed	1429





# 8JSA3



Technical data	8JSA31.ee050ffgg-0	8JSA32.ee030ffgg-0	8JSA32.ee055ffgg-0	8JSA33.ee045ffgg-0
Rated speed $n_N$ [min <sup>-1</sup> ]	5000	3000	5500	4500
Number of poles	8	8	8	8
Rated torque $M_N$ [Nm]	1	1.9	1.7	2.3
Rated power $P_N$ [kW]	0.52	0.6	0.98	1.08
Rated current $I_N$ [A]	1.18	1.33	1.79	2.13
Stall torque $M_0$ [Nm] <sup>1)</sup>	1.15	2	2	2.8
Stall current $I_0$ [A]	1.37	1.4	2.2	2.6
Peak torque $M_{max}$ [Nm]	3.88	6.92	7.05	9.96
Peak current $I_{max}$ [A]	5.5	5.7	8.9	10.3
Maximum angular acceleration without brake $a$ [rad/s <sup>2</sup> ]	117576	117288	119492	117177
Maximum speed $n_{max}$ [min <sup>-1</sup> ]	8000	8000	8000	8000
Torque constant $K_T$ [Nm/A]	0.85	1.4	0.92	1.1
Voltage constant $K_E$ [V/1000 min <sup>-1</sup> ]	54.45	90.06	58.64	70.16
Stator resistance $R_{2ph}$ [ $\Omega$ ]	21.4	23.76	10.3	9.01
Stator inductance $L_{2ph}$ [mH]	37.5	46.5	20.1	18.5
Electrical time constant $t_{el}$ [ms]	1.8	2	2	2.1
Thermal time constant $t_{therm}$ [min]	14	17	17	20
Moment of inertia without brake $J$ [kgcm <sup>2</sup> ]	0.33	0.59	0.59	0.85
Weight without brake $m$ [kg]	1.6	2.2	2.2	2.9
<b>Holding brake</b>				
Moment of inertia for brake $J_{br}$ [kgcm <sup>2</sup> ]	0.011	0.011	0.011	0.011
Weight of brake $m_{br}$ [kg]	0.35	0.35	0.35	0.35
Holding torque of the brake $M_{br}$ [Nm]	2.5	2.5	2.5	2.5
<b>Recommendations</b>				
Cross section for B&R motor cables [mm <sup>2</sup> ] <sup>2)</sup>	1.5	1.5	1.5	1.5
ACOPOS	≧ 1314	≧ 1314	≧ 1314	≧ 1314
ACOPOSmulti	≧ 1425	≧ 1425	≧ 1425	≧ 1425
ACOPOS servo drive 8Vxxxx.00-x <sup>3)</sup>	1016	1016	1045	1045
ACOPOSmulti inverter module 8BVI... <sup>4)</sup>	0014	0014	0028	0028

1) Flange design: Aluminum, 254 mm x 254 mm x 6.35 mm. The values decrease as follows depending on the motor option (the respective rated values also decrease simultaneously):

- Holding brake: 8JSA31: 0 Nm / 8JSA32: 0.05 Nm / 8JSA24: 0.1 Nm
- EnDat encoder: No reduction
- Holding brake + EnDat encoder: 8JSA31: 0 Nm / 8JSA32: 0.1 Nm / 8JSA24: 0.2 Nm

2) The B&R motor cables with this cable cross section are produced optimally (cables stripped to the correct length) for the recommended ACOPOS servo drive or the recommended ACOPOSmulti inverter module. B&R motor cables with other cable cross sections can also be used (within the specified terminal cross section range) and can be obtained from B&R in the desired design on request.

3) The recommended servo drive is defined for 1.1x the stall current of the motor; if more than double the stall torque is required during the acceleration phase, the next larger servo drive should be selected. This recommendation is only a guideline, detailed inspection of the corresponding speed - torque characteristic curve can result in deviations of the servo drive size (one size larger or smaller).

4) The recommended ACOPOSmulti inverter module is defined for 1.1x the stall current of the motor; if more than double the stall torque is required during the acceleration phase, the next larger inverter module should be selected. This recommendation is only a guideline, detailed inspection of the corresponding speed - torque characteristic curve can result in deviations of the inverter module size (one size larger or smaller).

Speed-torque characteristic curves with 400 VAC supply voltage

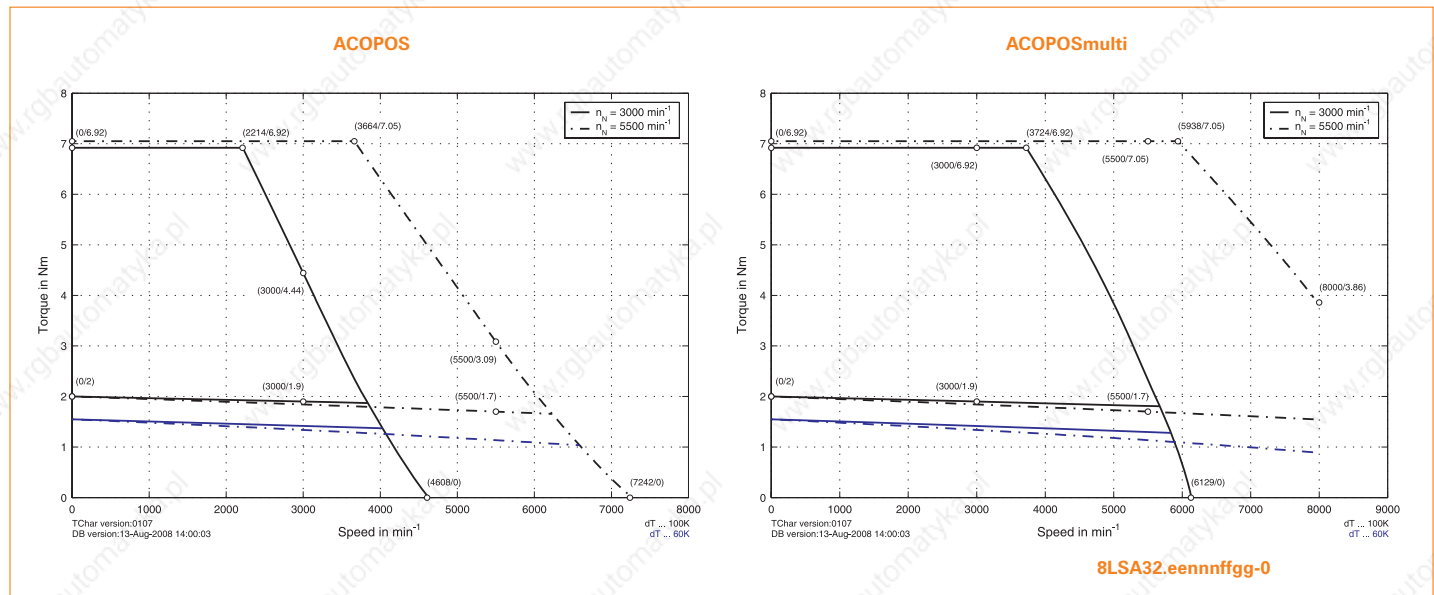
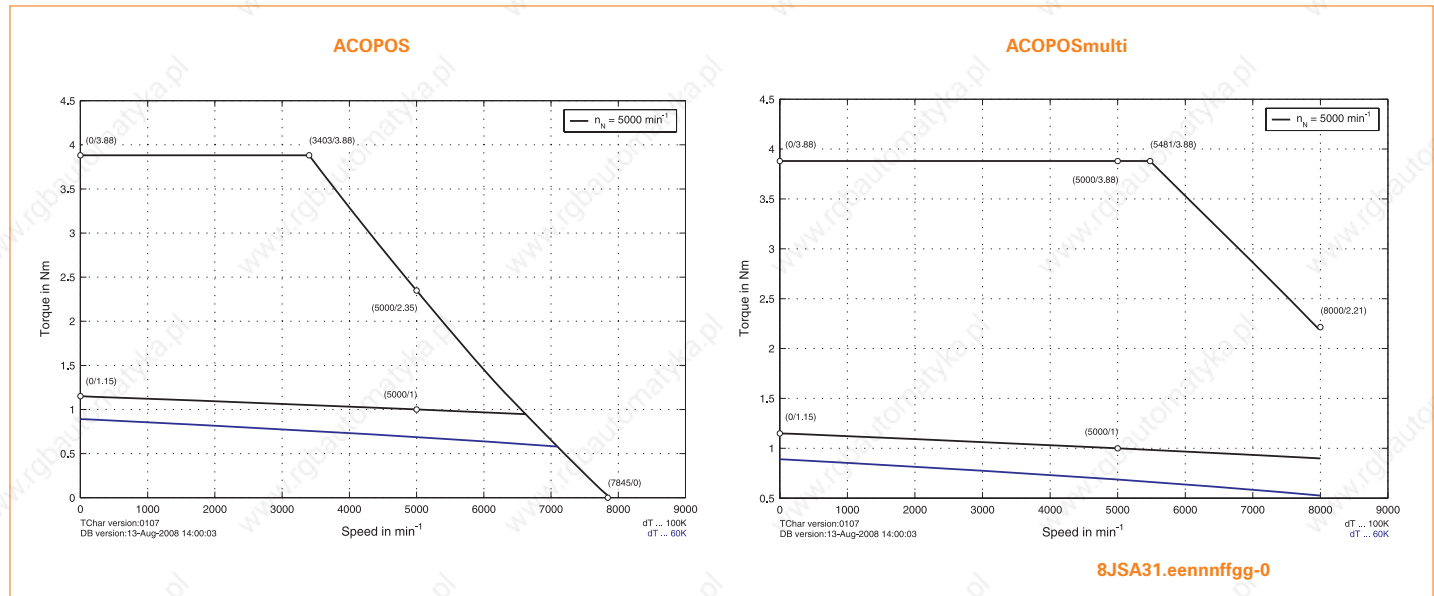

# 8JSA3

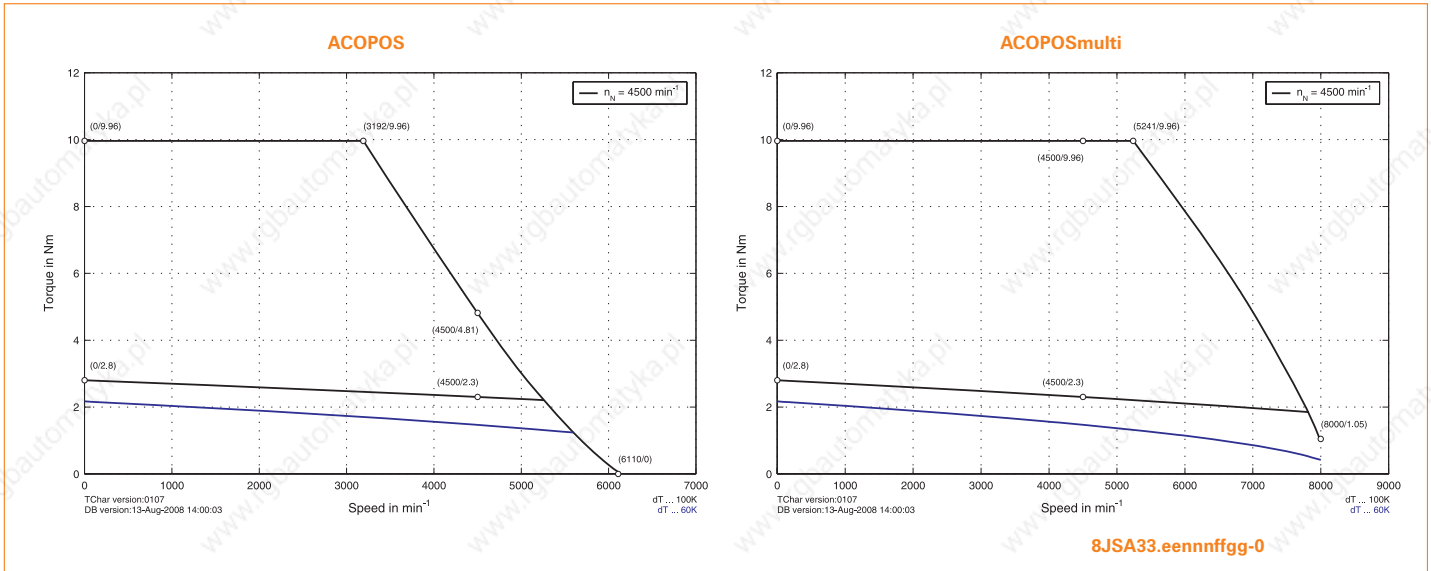

## Speed-torque characteristic curves with 230 VAC supply voltage

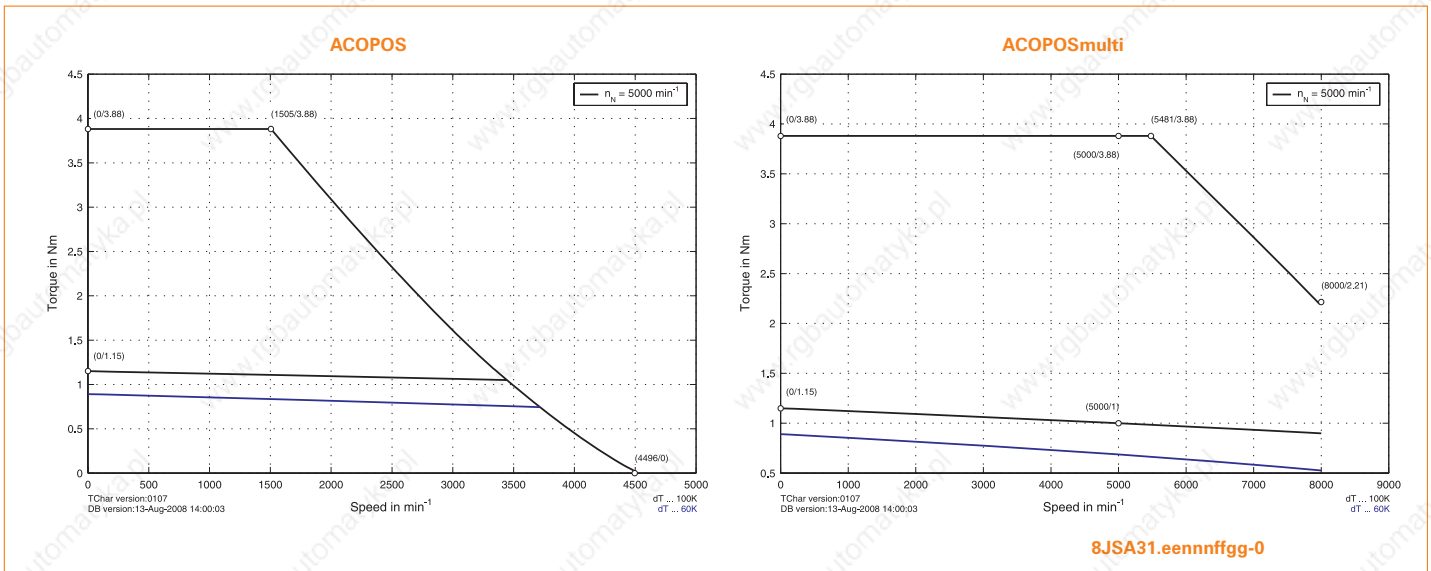

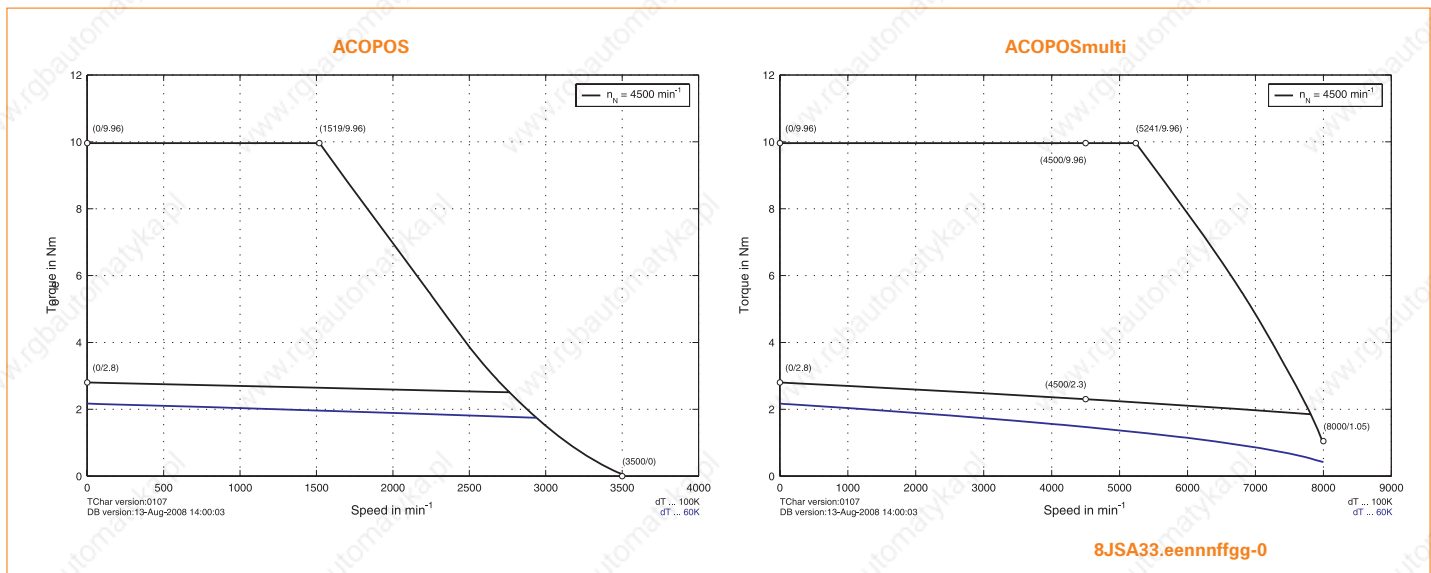
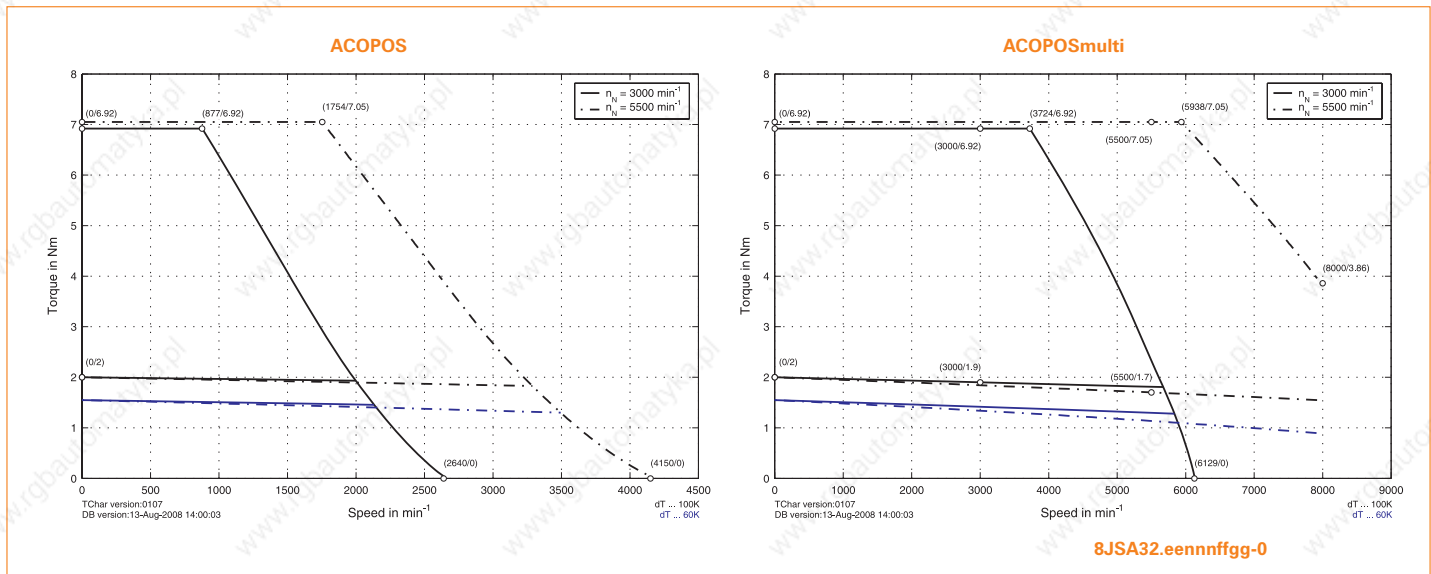

# 8JSA3

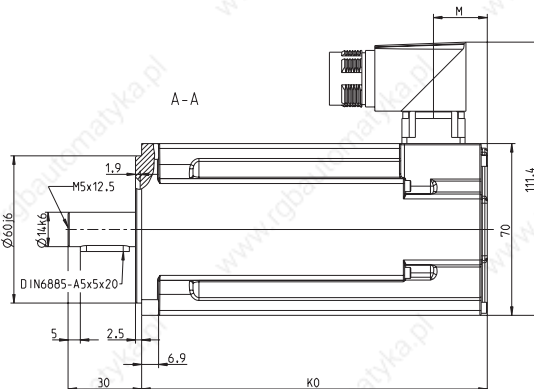
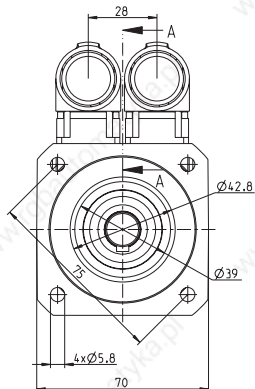

Dimensions

EnDat feedback			Resolver feedback			Extension of $K_0$ depending on the motor option [mm]	
Model number	$K_0$	M	Model number	$K_0$	M	Holding brake	Oil seal
8JSA31.Exnnnffgg-0	109.8	21.9	8JSA31.R0nnnffgg-0	109.8	21.9	32	---
8JSA32.Exnnnffgg-0	140.8	21.9	8JSA32.R0nnnffgg-0	140.8	21.9	32	---
8JSA33.Exnnnffgg-0	171.8	21.9	8JSA33.R0nnnffgg-0	171.8	21.9	32	---

### Maximum shaft load

The values in the diagram below are based on a mechanical lifespan of the bearings of 20,000 operating hours.

#### Standard bearing

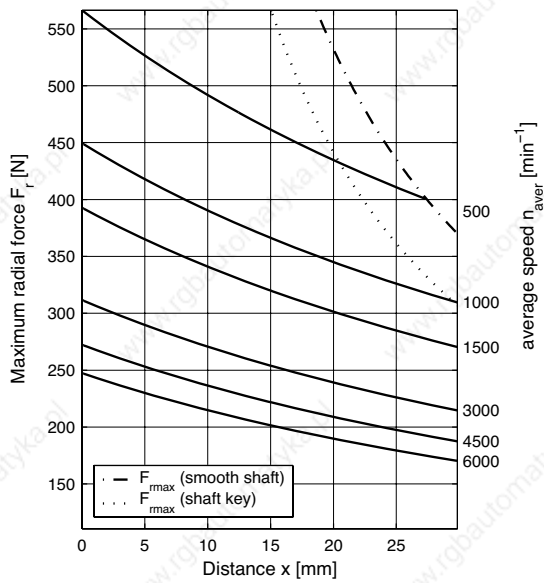

maximum allowed axial force:  $F_{amax} = 48 \text{ N}$

#### Recommended B&R motor cable

The recommended B&R motor cable for a motor depends on the recommended ACOPOS servo drive or ACOPOSmulti inverter module (see "Recommended cable cross section for B&R motor cables [ $mm^2$ ]" in the table "Technical data") 1610

#### Recommended B&R encoder cable

8BCExxxx.1111A-0	ACPMulti EnDat cable, length xxxx m, $10 \times 0.14 \text{ mm}^2 + 2 \times 0.5 \text{ mm}^2$ , EnDat plug 17-pin SpeedTEC socket, servo plug 15-pin DSUB plug, can be used in cable drag chains, UL/CSA listed	1428
8BCRxxxx.1111A-0	ACPMulti Resolver cable, length xxxx m, $3 \times 2 \times 24 \text{ AWG}$ ( $19 \times 0.127$ ), resolver plug 12-pin SpeedTEC socket, servo plug 9-pin DSUB plug, can be used in cable drag chains, UL/CSA listed	1429

# 8JSA4



Technical data	8JSA42.ee035ffgg-0	8JSA43.ee050ffgg-0	8JSA44.ee040ffgg-0
Rated speed $n_N$ [min <sup>-1</sup> ]	3500	5000	4000
Number of poles	10	10	10
Rated torque $M_N$ [Nm]	2.8	3	3.8
Rated power $P_N$ [kW]	1.03	1.57	1.59
Rated current $I_N$ [A]	2.23	3.04	3.16
Stall torque $M_0$ [Nm] <sup>1)</sup>	3.4	4.8	5.9
Stall current $I_0$ [A]	2.7	4.9	5
Peak torque $M_{max}$ [Nm]	11.3	16.1	20.2
Peak current $I_{max}$ [A]	11	19.5	20
Maximum angular acceleration without brake $a$ [rad/s <sup>2</sup> ]	75333	76667	74815
Maximum speed $n_{max}$ [min <sup>-1</sup> ]	6000	6000	6000
Torque constant $K_T$ [Nm/A]	1.26	0.99	1.19
Voltage constant $K_E$ [V/1000 min <sup>-1</sup> ]	80.63	63.88	76.45
Stator resistance $R_{2ph}$ [ $\Omega$ ]	7.78	2.81	2.8
Stator inductance $L_{2ph}$ [mH]	26.8	10.8	11.5
Electrical time constant $t_{el}$ [ms]	3.4	3.8	4.1
Thermal time constant $t_{therm}$ [min]	17	20	24
Moment of inertia without brake $J$ [kgcm <sup>2</sup> ]	1.5	2.1	2.7
Weight without brake $m$ [kg]	3.4	4.35	5.3
<b>Holding brake</b>			
Moment of inertia for brake $J_{br}$ [kgcm <sup>2</sup> ]	0.068	0.068	0.068
Weight of brake $m_{br}$ [kg]	0.63	0.63	0.63
Holding torque of the brake $M_{br}$ [Nm]	6	6	6
<b>Recommendations</b>			
Cross section for B&R motor cables [mm <sup>2</sup> ] <sup>2)</sup>	1.5	1.5	1.5
ACOPOS	≧ 1314	≧ 1314	≧ 1314
ACOPOSmulti	≧ 1425	≧ 1425	≧ 1425
ACOPOS servo drive 8Vxxxx.00-x <sup>3)</sup>	1045	1090	1090
ACOPOSmulti inverter module 8BVI... <sup>4)</sup>	0028	0055	0055

1) Flange design: Aluminum, 254 mm x 254 mm x 6.35 mm. The values decrease as follows depending on the motor option (the respective rated values also decrease simultaneously):

- Holding brake: 0.12 Nm
- EnDat encoder: 8JSA42: 0.1 Nm / 8JSA43: 0.2 Nm / 8JSA44: 0.3 Nm
- Holding brake + EnDat encoder: 8JSA42: 0.36 Nm / 8JSA43: 0.55 Nm / 8JSA44: 0.76 Nm

2) The B&R motor cables with this cable cross section are produced optimally (cables stripped to the correct length) for the recommended ACOPOS servo drive or the recommended ACOPOSmulti inverter module. B&R motor cables with other cable cross sections can also be used (within the specified terminal cross section range) and can be obtained from B&R in the desired design on request.

3) The recommended servo drive is defined for 1.1x the stall current of the motor; if more than double the stall torque is required during the acceleration phase, the next larger servo drive should be selected. This recommendation is only a guideline, detailed inspection of the corresponding speed - torque characteristic curve can result in deviations of the servo drive size (one size larger or smaller).

4) The recommended ACOPOSmulti inverter module is defined for 1.1x the stall current of the motor; if more than double the stall torque is required during the acceleration phase, the next larger inverter module should be selected. This recommendation is only a guideline, detailed inspection of the corresponding speed - torque characteristic curve can result in deviations of the inverter module size (one size larger or smaller).



### Speed-torque characteristic curves with 400 VAC supply voltage

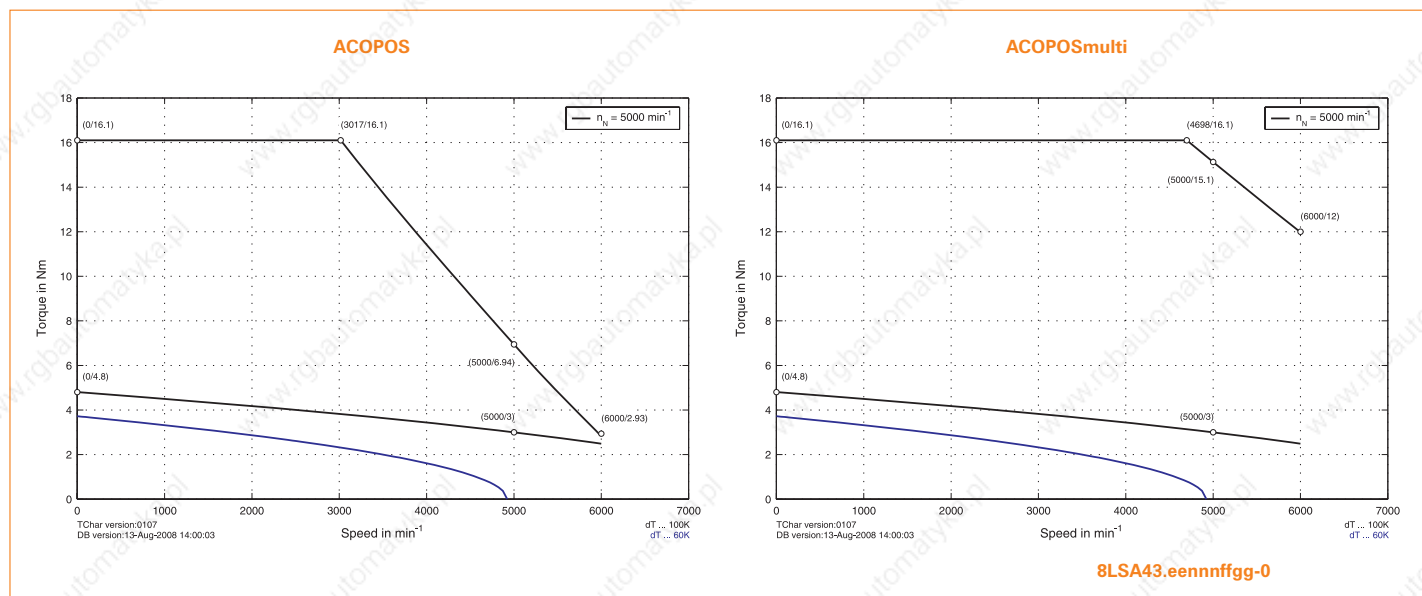
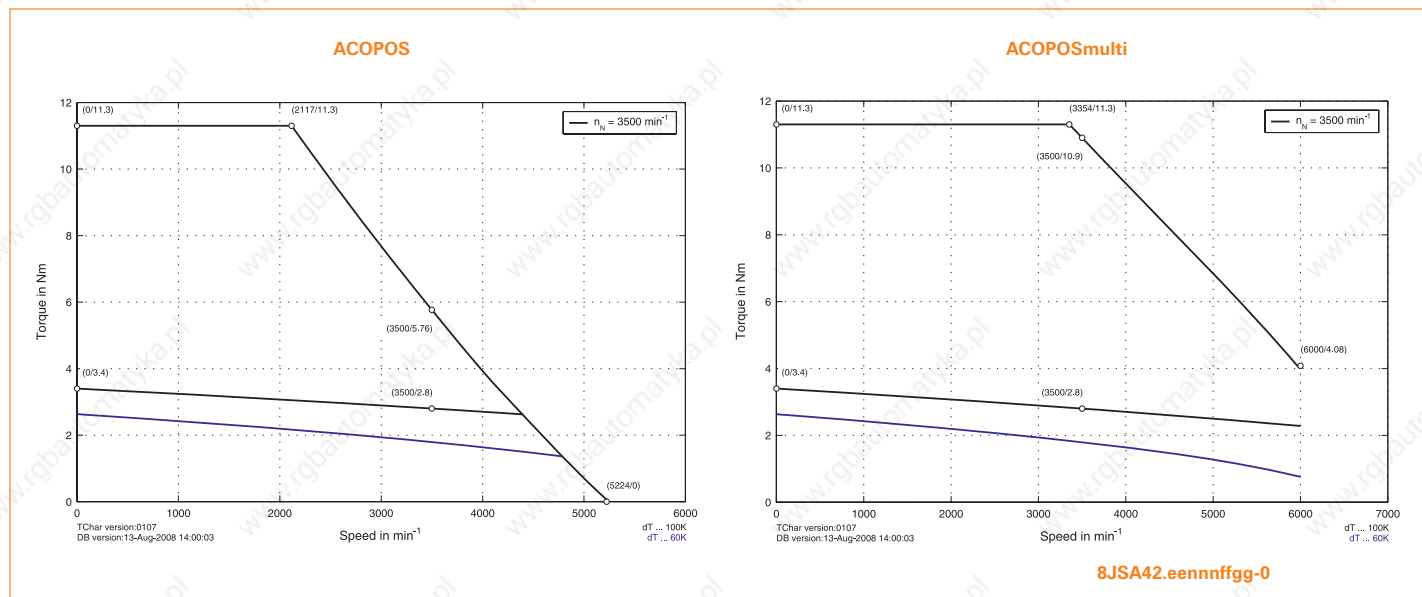

# 8JSA4

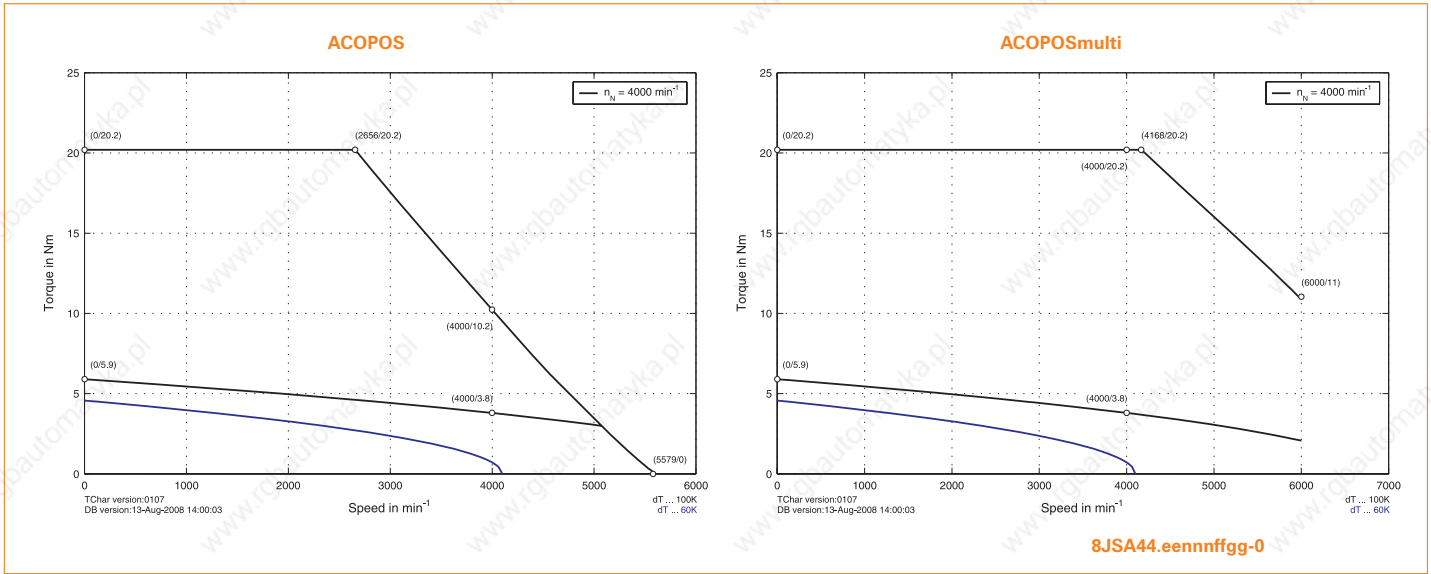

## Speed-torque characteristic curves with 230 VAC supply voltage

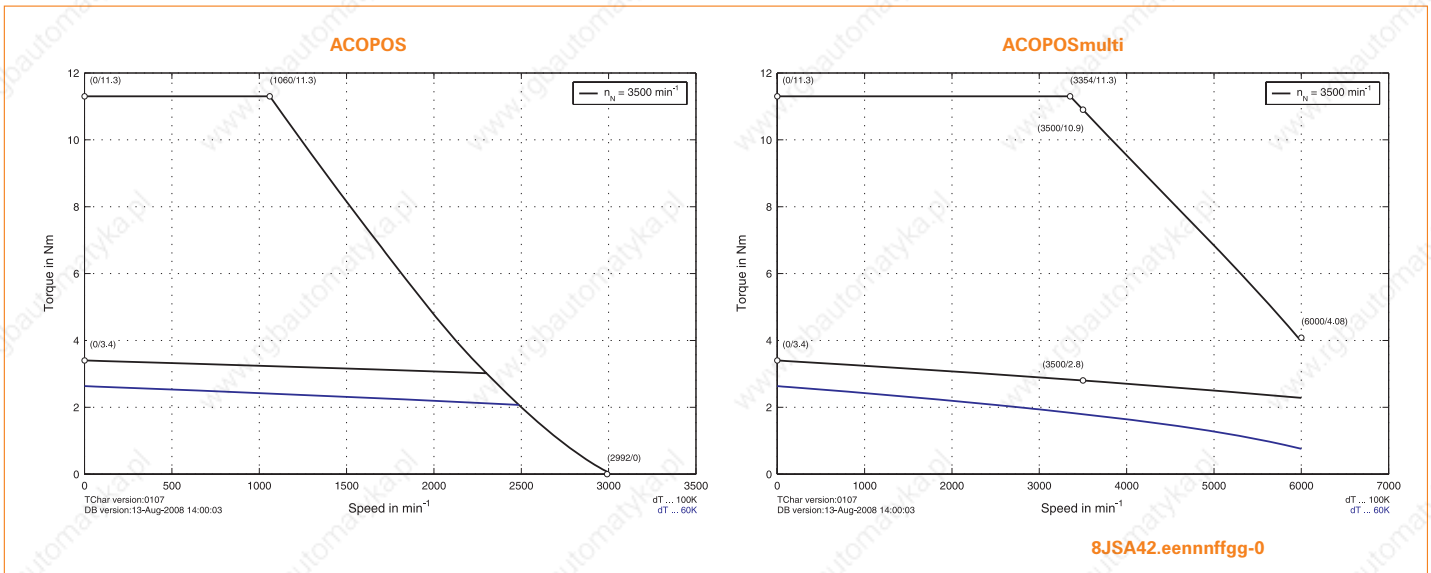

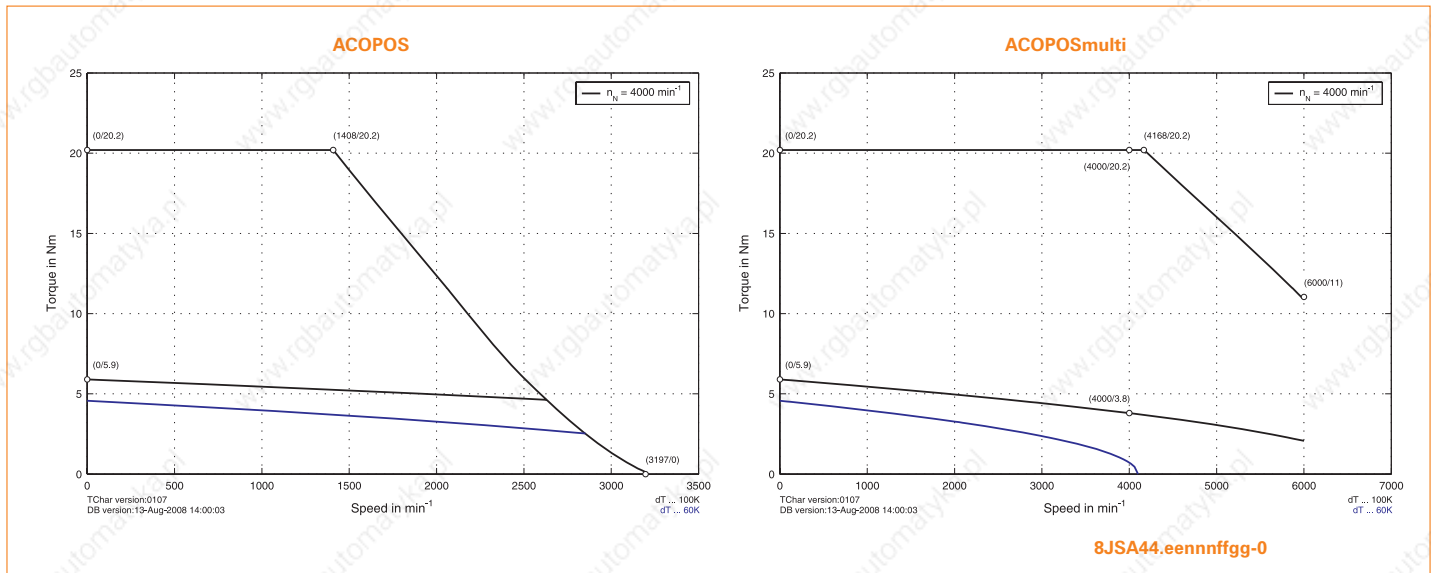
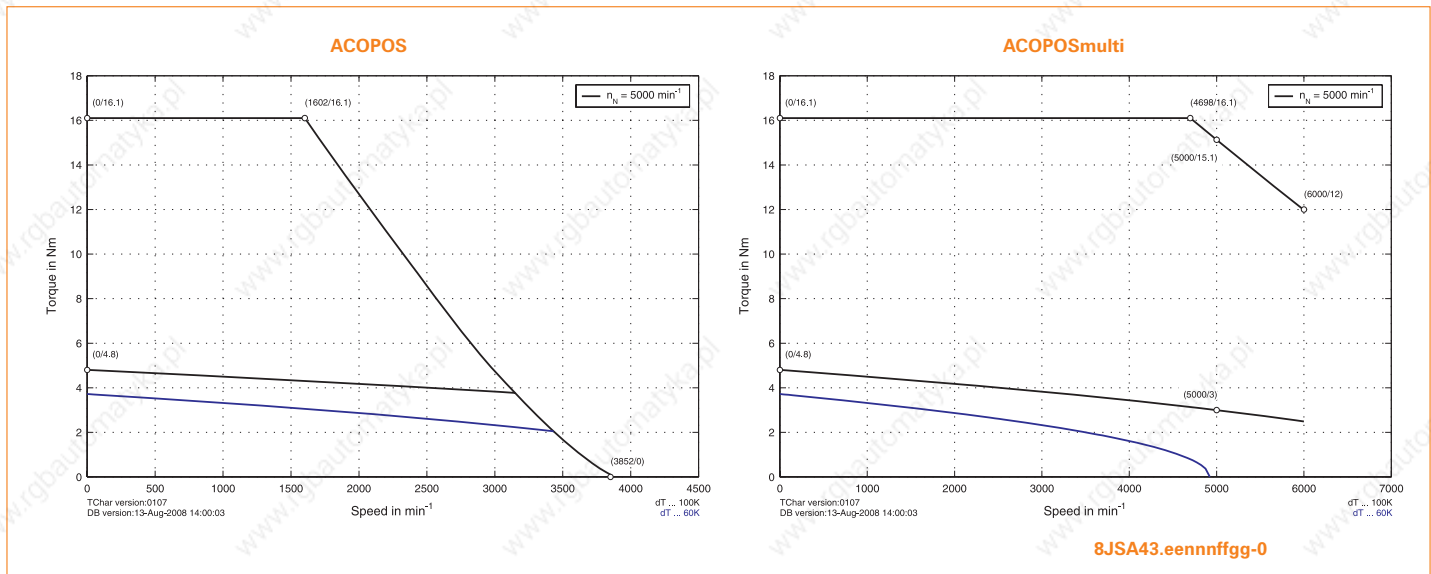



### Maximum shaft load

The values in the diagrams below are based on a mechanical lifespan of the bearings of 20,000 operating hours.

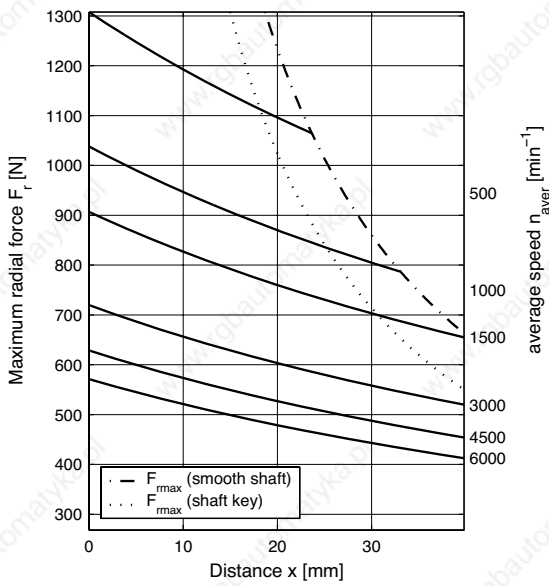

maximum allowed axial force:  $F_{amax} = 115 \text{ N}$

Recommended B&R motor cable		
	The recommended B&R motor cable for a motor depends on the recommended ACOPOS servo drive or ACOPOSmulti inverter module (see "Recommended cable cross section for B&R motor cables [ $\text{mm}^2$ ]" in the table "Technical data")	1616
Recommended B&R encoder cable		
8BCExxxx.1111A-0	ACPMulti EnDat cable, length xxxx m, $10 \times 0.14 \text{ mm}^2 + 2 \times 0.5 \text{ mm}^2$ , EnDat plug 17-pin SpeedTEC socket, servo plug 15-pin DSUB plug, can be used in cable drag chains, UL/CSA listed	1428
8BCRxxxx.1111A-0	ACPMulti Resolver cable, length xxxx m, $3 \times 2 \times 24 \text{ AWG}$ (19 x 0.127), resolver plug 12-pin SpeedTEC socket, servo plug 9-pin DSUB plug, can be used in cable drag chains, UL/CSA listed	1429

# 8JSA5



Technical data	8JSA51.ee045ffgg-0	8JSA52.ee045ffgg-0	8JSA54.ee028ffgg-0	8JSA54.ee050ffgg-0
Rated speed $n_N$ [min <sup>-1</sup> ]	4500	4500	2750	5000
Number of poles	10	10	10	10
Rated torque $M_N$ [Nm]	3	5.2	11.3	7.1
Rated power $P_N$ [kW]	1.41	2.45	3.25	3.72
Rated current $I_N$ [A]	4.65	4.4	6.01	6.24
Stall torque $M_0$ [Nm] <sup>1)</sup>	4.7	8.7	14.7	14.1
Stall current $I_0$ [A]	7.5	7.4	7.08	12.5
Peak torque $M_{max}$ [Nm]	11.9	22	37	37.54
Peak current $I_{max}$ [A]	22.6	22.1	23.3	37.5
Maximum angular acceleration without brake $a$ [rad/s <sup>2</sup> ]	35000	35484	30833	31283
Maximum speed $n_{max}$ [min <sup>-1</sup> ]	6000	6000	6000	6000
Torque constant $K_T$ [Nm/A]	0.65	1.17	1.88	1.13
Voltage constant $K_E$ [V/1000 min <sup>-1</sup> ]	41.89	75.4	120.43	73.3
Stator resistance $R_{2ph}$ [Ω]	1.16	1.45	1.58	0.65
Stator inductance $L_{2ph}$ [mH]	5.2	7.8	9.6	3.5
Electrical time constant $t_w$ [ms]	4.5	5.4	6.1	5.4
Thermal time constant $t_{therm}$ [min]	20	24	31	31
Moment of inertia without brake $J$ [kgcm <sup>2</sup> ]	3.4	6.2	12	12
Weight without brake $m$ [kg]	4.2	5.8	9	9
<b>Holding brake</b>				
Moment of inertia for brake $J_{br}$ [kgcm <sup>2</sup> ]	0.173	0.173	0.173	0.173
Weight of brake $m_{br}$ [kg]	1.1	1.1	1.1	1.1
Holding torque of the brake $M_{br}$ [Nm]	14.5	14.5	14.5	14.5
<b>Recommendations</b>				
Cross section for B&R motor cables [mm <sup>2</sup> ] <sup>2)</sup>	1.5	1.5	1.5	4
ACOPOS	≧ 1314	≧ 1314	≧ 1314	≧ 1315
ACOPOSmulti	≧ 1425	≧ 1425	≧ 1425	≧ 1426
ACOPOS servo drive 8Vxxxx.00-x <sup>3)</sup>	1090	1090	1090	1180
ACOPOSmulti inverter module 8BVI... <sup>4)</sup>	0055	0110	0110	0110

1) Flange design: Aluminum, 305 mm x 305 mm x 12.7 mm. The values decrease as follows depending on the motor option (the respective rated values also decrease simultaneously):

- Holding brake: 8JSA51: 0.15 Nm / 8JSA52: 0.26 Nm / 8JSA54: 0.43 Nm
- EnDat encoder: 8JSA51: 0.15 Nm / 8JSA52: 0.34 Nm / 8JSA54: 0.86 Nm
- Holding brake + EnDat encoder: 8JSA51: 0.39 Nm / 8JSA52: 0.76 Nm / 8JSA54: 1.55 Nm

2) The B&R motor cables with this cable cross section are produced optimally (cables stripped to the correct length) for the recommended ACOPOS servo drive or the recommended ACOPOSmulti inverter module. B&R motor cables with other cable cross sections can also be used (within the specified terminal cross section range) and can be obtained from B&R in the desired design on request.

3) The recommended servo drive is defined for 1.1x the stall current of the motor; if more than double the stall torque is required during the acceleration phase, the next larger servo drive should be selected. This recommendation is only a guideline, detailed inspection of the corresponding speed - torque characteristic curve can result in deviations of the servo drive size (one size larger or smaller).

4) The recommended ACOPOSmulti inverter module is defined for 1.1x the stall current of the motor; if more than double the stall torque is required during the acceleration phase, the next larger inverter module should be selected. This recommendation is only a guideline, detailed inspection of the corresponding speed - torque characteristic curve can result in deviations of the inverter module size (one size larger or smaller).

Speed-torque characteristic curves with 400 VAC supply voltage

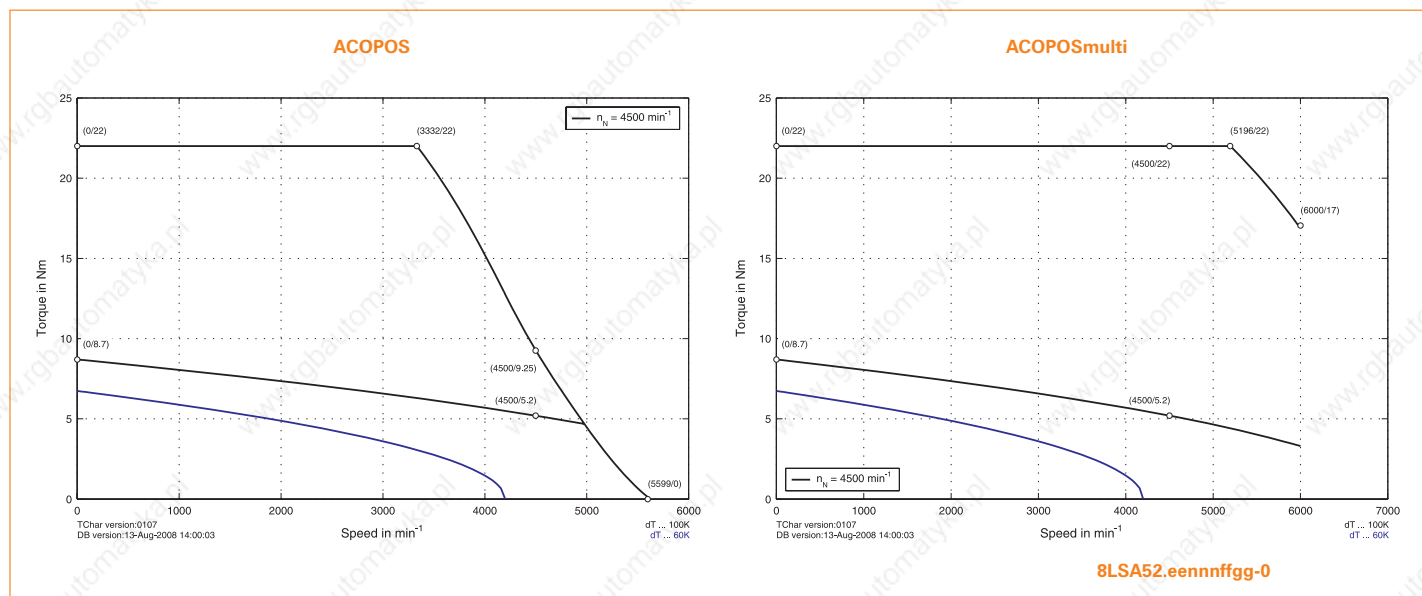
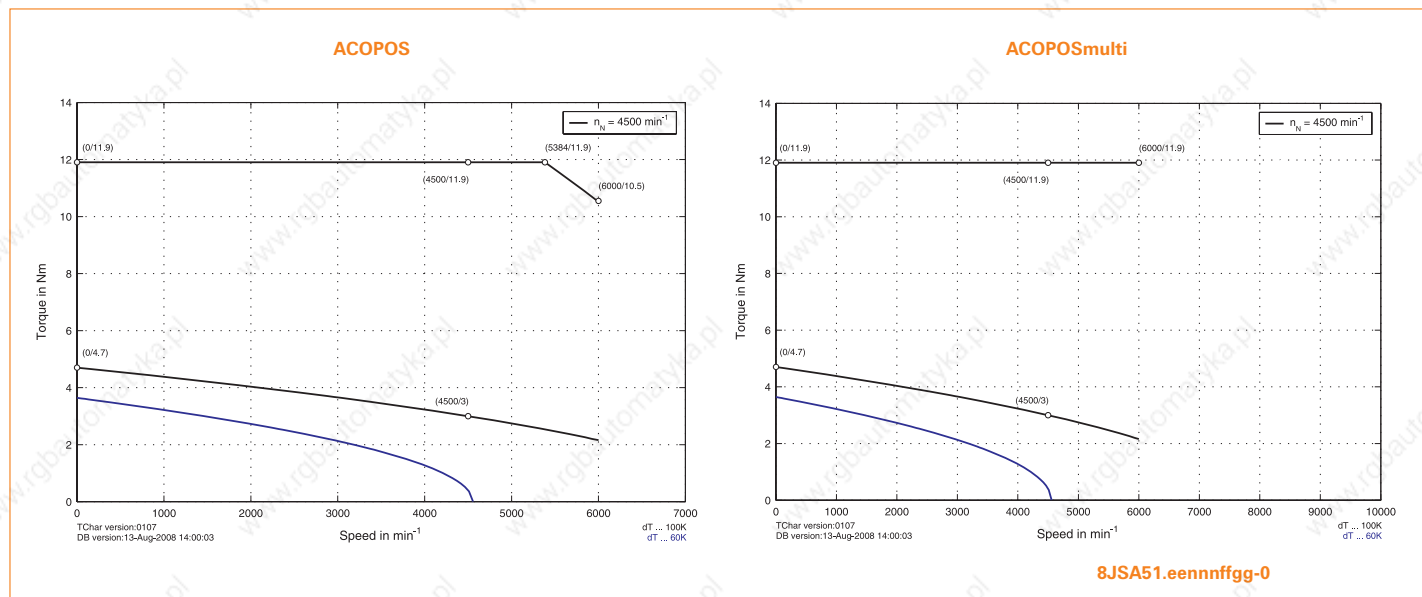

# 8JSA5

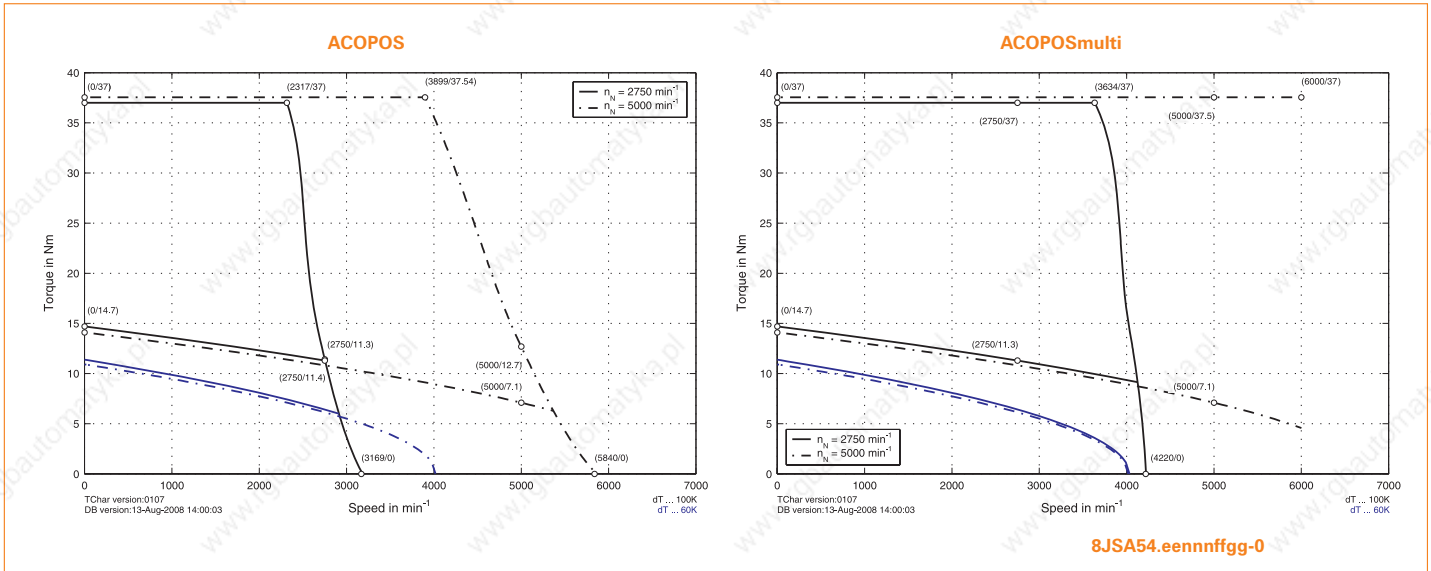

## Speed-torque characteristic curves with 230 VAC supply voltage

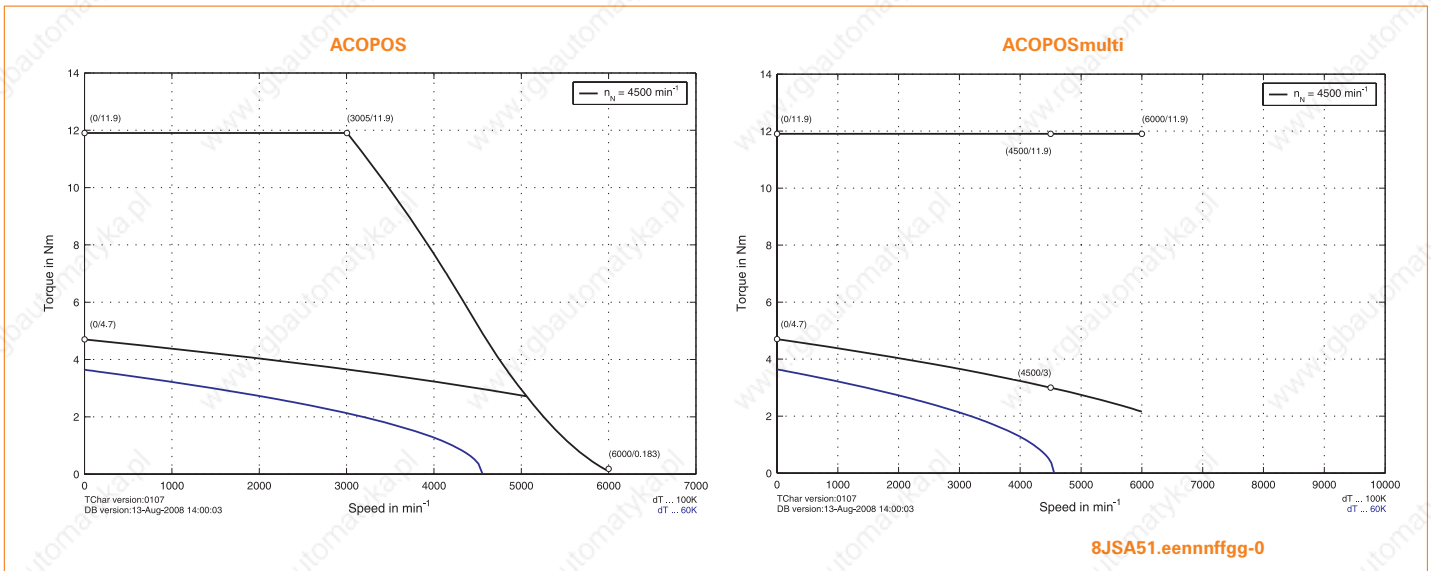



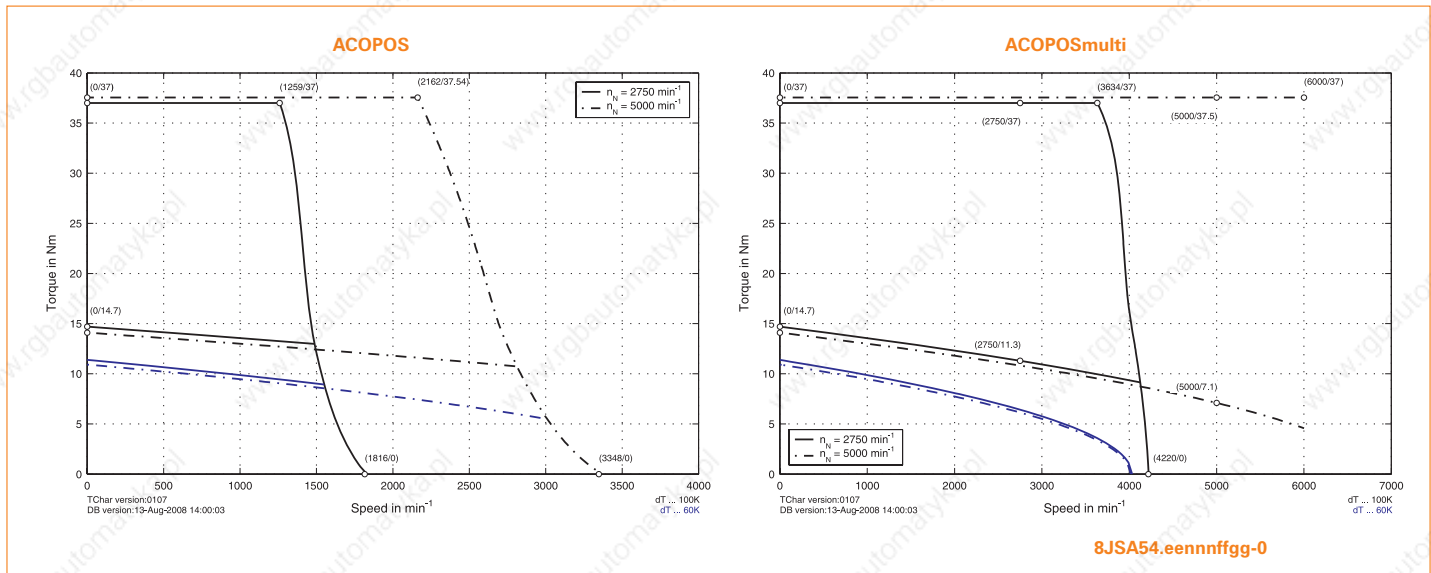
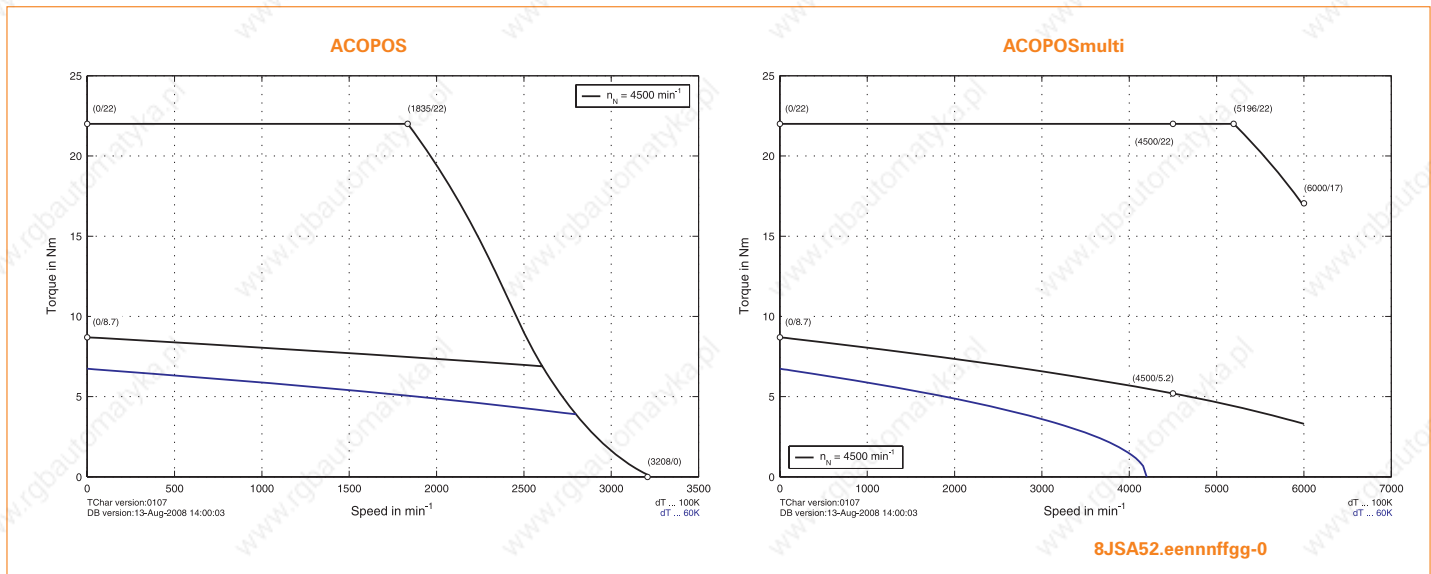

# 8JSA5

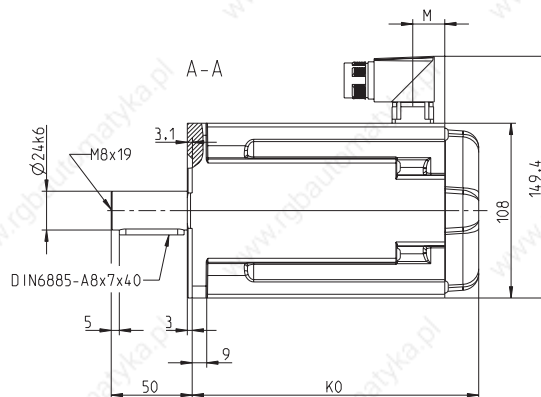
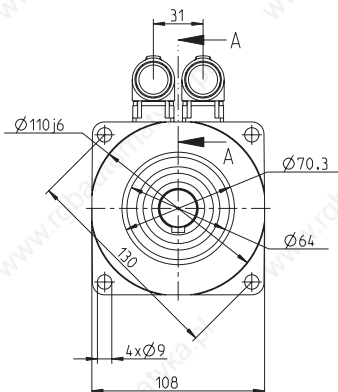

Dimensions

EnDat feedback			Resolver feedback			Extension of $K_0$ depending on the motor option [mm]	
Model number	$K_0$	M	Model number	$K_0$	M	Holding brake	Oil seal
8JSA51.Exnnffgg-0	146	40.7	8JSA51.R0nnffgg-0	127.5	22.2	45	---
8JSA52.Exnnffgg-0	177	40.7	8JSA52.R0nnffgg-0	158.5	22.2	45	---
8JSA54.Exnnffgg-0	239	40.7	8JSA54.R0nnffgg-0	220.5	22.2	45	---

### Maximum shaft load

The values in the diagram below are based on a mechanical lifespan of the bearings of 20,000 operating hours.

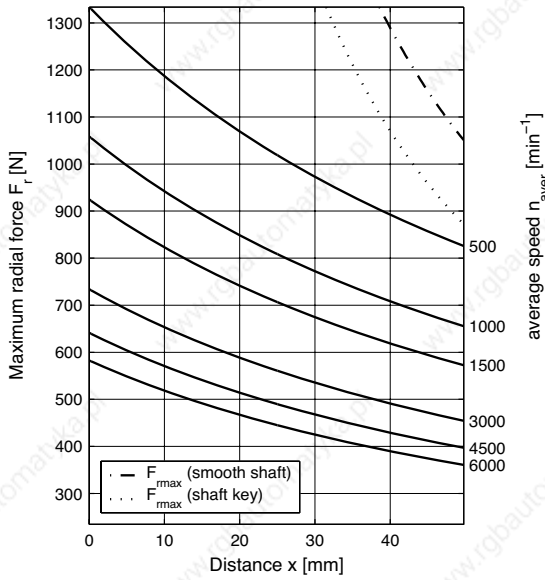

maximum allowed axial force:  $F_{amax} = 107$  N

Recommended B&R motor cable		
	The recommended B&R motor cable for a motor depends on the recommended ACOPOS servo drive or ACOPOSmulti inverter module (see "Recommended cable cross section for B&R motor cables [mm <sup>2</sup> ]" in the table "Technical data")	1622
Recommended B&R encoder cable		
8BCExxxx.1111A-0	ACPmulti EnDat cable, length xxxx m, 10 x 0.14 mm <sup>2</sup> + 2 x 0.5 mm <sup>2</sup> , EnDat plug 17-pin SpeedTEC socket, servo plug 15-pin DSUB plug, can be used in cable drag chains, UL/CSA listed	1428
8BCRxxxx.1111A-0	ACPmulti Resolver cable, length xxxx m, 3 x 2 x 24 AWG (19 x 0.127), resolver plug 12-pin SpeedTEC socket, servo plug 9-pin DSUB plug, can be used in cable drag chains, UL/CSA listed	1429

## 8JSA6



Technical data	8JSA62.ee030ffgg-0	8JSA63.ee023ffgg-0	8JSA64.ee030ffgg-0	8JSA65.ee025ffgg-0
Rated speed $n_N$ [min <sup>-1</sup> ]	3000	2250	3000	2500
Number of poles	10	10	10	10
Rated torque $M_N$ [Nm]	9.4	13.9	15.6	19.2
Rated power $P_N$ [kW]	2.95	3.35	4.9	5.03
Rated current $I_N$ [A]	5.84	6.42	9.4	10.38
Stall torque $M_0$ [Nm] <sup>1)</sup>	12.2	17.1	21	25
Stall current $I_0$ [A]	7.6	7.9	12.8	13.6
Peak torque $M_{max}$ [Nm]	30	42.5	54.1	65.2
Peak current $I_{max}$ [A]	22.7	23.6	38.4	40.9
Maximum angular acceleration without brake $a$ [rad/s <sup>2</sup> ]	17647	17562	16906	16300
Maximum speed $n_{max}$ [min <sup>-1</sup> ]	6000	6000	6000	6000
Torque constant $K_T$ [Nm/A]	1.61	2.16	1.66	1.85
Voltage constant $K_E$ [V/1000 min <sup>-1</sup> ]	103.67	138.23	106.81	119.38
Stator resistance $R_{2ph}$ [ $\Omega$ ]	1.65	1.7	0.75	0.73
Stator inductance $L_{2ph}$ [mH]	13.4	14.6	6.2	6.1
Electrical time constant $t_{el}$ [ms]	8.1	8.6	8.3	8.4
Thermal time constant $t_{therm}$ [min]	20	25	30	35
Moment of inertia without brake $J$ [kgcm <sup>2</sup> ]	17	24.2	32	40
Weight without brake $m$ [kg]	8.9	11.1	13.3	15.4
<b>Holding brake</b>				
Moment of inertia for brake $J_{br}$ [kgcm <sup>2</sup> ]	0.61	0.61	0.61	0.61
Weight of brake $m_{br}$ [kg]	2	2	2	2
Holding torque of the brake $M_{br}$ [Nm]	25	25	25	25
<b>Recommendations</b>				
Cross section for B&R motor cables [mm <sup>2</sup> ] <sup>2)</sup>	1.5	1.5	4	4
ACOPOS	≧ 1314	≧ 1314	≧ 1315	≧ 1315
ACOPOSmulti	≧ 1425	≧ 1425	≧ 1426	≧ 1426
ACOPOS servo drive 8Vxxxx.00-x <sup>3)</sup>	1090	1090	1180	1180
ACOPOSmulti inverter module 8BVI... <sup>4)</sup>	0110	0110	0110	0110

1) Flange design: Aluminum, 457 mm x 457 mm x 12.7 mm. The values decrease as follows depending on the motor option (the respective rated values also decrease simultaneously):

- Holding brake: 8JSA62: 0.5 Nm / 8JSA63: 0.9 Nm / 8JSA64: 1.3 Nm / 8JSA65: 1.7 Nm

- EnDat encoder: 8JSA62: 0.9 Nm / 8JSA63: 1.2 Nm / 8JSA64: 1.5 Nm / 8JSA65: 1.8 Nm

- Holding brake + EnDat encoder: 8JSA62: 1.6 Nm / 8JSA63: 2.4 Nm / 8JSA64: 3.1 Nm / 8JSA65: 4 Nm

2) The B&R motor cables with this cable cross section are produced optimally (cables stripped to the correct length) for the recommended ACOPOS servo drive or the recommended ACOPOSmulti inverter module. B&R motor cables with other cable cross sections can also be used (within the specified terminal cross section range) and can be obtained from B&R in the desired design on request.

3) The recommended servo drive is defined for 1.1x the stall current of the motor; if more than double the stall torque is required during the acceleration phase, the next larger servo drive should be selected. This recommendation is only a guideline, detailed inspection of the corresponding speed - torque characteristic curve can result in deviations of the servo drive size (one size larger or smaller).

4) The recommended ACOPOSmulti inverter module is defined for 1.1x the stall current of the motor; if more than double the stall torque is required during the acceleration phase, the next larger inverter module should be selected. This recommendation is only a guideline, detailed inspection of the corresponding speed - torque characteristic curve can result in deviations of the inverter module size (one size larger or smaller).

### Speed-torque characteristic curves with 400 VAC supply voltage

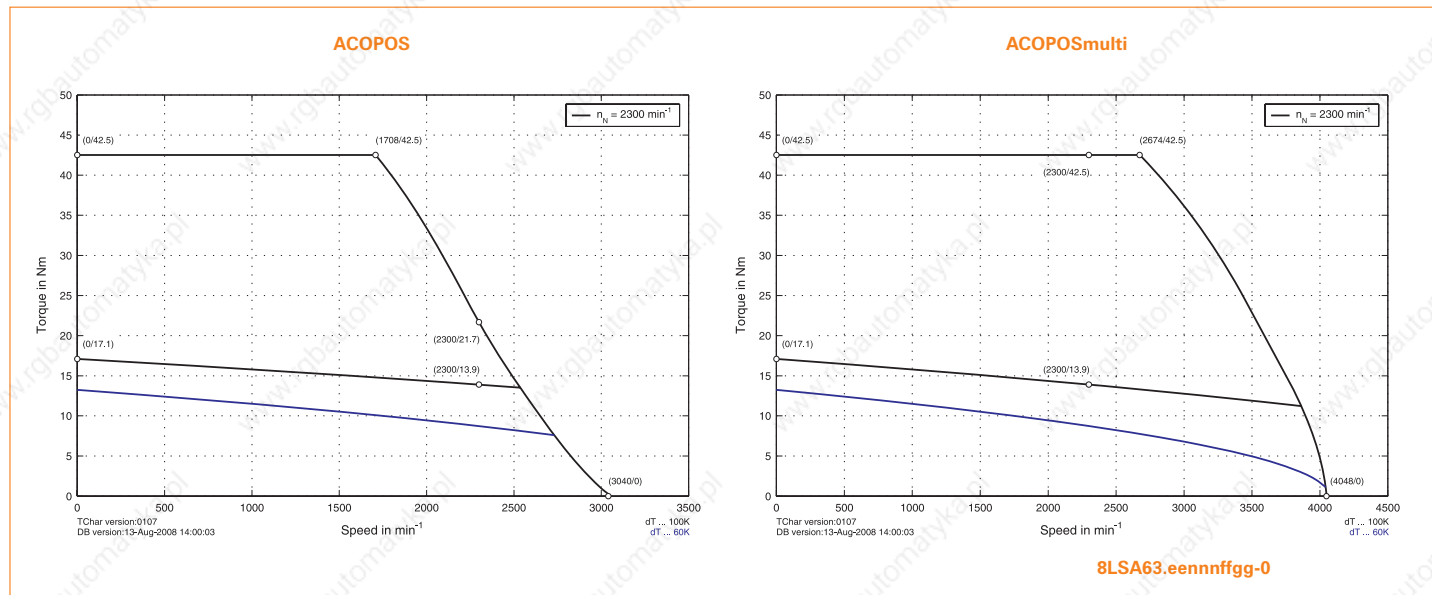
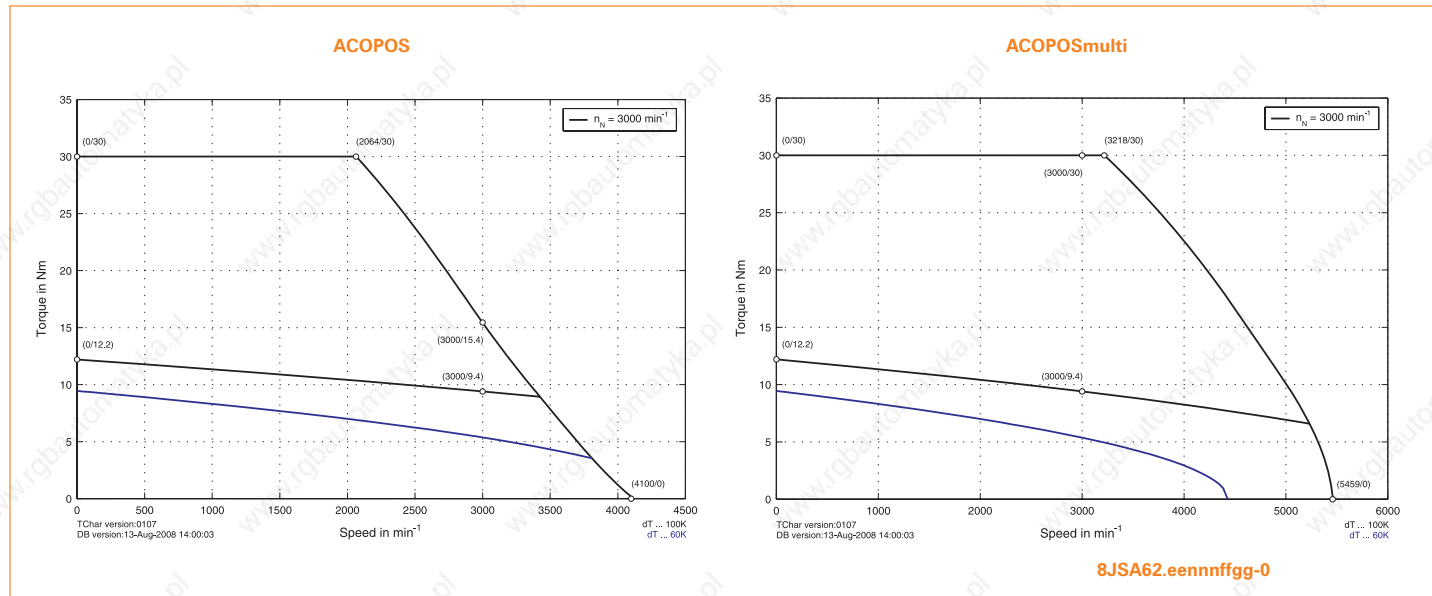

# 8JSA6

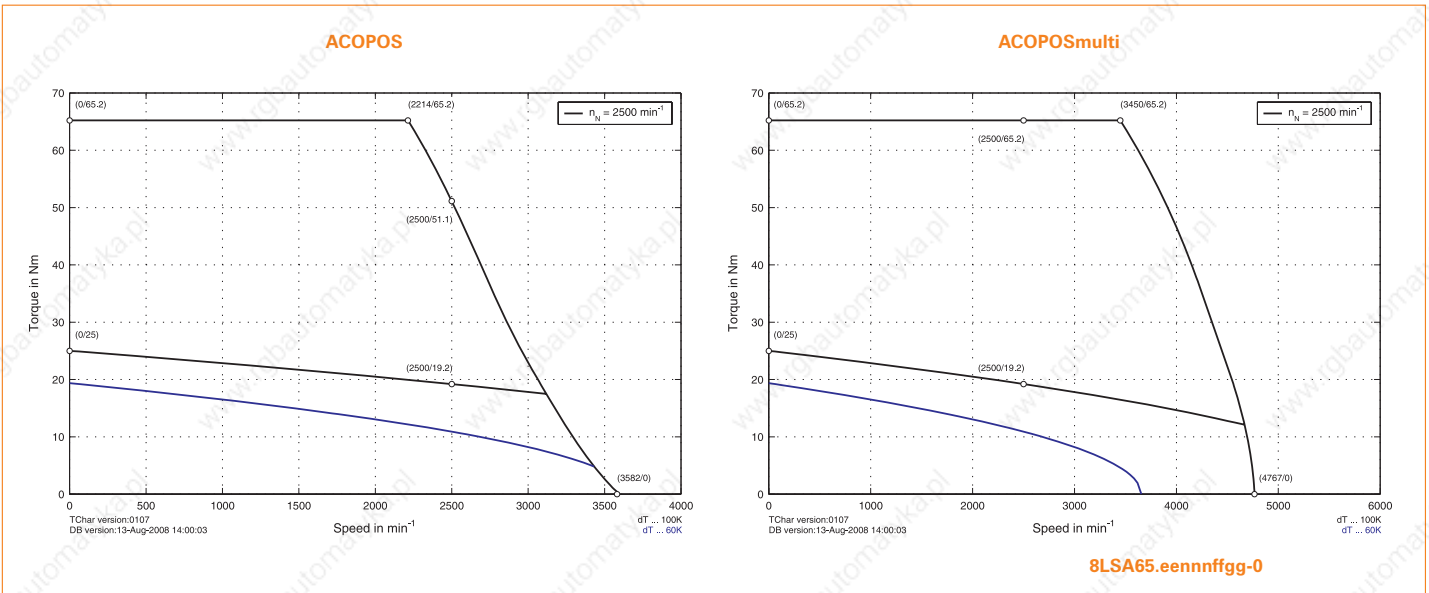
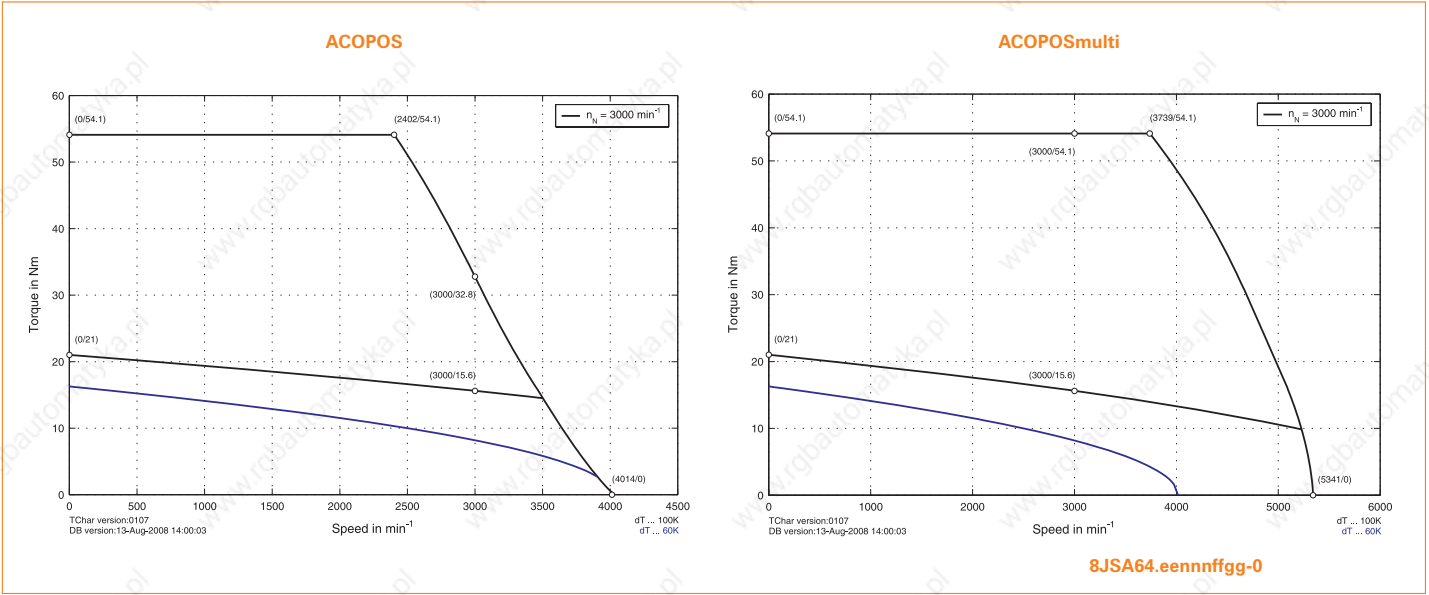

### Speed-torque characteristic curves with 230 VAC supply voltage

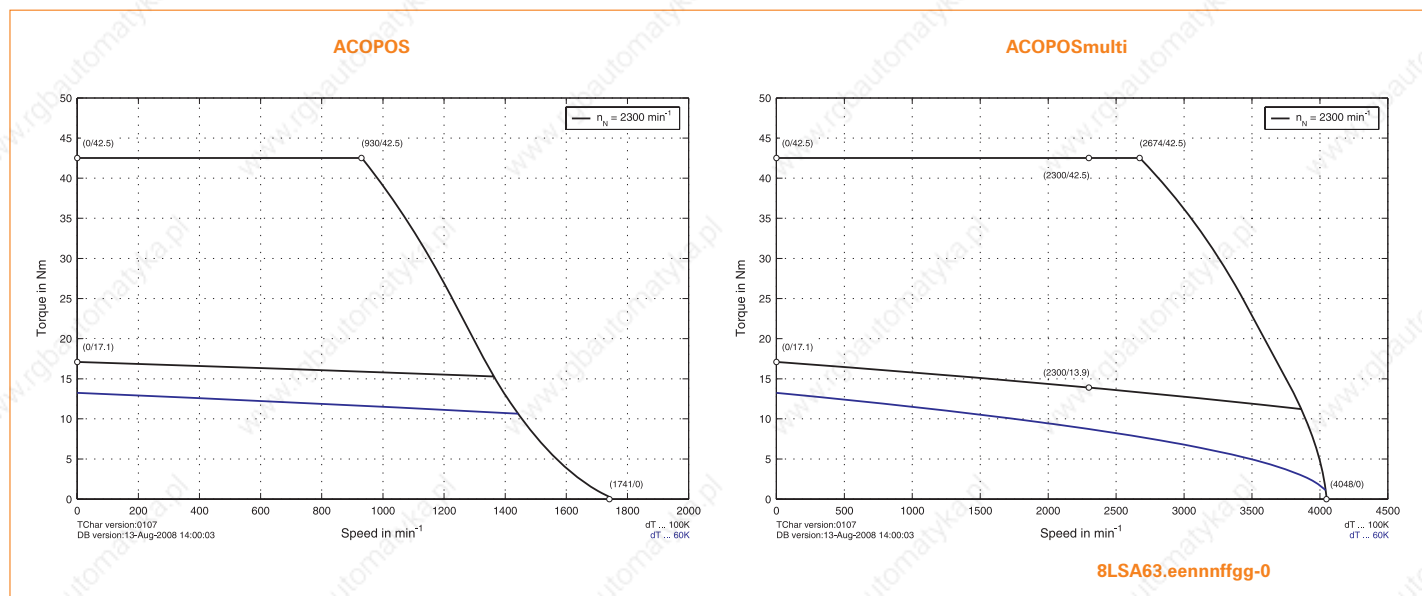
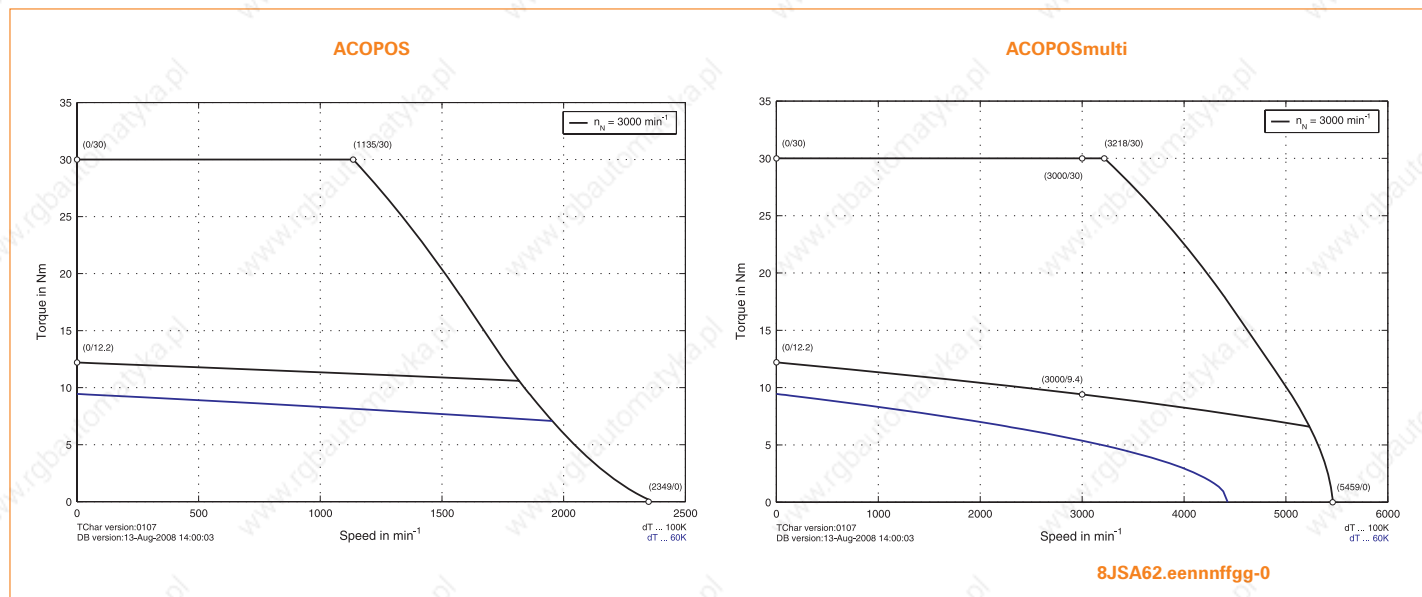

# 8JSA6

**ACOPOS**

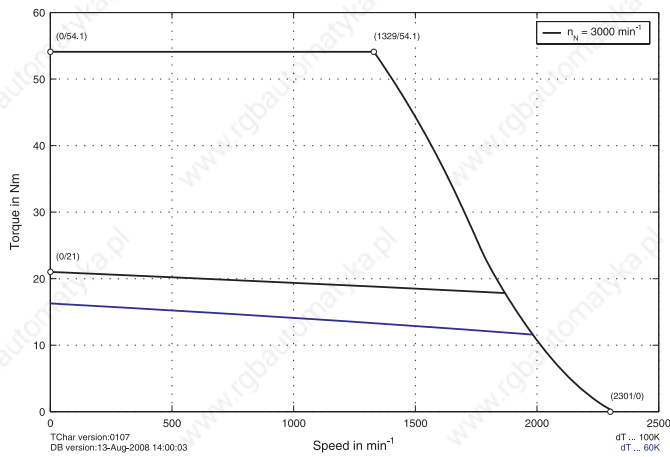

**ACOPOSMulti**

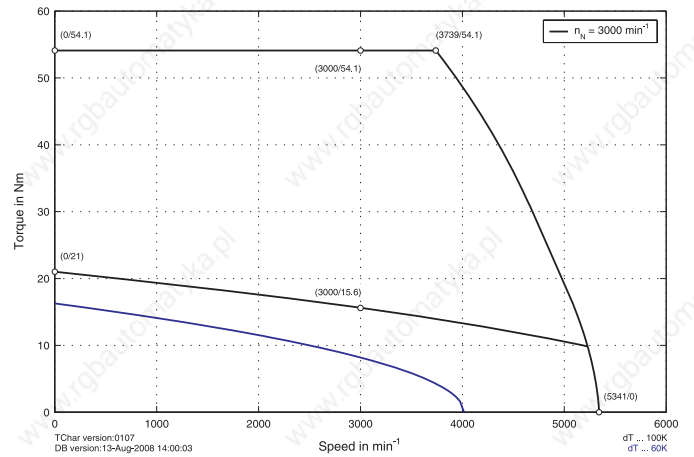

**8JSA64.eennnffgg-0**

**ACOPOS**

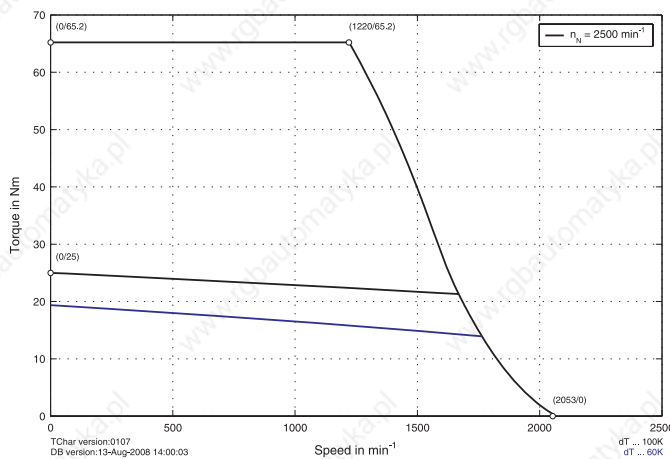

**ACOPOSMulti**

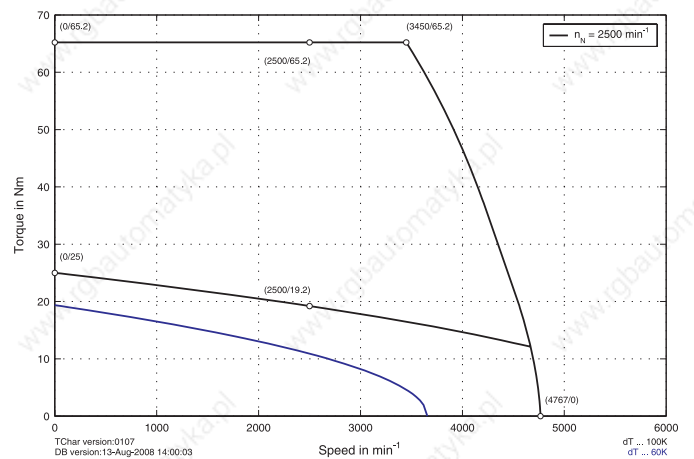

**8LSA65.eennnffgg-0**



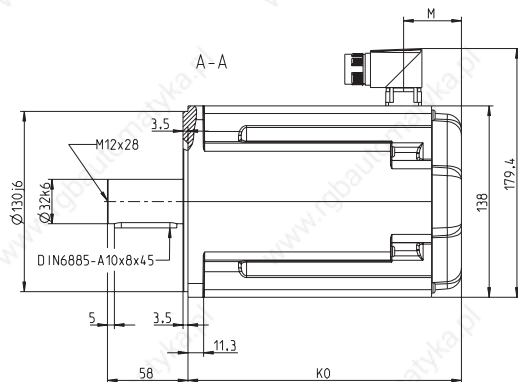
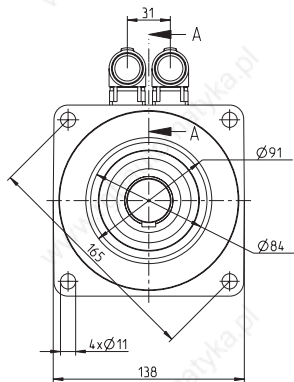

Dimensions

EnDat feedback		Resolver feedback		Extension of $K_0$ depending on the motor option [mm]			
Model number	$K_0$	M	Model number	$K_0$	M	Holding brake	Oil seal
8JSA62.Exnnnffgg-0	172.2	41.7	8JSA62.R0nnnffgg-0	153.7	23.2	47	---
8JSA63.Exnnnffgg-0	197.2	41.7	8JSA63.R0nnnffgg-0	178.7	23.2	47	---
8JSA64.Exnnnffgg-0	222.2	41.7	8JSA64.R0nnnffgg-0	203.7	23.2	47	---
8JSA65.Exnnnffgg-0	247.2	41.7	8JSA65.R0nnnffgg-0	228.7	23.2	47	---

# 8JSA6

## Maximum shaft load

The values in the diagram below are based on a mechanical lifespan of the bearings of 20,000 operating hours.

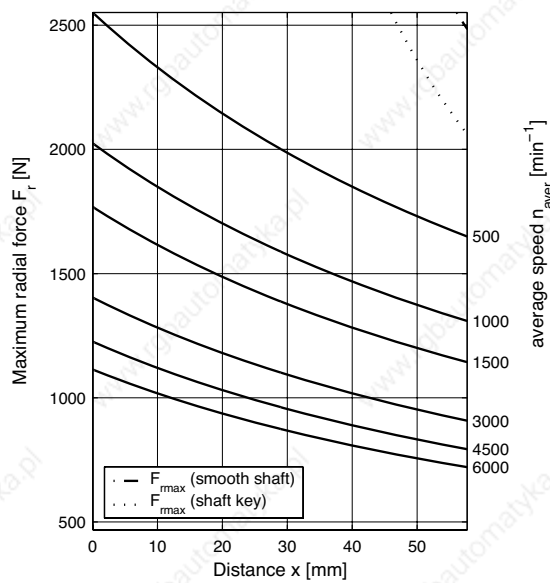

maximum allowed axial force:  $F_{amax} = 210$  N

Recommended B&R motor cable		
	The recommended B&R motor cable for a motor depends on the recommended ACOPOS servo drive or ACOPOSmulti inverter module (see "Recommended cable cross section for B&R motor cables [mm <sup>2</sup> ]" in the table "Technical data")	1628
Recommended B&R encoder cable		
8BCExxxx.1111A-0	ACPmulti EnDat cable, length xxxx m, 10 x 0.14 mm <sup>2</sup> + 2 x 0.5 mm <sup>2</sup> , EnDat plug 17-pin SpeedTEC socket, servo plug 15-pin DSUB plug, can be used in cable drag chains, UL/CSA listed	1428
8BCRxxxx.1111A-0	ACPmulti Resolver cable, length xxxx m, 3 x 2 x 24 AWG (19 x 0.127), resolver plug 12-pin SpeedTEC socket, servo plug 9-pin DSUB plug, can be used in cable drag chains, UL/CSA listed	1429



# 8JSA7



Technical data	8JSA72.ee020ffgg-0	8JSA73.ee024ffgg-0	8JSA74.ee018ffgg-0
Rated speed $n_N$ [min <sup>-1</sup> ]	2000	2400	1800
Number of poles	10	10	10
Rated torque $M_N$ [Nm]	23.6	28.5	39.6
Rated power $P_N$ [kW]	4.94	7.16	7.46
Rated current $I_N$ [A]	10.13	13.38	13.94
Stall torque $M_0$ [Nm] <sup>1)</sup>	30	41.6	52.5
Stall current $I_0$ [A]	13	19.5	18.5
Peak torque $M_{max}$ [Nm]	79.7	111	142
Peak current $I_{max}$ [A]	38.9	58.6	55.5
Maximum angular acceleration without brake $a$ [rad/s <sup>2</sup> ]	12262	12065	11833
Maximum speed $n_{max}$ [min <sup>-1</sup> ]	6000	6000	6000
Torque constant $K_T$ [Nm/A]	2.33	2.13	2.84
Voltage constant $K_E$ [V/1000 min <sup>-1</sup> ]	149.75	137.18	183.26
Stator resistance $R_{2ph}$ [ $\Omega$ ]	0.69	0.38	0.47
Stator inductance $L_{2ph}$ [mH]	10.8	5.9	7.7
Electrical time constant $t_{el}$ [ms]	15.7	15.5	16.4
Thermal time constant $t_{therm}$ [min]	46	53	60
Moment of inertia without brake $J$ [kgcm <sup>2</sup> ]	65	92	120
Weight without brake $m$ [kg]	19.7	26.7	33.6
<b>Holding brake</b>			
Moment of inertia for brake $J_{br}$ [kgcm <sup>2</sup> ]	1.64	1.64	1.64
Weight of brake $m_{br}$ [kg]	2.1	2.1	2.1
Holding torque of the brake $M_{br}$ [Nm]	53	53	53
<b>Recommendations</b>			
Cross section for B&R motor cables [mm <sup>2</sup> ] <sup>2)</sup>	4	4	4
ACOPOS	▮ 1315	▮ 1315	▮ 1315
ACOPOSmulti	▮ 1426	▮ 1426	▮ 1426
ACOPOS servo drive 8Vxxxx.00-x <sup>3)</sup>	1180	1320	1320
ACOPOSmulti inverter module 8BVL... <sup>4)</sup>	0110	0220	0220

1) Flange design: Aluminum, 457 mm x 457 mm x 12.7 mm. The values decrease as follows depending on the motor option (the respective rated values also decrease simultaneously):

- Holding brake: 1 Nm
- EnDat encoder: 8JSA72: 2 Nm / 8JSA73: 2.7 Nm / 8JSA74: 3.4 Nm
- Holding brake + EnDat encoder: 8JSA72: 3.9 Nm / 8JSA73: 5.1 Nm / 8JSA74: 6.2 Nm

2) The B&R motor cables with this cable cross section are produced optimally (cables stripped to the correct length) for the recommended ACOPOS servo drive or the recommended ACOPOSmulti inverter module. B&R motor cables with other cable cross sections can also be used (within the specified terminal cross section range) and can be obtained from B&R in the desired design on request.

3) The recommended servo drive is defined for 1.1x the stall current of the motor; if more than double the stall torque is required during the acceleration phase, the next larger servo drive should be selected. This recommendation is only a guideline, detailed inspection of the corresponding speed - torque characteristic curve can result in deviations of the servo drive size (one size larger or smaller).

4) The recommended ACOPOSmulti inverter module is defined for 1.1x the stall current of the motor; if more than double the stall torque is required during the acceleration phase, the next larger inverter module should be selected. This recommendation is only a guideline, detailed inspection of the corresponding speed - torque characteristic curve can result in deviations of the inverter module size (one size larger or smaller).

Speed-torque characteristic curves with 400 VAC supply voltage

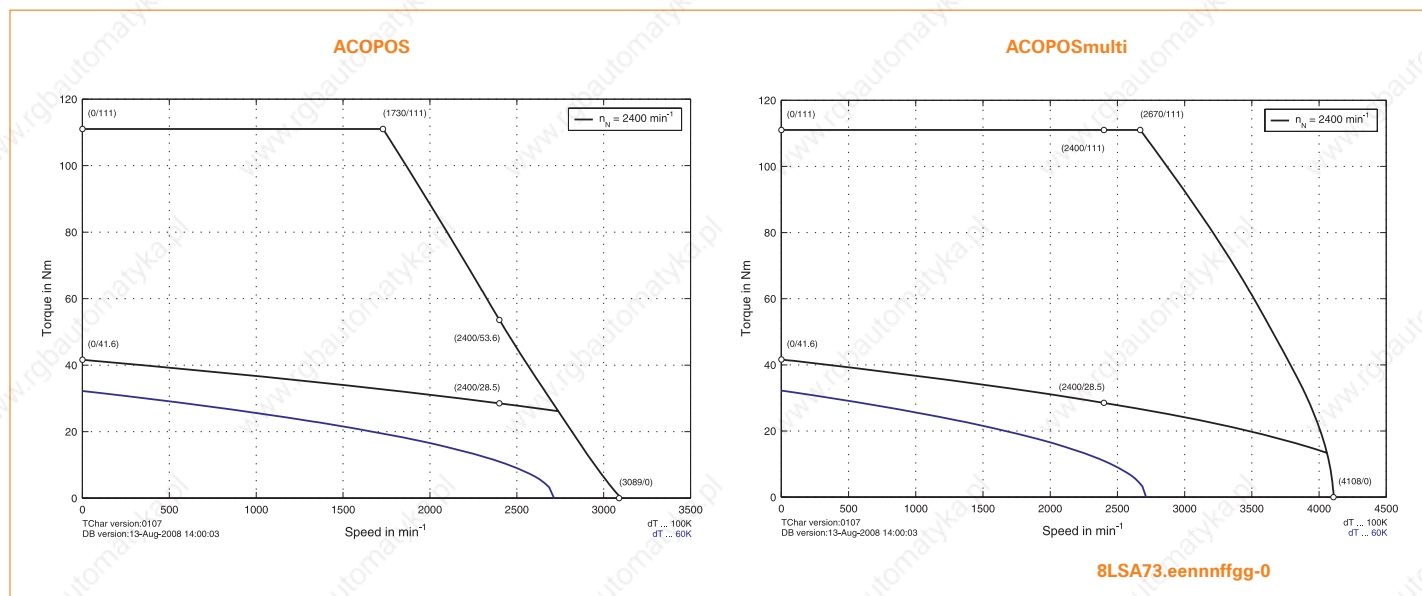
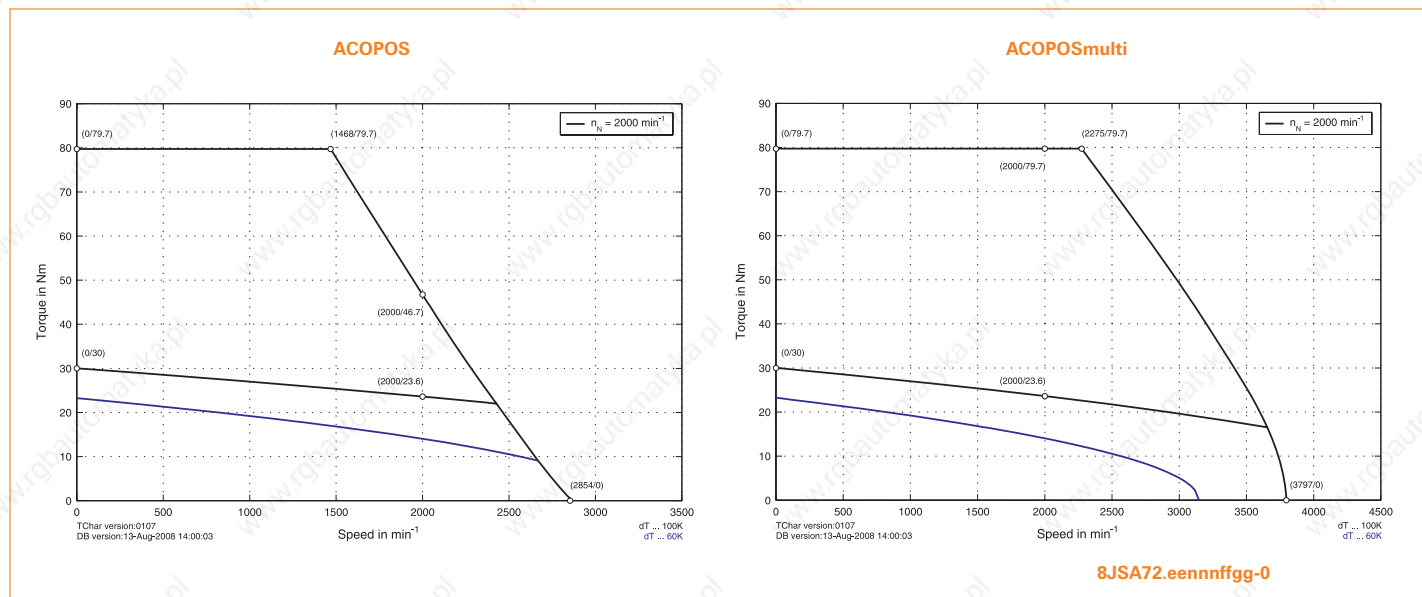

# 8JSA7

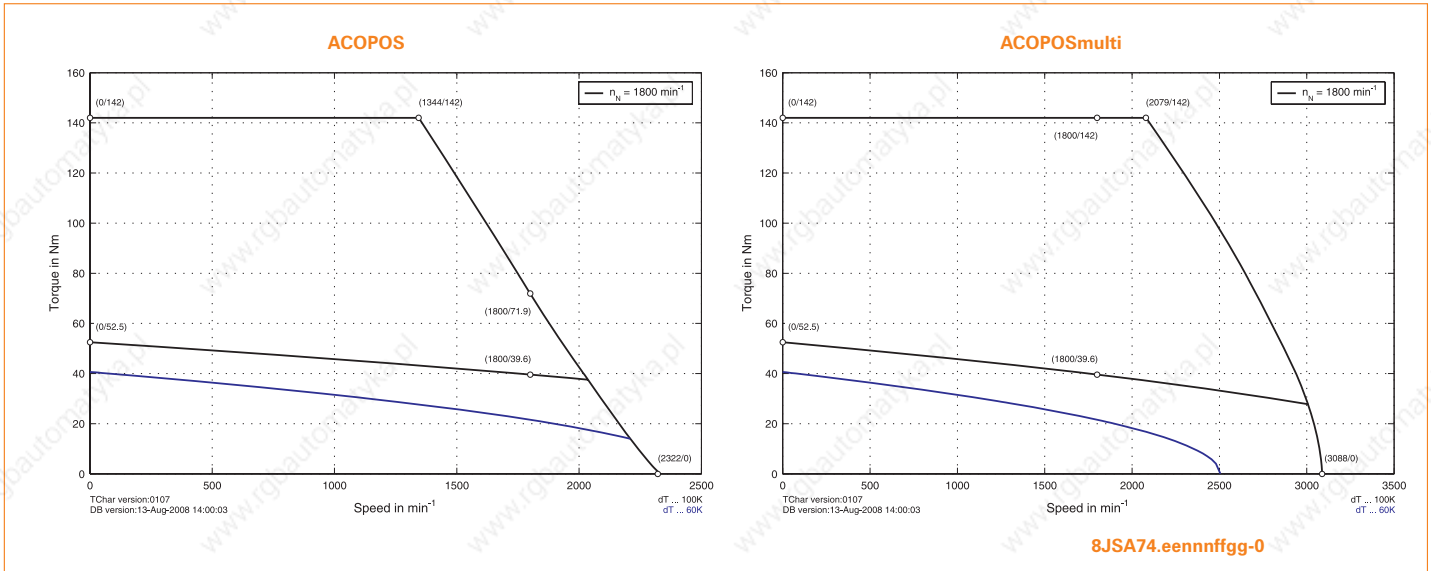

## Speed-torque characteristic curves with 230 VAC supply voltage

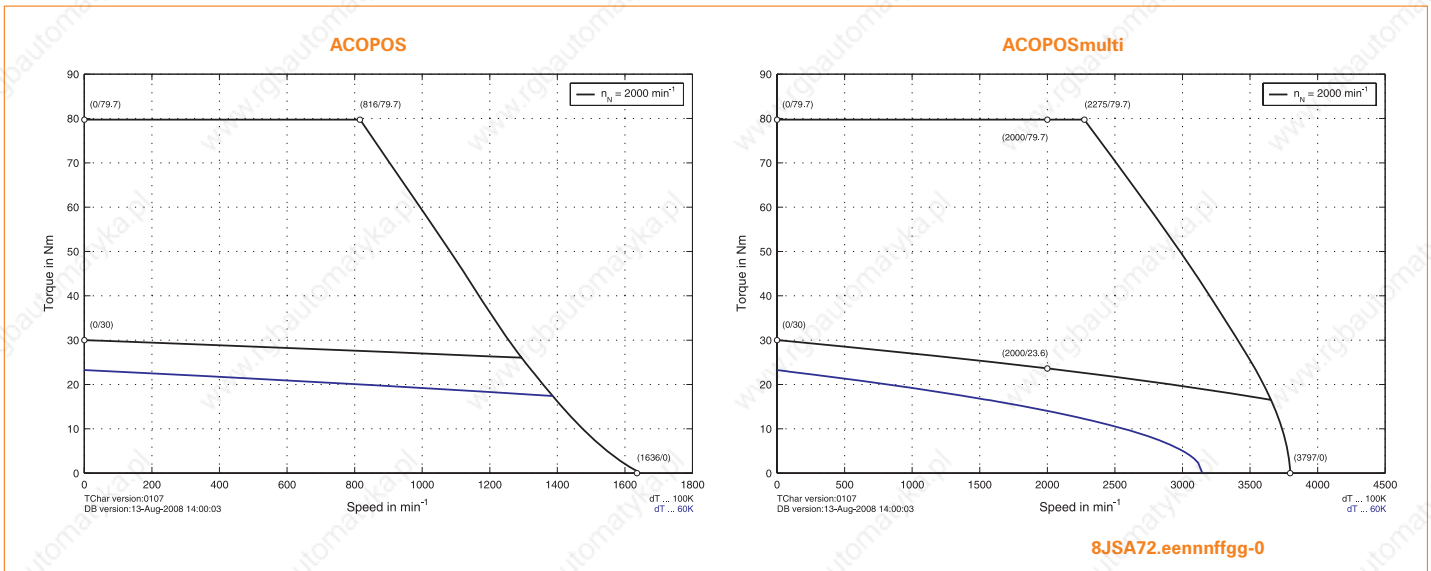

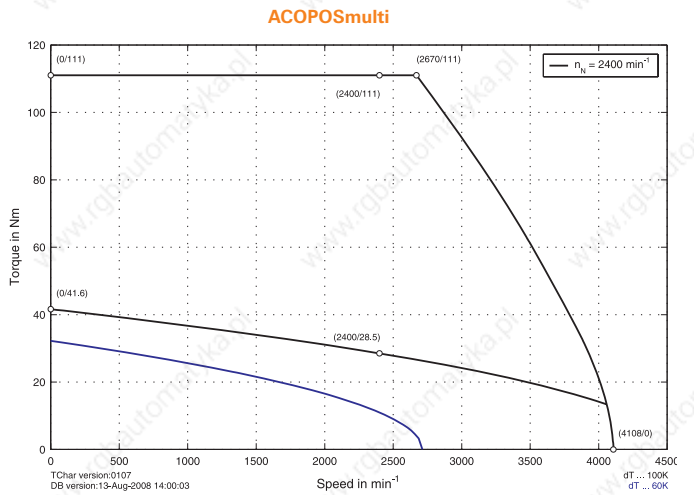
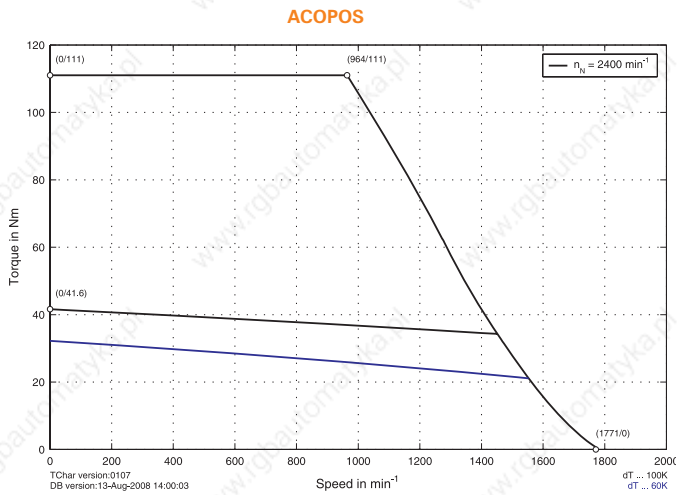

**8JSA73.eennnffgg-0**

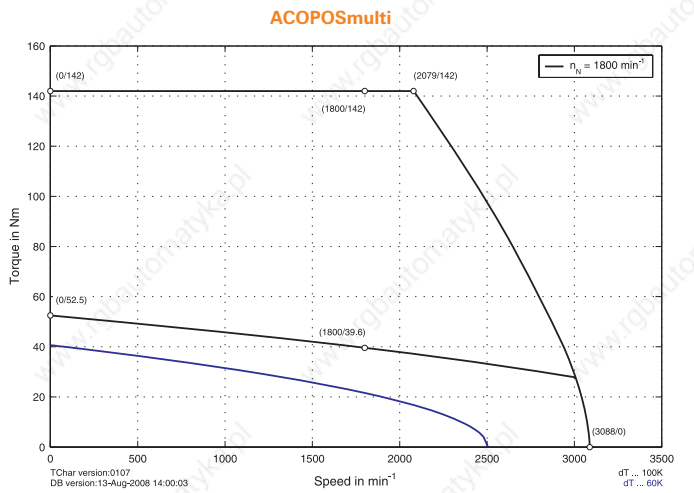
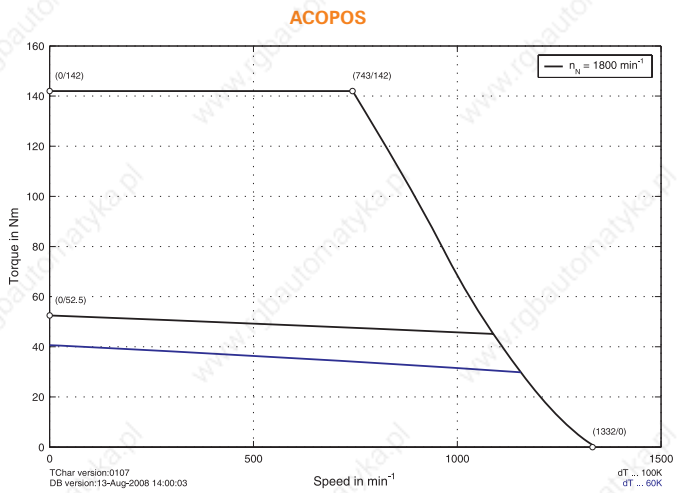

**8JSA74.eennnffgg-0**

# 8JSA7

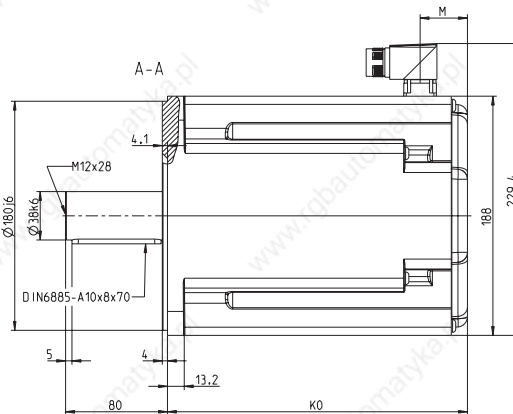
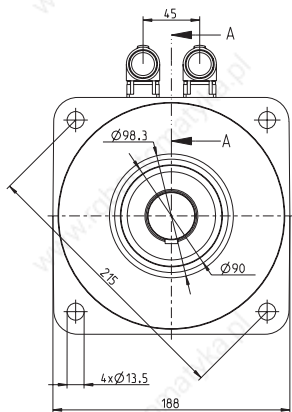

Dimensions

EnDat feedback			Resolver feedback			Extension of $K_0$ depending on the motor option [mm]	
Model number	$K_0$	M	Model number	$K_0$	M	Holding brake	Oil seal
8JSA72.Exnnnffgg-0	201.7	37.2	8JSA72.R0nnnffgg-0	192.5	28	42	---
8JSA73.Exnnnffgg-0	235.7	37.2	8JSA73.R0nnnffgg-0	226.5	28	42	---
8JSA74.Exnnnffgg-0	269.7	37.2	8JSA74.R0nnnffgg-0	260.5	28	42	---



### Maximum shaft load

The values in the diagram below are based on a mechanical lifespan of the bearings of 20,000 operating hours.

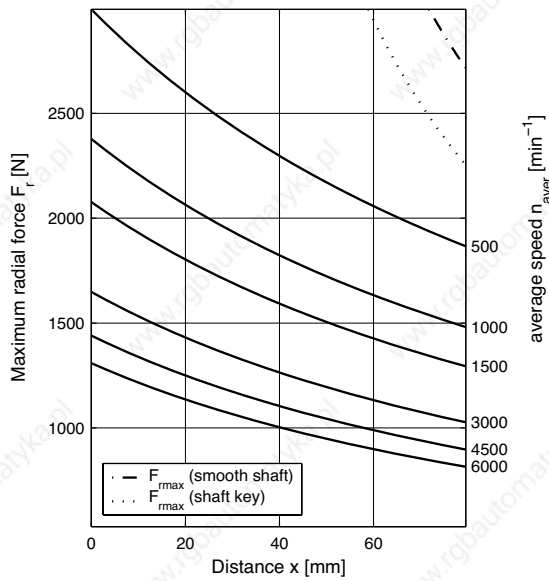

maximum allowed axial force:  $F_{amax} = 241$  N

Recommended B&R motor cable		
	The recommended B&R motor cable for a motor depends on the recommended ACOPOS servo drive or ACOPOSmulti inverter module (see "Recommended cable cross section for B&R motor cables [mm <sup>2</sup> ]" in the table "Technical data")	1636
Recommended B&R encoder cable		
8BCExxxx.1111A-0	ACPMulti EnDat cable, length xxxx m, 10 x 0.14 mm <sup>2</sup> + 2 x 0.5 mm <sup>2</sup> , EnDat plug 17-pin SpeedTEC socket, servo plug 15-pin DSUB plug, can be used in cable drag chains, UL/CSA listed	1428
8BCRxxxx.1111A-0	ACPMulti Resolver cable, length xxxx m, 3 x 2 x 24 AWG (19 x 0.127), resolver plug 12-pin SpeedTEC socket, servo plug 9-pin DSUB plug, can be used in cable drag chains, UL/CSA listed	1429

# Motor connectors 8BPM

## Features

- UL/CSA listed
- Metal housing; IP67 protection
- High-quality, gold-plated wire spring contacts
- High-level contact security even when reinserted many times
- SpeedTEC quick-release faster



General information	8BPM0001.0000-00	8BPM0002.0000-00	8BPM0003.0000-00
Connector size	Size 1	Size 1	Size 1.5
Number and type of contacts	8 (4 power and 4 signal contacts)	8 (4 power and 4 signal contacts)	8 (4 power and 4 signal contacts)
Degree of pollution	3	3	3
Installation altitude	Up to 2000 m	Up to 2000 m	Up to 2000 m
Insulator	PA, UL94/V0 listed	PA, UL94/V0 listed	PA, UL94/V0 listed
Contacts	Gold-plated brass	Gold-plated brass	Gold-plated brass
Protective ground connection on housing	According to VDE 0627	According to VDE 0627	According to VDE 0627
Protection according to DIN 40050	IP67 when connected	IP67 when connected	IP67 when connected
Certifications	UL/CSA	UL/CSA	UL/CSA
Electrical characteristics	8BPM0001.0000-00	8BPM0002.0000-00	8BPM0003.0000-00
Overvoltage category	3	3	3
Power contacts			
Rated current	30 A	30 A	75 A
Rated voltage	630 VAC / VDC	630 VAC / VDC	630 VAC / VDC
Test voltage (L-L)	6000 V	6000 V	6000 V
Contact resistance	< 3 Ω	< 3 Ω	< 1 Ω
Signal contacts			
Rated current	7 A	7 A	30 A
Rated voltage	250 VAC / VDC	250 VAC / VDC	630 VAC / VDC
Test voltage (L-L)	2500 V	2500 V	4000 V
Contact resistance	< 5 Ω	< 5 Ω	< 3 Ω
Mechanical characteristics	8BPM0001.0000-00	8BPM0002.0000-00	8BPM0003.0000-00
Temperature range	-20°C to +130°C	-20°C to +130°C	-20°C to +130°C
Housing material	Zinc casting, nickel plated	Zinc casting, nickel plated	Zinc casting, nickel plated
Gaskets	FKM	FKM	FKM
Connection cycles	> 50	> 50	> 50
Crimp range	4 x 0.5 - 2.5 mm <sup>2</sup> + 4 x 0.06 - 1 mm <sup>2</sup>	4 x 2.5 - 4 mm <sup>2</sup> + 4 x 0.06 - 1 mm <sup>2</sup>	4 x 1.5 - 10 mm <sup>2</sup> + 4 x 0.5 - 2.5 mm <sup>2</sup>
Cable ø	4.2 - 17 mm	4.2 - 17 mm	7 - 25 mm
Manufacturer information	8BPM0001.0000-00	8BPM0002.0000-00	8BPM0003.0000-00
Manufacturer	INTERCONTEC	INTERCONTEC	INTERCONTEC
Internet address	www.intercontec.biz	www.intercontec.biz	www.intercontec.biz
Manufacturer's product ID	BSTA 078 NN 00 42 0100 000	BSTA 078 NN 00 59 0100 000	CSTA 264 NN 00 45 0020 000

# Encoder connectors 8BPE, 8BPR

## Features

- UL/CSA listed
- Metal housing; IP67 protection
- High-quality, gold-plated wire spring contacts
- High-level contact security even when reinserted many times
- SpeedTEC quick-release faster



General information	8BPE0001.0000-00	8BPR0001.0000-00
Connector size	Size 1	Size 1
Number and type of contacts	17 signal contacts	12 signal contacts
Degree of pollution	3	3
Installation altitude	Up to 2000 m	Up to 2000 m
Insulator	PA, PBT, UL94/V0 listed	PA, PBT, UL94/V0 listed
Contacts	Gold-plated brass	Gold-plated brass
Protective ground connection on housing	According to VDE 0627	According to VDE 0627
Protection according to DIN 40050	IP67 when connected	IP67 when connected
Certifications	UL/CSA	UL/CSA
Electrical characteristics	8BPE0001.0000-00	8BPR0001.0000-00
Overvoltage category	3	3
Signal contacts		
Rated current	7 A	7 A
Rated voltage	125 V	160 V
Test voltage (L-L)	2000 V	2500 V
Contact resistance	< 5 Ω	< 5 Ω
Mechanical characteristics	8BPE0001.0000-00	8BPR0001.0000-00
Temperature range	-20°C to +130°C	-20°C to +130°C
Housing material	Zinc casting, nickel plated	Zinc casting, nickel plated
Gaskets	FKM, HBNR	FKM, HBNR
Connection cycles	> 50	> 50
Crimp range	17 x 0.06 - 1 mm <sup>2</sup>	12 x 0.06 - 1 mm <sup>2</sup>
Cable ø	3.5 - 14.7 mm	3.5 - 14.7 mm
Manufacturer information	8BPE0001.0000-00	8BPR0001.0000-00
Manufacturer	INTERCONTEC	INTERCONTEC
Internet address	www.intercontec.biz	www.intercontec.biz
Manufacturer's product ID	ASTA 035 NN 00 41 0100 000	ASTA 021 NN 00 41 0100 000