

PRESSURE SWITCHES

VACUUM

Pressure switches - vacuum (electrical output)

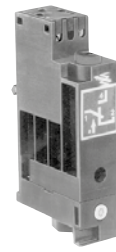

- › Conform to the Low Voltage Directive
- › Can be used without enclosure according to IEC 664-1 pollution group III

Part numbers

Pressure and vacuum switches	81 513 552	81 513 502	81 513 501	81 513 522
Mounting	DIN rail	DIN rail	DIN rail	DIN rail
Actuators	Pressure	Pressure	Low pressure	Vacuum
Manual override	with	without	without	without

Symbol

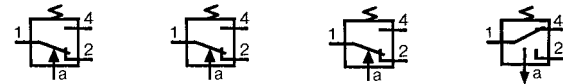

Characteristics

Pneumatic connection	Push-in connection for semi-rigid tubing (NFE 49100) Tapped BSP via connector	mm	Ø 4 ext.	Ø 4 ext.	Ø 4 ext.	Ø 4 ext.
Protection	IEC 529		IP 20	IP 20	IP 20	IP 20
Permissible fluid:	air, inert gases and liquids					
Adjustment of switching pressure (* adjusted to 0.3)	bar		2 → 8	2 → 8	0.3 → 1.2 *	-0.3 → -0.8
Hysteresis	at 1 bar	bar	0.5	0.5	—	—
	at 2 bars	bar	0.6	0.6	—	—
	at 4 bars	bar	0.8	0.8	—	—
	at 6 bars	bar	1	1	—	—
	max. 200 mb		—	—	•	—
	max. 250 mb		—	—	—	•
Pressure to break			—	—	—	—
Mechanical life (operations)			10 ⁶	10 ⁶	10 ⁶	10 ⁶
Contact rating (V resistive)			5A - 220-230 V	5A - 220-230 V	5A - 220-230 V	5A - 220-230 V
Wire cross-section	mm ²		0.75	0.75	0.75	0.75
Operating temperature	°C		-10 → +70	-10 → +70	-10 → +70	-10 → +70
Weight	g		48	46	46	46
Standard electrical contact			V4 83 170 4 I W2	V4 83 170 4 I W2	V4 83 170 4 I W2	V4 83 170 4 I W2
UL and cUL approval			MH15213 (R)	MH15213 (R)	MH15213 (R)	MH15213 (R)

Operation

Pressure operated

Vacuum operated

Electrical life

(Crouzet microswitch "V4" ref 83 170 4-1-W2)

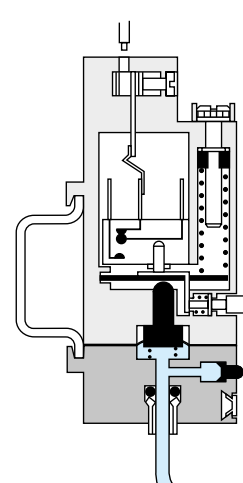
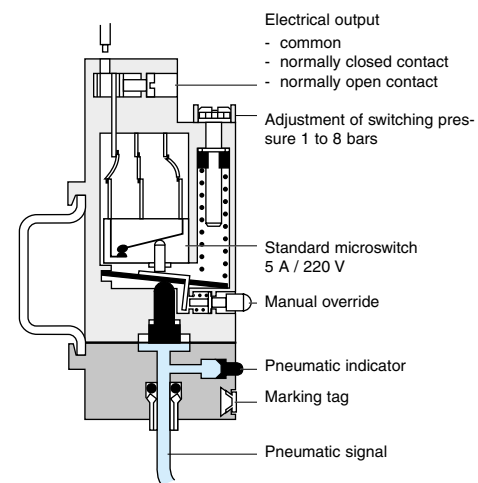

For continuous vacuum applications, please consult us.

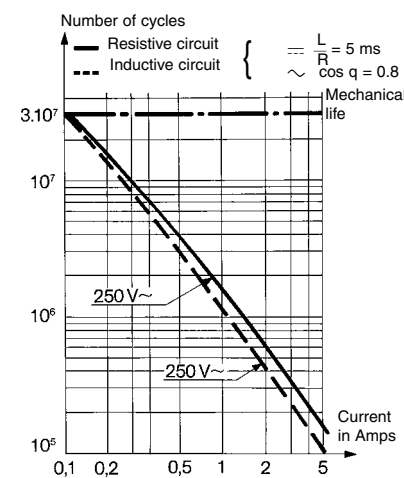

Other information

- On request :
- Microswitch V4 ref. 83 170 0 i W2 high current
 - Microswitch V4 ref. 83 170 9 i W2 low current



81 513 516	81 513 510	81 513 527	81 513 533	81 513 523	81 509 080	81 509 085
Base mounted page 4/14	Base mounted page 4/14	Base mounted page 4/14	2 screws M4	2 screws M4	Base mounted page 4/14	Base mounted page 4/14
Pressure without	Pressure with	Vacuum without	Pressure without	Vacuum without	Pressure without	Pressure with

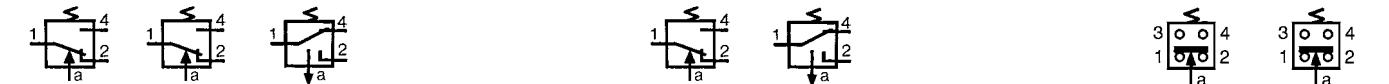

Ø 4 ext.	Ø 4 ext.	Ø 4 ext.	—	—	—	—
IP 54	IP 54	IP 54	1/8 BSP IP 54	1/8 BSP IP 54	Via sub-base IP 54	Via sub-base IP 54
2 → 8	2 → 8	-0.3 → -0.9	2 → 8	-0.3 → -0.8	1.4 ± 0.5	1.4 ± 0.5
0.5	0.5	—	0.5	—	—	—
0.6	0.6	—	0.6	—	—	—
0.8	0.8	—	0.8	—	—	—
1	1	—	1	—	—	—
—	—	•	—	•	—	—
10 ⁶	10 ⁶	10 ⁶	10 ⁶	10 ⁶	0.6 ± 0.2	0.6 ± 0.2
5A - 220-230 V	5A - 220-230 V	5A - 220-230 V	5A - 220-230 V	5A - 220-230 V	5A - 220-230 V	5A - 220-230 V
0.75	0.75	0.75	0.75	0.75	1.5	1.5
-10 → +70	-10 → +70	-10 → +70	-10 → +70	-10 → +70	-10 → +70	-10 → +70
56	58	56	65	65	80	80
V4 83 170 4 I W2	V4 83 170 4 I W2	V4 83 170 4 I W2	V4 83 170 4 I W2	V4 83 170 4 I W2	83 133 004	83 133 004
MH15213 (R)	MH15213 (R)	MH15213 (R)	MH15213 (R)	MH15213 (R)		

Electrical connections

81 513 501 - 81 513 502
81 513 522 - 81 513 552

Dimensions

81 513 552 - 81 513 502
81 513 501 - 81 513 522

Pressure switch with connector

81 513 516 - 81 513 510
81 513 527

81 516 082

81 513 533
81 513 523

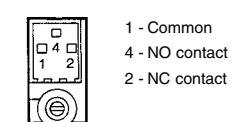

81 513 510
81 513 516 - 81 513 527

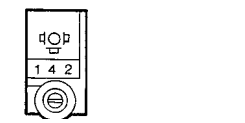

81 513 533
81 513 523 - 81 513 533

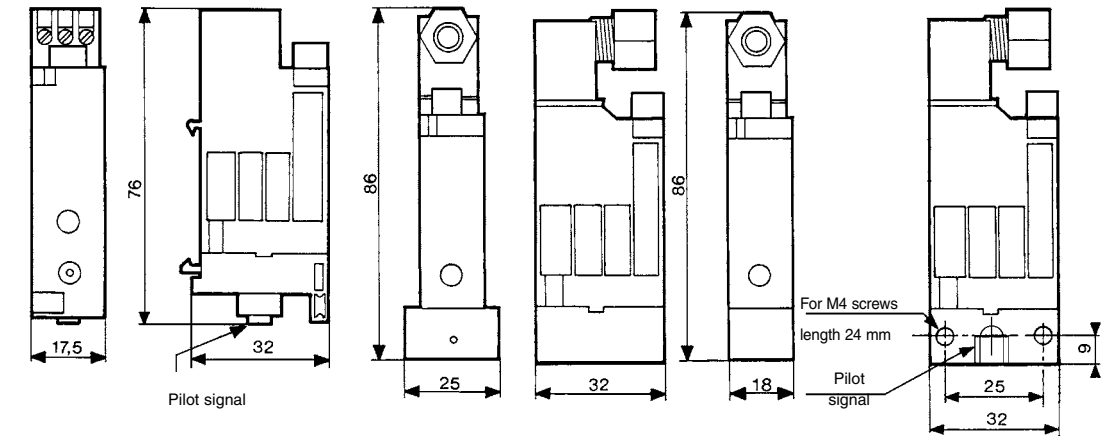

81 509 080 - 81 509 085

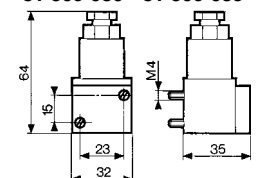

Adjustable pressure switches (manostats) (pneumatic output)

100 % pneumatic



Also available in ATEX version for use in potentially explosive atmospheres in accordance with 94/9/EC Directive

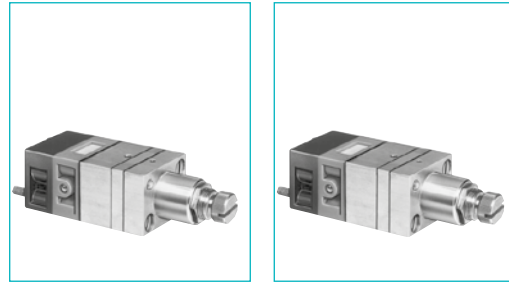

Part numbers (and adjustment ranges)

Adjustment range	50 → 500 mb 0.1 → 2.5 b 2 → 8 b	81 505 140 81 505 150 81 505 160	81 502 140 81 502 150 81 502 160
Version		Positive output	Negative output
Accuracy	50 → 500 mb 0.1 → 2.5 b 2 → 8 b	10 % 4 % 4 %	10 % 4 % 4 %

Symbol



Characteristics

Orifice diameter	mm	2.5	2.5
Flow at 4 bars	NI/min	170	170
Hysteresis	50 → 500 mb 0.1 → 2.5 b 2 → 8 b	60 mb 100 mb 320 mb	60 mb 100 mb 320 mb
Connection - sub-base pages 54/55			
Operating temperature	°C	-5 → +50	-5 → +50
Mechanical life	operations	3 x 10 ⁶	3 x 10 ⁶
Weight	g	160	160

Connections

Example of pressure threshold adjustment (mini-regulator - manostat)

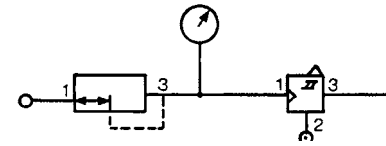

Principle of operation

The manostats provide an on or off output signal when the input signal reaches a predetermined pressure threshold.

Positive output

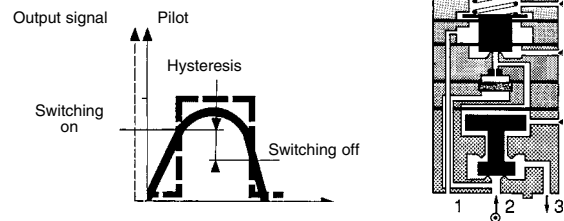

Negative output

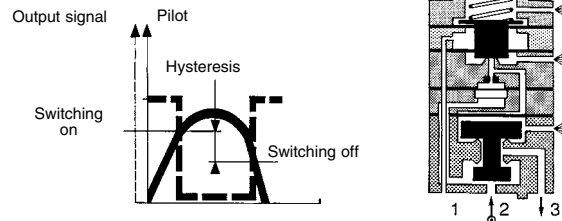

Dimensions

81 502 140 - 81 502 150 - 81 502 160
81 505 140 - 81 505 150 - 81 505 160

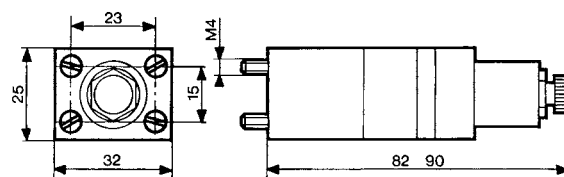

Other information Pressure switches with electrical output on request.

ATEX version products are available in the following catalogues: Pneumatic products for explosive atmospheres or on our website www.crouzet.com

Adjustable vacuum switches (vacuostat)

- 100 % pneumatic
- For vacuum -0,1 → -0,9 Bar



Part numbers

	81 505 110	81 502 110	81 508 110
	Positive output	Negative output	Electrical output

Symbol

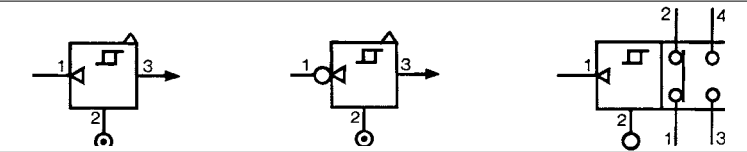

Characteristics

Adjustment range	b	-0.1 → -0.9	-0.1 → -0.9	-0.1 → -0.9
Flow at 6 bars	NI/min	170	170	170
Hysteresis	mb	80	80	80
Connection - sub-base pages 54/55				
Operating temperature	°C	-5 → +50	-5 → +50	-5 → +50
Mechanical life	operations	3 x 10 ⁶	3 x 10 ⁶	3 x 10 ⁶
Weight	g	160	160	180

Connections

Example of use: Vacuum handling (vacuum generator, vacuum pad, vacuostats).

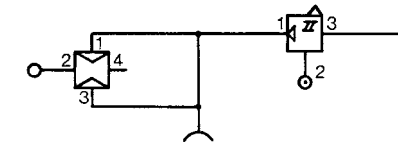

Principle of operation

Vacuostats provide an on or off output signal when the input signal reaches a predetermined pressure threshold.

Positive output

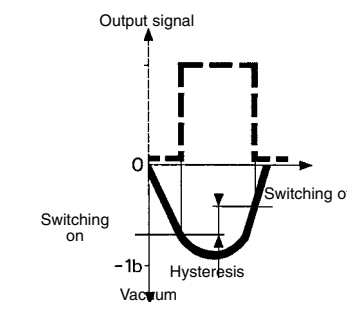

Negative output

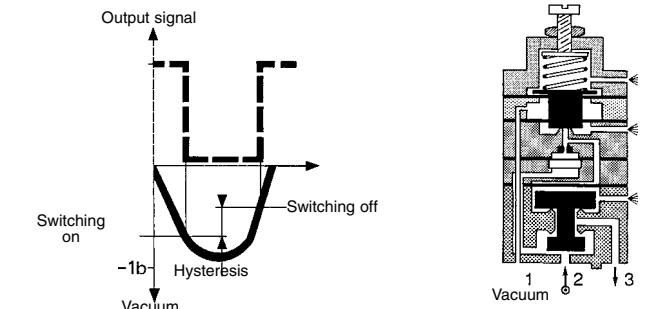

Dimensions

81 502 110 - 81 505 110

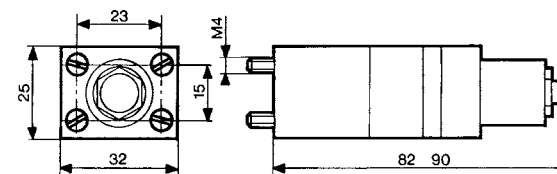

81 508 110

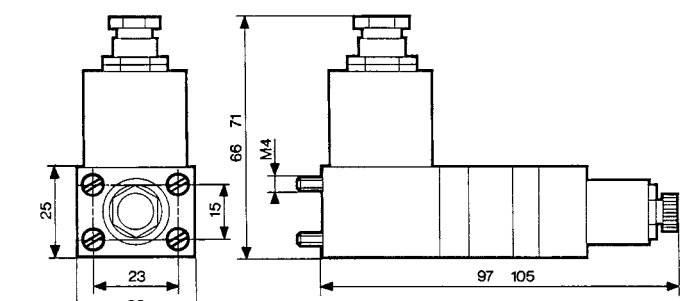

Vacuum handling components

- › Sur le principe du Venturi
- › Facilement raccordable

 Also available in **ATEX** version for use in potentially explosive atmospheres in accordance with 94/9/EC Directive

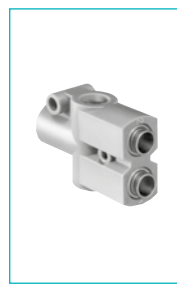

Part numbers

Vacuum generators	81 535 301 Sub-base mounting	81 545 001 Plug-in	81 545 005 Plug-in
-------------------	--	------------------------------	------------------------------

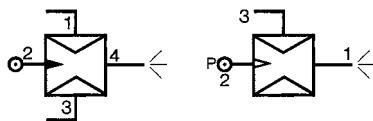

Characteristics

Push-in connectors for semi-rigid tubing (NFE 49100)	Male/Female/Female (MFF) Female/Female/ Female (FFF)	—	Ø 4 mm	—
Operating pressure	bar	2 → 8	2 → 8	2 → 8
Vacuum pad material		—	—	—
Weight	g	80	13	25

Detection of the pressure decrease can be achieved by the use of manostats (see pages 38/39)

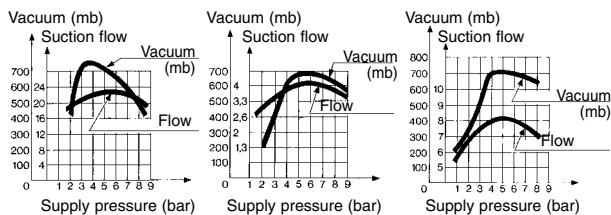

Dimensions

81 535 301

Sub-base mounting 81 531... and 81 532...

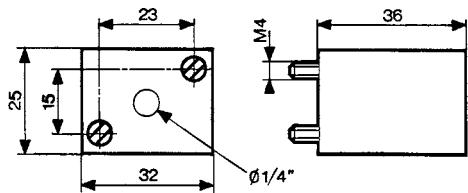

81 545 001

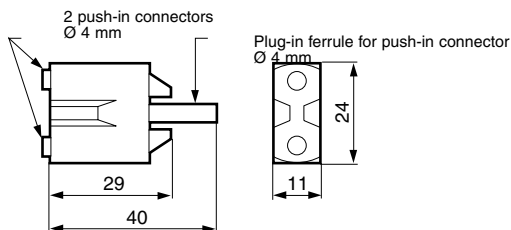

81 545 005

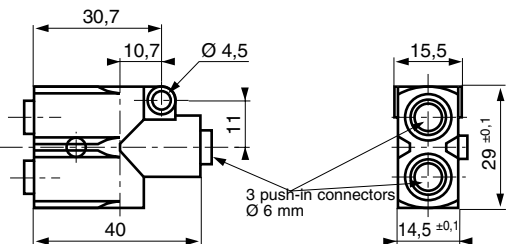

ATEX version products are available in the following catalogues: **Pneumatic products for explosive atmospheres** or on our website www.crouzet.com