

FALOWNIK MX2

Stworzony, żeby napędzać maszyny



- » Jakość gwarantowana przez firmę Omron
- » Duża funkcjonalność programowania
- » Wbudowane zabezpieczenia

Optymalne sterowania silnikiem i maszyną

MX2 zaprojektowano specjalnie z myślą o napędzaniu maszyn. Produkt umożliwia optymalne sterowanie silnikiem i maszyną. Zaawansowana konstrukcja i algorytmy MX2 zapewniają płynne sterowanie do prędkości zerowej, precyzję obsługi szybkich, cyklicznych operacji oraz sterowania momentem obrotowym w trybie otwartej pętli. MX2 kompleksowo obsługuje funkcje sterowania maszynami, np. pozycjonowanie, synchronizację prędkości i programowanie logiczne. MX2 jest w pełni zintegrowane z inteligentną platformą automatyki Omron. MX2 to produkt lidera w dziedzinie automatyzacji.

STEROWANIE SILNIKIEM

200% momentu startowego

- Praca niemalże bez ruchu (0,5 Hz)
- Płynne sterowanie wysokimi obciążeniami od sił bezwładności
- Kontrola szybkich obciążeń cyklicznych

Regulacja momentu obrotowego w trybie otwartej pętli

- Idealne przy niskim lub średnim momencie obrotowym
- Zastępuje wektor przepływu lub serwo w odpowiednich układach

Silniki specjalne

- Silniki z magnesami stałymi
- Silniki o wysokiej prędkości do 1000 Hz

Automatyczne strojenie jednego parametru

- MX2 zapewnia płynne i bezpieczne działanie – wystarczy podać moc znamionową silnika w kW





STEROWANIE MASZYNĄ

Wbudowane zabezpieczenia

- Zgodne z normą bezpieczeństwa ISO-13849 CAT3, poziom wydajności PL d
- 2 wejścia bezpieczeństwa
- EDM (External Device Monitoring)

Programowanie sterowników logicznych

- Programowanie przy użyciu schematów blokowych
- Edytor tekstu
- Intuicyjne – nawet 5 równoległych zadań

Pozycjonowanie

- Maks. 8 pre-definiowanych pozycji z funkcją przywrócenia
- Synchronizacja prędkości

Integracja z inteligentną automatyką Omron

- Narzędzie programowania CX-Drive podłączone do MX2 przez wbudowany port USB.
- Wbudowany Modbus RS485
- Opcjonalne moduły EtherCAT, Profibus, DeviceNet, ML-II i inne...

Pełna kontrola...

Wysoki początkowy moment obrotowy i możliwość sterowania momentem obrotowym w trybie otwartej pętli zapewniają pełną kontrolę oraz dynamikę i wydajność maszyny. Opcje połączenia do wszystkich najważniejszych systemów magistrali oraz zasilanie zewnętrzne prądem stałym o napięciu 24 V umożliwiają pełną kontrolę użytkownika nad pracą maszyny.



Dostrajanie częstotliwości a zmienność momentu

Przykład: 4-biegunowy silnik 7,5 kW



Wzorzec momentu obrotowego

Falownik MX2 dostarcza 200% początkowego momentu obrotowego bliskiego stanowi spoczynku (0,5 Hz) i może sterować momentem obrotowym w trybie otwartej pętli. Pozwala to na wykorzystanie falownika MX2 w zastosowaniach, gdzie uprzednio wykorzystywane były napędy sterowane wektorem prądu przemiennego w pętli zamkniętej.

Łatwa integracja z siecią

Wbudowana komunikacja RS485 Modbus i standardowe sieci przemysłowe, np. EtherCAT (zgodne z profilem CoE - CiA402), MECHATROLINK-II, DeviceNet, Profibus lub opcjonalnie CompoNet.

Zewnętrzne 24 VDC - płynne działanie

Wejście 24 VDC urządzenia MX2 zapewni procesorowi stałą kontrolę bez dodatkowego sprzętu, nawet po odłączeniu wejścia głównego. To klucz do kontrolowanego zatrzymania w sytuacji awaryjnej i ciągłości obsługi komunikacji sieciowej.

...0% ryzyka!

Falownik MX2 spełnia zasady bezpieczeństwa określone w normie ISO 13849-1 (kategoria 3) dzięki zastosowaniu dwóch wejść bezpieczeństwa i wyjścia EDM (External Device Monitoring – zewnętrzne monitorowanie urządzenia).

Nie wymaga zewnętrznych styczników po stronie silnika, co zapewnia użytkownikowi prostszą instalację.



Wbudowane funkcje bezpieczeństwa; ISO 13849-1, kategoria 3

Podwójne styczniki przy wyjściu falownika nie są już wymagane. Bezpośrednie połączenie z kontrolerem bezpieczeństwa zapewnia zgodność z normą ISO 13849-1, kategoria 3.



Wyjście monitorowania EDM

Wyjście EDM (External Device Monitoring) sprawdza bezpieczeństwo falownika, eliminując koszt i konieczność instalacji urządzeń zewnętrznych o tej samej funkcji.



Bezpośrednia integracja z obwodem bezpieczeństwa

Falowniki MX2 można łatwo wpasować w obwód bezpieczeństwa. Wejścia bezpieczeństwa można wykorzystać dla wielu falowników bez potrzeby stosowania dodatkowych przekaźników bezpieczeństwa.

Ustaw pozycję i uruchom!

MX2 to kontroler napędu i pozycji w jednym. Jest idealny do modułowych maszyn, które wymagają umiarkowanej dokładności pozycjonowania. Umożliwia synchronizację prędkości bez dodatkowego programowania.



Synchronizacja prędkości

Synchronizacja prędkości jest możliwa bez dodatkowych urządzeń zewnętrznych, poprzez standardowe ustawienia parametrów. MX2 pełni funkcję kontrolera prędkości zewnętrznego generatora impulsów/sygnału kodera do 32 KHz.



Funkcja pozycjonowania

Specjalnie opracowane funkcje umożliwiają falownikowi MX2 rozwiązywanie prostych zadań związanych z pozycjonowaniem bez konieczności stosowania zewnętrznego sterownika. Użytkownik może wybrać maksymalnie 8 pozycji plus pozycja początkowa. Co więcej falownik MX2 może być przełączany pomiędzy trybami prędkości i pozycjonowania.

Programuj i działaj!

Falownik MX2 pozwala tworzyć inteligentne rozwiązania za pomocą dostępnych funkcji PLC. Narzędzie programistyczne wykorzystujące schematy blokowe pozwala tworzyć programy zawierające do 1000 linii kodu oraz uruchamiać 5 zadań jednocześnie.



Swobodne programowanie

- “Programowanie przy użyciu schematów blokowych
- Integracja w narzędziu CX-Drive
- Do 1000 linii kodu dla każdego programu
- Równoległe działanie 5 zadań”

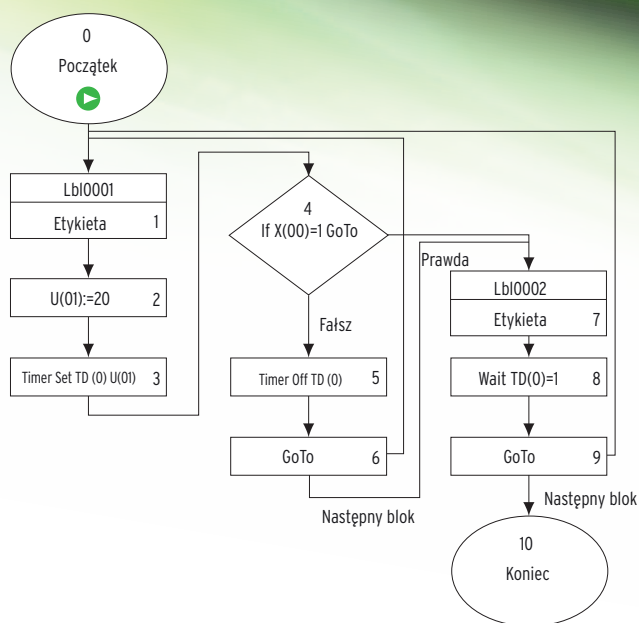

MX2

Born to drive machines

- Current vector control
- High starting torque: 200% at 0.5 Hz
- Double rating VT 120%/1 min and CT 150%/1 min
- Speed range up to 1000 Hz
- IM & PM motor control
- Torque control in open loop vector
- Positioning functionality
- Built-in application functionality (i.e. Brake control)
- Built-in logic programming
- Safety embedded compliant with ISO13849-1 (double input circuit and external device monitor EDM)
- USB port for PC programming
- 24 VDC backup supply for control board
- Fieldbus communications: Modbus, DeviceNet, Profibus, Componet, Ethercat, ML-II and Ethernet/IP
- PC configuration tool: CX-Drive
- RoHS, CE, cULus

Ratings

- 200 V Class single-phase 0.1 to 2.2 kW
- 200 V Class three-phase 0.1 to 15.0 kW
- 400 V Class three-phase 0.4 to 15.0 kW



System configuration



Specifications

Type designation



200 V class

Single-phase: 3G3MX2-□		B001	B002	B004	B007 ¹	B015	B022	-	-	-	-	-	
Three-phase: 3G3MX2-□		2001	2002	2004	2007	2015	2022	2037	2055	2075	2110	2150	
Motor kW ²	For VT setting	0.2	0.4	0.55	1.1	2.2	3.0	5.5	7.5	11	15	18.5	
	For CT setting	0.1	0.2	0.4	0.75	1.5	2.2	3.7	5.5	7.5	11	15	
Output characteristics	Inverter capacity kVA	200 VT	0.4	0.6	1.2	2.0	3.3	4.1	6.7	10.3	13.8	19.3	23.9
		200 CT	0.2	0.5	1.0	1.7	2.7	3.8	6.0	8.6	11.4	16.2	20.7
		240 VT	0.4	0.7	1.4	2.4	3.9	4.9	8.1	12.4	16.6	23.2	28.6
		240 CT	0.3	0.6	1.2	2.0	3.3	4.5	7.2	10.3	13.7	19.5	24.9
	Rated output current (A) at VT		1.2	1.9	3.5	6.0	9.6	12.0	19.6	30.0	40.0	56.0	69.0
Rated output current (A) at CT		1.0	1.6	3.0	5.0	8.0	11.0	17.5	25.0	33.0	47.0	60.0	
Max. output voltage		Proportional to input voltage: 0..240 V											
Max. output frequency		1000 Hz ³											
Power supply	Rated input voltage and frequency		Single-phase 200..240 V 50/60 Hz 3-phase 200..240 V 50/60 Hz										
	Allowable voltage fluctuation		-15%..+10%										
	Allowable frequency fluctuation		5%										
Braking torque	At short-time deceleration At capacitor feedback	100%: <50Hz 50%: <60Hz				70%: <50Hz 50%: <60Hz		Approx 20%			-		
		Cooling method					Self cooling ⁴			Forced-air-cooling			

1. Three phase model use forced-air-cooling but single phase model is self cooling.
2. Based on a standard 3-Phase standard motor.
3. Above 400 Hz with some function limitation.
4. Forced air cooling for IP54 models

400 V class

Three-phase: 3G3MX2-□		4004	4007	4015	4022	4030	4040	4055	4075	4110	4150	
Motor kW ¹	For VT setting	0.75	1.5	2.2	3.0	4.0	5.5	7.5	11	15	18.5	
	For CT setting	0.4	0.75	1.5	2.2	3.0	4.0	5.5	7.5	11	15	
Output characteristics	Inverter capacity kVA	380 VT	1.3	2.6	3.5	4.5	5.7	7.3	11.5	15.1	20.4	25.0
		380 CT	1.1	2.2	3.1	3.6	4.7	6.0	9.7	11.8	15.7	20.4
		480 VT	1.7	3.4	4.4	5.7	7.3	9.2	14.5	19.1	25.7	31.5
		480 CT	1.4	2.8	3.9	4.5	5.9	7.6	12.3	14.9	19.9	25.7
	Rated output current (A) at VT		2.1	4.1	5.4	6.9	8.8	11.1	17.5	23.0	31.0	38.0
Rated output current (A) at CT		1.8	3.4	4.8	5.5	7.2	9.2	14.8	18.0	24.0	31.0	
Max. output voltage		Proportional to input voltage: 0..480 V										
Max. output frequency		1000 Hz ²										
Power supply	Rated input voltage and frequency		3-phase 380..480 V 50/60 Hz									
	Allowable voltage fluctuation		-15%..+10%									
	Allowable frequency fluctuation		5%									
Braking torque	At short-time deceleration ^{*3} At capacitor feedback	100%: <50Hz 50%: <60Hz				70%: <50Hz 50%: <60Hz		-			-	
		Cooling method					Self cooling ³		Forced-air-cooling			

1. Based on a standard 3-Phase standard motor.
2. Above 400 Hz with some function limitation.
3. Forced air cooling for IP54 models

Specifications

Common specifications

Model number 3G3MX2		Specifications
Control functions	Control methods	Phase-to-phase sinusoidal pulse with modulation PWM (Sensorless vector control, V/f)
	Output frequency range	0.10..1000.00 Hz (with restrictions above 400Hz)
	Frequency precision	Digital set value: ±0.01% of the max. frequency Analogue set value: ±0.2% of the max. frequency (25 ±10°C)
	Resolution of frequency set value	Digital set value: 0.01 Hz Analogue set value: 1/1000 of maximum frequency
	Resolution of output frequency	0.01Hz
	Starting torque	200% / 0.5 Hz
	Overload capability	Dual rating: Heavy duty (CT): 150% for 1 minute Normal Duty (VT): 120% for 1 minute
	Frequency set value	0 to 10 VDC (10 KΩ), 4 to 20 mA (100 Ω), RS485 Modbus, Network options
	V/f Characteristics	Constant/ reduced torque, free V/f
Functionality	Inputs signals	FW (forward run command), RV (reverse run command), CF1~CF4 (multi-stage speed setting), JG (jog command), DB (external braking), SET (set second motor), 2CH (2-stage accel./decel. command), FRS (free run stop command), EXT (external trip), USP (startup function), CS (commercial power switchover), SFT (soft lock), AT (analog input selection), RS (reset), PTC (thermistor thermal protection), STA (start), STP (stop), F/R (forward/reverse), PID (PID disable), PIDC (PID reset), UP (remote control up function), DWN (remote control down function), UDC (remote control data clear), OPE (operator control), SF1~SF7 (multi-stage speed setting; bit operation), OLR (overload restriction), TL (torque limit enable), TRQ1 (torque limit changeover1), TRQ2 (torque limit changeover2), BOK (Braking confirmation), LAC (LAD cancellation), PCLR (position deviation clear), ADD (add frequency enable), F-TM (force terminal mode), ATR (permission of torque command input), KHC (Cumulative power clear), MI1~MI7 (general purpose inputs for EzSQ), AHD (analog command hold), CP1~CP3 (multistage-position switches), ORL (limit signal of zero-return), ORC (trigger signal of zero-return), SPD (speed/position changeover), GS1~GS2 (STO inputs, safety related signals), 485 (Starting communication signal), PRG (executing EzSQ program), HLD (retain output frequency), ROK (permission of run command), EB (rotation direction detection of B-phase), DISP (display limitation), OP (option control signal), NO (no function)
	Output signals	RUN (run signal), FA1~FA5 (frequency arrival signal), OL,OL2 (overload advance notice signal), OD (PID deviation error signal), AL (alarm signal), OTQ (over/under torque threshold), UV (under-voltage), TRQ (torque limit signal), RNT (run time expired), ONT (power ON time expired), THM (thermal warning), BRK (brake release), BER (brake error), ZS (0Hz detection), DSE (speed deviation excessive), POK (positioning completion), ODC (analog voltage input disconnection), OIdc (analog current input disconnection), FBV (PID second stage output), NDc (network disconnect detection), LOG1~LOG3 (Logic output signals), WAC (capacitor life warning), WAF (cooling fan warning), FR (starting contact), OHF (heat sink overheat warning), LOC (Low load), MO1~MO3 (general outputs for EzSQ), IRDY (inverter ready), FWR (forward operation), RVR (reverse operation), MJA (major failure), WCO (window comparator O), WCOI (window comparator OI), FREF (frequency command source), REF (run command source), SETM (second motor in operation), EDM (STO (safe torque off) performance monitor), OP (option control signal), NO (no function)
	Standard functions	Free-V/f, manual/automatic torque boost, output voltage gain adjustment, AVR function, reduced voltage start, motor data selection, auto-tuning, motor stabilization control, reverse running protection, simple position control, simple torque control, torque limiting, automatic carrier frequency reduction, energy saving operation, PID function, non-stop operation at instantaneous power failure, brake control, DC injection braking, dynamic braking (BRD), frequency upper and lower limiters, jump frequencies, curve accel and decel (S, U, inverted U,EL-S), 16-stage speed profile, fine adjustment of start frequency, accel and decel stop, process jogging, frequency calculation, frequency addition, 2-stage accel/decel, stop mode selection, start/end freq., analog input filter, window comparators, input terminal response time, output signal delay/hold function, rotation direction restriction, stop key selection, software lock, safe stop function, scaling function, display restriction, password function, user parameter, initialization, initial display selection, cooling fan control, warning, trip retry, frequency pull-in restart, frequency matching, overload restriction, over current restriction, DC bus voltage AVR
	Analogue inputs	2 analogue inputs 0 to 10 V (10 KΩ), 4 to 20 mA (100 Ω)
	Pulse train input terminal	0 to 10 V (up to 24 V), up to 32 kHz
	Accel/Decel times	0.01 to 3600.0 s (line/curve selection), 2nd accel/decel setting available
	Display	Status indicator LED's Run, Program, Alarm, Power, Hz, Amps Digital operator: Available to monitor 32 items: frequency reference, output current, output frequency...
	Motor overload protection	Electronic Thermal overload relay and PTC thermistor input
	Instantaneous overcurrent	200% of rated current
	Overload	Dual rating: Heavy duty (CT): 150% for 1 minute Normal Duty (VT): 120% for 1 minute
Overvoltage	800 V for 400 V type and 400 V for 200 V type	
Undervoltage	345 V for 400 V type and 172.5 V for 200 V type	
Momentary power loss	Following items are selectable: Alarm, decelerates to stop, decelerates to stop with DC bus controlled, restart	
Cooling fin overheat	Temperature monitor and error detection	
Stall prevention level	Stall prevention during acceleration/deceleration and constant speed	
Ground fault	Detection at power-on	
Power charge indication	On when power is supplied to the control part	
Ambient conditions	Degree of protection	IP20, Varnish coating on PCB & IP54 (For 3G3MX2-D□ type)
	Ambient humidity	90% RH or less (without condensation)
	Storage temperature	-20°C..+65°C (short-term temperature during transportation)
	Ambient temperature ¹	-10°C to 50°C (Both the carrier frequency and output current need to be reduced over 40°C)
	Installation	Indoor (no corrosive gas, dust, etc.)
	Installation height	Max. 1000 m
Vibration	5.9 m/s ² (0.6G), 10 to 55 Hz	

1. Some types of 3G3MX2-D requires special derating depending on installation conditions and carrier frequency selected. Check the manual for details

Dimensions

IP20



Voltage class	Inverter model 3G3MX2-A□	Figure	Dimensions in mm																	
			W	W1	H	H1	t	D	D1	D2	d	Weight (KG)								
Single-phase 200 V	B001	1	68	56	128	118	-	109	13.5	-	-	1.0								
	B002	1						123	27				1.0							
	B004	1						170.5	55				4.4	4.5	1.1					
	B007	2						170.5	55				4.4	4.5	1.4					
	B015	2						170.5	55				4.4	4.5	1.8					
B022	2	170.5	55	4.4	4.5	1.8														
Three-phase 200 V	2001	1	68	56	128	118	-	109	13.5	-	-	1.0								
	2002	1						113	27				1.0							
	2004	1						146	50				1.1							
	2007	1						170.5	55				4.4	4.5	1.2					
	2015	2						170.5	55				4.4	4.5	1.6					
	2022	2						170.5	55				4.4	4.5	1.8					
	2037	3						140	128				128	118	5	170.5	55	4.4	4.5	2.0
	2055	3						140	122				260	248	6	155	73.3	6	6	3.0
	2075	3						140	122				260	248	6	155	73.3	6	6	3.4
Three-phase 400 V	2110	3	180	160	296	284	7	175	97	5	7	5.1								
	2150	3	220	192	350	336	7	175	84	5	7	7.4								
	4004	2	108	96	128	118	-	144	28	-	-	1.5								
	4007	2						171					1.6							
	4015	2						171					1.8							
	4022	2						171					1.9							
	4030	2	171	55	1.9															
	4040	3	140	128	128	118	5	171	55	4.4	4.5	2.1								
4055	3	122		260	248	6	155	73.3	6	6	3.5									
4075	3	122		260	248	6	155	73.3	6	6	3.5									
4110	3	180		160	296	284	7	175	97	5	7	4.7								
4150	3	180	160	296	284	7	175	97	5	7	5.2									

Option board



Note: Option boards could be fitted inside the IP54 model

IP54

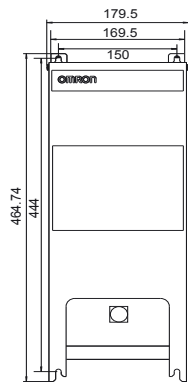

Figure 1



Figure 2

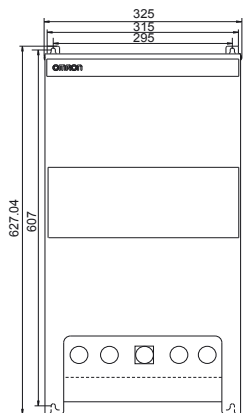
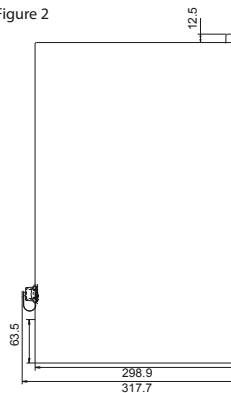

Figure 3



Figure 4

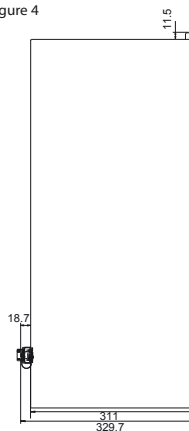

Figure 1	Figure 2	Figure 3	Figure 4
3G3MX2-DB001-E	3G3MX2-DB001-EC	3G3MX2-D2055-EC	3G3MX2-D2110-EC
3G3MX2-DB002-E	3G3MX2-DB002-EC	3G3MX2-D2075-EC	3G3MX2-D2150-EC
3G3MX2-DB004-E	3G3MX2-DB004-EC	3G3MX2-D4055-EC	3G3MX2-D4110-EC
3G3MX2-D2001-E	3G3MX2-DB007-EC	3G3MX2-D4075-EC	3G3MX2-D4150-EC
3G3MX2-D2002-E	3G3MX2-DB015-EC		
3G3MX2-D2004-E	3G3MX2-DB022-EC		
3G3MX2-D2007-E	3G3MX2-D2001-EC		
	3G3MX2-D2002-EC		
	3G3MX2-D2004-EC		
	3G3MX2-D2007-EC		
	3G3MX2-D2015-EC		
	3G3MX2-D2022-EC		
	3G3MX2-D2037-EC		
	3G3MX2-D4004-EC		
	3G3MX2-D4007-EC		
	3G3MX2-D4015-EC		
	3G3MX2-D4022-EC		
	3G3MX2-D4030-EC		
	3G3MX2-D4040-EC		

Rasmi footprint filters

Rasmi model		Dimensions					
		W	H	L	X	Y	M
1x200 V	AX-FIM1010-RE	71	45	169	156	51	M4
	AX-FIM1014-RE	111	50	169	156	91	M4
	AX-FIM1024-RE	111	50	169	156	91	M4
3x200 V	AX-FIM2010-RE	82	50	194	181	62	M4
	AX-FIM2020-RE	111	50	169	156	91	M4
	AX-FIM2030-RE	144	50	174	161	120	M4
	AX-FIM2060-RE	150	52	320	290	122	M5
	AX-FIM2080-RE	188	62	362	330	160	M5
	AX-FIM2100-RE	220	62	415	380	192	M6
3x400 V	AX-FIM3005-RE	114	46	169	156	91	M4
	AX-FIM3010-RE	114	46	169	156	91	M4
	AX-FIM3014-RE	144	50	174	161	120	M4
	AX-FIM3030-RE	150	52	306	290	122	M5
	AX-FIM3050-RE	182	62	357	330	160	M5



Schaffner footprint filters

Rasmi model		Dimensions							
		W	H	L	X	Y	A	B	M
1x200 V	AX-FIM1010-SE-V1	70	40	166	156	51	150	50	M5
	AX-FIM1024-SE-V1	110	50	166	156	91	150	80	M5
3x200 V	AX-FIM2010-SE-V1	80	40	191	181	62	150	50	M5
	AX-FIM2020-SE-V1	110	50	160	156	91	150	80	M5
	AX-FIM2030-SE-V1	142	50	171	161	120	150	112	M5
	AX-FIM2060-SE-V1	140	55	304	290	122	286	112	M5
	AX-FIM2080-SE-V1	180	55	344	330	160	323	140	M5
	AX-FIM2100-SE-V1	220	65	394	380	192	376	180	M5
3x400 V	AX-FIM3005-SE-V1	110	50	166	156	91	150	80	M5
	AX-FIM3010-SE-V1	110	50	166	156	91	150	80	M5
	AX-FIM3014-SE-V1	142	50	171	161	120	150	112	M5
	AX-FIM3030-SE-V1	140	55	304	290	122	286	112	M5
	AX-FIM3050-SE-V1	180	55	344	330	160	323	140	M5



Input AC Reactor

Voltage	Reference	Dimensions						Weight kg
		A	B2	C2	D	E	F	
200 V	AX-RAI02800080-DE	120	70	120	80	52	5.5	1.78
	AX-RAI00880200-DE	120	80	120	80	62	5.5	2.35
	AX-RAI00350335-DE	180	85	190	140	55	6	5.5
	AX-RAI00180670-DE	180	85	190	140	55	6	5.5
400 V	AX-RAI07700050-DE	120	70	120	80	52	5.5	1.78
	AX-RAI03500100-DE	120	80	120	80	62	5.5	2.35
	AX-RAI01300170-DE	120	80	120	80	62	5.5	2.50
	AX-RAI00740335-DE	180	85	190	140	55	6	5.5



DC Reactor

Voltage	Reference	Dimensions								Weight kg
		A	B	C	D	E	F	G	H	
200 V	AX-RC21400016-DE	84	113	96	101	66	5	7.5	2	1.22
	AX-RC10700032-DE									
	AX-RC06750061-DE			105						
	AX-RC03510093-DE			116						
	AX-RC02510138-DE	108	135	124	120	82	6.5	9.5	3.20	
	AX-RC01600223-DE	120	152	136	135	94	7	9.5	-	5.20
	AX-RC01110309-DE			146						6.00
	AX-RC00840437-DE			160						11.4
	AX-RC00590614-DE	150	177	182.6	160	115	-	2	-	14.3
	AX-RC00440859-DE									



Voltage	Reference	Dimensions								Weight kg
		A	B	C	D	E	F	G	H	
400 V	AX-RC43000020-DE	84	113	96	101	66	5	7.5	2	1.22
	AX-RC27000030-DE			105						1.60
	AX-RC14000047-DE			116						1.95
	AX-RC10100069-DE	120	152	133	135	94	7	9.5	-	3.70
	AX-RC06400116-DE			146						6.00
	AX-RC04410167-DE	150	177	136	160	115	7	2	-	5.20
	AX-RC03350219-DE			146						6.00
	AX-RC02330307-DE			160						11.4
AX-RC01750430-DE			182.6							14.3

Output AC Reactor

Voltage	Reference	Dimensions						Weight kg
		A	B2	C2	D	E	F	
200 V	AX-RAO11500026-DE	120	70	120	80	52	5.5	1.78
	AX-RAO07600042-DE	120	70	120	80	52	5.5	1.78
	AX-RAO04100075-DE	120	80	120	80	62	5.5	2.35
	AX-RAO03000105-DE	120	80	120	80	62	5.5	2.35
	AX-RAO01830180-DE	180	85	190	140	55	6	5.5
	AX-RAO01150220-DE	180	85	190	140	55	6	5.5
	AX-RAO00950320-DE	180	85	205	140	55	6	6.5
	AX-RAO00630430-DE	180	95	205	140	65	6	9.1
	AX-RAO00490640-DE	180	95	205	140	65	6	9.1
400 V	AX-RAO16300038-DE	120	70	120	80	52	5.5	1.78
	AX-RAO11800053-DE	120	80	120	80	52	5.5	2.35
	AX-RAO07300080-DE	120	80	120	80	62	5.5	2.35
	AX-RAO04600110-DE	180	85	190	140	55	6	5.5
	AX-RAO03600160-DE	180	85	205	140	55	6	6.5
	AX-RAO02500220-DE	180	95	205	140	55	6	9.1
AX-RAO02000320-DE	180	105	205	140	85	6	11.7	



Chokes

Reference	D diameter	Motor kW	Dimensions						Weight kg
			L	W	H	X	Y	m	
AX-FER2102-RE	21	< 2.2	85	22	46	70	-	5	0.1
AX-FER2515-RE	25	< 15	105	25	62	90	-	5	0.2
AX-FER5045-RE	50	< 45	150	50	110	125	30	5	0.7

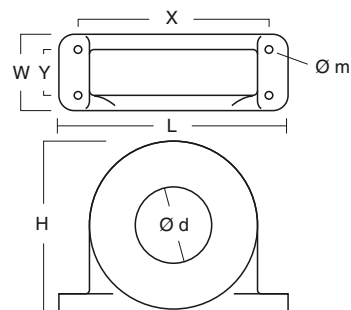

Resistor dimensions

AX-REM00K1200

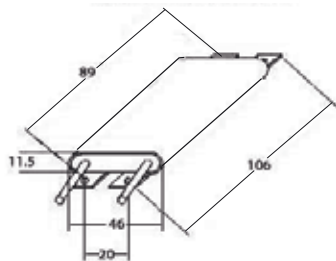

Fig 1

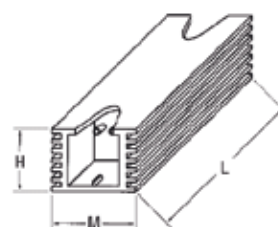

Fig 2

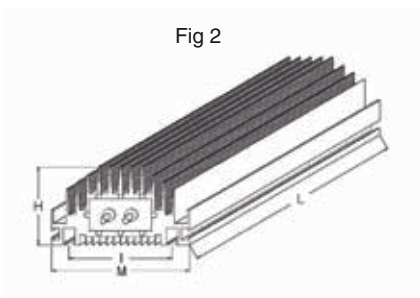

Fig 3

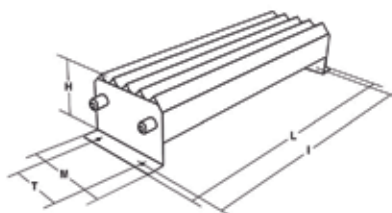
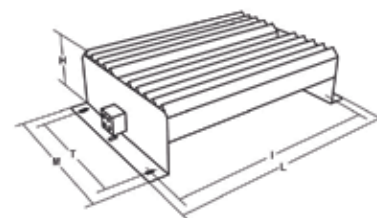

Fig 4



Type	Fig.	Dimensions					Weight kg
		L	H	M	I	T	
AX-REM00K1400-IE	1	105	27	36	94	-	0.2
AX-REM00K2070-IE							
AX-REM00K2120-IE							
AX-REM00K2200-IE							
AX-REM00K4075-IE							
AX-REM00K4035-IE	2	200	27	36	189	-	0.425
AX-REM00K4030-IE							
AX-REM00K5120-IE							
AX-REM00K6100-IE							
AX-REM00K6035-IE							
AX-REM00K9070-IE	3	365	73	105	350	70	4
AX-REM01K9017-IE							
AX-REM02K1070-IE	4	310	100	240	295	210	7
AX-REM02K1017-IE							
AX-REM03K5035-IE							
AX-REM03K5010-IE							

Standard connections



Terminal Block Specifications

Terminal	Name	Function (signal level)
R/L1, S/L2, T/L3	Main circuit power supply input	Used to connect line power to the drive. Drives with single-phase 200 V input power use only terminals R/L1 and N (T/L3), terminal S/L2 is not available for these units
U/T1, V/T2, W/T3	Inverter output	Used to connect the motor
PD/+1, P/+	External DC reactor terminal	Normally connected by the short-circuit bar. Remove the short-circuit bar between +1 and P/+ when a DC reactor is connected.
P/+, N/-	Regenerative braking unit terminal	Connect optional regenerative braking units (If a braking torque is required)
P/+, RB	Braking resistor terminals	Connect option braking resistor (if a braking torque is required)
⊕	Grounding	For grounding (grounding should conform to the local grounding code.)

Control Circuit

Type	No.	Signal name	Function	Signal level
Digital input signals	PLC	Intelligent input common	Source type: connecting [P24] to [1]-[7] turns inputs ON Sink type: connecting [L] to [1]-[7] turns inputs ON	-
	P24	Internal 24 VDC	24 VDC, 30mA	24 VDC, 100 mA
	1	Multi-function Input selection 1	Factory setting: Forward/ Stop	27 VDC max
	2	Multi-function Input selection 2	Factory setting: Reverse/ Stop	
	3/GS1	Multi-function Input selection 3 / safe stop input 1	Factory setting: External trip	
	4/GS2	Multi-function Input selection 4 / safe stop input 2	Factory setting: Reset	
	5/PTC	Multi-function Input selection 5 / PTC thermistor input	Factory setting: Multi-step speed reference 1	
	6	Multi-function input selection 6	Factory setting: Multi-step speed reference 2	
	7/EB	Multi-function input selection 7 / Pulse train input B	Factory setting: Jog	
	L	Multi-function Input selection common (in upper row)	--	
Pulse train	EA	Pulse train input A	Factory setting: Speed reference	32 kHz max 5 to 24 VDC
	EO	Pulse train output	LAD frequency	10 VDC 2 mA 32 kHz max
Analog input signal	H	Frequency reference power supply	10 VDC 10 mA max	
	O	Voltage frequency reference signal	0 to 10 VDC (10 kΩ)	
	OI	Current frequency reference signal	4 to 20 mA (250 Ω)	
	L	Frequency reference common (bottom row)	--	
Digital output signals	11/EDM	Discrete logic output 1 / EDM output	Factory setting: During Run	27 VDC, 50 mA max EDM based on ISO13849-1
	12	Discrete logic output 2	Factory setting: Frequency arrival type 1	
	CM2	GND logic output	--	
	AL0	Relay common contact	Factory setting: Alarm signal Under normal operation AL1 - AL0 Closed AL2 - AL0 Open	R load 250 VAC 2.5 A 30 VDC 3.0 A I load 250 VAC 0.2 A 30 VDC 0.7 A
	AL1	Relay contact, normally open		
	AL2	Relay contact, normally closed		
Monitor Signal	AM	Analog voltage output	Factory setting: LAD frequency	0 to 10 VDC 1 mA
Comms	SP	Serial communication terminal	RS485 Modbus communication	
	SN			

Side by side mounting



Inverter heat loss

Three-phase 200 V class

Model 3G3MX2		A2001	A2002	A2004	A2007	A2015	A2022	A2037	A2055	A2075	A2110	A2150
Inverter capacity kVA	200 VT	0.4	0.6	1.2	2.0	3.3	4.1	6.7	10.3	13.8	19.3	23.9
	200 CT	0.2	0.5	1.0	1.7	2.7	3.8	6.0	8.6	11.4	16.2	20.7
	240 VT	0.4	0.7	1.4	2.4	3.9	4.9	8.1	12.4	16.6	23.2	28.6
	240 CT	0.3	0.6	1.2	2.0	3.3	4.5	7.2	10.3	13.7	19.5	24.9
Rated current (A) VT		1.2	1.9	3.4	6.0	9.6	12.0	19.6	30.0	40.0	56.0	69.0
Rated current (A) CT		1.0	1.6	3.0	5.0	8.0	11.0	17.5	25.0	33.0	47.0	60.0
Total heat loss		12	22	30	48	79	104	154	229	313	458	625
Efficiency at rated load		89.5	90	93	94	95	95.5	96	96	96	96	96
Cooling Method		Self cooling					Forced-air-cooling					

Single-phase 200 V class

Model 3G3MX2		AB001	AB002	AB004	AB007	AB015	AB022
Inverter capacity kVA	200V VT	0.4	0.6	1.2	2.0	3.3	4.1
	200V CT	0.2	0.5	1.0	1.7	2.7	3.8
	240V VT	0.4	0.7	1.4	2.4	3.9	4.9
	240V CT	0.3	0.6	1.2	2.0	3.3	4.5
Rated current (A) VT		1.2	1.9	3.4	6.0	9.6	12.0
Rated current (A) CT		1.0	1.6	3.0	5.0	8.0	11.0
Total heat loss		12	22	30	48	79	104
Efficiency at rated load		89.5	90	93	94	95	95.5
Cooling Method		Self cooling				Forced-air-cooling	

Three-phase 400 V class

Model 3G3MX2		A4004	A4007	A4015	A4022	A4030	A4040	A4055	A4075	A4110	A4150
Inverter capacity kVA	380V VT	1.3	2.6	3.5	4.5	5.7	7.3	11.5	15.1	20.4	25.0
	380V CT	1.1	2.2	3.1	3.6	4.7	6.0	9.7	11.8	15.7	20.4
	480V VT	1.7	3.4	4.4	5.7	7.3	9.2	14.5	19.1	25.7	31.5
	480V CT	1.4	2.8	3.9	4.5	5.9	7.6	12.3	14.9	19.9	25.7
Rated current (A) VT		2.1	4.1	5.4	6.9	8.8	11.1	17.5	23.0	31.0	38.0
Rated current (A) CT		1.8	3.4	4.8	5.5	7.2	9.2	14.8	18.0	24.0	31.0
Total heat loss		35	56	96	116	125	167	229	296	411	528
Efficiency at rated load		92	93	94	95	96	96	96	96.2	96.4	96.6
Cooling Method		Self cooling				Forced-air-cooling					

Input AC Reactor



3 phase 200 V class				400 V class			
Max. applicable motor output kW	Reference	Current value A	Inductance mH	Max. applicable motor output kW	Reference	Current value A	Inductance mH
1.5	AX-RAI02800080-DE	8.0	2.8	1.5	AX-RAI07700050-DE	5.0	7.7
3.7	AX-RAI00880200-DE	20.0	0.88	4.0	AX-RAI03500100-DE	10.0	3.5
7.5	AX-RAI00350335-DE	33.5	0.35	7.5	AX-RAI01300170-DE	17.0	1.3
15	AX-RAI00180670-DE	67.0	0.18	15	AX-RAI00740335-DE	33.5	0.74

DC Reactor



200 V class				400 V class			
Max. applicable motor output kW	Reference	Current value A	Inductance mH	Max. applicable motor output kW	Reference	Current value A	Inductance mH
0.2	AX-RC21400016-DE	1.6	21.4	0.4	AX-RC43000020-DE	2.0	43.0
0.4	AX-RC10700032-DE	3.2	10.7	0.7	AX-RC27000030-DE	3.0	27.0
0.7	AX-RC06750061-DE	6.1	6.75	1.5	AX-RC14000047-DE	4.7	14.0
1.5	AX-RC03510093-DE	9.3	3.51	2.2	AX-RC10100069-DE	6.9	10.1
2.2	AX-RC02510138-DE	13.8	2.51	3.0	AX-RC08250093-DE	9.3	8.25
3.7	AX-RC01600223-DE	22.3	1.60	4.0	AX-RC06400116-DE	11.6	6.40
5.5	AX-RC01110309-DE	30.9	1.11	5.5	AX-RC04410167-DE	16.7	4.41
7.5	AX-RC00840437-DE	43.7	0.84	7.5	AX-RC03350219-DE	21.9	3.35
11.0	AX-RC00590614-DE	61.4	0.59	11.0	AX-RC02330307-DE	30.7	2.33
15.0	AX-RC00440859-DE	85.9	0.44	15.0	AX-RC01750430-DE	43.0	1.75

Output AC Reactor

200 V class				400 V class			
Max. applicable motor output kW	Reference	Current value A	Inductance mH	Max. applicable motor output kW	Reference	Current value A	Inductance mH
0.4	AX-RAO11500026-DE	2.6	11.50	1.5	AX-RAO16300038-DE	3.8	16.30
0.75	AX-RAO07600042-DE	4.2	7.60				
1.5	AX-RAO04100075-DE	7.5	4.10				
2.2	AX-RAO03000105-DE	10.5	3.00	2.2	AX-RAO11800053-DE	5.3	11.80
3.7	AX-RAO01830160-DE	16.0	1.83	4.0	AX-RAO07300080-DE	8.0	7.30
5.5	AX-RAO01150220-DE	22.0	1.15	5.5	AX-RAO04600110-DE	11.0	4.60
7.5	AX-RAO00950320-DE	32.0	0.95	7.5	AX-RAO03600160-DE	16.0	3.60
11	AX-RAO00630430-DE	43.0	0.63	11	AX-RAO02500220-DE	22.0	2.50
15	AX-RAO00490640-DE	64.0	0.49	15	AX-RAO02000320-DE	32.0	2.00

Ordering information



3G3MX2

Voltage class	Specifications				Model	
	Constant torque		Variable torque		IP20	IP54
	Max motor kW	Rated current A	Max motor kW	Rated current A		
Single-phase 200 V	0.1	1.0	0.2	1.2	3G3MX2-AB001-E	3G3MX2-DB001-E/EC
	0.2	1.6	0.4	1.9	3G3MX2-AB002-E	3G3MX2-DB002-E/EC
	0.4	3.0	0.55	3.5	3G3MX2-AB004-E	3G3MX2-DB004-E/EC
	0.75	5.0	1.1	6.0	3G3MX2-AB007-E	3G3MX2-DB007-E/EC
	1.5	8.0	2.2	9.6	3G3MX2-AB015-E	3G3MX2-DB015-E/EC
	2.2	11.0	3.0	12.0	3G3MX2-AB022-E	3G3MX2-DB022-E/EC
Three-phase 200 V	0.1	1.0	0.2	1.2	3G3MX2-A2001-E	3G3MX2-D2001-E/EC
	0.2	1.6	0.4	1.9	3G3MX2-A2002-E	3G3MX2-D2002-E/EC
	0.4	3.0	0.55	3.5	3G3MX2-A2004-E	3G3MX2-D2004-E/EC
	0.75	5.0	1.1	6.0	3G3MX2-A2007-E	3G3MX2-D2007-E/EC
	1.5	8.0	2.2	9.6	3G3MX2-A2015-E	3G3MX2-D2015-E/EC
	2.2	11.0	3.0	12.0	3G3MX2-A2022-E	3G3MX2-D2022-E/EC
	3.7	17.5	5.5	19.6	3G3MX2-A2037-E	3G3MX2-D2037-E/EC
	5.5	25.0	7.5	30.0	3G3MX2-A2055-E	3G3MX2-D2055-E/EC
	7.5	33.0	11	40.0	3G3MX2-A2075-E	3G3MX2-D2075-E/EC
11	47.0	15	56.0	3G3MX2-A2110-E	3G3MX2-D2110-E/EC	
Three-phase 400 V	0.4	1.8	0.75	2.1	3G3MX2-A4004-E	3G3MX2-D4004-E/EC
	0.75	3.4	1.5	4.1	3G3MX2-A4007-E	3G3MX2-D4007-E/EC
	1.5	4.8	2.2	5.4	3G3MX2-A4015-E	3G3MX2-D4015-E/EC
	2.2	5.5	3.0	6.9	3G3MX2-A4022-E	3G3MX2-D4022-E/EC
	3.0	7.2	4.0	8.8	3G3MX2-A4030-E	3G3MX2-D4030-E/EC
	4.0	9.2	5.5	11.1	3G3MX2-A4040-E	3G3MX2-D4040-E/EC
	5.5	14.8	7.5	17.5	3G3MX2-A4055-E	3G3MX2-D4055-E/EC
	7.5	18.0	11	23.0	3G3MX2-A4075-E	3G3MX2-D4075-E/EC
	11	24.0	15	31.0	3G3MX2-A4110-E	3G3MX2-D4110-E/EC
15	31.0	18.5	38.0	3G3MX2-A4150-E	3G3MX2-D4150-E/EC	

① Line filters

Inverter		Line filter Rasmi		Line filter Schaffner	
Voltage	Model 3G3MX2-□	Reference AX-FIM	Current (A)	Reference AX-FIM	Current (A)
1Phase 200 VAC	AB001 / AB002 / AB004	1010-RE	10	1010-SE-V1	8
	AB007	1014-RE	14	1024-SE-V1	27
	AB015 / AB022	1024-RE	24	1024-SE-V1	27
	A2001 / A2002 / A2004 / A2007	2010-RE	10	2010-SE-V1	7.8
3Phase 200 VAC	A2015 / A2022	2020-RE	20	2020-SE-V1	16
	A2037	2030-RE	30	2030-SE-V1	25
	A2055 / A2075	2060-RE	60	2060-SE-V1	50
	A2110	2080-RE	80	2080-SE-V1	75
3Phase 400 VAC	A2150	2100-RE	100	2100-SE-V1	100
	A4004 / A4007	3005-RE	5	3005-SE-V1	6
	A4015 / A4022 / A4030	3010-RE	10	3010-SE-V1	12
	A4040	3014-RE	14	3014-SE-V1	15
3Phase 400 VAC	A4055 / A4075	3030-RE	30	3030-SE-V1	29
	A4110 / A4150	3050-RE	50	3050-SE-V1	48

① Input AC reactors

Inverter		AC Reactor
Voltage	Model 3G3MX2-□	Reference
3-Phase 200 VAC	A2002 / A2004 / A2007	AX-RAI02800080-DE
	A2015 / A2022 / A2037	AX-RAI00880200-DE
	A2055 / A2075	AX-RAI00350335-DE
	A2110 / A2150	AX-RAI00180670-DE
1-Phase 200 VAC	AB002 / AB004	Under development
	AB007	
	AB015 / AB022	
3-Phase 400 VAC	A4004 / A4007 / A4015	AX-RAI07700050-DE
	A4022 / A4030 / A4040	AX-RAI03500100-DE
	A4055 / A4075	AX-RAI01300170-DE
	A4110 / A4150	AX-RAI00740335-DE

① DC reactors

200V single phase		200V 3-phase		400V 3-phase	
Inverter	DC Reactor	Inverter	DC Reactor	Inverter	DC Reactor
3G3MX2-AB001	AX-RC10700032-DE	3G3MX2-A2001	AX-RC21400016-DE	3G3MX2-A4004	AX-RC43000020-DE
3G3MX2-AB002		3G3MX2-A2002		3G3MX2-A4007	
3G3MX2-AB004	AX-RC06750061-DE	3G3MX2-A2004	AX-RC10700032-DE	3G3MX2-A4015	AX-RC14000047-DE
3G3MX2-AB007	AX-RC03510093-DE	3G3MX2-A2007	AX-RC06750061-DE	3G3MX2-A4022	AX-RC10100069-DE
3G3MX2-AB015	AX-RC02510138-DE	3G3MX2-A2015	AX-RC03510093-DE	3G3MX2-A4030	AX-RC08250093-DE
3G3MX2-AB022	AX-RC01600223-DE	3G3MX2-A2022	AX-RC02510138-DE	3G3MX2-A4040	AX-RC06400116-DE
		3G3MX2-A2037	AX-RC01600223-DE	3G3MX2-A4055	AX-RC04410167-DE
		3G3MX2-A2055	AX-RC01110309-DE	3G3MX2-A4075	AX-RC03350219-DE
		3G3MX2-A2075	AX-RC00840437-DE	3G3MX2-A4011	AX-RC02330307-DE
		3G3MX2-A2011	AX-RC00590614-DE	3G3MX2-A4015	AX-RC01750430-DE
		3G3MX2-A2015	AX-RC00440859-DE		

① Chokes

Model	Diameter	Description
AX-FER2102-RE	21	For 2.2 KW motors or below
AX-FER2515-RE	25	For 15 KW motors or below
AX-FER5045-RE	50	For 45 KW motors or below

① Output AC reactor

Inverter		AC Reactor
Voltage	Model 3G3MX2-□	Reference
200 VAC	A2001 / A2002 / A2004 AB001 / AB002 / AB004	AX-RAO11500026-DE
	A2007/AB007	AX-RAO07600042-DE
	A2015 / AB015	AX-RAO04100075-DE
	A2022 / AB022	AX-RAO03000105-DE
	A2037	AX-RAO01830160-DE
	A2055	AX-RAO01150220-DE
	A2075	AX-RAO00950320-DE
	A2110	AX-RAO00630430-DE
400 VAC	A2150	AX-RAO00490640-DE
	A4004 / A4007 / A4015	AX-RAO16300038-DE
	A4022	AX-RAO11800053-DE
	A4030 / A4040	AX-RAO07300080-DE
	A4055	AX-RAO04600110-DE
	A4075	AX-RAO03600160-DE
	A4110	AX-RAO02500220-DE
A4150	AX-RAO02000320-DE	

② Accessories

Types	Model	Description	Functions
Digital operator	AX-OP05-E	LCD remote operator	5 Line LCD remote operator with copy function, cable length max. 3m. 3 meters cable for connecting remote operator LED remote operator, cable length max. 3m Mounting kit for LED operator on panel Holder to put the AX-OP05-E inside of the cabinet
	3G3AX-CAJOP300-EE	Remote operator cable	
	3G3AX-OP01	LED remote operator	
	4X-KITMINI	Mounting kit for LED operator	
	3G3AX-OP05-H-E	Operator holder	
Accessories	AX-CUSBM002-E	PC configuration cable	Mini USB to USB connector cable

③ Communication option boards

Types	Model	Description	Functions
Communication options	3G3AX-MX2-PRT	Profibus option card	Used for running or stopping the inverter, setting or referencing parameters, and monitoring output frequency, output current, or similar items through communications with the host controller.
	3G3AX-MX2-DRT	DeviceNet option card	
	3G3AX-MX2-ECT	Ethercat option card	
	3G3AX-MX2-CRT	CompoNet option card	
	3G3AX-MX2-MRT	Mechatrolink II option card	
	3G3AX-MX2-EIP	Ethernet IP option board	

④ Braking unit, braking resistor unit

Voltage	Inverter				Braking resistor unit						
	Max. motor kW	Inverter 3G3MX2□		Connectable min. resistance Ω	Inverter mounted type (3 %ED, 10 sec max)		Braking torque %	Inverter mounted type (10%ED, 10 sec max)		Braking torque %	
		3-phase	1-phase		Type AX-	Resist Ω		Type AX-	Resist Ω		
200 V (Single-/Three-phase)	0.12	2001	B001	100	REM00K1400-IE	400	200	REM00K1400-IE	400	200	
	0.25	2002	B002		50	REM00K1200-IE	200	180	REM00K1200-IE	200	180
	0.55	2004	B004					100	REM00K2070-IE	70	200
	1.1	2007	B007	35	REM00K2070-IE	70	140	REM00K4075-IE	75	130	
	1.5	2015	B015				90	REM00K4035-IE	35	180	
	2.2	2022	B022	20	REM00K4075-IE	75	50	REM00K6035-IE	35	100	
	4.0	2040	-				75	REM00K9020-IE	20	150	
	5.5	2055	-	17	REM00K4035-IE	35	55	REM01K9017-IE	17	110	
	7.5	2075	-				40	REM02K1017-IE	17	75	
	11	2110	-	10	REM00K6035-IE	35	55	REM02K1017-IE	17	75	
15	2150	-	17				REM00K9017-IE	17	55	REM03K5010-IE	10
400 V (Three-phase)	0.55	4004	-	180	REM00K1400-IE	400	200	REM00K1400-IE	400	200	
	1.1	4007	-		100	REM00K1200-IE	200	200	REM00K2200-IE	200	190
	1.5	4015	-					130	REM00K5120-IE	120	200
	2.2	4022	-	70	REM00K2120-IE	120	160	REM00K6100-IE	100	140	
	3.0	4030	-				120	REM00K9070-IE	70	150	
	4.0	4040	-	35	REM00K4075-IE	75	100	REM01K9070-IE	70	110	
	5.5	4055	-				50	REM02K1070-IE	70	75	
	7.5	4075	-	70	REM00K6100-IE	100	55	REM03K5035-IE	35	110	
	11	4110	-				70	REM00K9070-IE	70	55	REM03K5035-IE
	15	4150	-	35	REM00K9070-IE	70	55	REM03K5035-IE	35	110	

⑤ Computer software

Types	Model	Description	Installation
Software	CX-drive	Computer software	Configuration and monitoring software tool
	CX-One	Computer software	Configuration and monitoring software tool
	€Saver	Computer software	Software tool for Energy Saving calculation

ALL DIMENSIONS SHOWN ARE IN MILLIMETERS.
To convert millimeters into inches, multiply by 0.03937. To convert grams into ounces, multiply by 0.03527.

OMRON EUROPE B.V. Wegalaan 67-69, NL-2132 JD, Hoofddorp, Holandia. Tel: +31 (0) 23 568 13 00 Fax: +31 (0) 23 568 13 88 industrial.omron.eu

POLSKA

OMRON ELECTRONICS Sp. z o.o.

ul. Cybernetyki 7A
Budynek LUMINAR
01-001 Warszawa
Tel. +48 22 458 66 66
Fax. +48 22 458 66 60
industrial.omron.pl

Austria

Tel: +43 (0) 2236 377 800
industrial.omron.at

Belgia

Tel: +32 (0) 2 466 24 80
industrial.omron.be

Dania

Tel: +45 43 44 00 11
industrial.omron.dk

Finlandia

Tel: +358 (0) 207 464 200
industrial.omron.fi

Francja

Tel: +33 (0) 1 56 63 70 00
industrial.omron.fr

Hiszpania

Tel: +34 913 777 900
industrial.omron.es

Holandia

Tel: +31 (0) 23 568 11 00
industrial.omron.nl

Niemcy

Tel: +49 (0) 2173 680 00
industrial.omron.de

Norwegia

Tel: +47 (0) 22 65 75 00
industrial.omron.no

Portugalia

Tel: +351 21 942 94 00
industrial.omron.pt

Republika Czeska

Tel: +420 234 602 602
industrial.omron.cz

Republika Południowej Afryki

Tel: +27 (0)11 579 2600
industrial.omron.co.za

Rosja

Tel: +7 495 648 94 50
industrial.omron.ru

Szwajcaria

Tel: +41 (0) 41 748 13 13
industrial.omron.ch

Szwecja

Tel: +46 (0) 8 632 35 00
industrial.omron.se

Turcja

Tel: +90 212 467 30 00
industrial.omron.com.tr

Węgry

Tel: +36 1 399 30 50
industrial.omron.hu

Wielka Brytania

Tel: +44 (0) 870 752 08 61
industrial.omron.co.uk

Włochy

Tel: +39 02 326 81
industrial.omron.it

Inne przedstawicielstwa

firmy Omron
industrial.omron.eu

Systemy automatyki

- Programowalne sterowniki logiczne (PLC) • Panele operatorskie (HMI) • Zdalne moduły We/Wy
- Przemysłowe komputery PC • Oprogramowanie

Sterowniki i napędy

- Kontrolery ruchu • Serwonapędy • Falowniki • Roboty

Komponenty sterujące

- Regulatory temperatury • Zasilacze • Przekazniki czasowe • Liczniki
- Przekazniki programowalne • Cyfrowe wskaźniki panelowe
- Przekazniki elektromechaniczne • Przekazniki monitorująco-kontrolne
- Przekazniki półprzewodnikowe • Wyłączniki krańcowe • Przyciski
- Niskonapięciowa aparatura przełączająca

Czujniki i urządzenia bezpieczeństwa

- Czujniki fotoelektryczne • Czujniki indukcyjne • Czujniki ciśnienia i pojemnościowe
- Kable połączeniowe • Czujniki przemieszczania i pomiaru szerokości
- Systemy wizyjne • Sieci bezpieczeństwa • Czujniki bezpieczeństwa
- Moduły bezpieczeństwa/moduły przekaznikowe • Zamki bezpieczeństwa/zamki ryglujące