

---

# 10 Axis Calibration (by UT2)

<b>10.1 General</b>	10 - 3
<b>10.2 Record of Corrections to Be Made</b>	10 - 5
<b>10.3 Operations on Axis Measurement Correction Tables</b>	10 - 6
10.3.1 Entering the Measurement Correction Table	10 - 7
10.3.2 Saving the Measurement Correction Table	10 - 8
10.3.3 Checking the Measurement Correction Table	10 - 9
10.3.4 Loading a Measurement Correction Table	10 - 10
10.3.5 Exit from the Utility Confirming the Changes Made	10 - 11



### 10.1 General

Axis calibration allows the system to add a correction depending on the real axis position to the measurement made by the coupler.

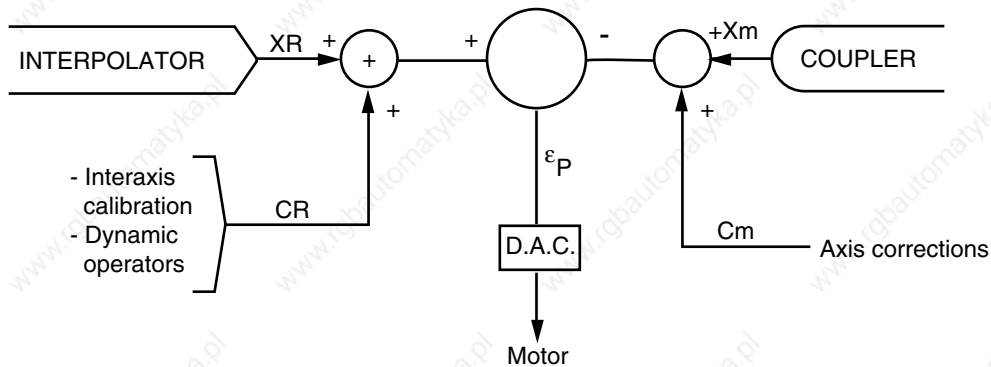

Axis calibration is carried out on both linear and rotary axes.

The corrections are entered for a limited number of points per axis. The system computes the corrections between two points by linear interpolation.

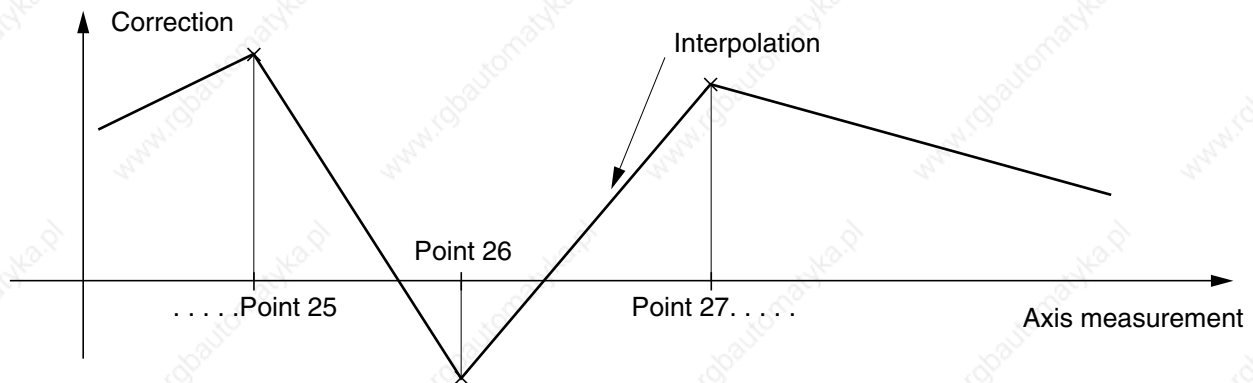

It is recommended to correct the measurements of the minimum and maximum travel points (defined by machine parameter P17). Otherwise, the value of the last correction is applied to these points:

Minimum and maximum travel points not corrected

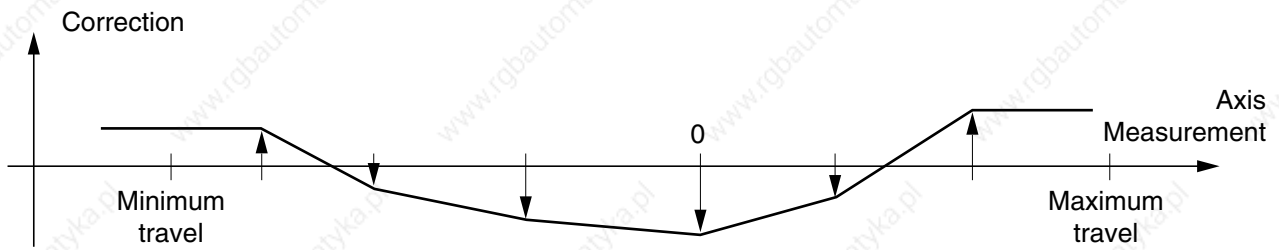

Minimum and maximum travel points corrected

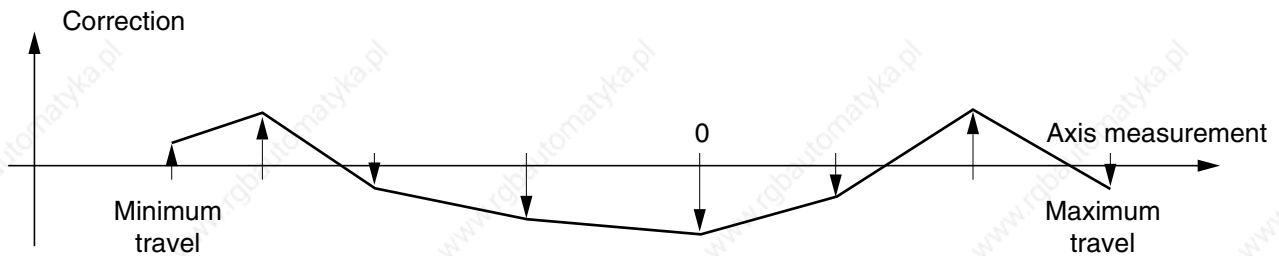

A maximum number of approximately 2600 points can be corrected for all the axes combined. There are no restrictions on how the points are distributed on the axes.

## 10.2 Record of Corrections to Be Made

The real axis position is taken for a series of points to determine the corrections required:

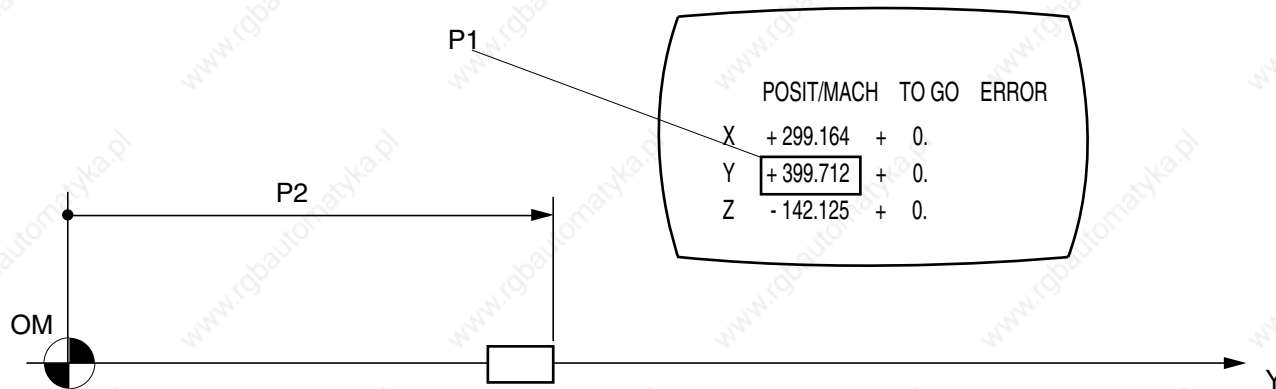

The corrections are in the internal system units (IU).

Axis number:

Unit:

Measured position (P1)							
Real position (P2)							
Correction (P2 - P1)							

The measured values and corresponding corrections are recorded in the correction tables (see 10.3.1).

### REMARKS

*A correction table must have at least three points.*

*The correction range is between -32768 and 32767 units.*

*For a rotary axis, the corrections must be identical for the 0 and 360 degree points.*

### 10.3 Operations on Axis Measurement Correction Tables

Select the CN UTILITY menu.

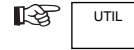

Display of the "CN UTILITY" menu.

Select the "UTILITIES PRESENT" menu.

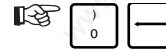

Display of the "UTILITIES PRESENT" menu.

Select the axis calibration utility.



Display of the menu:

AXIS CABLIBRATION VALUES

```
>0 DISPLAY - CHANGE
 1 LOAD
 2 UNLOAD
 3 VERIFY
```

Select the operation to be performed:

- enter a measurement correction table (see 10.3.1),
- load a measurement correction table (see 10.3.4),
- save a measurement correction table (see 10.3.2),
- check the measurement correction table (see 10.3.3),
- exit from the utility, confirming the data modified (see 10.3.5).

### 10.3.1 Entering the Measurement Correction Table

#### Initial Conditions

Record made of required corrections (see 10.2).

"AXIS CALIBRATION VALUES" menu displayed.

#### Actions

Choose "DISPLAY - CHANGE"

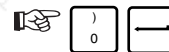

Display of the question:

AXIS ?

Enter the number of the axis to be corrected (corresponds to the axis position in machine parameter P9).



Display of the measurement correction table for the axis considered, e.g.:

```

AXIS CALIBRATION  AXIS: 2
>M-  10000  C-    3
M-   9000  C+    6
M-   8000  C-    9
...
    
```

Interpretation of the measurement correction table:

- the header gives the axis number selected,
- the next number, "M", is the measurement of the point (in internal units),
- the following number, "C", is the correction to be made (in internal units).

The table is in increasing order of measurements.

When the table is empty, only the header is displayed.

#### Modifying or Adding a Correction

The corrections can be entered in any order.

Enter the correction: "M±[measurement] C±[correction]".



Modification of the correction line concerned or display of the new line.

#### Deleting a Correction

Select the correction to be deleted.



Delete the correction.



Return to the "AXIS CALIBRATION VALUES" menu (to enter the corrections for another axis)

Exit from the measurement correction table.



Return to the "AXIS CALIBRATION VALUES" menu.

### 10.3.2 Saving the Measurement Correction Table

#### Initial conditions

Peripheral device (PC + communication tool, diskette drive or tape reader/punch) connected and ready to receive data.  
 "AXIS CALIBRATION VALUES" menu displayed.

#### Actions

Select "UNLOAD".  

Display of the question:

READY (Y/N)?

Initiate the save.  

Display of :

%[CNC job reference]

Keep the job reference	Change the job reference
Possibly add a comment	Enter another job reference (possibly with comment)

Reinitiate the save.  

The correction tables are saved then the following message is displayed:

UPLOADING COMPLETE!

Acknowledge the message.  

#### Structure of the data transmitted

The data saved are in the following format:

```
%00084001 ;0A
AXIS: 0;08
M- 10000 C- 3;17
M- 9000 C- 10;17
...
AXIS: 1;08
M- 10000 C+ 25;17
M- 9000 C- 5;17
...
!!
```

Interpretation of the data transmitted:

- the first line gives the CNC job reference (which may be followed by a comment, e.g.: "%00084001 28 June 1995"),
- each of the axes (AXIS: [No.]= is followed by the corrections assigned to it,
- the number after "M" is the measurement of the point (in internal units),
- the number after "C" is the correction of the point (in internal units),
- the two digits after ";" on each line are the hexadecimal number of characters in the line.



### 10.3.3 Checking the Measurement Correction Table

The measurement correction table can be checked to make sure that it was saved or loaded correctly.

#### Initial Conditions

Peripheral (PC + communication tool, diskette drive or tape reader/punch) connected and ready to transmit the table to be checked.

"AXIS CALIBRATION VALUES" menu displayed.

#### Actions

Choose "VERIFY".



Display of the question:

READY (Y/N)?

Initiate the check.



Initiate transmission by the peripheral.

The measurement correction table is checked followed by display of the message:

OK!

Acknowledge the message.



#### Possible Problems

The job reference is different from the CNC job reference

Loading stops and the incorrect job reference is displayed.

Enter the correct job reference.



The check is then resumed and continues normally.

The data saved do not correspond to the correction table

Display of the message:

ERROR

Acknowledge the message.



Resume save (see 10.3.2) or load (see 10.3.4).

The changes made to the measurement correction table were not confirmed before the check

Display of the message:

WARNING - CHANGES MAY BE LOST  
(EXIT TO SAVE)

Acknowledge the message.



EXIT

Confirm the modifications (see 10.3.5).

Resume the check.

### 10.3.4 Loading a Measurement Correction Table

The measurement correction tables to be loaded can have two possible origins:

- table saved earlier,
- table entered on a peripheral device (complying with the structure shown in 10.3.2; the spaces before the numerical data can be omitted and the two digits after the ";" on each line are the number of characters in the line).

#### Initial Conditions

Peripheral device (PC + communication tool, diskette drive or tape reader/punch) connected and ready to transmit data.

"AXIS CALIBRATION VALUES" menu displayed.

#### Actions

Choose "LOAD".

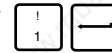

Display of the question:

READY (Y/N) ?

Initiate the load.



Initiate transmission by the peripheral.

Load of the correction table.

#### Possible Problems

The job reference is different from the CNC job reference

Loading stops and the incorrect job reference is displayed.

Enter the correct job reference.



Loading is then resumed and continues normally.

### 10.3.5 Exit from the Utility Confirming the Changes Made

Exit from the utility.



Changes were made

Display of the message:

WRITING IN PROGRESS

After confirmation, display of the message:

WARNING ! LOADING REQUIRES TO STOP  
MACHINE CONTROL OK? (Y/N) :

It is necessary to reset the system to take the changes made into account.

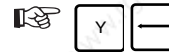

Reset the system.

No changes

Return to the menu "UTILITIES PRESENT".