

WÖHRLE

DEVICE MANUAL

CIMO 9 Operating Panel

C 09



Device Manual

Guide for: CIMO-9" Operating Panel
(CB-09)

Order Code: **TB-C-02/GB/2.0**

Edition: 07. October 1996

© Copyright 1996

Wöhrle Industrieelektronik GmbH
Lerchenstr. 34
71144 Steinenbronn / Germany

Tel.: 0 71 57 / 12 95-0
Fax: 0 71 57 / 12 95-20

All contents of this manual were carefully compiled and revised. However, we accept no liability for any eventual errors that may appear in this book or their consequences. Technical Specifications, measurements and weights are not binding characteristics. Wöhrle GmbH retains the right to make changes based up on the newest technology and stand of the development department.

The designation of other wares in this manual is done without reference to existing patents, samples or trademarks. The absence of specific notices is not a ground for the assumption that a ware or trademark is without restrictions.

Table of Contents

Safety	P. 3
Proper Use	P. 3
Safety Notes	P. 3
Installation Notes	P. 4
Device Overview	P. 5
Front view	P. 5
Side View	P. 6
Interface / Pin Assignments	P. 7
LED-Selection	P. 7
20 mA Serial Key Output Interface (<i>CP526/27 operating panel Only</i>)	P. 7
Parallel Key Output Interface (<i>WF470 operating panel Only</i>)	P. 8
Timing characteristics of the parallel interface	P. 8
Key Encoder/Key Codes	P. 9
CIMO keyboard layout	P. 10
Standard code for CP operating panel	P. 11
Standard code for WF operating panel	P. 12
Monitor Adjustment	P. 13
Dimensions.	P. 16
Dimensions in mm	P. 16
Control panel section in mm	P. 16
Technical Data	P. 17
Accessories/Spare Parts.	P. 19

Safety

Proper Use

CIMO monitor operating panel are high-performance, flexible and control-independent monitoring units designed for direct applications in industrial production and manufacturing equipment.

Among the special features exhibited by the CIMO system is the front panel that consists of an aluminum plate containing all operational elements and the filter screen. The entire front panel is covered with a durable polyester film that is resistant to many of the most commonly used industrial chemicals.

CIMO monitor operating panel are exclusively designed for display, monitoring and input.

For safety reasons, subsequent modifications to the devices by the purchaser are expressly prohibited!

Proper use also includes observance of our established guidelines for operation and shipping.

Safety Notes

All our products have been designed and manufactured in accordance with the most up to date state of the art and, when properly employed, are safe in all operations. There are, however, a number of items that must be observed:

Warning labels

Wöhrlle devices are equipped with labels warning the user against contact with electrically conductive parts and against subjecting control components to static discharges. Please heed these labels.

Wöhrlle assumes no liability for damage or injuries resulting from the improper use of its devices or if the devices are employed in a manner that is not in accordance with that described in the manual.

Accessories

All spare parts and accessories have been specially designed and manufactured for use with Wöhrlle equipment. Spare parts and accessories not supplied by Wöhrlle have not been tested by us and are therefore not approved. Wöhrlle assumes no liability for damages resulting from the use of such parts.

Installation Notes

- Check that the circuit box or panel is designed to handle the expected mechanical load.
- Make sure there is an adequate amount of space between the back of the system and the housing (at least 50 mm).
- Tighten all connections in the system and make sure they are not subjected to strain.
- Make sure you are using the proper power supply.
- Do not install systems in cabinets where the system may be affected by nearby sources of strong electrical or magnetic fields (motors, rectifiers, etc.).
- Check the protection class and method of the cabinet, panel or housing. While the front of the system is equipped with IP 65 protection, the protection at the rear is significantly lower.

Note :

- For measurements in millimeters: 1 inch = 25.4 mm.

Device Overview

Front view



The entire front panel is covered with a durable polyester film that is resistant to many of the most commonly used industrial chemicals.

All keys are raised and have a discernible “breakpoint” when pressed, thus giving them the feel of a mechanical push-button.

Depending on the proposed application, there are 2 different types of device available:

- CIMO 9” operating panel for connection to a Siemens CP526/27
Order number: **CB-09/SK2L-304**
- CIMO 9” operating panel for connection to a Siemens WF470
Order number: **CB-09/SK2L-303**

Side View

CP-operating panel (CB-09/SK2L-304)

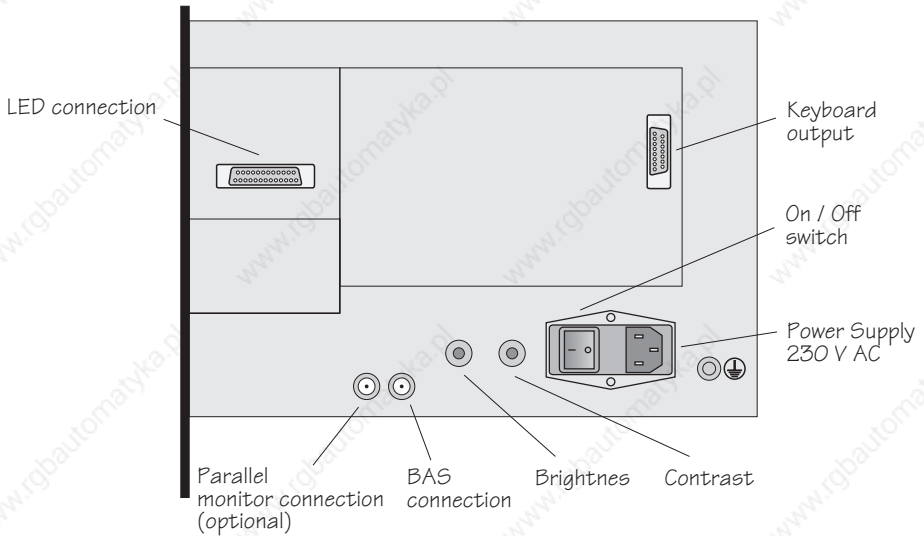

WF-operating panel (CB-09/SK2L-303)

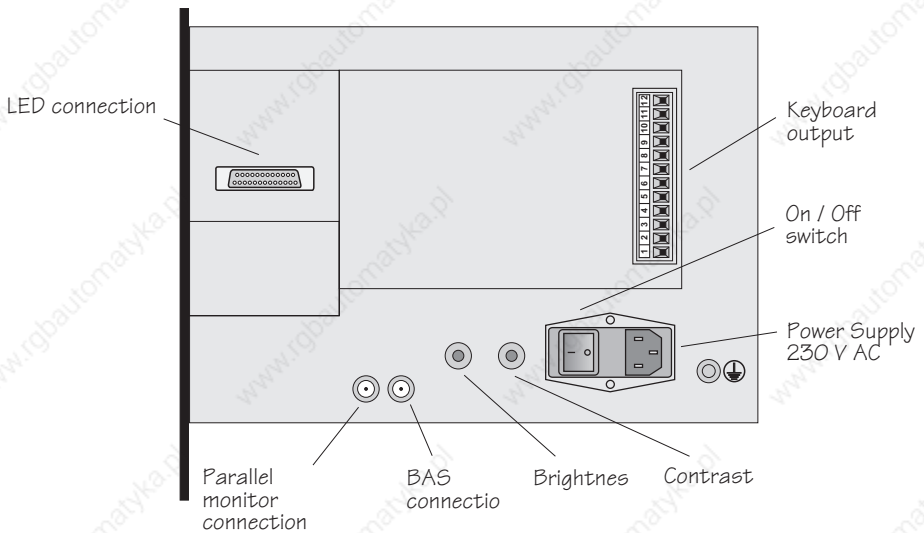

Interface / Pin Assignments

LED-Selection

25pin sub-min-D male

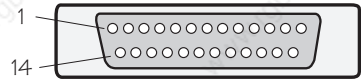

Pin	Assignment
01	LED F9
02	LED F4
03	LED F10
04	LED F5
05	LED F11
06	LED F6
07	LED F12
08	LED F7
09	LED F13
10	LED F8
11	LED F14
12	LED F1
13	LED F15
14	LED F3
15	LED F2
16	LED F16
17-21	n.c.
22-25	GND

The LEDs integrated into the 16 soft keys can be accessed via digital SPS outputs. Connection is by means of an accessory board that is part of the standard delivery and that contains the required drop resistors. The LEDs are supplied with 24 VDC power.

20 mA Serial Key Output Interface (CP526/27 operating panel Only)

15 pin sub-min-D male

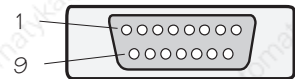

Pin	Assignment
01-03	n.c.
04	+24 V DC
05-08	n.c.
09	TxD -
10	GND
11-12	n.c.
13	TxD +
14-15	n.c.

Parallel Key Output Interface (WF470 operating panel Only)

12pin screw down plug



Pin	Assignment
01	GND
02	+24 V
03	D 0
04	D 1
05	D 2
06	D 3
07	D 4
08	D 5
09	D 6
10	D 7
11	NT
12	TG

Note:

The TG signal (pin 12) must be on D7 for WF470 devices.
NT (pin 11) and D7 (pin 10) are not used on WF470 devices.

Timing characteristics of the parallel interface

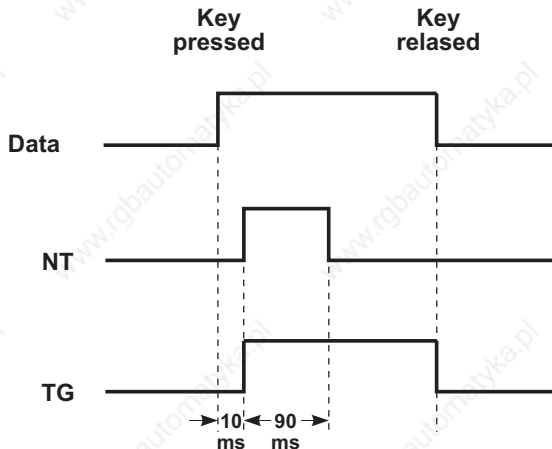

Key Encoder/Key Codes

Jumper description of key encoder TE1

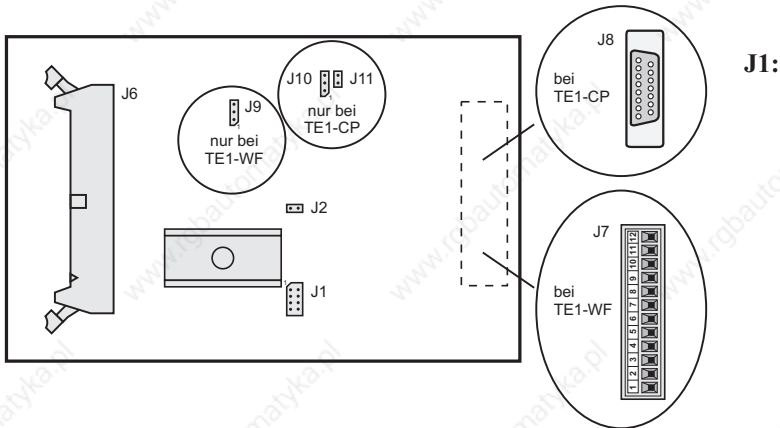

Memory selection (Operating system and key code are on the same memory)

Pin 2-4 and Pin 5-7 bridged	→	27C64, 27C128 and 28C64
Pin 2-4 and Pin 3-5 bridged	→	27C256
Pin 4-6 and Pin 3-5 bridged	→	27C512
Pin 3-4 and Pin 5-7 bridged	→	28C256

J2: Key lock

Pin 1-2 bridged	→	all keys are locked
-----------------	---	---------------------

J9: TG signal (only at WF encoder)

Pin 1-2 bridged	→	low active
Pin 2-3 bridged	→	high active (factory setting)

J10: Interface (only at CP encoder)

Pin 1-2 bridged	→	active
Pin 2-3 bridged	→	passive (factory setting)

J11: Interface (only at CP encoder)

Pin 1-2 bridged	→	active
Pin 1-2 open	→	passive (factory setting)

J6: Matrix keyboard connection (connection of front panel keys)

























J7/J8: Output interface (according to encoder type)

TE1-CP (J8)	→	15pin sub-min-D male
TE1-WF (J7)	→	12pin screw down plug

















CIMO keyboard layout

Codes can be freely programmed via an EPROM or EEPROM, 2 levels per key (unshift/shift) and 1 ASCII character.

























Standard code for CP operating panel**Operating keys**

key	code	key	code	key	code
	37		38		39
	34		35		36
	31		32		33
	2D		30		2E
	95		92		94
	90		97		91
	9C		93		9D
	6C		9E		9E

















Softkeys

key	code	key	code	key	code	key	code
	C0		C1		C2		C3
	C4		C5		C6		C7
	80		81		82		83
	84		85		86		87

Standard code for WF operating panel**Operating keys**

key	code	key	code	key	code
	29		2A		2B
	39		3A		3B
	49		4A		4B
	59		5A		5B
<hr/>					
	2C		3D		2D
	4C		4E		4D
	5C		3C		5D
	6C (acknowl.)		6D		6D

Softkeys

key	code	key	code	key	code	key	code
	01		02		03		04
	05		06		07		08
	11		12		13		14
	15		16		17		18

Monitor Adjustment

Note !

Adjustments may only be carried out by properly trained technicians !

All delivered systems have already been pre-adjusted to the corresponding connection assembly. Correct display is, however, dependent on:

- Cable lengths,
- Ambient condition, etc.

Should adjustments be necessary, proceed as follows:

Caution

- Exercise extreme caution when working inside the unit. Monitors operate with high voltage (approx. 12,000 volts).
- Do not touch any conductors or connections.
- Use only insulated tools.
- Work at a safe location. Always work in pairs, with one technician watching the image while the other carries out the adjustments.
- When opening the unit, make sure no conducting parts fall into it.
- Always disconnect the unit from the power source before re-installing it.

Procedure:

1. Turn off power to the unit.
2. Remove the top cover panel.
3. Connect the video cable.
4. Turn power on.
5. Set the brightness control to one-half maximum.
6. Perform the necessary adjustments.
7. After completing the adjustment work, turn off power to the unit and re-install the top cover panel.

Horizontal frequency (1)

If horizontal adjustment is required, the unit should be returned to the manufacturer. (Any independent adjustments are made at the owner's risk.)

If the vertical lines are distorted, particularly at the upper screen border, or if the screen shows only horizontal lines, a horizontal frequency adjustment is required.

The adjuster is labeled "H.FRQ". The adjustment is correct when the vertical lines are straight.

Vertical frequency (2)

If the image rolls vertically up or down, the vertical frequency needs to be adjusted.

The adjuster is labeled "V.HOLD". (On the PCB the adjuster is incorrectly labeled "H.HOLD".)

During the adjustment, let the image roll down first, then turn the potentiometer until the image gradually moves upward to the required position. If the potentiometer is turned too far, the image will scroll upwards off the screen.

Image amplitude (3)

If the image is too large or too small in the vertical direction, use the "V.HEIGHT" adjuster to correct the problem.

Horizontal phase (4)

You can use this potentiometer to shift the image to the left or to the right.

The adjuster is labeled "H.PHASE".

Contrast setting (5)

If the video signal amplitude at the BAS input is too great, the video amplifier will become overloaded (distortion in areas of light/dark transition).

You can correct this problem with the "CONTR" potentiometer.

External brightness and contrast

These adjusters are accessible from the outside of the unit, and are located on the unit's side panel.

Never turn the brightness and contrast controls to their maximum positions for longer periods of time, in order to extend the life of the picture tube.

Other adjusters

- Vertical linearity, “V.LIN”: (6)
- Vertical position, “V.SHIFT”: (7)
- Focus, “DY.FOCUS”: (8)
- Background brightness “SUB.BRIGHT”: (9)
- Horizontal width, “H.WIDTH”: (10)
- Horizontal linearity, “H.LIN”: (11)

Location diagram:

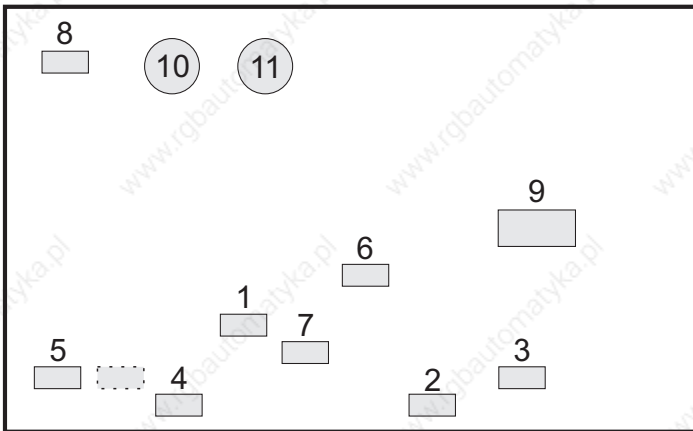

1	Horizontal frequency	7	Vertical position
2	Vertical frequency	8	Focus
3	Image amplitude	9	Background brightness
4	Horizontal phase	10	Horizontal width
5	Contrast	11	Horizontal linearity
6	Vertical linearity		

Dimensions

Dimensions in mm

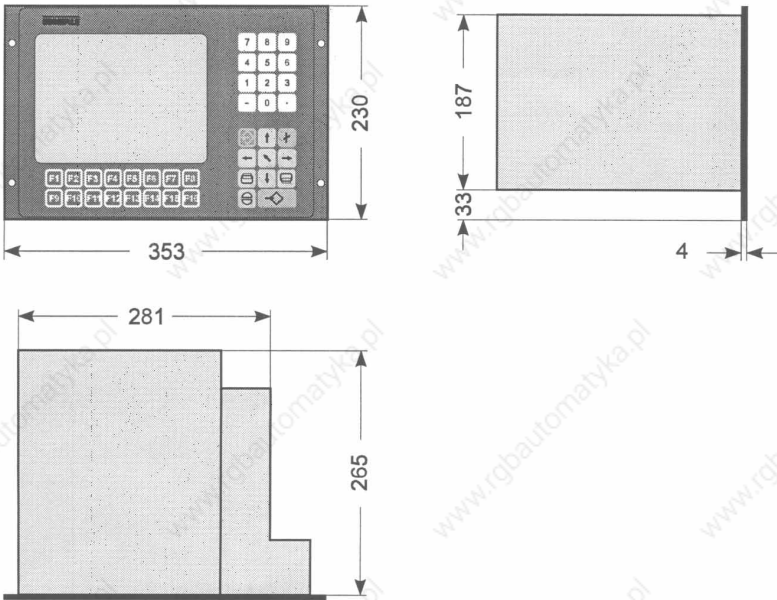

Control panel section in mm

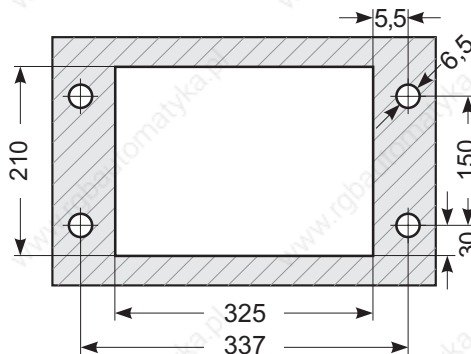

General tolerances (untoleranced dimensions) in accordance with DIN 7168 m.

Technical Data

CIMO CB-09	SK2L-304 for CP	SK2L-303 for WF
Monitor	Monochrome green	
Diagonal screen size	9"	
Resolution	Typ. 1200 x 280	
Monitor control		
Signal input	BAS / analog ; composite / video	
Band width	30 MHz (-3 dB)	
Interface	BNC	
Synchronization		
Horizontal frequency	15.625 KHz \pm 500 Hz	
Image frequency	40 to 61 Hz	
Monitor connection		
Video cable length	50 m, maximum	
Keyboard		
Operator keys	2 x 12; preprinted polyester film	
Softkeys	2 x 8 with LED (F1-F16); preprinted polyester film	
Keyboard encoder	TE1-CP	TE1-WF
Interface	Serial; TTY/20 mA active/passive jumper selectable	Parallel; (data output: D0-D7 control output: NT/TG)
Data output	_____	24 V DC for digital PLC inputs
Output current	_____	Max. 12 mA / per output (short-circuit proof)
Connector	15pin sub-min-D male	12pin screw down plug (single wire, 1.5 mm ² max.)
Programming	Via EPROM or EEPROM, jumper selectable	
Programming level	2 levels per key (unshift/shift)	
Number of character	1 ASCII character per key	
Key lock	Via jumper	

CIMO CB-09	SK2L-304 for CP	SK2L-303 for WF
Device technology		
Power supply (Monitor)	230 V AC in accord. with IEC 38 (115 V available)	
Power supply (Keyboard)	20 V DC to 30 V DC (via PLC)	
Unit safety	T 1 A fuse	
Power consumption	20 Watts	
Protection method when installed	IP 65 in accord. with DIN 40050	
Operating temperature range	0 °C to +50 °C in accord. with DIN 40040, 10 to 95 % relative humidity, non-condensing	
Storage / shipping temperature	-10 °C to +60 °C in accord. with DIN 40040	
Weight	Approx. 5,3 kg	
Front panel	Aluminium with polyester film, black	
Housing	Full metal, sealed	
Dimensions in mm	W 353 x H 230 x D 265	
Connection type (power supply)	Via cold device cable	

The above technical data apply to the standard configuration. Your system may be equipped with additional options.

We reserve the right to make technical changes at any time and without prior notification.

Accessories/Spare Parts

You can order accessories and spare parts by Wöhrle.

Article	Order no.:
---------	------------

Connecting cable for CP controls

Coaxial cable with 2 BNC connectors, from CIMO to controller, 5 m *	DK-BNC/005
Single-lead video cable from CIMO to CP 526/27/28, 5 m *	DK-CP526/005
Connecting cable between CIMO keyboard interface and CP keyboard interface, 5 m *	DK-TE1-CP526/005

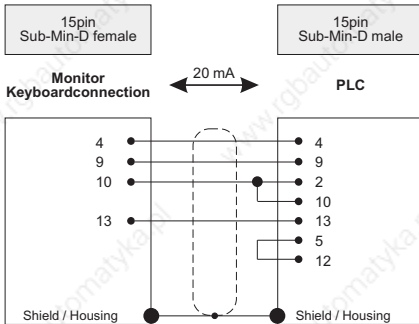

Connecting cable for WF controls

Coaxial cable with 2 BNC connectors, from CIMO to controller, 5 m *	DK-BNC/005
Single-lead video cable, from CIMO to WF 470, 5 m *	DK-WF470/005
Adapter cable from WF connecting cable to controller, 0.15 m	DK-WF470/ADA015

* Other lengths are indicated by the 3-digit code 005 = 3-digit code

