



11/91 AWA 27-772

SUCOS PS 316

Allgemeine Hinweise

Transport, Lagerung, Austausch

Zur Verhinderung elektrostatischer Entladungen empfehlen wir, die Baugruppen nur am Griff und/oder an der Frontplatte anzufassen.



**Die Baugruppen nur bei spannungsloser PS ziehen oder stecken.
Baugruppencodierung beachten!**

General notes

Transport, storage, exchange

In order to prevent cards being damaged, we recommend that you hold the cards only by the handle and/or the front plate.



**Switch off PS316 before inserting or removing the cards.
Note the coding of the cards!**

Remarques générales

Transport, stockage, remplacement

Afin d'éviter les décharges électrostatiques, il est recommandé de ne saisir les modules que par la poignée et/ou le plastron.



**Avant d'embrocher ou de débrocher un module, mettre toujours l'automate
hors tension.
Attention au codage des modules!**

Istruzioni generali

Trasporto, montaggio, sostituzione

Per evitare che le schede vengano danneggiate si raccomanda di prenderle solo per l'impugnatura e/o sulla piastra frontale.



**Togliere tensione al PS 316 prima di inserire o rimuovere i moduli.
Fare attenzione alla codifica della scheda!**

Indicaciones generales

Transporte, almacenamiento, sustitución

Para evitar daños en la tarjeta, recomendamos sujetarla solo desde la maneta y/o de la placa frontal.



**Las tarjetas deben insertarse o extraerse sólo con el PS desconectado.
¡Atención a la codificación de las tarjetas!**

Baugrupenträgeranordnung

Rack arrangement

Disposition des racks

Disposizione dei rack

Disposición de los racks

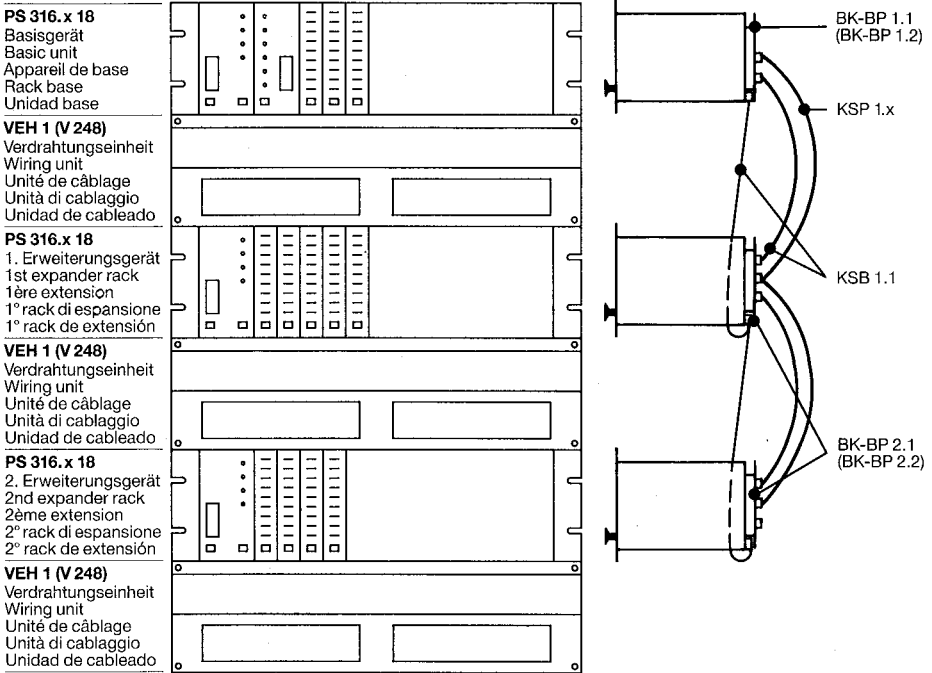

Achtung:

Typen BK-BPx.1 und BK-BPx.2 nicht gemischt in einem Aufbau verwenden.

Attention:

Types BK-BPx.1 and BK-BPx.2 cannot be mixed.

Attention:

Les types BK-BPx.1 et BK-BPx.2 ne doivent pas être combinés.

Attenzione:

I tipi BK-BPx.1 e BK-BPx.2 non possono essere utilizzati assieme.

Atención:

Los tipos BK-BPx.1 y BK-BPx.2 no deben mezclarse.

Montage der Basisgeräte PS 316. x 08 und PS 316. x 12

Kabelklammern aufkleben, Klebestellen vorher mit fettlösendem Reinigungsmittel säubern.

Fitting the PS 316. x 08 and PS 316. x 12 basic units

Stick the cable clamp in place after cleaning area with a degreasing agent.

Montage des appareils de base PS 316. x 08 et PS 316. x 12

Coller les attaches de câbles après avoir nettoyé les emplacements avec un solvant de graisses.

Montaggio dei rack base PS 316. x 08 e PS 316. x 12

Incollare il guida cavo dopo aver pulito la superficie con un solvente per grassi.

Montaje de las unidades base PS 316. x 08 y PS 316. x 12

Pegar los sujetacables después de limpiar el área con un desengrasante.

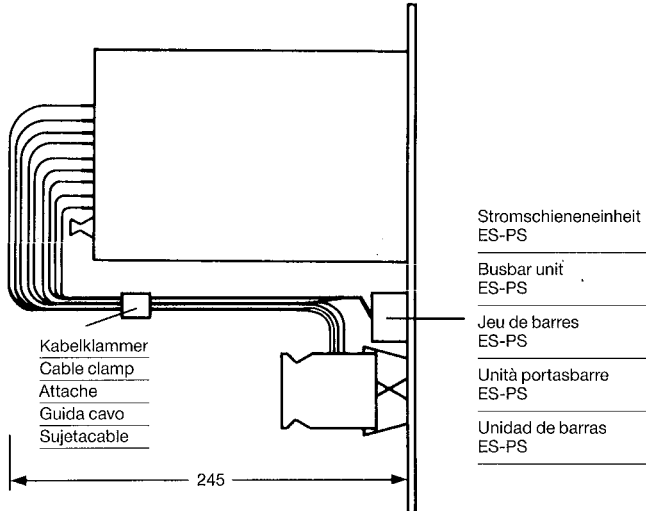

Verdrahtung

110-V-/220-V- AC-Leitungen sind getrennt von 24-V-DC-Leitungen zu verlegen.

Wiring

110V/220V a.c. cables are to be laid separately from 24V d.c. cables.

Câblage

Les lignes 110V/220V CA doivent être posées séparément des lignes 24V CC.

Cablaggio

Le linee a 110V/220V AC devono essere separate dalle linee a 24V DC

Conexión

Los cables de 110V/220V AC deben quedar separados de los cables de 24V DC.

Steckplatzbelegung des Basisgerätes

Module location of the basic unit

Affectation des postes d'enchâfrage de l'appareil de base

Inserimento dei moduli sul rack base

Ubicación de las tarjetas en la unidad base

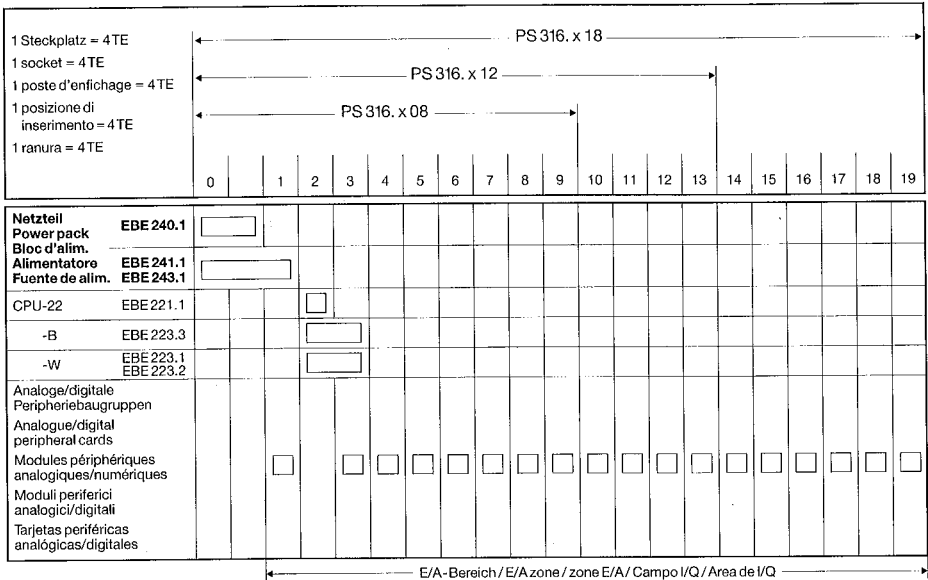

Systemausbau

Maximal 1 Basisgerät + 4 Erweiterungsgeräte mit BK-BP x. 1
maximal 1 Basisgerät + 7 Erweiterungsgeräte mit BK-BP x.2
Bei mehr als 2 Erweiterungsgeräten muß ein Netzfilter FIL-PS vor die Netzteile EBE 241.1 geschaltet werden.

ACHTUNG:
Bei Aufbauten mit mehr als 4 Erweiterungsgeräten müssen für alle Geräte die Buskoppeleinheiten BK-BP x.2 verwendet werden.

System Expansion

Max. 1 basic unit + 4 expander racks with BK-BP x.1
Max. 1 basic unit + 7 expander racks with BK-BP x.2
An FIL-PS mains filter must be connected in front of the EBE 241.1 power supply units if more than 2 expander racks are used.

CAUTION:
The BK-BP x.2 bus coupling units must be used for all systems involving more than 4 expander racks.

Extension du système

Max. 1 appareil de base + 4 appareils d'extension avec BK-BP x.1
Max. 1 appareil de base + 7 appareils d'extension avec BK-BP x.2
S'il y a plus de 2 appareils d'extension, un filtre d'alimentation doit être connecté en série avec les blocs d'alimentation EBE 241.1

ATTENTION:
Pour les systèmes avec plus de 4 appareils d'extension, les unités de couplage pour bus BK-BP x.2 doivent être utilisés pour tous les appareils.

Espansione del sistema

Max. 1 rack base + 4 rack espansione con BK-BP x.1
Max. 1 rack base + 7 rack espansione con BK-BP x.2
Se vengono utilizzati più di 2 rack di espansione deve essere montato un filtro di alimentazione sul lato frontale dell'alimentatore EBE 241.1.

ATTENZIONE:
Per i sistemi con più di 4 rack di espansione devono essere utilizzate le unità di accoppiamento bus BK-BP x.2.

Configuración del sistema

1 unidad base + 4 racks de extensión con BK-BP x.1 como máximo
1 unidad base + 7 racks de extensión con BK-BP x.2 como máximo
En sistemas con más de 2 racks de extensión debe utilizarse un filtro FIL-PS para las fuentes de alimentación EBE 241.1

ATENCION:
En sistemas con más de 4 racks de extensión deben utilizarse en todos los racks las tarjetas de acoplamiento de bus BK-BP x.2.

Buskopplung zu Erweiterungsgeräten

Bus coupling for expander racks

Couplage des bus pour appareils d'extension

Collegamento bus per rack di espansione

Acoplamiento de bus a racks de extensión

Montage

Installation

Montage

Montaggio

Montaje

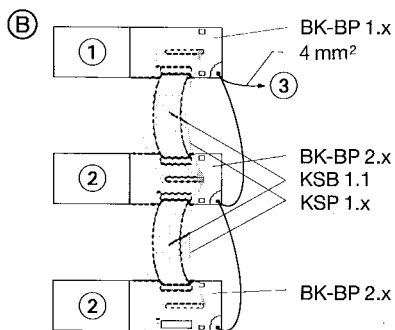
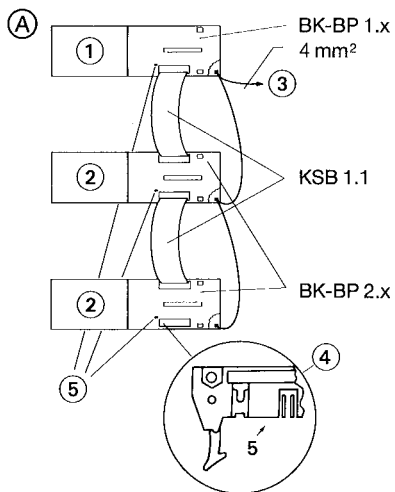
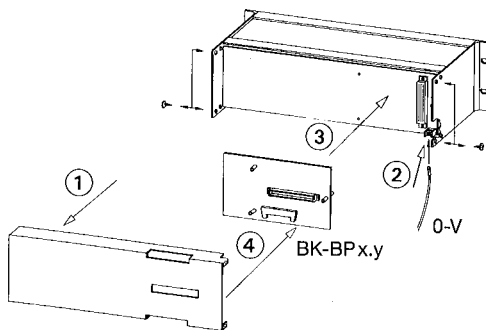

Kodierung / Kabelanschluß

- Ⓐ Bit-I/O-Buskopplung
 - Ⓑ Parallelbuskopplung
- ① Basisgerät (Rückseite)
 - ② Erweiterungsgerät (Rückseite)
 - ③ Bei Betrieb mit potentialgebundenen Baugruppen (z. B. EBE 200, EBE 250): 0-V-Brücke zur Spannungsversorgung der potentialgebundenen Baugruppe.
 - ④ Jumper auf Stiftpaar Nr. 5 (von links)
 - ⑤ Kodierbrücke: immer offen
-

Coding / Cable connection

- Ⓐ Bit-I/O-Bus coupling
 - Ⓑ Parallel bus coupling
- ① Basic unit (rear)
 - ② Expander unit (rear)
 - ③ For potential-dependent modules, e. g. EBE 200 and EBE 250, connect the 0V-bridge to the power supply of the potential-dependent module concerned.
 - ④ Jumper on pin pair No. 5 (from left)
 - ⑤ Coding: always open
-

Codage / Raccordement des câbles

- Ⓐ Couplage de bus bit E/S
 - Ⓑ Couplage de bus parallèle
- ① Appareil de base (face arrière)
 - ② Appareil d'extension (face arrière)
 - ③ Pour opération sous potentiel (EBE 200, EBE 250): Pont 0V pour bloc d'alimentation des modules sous potentiel.
 - ④ Shunt sur paire de broches no. 5 (vu de gauche)
 - ⑤ Codage: toujours ouvert
-

Codifica / collegamento cavi

- Ⓐ Collegamento del bus a bit I/O
 - Ⓑ Collegamento del bus parallelo
- ① Rack di base (retro)
 - ② Rack di espansione (retro)
 - ③ Per il funzionamento con moduli non separati galvanicamente (p. es. EBE 200, EBE 250) ponte 0V per l'alimentazione dei moduli non separati galvanicamente.
 - ④ Jumper su coppia di spine N° 5 (da sinistra)
 - ⑤ Ponte di codifica: sempre aperto.
-

Codificación / Conexión de cables

- Ⓐ Acoplamiento del bus de I/Q de bit
 - Ⓑ Acoplamiento del bus paralelo
- ① Unidad base (parte posterior)
 - ② Rack de extensión (parte posterior)
 - ③ Al usar tarjetas con potencial (p. e. EBE 200, EBE 250): puente 0V a la alimentación de la tarjeta con potencial.
 - ④ Puente en pins N° 5 (desde la izquierda)
 - ⑤ Codificación: siempre abierto
-

Stromversorgungen

Eine Kombination der Typen EBE241.1 und EBE243.1 in einem Aufbau ist unzulässig. EBE 240.1 nur für Einzelgeräte verwenden.

Kodierung der EBE 241.1 / EBE 243.1

- ① Überwachungsfunktionen (BUS aktiv und LOOP)

Power supplies

A combination of types EBE 241.1 and EBE 243.1 is not permissible. Use type EBE 240.1 only for basic units without expander racks.

Coding of EBE 241.1 / EBE 243.1

- ① Monitoring functions (BUS ACTIVE with LOOP)

Alimentations

L'utilisation simultanée des EBE 241.1 et EBE 243.1 est interdite. Utiliser EBE 240.1 seulement pour appareils de base sans appareils d'extension.

Codage de l'EBE 241.1 / EBE 243.1

- ① Fonctions de surveillance (BUS ACTIVE et LOOP)

Alimentazione

Non è possibile la combinazione dei moduli EBE 241.1 e EBE 243.1 nella stessa configurazione. Utilizzare il tipo EBE 240.1 solo per rack base senza rack espansione.

Codifica dell'EBE 241.1 / EBE 243.1

- ① Funzioni di controllo (BUS ATTIVO e LOOP)

Fuentes de alimentación

Una combinación de las tarjetas EBE 241.1 y EBE 243.1 en el mismo sistema no está permitido. La tarjeta EBE 240.1 debe utilizarse solo en unidades base (sin racks de extensión).

Codificación de la EBE 241.1 / EBE 243.1

- ① Función de supervisión (BUS ACTIVO y LOOP)

EBE 241.1/
EBE 243.1

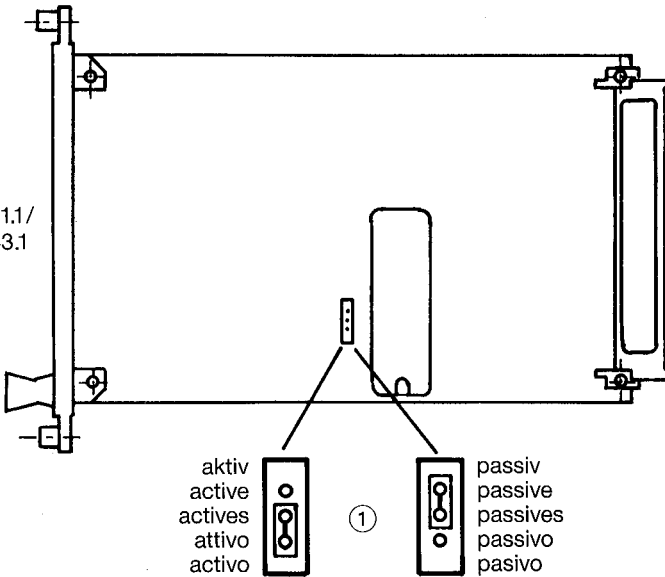

Achtung!

Bei Parallelbusbetrieb ist nur die Kodierung „aktiv“ erlaubt!

Caution!

Only “active” coding permissible with parallel bus operation.

Attention!

En cas de fonctionnement avec bus parallèle, seul le codage «actives» est admis.

Attenzione!

In caso di funzionamento con bus parallelo è ammessa soltanto una codifica “attiva”.

¡Atención!

En caso de funcionamiento con el bus paralelo, sólo se permite la codificación “activo”.

Maßtabellen / Dimensions / Encombres / Dimensioni / Dimensiones

PS 316. x 18

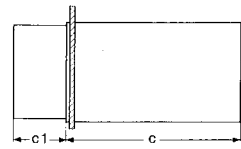
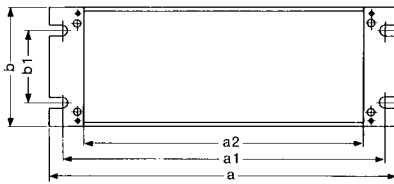

PS 316. x 18

PS 316. x 08
PS 316. x 12

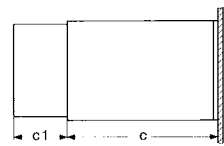
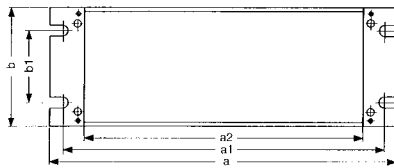

PS 316. x 08/ . x 12

VEH 1

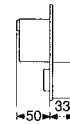
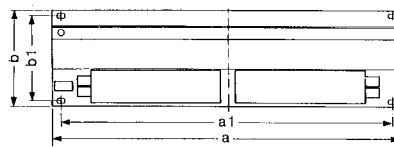

V248

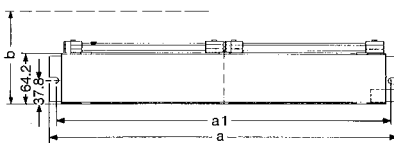

ES-PS

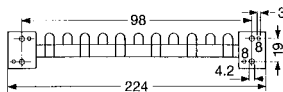

Typ/Type/Référence

Tipo/Tipo	a	a1	a2	b	b1	c	c1
PS 316. x 08	288	275	255	132,5	100	205	—
dito +SAM						—	50
dito +SEM						—	68
dito +S2...						—	70
PS 316. x 12	362	350	336	132,5	100	205	—
dito +SAM						—	50
dito +SEM						—	68
dito +S2...						—	70
PS 316. x 18	483	465	427	132,5	57	230	—
dito +SAM						—	50
dito +SEM						—	68
dito +S2...						—	70
VEH 1	483	465	—	132,5	120,5	—	—
V248	483	465	—	88	—	—	—
MBP 3	483	465	—	132,5	120,5	—	—
MBP 1	483	465	—	43,6	31,7	—	—

Codierung	Alle Baugruppen dürfen nur bei ausgeschalteter Versorgungsspannung ausgetauscht werden.	Schalter	0 = off/open	1 = on
Coding	Cards must be exchanged only while the supply voltage is disconnected.	Switches		
Codage	Les modules doivent tous être remplacés hors tension.	Codeurs		
Codifica	Togliere tensione prima di inserire o rimuovere i moduli.	Interruttori		
Codificación	Las tarjetas deben insertarse o extraerse sólo con la alimentación desconectada.	Codificador		

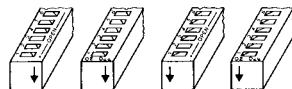

Baugruppentyp / Module Type / Type de module /
Tipi di moduli / Tipo de tarjeta

Schalternummer / Switch Number / No. de microrrupteur /
N° interruttore / N° de codificador

A		B		C		S8		D								
EBE 261		EBE 200 EBE 201 EBE 205 EBE 206.1 EBE 206.2 EBE 213.1 EBE 250 A EBE 252 EBE 258 EBE 266.1		EBE 202.1 EBE 211 (F) EBE 254.1 EBE 255 EBE 256 EBE 260 EBE 265 EBE 267.1		on/off on/off on/off - - off off on/off		EBE 253								
								1	2	3	4	5	6	7	8	
0.0...1.15	0.0...0.15	0.0...0.7	0.0...0.3 0.4...0.7 0.8...0.15	0.0...0.7 0.8...0.11 0.12...0.15	0.0...0.3 0.4...0.7 0.8...0.11 0.12...0.15	on/off on/off on/off	1 0 0	1 1 0	1 1 1	1 1 1	1 1 1	1 1 1	1 1 1	1 1 1	1 1 1	
2.0...3.15	2.0...2.15	2.0...2.7	2.0...2.3 2.4...2.7	2.0...2.7 2.8...2.11 2.12...2.15	2.0...2.3 2.4...2.7 2.8...2.11 2.12...2.15	on/off on/off	1 0	1 1	1 0	1 0	1 1	1 1	1 1	1 1	1 1	1 1
4.0...5.15	4.0...4.15	4.0...4.7	4.0...4.3 4.4...4.7	4.0...4.7 4.8...4.11 4.12...4.15	4.0...4.3 4.4...4.7 4.8...4.11 4.12...4.15	on/off on/off	1 0	1 1	1 0	1 1	1 0	1 1	1 1	1 1	1 1	1 1
6.0...7.15	6.0...6.15	6.0...6.7	6.0...6.3 6.4...6.7	6.0...6.7 6.8...6.11 6.12...6.15	6.0...6.3 6.4...6.7 6.8...6.11 6.12...6.15	on/off on/off	1 0	1 1	1 0	1 0	1 0	1 1	1 1	1 1	1 1	1 1
8.0...9.15	8.0...8.15	8.0...8.7	8.0...8.3 8.4...8.7	8.0...8.7 8.8...8.11 8.12...8.15	8.0...8.3 8.4...8.7 8.8...8.11 8.12...8.15	on/off on/off	1 0	1 1	1 1	1 1	1 1	1 1	1 1	1 1	1 1	1 1
	9.0...9.15	9.0...9.7	9.0...9.3 9.4...9.7	9.0...9.7 9.8...9.11 9.12...9.15	9.0...9.3 9.4...9.7 9.8...9.11 9.12...9.15	on/off on/off	1 0	1 0	1 0	1 0	1 0	1 1	1 1	1 1	1 1	1 1

Codierung	Alle Baugruppen dürfen nur bei ausgeschalteter Versorgungsspannung ausgewechselt werden.	Schalter	0 = off/open	1 = on
Coding	Cards must be exchanged only while the supply voltage is disconnected.	Switches		
Codage	Les modules doivent tous être remplacés hors tension.	Codeurs		
Codifica	Togliere tensione prima di inserire o rimuovere i moduli.	Interruttori		
Codificación	Las tarjetas deben insertarse o extraerse sólo con la alimentación desconectada.	Codificador		

Baugruppentyp / Module Type / Type de module /
Tipi di moduli / Tipo de tarjeta

Schalternummer / Switch Number / No. de microrupteur /
N° interruptore / N° de codificador

A	B	C	D										
			1		2		3		4				
			1	2	3	4	5	6	7	8			
			1	2	3	4	5	6	7	8			
10.0...11.15	10.0...10.15	10.0...10.7	10.0...10.3	1	1	0	1	0	1	1	1		
			10.4...10.7	0	1	1	0	1	0	1	1		
		10.8...10.15	10.8...10.11	1	0	1	0	1	0	1	1		
		10.12...10.15	10.12...10.15	0	0	1	0	1	0	1	1		
	11.0...11.15	11.0...11.7	11.0...11.7	11.0...11.3	1	1	0	1	0	1	1		
				11.4...11.7	0	1	0	1	0	1	1		
			11.8...11.15	11.8...11.11	1	0	0	1	0	1	1		
			11.12...11.15	11.12...11.15	0	0	0	1	0	1	1		
		12.0...12.15	12.0...12.15	12.0...12.7	12.0...12.3	1	1	1	1	0	0	1	1
					12.4...12.7	0	1	1	1	0	0	1	1
				12.8...12.15	12.8...12.11	1	0	1	1	0	0	1	1
				12.12...12.15	12.12...12.15	0	0	1	1	0	0	1	1
13.0...13.15	13.0...13.7		13.0...13.3	1	1	0	1	0	0	1	1		
			13.4...13.7	0	1	0	1	0	0	1	1		
	13.8...13.15		13.8...13.11	1	0	0	1	0	0	1	1		
	13.12...13.15		13.12...13.15	0	0	0	1	0	0	1	1		
14.0...15.15	14.0...14.15	14.0...14.7	14.0...14.3	1	1	1	0	0	0	1	1		
			14.4...14.7	0	1	1	0	0	0	1	1		
		14.8...14.15	14.8...14.11	1	0	1	0	0	0	1	1		
		14.12...14.15	14.12...14.15	0	0	1	0	0	0	1	1		
	15.0...15.15	15.0...15.7	15.0...15.3	1	1	0	0	0	0	1	1		
			15.4...15.7	0	1	0	0	0	0	1	1		
		15.8...15.15	15.8...15.11	1	0	0	0	0	0	1	1		
		15.12...15.15	15.12...15.15	0	0	0	0	0	0	1	1		
	16.0...17.15	16.0...16.15	16.0...16.7	16.0...16.3	1	1	1	1	1	1	0	1	
				16.4...16.7	0	1	1	1	1	1	0	1	
			16.8...16.15	16.8...16.11	1	0	1	1	1	1	0	1	
			16.12...16.15	16.12...16.15	0	0	1	1	1	1	0	1	
17.0...17.15		17.0...17.7	17.0...17.3	1	1	0	1	1	1	0	1		
			17.4...17.7	0	1	0	1	1	1	0	1		
		17.8...17.15	17.8...17.11	1	0	0	1	1	1	0	1		
		17.12...17.15	17.12...17.15	0	0	0	1	1	1	0	1		
18.0...19.15		18.0...18.15	18.0...18.7	18.0...18.3	1	1	1	0	1	1	0	1	
				18.4...18.7	0	1	1	0	1	1	0	1	
			18.8...18.15	18.8...18.11	1	0	1	0	1	1	0	1	
			18.12...18.15	18.12...18.15	0	0	1	0	1	1	0	1	
	19.0...19.15	19.0...19.7	19.0...19.3	1	1	0	0	1	1	0	1		
			19.4...19.7	0	1	0	0	1	1	0	1		
		19.8...19.15	19.8...19.11	1	0	0	0	1	1	0	1		
		19.12...19.15	19.12...19.15	0	0	0	0	1	1	0	1		
	20.0...21.15	20.0...20.15	20.0...20.7	20.0...20.3	1	1	1	1	0	1	0	1	
				20.4...20.7	0	1	1	1	0	1	0	1	
			20.8...20.15	20.8...20.11	1	0	1	1	0	1	0	1	
			20.12...20.15	20.12...20.15	0	0	1	1	0	1	0	1	
21.0...21.15		21.0...21.7	21.0...21.3	1	1	0	1	0	1	0	1		
			21.4...21.7	0	1	0	1	0	1	0	1		
		21.8...21.15	21.8...21.11	1	0	0	1	0	1	0	1		
		21.12...21.15	21.12...21.15	0	0	0	1	0	1	0	1		
22.0...23.15		22.0...22.15	22.0...22.7	22.0...22.3	1	1	1	0	0	1	0	1	
				22.4...22.7	0	1	1	0	0	1	0	1	
			22.8...22.15	22.8...22.11	1	0	1	0	0	1	0	1	
			22.12...22.15	22.12...22.15	0	0	1	0	0	1	0	1	
	23.0...23.15	23.0...23.7	23.0...23.3	1	1	0	0	0	1	0	1		
			23.4...23.7	0	1	0	0	0	1	0	1		
		23.8...23.15	23.8...23.11	1	0	0	0	0	1	0	1		
		23.12...23.15	23.12...23.15	0	0	0	0	0	1	0	1		

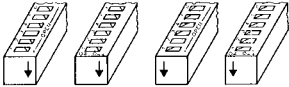
Codierung	Alle Baugruppen dürfen nur bei ausgeschalteter Versorgungsspannung ausgetauscht werden.	Schalter	0 = off/open	1 = on	
Coding	Cards must be exchanged only while the supply voltage is disconnected.	Switches			
Codage	Les modules doivent tous être remplacés hors tension.	Codeurs			
Codifica	Togliere tensione prima di inserire o rimuovere i moduli.	Interruttori			
Codificación	Las tarjetas deben insertarse o extraerse sólo con la alimentación desconectada.	Codificador			

Baugruppentyp / Module Type / Type de module /
Tipi di moduli / Tipo de tarjeta

Schalternummer / Switch Number / No. de microrrupteur /
N° interruttore / N° de codificador

A	B	C	D										
			1		2		3		4				
			1	2	3	4	5	6	7	8			
			1	2	3	4	5	6	7	8			
24.0...25.15	24.0...24.15	24.0...24.7	24.0...24.3	1	1	1	1	1	0	0	0	1	
			24.4...24.7	0	1	1	1	1	0	0	0	1	
			24.8...24.11	1	0	1	1	1	0	0	0	1	
	25.0...25.15	25.0...25.7	25.0...25.3	24.12...24.15	0	0	1	1	1	0	0	0	1
				25.4...25.7	0	1	0	1	1	0	0	0	1
				25.8...25.11	1	0	0	1	1	0	0	0	1
26.0...27.15	26.0...26.15	26.0...26.7	25.12...25.15	0	0	0	1	1	0	0	0	1	
			26.0...26.3	1	1	1	0	1	0	0	0	1	
			26.4...26.7	0	1	1	0	1	0	0	0	1	
	27.0...27.15	26.8...26.15	26.8...26.11	26.12...26.15	1	0	1	0	1	0	0	0	1
				27.0...27.7	1	1	0	0	1	0	0	0	1
				27.4...27.7	0	1	0	0	1	0	0	0	1
28.0...29.15	28.0...28.15	27.8...27.15	27.8...27.11	1	0	0	0	1	0	0	0	1	
			27.12...27.15	0	0	0	0	1	0	0	0	1	
			28.0...28.3	1	1	1	1	0	0	0	0	1	
	29.0...29.15	28.8...28.15	28.8...28.11	28.4...28.7	0	1	1	1	0	0	0	0	1
				28.12...28.15	1	0	1	1	0	0	0	0	1
				29.0...29.3	1	1	0	1	0	0	0	0	1
30.0...31.15	30.0...30.15	29.4...29.7	29.4...29.7	0	1	0	1	0	0	0	0	1	
			29.8...29.11	1	0	0	1	0	0	0	0	1	
			29.12...29.15	0	0	0	1	0	0	0	0	1	
	31.0...31.15	30.8...30.15	30.0...30.7	30.0...30.3	1	1	1	0	0	0	0	0	1
				30.4...30.7	0	1	1	0	0	0	0	0	1
				30.8...30.11	1	0	1	0	0	0	0	0	1
32.0...33.15	32.0...32.15	31.0...31.3	30.12...30.15	0	0	1	0	0	0	0	0	1	
			31.0...31.3	1	1	0	0	0	0	0	0	1	
			31.4...31.7	0	1	0	0	0	0	0	0	1	
	33.0...33.15	32.8...32.15	32.0...32.7	31.8...31.11	1	0	0	0	0	0	0	0	1
				31.12...31.15	0	0	0	0	0	0	0	0	1
				32.0...32.3	1	1	1	1	1	1	1	0	
34.0...35.15	33.0...33.15	32.8...32.15	32.4...32.7	0	1	1	1	1	1	1	1	0	
			32.8...32.11	1	0	1	1	1	1	1	0		
			32.12...32.15	0	0	1	1	1	1	1	0		
	35.0...35.15	33.8...33.15	33.0...33.7	33.0...33.3	1	1	0	1	1	1	1	0	
				33.4...33.7	0	1	0	1	1	1	1	0	
				33.8...33.11	1	0	0	1	1	1	1	0	
36.0...37.15	34.0...34.15	33.12...33.15	33.12...33.15	0	0	0	1	1	1	1	0		
			34.0...34.7	1	1	1	0	1	1	1	0		
			34.4...34.7	0	1	1	0	1	1	1	0		
	35.8...35.15	34.8...34.15	34.8...34.11	34.12...34.15	1	0	1	0	1	1	1	0	
				35.0...35.7	0	0	1	0	1	1	1	0	
				35.4...35.7	0	1	0	0	1	1	1	0	
36.8...36.15	35.0...35.15	35.8...35.11	35.8...35.11	1	0	0	0	1	1	1	0		
			35.12...35.15	0	0	0	0	1	1	1	0		
			36.0...36.3	1	1	1	0	1	1	1	0		
	37.0...37.15	36.4...36.7	36.4...36.7	36.4...36.7	0	1	1	0	1	0	1	0	
				36.8...36.11	1	0	1	1	0	1	1	0	
				36.12...36.15	0	0	1	0	1	1	1	0	
37.8...37.15	37.0...37.15	37.0...37.7	37.0...37.3	1	1	0	1	0	1	1	0		
			37.4...37.7	0	1	0	1	0	1	1	0		
			37.8...37.11	1	0	0	1	0	1	1	0		
	37.12...37.15	37.8...37.15	37.8...37.15	37.8...37.15	0	0	0	1	0	1	1	0	
					0	0	0	1	0	1	1	0	
					0	0	0	1	0	1	1	0	

Codierung Alle Baugruppen dürfen nur bei ausgeschalteter Versorgungsspannung ausgetauscht werden.

Coding Cards must be exchanged only while the supply voltage is disconnected.

Codage Les modules doivent tous être remplacés hors tension.

Codifica Togliere tensione prima di inserire o rimuovere i moduli.

Codificación Las tarjetas deben insertarse o extraerse sólo con la alimentación desconectada.

Schalter 0 = off/open 1 = on

Switches

Codeurs

Interruttori

Codificador

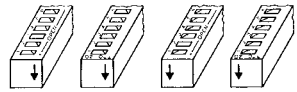

**Baugruppentyp / Module Type / Type de module /
Tipi di moduli / Tipo de tarjeta**

**Schalternummer / Switch Number / No. de microrrupteur /
N° interruttore / N° de codificador**

A	B	C	D								
				1				2			
				1	2	3	4	5	6	7	8
				1	2	3	4	5	6	7	8
38.0...39.15	38.0...38.15	38.0...38.7	38.0...38.3	1	1	1	0	0	1	1	0
			38.4...38.7	0	1	1	0	0	1	1	0
			38.8...38.15	1	0	1	0	0	1	1	0
	39.0...39.15	39.0...39.7	38.12...38.15	0	0	1	0	0	1	1	0
			39.0...39.3	1	1	0	0	0	1	1	0
			39.4...39.7	0	1	0	0	0	1	1	0
40.0...41.15	40.0...40.15	40.0...40.7	39.8...39.15	1	0	0	0	0	1	1	0
			39.12...39.15	0	0	0	0	0	1	1	0
			40.0...40.3	1	1	1	1	1	0	1	0
	41.0...41.15	41.0...41.7	40.4...40.7	0	1	1	1	1	0	1	0
			40.8...40.15	1	0	1	1	1	0	1	0
			40.12...40.15	0	0	1	1	1	0	1	0
42.0...43.15	42.0...42.15	42.0...42.7	41.0...41.7	1	1	0	1	1	0	1	0
			41.4...41.7	0	1	0	1	1	0	1	0
			41.8...41.15	1	0	0	1	1	0	1	0
	43.0...43.15	43.0...43.7	41.12...41.15	0	0	0	1	1	0	1	0
			42.0...42.3	1	1	1	0	1	0	1	0
			42.4...42.7	0	1	1	0	1	0	1	0
44.0...45.15	44.0...44.15	44.0...44.7	42.8...42.15	1	0	1	0	1	0	1	0
			42.12...42.15	0	0	1	0	1	0	1	0
			43.0...43.3	1	1	0	0	1	0	1	0
	45.0...45.15	45.0...45.7	43.4...43.7	0	1	0	0	1	0	1	0
			43.8...43.15	1	0	0	0	1	0	1	0
			43.12...43.15	0	0	0	1	0	1	0	1
46.0...47.15	46.0...46.15	46.0...46.7	44.4...44.7	1	1	1	1	0	0	1	0
			44.8...44.15	0	1	1	1	0	0	1	0
			44.12...44.15	1	0	1	1	0	0	1	0
	47.0...47.15	47.0...47.7	45.0...45.3	0	0	1	1	0	0	1	0
			45.4...45.7	0	1	0	1	0	0	1	0
			45.8...45.15	1	0	0	1	0	0	1	0
48.0...49.15	48.0...48.15	48.0...48.7	45.12...45.15	0	0	0	1	0	0	1	0
			46.0...46.3	1	1	1	0	0	0	1	0
			46.4...46.7	0	1	1	0	0	0	1	0
	49.0...49.15	49.0...49.7	46.8...46.15	1	0	1	0	0	0	1	0
			46.12...46.15	0	0	1	0	0	0	1	0
			47.0...47.3	1	1	0	0	0	0	1	0
50.0...51.15	50.0...50.15	50.0...50.7	47.4...47.7	0	1	0	0	0	0	1	0
			47.8...47.15	1	0	0	0	0	0	1	0
			47.12...47.15	0	0	0	0	0	0	1	0
	51.0...51.15	51.0...51.7	48.0...48.7	1	1	1	1	1	1	0	0
			48.4...48.7	0	1	1	1	1	1	0	0
			48.8...48.15	1	0	1	1	1	1	0	0
51.8...51.15	49.8...49.15	49.0...49.7	48.12...48.15	0	0	1	1	1	1	0	0
			49.0...49.3	1	1	0	1	1	1	0	0
			49.4...49.7	0	1	0	1	1	1	0	0
	51.8...51.15	49.8...49.15	49.8...49.11	1	0	0	1	1	1	0	0
			49.12...49.15	0	0	0	1	1	1	0	0
			50.0...50.3	1	1	1	0	1	1	0	0
51.8...51.15	50.4...50.15	50.8...50.15	50.4...50.7	0	1	1	0	1	1	0	0
			50.8...50.11	1	0	1	0	1	1	0	0
			50.12...50.15	0	0	1	0	1	1	0	0
	51.8...51.15	51.0...51.7	51.0...51.3	1	1	0	0	1	1	0	0
			51.4...51.7	0	1	0	0	1	1	0	0
			51.8...51.11	1	0	0	0	1	1	0	0
51.12...51.15	0	0	0	0	1	1	0	0			

Codierung	Alle Baugruppen dürfen nur bei ausgeschalteter Versorgungsspannung ausgetauscht werden.	Schalter	0 = off/open	1 = on
Coding	Cards must be exchanged only while the supply voltage is disconnected.	Switches		
Codage	Les modules doivent tous être remplacés hors tension.	Codeurs		
Codifica	Togliere tensione prima di inserire o rimuovere i moduli.	Interruttori		
Codificación	Las tarjetas deben insertarse o extraerse sólo con la alimentación desconectada.	Codificador		

**Baugruppentyp / Module Type / Type de module /
Tipi di moduli / Tipo de tarjeta**

**Schalternummer / Switch Number / No. de microrupteur /
N° interruttore / N° de codificador**

A	B	C											
						1					1 2 3 4 5		
					1 2	3				3 4 5 6 7			
			1	2	3	4	5	6	7	8			
52.0...53.15	52.0...52.15	52.0...52.7	52.0...52.3	1	1	1	1	0	1	0	0	0	
			52.4...52.7	0	1	1	1	0	1	0	0	0	
			52.8...52.15	1	0	1	1	0	1	0	0	0	
	53.0...53.15	53.0...53.7	53.0...53.3	53.0...53.3	1	1	0	1	0	1	0	0	0
				53.4...53.7	0	1	0	1	0	1	0	0	0
				53.8...53.15	1	0	0	1	0	1	0	0	0
54.0...55.15	54.0...54.15	54.0...54.7	54.0...54.3	1	1	1	0	0	1	0	0	0	
			54.4...54.7	0	1	1	0	0	1	0	0	0	
			54.8...54.15	1	0	1	0	0	1	0	0	0	
	55.0...55.15	55.0...55.7	55.0...55.3	55.0...55.3	1	1	0	0	0	1	0	0	0
				55.4...55.7	0	1	0	0	0	1	0	0	0
				55.8...55.15	1	0	0	0	0	1	0	0	0
56.0...57.15	56.0...56.15	56.0...56.7	56.0...56.3	1	1	1	1	1	0	0	0	0	
			56.4...56.7	0	1	1	1	1	0	0	0	0	
			56.8...56.15	1	0	1	1	1	0	0	0	0	
	57.0...57.15	57.0...57.7	57.0...57.3	57.0...57.3	1	1	0	1	1	0	0	0	0
				57.4...57.7	0	1	0	1	1	0	0	0	0
				57.8...57.15	1	0	0	1	1	0	0	0	0
58.0...59.15	58.0...58.15	58.0...58.7	58.0...58.3	1	1	1	0	1	0	0	0	0	
			58.4...58.7	0	1	1	0	1	0	0	0	0	
			58.8...58.15	1	0	1	0	1	0	0	0	0	
	59.0...59.15	59.0...59.7	59.0...59.3	59.0...59.3	1	1	0	0	1	0	0	0	0
				59.4...59.7	0	1	0	0	1	0	0	0	0
				59.8...59.15	1	0	0	0	1	0	0	0	0
60.0...61.15	60.0...60.15	60.0...60.7	60.0...60.3	1	1	1	1	0	0	0	0	0	
			60.4...60.7	0	1	1	1	0	0	0	0	0	
			60.8...60.15	1	0	1	1	0	0	0	0	0	
	61.0...61.15	61.0...61.7	61.0...61.3	61.0...61.3	1	1	0	1	0	0	0	0	0
				61.4...61.7	0	1	0	1	0	0	0	0	0
				61.8...61.15	1	0	0	1	0	0	0	0	0
62.0...63.15	62.0...62.15	62.0...62.7	62.0...62.3	1	1	1	0	0	0	0	0	0	
			62.4...62.7	0	1	1	0	0	0	0	0	0	
			62.8...62.15	1	0	1	0	0	0	0	0	0	
	63.0...63.15	63.0...63.7	63.0...63.3	63.0...63.3	1	1	0	0	0	0	0	0	0
				63.4...63.7	0	1	0	0	0	0	0	0	0
				63.8...63.15	1	0	0	0	0	0	0	0	0
63.8...63.15	63.8...63.15	63.8...63.15	63.8...63.15	1	0	0	0	0	0	0	0	0	
			63.12...63.15	0	0	0	0	0	0	0	0	0	