



# **RARA**

**RARA Electronics Corp.**

**WIRE WOUND  
METAL CLAD RESISTORS**

## WIRE WOUND METAL CLAD RESISTORS



RoHS

**IRH/ULH**  
**IRV/ULV**  
Standard & UL  
60-500W  
1m-750Kohms



RoHS

**IRV/ULV**  
**600-1.2KW**  
Standard & UL  
0.1-160ohms



RoHS

**IRV**  
**1600-2800W**  
Highest Power  
2.5-96ohms



RoHS

**IRN/ULN**  
**IRF/ULF**  
IP65 Rating  
30-500W  
1-5.78Kohms



RoHS

**IRS**  
Economical  
Metal Clad  
30W, 50W  
1-500ohms



RoHS

**SPR114**  
Network  
30W X 3  
0.1-20Kohms



RoHS

**IRB**  
Economical  
48-120W  
1-1.3Kohms



**RA**  
Resistor  
Assembly  
80-2400W  
0.1-6.8Kohms



**HRA**  
High Power  
Assembly  
640-1.8KW  
0.1-840ohms



**IRP**  
High Power  
Assembly  
400-3.0KW  
0.1-1.4Kohms



**LCA**  
Low Cost  
Assembly  
1K-3KW  
0.5-560ohms

## IRV, ULV, IRH, ULH WIRE WOUND, METAL CLAD RESISTORS



The IRV(V=vertical) & IRH(H=horizontal) models are our standard wire wound, metal clad resistors. The ULV and ULH models are UL approved versions of the IRV and IRH. These models have an extruded aluminum housing providing rugged and strong protection. Options include flying leads or tab terminals, inductive or non-inductive windings. The most common applications for these models are motor drives, braking and snubber applications and power sources for industrial equipment.

### GENERAL SPECIFICATIONS

Model	Wattage Rating On Heat Sink	Resistance Range [ohms]				Notes:
		Inductive		Inductive		
		Tab Terminals	Flying Leads	Tab Terminals	Flying Leads	
IRV/IRH 60	60W	0.1-400		0.1-180		<b>Standard Tolerances</b> +-2%(G) +-5%(J) +-10%(K)  <b>Optional Tolerances</b> +-1.0%(F) +-0.5%(D) +-0.25%(C) +-0.1%(B)  <b>Extended Resistances</b> >150K depending on model (please enquire)
ULV/ULH 60		0.1-375	0.1-400	0.1-180		
IRV/IRH 80	80W	0.1-910		0.1-110		
ULV/ULH 80		0.1-281	0.1-910	0.1-110		
IRV/IRH 100	100W	0.1-1.1K		0.1-240		
ULV/ULH 100		0.1-225	0.1-1.1K	0.1-225	0.1-240	
IRV/IRH 120	120W	0.1-1.3K		0.1-300		
ULV/ULH 120		0.1-187	0.1-1.3K	0.1-187	0.1-300	
IRV/IRH 150	150W	0.1-1.6K		0.1-390		
ULV/ULH 150		0.1-150	0.1-1.6K	0.1-150	0.1-390	
IRV/IRH 200	200W	0.1-2.2K		0.1-1.1K		
ULV/ULH 200		0.1-450	0.1-2.2K	0.1-450	0.1-1K	
IRV/IRH 300	300W	0.1-2.7K		0.1-1.5K		
ULV/ULH 300		0.1-300	0.1-2.7K	0.1-300	0.1-1.5K	
IRV/IRH 400	400W	0.1-4.3K		0.1-2.2K		
ULV/ULH 400		0.1-225	0.1-4.3	0.1-225	0.1-2.2K	
IRV/IRH 500	500W	0.1-6.8K		0.1-3K		
ULV/ULH 500		0.1-180	0.1-6.8K	0.1-180	0.1-3K	

### CHARACTERISTICS

1/Temperature Range	-55C to +200C	
2/Insulation Resistance	20Mohms minimum	
3/Dielectric Strength	IRV/IRH	AC1500V, 3500V, 4500V, 5400V;Max. leakage current: 2mA
	ULV/ULH	See Note
4/Temp. Coefficient	+-260ppm/C maximum	
5/Short Time Overload	+-[2%+0.05 ohms]	60W: 5XWatt Rating-5s.,80to500W: 10 X wattage rating-5s.
6/Moisture Resistance	+-[3%+0.05 ohms]	40C, 95% RH, DC100V case to terminal (500hrs.)
7/Thermal Shock	+-[2%+0.05 ohms]	wattage rating 30min., -25C, 15minutes
8/Vibration	+-[1%+0.05 ohms]	10Hz-55Hz-10Hz (1min.),2hrs. each direction
9/Moisture Load Life	+-[3%+0.05 ohms]	40C,95%RH,0.1Xwattage rating, 1.5h.on,30min.off,500 hours
10/Load Life	+-[5%+0.05 ohms]	wattage rating 1.5h. on, 30min. off, 500hours

**Note:**  
 ULV/ULH dielectric strength options of 1500V, 3500V, 4500V, 5400V are also available.  
 Optional dielectric strength must be higher than standard (calculated by formula)

**SURFACE TEMPERATURE INCREASE VERSUS POWER LOAD (Heatsink size 400X400X3mm)**

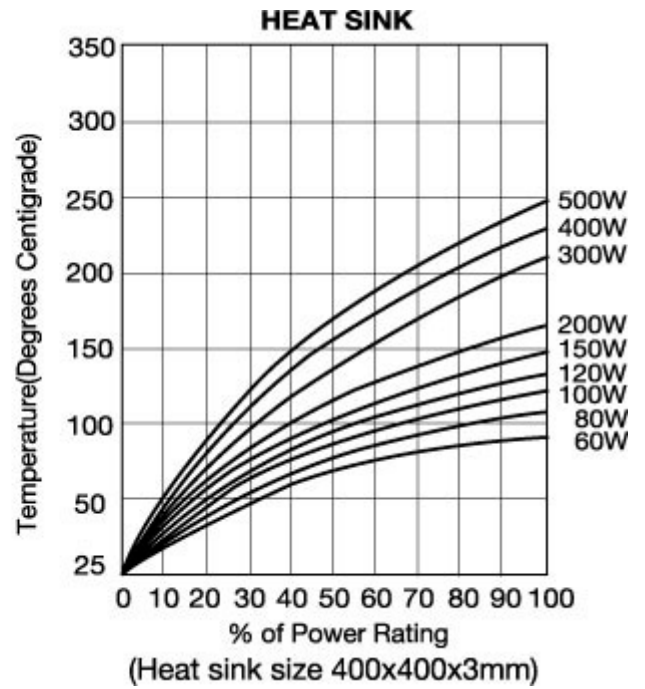
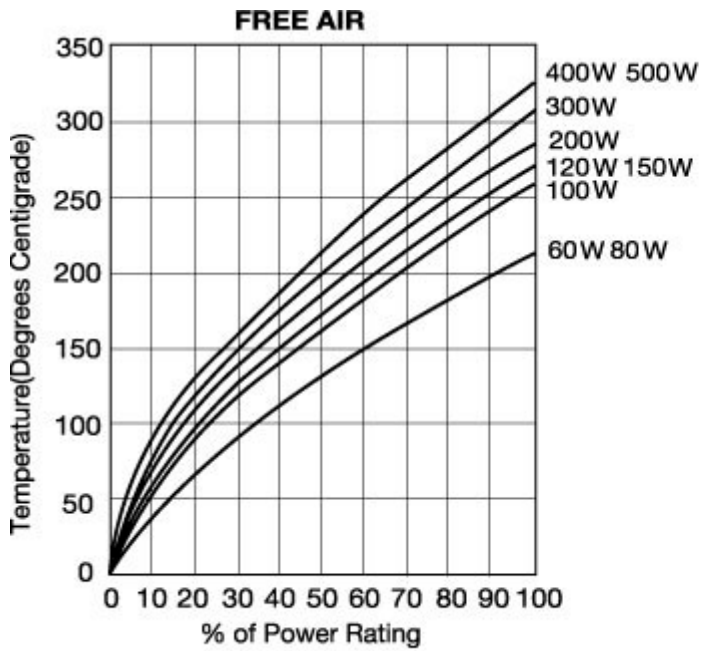

**DIMENSIONS**

Model	Dimensions [ mm ]										Weight [ g ]	
	L1 +-2	L2 +-2	L3 +-2	W +-0.5	H +-0.5	D1 +-0.5	D2 +-0.5	a	b	IRH	IRV	
H/V 60	100	87	60	41	22	4.3	8.65	10	12	110	113	
H/V 80	150	137	110	41	22	4.3	8.65	10	12	195	189	
H/V 100	165	152	125	41	22	4.3	8.65	10	12	216	215	
H/V 120	182	169	142	41	22	4.3	8.65	10	12	245	241	
H/V 150	210	197	170	41	22	4.3	8.65	10	12	283	290	
H/V 200	165	146	125	60	30	5.3	12	13	17	485	447	
H/V 300	215	196	175	60	30	5.3	12	13	17	600	600	
H/V 400	265	246	225	60	30	5.3	12	13	17	770	780	
H/V 500	335	316	295	60	30	5.3	12	13	17	990	980	

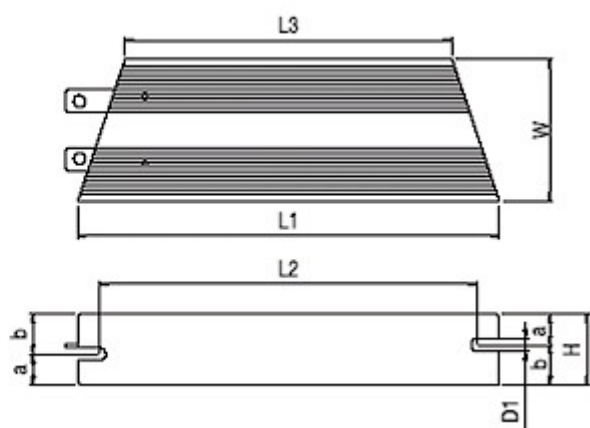
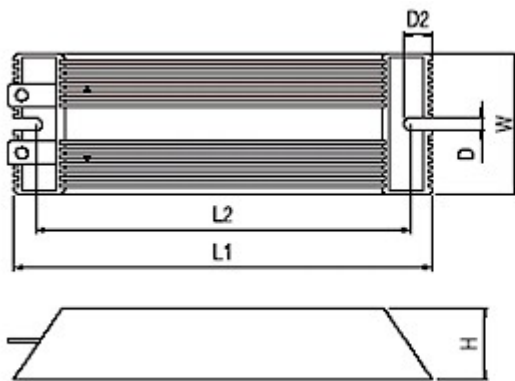

## DERATING CURVE

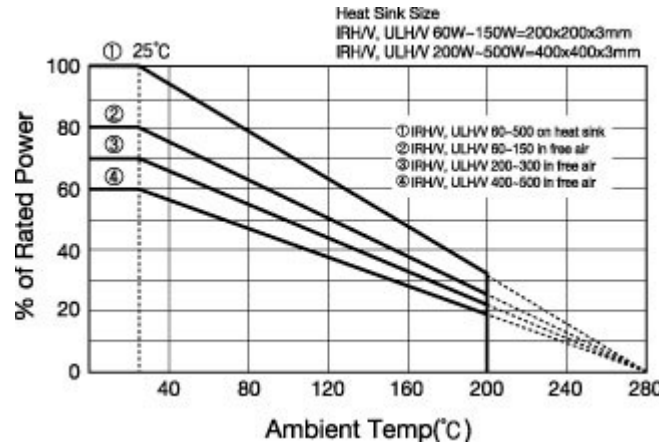

## FLYING LEADS

Model	8mm <sup>2</sup>	5.5mm <sup>2</sup>	2mm <sup>2</sup>	1.25mm <sup>2</sup>	UL3512AWG10	UL3512AWG14
IRH/V60-150	-	-	0.1-0.99ohm	1ohm and up	-	-
IRH/V200-500	0.1-0.99ohm	1-4.99ohm	5ohm and up	-	-	-
IRH/V60-120	-	-	-	-	-	0.10ohm and up
ULH/V150	-	-	-	-	-	0.11ohm and up
ULH/V200	-	-	-	-	0.1-0.15ohm	0.16ohm and up
ULH/V300	-	-	-	-	0.1-0.22ohm	0.23ohm and up
ULH/V400	-	-	-	-	0.1-0.30ohm	0.31ohm and up
ULH/V500	-	-	-	-	0.1-0.37ohm	0.38ohm and up

## ORDERING PROCEDURE EXAMPLE

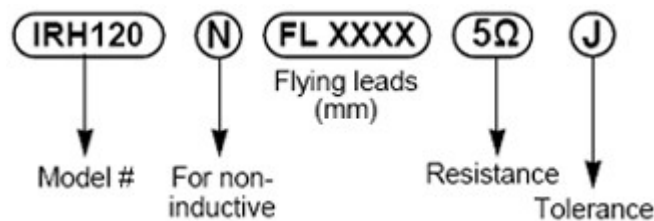

## IRV/ULV 600-1200 WIRE WOUND, METAL CLAD RESISTORS



The IRV/ULV600-1200 (V=vertical) models are our standard higher power, wire wound, metal clad resistors. The ULV600-1200 are the UL approved versions of the IRV600-1200 models. These models have an extruded aluminium housing providing strong and rugged protection. Options include flying leads or tab terminals and inductive or non-inductive windings. The

most common applications for these models are: motor drives, braking and snubber applications and power sources for industrial equipment.

### SPECIFICATIONS

Model	Power Rating on Heatsink	Resistance Range [ohms]					
		Inductive			Non-Inductive		
		Tab TP	Tab TS	Leads	Tab TP	Tab TS	Leads
IRV600	600W	0.1-9	9.1-94	0.1-94	0.1-5.3	5.4-21.2	0.1-21.2
ULV600		0.1-9	9.1-94	0.1-94	0.1-5.3	5.4-21.2	0.1-21.2
IRV800	800W	0.1-11	11.1-112	0.1-112	0.1-7.2	7.2-28.8	0.1-28.8
ULV800		0.1-11	11.1-112	0.14-112	0.1-7.2	7.2-28.8	0.14-28.8
IRV1000	1000W	0.1-18	18.1-140	0.1-140	0.1-9	9.1-36	0.1-36
ULV1000		0.1-18	18.1-140	0.17-140	0.1-9	9.1-36	0.17-36
IRV1200	1200W	0.1-25	25.1-160	0.1-160	0.1-12	12.1-48	0.1-48
ULV1200		0.1-25	25.1-75	0.21-160	0.1-12	12.1-48	0.21-48

IRV available tolerances: +-0.5(D), +-1(F), +-2(G), +-5(J), +-10(K)

ULV available tolerances: +-2(G), +-5(J), +-10(K)

### CHARACTERISTICS

Values in [ ] mean change in ohmic value after test

Temperature Range	-55C to +200C	
Insulation Resistance	20MW minimum	
Dielectric Strength	IRV	AC1500V, 3500V, 4500V, 5400V; Max. leakage current: 2mA
	ULV	See Note [1000V+(Voltage Rating X 2) for 1min.
Temp. Coefficient	±260ppm/C maximum	
Short Time Overload	±[2%+0.05W] 5seconds	10 X Power rating-
Moisture Resistance	±[3%+0.05W]	40C, 95% RH, DC100V case to terminal (500hrs.)
Thermal Shock	±[2%+0.05W] 25C, 15minutes	Power rating 30min.,
Vibration	±[1%+0.05W]	1Hz-55Hz-10Hz (1min.), 2hrs. each direction
Moisture Load Life	±[3%+0.05W]	40C, 95% RH, 0.1 X Power rating, 1.5h. on, 30min. off, 500 hrs.
Load Life	±[5%+0.05W]	Power rating 1.5hr. on, 30min. off, 500hours

**Note:**  
 ULV/ULH dielectric strength options of AC1500V, 3500V, 4500V, 5400V also available  
 Optional dielectric strength must be higher than standard (calculated by formula)

## SURFACE TEMPERATURE INCREASE VS POWER LOAD

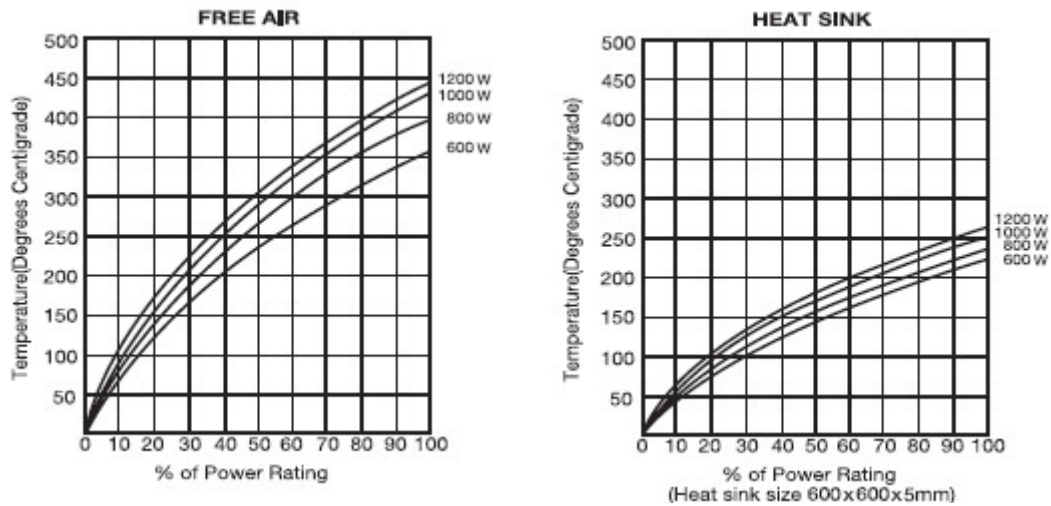

## DIMENSIONS

Model	Dimensions [mm]			Weight [g]
	L1+-2	L2+-2	L3+-2	
IRV600	235	216	195	1165
IRV800	285	266	245	1500
IRV1000	335	316	295	1835
IRV1200	405	386	365	2304

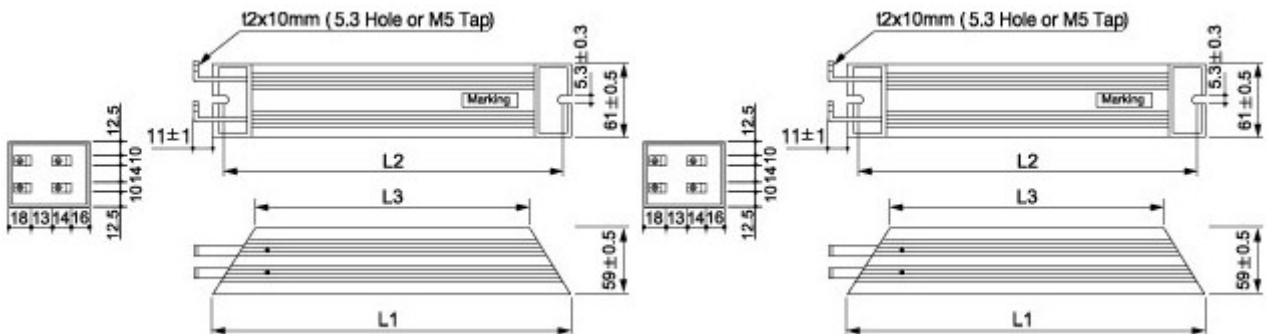

## FLYING LEADS

Model	8mm <sup>2</sup>	5.5mm <sup>2</sup>	UL 3512 AWG 10
IRV600-1200	0.1-0.99ohms	1 ohm and up	-
ULV600	-	-	0.11 ohms and up
ULV800	-	-	0.14 ohms and up
ULV1000	-	-	0.17 ohms and up
ULV1200	-	-	0.21 ohms and up

## DERATING CURVE

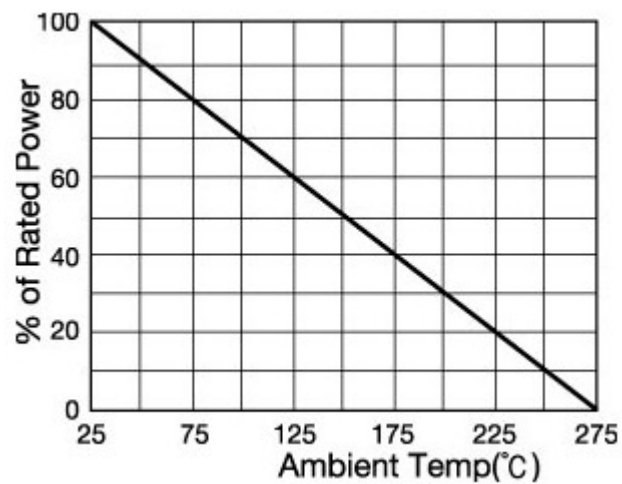

## ORDERING PROCEDURE EXAMPLE

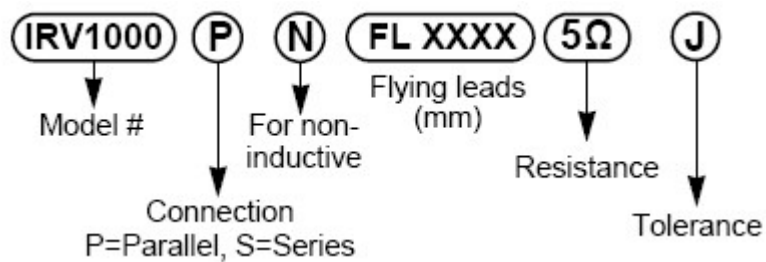



## IRV1600-2800 HIGH POWER, WIRE WOUND, METAL CLAD RESISTORS

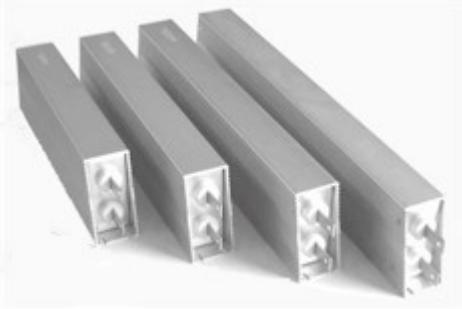

The IRV1600-2800 (V=vertical) models are our highest power, wire wound, metal clad resistors. These models have an extruded aluminium housing providing strong and rugged protection. Options include flying leads or tab terminals and inductive or non-inductive windings. The most common applications for these models are: motor drives, braking and snubber applications and power sources for industrial equipment. These models are fully RoHS compliant.

### SPECIFICATIONS

Model	Rated Power		Resistance Range	Resistance Tolerance
	Heat Sink	Free Air	Inductive	
IRV1600	1600W	570W	2.5-78	F[+-01%] J[+-05%] K[+-10%]
IRV2000	2000W	650W	3.2-86	
IRV2400	2400W	720W	4.0-92	
IRV2800	2800W	730W	4.5-96	

### CHARACTERISTICS

Values in [ ] mean change in ohmic value after test

Temperature Range	-55C to +280C	
Insulation Resistance	20MW minimum	
Dielectric Strength	AC1500V, 2500V, 3500V, 4500V for 1 min.; Max. leakage current: 2mA	
Temp. Coefficient	±260ppm/C maximum	
Short Time Overload	±[3%+0.05W]	5-10 X Power rating-5seconds
Moisture Resistance	±[3%+0.05W]	40C, 95% RH, DC100V case to terminal (500hrs.)
Thermal Shock	±[5%+0.05W]	Power rating 30min., -40C,15minutes
Vibration	±[2%+0.05W]	10Hz-55Hz-10Hz (1min.), 2hrs. each direction
Moisture Load Life	±[3%+0.05W]	40C, 95% RH, 0.1XPower rating, 1.5h. on, 30min. off, 500 hrs.
Load Life	±[5%+0.05W]	Power rating 1.5hr. on, 30min. off, 500hours

## SURFACE TEMPERATURE INCREASE VS POWER LOAD & DERATING

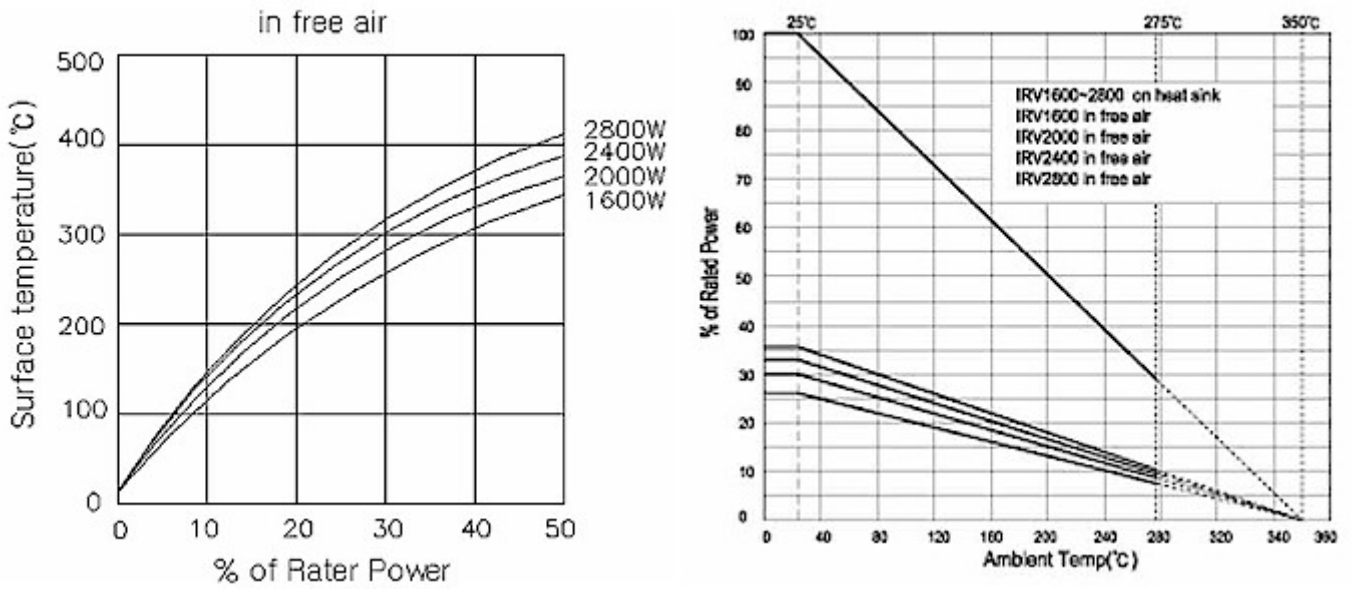

## DIMENSIONS

Model	Dimensions [mm]					Weight [Kg]
	L1+-2	L2+-2	L3+-2	H+-1	W+-0.5	
IRV1600	330	315	290	100	50	2.5
IRV2000	440	385	360	100	50	3.1
IRV2400	480	465	440	100	50	3.7
IRV2800	550	535	510	100	50	4.3

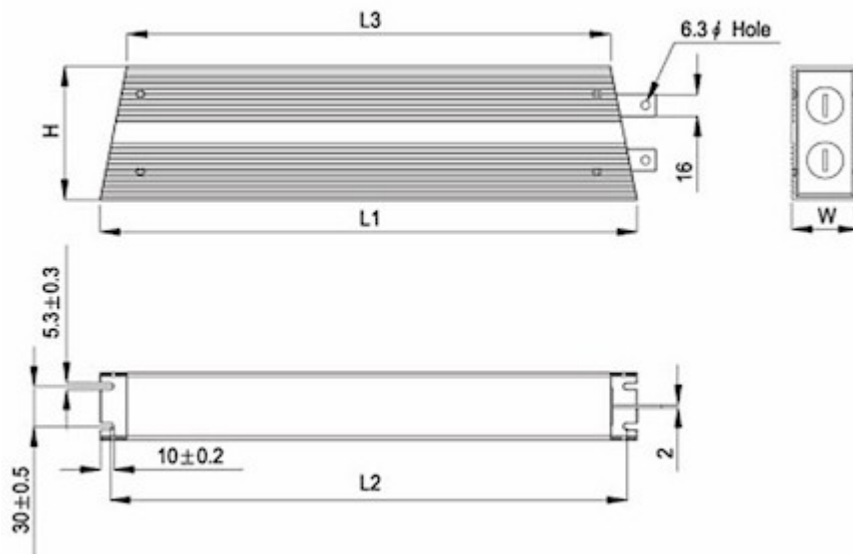

## FLYING LEADS

Model	5.5mm <sup>2</sup>	2mm <sup>2</sup>	UL3512 AWG14	LKGB-600V 2mm <sup>2</sup>
IRV1600	Optional	2.5ohm +	Optional	Optional
IRV2000	Optional	3.2ohm +	Optional	Optional
IRV2400	Optional	4.0ohm +	Optional	Optional
IRV2800	Optional	4.5ohm +	Optional	Optional

## ORDERING PROCEDURE EXAMPLE

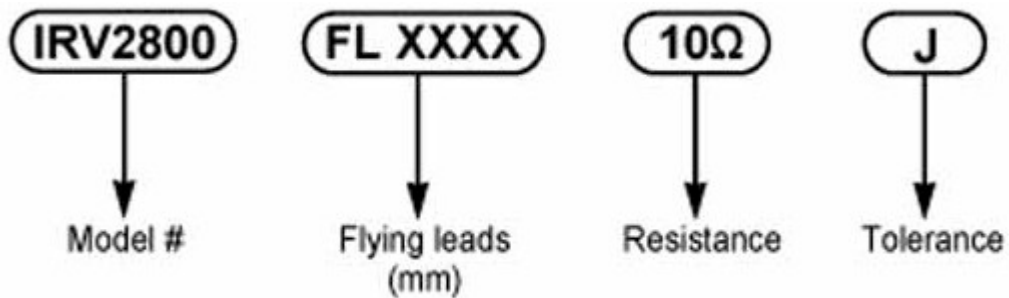

**IRN, ULN, IRF, ULF SLIM PROFILE  
WIRE WOUND, METAL CLAD RESISTORS  
IP65 RATING AVAILABLE**



The IRN(N=narrow and flat) & IRF(F=flat) models are metal-clad, wire-wound, high-power, extremely low inductance resistors designed for industrial and other applications where space is at a premium and performance is a must. The ULN and ULF are UL approved versions of these models. Our extruded aluminium housing provides rugged and strong protection. The flat design allows excellent heat dissipation. These models are available with flying leads or tab terminals. The most common applications for these models are motor drives, braking and snubber applications and power sources for industrial equipment.

**GENERAL SPECIFICATIONS**

Model	Wattage Rating on Heat Sink	Resistance Range [ohms]	Tolerances
IRN50/ULN50C	50W	1-420	+-0.5(D)
IRN100/ULN100C	100W	1-1.1K	
IRN150/ULN150C	150W	1-1.75K	
IRF100/ULF100C	100W	1-1.1K	+-1.0(F)
IRF150/ULF150C	150W	1-1.75K	
IRF200/ULF200C	200W	1-2.2K	+-2.0(G)
IRF250/ULF250C	250W	1-2.79K	
IRF300/ULF300C	300W	1-3.5K	+-5.0(J)
IRF400	400W	1-4.45K	
ULF400C	400W	1-3.08K	+-10(K)
IRF500	500W	1-5.78K	
ULF500C	500W	1-2.46K	

**CHARACTERISTICS**

1/Temperature Range	Cement: -55C to +200C, Silicone: -55-150C	
2/Insulation Resistance	20Mohms minimum	
3/Dielectric Strength	IRN/IRF	AC1500V, 2500V, 3000V, 4500V; Max. leakage current: 2mA
	ULN/ULF	See Note 2
4/Temp. Coefficient	+-260ppm/C maximum	
5/Short Time Overload	+-[1%+0.05 ohms]	5 X Power Rating-5sec.
6/Moisture Resistance	+-[2%+0.05 ohms]	40C, 95% RH, DC100V case to terminal (500hrs.)
7/Thermal Shock	+-[1%+0.05 ohms]	Power rating 30min., -25C, 15minutes
8/Vibration	+-[1%+0.05 ohms]	10Hz-55Hz-10Hz (1min.), 2hrs. each direction
9/Moisture Load Life	+-[2%+0.05 ohms]	40C,95% RH, 0.1 X Power rating, 1.5h. on, 30min. off, 500 hours
10/Load Life	+-[5%+0.05 ohms]	Power rating, 1.5h. on, 30min. off, 500 hours

**Note1:**  
ULN/ULF dielectric strength options of 1500V, 3500V, 4500V are also available.  
Optional dielectric strength must be higher than standard (calculated by formula)

**Note2:**  
Less than 50V: 500V 1 min.  
50-600V: [1000V+(voltage rating X 2) 1 min.  
601-1500V: [2000V+(voltage rating X 2.25) 1 min.

**SURFACE TEMPERATURE INCREASE VERSUS POWER LOAD**  
(Heatsink size 400X400X3mm)

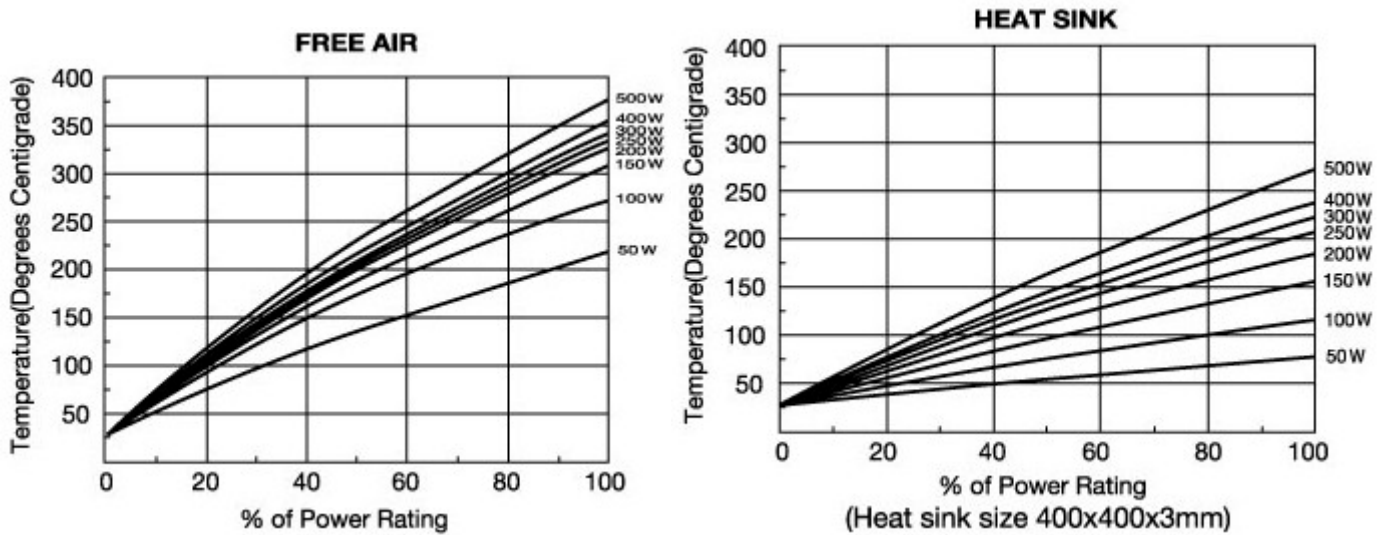

**DIMENSIONS**

Model	Dimensions [mm]				Weight [g]
	L1+-1	L2+-0.3	W1+-0.3	W2+-0.3	
IRN50/ULN50	70	50	60	50	100
IRN100/ULN100	120	100	60	50	160
IRN150/ULN150	170	150	60	50	220
IRF100/ULF100	90	70	80	70	155
IRF150/ULF150	120	100	80	70	200
IRF200/ULF200	150	130	80	70	245
IRF250/ULF250	180	160	80	70	290
IRF300/ULF300	210	190	80	70	335
IRF400/ULF400	270	250	80	70	430
IRF500/ULF500	330	310	80	70	525

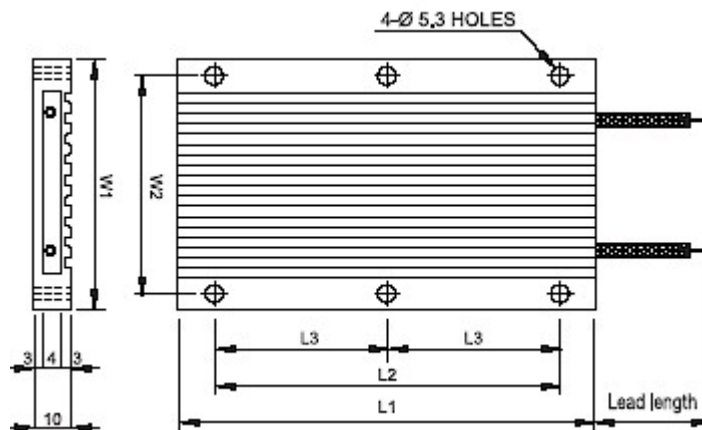

## FLYING LEADS

Model	2mm <sup>2</sup>	1.25mm <sup>2</sup>	UL 3512 AWG 16
IRN/F 50-150	-	1ohm	-
IRF200	1-4ohm	4.1ohm	-
IRF250	1-5ohm	5.1ohm	-
IRF300	1-6ohm	6.1ohm	-
IRF400	1-8ohm	8.1ohm	-
IRF500	1-10ohm	10.1ohm	-
ULN/F 50-500	-	-	1ohm

## DERATING CURVE

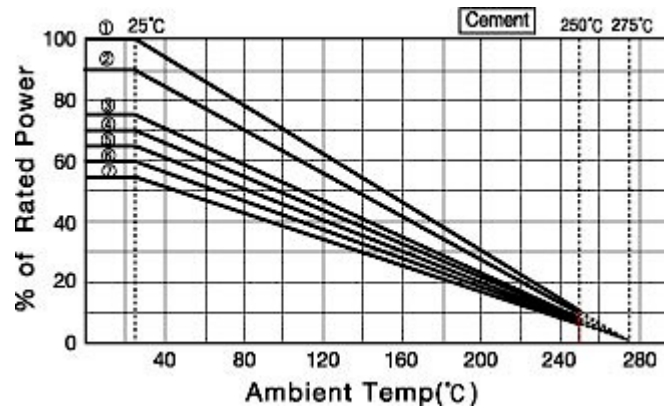

- 1 IRF,IRN,ULF,ULN100-500 on heat sink; IRN,ULN50 free air
- 2 IRF,IRN,ULF,ULN100 in free air
- 3 IRF,IRN,ULF,ULN150 in free air
- 4 IRF,IRN,ULF,ULN200 in free air
- 5 IRF,IRN,ULF,ULN250-300 in free air
- 6 IRF,IRN,ULF,ULN400 in free air
- 7 IRF,IRN,ULF,ULN500 in free air

Heat Sink Size:  
 IRF,IRN,ULF,ULN100-200: 200X200X3mm  
 IRF,ULF250-400: 400X400X3mm  
 IRF,ULF500: 600X600X3mm

## ORDERING PROCEDURE EXAMPLE

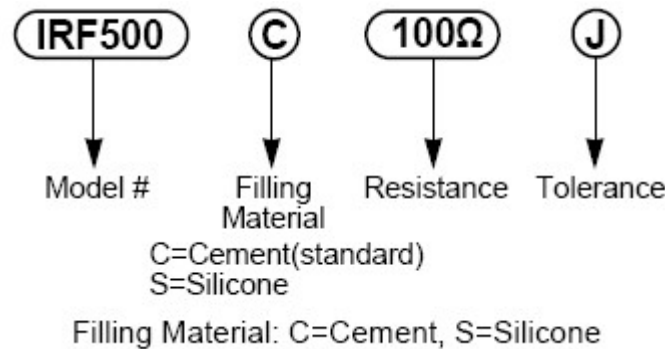

## ECONOMICAL WIRE WOUND, METAL CLAD RESISTORS

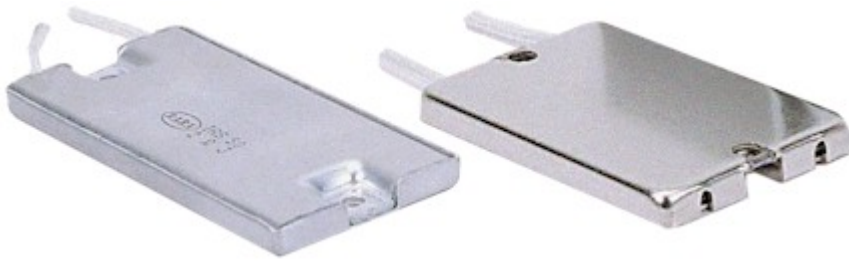

The IRS30, IRS50 are slim and flat economical resistors. These models are ideal for applications where space and funds are at a premium. The most common applications for these models are motor drives, braking and snubber applications and power sources for industrial equipment.

### SPECIFICATIONS

MODEL	Wattage Rating On Heat Sink [W]	Resistance Range [ohms]	Dimensions		Weight [g]
			L1+-1	L2+-1	
IRS 30	30	1 - 420	65	57	65
IRS 50	50	1-500	90	78	50

Available Tolerances: +-0.5(D), +-1.0(F), +-2.0(G), +-10(K)

### DIMENSIONS

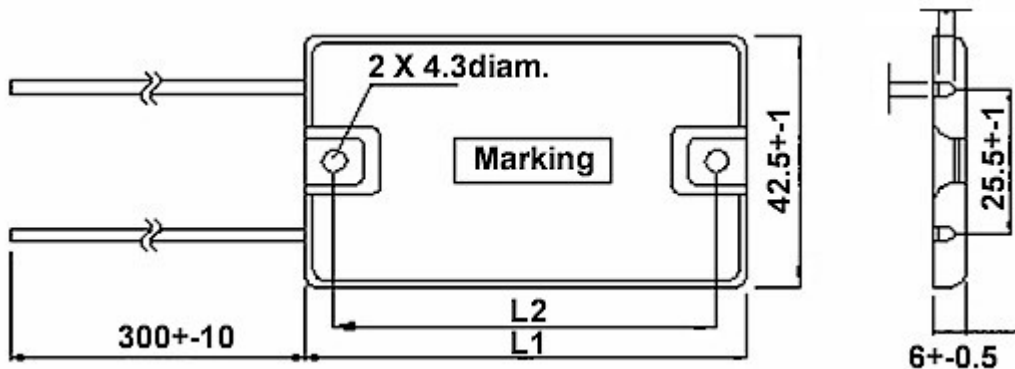

### CHARACTERISTICS

Temperature Range	200C	-55-
Insulation Resistance		20Mohm Minimum
Dielectric Strength	Available Options: AC1500V, 2500V; Max. Leakage Current: 2mA	
Temp. Coefficient		+/-260ppm/C Maximum
Short Time Overload	+/-[2%+0.05ohms]	5 X Power Rating, 5sec.
Thermal Shock	+/-[2%+0.05ohms]	Power Rating 30min., -25C 15min.
Load Life	+/-[5%+0.05ohms]	Power Rating 1.5hrs. on, 30min. off, 500hrs.

## SURFACE TEMPERATURE INCREASE VS POWER LOAD

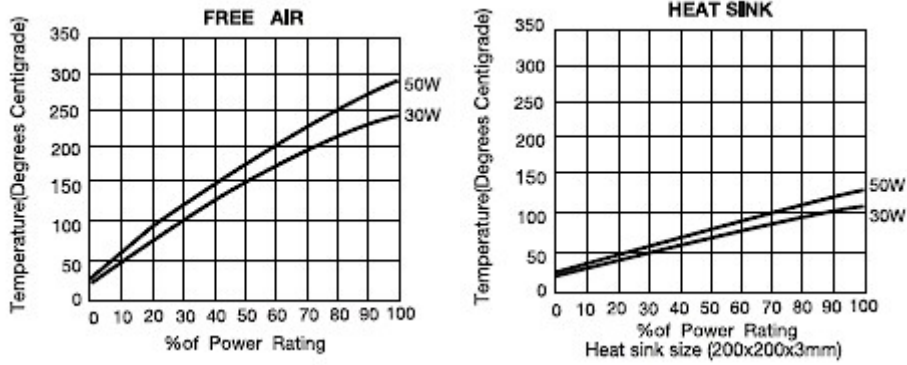

## DERATING CURVE

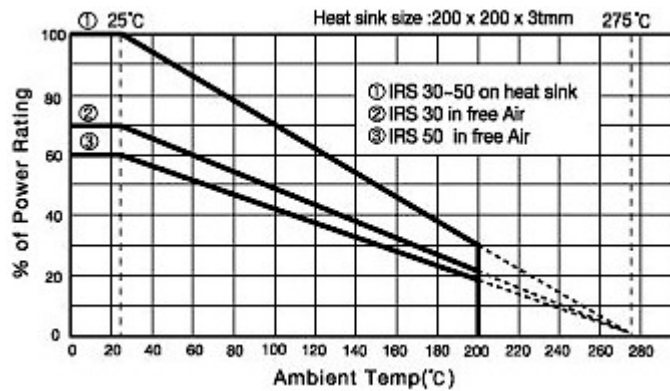

- 1/ On chassis, 30W, 50W (heatsink size 200X200X3mm)
- 2/ Free Air, 30W
- 3/ Free Air, 50W

## ORDERING PROCEDURE EXAMPLE

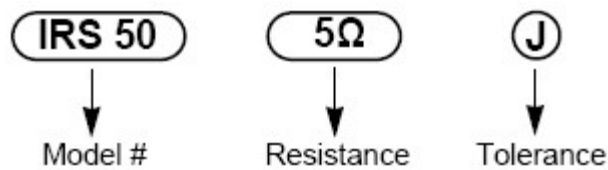



## SPR114 30W X 3 NETWORK RESISTORS



These Are aluminium hosed, non-inductive, resistor networks. These are mountable on chassis toutilize heatsink effect. These models exhibit high stability at conventional power ratings. The SPR114 has three isolated resistors.

### SPECIFICATIONS

Model	Power Rating [W]	Resistance Range [ohms]	Tolerance
SPR114	30 X 3	75 X 3	J(+ -5%)
		150 X 3	
		300 X 3	
		400 X 3	

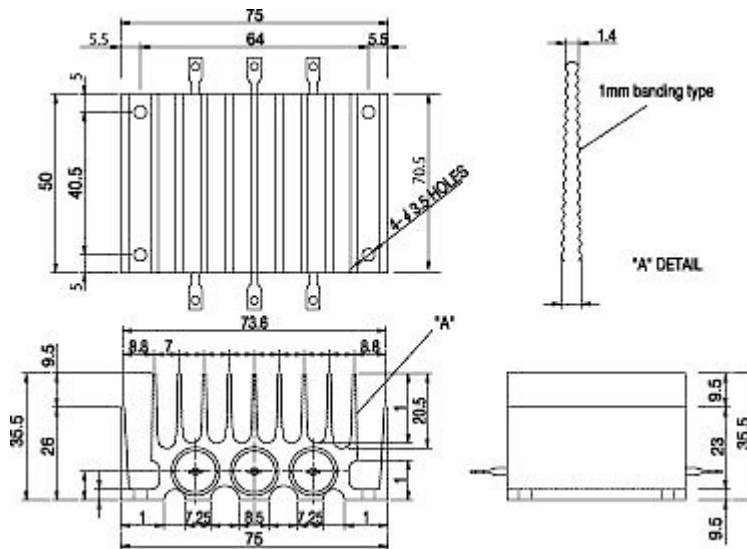

### CHARACTERISTICS

Temperature Range	-55C to 200C
Insulation Resistance	20Mohms minimum
Dielectric Strength	Available Options: AC200V; Max. 1 min.; Leakage Current: 2mA
Temperature Coefficient	+ -260ppm/C maximum

### ORDERING PROCEDURE EXAMPLE

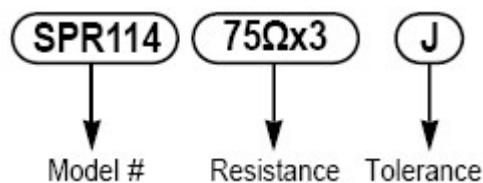

## ECONOMICAL WIRE WOUND, METAL CLAD RESISTORS



IRB60, 80, 120 metal clad, wire wound resistors are ideal for applications that require 60W,80W,120W or less and are on a budget. These models come in a durable metal case have flying leads.

### GENERAL SPECIFICATIONS

MODEL	Power rating [W]	Resistance Range [ $\Omega$ ]	
		Inductive	Non-Inductive
IRB 60	60	0.1-270	0.1-56
IRB 80	80	0.1-910	0.1-110
IRB120	120	0.1-1.3K	0.1-300

Available Tolerances: G (+-2%), H (+-3%), J (+-5%), K (+-10%), M (+-20%)

### DIMENSIONS

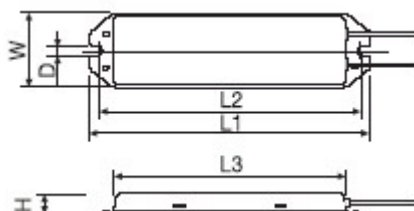

MODEL	DIMENSIONS					
	L1	L2	D	W	L3	H
IRB60	100+-1.5	90+-1.5	5+-0.2	32.3+-0.5	75+-1	12.3+-1
IRB80	150+-2	140+-2	4.2+-0.5	34+-1	130+-2	20+-1
IRB120	182+-1	170+-1	5+-0.2	44+-1	150+-1	13+-0.5

### CHARACTERISTICS

Values in [ ] mean change in ohmic value after test

Temperature Range	-55C to 200C	
Insulation Resistance	20Mohm min.	
Dielectric Strength	Available options: AC 1500V,3500V,4500V,5400V MAX. leakage current: 2mA	
Temp. Coefficient	+- 260ppm/C maximum	
Short time overload	(2%+0.05 $\Omega$ )	60W:5×wattage rating, 80W, 120W:10×wattage rating-5 sec.
Moisture Resistance	(3%+0.05 $\Omega$ )	40C, 95% RH, DC100V case to terminal (500hrs.)
Thermal Shock	(2%+0.05 $\Omega$ )	wattage rating 30 min., -25C, 15 min.
Vibration	(1%+0.05 $\Omega$ )	10Hz-55Hz-10Hz (1 min.), 2hrs.each direction
Moisture Load Life	(3%+0.05 $\Omega$ )	40C, 95%RH, 0.1×wattage rating, 1.5hrs.on, 30min. off, 1000hrs.
Load Life	(5%+0.05 $\Omega$ )	wattage rating 1.5h. on, 30min.off, 1000hrs.

**SURFACE TEMPERATURE INCREASE CURVE**

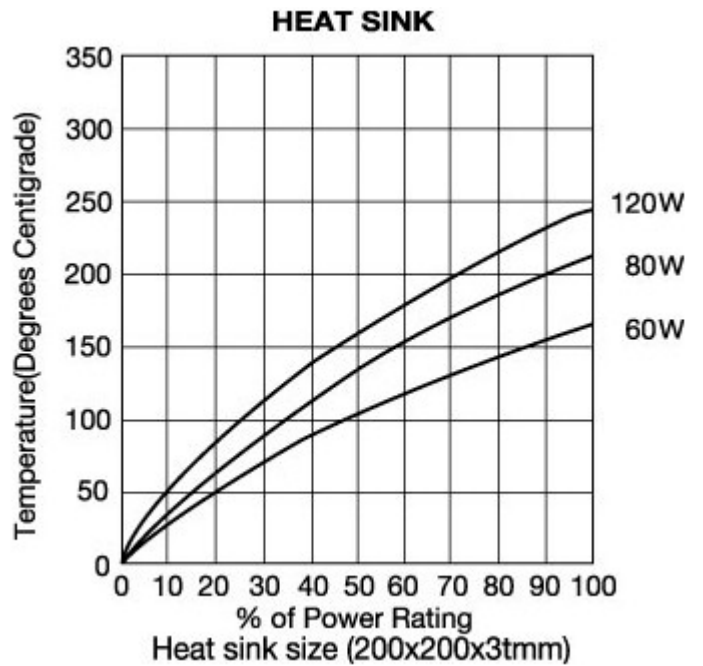
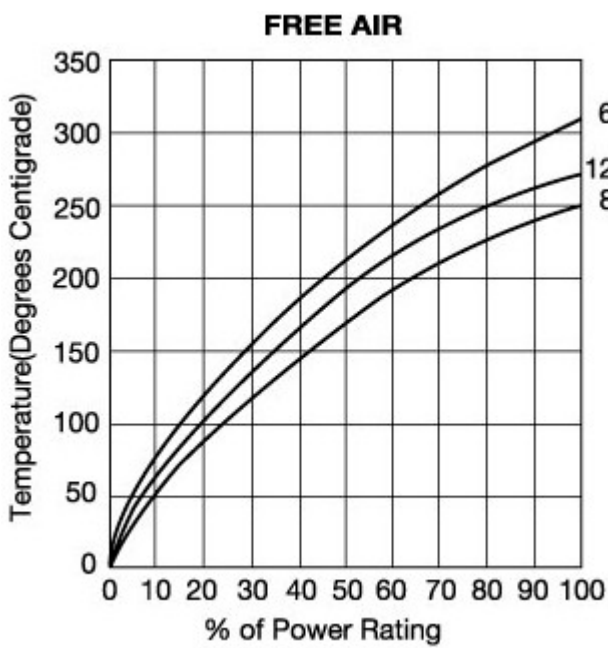

**DERATING CURVE**

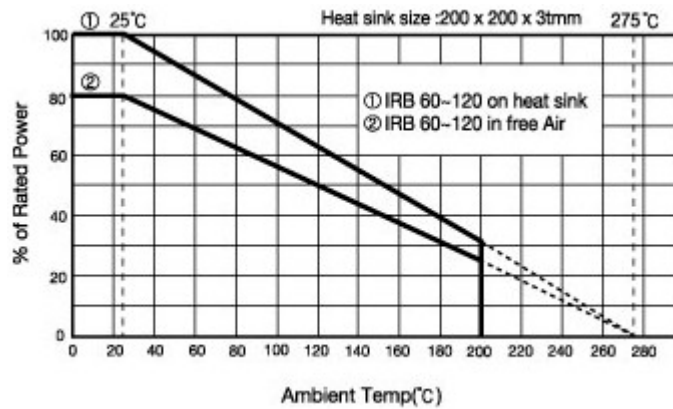

**ORDERING PROCEDURE EXAMPLE**

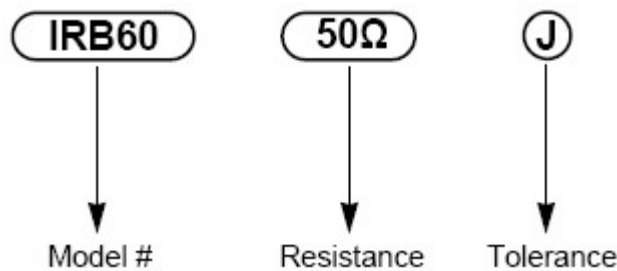

## RA RESISTOR ASSEMBLIES



The RA series of power, metal clad, wire wound resistors are designed for use in power inverters. The basis for these models is an IRH or IRV resistor surrounded by a metal case, which conforms to international safety specifications. The steel case is powder coated and baked for durability.

### GENERAL SPECIFICATIONS

Model	Resistor Type Inside	Wattage Rating in Free Air	Resistance Range [ohms]		Resistance Tolerance
			Inductive	Non-Inductive	
RA080	IRH80	80	0.1-910	0.1-110	+-0.5(D) +-1.0(F) +-2.0(G) +-5.0(J) +-10(K)
RA100	IRH100	90	0.1-1.1K	0.1-240	
RA200	IRH200	140	0.1-2.2K	0.1-1K	
RA300	IRH300	210	0.1-2.7K	0.1-1.5K	
RA400	IRH400	240	0.1-4.3K	0.1-2.2K	
RA500	IRH500	300	0.1-6.8K	0.1-3K	
RA600	IRV600	320	0.1-94	0.1-23	
RA800	IRV800	360	0.1-112	0.1-28	
RA1000	IRV1000	400	0.1-140	0.1-36	
RA1200	IRV1200	420	0.1-160	0.1-48	
RA1600	IRV1600	570	2.5-78	/	
RA2000	IRV2000	650	3.2-86	/	
RA2400	IRV2400	710	4.0-92	/	

### CHARACTERISTICS

1/Temperature Range	+200C	-55C to
2/Insulation Resistance	minimum	20Mohms
3/Dielectric Strength	Available options: 1500, 3500, 4500, 5400 (VAC); Max Leakage Current: 2mA	
4/Temp. Coefficient	+-260ppm/C maximum	
5/Short Time Overload	+-[2%+0.05 ohms]	10 X wattage rating 5s.
6/Moisture Resistance	+-[3%+0.05 ohms]	40C, 95% RH, DC100V case to terminal (500hrs.)
7/Thermal Shock	+-[2%+0.05 ohms]	Wattage rating 30min., -25C, 15minutes

## DIMENSIONS

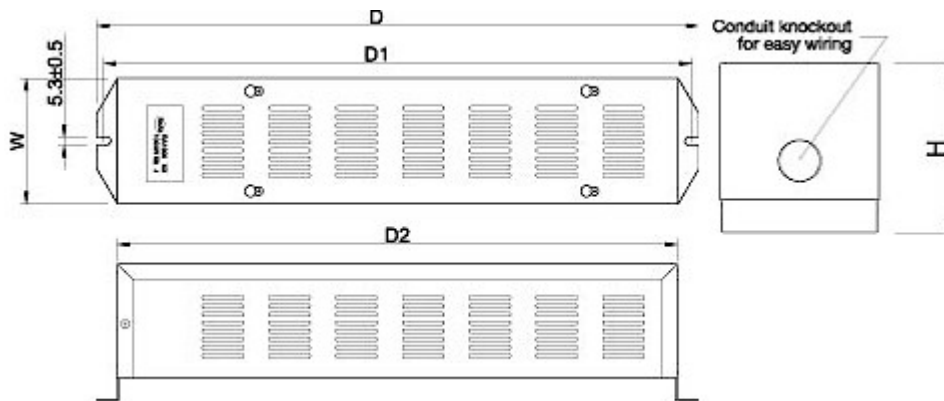

Model	Weight [g]	Dimensions [mm]				
		W+-1.5	H+-1.5	D+-2	D1+-1.5	D2+-2
RA080	980	78.5	67	254	240	224
RA100	1000	78.5	67	254	240	224
RA200	2415	93.5	105	440	426	410
RA300	2530	93.5	105	440	426	410
RA400	2700	93.5	105	440	426	410
RA500	2920	93.5	105	440	426	410
RA600	3095	93.5	105	440	426	410
RA800	3430	93.5	105	440	426	410
RA1000	3725	93.5	105	440	426	410
RA1200	4194	93.5	105	510	426	480
RA1600	5900	93.5	147	615	600	584
RA2000	6500	93.5	147	615	600	584
RA2400	7100	93.5	147	615	600	584

## ORDERING PROCEDURE EXAMPLE

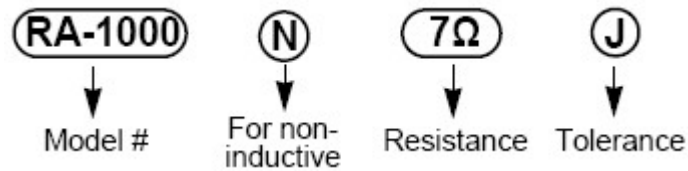

## HRA RESISTOR ASSEMBLIES



The HRA series of power, metal clad, wire wound resistors are designed for use in high power inverters. The basis for these models is an IRV resistors surrounded by a metal case, which conforms to international safety specifications. The steel case is powder coated and baked for durability.

### GENERAL SPECIFICATIONS

Model	Internal Resistor	Power Rating		Resistance Range [ohms]		Resistance Tolerance
		Free Air	Fan	Inductive	Non-Inductive	
HRA1600	2XIRV800	640W	960W	0.1-224	0.1-56	+-0.5(D) +-1.0(F) +-2.0(G) +-5.0(J) +-10(K)
HRA2000	2XIRV1000	800W	1200W	0.1-280	0.1-72	
HRA2400	3XIRV800	960W	1440W	0.1-336	0.1-84	
HRA3000	3XIRV1000	1100W	1650W	0.1-420	0.1-108	
HRA4000	4XIRV1000	1400W	2100W	0.1-560	0.1-144	
HRA5000	5XIRV1000	1600W	2400W	0.1-700	0.1-180	
HRA6000	6XIRV1000	1800W	2700W	0.1-840	0.1-216	
HRA7000	7XIRV1000	2100W	3150W	0.1-980	0.1-252	
HRA8000	8XIRV1000	2400W	3600W	0.1-1120	0.1-288	
HRA9000	9XIRV1000	2700W	4050W	0.1-1260	0.1-324	
HRA10000	10XIRV1000	3000W	4500W	0.1-1400	0.1-360	

### CHARACTERISTICS

1/Temperature Range	+200C	-55C to
2/Insulation Resistance	minimum	20Mohms
3/Dielectric Strength	Available options: 1500, 2500, 3500 (VAC); Max Leakage Current: 2mA	
4/Temp. Coefficient	+-260ppm/C maximum	
5/Short Time Overload	+-[2%+0.05 ohms]	10 X wattage rating 5s.
6/Moisture Resistance	+-[3%+0.05 ohms]	40C, 95% RH, DC100V case to terminal (500hrs.)
7/Thermal Shock	+-[2%+0.05 ohms]	Wattage rating 30min., -25C, 15minutes

## DIMENSIONS

Model	Weight [Kg]	Dimensions [mm]				
		W±5	D±5	H±3	W1±2	D1±2
HRA1600	8.3	250	510	110	215	360
HRA2000	9	250	510	110	215	360
HRA2400	9.8	250	510	110	215	360
HRA3000	10.8	250	510	110	215	360
HRA4000	14.2	388	510	110	356	360
HRA5000	16.0	388	510	110	356	360
HRA6000	18.0	388	510	190	356	360
HRA7000	20.5	388	510	190	356	360
HRA8000	22.3	388	510	190	356	360
HRA9000	24.2	388	510	190	356	360
HRA10000	26.0	388	510	190	356	360

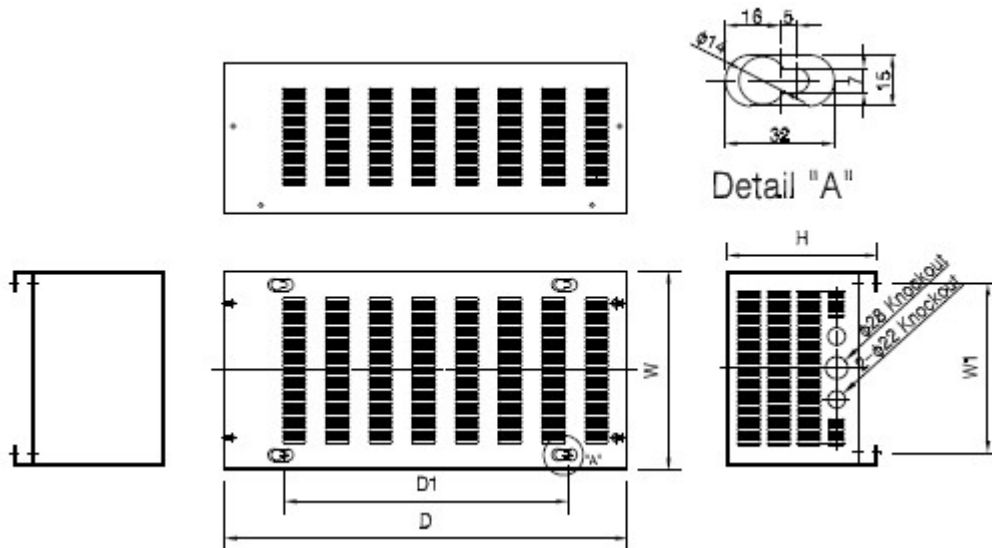

These models come with multiple conduit knockouts for easy wiring.

The enclosure is well ventilated and meets int'l safety specs.

## ORDERING PROCEDURE EXAMPLE

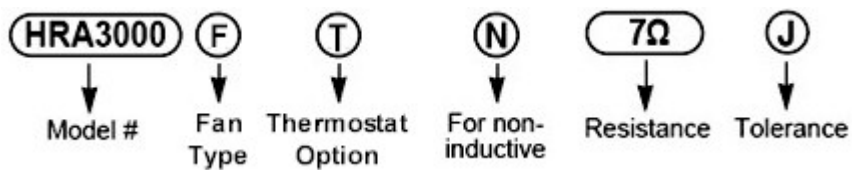

## IRP HIGH POWER RESISTOR ASSEMBLIES



The IRP high power resistor line can handle power of up to 3000W in free air. These models are comprised of multiple resistors housed in a rugged steel protective cover. The base is zinc plated steel. The cover is powder coated which is baked, rendering it extremely strong. The major application for this model range is high power inverter braking resistors.

### GENERAL SPECIFICATIONS

Model	Free Air Power Rating [W]	Resistance Range [ohms]		Resistance Tolerance
		Inductive	Non-Inductive	
IRP1000	400	0.1-140	0.1-36	+-0.5(D) +-1.0(F) +-2.0(G) +-5.0(J) +-10(K)
IRP2000	800	0.1-280	0.1-72	
IRP3000	1100	0.1-420	0.1-108	
IRP4000	1400	0.1-560	0.1-144	
IRP5000	1600	0.1-700	0.1-180	
IRP6000	1800	0.1-840	0.1-216	
IRP7000	2100	0.1-980	0.1-252	
IRP8000	2400	0.1-1120	0.1-288	
IRP9000	2700	0.1-1260	0.1-324	
IRP10000	3000	0.1-1400	0.1-360	

### CHARACTERISTICS

1/Temperature Range	+200C	-55C to
2/Insulation Resistance	minimum	20Mohms
3/Dielectric Strength	Available options: 1500, 2500, 3500 (VAC); Max Leakage Current: 2mA	
4/Temp. Coefficient	+-260ppm/C maximum	
5/Short Time Overload	+-[2%+0.05 ohms]	10 X wattage rating 5s.
6/Moisture Resistance	+-[3%+0.05 ohms]	40C, 95% RH, DC100V case to terminal (500hrs.)
7/Thermal Shock	+-[2%+0.05 ohms]	Wattage rating 30min., -25C, 15minutes



## DIMENSIONS

Model	Dimensions[mm]						Weight [Kg]
	L1+-2	L2+-2	W1+-2	W2+-2	H1+-2	H2+-2	
IRP1000	530	510	320	240	120	75	7.1
IRP2000			320				9.0
IRP3000			320				10.8
IRP4000			430				14.2
IRP5000			430				16.0
IRP6000			320				18.0
IRP7000			430		20.5		
IRP8000			430		22.3		
IRP9000			430		24.2		
IRP10000			430		26.0		

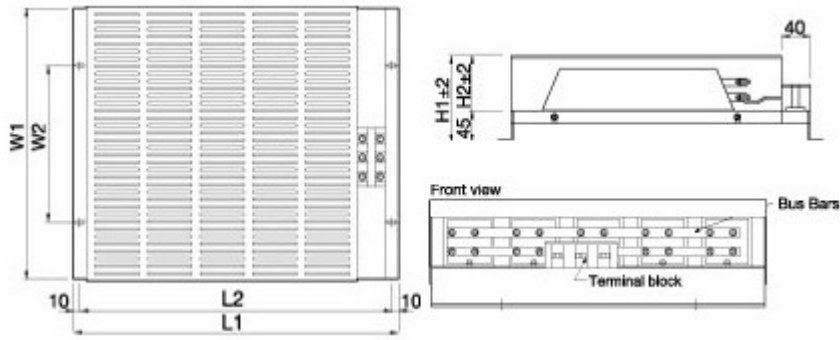

## ORDERING PROCEDURE EXAMPLE

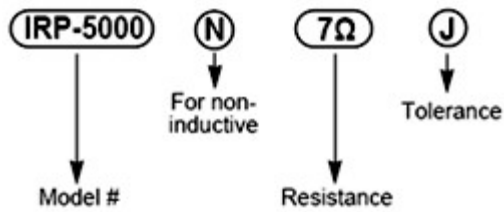

## LCA LOW COST RESISTOR ASSEMBLY



These economical and powerful components comprise two, three or four high power resistors housed in partial steel covers at each end. These rugged, powder coated covers ensure an excellent seal. The internal resistors use aluminum plates at each end instead of our standard cement molding. This innovation reduces construction time and reduces cost, at no reduction of performance. The major application of this exciting new model is highpower inverter braking units.

### GENERAL SPECIFICATIONS

MODEL	Internal Resistor Type	Power Rating in free air [W]	Resistance Range[ohms]	Resistance Tolerance
LCA 3.2K	IRV1600X2	1.0k	2.3 - 160	J[+-5%] K[+-10%]
LCA 4.0K	IRV2000X2	1.2k	3.0 - 220	
LCA 4.8K	IRV2400X2	1.3k	4.0 - 280	
LCA 5.6K	IRV2800X2	1.4k	4.5 - 270	
LCA 4.8K	IRV1600X3	1.3k	0.75 - 265	
LCA 6.0K	IRV2000X3	1.4k	1.0 - 330	
LCA 7.2K	IRV2400X3	1.5k	1.5 - 420	
LCA 9.6K	IRV2800X3	1.6k	1.5 - 390	
LCA 6.4K	IRV1600X4	1.7k	0.5 - 340	
LCA 8.0K	IRV2000X4	1.9k	0.75 - 440	
LCA 9.6K	IRV2400X4	2.1k	1.0 - 560	
LCA 11.2K	IRV2800X4	2.3k	1.1 - 520	

### CHARACTERISTICS

Values in [ ] mean change in ohmic value after test

Temperature Range	-55C - 275C	
Insulation Resistance	20Mohms min.	
Dielectric Strength	Available options: AC1500V, 3500V(Max. leakage current: 2mA)	
Temp. Coefficient	+- 260ppm/C max.	
Short Time Overload	+- [2%+0.05 ohms]	10 X Power rating 5 secs.
Moisture Resistance	+- [3%+0.05 ohms]	40C, 95% RH, DC100V case to terminal, 500hrs.
Thermal Shock	+- [2%+0.05 ohms]	Power rating 30min., -40C 15 min.
Vibration	+- [2%+0.05 ohms]	10Hz-55Hz-10Hz (1 min), 2hrs each direction.
Load life	+- [5%+0.05 ohms]	Power rating 1.5hrs on, 30min off, 500hrs.

## DIMENSIONS

Model	Weight [Kg]	Dimensions[mm]			
		L1+-5	L2+-3	W1+-2	W2+-2
LCA 3.2K	6.5	484	463	134	79
LCA 4.0K	7.5	554	533		
LCA 4.8K	8.5	634	613		
LCA 5.6K	10.0	704	683	204	140
LCA 4.8K	9.0	484	463		
LCA 6.0K	11.0	554	533		
LCA 7.2K	13.0	634	613		
LCA 9.6K	15.0	704	683	274	140
LCA 6.4K	12.0	484	463		
LCA 8.0K	14.0	554	533		
LCA 9.6K	16.5	634	613		
LCA 11.2K	19.0	704	683		

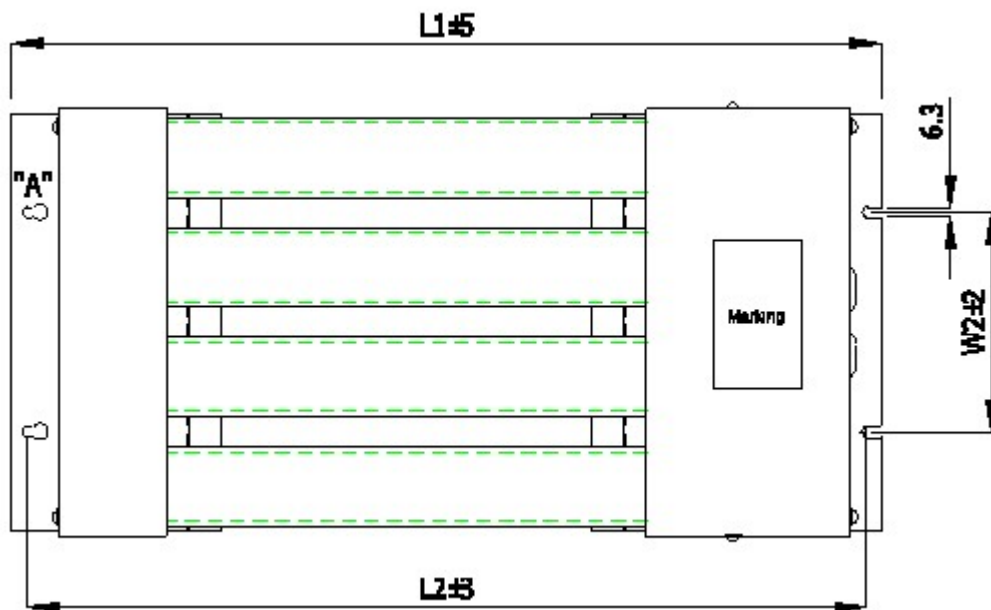
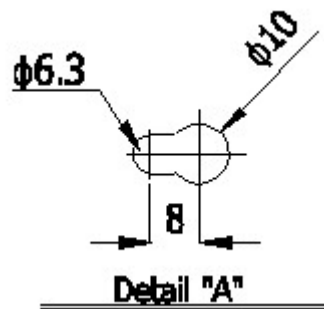

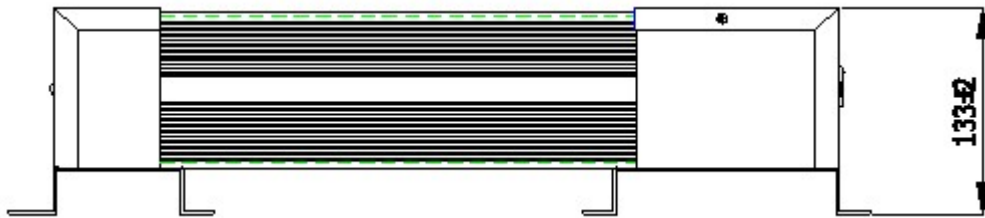
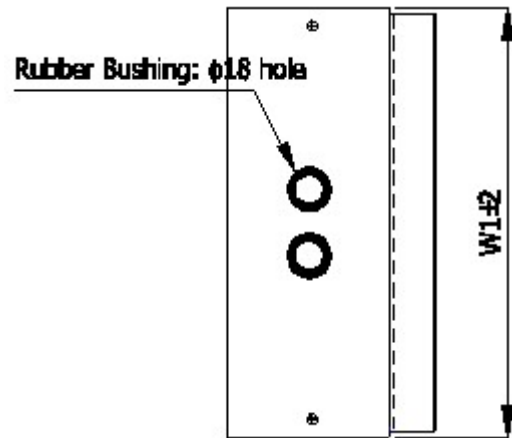

**ORDERING PROCEDURE EXAMPLE**

