

**Applications** Small control systems governed by non-extendable PLC bases with maximum 24 I/O



<b>Supply voltage</b>	~ 100...240 V	
<b>Discrete I/O</b>	14 or 20 I/O	10, 16 or 24 I/O
<b>Number of I/O</b>		
<b>Number of inputs</b>	8 or 12 inputs --- 24 V depending on model	6, 9 or 14 inputs --- 24 V depending on model
<b>Number of outputs</b>	6 or 8 relay outputs depending on model	4, 7 or 10 relay outputs depending on model
<b>I/O extension</b>		
<b>Control system functions</b>	Timers, up/down counters, word registers, shift bit registers, step counters, drum controllers	Real-time clocks (with 16 or 24 I/O), timers,
<b>Analogue I/O</b>		
<b>Integrate</b>		
<b>Modules with 1 channel</b>	1 input 0...10 V, ± 10 V, 4-20 mA	1 input 0...10 V
<b>Analogue extension modules</b>		
<b>Counting</b>	Fast counter (10 kHz maximum), frequency meter (10 kHz maximum) Up/down counter (1 kHz maximum) with 2 reflex outputs	
<b>Processing</b>	Combinational and sequential processing Processing on bits and words Processing on bit strings, word tables and indexed words	
<b>Communication</b>	Terminal port, RS 485 ASCII link or Uni-Telway master/slave link (depending on the model)	
<b>Language</b>	Reversible PL7 language, Instruction List language with Grafcet instructions and Ladder language	
<b>Programming</b>	FTX 117 terminal (Instruction List language) PL7-07 software under DOS compatible with Windows 95 and Windows NT (Instruction List and Ladder language)	
<b>Type of PLC</b>	TSX 07 3L 1428 TSX 07 3L 2028	TSX 07 32 1028 TSX 07 33 1628 TSX 07 33 2428
<b>Pages</b>	40050/12 and 40050/13	

Small control systems governed by extendable PLC bases with up to 48 I/O and up to 120 I/O when peer PLCs are used



≡ 24 V

9 inputs ~ 115 V 7 relay outputs	6, 9 or 14 inputs ≡ 24 V depending on model 4, 7 or 10 transistor outputs depending on model Negative logic	4, 7 or 10 relay outputs depending on model	4, 7 or 10 transistor outputs depending on model Positive logic
-------------------------------------	---	---	--

1 Nano PLC extension (16 or 24 I/O) or 1 Nano PLC base (10, 16 or 24 I/O)

up/down counters, word registers, shift bit registers, step counters, drum controllers

1 input and 1 output 0...10 V, ± 10 V, 4-20 mA	1 input 0...10 V, ± 10 V, 4-	1 input and 1 output 0...10 V, ± 10 V, 4-20 mA
---	---------------------------------	---

1 to 3 modules (3 inputs 0...10 V, ± 10 V, 0...20 mA, 4-20 mA and 1 output 0...10 V, ± 10 V, 0...20 mA, 4-20 mA)

Terminal port, RS 485 ASCII link or Uni-Telway master/slave link (depending on the model)  
Integrated RS 485 Modbus slave link or communication between PLCs (maximum 4 Nano PLCs with 10, 16 or 24 I/O, 200 m long)

for PC compatible

TSX 07 30 1028	TSX 07 31 1648	TSX 07 30 1008	TSX 07 30 1022	TSX 07 30 1012
TSX 07 31 1628		TSX 07 31 1608	TSX 07 31 1622	TSX 07 31 1612
TSX 07 31 2428		TSX 07 31 2408	TSX 07 31 2422	TSX 07 31 2412

40050/12 and 40050/13

### Presentation

Nano PLCs are very compact and offer a cost-effective replacement for traditional solutions while increasing application flexibility and ease of wiring.

Nano PLCs are available in 3 formats :

- Nano PLC bases with 10, 14, 16, 20 or 24 non-extendable I/O.
- Nano PLC bases with 10, 16 or 24 extendable I/O, which can be augmented with an I/O extension and up to 3 PLC extensions.
- Nano PLC extensions with 16 or 24 I/O which can be used to augment extendable Nano PLC bases (1 extension per base).

### Non-extendable Nano PLC bases



Nano PLCs with 10 I/O



Nano PLCs with 14/16 I/O

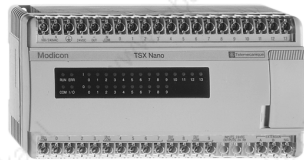

Nano PLCs with 20/24 I/O

Non-extendable Nano PLC bases will not accept any extension. They all have a ~ 100...240 V power supply, depending on the model :

- 10 I/O : 6 inputs + 4 outputs and 1 analogue input.
- 14 I/O : 8 inputs + 6 outputs.
- 16 I/O : 9 inputs + 7 outputs and 1 analogue input.
- 20 I/O : 12 inputs + 8 outputs.
- 24 I/O : 14 inputs + 10 outputs and 1 analogue input.

The following types of inputs and outputs are used :

- Inputs :  $\bar{\bar{}}$  24 V (sensor supply is not protected).
- Outputs : relay.

These PLCs incorporate extended communication : Uni-Telway master/slave link or ASCII link for transmission/reception.

Models with 16 and 24 I/O have a real-time clock.

### Extendable Nano PLC bases



Nano PLCs with 10 I/O



Nano PLCs with 16 I/O



Nano PLCs with 24 I/O or 16 I/O (~ inputs)

Nano PLCs, with  $\pm 24\text{ V}$  or  $\sim 100\text{...}240\text{ V}$  power supply, are available with three different I/O combinations :

- 10 I/O : 6 inputs + 4 outputs.
- 16 I/O : 9 inputs + 7 outputs.
- 24 I/O : 14 inputs + 10 outputs.

There are many types of I/O :

- Inputs :  $\pm 24\text{ V}$ ,  $\sim 115\text{ V}$ , analogue 0/10 V.
- Outputs : relay outputs, transistor outputs  $\pm 24\text{ V}/0.5\text{ A}$  (positive logic : load common at “-”), transistor outputs  $\pm 24\text{ V}/0.5\text{ A}$  (negative logic : load common at “+”).

Nano PLCs are programmed in lists of instructions using the FTX 117 programming terminal, in Ladder or Instruction list language using software on a PC compatible. Instruction list and Ladder programs are reversible on PC compatibles.

Nano PLCs are easy to set up and have numerous built in functions (EEPROM memory for storing programs, battery-backed RAM, real-time clocks for models with 16 and 24 I/O). They can be installed easily on a mounting rail or base plate, in a vertical or horizontal position.

### Nano PLC extensions



Nano PLC extensions with 16 I/O



Nano PLC extensions with 24 I/O

Nano PLC extensions can be used to augment extendable Nano PLCs using a single extension per base.

They all have a  $\sim 100\text{...}240\text{ V}$  or  $\pm 24\text{ V}$  power supply and, depending on the model :

- 16 I/O : 9 inputs + 7 outputs.
- 24 I/O : 14 inputs + 10 outputs.

The following types of inputs and outputs are used :

- Inputs :  $\pm 24\text{ V}$ .
- Outputs : relay outputs for models with  $\sim 100\text{...}240\text{ V}$  power supply, transistor outputs with positive logic for models with  $\pm 24\text{ V}$  power supply

Each extendable Nano base PLC **1** can be augmented using an I/O extension **2**, made up of one of the extendable Nano PLCs or a Nano extension. In addition, up to three PLC extensions **3**, **4** and **5** communicating via exchange words can be connected to the base PLC. Only the base PLC can receive an I/O extension.

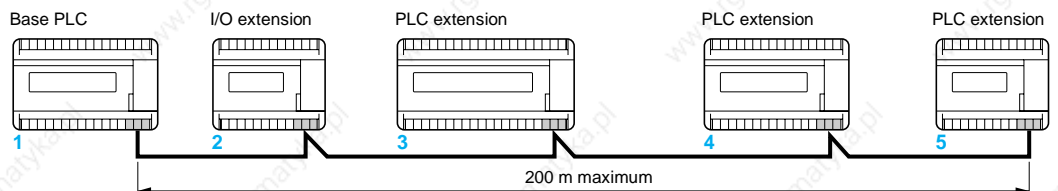

This extension link can be used exclusively as a Modbus slave link.

# Nano PLCs

## Nano PLCs bases

### Description

#### Non-extendable Nano PLCs

The front panels of **TSX 07 3L ●●28** non-extendable Nano PLCs comprise :

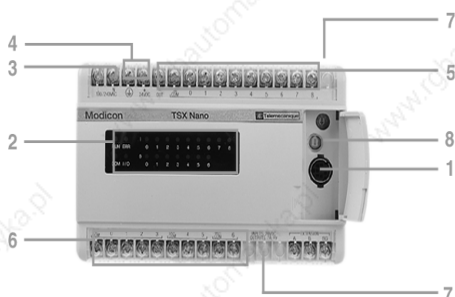

- 1 A port (1) for connecting a programming terminal (or Uni-Telway bus or serial link)
- 2 A display of :
  - inputs 0 to 7 or 0 to 11
  - outputs 0 to 5 or 0 to 7
  - PLC status (RUN, ERR, COM, I/O)
- 3 A mains power supply connection
- 4 A sensor power supply ( $\approx$  24 V/150 mA)
- 5 An input sensor connection
- 6 An output preactuator connection
- 7 A removable cover for protecting the screw terminal blocks
- 8 A potentiometer

#### Extendable Nano PLCs

The front panels of **TSX 07 30 10●●** extendable Nano PLCs with 10 I/O comprise :



- 1 A port (1) for connecting a programming terminal (or Uni-Telway bus or serial link)
- 2 A selector switch for coding the base/extension function
- 3 A potentiometer
- 4 A display of :
  - inputs 0 to 5 and outputs 0 to 3
  - PLC status (RUN, ERR, COM, I/O)
- 5 A mains power supply connection
- 6 A sensor power supply ( $\approx$  24 V/150 mA) on models with a  $\sim$  100...240 V supply
- 7 An input sensor connection
- 8 An output preactuator connection
- 9 An extension connection (I/O extension and/or PLC extension) or Modbus slave connection
- 10 A removable cover for protecting the screw terminal blocks

The front panels of **TSX 07 31 16/24●●** extendable Nano PLCs with 16/24 I/O comprise :



- 1 A port (1) for connecting a programming terminal (or Uni-Telway bus or serial link)
- 2 A selector switch for coding the base/extension function
- 3 Two potentiometers
- 4 A display of :
  - inputs 0 to 8 or 0 to 13 and outputs 0 to 6 or 0 to 9
  - PLC status (RUN, ERR, COM, I/O)
- 5 A mains power supply connection
- 6 A sensor power supply ( $\approx$  24 V/150 mA) on models with a  $\sim$  100...240 V supply
- 7 An input sensor connection
- 8 An output preactuator connection
- 9 An extension connection (I/O extension and/or PLC extension) or Modbus slave connection
- 10 A removable cover for protecting the screw terminal blocks

(1) Female 8-way mini-DIN type connector.

### Nano PLCs (with integrated analogue input)

The front panels of **TSX 07 32/33 ●●28** Nano PLCs with 10/16/24 I/O and 1 integrated analogue input comprise :

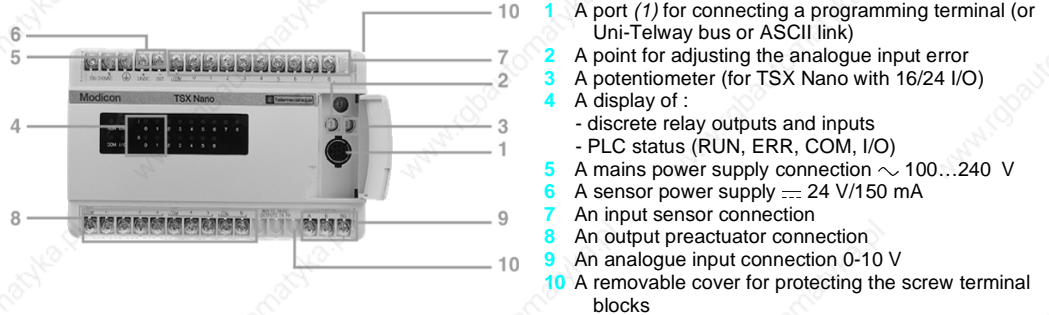

### Nano PLC extensions

The front panels of **TSX 07 EX ●●●●** Nano PLC extensions comprise :

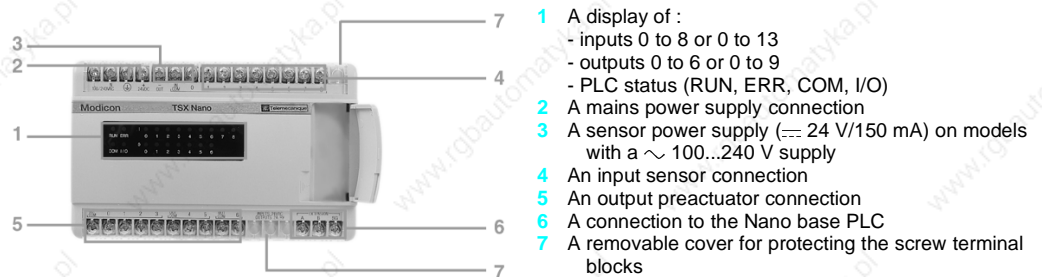

### Program loader

The TSX PGR LDR module is designed to simplify duplicating or updating applications on Nano and Micro PLCs without the need for a programming terminal. An application (in internal RAM) can be transferred from a PLC to the TSX PGR LDR module (and saved within it), then transferred from the TSX PGR LDR module to a PLC.

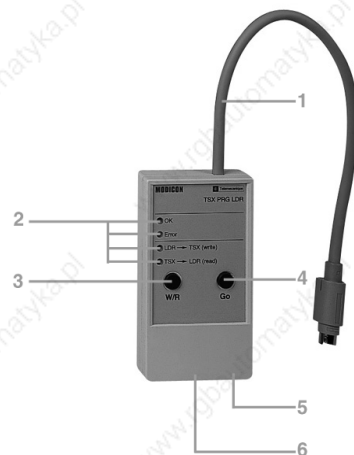

The front panel of the **TSX PGR LDR** module comprises :

- 1 A cord for connecting to the PLC programming port
- 2 Four operation indicator lights
- 3 A W/R button which selects the program transfer direction (PLC  $\rightarrow$  module or module  $\rightarrow$  PLC).
- 4 A GO button to start the transfer
- 5 A Write Only switch which prevents PLC  $\rightarrow$  module transfer
- 6 A Program Protect switch which protects the PLC application as read-only after the transfer

(1) Female 8-way mini-DIN type connector.

### Functions

#### I/O extension (1)

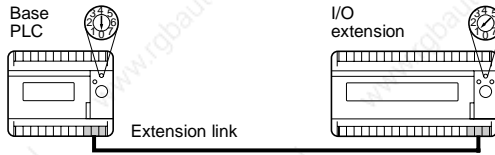

Each Nano base PLC can be extended using an I/O extension. This extension is created by one of the PLCs with 10, 16 or 24 I/O. The function of each PLC is defined by the position of the coding selector switch :

- Position 0 : base PLC
- Position 1 : I/O extension

The extension link cable between the base PLC and the I/O extension is a shielded, twisted pair and is no more than 200 metres long.

#### Peer PLCs (1)

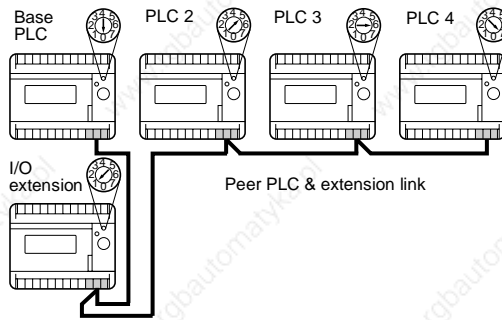

Up to 3 peer PLCs, communicating via common words, can be connected to the base PLC. In this case, only the base PLC can receive an I/O extension. The function of each PLC is defined by the position of the coding selector switch. I/O addressing of peer PLCs is identical to that of the base PLC.

The extension link cable between the base PLC and PLC extensions is a shielded, twisted pair and is no more than 200 metres long.

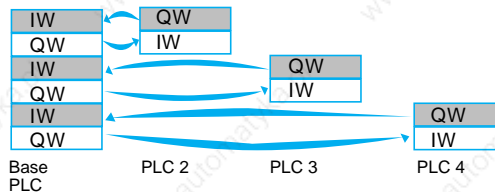

#### Inter-PLC communication

Each PLC has 2 reserved (IW) and 2 reserved (QW) words for exchanging data between PLCs. These exchange words are updated automatically. For each PLC, the user program is only able to :

- Write to the 2 %QW output words
- Read the 2 %IW input words

#### Displaying the I/O, internal bits and PLC status

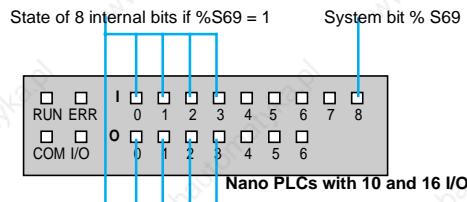

The results of the self-tests performed continuously by the base PLC, peer PLCs and I/O extensions are displayed on the front panel by 4 indicator lamps :

- RUN : PLC status
- ERR : internal fault
- COM : data exchange on the extension link
- I/O : I/O fault

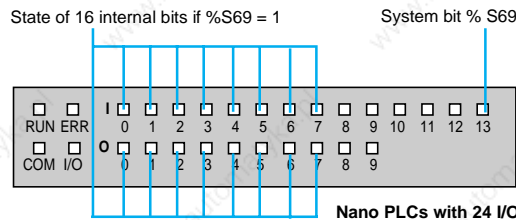

#### I/O display

The state of each I/O is displayed on the front panel of the PLC by an indicator lamp : when the lamp is on, the I/O is active, when the lamp is off, the I/O is inactive.

#### Internal bits display

When the PLC system bit %S69 is set to 1, the first indicator lamps show the state of 8 or 16 defined internal bits (%M120...%M127 or %M112...%M127).

#### Dedicated I/O

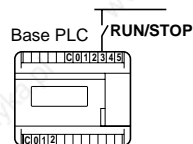

The RUN/STOP input will launch or stop program execution from an external order. After configuration, one of the first 6 inputs (%I0.0 to %I0.5) can be assigned to this function. One of the first 4 outputs (%Q0.0 to %Q0.3) can be configured to indicate to the user that the PLC program is not running (STOP or fault).

(1) TSX 07 30/31 PLCs can no longer receive an I/O extension or peer PLC when the integrated Modbus link is in use. TSX 07 32/33 ●●28 and TSX 07 3L ●●28 PLCs cannot take an I/O extension or peer PLC.

### Real-time based programming

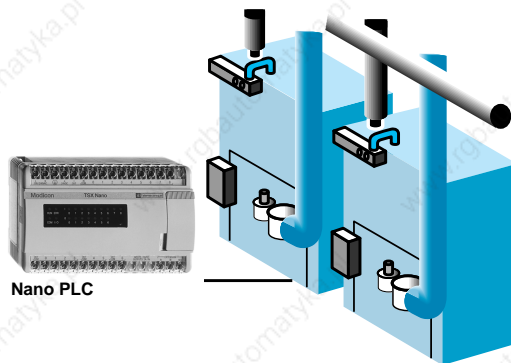

Nano PLC

Nano PLCs with 16 or 24 I/O integrate 16 user-definable real-time clocks which can be used to :

- Control the outputs directly (opening and closing electrical circuits) or act on the user program according to the time (month, day, hour and minute).
- Program time setpoints which can be modified via an operator panel or calculated by the program.
- Program event time-stamping or perform time calculations.

### Analogue I/O

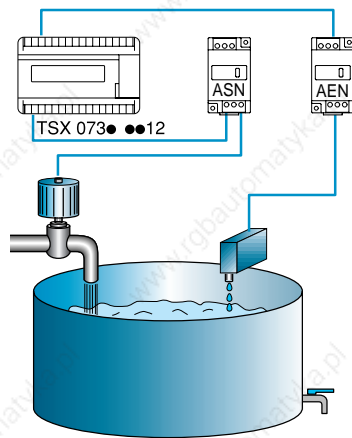

Nano PLC

The Nano PLC is designed for simple process control applications (level, temperature, flow rate control, etc) with speed controller or servo-valve control.

TSX AEN/ASN modules are used with Nano PLCs to process 1 analogue input and 1 analogue output respectively :

- The input module, 0/10 V - 10/+ 10 V or 4/20 mA is connected to the  $\approx 24$  V input %I0.0 of the PLC and is configured in frequency meter mode.
  - The output module, 0/10 V - 10/+ 10 V or 4/20 mA uses the pulse width modulation transistor output %Q0.0.
- Analogue processing is also possible using three TSX 07 32/33  $\bullet\bullet$ 28 bases which consist of 1 analogue input 0-10 V.

### High-speed processing applications

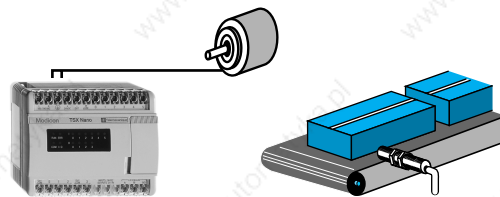

Nano PLC

On a base PLC or peer PLC, each of the first 6 inputs (%I0.0 to %I0.5) can be assigned to the latching function after configuration. This function is used to take account of input pulses with short durations, 100  $\mu$ s minimum.

Nano PLCs include standard functions which are easy to set up and can be used for adaptation to control systems requiring counting capacity or short response times :

- Fast counter (maximum frequency 10 kHz)
- Fast up/down counter (maximum frequency 1 kHz)
- Frequency meter (maximum frequency 10 kHz)

Sensors which are used on the up/down counter inputs (%I0.0 and %I0.3) must have solid state outputs.

2 reflex outputs (%Q0.1 and %Q0.2) are controlled directly by the fast counter (without waiting for outputs to be updated at the end of the scan) according to a matrix predefined during configuration.

### Pulse outputs

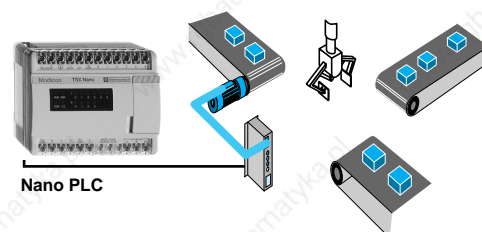

Nano PLC

After configuration, the first output %Q0.0 (if it is a transistor output) of the Nano PLC can be used with :

- The **PWM** software function, as a pulse width modulation output at a predefined frequency of up to 4.9 kHz designed for use in applications with light or sound intensity control (dimmer function).
- The **PULSE** software function, as a pulse generator output of up to 4.9 kHz designed for use for controlling stepper motors.



### Uni-Telway communication

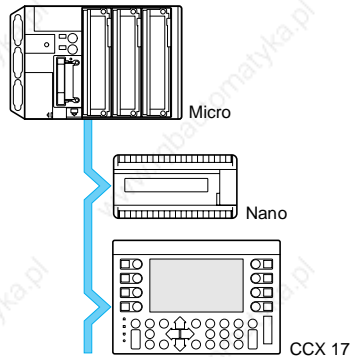

The Nano PLC can communicate with other Uni-Telway devices via the terminal port : speed -controllers, operator terminals, compact or modular PLCs. The ability to send and receive messages means that Nano PLCs can be integrated in distributed architectures. In slave mode, for example, the Nano PLC can initiate communication and send updated variables to the bus master (local reflex processing).

28 Nano slave PLCs can be connected to the Uni-Telway bus over a distance of 1 km (isolated for speeds of 1.2 to 9.6 K bits/s).

### Modbus slave communication

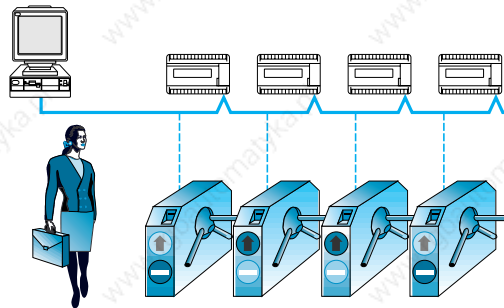

Nano PLCs have an RS 485 serial link extension port, supporting the Modbus protocol (depending on the model). It is used to perform the following requests :

- Read/write bits and words
- Read PLC status (via Uni-TE request)
- Set to RUN or STOP mode (via Uni-TE request)
- Initialise the PLC (via Uni-TE request)

Up to 28 Nano PLCs can be connected over a distance of 200 m for user-definable speeds of 1.2 to 19.2 K bits/s.

### ASCII communication

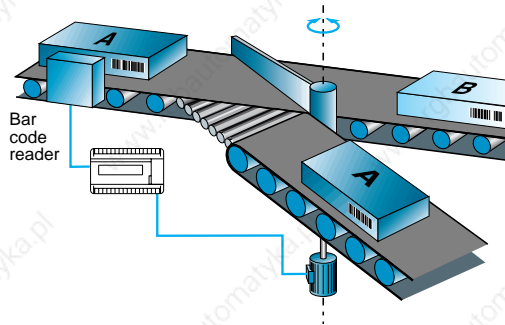

The ability to send and receive characters enables the Nano PLC to communicate in point-to-point mode with a large number of ASCII devices, such as PCs (directly or via modem), printers, bar code readers, etc.

Frame speed and format can be configured. Connection to the Nano PLC terminal port is via an RS 232/485 converter cable powered by the PLC.

### Modem application (Modbus or Uni-Telway protocol)

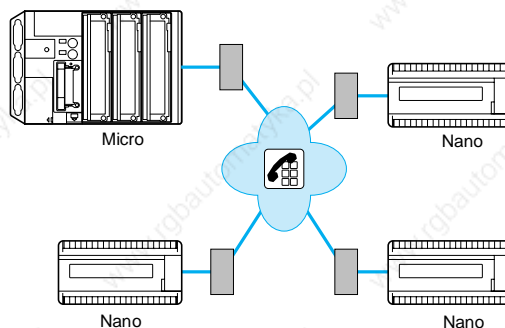

A PLC fitted with a Modbus or Uni-Telway master module interrogates Nano PLCs via the switched telephone net-work.

When connected to a Modem in RS 485 mode, the master can use the link to generate dialling sequences for remote sites.

Each Nano PLC responds to requests from the master, but is also able to trigger a call by activation of a discrete input on the Modem.

Target applications (with Modbus or Uni-Telway) :

- System teleprocessing
- Telemonitoring of remote sites
- Water, energy, environment control

The Uni-Telway slave link of Nano PLCs can also be used for:

- Up/down loading programs
- Programming and remote diagnostics

Environment				
<b>Conforming to standards</b>			IEC 1131-2, IEC 664, UL 508, UL 746 C, UL 94, CSA 22-2 no. 142, EN 50081/class B	
<b>Temperature</b>	Operation	°C	0...+ 60	
	Storage	°C	- 25...+ 70	
<b>Humidity</b>	Without condensation	%	5...95	
<b>Altitude</b>		m	0...2000	
<b>Vibration resistance</b>			Conforming to IEC 68-2-6 FC tests	
<b>Mechanical shock resistance</b>			Conforming to IEC 68-2-27 EA tests	
Power supply characteristics				
<b>Type of PLC</b>			TSX 07 30/31/32/33 ●●●●, TSX 07 3L ●●28, TSX 07 EX ●●28	
			TSX 07 31 ●●●●, TSX 07 EX ●●12	
<b>Supply voltage</b>	Nominal	V	~ 100...240	
	Limit	V	85...264	
<b>Frequency</b>	Nominal	Hz	50/60	
	Limit	Hz	47...63	
<b>Power required</b>			≤ 30 VA	
<b>Sensor protected power supply</b>		V	24/150 mA	
<b>Primary/earth isolation</b>		Vrms	2000/50-60 Hz	
<b>Microbreaks</b>		ms	≤ 10	
			≤ 1	
Discrete input characteristics				
<b>Type of input</b>		V	≡ 24 (resistive)	
			~ 115 (capacitive)	
<b>Nominal input values</b>	Voltage	V	≡ 24	
	Current	mA	7	
	Sensor supply	V	≡ 19.2...30 (including ripple)	
<b>Limit input values</b>	At state 1	Voltage	V	≥ 11
		Current	mA	≥ 2.5 for 11 V
	At state 0	Voltage	V	≤ 5
		Current	mA	≤ 1.2
<b>Logic</b>			Positive or negative depending on wiring	
<b>Filter time</b>			12 ms, 3 ms or 100 μs (on I0.0 to I0.7)/375 μs (on I0,8 to I0,13)	
<b>Isolation</b>	Between groups of I/O points	Vrms	1500/50-60 Hz	
	Type		Optoelectronic module	

### Discrete output characteristics

Type of output			Relay	Transistor, positive logic	Transistor, negative logic
Output description			1 normally open contact	Protected	Non-protected
Loads (nominal values)	Voltage	<b>V</b>	~ 24...220	≡ 24	≡ 24
	Nominal current	<b>A</b>	–	0.5	0.5
	Tungsten lamp	<b>W</b>	–	≤ 10	≤ 10
≡ loads	Voltage	<b>V</b>	24	19.2...30	19.2...30
	Current	<b>A</b>	DC-12 : 1-24 V (0.3 x 10 <sup>6</sup> op. cycles) DC-13 : 0.4-24 V (1 x 10 <sup>6</sup> op. cycles)	0.625 (at 30 V) common to “-” loads	0.625 (at 30 V) common to “+” loads
~ loads	AC-12 resistive duty	<b>A</b>	1-110/220 V (0.5 x 10 <sup>6</sup> op. cycles) 0.5-110/220 V (2 x 10 <sup>6</sup> op. cycles) 1-48 V (0.5 x 10 <sup>6</sup> op. cycles) 2-24 V (0.3 x 10 <sup>6</sup> op. cycles) 1-24 V (0.5 x 10 <sup>6</sup> op. cycles)	–	–
	AC-15 inductive duty	<b>A</b>	0.22-220 V (1 x 10 <sup>6</sup> op. cycles) 0.5-24/48/110 V (1 x 10 <sup>6</sup> op. cycles) 1-24 V (0.2 x 10 <sup>6</sup> op. cycles)	–	–
Response time	State 0 to 1	<b>ms</b>	≤ 5	≤ 1	≤ 1
	State 1 to 0	<b>ms</b>	≤ 10	≤ 1	≤ 1
Leakage current	At state 0	<b>mA</b>	–	≤ 1	≤ 1
Voltage drop	At state 1	<b>V</b>	–	≤ 2 (for I = 0.5 A)	≤ 1.5 (for I = 0.5 A)
Built-in protection	Overloads and short-circuits		None (fit one fuse per I/O point or group of I/O points)	Yes	None (fit a fuse on the preactuator common)
	Overt Voltages		None (fit RC or GMOV peak limiter circuit for ~ and a freewheel diode for ≡)	Yes	Yes
	Polarity inversions		–	Yes	Yes

### Integrated analogue input characteristics

Type of PLC		<b>TSX 07 32/33 ●●28</b>
Analogue input	Number of points	1
	Input range	<b>V</b> 0...10
	Input impedance	<b>kΩ</b> 16...18
	Max. voltage without destruction	<b>V</b> ± 16
	Type of protection	Against short-circuits
Conversion	Method	Successive approximations
	Resolution	8 bits
	Conversion time	PLC scan time
	Precision at 25 °C	<b>% FS</b> ± 0.8
	at 60 °C	<b>% FS</b> ± 2
	Drift	0.34 % per 10 °C
Repeatability	<b>V</b> ± 0.8 % of 0 to 60 °C (at full scale)	
Isolation	Analogue input and processor	<b>V</b> None
Wiring distance with shielded cable	Isolated sensor	<b>m</b> 30 max.
	Non-isolated sensor	<b>m</b> 10 max.

Modbus characteristics				
Type of PLC	TSX 07 30/31 ●●●●			
Structure	Description	Heterogeneous industrial bus		
	Physical interface	RS 485 non-isolated		
	Method of access	Master/slave type		
Transmission	Mode	Asynchronous in base band, RTU/ASCII frame		
	Bit rate	1.2 K bits/s to 19.2 K bits/s		
	Medium	Double shielded twisted pair		
Configuration	Number of devices	28 devices maximum, 98 link addresses maximum		
	Bus length	200 m maximum		
	Drop cable	15 m maximum		
Available Modbus/Jbus slave functions	Code	Description	Code	Description
	01	Reading of n consecutive output bits	05	Writing of 1 output bit
	02	Reading of n consecutive input bits	06	Writing of 1 output word
	03	Reading of n consecutive output words	15	Writing of n output bits
	04	Reading of n consecutive input words	16	Writing of n output words
Services	Sending requests	Bits : 120 bits maximum per request Words : 120 words maximum per request		
	Safety	One CRC 16 check parameter on each frame		
	Monitoring	Diagnostics counters, event counters		

### ASCII asynchronous serial link characteristics

Type of PLC	TSX 07 30/31/32/33 ●●●●, TSX 07 3L ●●●●		
Physical layer	Terminal port	RS 485 non-isolated Half-duplex (10 m max)	
	Flow rate	1.2 K bits/s to 9.6 K bits/s	
Transmission	Type	Point-to-point, without flux control (Xon-Xoff, RTS/CTS)	
	Data	7 or 8 bits	
	Stop bit	1 or 2 bits	
	Parity bit	Even, odd or no parity	
Services	120 character messages	Transmission/reception	

### Uni-Telway integrated link characteristics (general characteristics, see page 43594/2)

Type of PLC	TSX 07 30/31/32/33 ●●●●, TSX 07 3L ●●●●		
Structure	Physical interface	RS 485 terminal port Half-duplex non-isolated	
	Bit rate	1.2 to 9.6 K bits/s	
	Functions	Master/slave	
Configuration	Number of devices	Master : 3 devices maximum (5 link addresses maximum) Slave : 28 devices maximum (96 link addresses max.)	
	Bus length	10 m max, 1000 m when using the <b>TSX P ACC 01</b> terminal port cable connector	
Services	Uni-TE server	Writing or reading Nano master data after a request is sent by a connected client device	
		Reception of messages from all devices on the bus (master or slave), 128 bytes maximum	
	Uni-TE client (master function)	Sending requests (128 bytes maximum) to all slave devices on the bus	
Uni-TE client (slave function)	Sending messages to every device on the bus (master or slave), 128 bytes maximum		

### Non-extendable Nano PLC bases

These bases will not accept any extension. They incorporate extended communication : Uni-Telway master/slave link or ASCII link for transmission/reception.

24 V/150 mA sensor power supply is not protected.

Number of I/O	Inputs	Relay outputs	Transistor outputs	Reference (1)	Weight kg
<b>~ 100...240 V power supply</b>					
14	8 I 24 V	6 O	–	<b>TSX 07 3L 1428</b>	0.320



TSX 07 3L 1428

20	12 I 24 V	8 O	–	<b>TSX 07 3L 2028</b>	0.340
----	-----------	-----	---	-----------------------	-------



TSX 07 3L 2028

### Extendable Nano PLC bases

These Nano PLC bases are used as base PLCs (1 per configuration), as I/O extensions (maximum 1 per configuration) or as peer PLCs (maximum 3 per configuration). They integrate an extended communication function : Uni-Telway master/slave link or ASCII link in transmission/reception and Modbus slave link.

Number of I/O	Inputs	Relay outputs	Transistor outputs 24 V/0.5 A	Reference (1)	Weight kg
<b>24 V power supply</b>					
10	6 I 24 V	4 O	–	<b>TSX 07 30 1022</b>	0.290



TSX 07 00 1002

–	–	–	4 O protected, positive logic	<b>TSX 07 30 1012</b>	0.270
---	---	---	-------------------------------	-----------------------	-------

16	9 I 24 V	7 O	–	<b>TSX 07 31 1622</b>	0.350
----	----------	-----	---	-----------------------	-------



TSX 07 01 1602

–	–	–	7 O protected, positive logic	<b>TSX 07 31 1612</b>	0.325
---	---	---	-------------------------------	-----------------------	-------

24	14 I 24 V	10 O	–	<b>TSX 07 31 2422</b>	0.400
----	-----------	------	---	-----------------------	-------

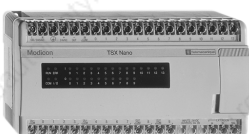

TSX 07 01 2402

–	–	–	10 O protected, positive logic	<b>TSX 07 31 2412</b>	0.370
---	---	---	--------------------------------	-----------------------	-------

(1) Multilingual quick reference guide included as standard (English, French, German, Italian and Spanish).

### Extendable Nano PLC bases (continued)

Number of I/O	Inputs	Relay outputs	Transistor outputs 24 V/0.5 A	Reference (1)	Weight kg
<b>~ 100...240 V power supply</b>					
10	6 I $\overline{\text{---}}$ 24 V	4 O	–	<b>TSX 07 30 1028</b>	0.300
		–	4 O unprotected, negative logic	<b>TSX 07 30 1008</b>	0.280
16	9 I $\overline{\text{---}}$ 115 V 9 I $\overline{\text{---}}$ 24 V	7 O	–	<b>TSX 07 31 1648</b>	0.390
		7 O	–	<b>TSX 07 31 1628</b>	0.360
		–	7 O unprotected, negative logic	<b>TSX 07 31 1608</b>	0.335
24	14 I $\overline{\text{---}}$ 24 V	10 O	–	<b>TSX 07 31 2428</b>	0.410
		–	10 O unprotected, negative logic	<b>TSX 07 31 2408</b>	0.380



TSX 07 16 16



TSX 07 16 24 / TSX 07 21 1648



TSX 07 33 1628

### Nano PLC bases (with an integrated analogue input) (2)

Number of I/O	Inputs	Relay outputs	Integrated analogue input	Reference (1)	Weight kg
<b>~ 100...240 V power supply</b>					
10	6 I $\overline{\text{---}}$ 24 V	4 O	1 I x 0...10 V	<b>TSX 07 32 1028</b>	0.290
16	9 I $\overline{\text{---}}$ 24 V	7 O	1 I x 0...10 V	<b>TSX 07 33 1628</b>	0.290
24	14 I $\overline{\text{---}}$ 24 V	10 O	1 I x 0...10 V	<b>TSX 07 33 2428</b>	0.290

### Nano PLC extensions

These extensions can be used to augment extendable Nano PLC bases at minimum cost (maximum 1 extension per base).

Number of I/O	Inputs	Relay outputs	Transistor outputs 24 V/0.5 A	Reference (1)	Weight kg
<b><math>\overline{\text{---}}</math> 24 V power supply</b>					
16	9 I $\overline{\text{---}}$ 24 V	–	7 O protected, positive logic	<b>TSX 07 EX 1612</b>	0.325
24	14 I $\overline{\text{---}}$ 24 V	–	10 O protected, positive logic	<b>TSX 07 EX 2412</b>	0.370
<b>~ 100...240 V power supply</b>					
16	9 I $\overline{\text{---}}$ 24 V	7 O	–	<b>TSX 07 EX 1628</b>	0.360
24	14 I $\overline{\text{---}}$ 24 V	10 O	–	<b>TSX 07 EX 2428</b>	0.410



TSX 07 EX 16



TSX 07 EX 24

(1) Multilingual quick reference guide included as standard (English, French, German, Italian and Spanish).

(2) TSX 07 32/33 1628 PLCs do not have I/O extension and/or PLC extension links or the Modbus slave link.



TSX PRG LDR



TSX P ACC 01

### Separate parts

Description	Use with	Length	Reference	Weight kg
<b>Program loader with programming port connecting cable</b>	Simplifies duplicating or updating applications (program and constants in internal RAM)	0.3 m	<b>TSX PRG LDR</b>	0.150
<b>Input simulator</b> = 24/~/ 115 V	Nano PLC with 10 I/O	–	<b>TSX 07 SIM 06</b>	0.050
	Nano PLC with 16 I/O	–	<b>TSX 07 SIM 09</b>	0.070
	Nano PLC with 24 I/O	–	<b>TSX 07 SIM 14</b>	0.080
<b>Connecting cables</b> between Nano PLC bases	I/O extension	0.3 m	<b>TSX CA0 003</b>	0.015
	PLC extension	50 m	<b>TSX STC 050</b>	1.710
		200 m	<b>TSX STC 200</b>	6.790

<b>Connecting cable for Modem (DCE)</b>	Nano PLC terminal port connection to the Modem device (with 25-way male SUB-D connector)	2,5 m	<b>TSX PCX 1130</b>	0.240
<b>Terminal port cable connector</b>	Isolation of Uni-Telway signals for distances > 10 m and < 1 km, line termination, bus drop cable	1 m	<b>TSX P ACC 01</b>	0.690

Description	Composition	Reference	Weight kg
<b>Self-instruction cases (1)</b>	1 Nano PLC (16 I/O), 1 Input simulator and 1 FTX 117	<b>TSX SDC 07 30 117</b>	0.950
	1 Nano PLC (16 I/O), 1 input simulator and software under DOS for FT 210032	<b>TSX SDC 07 30 DSF</b>	0.600
	1 Nano PLC (16 I/O), 1 input simulator and software under DOS for PC compatible	<b>TSX SDC 07 30 DSP</b>	0.600

(1) Multilingual quick reference guide included as standard (english, french, german, italian and spanish).

### Dimensions

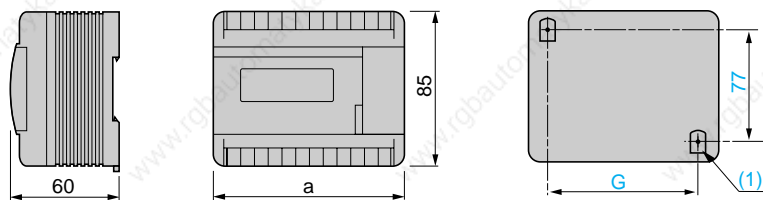

	a	G
TSX 07 3● 10●●	105	86
TSX 07 3● 16●●, TSX 07 3L 1428	135	116
TSX 07 3● 24●●, TSX 07 31 1648, TSX 07 3L 2028	165	146

(1) 2 knock-outs  $\varnothing 4$

### Mounting

By clicking onto 35 mm DIN rail, or by screwing onto panel using  $\varnothing M3$  screws

Mounting

Removal

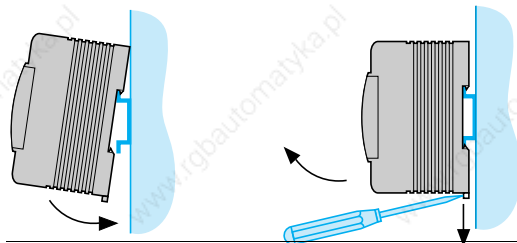

### Mounting positions on vertical plane

Possible mounting positions

Incorrect mounting position

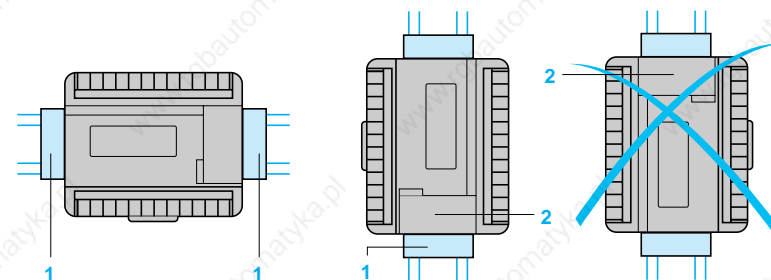

1 End stop AB1-AB8P35

2 Access cover

### Installation rules

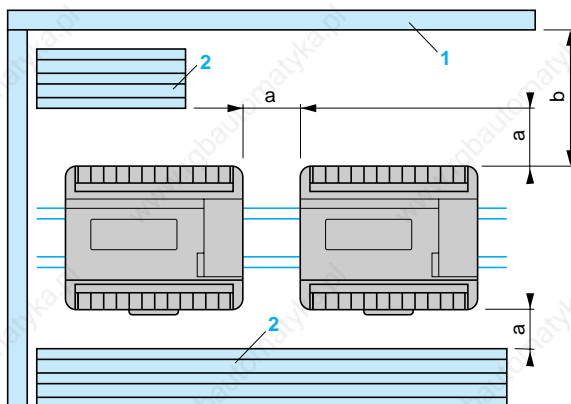

1 Switchgear, enclosure or machine frame

2 Cable ducting or clips

$a \geq 20$  mm

$b \geq 40$  mm

**Warning :** Avoid placing heat generating devices (transformers, power supplies, contactors, etc) beneath the Nano PLC.



**Power supply = 24 V, 6, 9 or 14 inputs = 24 V**

**TSX 07 30/31 ●●●2, TSX 07 EX ●●●12**  
Positive logic

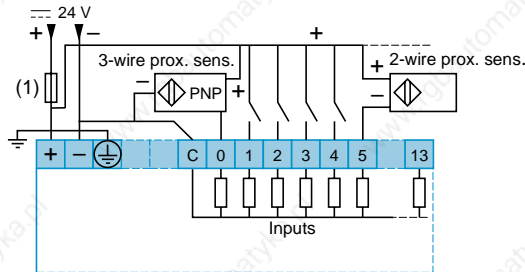

**Negative logic**

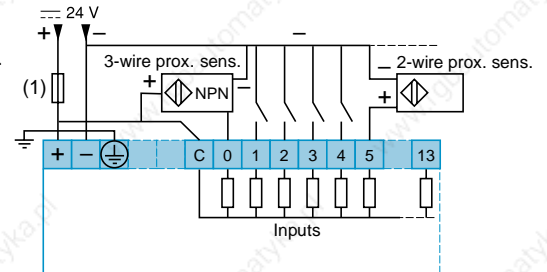

**Power supply ~ 100/240 V, 6, 8, 9, 12 or 14 inputs = 24 V**

**TSX 07 30/31 ●●●8, TSX 07 32/33 ●●●8, TSX 07 EX ●●●28, TSX 07 3L●●28**  
Positive logic

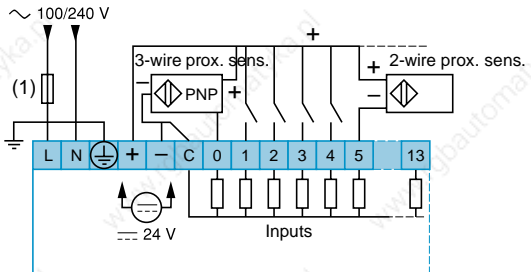

**Negative logic**

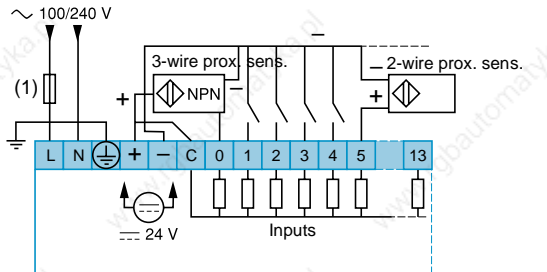

**Power supply ~ 100/240 V, 9 inputs ~ 115 V**

**TSX 07 31 1648**

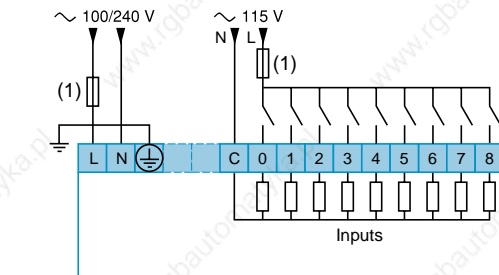

**Analogue input**

**TSX 07 32 1028/33 ●●28**

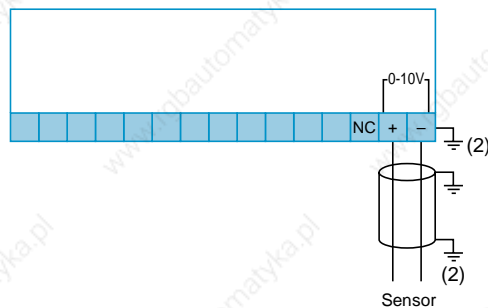

(1) 3 A fuse.  
(2) Earth connection required for non-isolated sensor.

# Connection of relay outputs Nano PLCs

## Nano PLCs bases

Power supply  $\equiv$  24 V or  $\sim$  110...220 V (1)

TSX 07 30 1022/1028, TSX 07 32 1028

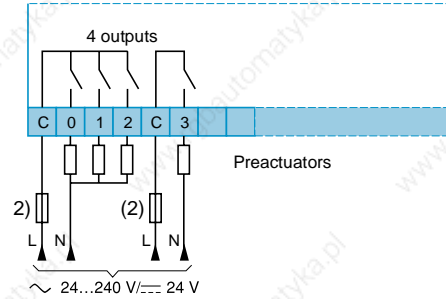

TSX 07 3L 1428

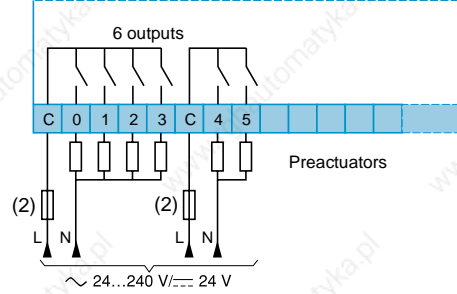

TSX 07 31 1622/1628, TSX 07 33 1628, TSX 07 EX 1628

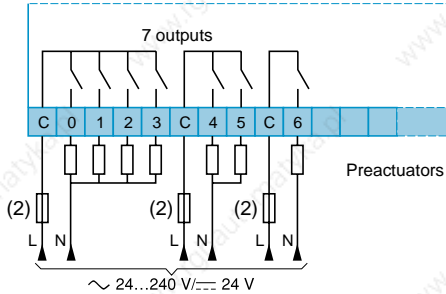

TSX 07 3L 2028

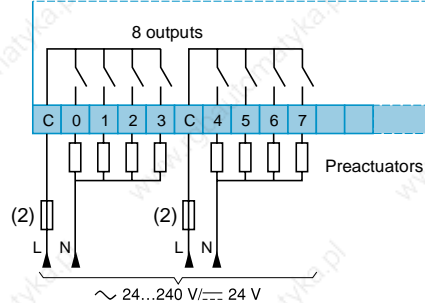

TSX 07 31 2422/2428, TSX 07 33 2428, TSX 07 EX 2428

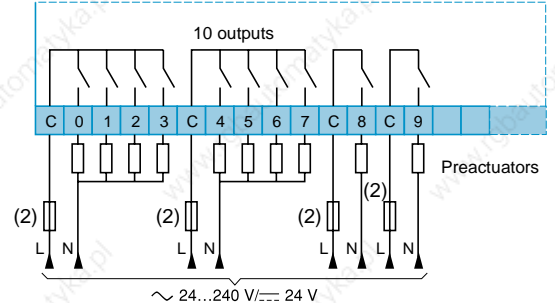

Power supply  $\sim$  110...220 V (1)

TSX 07 31 1648

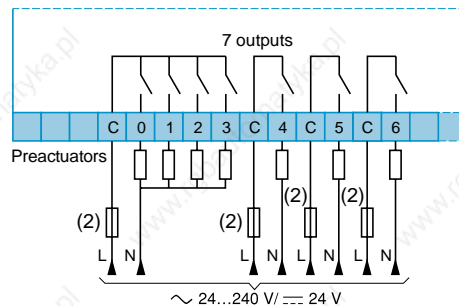

(1) Provide an inductive overload protection device at the load terminals and for each output : an RC or GMOV type peak limiter circuit for  $\sim$ , a flywheel diode for  $\equiv$ .  
 (2) Fuse rated for load.

**Power supply  $\approx 24\text{ V}$ , positive logic transistor outputs**

**TSX 07 30 1012**

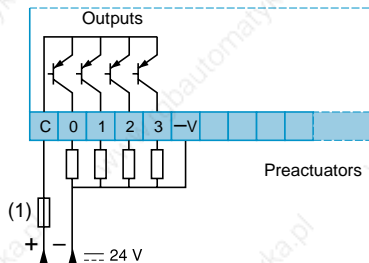

**TSX 07 31 1612, TSX 07 EX 1612**

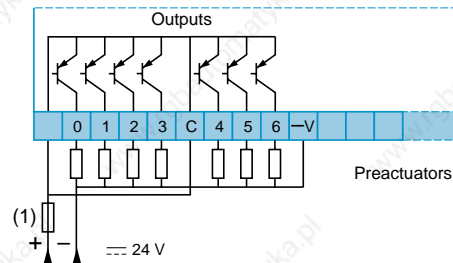

**TSX 07 31 2412, TSX 07 EX 2412**

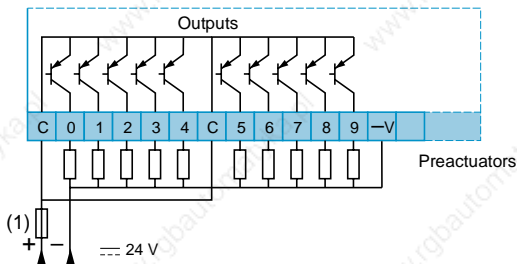

**Power supply  $\approx 24\text{ V}$ , negative logic transistor outputs**

**TSX 07 30 1008**

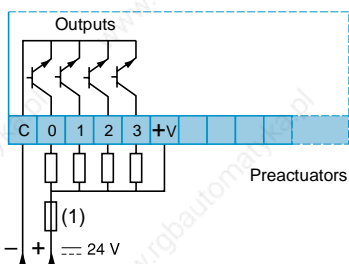

**TSX 07 31 1608**

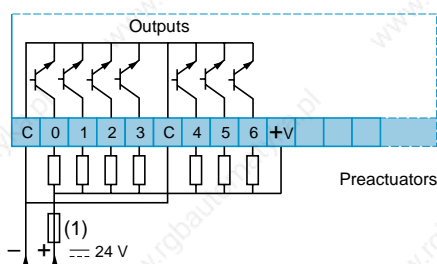

**TSX 07 31 2408**

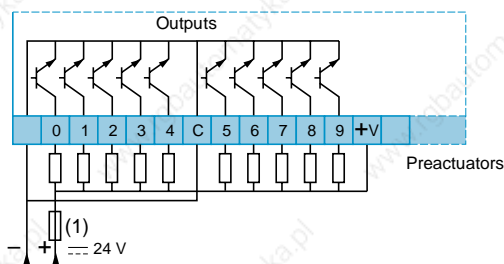

(1) Fuse rated for load.

**Connection of extensions**

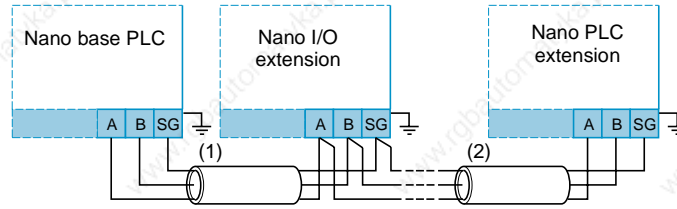

- (1) TSX CA0 003 cable (0.3 m long) or shielded twisted pair cable.  
 (2) Remote location (200 m max) of Nano PLC extensions requires either :
- TSX STC 050 cable (50 m long) or TSX STC 200 (200 m long), or
  - Shielded twisted pair cable with the following main characteristics :
    - Mechanical characteristics : tinned copper core, 18 to 24 gauge with tinned copper shielding
    - Electrical characteristics : load resistance per unit length of one wire :  $\leq 85 \Omega/\text{km}$ , load resistance per unit length of shielding :  $\leq 12 \Omega/\text{km}$

**Connection of Modbus bus**

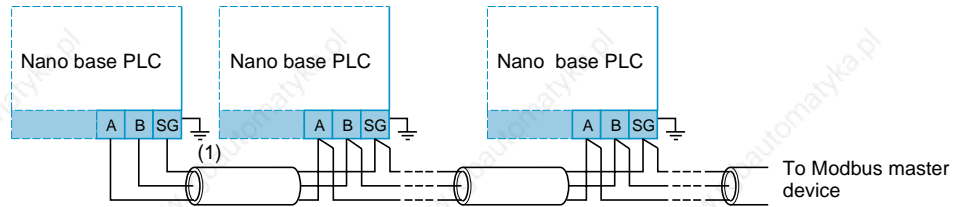

(1) Shielded twisted pair cable

**Connection of Uni-Telway bus**

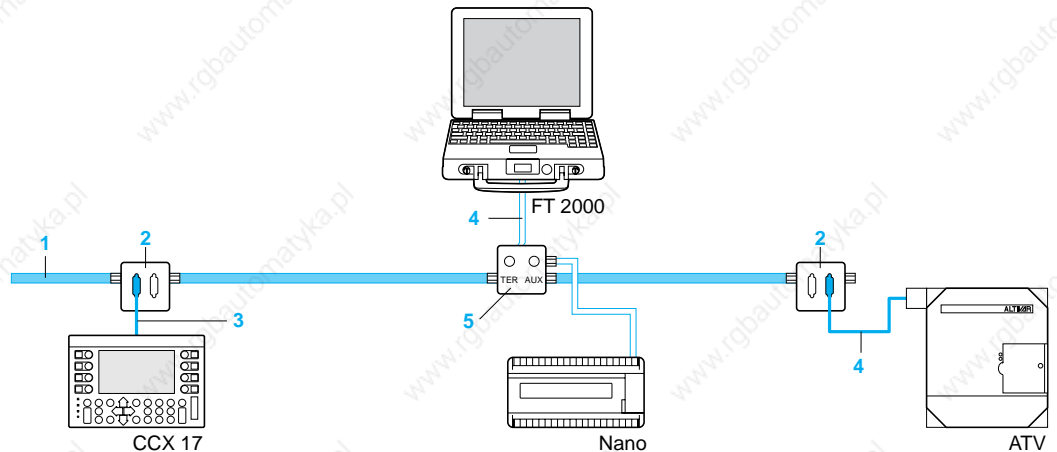

- 1 **TSX CSA ●●●** : bus cable, double twisted shielded pair. The shielding must be taken to earth at each device.
- 2 **TSX SCA 62** : passive 2-channel subscriber socket (see page 43594/5).
- 3 **XBT-Z908** : connecting cable between the CCX 17 operator panel and the TSX SCA 62 subscriber socket (see page 43594/5).
- 4 **TSX PCU 1030** : Uni-Telway connecting cable between the PC compatible FT 2000 terminal and the TER port of Nano PLCs or TSX P ACC 01 connectors.  
**T FTX CBF 020** : Uni-Telway connecting cable between the FTX 517 terminal and the TER port of Nano PLCs or TSX P ACC 01 connectors.
- 5 **TSX P ACC 01** : cable connector from a Nano PLC to the Uni-Telway bus via the PLC terminal port. The connecting cable (1 m long) is integrated in the cable connector. It isolates signals (over a distance > 10 m) and adapts line termination impedance. It is also used to select the terminal port (Uni-Telway master/slave or character mode).

### Presentation

TSX AMN analogue I/O extension modules have 3 analogue inputs and 1 analogue output which can be configured for voltage or current :

- TSX AMN 4000 : with  $\sim$  100/240 V power supply.
- TSX AMN 4001 : with  $\equiv$  24 V power supply.

It is possible to use up to 3 modules as an extension to the Nano PLC base. They communicate with the base PLC via exchange words.

### Description

The front panels of TSX AMN analogue I/O extension modules comprise :

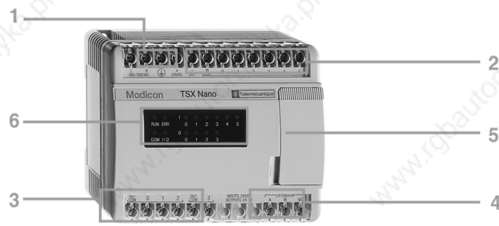

- 1 A mains power supply connection terminal block.
- 2 An analogue input connection terminal block.
- 3 An analogue output connection terminal block.
- 4 A PLC extension connection terminal block.
- 5 A selector switch for coding the extension number.
- 6 A display block with 4 LEDs :
  - RUN : PLC status
  - ERR : internal fault
  - COM : exchanges on the extension link
  - I/O : external faults

### Characteristics

#### Input characteristics

Type of module			TSX AMN 4000	TSX AMN 4001
<b>Analogue input</b>	Number of channels		3	
	Input range		0...10 V, $\pm$ 10 V, 0...20 mA, 4-20 mA	
	Input impedance		125 $\Omega$ in current, 100 K $\Omega$ in voltage	
	Max. voltage without damage		$\pm$ 7.5 V in current, $\pm$ 30 V in voltage	
<b>Power supply</b>	Nominal voltage	<b>V</b>	$\sim$ 100...240 (50/60 Hz)	$\equiv$ 24
	Limit voltage	<b>V</b>	$\sim$ 85...264 (50/60 Hz)	$\equiv$ 19.2...30
<b>Conversion</b>	Method		By successive approximation	
	Resolution channel 1		11 bits (+ sign in $\pm$ 10 V)	
	Resolution channel 2		11 bits (+ sign in $\pm$ 10 V) (if two channels are used), 7 bits (+ sign in $\pm$ 10 V) (if three channels are used)	
	Resolution channel 3		7 bits (+ sign in $\pm$ 10 V)	
	Precision		0.5% of the full scale from 0 to 60°C	
<b>Isolation</b>	Between channel and earth	<b>V rms</b>	2000	
	Between inputs		Common point	
	Between inputs and outputs	<b>V rms</b>	1000	

#### Output characteristics

Type of module			TSX AMN 4000/4001		
<b>Analogue output</b>	Number of channels		1		
	Max. permissible voltage	<b>V</b>	$\pm$ 30		
<b>Conversion</b>	According to standards		IEC 1131, UL 508, ANSI MC 96.1, NF C 42		
	Range		0...10 V or $\pm$ 10 V	0...20 mA	4-20 mA
	Resolution		11 bits (+ sign in $\pm$ 10 V)	11 bits	11 bits
	Precision		1 % of 0...60 °C	1.5 % of 0...60 °C	1.5 % of 0...60 °C
	Type of protection		Permanent short circuit	Permanent open circuit	
<b>Isolation</b>	Between channel and earth	<b>V rms</b>	2000		
	Between inputs and outputs	<b>V rms</b>	1000		



TSX AMN 400●

### References

Type of I/O	Number of channels	Voltage/current ranges	Power supply	Reference (1)	Weight kg
<b>High level nputs</b> 12 bits	3 channels	0...10 V, ± 10 V 0...20 mA, 4-20 mA	~ 100/240 V	<b>TSX AMN 4000</b>	0.280
<b>High level isolated output</b> 11 bits	1 channel	0...10 V, ± 10 V 0...20 mA, 4-20 mA	≐ 24 V	<b>TSX AMN 4001</b>	0.270

1

(1) Product supplied with multilingual installation guide.

### Dimensions

TSX AMN 400●

Mounting

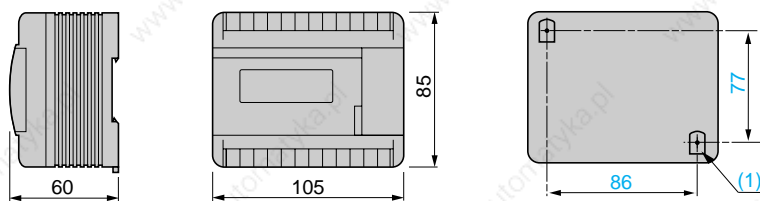

(1) 2 knock-outs Ø 4

### Connections

Inputs

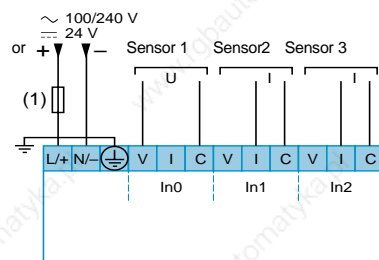

Output

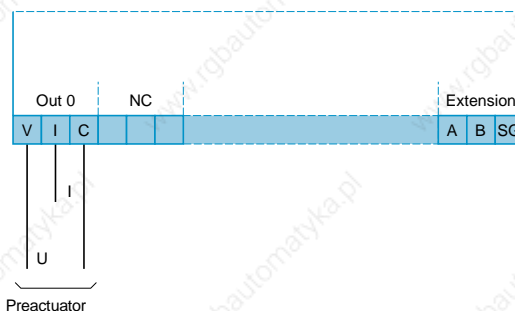

Distance between module and sensors or preactuator : 50 m max. with cable ø 0.5 mm (conductor cross-section) and shielding connected on the module side.

(1) 3 A fuse.

TSX AEN and TSX ASN analogue I/O modules enable the use of an analogue input on Nano PLCs via high speed counter inputs and the use of an analogue output on Nano PLCs via solid state outputs respectively.

There are six types of I/O module :

- TSX AEN 101 : 0/10 V input range
- TSX AEN 102 : 4/20 mA input range
- TSX AEN 105 :  $\pm 10$  V input range
- TSX ASN 101 : 0/10 V output range
- TSX ASN 102 : 4/20 mA output range
- TSX ASN 105 :  $\pm 10$  V output range

### Description

Analogue I/O modules are in a box format.

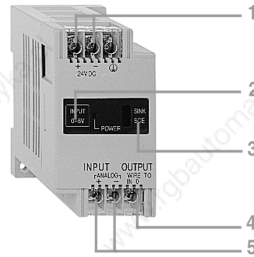

The front panel consists of :

- 1 A screw terminal block for connecting the  $\pm 24$  V power supply
- 2 A lamp indicating the presence of the  $\pm 24$  V power supply
- 3 An I/O type selector switch (positive or negative logic)
- 4 A screw terminal for connecting the frequency input or output to the Nano PLC
- 5 Two screw terminals for connecting the sensor or analogue preactuator

### Functions

Analogue I/O modules have the following functions :

- **For analogue inputs**  
For voltage/frequency conversion, which requires connection of the TSX AEN 10● module frequency output to the I0.0 input of the Nano PLC ( $\pm 24$  V input configured as a frequency meter at 10 kHz).
- **For analogue outputs**  
For frequency/voltage-current conversion, which requires connection of the TSX ASN 10● module frequency input to the Q0.0 output of the Nano PLC (solid state output configured for the PWM function, with time base at 0.1 ms).

### Characteristics

Type of module			TSX AEN 10●	TSX ASN 10●
Analogue I/O	Number of channels		1 (high level)	1 (high level)
	Input impedance		6.6 M $\Omega$ (1)   250 $\Omega$ (2)	—
	Load impedance		—	$\leq 5$ K $\Omega$ (1)   $\leq 250$ $\Omega$ (2)
	Max. permissible voltage without damage	V	$\pm 16$	$\pm 12$ (1)   $\pm 0.6$ (2)
Conversion	Method of conversion		Voltage $\rightarrow$ frequency	Frequency $\rightarrow$ voltage
	Resolution		10 bits or 12 bits	8 bits
	Conversion time	ms	125 (10 bits), 500 (12 bits)	500
	Precision		$\pm 1$ % of 0...60 $^{\circ}$ C (3)	
Frequency output	Nominal voltage	V	$\pm 24$	—
	Logic		Positive or negative	—
	Protection against short-circuits		No	—
Frequency input	Nominal voltage	V	—	$\pm 24$
	Logic		—	Positive or negative
Power supply	Nominal voltage	V	$\pm 24$	
	Limit voltages	V	$\pm 21...30$	
	Power drawn	W	2.5	
	Inrush current	A	10 max	
Isolation	Between power supply and earth	V rms	1500/50-60 Hz	1500/50-60 Hz
	Between the input or output and earth	V rms	1500/50-60 Hz	1500/50-60 Hz
	Between the input and frequency output	V rms	500/50-60 Hz	—
	Between the frequency input and the output	V rms	—	500/50-60 Hz

(1) TSX A●N 101 (0...10 V) and TSX A●N 105 ( $-10...+10$  V) modules.

(2) TSX A●N 102 (4...20 mA) module.

(3) Full scale.

### References



TSX AEN 10●

Analogue input modules (1)						
Type	Number of channels	Nature	Input range	Reference (2)	Weight	kg
High level 10/12 bits	1 channel	Voltage	0-10 V	TSX AEN 101	0.120	
			± 10 V	TSX AEN 105		
		Current	4-20 mA	TSX AEN 102	0.120	



TSX ASN 10●

Analogue output modules (3)						
Type	Number of channels	Nature	Output range	Reference (2)	Weight	g
High level 8 bits	1 channel	Voltage	0-10 V	TSX ASN 101	0.120	
			± 10 V	TSX ASN 105		
		Current	4-20 mA	TSX ASN 102	0.120	

(1) The Nano PLC must have  $\approx$  24 V inputs.

(2) Installation guide included as standard (English, French, German, Italian and Spanish).

(3) The Nano PLC must have  $\approx$  24 V transistor outputs.

### Dimensions, mounting

TSX AEN 10●/ASN 10● module

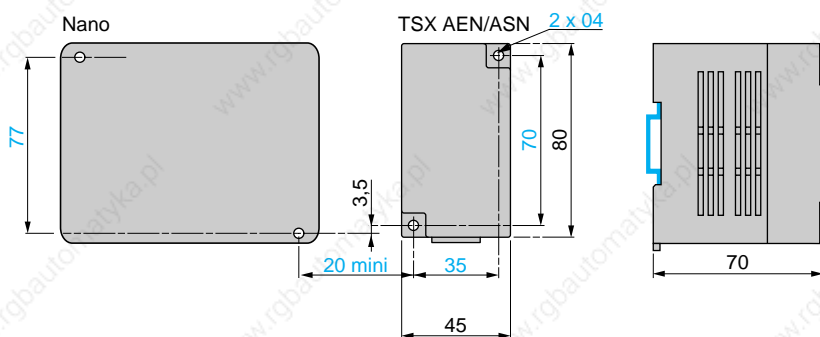

### Connections

TSX AEN 10● input module

Discrete inputs wired in positive logic

Discrete inputs wired in negative logic

TSX ASN 10● output module

Connection example with positive logic output

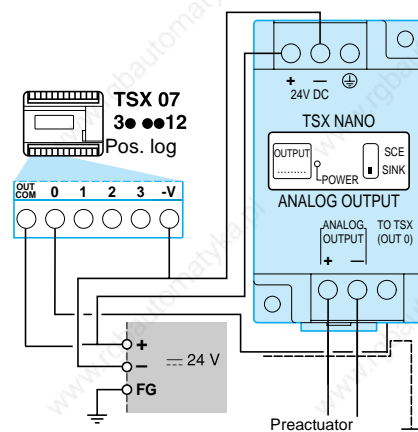
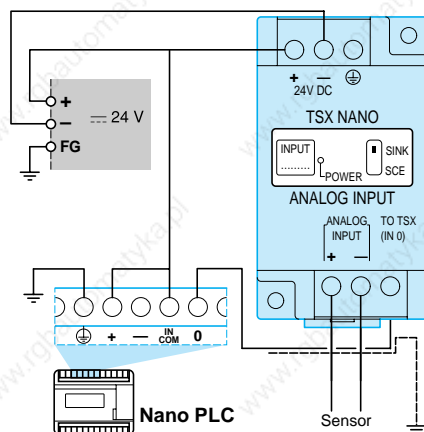
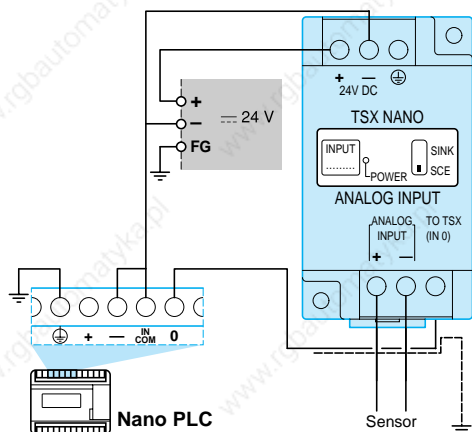



### General

PL7 language on Nano PLCs enables the programming of simple sequential applications such as those requiring numerical processing or specific functions such as schedule blocks, fast counting, etc. This programming is in List language (Instruction List) or in Ladder language.

These two languages are reversible provided a few simple programming rules are respected : any Nano PLC program which has been written in Instruction List (on an FTX 117 terminal or using PL7-07 software) can be read and modified in Ladder language (with PL7-07 software on an FT 2100 terminal or PC compatible) or vice versa.

### List language

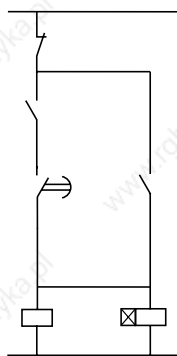

```

000 LD      %I0.0
001 AND (   %I0.1
002 ANDN   %TM0.Q
003 OR     %Q0.1
004 )
005 ST     %Q.1
006 IN    %TMO
007 ---
    
```

PL7 List language comprises a list of instructions from different families for direct translation into :

- Instructions on Ladder diagram bits, logic diagrams or Boolean equations
- Instructions on control system function blocks -(timers, counters, etc)
- Grafcet instructions
- Instructions on words for numerical processing
- Instructions on the program for structuring programs

### Ladder language

PL7 Ladder language is entirely graphic and thus offers the advantage of similarity with electromagnetic relay control systems. Its basic symbols are complemented by graphic elements allowing it to carry out control system functions, numerical processing and structuring of Nano PLC programs.

Ladder language provides additional assistance when debugging applications through the real-time display of graphic symbols (for example, the highlighting of closed contacts).

### Programming terminals

The development, transfer, debugging and archiving of programs for Nano PLCs can be carried out equally well on either of the two types of terminal :

#### FTX 117

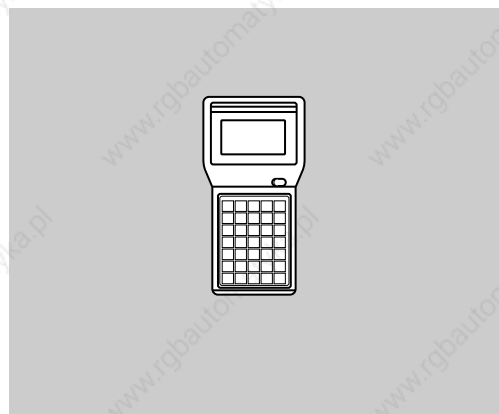

Dedicated pocket terminal, for programming in List language with operation in offline or online mode.

#### FT2100 or PC compatible

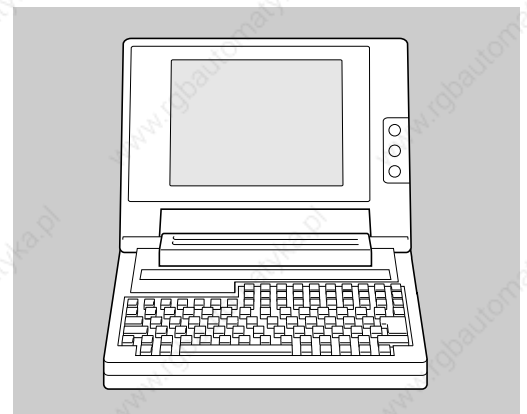

Standardised design office and workshop terminal, with PL7-07 software for programming in Ladder and/or List language (Instruction List)

Instructions	Combined List instructions	Grafcet List instructions #
	<ul style="list-style-type: none"> <li>● <b>LD, LDN, LDR, LDF</b> : read the state of a bit (direct, inverse, rising and falling edge)</li> <li>● <b>ST, STN, S, R</b> : write an output (direct, inverse, set, reset)</li> <li>● <b>AND, ANDN, ANDR, ANDF</b> : logic AND with a bit (direct, inverse, rising and falling edge)</li> <li>● <b>OR, ORN, ORR, ORF</b> : logic OR with a bit (direct, inverse, rising and falling edge)</li> <li>● <b>LD (, AND (, OR (, )</b> : open and close brackets (8 possible levels)</li> <li>● <b>XOR, XORN, XORR, XORF</b> : exclusive OR with a bit</li> <li>● <b>MPS, MRD, MPP</b> : buffer memory management for divergence towards output bits</li> <li>● <b>N</b> : negation</li> </ul> <p><b>List comments and title with PL7-07 software</b></p> <ul style="list-style-type: none"> <li>● Title : 122 characters before each instruction</li> <li>● <b>LD, LDN, LDR, LDF</b></li> <li>● Comments : 4 lines of 122 characters before each instruction</li> <li>● Possibility of associating a comment of 122 characters with each instruction</li> </ul>	<ul style="list-style-type: none"> <li>● <b>-*i</b> : step (1 ≤ i ≤ 62)</li> <li>● <b>=*i</b> : initial step (1 ≤ i ≤ 62)</li> <li>● <b>#i</b> : activate step i, after deactivation of current step</li> <li>● <b>#</b> : deactivate current step</li> <li>● <b>#Di</b> : deactivate step i after another step</li> <li>● <b>=*POST</b> : start post-processing</li> <li>● <b>%Xi</b> : bit associated with step i</li> </ul> <p><b>Instructions on program</b></p> <ul style="list-style-type: none"> <li>● <b>MCS, MCR</b> : master relay</li> <li>● <b>END, ENDC, ENDCN</b> : end of program (conditional or unconditional)</li> <li>● <b>JMP, JMPC, JMPCN</b> : jump to a label % L (conditional or unconditional)</li> <li>● <b>SRn</b> : call subroutine n (0 ≤ n ≤ 15)</li> <li>● <b>RET</b> : end of subroutine</li> <li>● <b>NOP</b> : non-operative instruction</li> </ul>
	<p><b>Ladder rungs</b></p> <ul style="list-style-type: none"> <li>● 10 contacts of 7 lines with 1 output per line</li> <li>● Title : 122 characters per rung</li> <li>● Comments : 4 lines of 122 characters</li> </ul>	<p><b>Ladder language graphic symbols</b></p> <ul style="list-style-type: none"> <li>● Normally open, normally closed and on edge contacts</li> <li>● Direct, inverse, SET and RESET coils</li> <li>● Program jump, subroutine call</li> </ul>
	<p><b>Standard function blocks</b></p> <ul style="list-style-type: none"> <li>● 32 timers : <b>%Tmi</b> (0 ≤ i ≤ 31) 0 to 9999 (word)</li> <li>● 16 up/down counters : <b>%Ci</b> (0 ≤ i ≤ 15) 0 to 9999 (word)</li> <li>● 4 16-bit LIFO or FIFO registers : <b>%Ri</b> (0 ≤ i ≤ 3)</li> <li>● 4 drum controllers : <b>%DRi</b> (0 ≤ i ≤ 3) 8 steps</li> <li>● Real-time clock : <b>%RTCi</b> (0 ≤ i ≤ 15) month, day, hour, minute, with TSX Nano 16 and 24 I/O</li> </ul> <p><b>Numerical instructions</b></p> <ul style="list-style-type: none"> <li>● Assignment in word, indexed word, bit strings word tables : :=</li> <li>● Arithmetic : +, -, x, /, REM, SQRT</li> <li>● Logic : AND, OR, XOR, NOT, INC, DEC</li> <li>● Shift operation : SHL, SHR, ROL, ROR (logic and rotate)</li> <li>● Conversion : BTI, ITB (BCD &lt;-&gt; Binary)</li> <li>● Comparison : &gt;, &lt;, &lt;=, &gt;=, =, &lt;&gt;</li> </ul>	<p><b>Specific function blocks</b></p> <ul style="list-style-type: none"> <li>● Transmission/reception of message of 64 words maximum (internal or constant) : <b>EXCH</b></li> <li>● Exchange control : <b>%MSG</b> available output, fault -output</li> <li>● 8 shift bit registers : <b>%SBRi</b> (0 ≤ i ≤ 7), shift one step to the left or right (max. 16 steps).</li> <li>● 8 step counter blocks : <b>%SCi</b> (0 ≤ i ≤ 7), move forward or back one step (max. 256 steps)</li> <li>● 1 fast counter (max.10 KHz), frequency meter (max. 10 KHz), up/down counter (max. 1 KHz) : <b>%FC</b> with 2 high speed outputs</li> <li>● Pulse width modulated output : <b>%PWM</b></li> <li>● Pulse output : <b>%PLS</b></li> <li>● Real-time display of Grafcet steps used</li> <li>● Symbol table management</li> <li>● Porting of Nano applications to Micro (List or Ladder)</li> </ul>
<p><b>Specific functions</b></p>	<ul style="list-style-type: none"> <li>● 1 input for PLC RUN/STOP command</li> <li>● 1 PLC status (security) output : PLC error</li> <li>● 6 latching inputs : 100us minimum</li> </ul>	<ul style="list-style-type: none"> <li>● Real-time display of Grafcet steps used</li> <li>● Symbol table management</li> <li>● Porting of Nano applications to Micro (List or Ladder)</li> </ul>
<p><b>Addressable objects</b></p>	<p><b>Bit objects</b></p> <ul style="list-style-type: none"> <li>● <b>%I/Qx.y</b> : 28 inputs and 20 outputs max.</li> <li>● <b>%Mi</b> : 128 internal bits</li> <li>● <b>%Si</b> : 128 system bits</li> <li>● <b>%Xi</b> : 62 Grafcet steps</li> <li>● <b>%●i.j</b> : function block bits</li> <li>● <b>%●i:Xk</b> : bits extracted from internal words, system words, constant words, input and output words</li> </ul> <p><b>Bit string and word table objects</b></p> <ul style="list-style-type: none"> <li>● <b>%●i:L</b> : bit strings (I/O, internal, system and Grafcet bits)</li> </ul>	<p><b>Word objects</b></p> <ul style="list-style-type: none"> <li>● <b>%MWi</b> : 256 internal words</li> <li>● <b>%KWi</b> : 64 constant words</li> <li>● <b>%SWi</b> : 128 system words</li> <li>● <b>%IWi.j</b> : 2 input words per PLC (exchange words for inter-PLC communication)</li> <li>● <b>%QWi.j</b> : 2 output words per PLC (exchange words for inter-PLC communication)</li> </ul> <ul style="list-style-type: none"> <li>● <b>%●Wi:L</b> : word tables (internal, constant and system words)</li> </ul>

### Software structure

There are two types of scan execution :

- Normal cyclic execution. This is the default setting.
- Periodic execution. This type of execution and the period of time are defined by the user during configuration.

#### Normal (cyclic) execution

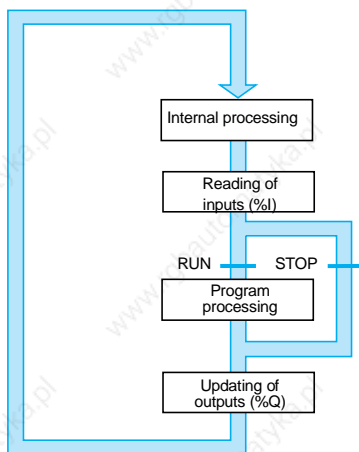

At the end of each scan the PLC system relaunches execution of a new scan. The execution time of each scan, which must not exceed 150 ms, is monitored by a software watchdog.

If this value is exceeded, a fault appears causing :

- Immediate stop of the scan (STOP)
- Display on the PLC front panel (RUN light flashing)
- Memorisation in a system bit (%S11)
- If an output is configured for the SECURITY function, it is reset to 0

#### Periodic execution

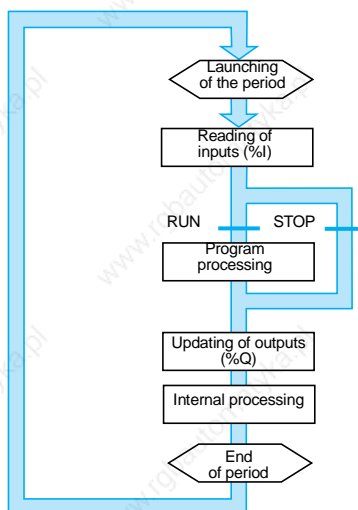

The execution of a scan is relaunched at the end of each period. The scan execution time must be less than that of the period defined (2 to 150 ms). If it exceeds this, it is memorised in a system bit (%S19) which should be tested and reset to 0 by the user (via the program or the terminal).

A software watchdog of 150 ms monitors the scan time. If it exceeds 150 ms, an execution fault is displayed (see normal execution).

#### PLC scan

In both types of execution, the system carries out :

- **Internal processing**  
The system implicitly :
  - monitors and controls the PLC
  - processes requests from the terminal
- **Reading of inputs**  
The state of each preactuator connected to the inputs (%I) is memorised. It is this memorised state which is taken into account during program processing.
- **Program processing**  
The program is executed in the order in which the user has written it (except for program or subroutine jump instructions).
- **Updating of outputs**  
The outputs (%Q) are activated or deactivated depending on the state (0 or 1) defined by the program.

### Instruction List language

#### Program structure

A program in PL7 language comprises a list of instructions (up to 1000 instructions) from the following different families :

- Bit instructions : for example, read input n° 3 : **LD %I0.3**
- Function block instructions : for example, start timer n° 0 : **IN %TMO**
- Word instructions : for example, an addition **[%MW10 := %MW50 + 100]**
- Program instructions : for example, call subroutine n° 5 : **SR5**
- Grafcet instructions : for example, step n° 8 : **-\*8**

Each program line has an automatically generated line number, an instruction code and a bit or word operand.

Example of a program line :

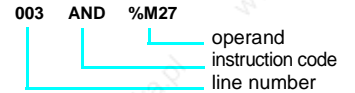

### Simple application programming (Boolean processing)

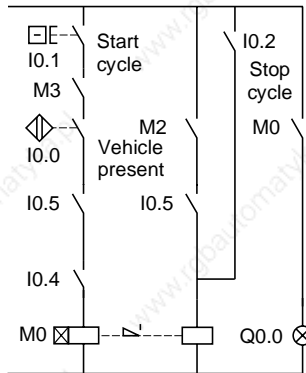

The translation of a Ladder diagram into an Instruction List program is immediate.

```

000 LD %I0.1 Start cycle pushbutton
    AND %I0.0 Vehicle present proximity sensor
    AND %M3 Real-time clock authorisation bit
    AND %I0.5 High roller limit switch
    AND %I0.4 Rear gantry limit switch
005 S %M0 Memo start cycle
    LD %M2
    AND %I0.5
    OR %I0.2 Stop cycle pushbutton
    R %M0
010 LD %M0
    ST %Q0.0 Scan indicator
    
```

### Application programming with Grafcet

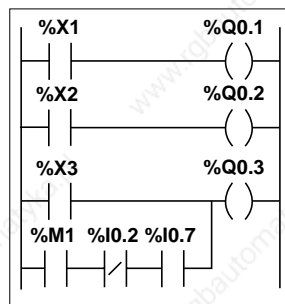
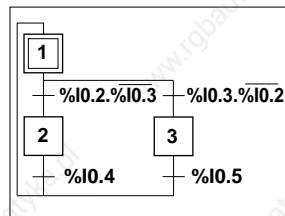
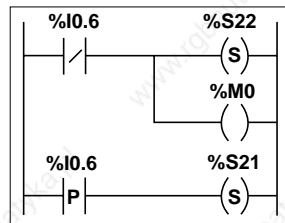

A Grafcet program is divided into 3 parts, each with a specific role.

```

000 LDN %I0.6 Pre-processing
001 S %S22 This is made up of a list of instructions
002 ST %M0 for processing :
003 LDR %I0.6 ● Power returns
004 S %S21 ● Failures
                                ● Changes in mode
                                ● Input logic
                                It ends with the first =* = or -* - instruction
                                encountered

005 =* = 1 Sequential processing
006 LD %I0.2 This is made up of the chart (-instructions
007 ANDN %I0.3 representing the chart) :
008 # 2 ● Steps
009 LD %I0.3 ● Transitions
010 ANDN %I0.2 ● Conditions
011 # 3 It ends with execution of the =* = POS
012 -* - 2 instruction.
013 LD %I0.4
014 # 1
015 -* - 03
016 LD %I0.5
017 # 1

018 =* = POST Post-processing
019 LD %X1 This is made up of a list of instructions
020 ST %Q0.1 for processing :
021 LD %X2 ● Instructions from the sequential
022 ST %Q0.2 processing part to control the outputs
023 LD %X3 ● Safety interlocks specific to the
024 OR ( %M1 outputs
025 ANDN %I0.2
026 AND %I0.7
027 )
028 ST %Q0.3
    
```

### Ladder language

#### Program structure

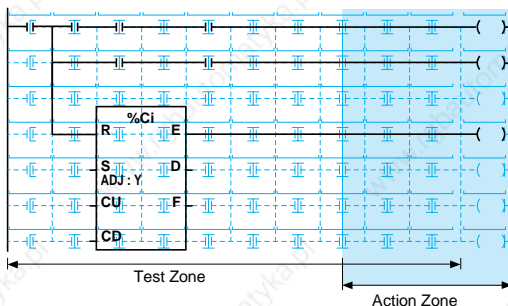

A program in Ladder language consists of a series of rungs. Each rung is labelled and can be :

- Described by a title of 122 characters maximum.
- Completed by a comment of 4 lines of 122 characters maximum

A rung consists of 7 lines of 11 columns with a maximum of 10 contacts and one coil per line.

The rung is divided into two different zones :

- Test Zone for receiving graphic elements; contacts, -comparison blocks and function blocks (standard or specific).
- Action Zone for receiving coils (in column 11) and operation blocks (from column 8 onwards).

Within a rung, coils or operation blocks must be connected by at least one vertical link in order to form a single group.

#### Graphic elements

The graphic elements which make up a rung are :

##### • Contacts



These test the state of the bit associated with them. 4 types are available : normally open, normally closed, rising edge (P) and falling edge (N).

##### • Coils



These control the output bits or internal bits. 4 types are available : direct, inverse, set and reset.

##### • Standard and specific function blocks



These correspond to the control system functions. There are 10 of them (see next page). A single function block is authorised for each rung.

##### • Operation blocks

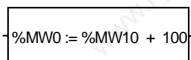

These enable numerical processing : assignment of words, arithmetic, logic, conversion, logic and rotate shift -operations, incrementation/decrementation. They call up the List -language numerical instructions.

##### • Comparison blocks

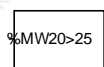

These enable comparison of two words of any type (>, >=, <, <=, =, <>).

##### • Program structure elements

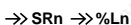

These call up subroutine n and the program jump for rung n.

##### • Connecting elements



These elements, called horizontal Boolean logic and -vertical Boolean logic are used to connect all the graphic elements described above.

#### Reversibility

The reversibility of List and Ladder languages enables the display of programs in whichever language is desired, regardless of the language used in their creation. For example, an application developed in the design office in Ladder language can be read, and even modified, in List language, and vice versa.

In order to be reversible, an application written in List language must respect a few rules of reversibility :

- Certain instructions such as XOR, JMPCN, etc must not be used.
- Function blocks such as BLK, OUT\_BLK and END\_BLK, etc must be used.

Each part of a non reversible program is represented in List language, the rest of the reversible program is presented in the form of rungs.

**Functions** (continued)

Function blocks are pre-programmed in the Nano PLC and allow control system functions to be integrated easily into application programs.

Description	Number	Chart	Function	Function
<b>Standard function blocks</b>				
Timer 1 ms minimum 9999 min maximum	32		E TYP TB	Enable input TON on-delay timer TOF off-delay timer TP Monostable Time base : 1 ms (TMO & TM1), 10 ms/100 ms/1 s or 1 min
Up/down counter	16		R P CU CD	Reset input Preset input Increment on edge input Decrement on edge input
LIFO/FIFO register	4		R I O TYP	Reset input Storage on edge input Retrieval on edge input FIFO, stack LIFO, stack
Drum controller	4		R U LEN	Return to step zero Forward step input Number of steps
<b>Specific function blocks</b>				
Width modulated output	1		IN TB	Pulse input Time base 0.1 ms, 10 ms, 1 s
Pulse output	1		IN R TB ADJ	Pulse input Reset number of pulses to 0 input Time base 0.1 ms, 10 ms, 1 s
Fast up/down counter Frequency meter	1		IN S TYP	Enable input Preset input Threshold value S0 ≤ 65535 Threshold value S1 ≤ 65535
Message transmission/reception	-	EXCH	EXCHANGE	Transmission or reception (1) via (Uni-Telway or ASCII) terminal port or Modbus link
Exchange control	-		R D	Communication initialisation input
Bit shift register	8		R CU CD	Reset 16 %SBRi.j bits to 0 Shift input left Shift input right
Step counter	8		R CU CD	Reset %SCi.j bits to 0 Increment input one step Decrement input one step
Schedule block (real-time clock)	16	RTC:i	Q : MTWTFSS hh:mm	Assignment of output %Mi or %Qj.k activated by schedule block Activation days of the week Hours (0 to 23) and minutes (0 to 59) of start and end of activation

(1) This function is specific to PL7-07 ≥V3, compatible with Nano PLCs ≥version 2.

### Presentation

The FTX 117 dedicated terminal is the Instruction list language programming tool for Nano PLCs. It is very easy to use due to its back-lit screen with 4 lines of 16 characters and 35-key keypad for contextual entry.

The FTX 117 terminal can be powered in two different ways :

- By a ~ 100 to 120 V mains supply or ~ 200 to 240 V supply via a T FTX ADC 1● adaptor, in which case the terminal must be used in offline mode.
- By the Nano PLC, in which case the priority operating mode of the terminal is online mode.

### Description

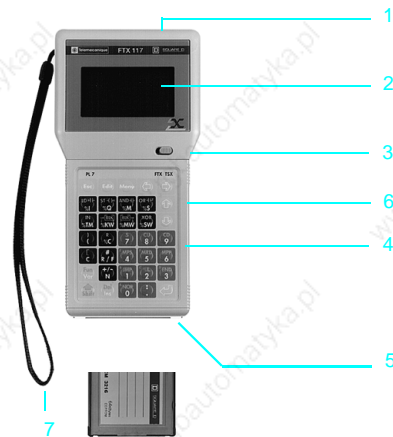

The FTX 117 terminal front panel comprises :

- 1 Exclusive access to connectors for connection to :
  - T FTX ADC 1● ~ / = mains adaptor
  - T FTX CB1 0●0 cable for connection to the Nano PLC
- 2 A back-lit screen with 4 lines of 16 alphanumeric characters
- 3 An operating mode selector switch :
  - FTX : offline mode operation
  - TSX : online mode operation
- 4 A 35-key keypad
- 5 A slot for PCMCIA type 1 memory card
- 6 Magnets fitted on the back of the terminal to keep it in a vertical position on a metal support
- 7 A carrying strap

### Functions

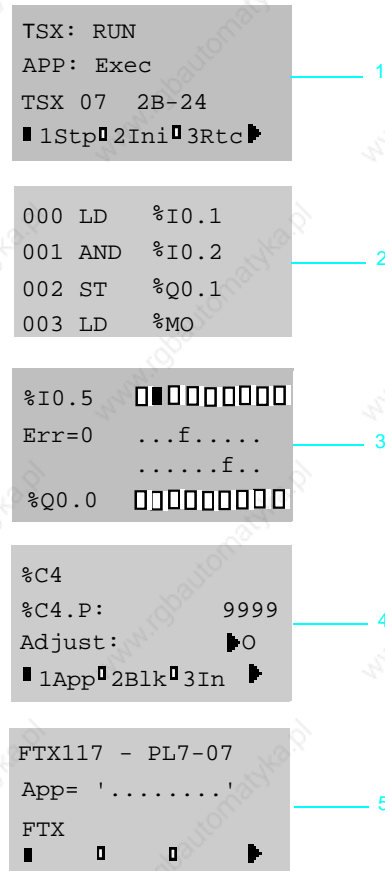

In order to offer rapid operation, all the necessary functions for writing, debugging, transferring and archiving programs are accessible at any time as there are 5 editors which display the menus.

The 5 editors are as follows :

- 1 **TSX** : shows the menus for :
  - displaying the RUN/STOP status of the PLC
  - running or stopping the PLC
  - initialising the PLC memory
  - displaying and entering the real-time clock parameters
  - setting the PLC integral clock
- 2 **Prg** : program editor designed for :
  - reading, writing and modifying the program using duplication, search, replacement functions, etc
  - partially or completely clearing the application memory
  - debugging the program
  - transferring and archiving applications
  - program diagnostics using a consistency check
- 3 **Dat** : data editor for :
  - accessing the set of variables in real-time display
  - modifying or forcing authorised variables
  - converting word objects into hexadecimal, ASCII or decimal code
  - entering and memorising data tables
- 4 **Cnf** : configuration editor (when default configuration is not suitable) for :
  - entering application parameters
  - entering I/O and function block parameters
  - entering constant words
- 5 **FTX** : terminal editor for entering terminal parameters (language, sound, keyboard, screen saver)

Development,  
debugging and  
adjustment tools

The various editors offered by the FTX 117 terminal make it easy to use for all stages of application development :

- **In the development phase** for the configuration steps of PLC objects, real-time clocks, entering the program, diagnostics and back-up (to Flash memory or to PCMCIA memory card)
- **In the adjustment and debugging phase** for transferring the application to the PLC, starting-up, debugging, adjusting parameters and archiving the application to PLC EEPROM memory and/or to PCMCIA memory card

Easy touse,  
user-friendly tool

The FTX 117 terminal is just as suited to use in the design office in offline mode as in the workshop connected to the TSX 07 PLC. Ease of use is mainly due to :

- A back-lit screen with 4 lines of character
- A 35-key keypad comprising 3 zones represented by 3 colours :
  - operating mode zone (access to editors and functions) in light blue
  - instruction entry zone in dark blue with dual marked keys for contextual access
  - hexadecimal keypad zone in grey (0 to 9 and A to F) with contextual access to program structuring instructions
- Its small size (185 x 95 x 30 mm) and magnetic back

### References

#### FTX 117 terminals (with 4 line back-lit LCD screen)

Use	Manual TLX DM 07 117E	Cable for connection to Nano PLC :	Reference (1)	Weight kg
Programming/ adjustment of Nano PLCs (2)	Not supplied	Not supplied	<b>T FTX 117 0</b>	0.300
		Supplied	<b>T FTX 117 071</b>	0.400
	Supplied	Supplied	<b>T FTX 117 071E</b>	0.665

#### Separate parts

Description	Length	Use	Reference	Weight kg
~ / ~ adaptors for FTX 117 terminal	-	~ 110/120 V mains adaptor	<b>T FTX ADC 11</b>	0.260
	-	~ 200/240 V mains adaptor	<b>T FTX ADC 12</b>	0.260
Connecting cables	2 m	FTX 117<-> Nano PLC	<b>T FTX CB1 020</b>	0.100
	5 m	FTX 117<-> Nano PLC	<b>T FTX CB1 050</b>	0.190
PCMCIA type 1 memory cards	-	EEPROM 32 K words	<b>T FTX REM 3216</b>	0.025
	-	Protected RAM 32 K words	<b>T FTX RSM 3216</b>	0.030
	-	Protected RAM 128 K words	<b>T FTX RSM 12816</b>	0.030
Battery	-	For PCMCIA RAM type memory card	<b>TSX BAT M01</b>	0.010

### Dimensions

T FTX 117 0●●●

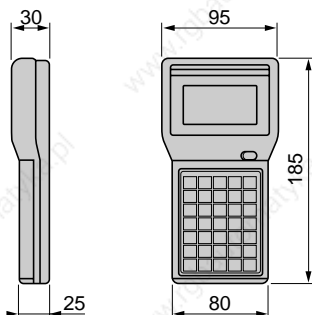

(1) The letter **E** at the end of a reference indicates that the product includes documentation in English.  
(2) FTX 117 Adjust terminal, see page 43580/2



T FTX 117 0●●●



T FTX REM 3216



Presentation

PL7-07 software offers fully reversible programming in Ladder language and in Instruction list language on PC compatibles (using DOS operating system, compatible with Windows 95/Windows NT). This software, which uses a Windows type user interface, simplifies the task of the automation engineers by its optimized graphic entry, editing functions and high-performance online help.

Graphic entry and display

When creating programs in Ladder language or in Instruction list language, the software displays the palettes showing the set of graphic components or of Boolean instructions, depending on the user context.

Graphic components



Ladder language

Ladder language is a graphic language which offers:

- Basic graphic symbols
- Standard function blocks (timers, etc)
- Specific blocks (pulse generator, etc)
- Comparison blocks and operation blocks (additions, etc)

Instruction List



Instruction list language

The PL7-07 instruction list language is a Boolean language which can also process numerical operations.

This language easily translates different graphical representations:

- Ladder diagram
- Grafcet

Language objects are symbolised by a maximum 32 character description. The programs are supplemented by titles (122 characters maximum) and by comments (4 lines of 122 characters maximum), which simplify debugging and maintenance.

Provided a few simple writing rules are respected, the two languages are fully reversible (apart from Grafcet instructions logic or exclusive instructions, etc). In the case of a program written in Instruction list language, when it is requested in Ladder language, non-reversible instruction sequences remain displayed in the form of an instructions list, while the rest of the reversible program is translated into Ladder language.

The transition from one language to the other is achieved by the simple touch of a button.

Design and debugging features

The following features simplify application creation:

**Multilingual software:** when installing the software, it is possible to choose one of 5 languages (English, French, Spanish, German, Italian). All screens and messages as well as the online help will be displayed in the chosen language.

**Entry assistance:** contextual graphic palettes, the structure of editors and menus, and a Windows-type user interface ensure that PL7-07 programs are easy to write and modify.

**Programming in RUN** (in Instruction list language only): changing the PL7 language object addresses in run mode allows debugging and on-site changes when controlled applications cannot be stopped. In addition, in Instruction list language, program instructions can be modified, except those instructions which modify the program structure.

**Debugging and adjustment:** display and modification in real time of the status of bit objects and the value of word objects, forcing of input/output, creation of data tables.

**Documentation:** allows the user to create and update a complete application file (general information, symbol tables, configuration, program, cross-references, etc) with information sequencing and layout facilities.

### PL7-07 software packs under DOS (Windows 95 and Windows NT compatible)

Software packs designed for PC compatibles (with a 386 microprocessor minimum, 4 M bytes of RAM memory and DOS 3.3 operating system) for programming and debugging Nano PLCs in PL7 language.

Description	Support	Composition	Reference	Weight kg
<b>DOS software packs</b> Reversible instruction List/Ladder language	Compatible PC	1 CD-Rom, 1 TSX PCU 1031 cable, 1 multilingual technical documentation on CD-ROM	<b>TLX CD PL7 07P 40M</b>	0.440
	FTX 517 terminals	1 CD-Rom, 1 T FTX CB F 020 cable, 1 multilingual technical documentation on CD-ROM	<b>TLX CD PL7 07F 40M</b>	0.440
<b>Update software for TLX L PL7 07● 30●</b>	Compatible PC, FTX 517 terminal	1 CD-Rom, 1 multilingual technical documentation on CD-ROM	<b>TLX U PL7 07 40M</b>	0,310



TLX L PL7 07● 40M

Spare parts				
Description	Length	Use	Reference	Weight kg
<b>Connecting cables</b>	2.5 m	Connection between Nano PLC and FT2100/PC compatible (9-way SUB-D type connector)	<b>TSX PCU 1031</b>	0.140
	2 m	Connection between Nano PLC and FTX 517 (26-way SUB-D type connector)	<b>T FTX CB F 020</b>	0.120