

PacDrive™ Controller Mx-4

Controller-based architecture

The PacDrive Controller Mx-4 is a Pentium II based controller using the VxWorks real-time operating system that provides logic and motion functions for a machine. A PacDrive Controller synchronizes, coordinates and generates the positioning functions for a maximum of 47 servo drives which are connected through the motion bus SERCOS interface.

Several standardized field bus interfaces are available, PROFIBUS DP, CAN, CANopen, DeviceNet, or Ethernet/IP. For HMI functions various standard HMI systems can be used. Whether low-cost text display or IPC - no problem for the flexible Mx-4.

The technical data at a glance:

- CPU: Intel Pentium II, 266 MHz, 32 MB RAM, L2 Cache 512 KB
- Real-time operating system: VxWorks
- IEC 61131-3 programming languages for PLC and motion control
- Motion bus: SERCOS interface
- Field bus interface: Profibus DP, CAN, CANopen, DeviceNet, or Ethernet/IP
- Integrated IOs: digital inputs, digital outputs, analog inputs, interrupt inputs, fast touchprobe inputs
- Communication interfaces: RS 232, RS 485, Ethernet (TCP/IP)
- CompactFlash™ Disk (16 MB)
- Includes OPC server for Windows based HMI
- Remote diagnosis over web server or modem



Contents	Product information	1
	Technical Data	3
	Interfaces	7
	Electrical connections	9
	Dimensions	17
	Option Modules	19
	Product ID Code	21

Imprint © All rights reserved to ELAU AG, also in case of patent right applications.

No part of this documentation and the related software and firm-ware may be reproduced, rewritten, stored on a retrieval system, transmitted or translated into any other language or computer language without the express written consent of ELAU AG.

Every possible measure was taken to ensure that this product documentation is complete and correct. However, since hardware and software are continuously improved, ELAU makes no representations or warranties with respect to the contents of this product documentation.

Trademark PacDrive is a registered trademark of ELAU AG.

All other trademarks mentioned are the exclusive property of their manufacturers.

This Technical Data Sheet does not replace the Operating manual.
For a complete description of the PacDrive Controller see the Operating manual PacDrive Controller
For planning and project activities see the PacDrive Projecting manual

ELAU AG
Dillberg 12
D-97828 Marktheidenfeld
Phone: 09391/606-0
Fax: 09391/606-300
eMail: info@elau.de
Internet: <http://www.elau.de>

Technical Data

	Parameter	Value
Product configuration	Product ID code - MAx-4 up to 8 axes - MAx-4 up to 99 axes	MAx-4 / 11 / 02 / 016 / 08 / x / x / xx MAx-4 / 11 / 02 / 016 / 99 / x / x / xx
	Order code - MAx-4 up to 8 axes - MAx-4 up to 99 axes	13 13 02 51 - xxx 13 13 02 55 - xxx
Processor	CPU	Intel Pentium II 266 MHz
	RAM	32 MB
	L2 Cache	512 kB
	NVRAM	32 kB
	CompactFlash™ Disk	16 MB (internal)
	Real time clock (RTC)	yes, optional hardware required
	Watchdog	yes
	Diagnostics	status LEDs
Operating System	Real-time operating system	VxWorks
Programming languages	Programming languages IEC 61131-3	Continuous Function Chart (CFC) Function Block Diagram (FBD) Instruction List (IL) Ladder Diagram (LD) Sequential Function Chart (SFC) Structured Text (ST)
Interfaces	Communication interfaces COM1 COM2	RS232 (X5) RS485 (X6)
	Network interface	Ethernet (10 Base-T) (X10)
	Fieldbus interfaces	PROFIBUS DP Master (12 MBaud) ¹⁾ PROFIBUS DP Slave (12 MBaud) ¹⁾ CAN (2.0B) ¹⁾ CANopen ¹⁾ DeviceNet Slave ¹⁾ Ethernet/IP Slave ¹⁾ ¹⁾ optional hardware module required
	Motion bus interface	SERCOS interface (4 MBaud) (X7, X8)

	Parameter	Value
	PacNet interface	1 PacNet interface ¹⁾ 1) optional hardware module required
	Encoder interface	1 SinCos encoders up to 10 incremental encoder ¹⁾ 1) optional hardware module required
	HMI interface	Operator panels: RS485 using Modbus or PROFIBUS DP HMI software tools: OPC server (Windows NT/2000/XP or Windows CE)
	Remote Diagnostics interface	Web server or modem
	Communication protocols	http, ftp, SMTP (email)
	Integrated trace recorder (software oscilloscope)	8 channels 1 ms resolution
	Integrated logger for diagnostic messages	27 kB
Performance	Motion performance	11 Servo axes @ 1 ms SERCOS cycle 23 Servo axes @ 2 ms SERCOS cycle 45 Servo axes @ 4 ms SERCOS cycle max. 255 cam profiles running in parallel
	PLC performance	20 µs for 1000 Bit instructions unlimited number of PLC tasks PLC task types: continuous, periodic or event-triggered Cycle time Fast Task: 250 µs Nominal I/O response time: 500 µs (reading input, processing data, setting output)
PLS	Programmable limit switches (PLS)	max. 256 Type: dynamic Outputs: memory or digital outputs Inputs: external master encoder, virtual master encoder, or axes position Scan time: 250 µs

Parameter	Value
I/Os Integrated digital inputs (X3)	number: 20 range U_{IN} 0 state: DC 0 ... 6 V range U_{IN} 1 state: DC 20 ... 33 V input current: $I_{IN} = 5$ mA on $U_{IN} = 24$ V pole safe: yes input filter: 3.5 ... 5.5 ms
Integrated analog inputs (X2)	number: 2 range U_{IN} : -7 ... 10 V (impedance 100 k) or range I_{IN} : 0 ... 20 mA (impedance 500 R)
Integrated interrupt inputs (X4)	number: 4 range U_{IN} 0 state: DC 0 ... 6 V range U_{IN} 1 state: DC 20 ... 33 V input current: $I_{IN} = 5$ mA on $U_{IN} = 24$ V pole safe: yes input filter: 0.07 ... 0.17 ms
Integrated touchprobe inputs (X4)	number: 16 range U_{IN} 0 state: DC 0 ... 6 V range U_{IN} 1 state: DC 20 ... 33 V input current: $I_{IN} = 5$ mA on $U_{IN} = 24$ V pole safe: yes input filter TP0 to TP15: 100 μ s resolution time TP0 to TP3: 15.6 μ s @ 1, 2, 4 ms cycle time resolution time TP4 to TP15: 15.6 μ s @ 1 ms cycle time 32.25 μ s @ 2ms cycle time 62.5 μ s @ 4ms cycle time
Integrated digital outputs (X4)	number: 16 output voltage: $(+UL-3\text{ V}) < U_{OUT} < +UL$ rated current: $I_e = 100$ mA per output switch current: $I_{e\max} < 0.5$ A for 1 s leakage current 0 signal: < 0.4 mA transmission time: 0.04 ... 0.31 ms short-circuit-proof: yes relay outputs: DC 20 ... 30 V / 2 A
Integrated analog outputs	none
Additional digital and analog I/Os	via fieldbus max. 3.584 Bytes digital/analog inputs and max. 3.584 Bytes digital/analog outputs max. number of stations: 126 (PROFIBUS)

	Parameter	Value
Power supply	Additional fast digital I/Os	via PacNet max. 128 inputs and 128 outputs
	Additional touchprobe inputs	via PacNet max. 16 touchprobe inputs
	Power supply	DC 24 V (-15% / +25%) / max. 3.15 A
	Power consumption	max. 60 W
	Uninterruptable power supply UPS	external
	Environment	Product size
Box size		width: 100 mm height: 400 mm depth: 300 mm
Product weight Boxed weight		2.4 kg 3.0 kg
Ambient conditions - protection class - ambient temp. - insulation - rel. humidity		IP20 +5 ... +55 °C (in operation) -25 ... +70 °C (for storage and transport) degree of pollution 2 ..., no dewing allowed 5% ... 85% climatic category 3K3 EN 60 721
Approvals		CE, UL , cUL

Remark: All technical data refer to the actual SW and HW versions:

- HW-Code: F464A8
- SW-Version: Firmware V00.15.xx

Interfaces

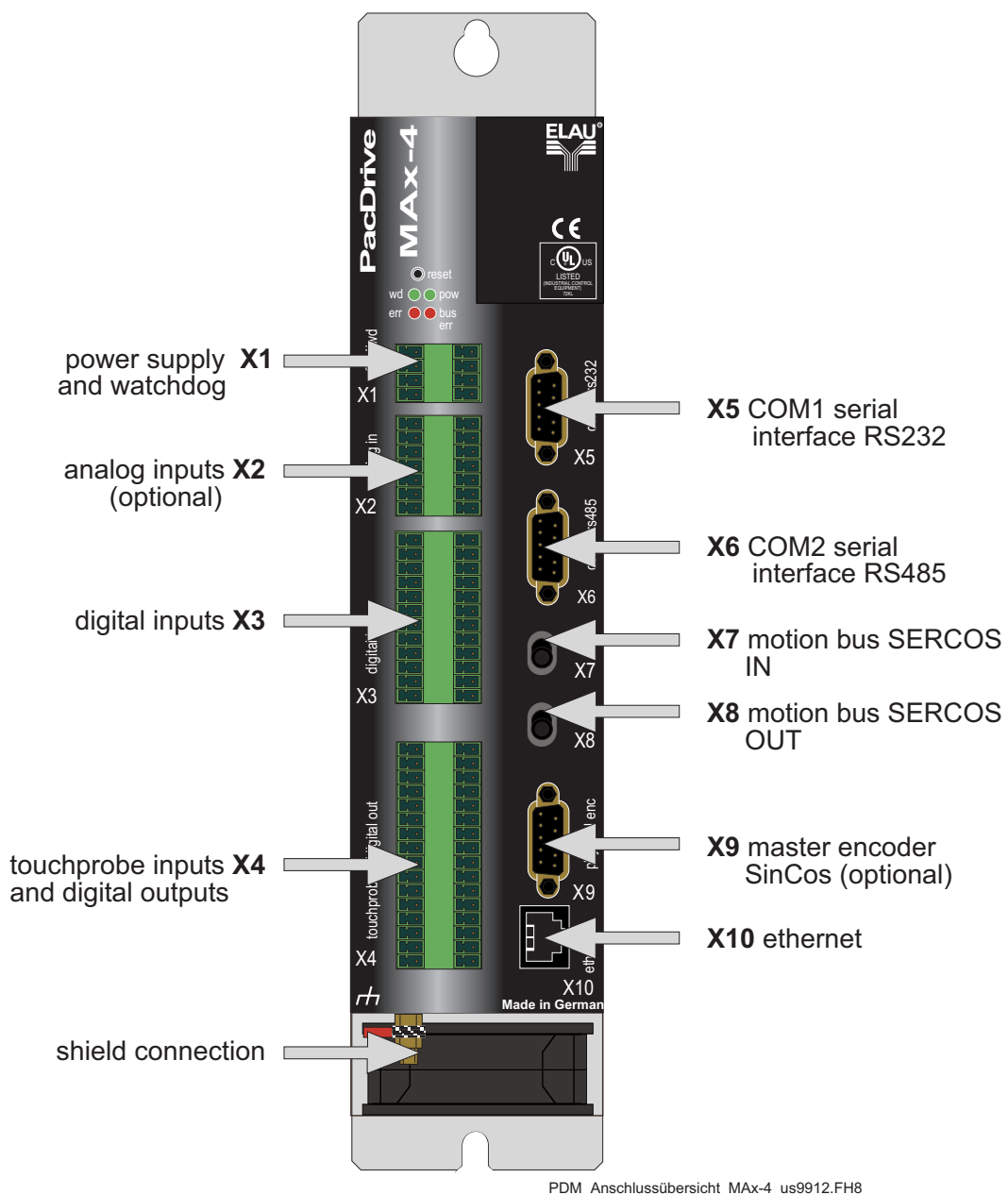
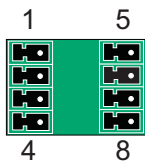

Fig. 0-1: Overview of the PacDrive Controller MAX-4

Electrical Connections

X1 - control voltage and watchdog



Pin	Designation	Meaning	Range	Max. cross section
1	DC +24 V	supply voltage	- 15% / +25%	1.5 mm ²
2	0 V	supply voltage		1.5 mm ²
3	+UL	for digital outputs	DC +24V -15% / +25%	1.5 mm ²
4	L0	for digital inputs / outputs		1.5 mm ²
5	DC +24 V	supply voltage	-15% / +25%	1.5 mm ²
6	DC 0 V	supply voltage		1.5 mm ²
7	WD	watchdog relay		1.5 mm ²
8	WD	watchdog relay		1.5 mm ²

Table 0-1: Electrical connections of MAX-4 / X1

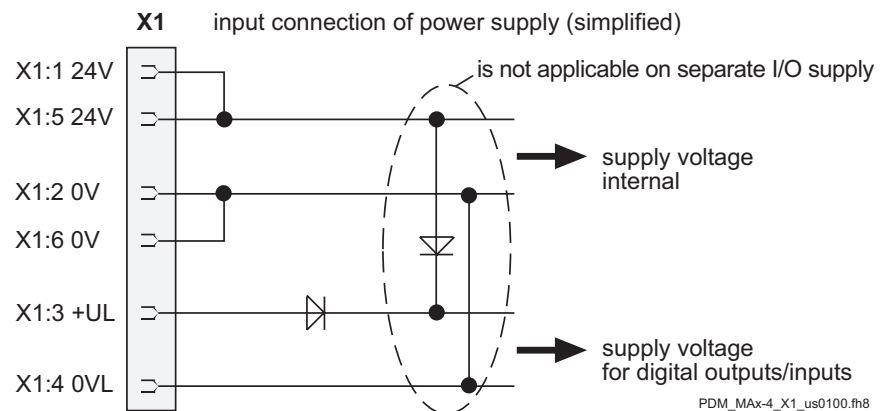

Fig. 0-1: Electrical connections of MAX-4 / X1 input connection



CAUTION!

Disconnection of control voltage!
Risk of data loss or damage to flash disk!

- Use UPS, and the control voltage of the PacDrive Controller may only be switched off if all files are closed. See also Programming Manual -Reference- Function *SysShutdown()*.

X2 - analog inputs

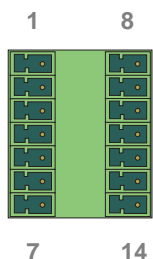

Pin	Designation	Meaning	Range	Max. cross section
1	a1+	analog input 1+	differential input	1.5 mm ²
2 *)	a1-	analog input 1-	-7 V ... +10 V	1.5 mm ²
3	AGND	analog GND		1.5 mm ²
4	PE	shield		1.5 mm ²
5	12 V	output voltage	Ri = 1k	1.5 mm ²
6	j1	bridge power input		1.5 mm ²
7	j1	bridge power input		1.5 mm ²
8	a2+	analog input 2+	differential input	1.5 mm ²
9 *)	a2-	analog input 2-	-7 V ... +10 V	1.5 mm ²
10	AGND	analog GND		1.5 mm ²
11	PE	shield		1.5 mm ²
12	12 V	output voltage	Ri = 1k	1.5 mm ²
13	j2	bridge power input		1.5 mm ²
14	j2	bridge power input		1.5 mm ²

*) Voltages and currents outside the specified ranges lead to wrong measuring values (AnalogIn.Value).
 If the voltage to be measured relates to AGND, only positive voltages and currents from 0 V to +10 V or 0 mA to 20 mA can be processed.
 This is equivalent to an AnalogIn.Value of 2048 to 4096.

Table 0-2: Electrical connections of MAX-4 / X2

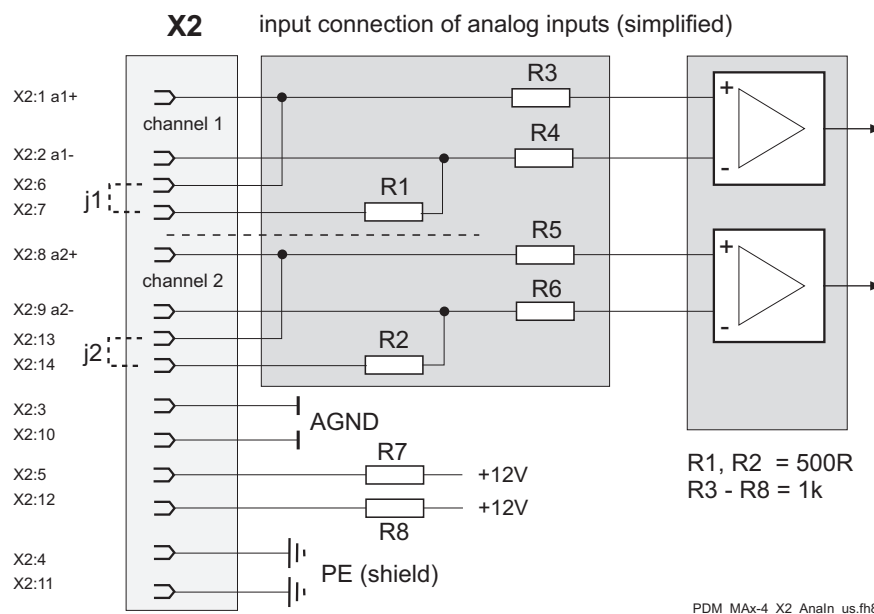
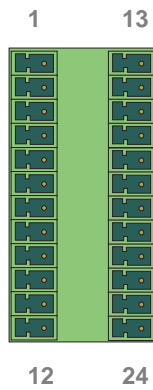

Fig. 0-2: Electrical connections of MAX-4 / X2 input connection

X3 - digital inputs



Pin	Designation	Meaning	Range	Max. cross section
1	0.0	standard input 0	DC 20 ... 30 V	1.5 mm ²
2	0.1	standard input 1	DC 20 ... 30 V	1.5 mm ²
3	0.2	standard input 2	DC 20 ... 30 V	1.5 mm ²
4	0.3	standard input 3	DC 20 ... 30 V	1.5 mm ²
5	0.4	standard input 4	DC 20 ... 30 V	1.5 mm ²
6	0.5	standard input 5	DC 20 ... 30 V	1.5 mm ²
7	0.6	standard input 6	DC 20 ... 30 V	1.5 mm ²
8	0.7	standard input 7	DC 20 ... 30 V	1.5 mm ²
9	0.8	standard input 8	DC 20 ... 30 V	1.5 mm ²
10	0.9	standard input 9	DC 20 ... 30 V	1.5 mm ²
11	0.10	standard input 10	DC 20 ... 30 V	1.5 mm ²
12	0.11	standard input 11	DC 20 ... 30 V	1.5 mm ²
13	0.12	standard input 12	DC 20 ... 30 V	1.5 mm ²
14	0.13	standard input 13	DC 20 ... 30 V	1.5 mm ²
15	0.14	standard input 14	DC 20 ... 30 V	1.5 mm ²
16	0.15	standard input 15	DC 20 ... 30 V	1.5 mm ²
17	0.16	standard input 16	DC 20 ... 30 V	1.5 mm ²
18	0.17	standard input 17	DC 20 ... 30 V	1.5 mm ²
19	0.18	standard input 18	DC 20 ... 30 V	1.5 mm ²
20	0.19	standard input 19	DC 20 ... 30 V	1.5 mm ²
21	1.0	interrupt input 0	DC 20 ... 30 V	1.5 mm ²
22	1.1	interrupt input 1	DC 20 ... 30 V	1.5 mm ²
23	1.2	interrupt input 2	DC 20 ... 30 V	1.5 mm ²
24	1.3	interrupt input 3	DC 20 ... 30 V	1.5 mm ²

Table 0-3: Electrical connections of MAX-4 / X3

X4 - touchprobe inputs and digital outputs

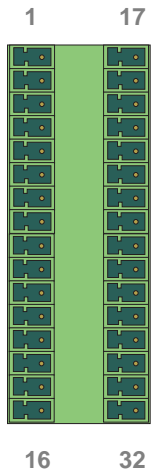

Pin	Designation	Meaning	Range	Max. cross section
1	2.0	touchprobe input 0	DC 20 ... 30 V	1.5 mm ²
2	2.1	touchprobe input 1	DC 20 ... 30 V	1.5 mm ²
3	2.2	touchprobe input 2	DC 20 ... 30 V	1.5 mm ²
4	2.3	touchprobe input 3	DC 20 ... 30 V	1.5 mm ²
5	2.4	touchprobe input 4	DC 20 ... 30 V	1.5 mm ²
6	2.5	touchprobe input 5	DC 20 ... 30 V	1.5 mm ²
7	2.6	touchprobe input 6	DC 20 ... 30 V	1.5 mm ²
8	2.7	touchprobe input 7	DC 20 ... 30 V	1.5 mm ²
9	2.8	touchprobe input 8	DC 20 ... 30 V	1.5 mm ²
10	2.9	touchprobe input 9	DC 20 ... 30 V	1.5 mm ²
11	2.10	touchprobe input 10	DC 20 ... 30 V	1.5 mm ²
12	2.11	touchprobe input 11	DC 20 ... 30 V	1.5 mm ²
13	2.12	touchprobe input 12	DC 20 ... 30 V	1.5 mm ²
14	2.13	touchprobe input 13	DC 20 ... 30 V	1.5 mm ²
15	2.14	touchprobe input 14	DC 20 ... 30 V	1.5 mm ²
16	2.15	touchprobe input 15	DC 20 ... 30 V	1.5 mm ²
17	0.0	standard output 0	DC20..30 V/0.1A	1.5 mm ²
18	0.1	standard output 1	DC20..30 V/0.1A	1.5 mm ²
19	0.2	standard output 2	DC20..30 V/0.1A	1.5 mm ²
:	:	:	:	:
27	0.10	standard output 10	DC20..30 V/0.1A	1.5 mm ²
28	0.11	standard output 11	DC20..30 V/0.1A	1.5 mm ²
29	0.12	standard output 12	DC20..30 V/0.1A	1.5 mm ²
30	0.13	standard output 13	DC20..30 V/0.1A	1.5 mm ²
31	0.14	standard output 14	DC20..30 V/0.1A	1.5 mm ²
32	0.15	standard output 15	DC20..30 V/0.1A	1.5 mm ²

Table 0-4: Electrical connections of MAx-4 / X4

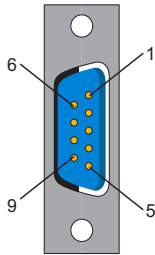
X5 - Com 1 (RS232)

Pin	Designation	Meaning	Range	Max. cross section
1	DCD	Data Carrier Detect		0.25 mm ²
2	RxD	Receive Data		0.25 mm ²
3	TxD	Transmit Data		0.25 mm ²
4	DTR	Data Terminal Ready		0.25 mm ²
5	GND	Signal Ground		0.25 mm ²
6	DSR	Data Set Ready Clear To Send		0.25 mm ²
7	RTS	Request To Send		0.25 mm ²
8	CTS	Clear To Send		0.25 mm ²
9	RI	Ring Indicator		0.25 mm ²

Table 0-5: Electrical connections of MAx-4 / X5

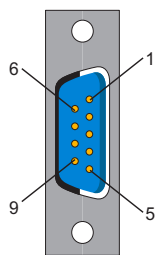
X6 - Com 2 (RS485)

Pin	Designation	Meaning	Range	Max. cross section
1	+5 VM	supply voltage		0.25 mm ²
2	TxD-	RS485 Transmit -		0.25 mm ²
3	TxD+	RS485 Transmit+		0.25 mm ²
4	RxD+	RS485 Receive +		0.25 mm ²
5	RxD-	RS485 Receive -		0.25 mm ²
6	GNDR	GND receive RS485		0.25 mm ²
7	-	reserved		0.25 mm ²
8	GNDM	supply voltage		0.25 mm ²
9	GNDR	GND receive RS485		0.25 mm ²

Table 0-6: Electrical connections of MAx-4 / X6

X9 - master encoder (SinCos, optional)

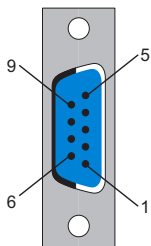

Pin	Designation	Meaning	Range	Max. cross section
1	REFSIN	sinus reference signal		0.25 mm ²
2	SIN	sinus trace		0.25 mm ²
3	REFCOS	cosine reference signal		0.25 mm ²
4	COS	cosine trace		0.25 mm ²
5	+12 V	supply voltage		0.25 mm ²
6	RS485-	parameter channel -		0.25 mm ²
7	RS485+	parameter channel +		0.25 mm ²
8	SC_SEL	encoder connected (bridge to GND)		0.25 mm ²
9	GND	supply voltage		0.25 mm ²

Table 0-7: Electrical connections of MAX-4 / X9



CAUTION!

Disconnection of SinCos encoder plug while unit is powered on! SinCos encoder may be damaged!

- Disconnect and connect the SinCos encoder plug only in voltage-free state (disconnect MC-4 MotorController from 24 V power supply!).

X10 - Ethernet

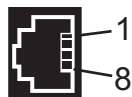

Pin	Designation	Meaning	Range	Max. cross section
1	Tx+	OutputTransmitData+		
2	Tx-	OutputTransmitData-		
3	Rx+	InputReceiveData +		
4	-	reserved		
5	-	reserved		
6	Rx-	InputReceiveData -		
7	-	reserved		
8	-	reserved		

Table 0-8: Electrical connections of MAX-4 / X9

**NOTE**

Depending on the application, different cables are required for the connection to the PacDrive MAX-4 via the RJ-45 connector plug.

- Connection PacDrive Controller <-> „corporate network“ mit RJ-45
-> straight twisted-pair cable
- Connection PacDrive Controller <-> Hub
-> straight twisted-pair cable
- Connection PacDrive Controller <-> PC
-> crossover twisted-pair cable

In doubt, please contact your network administrator.

Connector plugs of MAX-4 optional modules

Fig. 0-3: Connector plug on the front side and the bottom side of the MAX-4 „special casing“

Priority	optional module	standard connector plug (alternative connector)	more alternative connector plug with special case
1 (highest)	PacNet PN-4	X15	-
2	PROFIBUS DP master	X11	-
3	PROFIBUS DP slave	X11 (X12)	X12
4	CANopen master	X11 (X12)	X12
5	CANopen slave	X11 (X12)	X12
6	CAN layer 2	X11 (X12)	X12
7	DeviceNet	X13	-
8	INC-4 (OPT-5 / 01) - 1st input (Incln_0) - 2nd input (Incln_1) - output - 24 V supply (encoder)	X14 X13 X12 X11 (X15)	X16 X17 X21 X28
9	INC-4 (OPT-5 / 02) - 1st input (Incln_0) - 2nd input (Incln_1) - 3rd input (Incln_2) - 4th input (Incln_3) - 5th input (Incln_4) - output - 5V/24V supply (enc.)		X16 X17 X18 X19 X20 X21 X28
10	INC-4 (OPT-5 / 03) - 1st input (Incln_0) - 2nd input (Incln_1) - 3rd input (Incln_2) - 4th input (Incln_3) - 5th input (Incln_4) - 1st output - 6th input (Incln_5) - 7th input (Incln_6) - 8th input (Incln_7) - 9th input (Incln_8) - 10th input (Incln_9) - 2nd output - 5V/24V supply (enc.)		X16 X17 X18 X19 X20 X21 X22 X23 X24 X25 X26 X27 X28

Fig. 0-4: Priority of the optional modules when allocating connector plugs

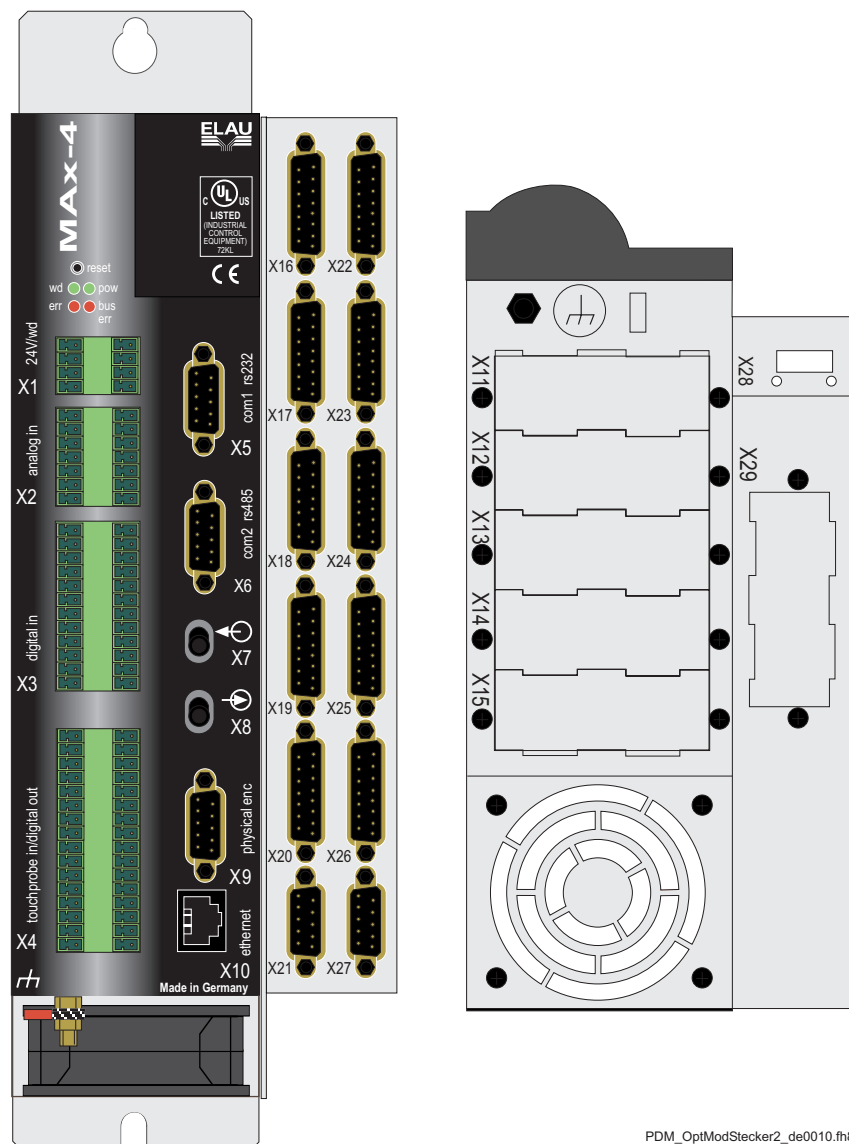

NOTE

Only one CAN or CANopen optional module can be installed per PacDrive MAX-4.

With the application of an „special casing“ the encoder supply 5 V / 24 V is always on X28.

Max. 3 option modules may be built in the PacDrive MAX-4.

Dimensions

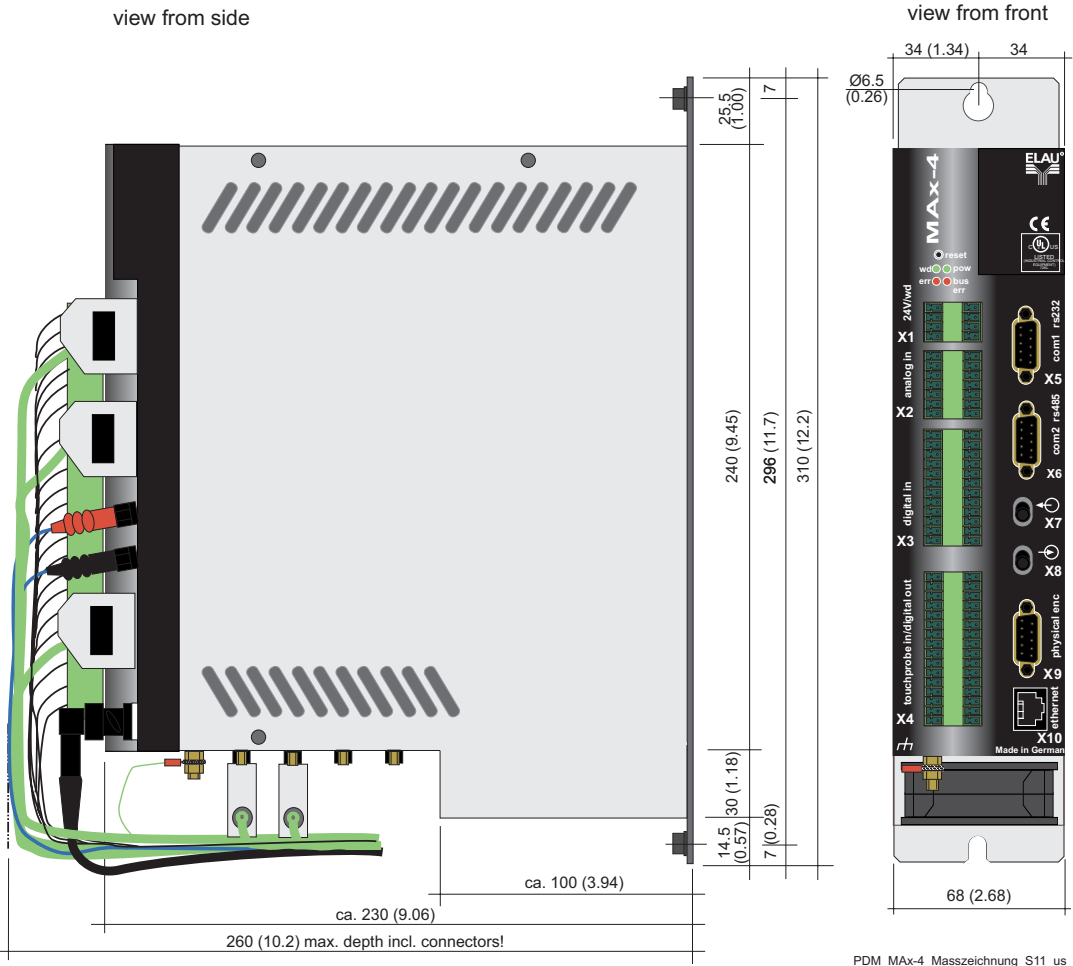

PDM_MAX-4_Masszeichnung_S11_us

Fig. 0-1: Dimensions of the PacDrive MAX-4 / "standard casing"

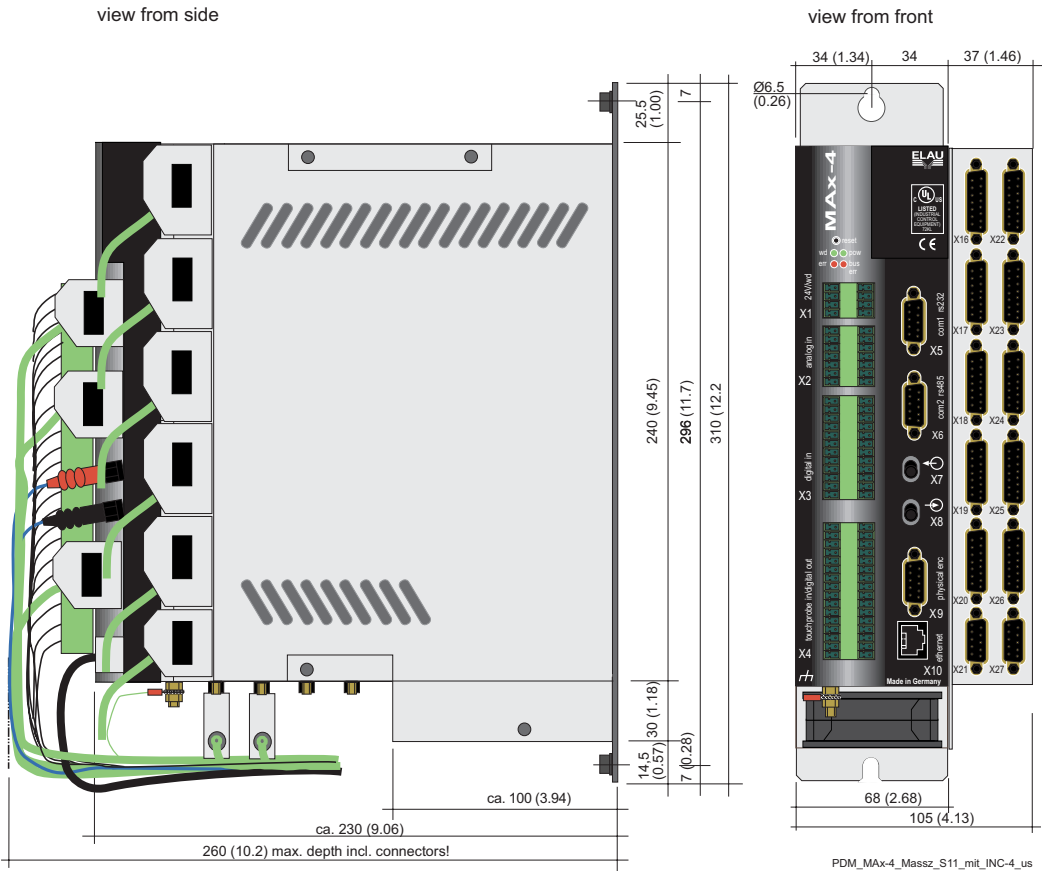

Fig. 0-2: Dimensions of the PacDrive MAX-4 / "special casing" for additional connector plugs

Option Modules

Article	Article description Article number
PROFIBUS DP Master	OM/MAX-4/PROFIBUS DP-Master 51130237
PROFIBUS DP Slave	OM/MAX-4/PROFIBUS DP-Slave 51130232
CAN Layer 2 (2.0B)	OM/MAX-4/CAN Layer 2 51130231
CANopen	OM/MAX-4/CAN-OPEN M/S 51130238
DeviceNet Slave	OM/MAX-4/DEVICE-NET Slave 51130240
Ethernet/IP Slave	in preparation
INC-4 (2 In / 1 Out)	OM/MAX-4/INC-4/10 2 In / 1 Out 51130244-001
INC-4 (5 In / 1 Out)	OM/MAX-4/INC-4/10 5 In / 1 Out 51130244-002
INC-4 (10 In / 2 Out)	OM/MAX-4/INC-4/10 10 In / 2 Out 51130244-003
INC-4 (2 In / 1 Out 24V)	OM/MAX-4/INC-4/10 2 In / 1 Out 24V 51130244-011
INC-4 (5 In / 1 Out 24V)	OM/MAX-4/INC-4/10 5 In / 1 Out 24V 51130244-012
INC-4 (10 In / 2 Out 24V)	OM/MAX-4/INC-4/10 10 In / 2 Out 24V 51130244-013
PacNet PN-4	OM/MAX-4/PN-4/10 51130258

Product ID code**MAx-4 / 11 / 03 / 016 / 08 / 0 / 0 / XX****HW-Variant**

11 (RJ-45 Ethernet connector)

Processor *)

00 = not recognized

03 = Profive T5, Intel PII 266 MHz, 32 MB RAM, L2 Cache 256 KB

Flash memory

e.g.: 016 = 16 MB

Max. no. of axes

08 = up to 8 axes

99 = more than 8 axes

Master encoder evaluation

0 = no

1 = yes

Analog input

0 = without analog input

1 = with 2 analog inputs

Optional functions

00 = none

01 = separate I/O supply

***) Note**

Previous version of the processor:

01 = Profive P5, AMD K6 266 MHz, 16 MB RAM, L2 Cache 256 KB

02 = Profive P5, AMD K6 266 MHz, 32 MB RAM, L2 Cache 256 KB

