

# SIEMENS

# SFH600 SERIES

## PHOTOTRANSISTOR OPTOCOUPLER

T-41-83

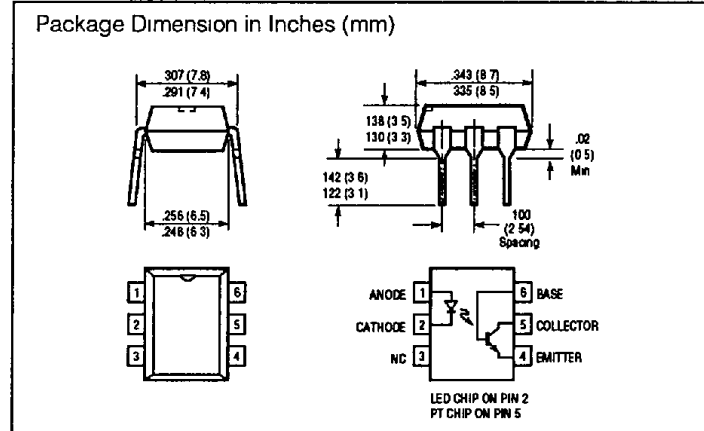
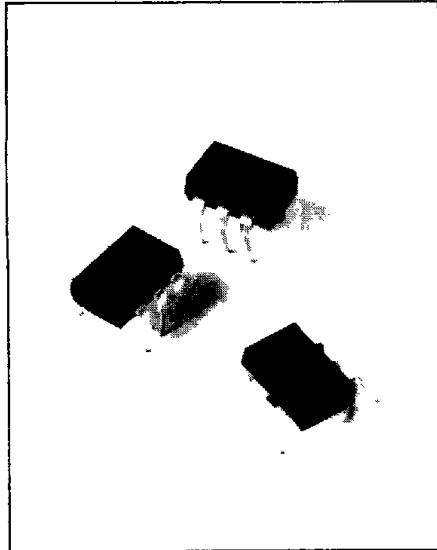

### FEATURES

- High Quality Premium Device
- Long Term Stability
- High Current Transfer Ratio, 4 Groups
  - SFH 600-0, 40 to 80%
  - SFH 600-1, 63 to 125%
  - SFH 600-2, 100 to 200%
  - SFH 600-3, 160 to 320%
- 5300 Volt Isolation (1 Minute)
- Storage Temperature -55 to +150 ° C
- VCE SAT 0.25 (< 0.4) Volt  
 $I_F = 10 \text{ mA}$ ,  $I_C = 2.5 \text{ mA}$
- UL Approval #E52744
- VDE Approval #0883
- VDE Approval #0884 (Optional with Option 1, add -X001 suffix)

### DESCRIPTION

The optoelectronic coupler SFH 600 comprises a GaAs LED as the emitter which is optically coupled with a silicon planar phototransistor as the detector. The component is located in a plastic plug-in case 20 AB DIN 41866.

The coupler allows to transfer signals between two electrically isolated circuits. The potential difference between the circuits to be coupled is not allowed to exceed the maximum permissible insulating voltage.

### Maximum Ratings

Reverse Voltage ( $V_R$ )	6 V
Forward Current ( $I_F$ )	60 mA
Surge Current ( $I_{FS}$ ), $t_D = 10 \mu s$	2.5 A
Power Dissipation ( $P_{TOT}$ )	100 mW

### Detector (Silicon Phototransistor)

Collector-Emitter Voltage ( $V_{CEQ}$ )	70 V
Emitter-Base Reverse Voltage ( $V_{EBO}$ )	7 V
Collector Current ( $I_C$ )	50 mA
Collector Current ( $I_{CS}$ ), $t = 1 \text{ ms}$	100 mA
Power Dissipation ( $P_{TOT}$ )	150 mW

### Coupler

Storage Temperature ( $T_{stor}$ )	-55 to +150 °C
Ambient Temperature ( $T_{amb}$ )	-55 to +100 °C
Junction Temperature ( $T_j$ )	100 °C
Soldering Temperature ( $T_L$ ), 1 Min	260 °C
Isolation Test Voltage (1 Min) ( $V_{IS}$ ) (between emitter and detector referred to standard climate 23/50 DIN 50014)	5300 V
Tracking Resistance	Min 8.2 mm
Air Path	Min. 7.3 mm

### Tracking Resistance

Group III (KC = > 600) in accordance with VDE0110 § 6 Table 3 and DIN 53480/VDE0303, Part 1

As to nominal isolation voltage VDE 0883 applies

Isolation Resistance ( $R_{IS}$ ) at $V_{IS} = 500 \text{ V}$	$10^{11} \Omega$
---	------------------

### Climatic Conditions

DIN 40040, Humidity Class F

### Flammability

DIN57471 or VDE0471, Part 2, of April 1975 or MIL 202E, Method 11A

### Characteristics ( $T_{amb} = 25 \text{ °C}$ )

#### Emitter (GaAs LED)

Forward Voltage ( $V_F$ ) $I_F = 60 \text{ mA}$	1.25 ( $\leq 1.65$ ) V
Breakdown Voltage ( $V_{BR}$ ) $I_R = 100 \mu A$	30 ( $\geq 6$ ) V
Reverse Current ( $I_R$ ), $V_R = 3 \text{ V}$	0.01 ( $\leq 10$ ) $\mu A$
Capacitance ( $C_C$ ) $V_R = 0 \text{ V}$ $f = 1 \text{ MHz}$	40 pF
Thermal Resistance ( $R_{Th \text{ Jamb}}$ )	750 K/W

#### Detector (Silicon Phototransistor)

Capacitance ( $V_{CE} = 5 \text{ V}$ $f = 1 \text{ MHz}$ )	
$C_{CE}$	5.2 pF
$C_{CB}$	6.5 pF
$C_{EB}$	9.5 pF
Thermal Resistance ( $R_{Th \text{ Jamb}}$ )	500 K/W

#### Coupler

Collector Emitter Saturation Voltage ( $V_{CE \text{ sat}}$ )	
$I_F = 10 \text{ mA}$ $I_C = 2.5 \text{ mA}$	0.25 ( $\leq 0.4$ ) V
Coupling Capacitance ( $C_K$ )	0.55 pF

The optocouplers are grouped according to their current transfer ratio  $I_C/I_F$  at  $V_{CE}=5\text{ V}$ , marked by dash numbers.

	-0	-1	-2	-3	
$I_C/I_F$ ( $I_F=10\text{ mA}$ )	40-80	63-125	100-200	160-320	%
$I_C/I_F$ ( $I_F=1\text{ mA}$ )	30(>13)	45(>22)	70(>34)	90(>56)	%
Collector-Emitter Leakage Current ( $V_{CE}=10\text{ V}$ ) ( $I_{CEO}$ )	2 ( $\leq 35$ )	2 ( $\leq 35$ )	5 ( $\leq 35$ )	5 ( $\leq 70$ )	nA

**Linear Operation (without saturation)**

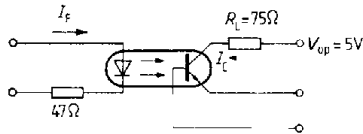

$I_F=10\text{ mA}$ ,  $V_{OP}=5\text{ V}$ ,  $T_{amb}=25^\circ\text{C}$

Load Resistance	$R_L$	75	$\Omega$
Turn-On Time	$t_{ON}$	3.2 ( $\leq 4.6$ )	$\mu\text{s}$
Rise Time	$t_r$	2.0 ( $\leq 3.0$ )	$\mu\text{s}$
Turn-Off Time	$t_{OFF}$	3.0 ( $\leq 4.0$ )	$\mu\text{s}$
Fall Time	$t_f$	2.5 ( $\leq 3.3$ )	$\mu\text{s}$
Cut-Off Frequency	$F_{CO}$	250	KHz

**Switching Operation (with saturation)**

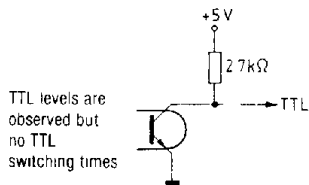
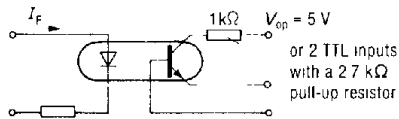

Group	-0 ( $I_F=20\text{ mA}$ )	-1 and -2 ( $I_F=10\text{ mA}$ )	-3 ( $I_F=5\text{ mA}$ )	
Turn-On Time $t_{ON}$	3.7 ( $\leq 5.8$ )	4.5 ( $\leq 6.2$ )	5.8 ( $\leq 8.0$ )	$\mu\text{s}$
Rise Time $t_r$	2.5 ( $\leq 4.0$ )	3.0 ( $\leq 4.2$ )	4.0 ( $\leq 5.5$ )	$\mu\text{s}$
Turn-Off Time $t_{OFF}$	19 ( $\leq 25$ )	21 ( $\leq 27$ )	24 ( $\leq 31$ )	$\mu\text{s}$
Fall Time $t_f$	11 ( $\leq 14$ )	12 ( $\leq 15$ )	14 ( $\leq 18$ )	$\mu\text{s}$
$V_{CESAT}$	0.25 ( $\leq 0.4$ )			V

Optocouplers  
(Optoisolators)

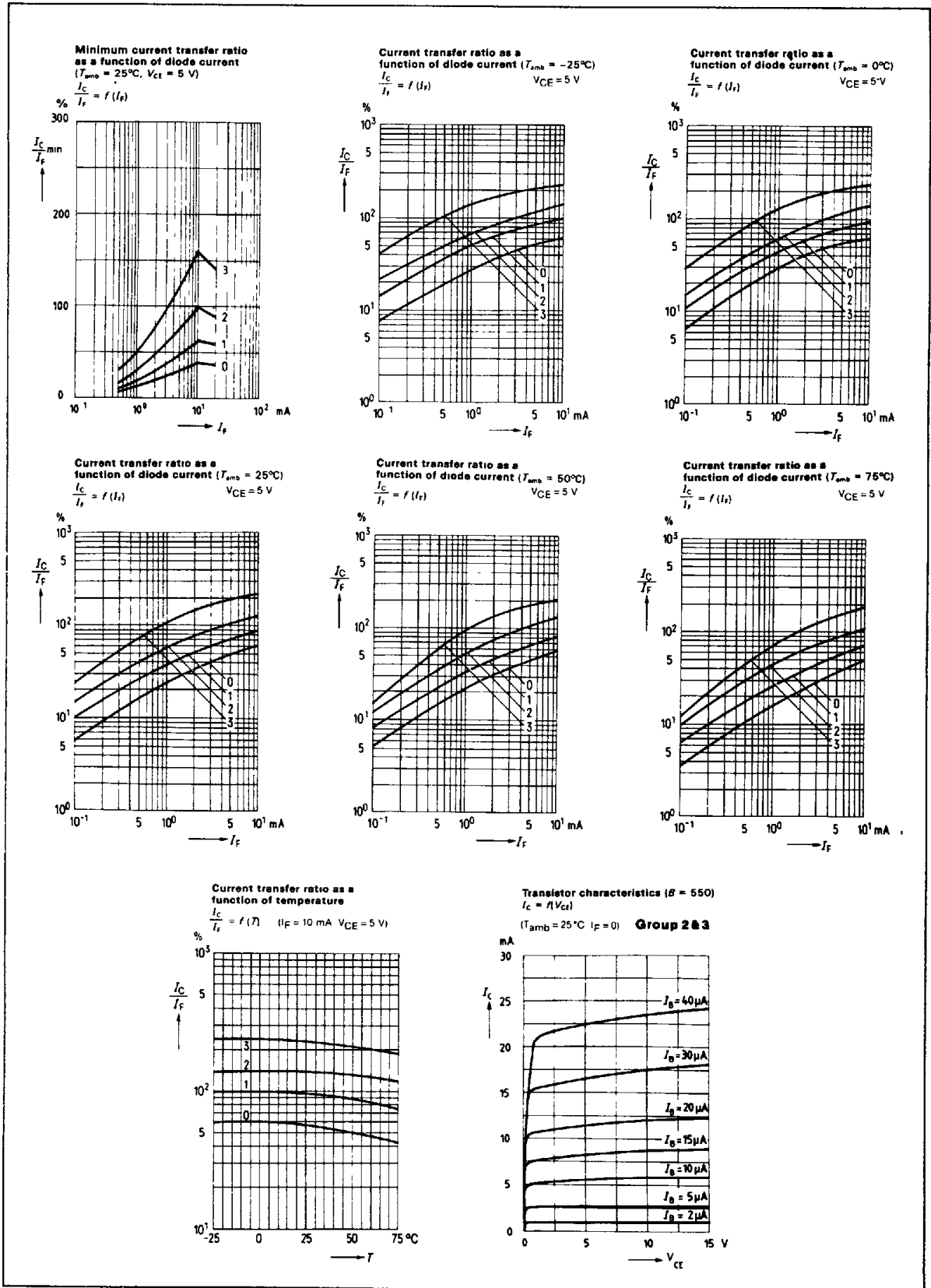

SFH 600

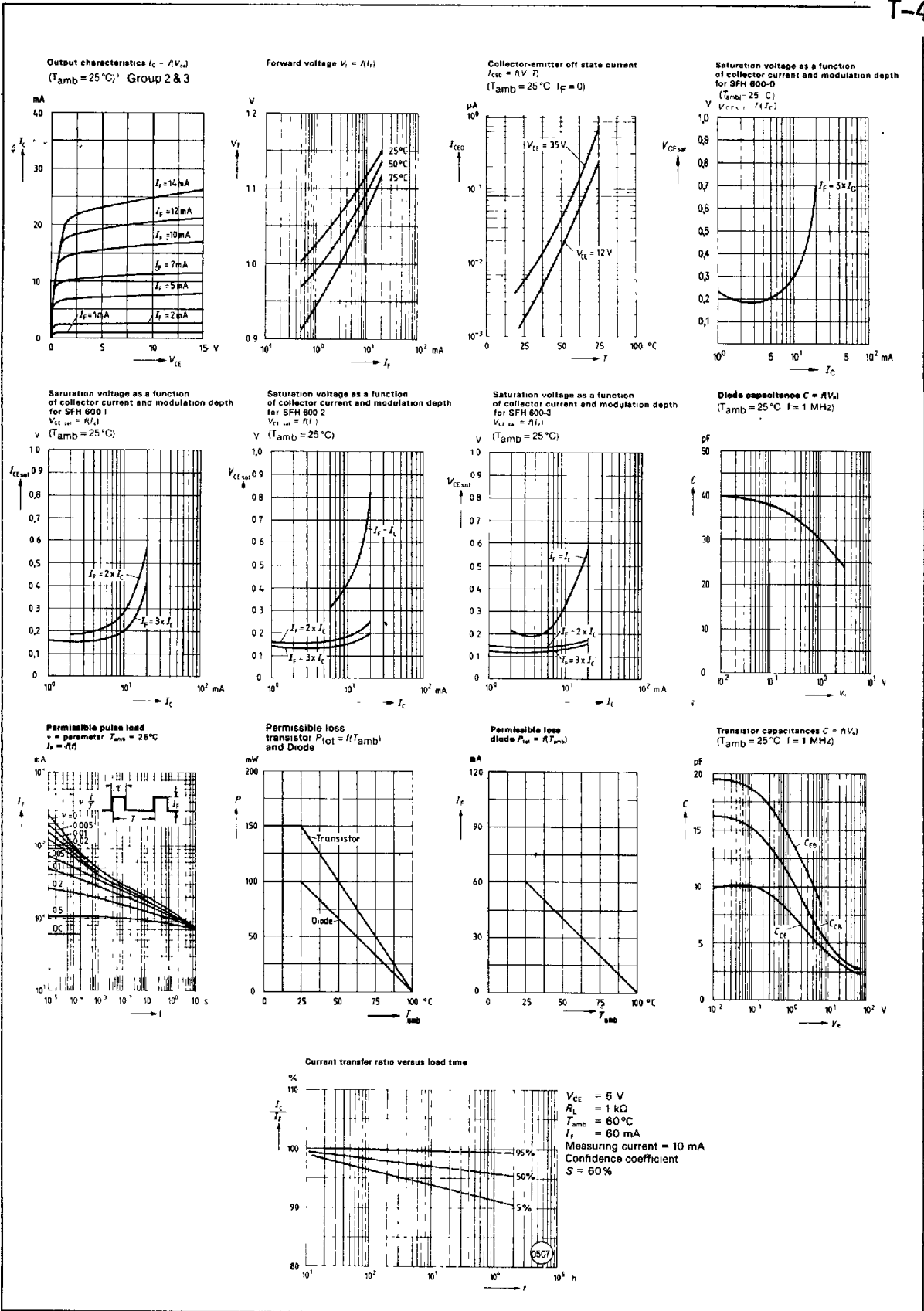

Optocouplers (Optoisolators)