

Mains connection 3x 400 V

Motor type	n_N	M_0	M_{max}	M_N	P_N	I_0	I_N	I_{max}	U_N	f_N	η
	[min ⁻¹]	[Nm]	[Nm]	[Nm]	[kW]	[A]	[A]	[A]	[V]	[Hz]	[%]
MDSKS□□036-13	4000	0.7	3.1	0.6	0.25	0.9	0.9	5.0	245	200	66
MDSKS□□036-23	4000	1.5	7.2	1.3	0.54	1.3	1.1	7.5	345	200	83
MDSKS□□056-23	3800	3.2	11.6	2.8	1.10	2.6	2.3	10.0	330	190	85
MDSKS□□056-33	4000	4.7	17.2	4.2	1.80	4.0	3.6	16.0	325	200	87
MDSKS□□071-03	3400	6.7	23.6	5.7	2.00	4.9	4.2	19.0	330	170	85
MDSKS□□071-13	3700	10.0	35.2	8.3	3.20	8.4	7.0	32.0	325	185	82
MDSKS□□071-33	3600	14.7	52.0	12.3	4.60	11.9	10.0	45.0	325	180	82
MDFKS□□071-03	3300	8.8	23.6	7.7	2.60	6.6	5.6	19.0	330	165	81
MDFKS□□071-13	3600	13.3	35.2	11.7	4.10	11.1	9.2	32.0	325	180	79
MDFKS□□071-33	3500	19.3	52.0	17.0	5.90	15.6	13.1	45.0	325	175	80

Motor type	J_M ¹⁾	$kE_{LL 150^\circ C}$	$R_{UV 20^\circ C}$	$R_{UV 150^\circ C}$	L_{St}	$kt_{0 150^\circ C}$	n_{max} ²⁾	m ¹⁾	Socket
	[kgcm ²]	[V/1000 min ⁻¹]	[Ω]	[Ω]	[mH]	[Nm/A]	[min ⁻¹]	[kg]	
MDSKS□□036-13	0.22	47.2	29.3	36.6	47.4	0.72	8000	1.5	EWS0001 EWS1001
MDSKS□□036-23	0.36	74.5	28.7	38.7	39.9	1.2	8000	2.1	EWS0001 EWS1001
MDSKS□□056-23	1.20	78.1	10.1	13.6	17.1	1.23	5500	5.3	EWS0001 EWS1001
MDSKS□□056-33	1.80	74.6	5.1	6.9	10.8	1.18	5500	6.3	EWS0001 EWS1001
MDSKS□□071-03	6.00	93.0	3.4	4.6	10.6	1.37	5000	8.9	EWS0001 EWS1001
MDSKS□□071-13	8.00	84.5	1.5	2.1	5.3	1.19	5000	10.9	EWS0001 EWS1001
MDSKS□□071-33	10.00	88.2	1.1	1.6	5.8	1.24	5000	13.0	EWS0001 EWS1001
MDFKS□□071-03	6.00	93.0	3.4	4.6	10.6	1.33	5000	10.2	EWS0001 EWS1001
MDFKS□□071-13	8.00	84.5	1.5	2.1	5.3	1.2	5000	12.2	EWS0001 EWS1001
MDFKS□□071-33	10.00	88.2	1.1	1.6	5.8	1.24	5000	12.2	EWS0001 EWS1001

¹⁾ Without brake.

²⁾ Mechanically permissible maximum speed.

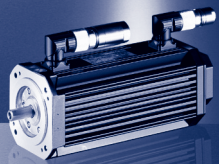

MD□KS synchronous servo motor

Rated data

Permissible radial and axial forces

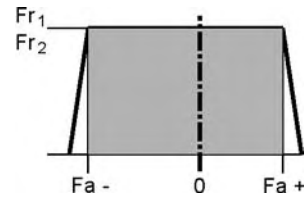
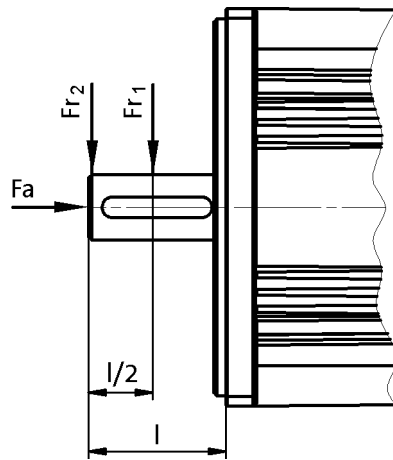

Motor type	L_{10} [h]	Application of force Fr_1 at $l/2$			Application of force Fr_2 at l		
		Fr_1 [N]	Fa [N]	Fa [N]	Fr_2 [N]	Fa [N]	Fa [N]
MDSKS□□036	5000	620	-135	245	580	-135	245
	10000	495	-80	190	460	-80	190
	20000	390	-35	145	365	-35	145
	30000	340	-10	120	320	-10	120
	50000	290	10	100	270	10	100
MDSKS□□056	5000	590	-90	280	550	-90	280
	10000	470	-40	230	430	-40	230
	20000	370	0	190	340	0	190
	30000	310	10	180	290	10	180
	50000	220		180	200		180
MD□KS□□071	5000	910	-50	520	820	-50	520
	10000	700			630		
	20000	430	20	450	390	20	450
	30000	310			280		
	50000	50	-50	520	40	-50	520

- ▶ The values for the bearing service life L_{10} refer to an average speed of 4000 min^{-1} . Depending on the ambient temperatures, the service life of the bearings is also reduced by the grease lifetime.

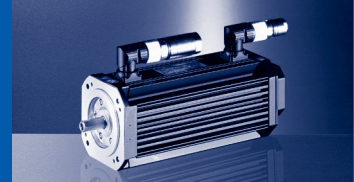

Mains connection 3x 400 V

Motors without fans

					E94A□□	E0024	E0034	E0044	E0074	E0134	E0174
					I_N	1.9	3.1	5.0	8.8	16.3	20.6
					I_{0max}	6.0	10.0	16.0	21.0	39.0	49.5
MDSKS	M_N	n_N	I_N	P_N	I_{max}	6.0	10.0	16.0	21.0	39.0	49.5
036-13	0.6	4000	0.9	0.25	M_0	0.6					
					M_N	0.6					
					M_{0max}	3.1					
					M_{max}	3.1					
					η_{Eck}	-					
036-23	1.3	4000	1.1	0.54	M_0	1.5	1.5				
					M_N	1.3	1.3				
					M_{0max}	6.2	7.2				
					M_{max}	6.2	7.2				
					η_{Eck}	-	-				
056-23	2.8	3800	2.3	1.10	M_0	2.3	3.2				
					M_N	2.3	2.8				
					M_{0max}	7.5	11.6				
					M_{max}	7.5	11.6				
					η_{Eck}	-	-				
056-33	4.2	4000	3.6	1.80	M_0		3.6	4.7			
					M_N		3.6	4.2			
					M_{0max}		12.0	17.2			
					M_{max}		12.0	17.2			
					η_{Eck}		-	-			
071-03	5.7	3400	4.2	2.00	M_0		4.2	6.7	6.7		
					M_N		4.2	5.7	5.7		
					M_{0max}		15.2	21.4	23.6		
					M_{max}		15.2	21.4	23.6		
					η_{Eck}		-	-	-		
071-13	8.3	3700	7.0	3.20	M_0			6.0	10.0	10.0	
					M_N			5.9	8.3	8.3	
					M_{0max}			22.0	27.1	35.2	
					M_{max}			22.0	27.1	35.2	
					η_{Eck}			-	-	-	
071-33	12.3	3600	10.0	4.60	M_0				10.9	14.7	14.7
					M_N				10.8	12.3	12.3
					M_{0max}				31.2	48.3	52.0
					M_{max}				31.2	48.3	52.0
					η_{Eck}				-	-	-

► $I...$ [A], $M...$ [Nm], $n...$ [min^{-1}], $P...$ [kW]

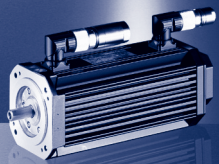

MD□KS synchronous servo motor

Selection tables for the 9400 Servo Drives

Mains connection 3x 400 V

Motors with blower

					E94A□□	E0044	E0074	E0134	E0174
					I_N	5.0	8.8	16.3	20.6
					I_{0max}	16.0	21.0	39.0	49.5
MDFKS	M_N	n_N	I_N	P_N	I_{max}	16.0	21.0	39.0	49.5
071-03	7.7	3300	5.6	2.60	M_0	6.7	8.8		
					M_N	6.7	7.5		
					M_{0max}	21.6	23.6		
					M_{max}	21.6	23.6		
					η_{Eck}	-	-		
071-13	11.7	3600	9.2	4.10	M_0		10.5	13.3	
					M_N		10.5	11.0	
					M_{0max}		27.8	35.2	
					M_{max}		27.8	35.2	
					η_{Eck}		-	-	
071-33	17.0	3500	13.1	5.90	M_0			19.3	19.3
					M_N			16.2	16.2
					M_{0max}			48.8	52.0
					M_{max}			48.8	52.0
					η_{Eck}			-	-

► $I...$ [A], $M...$ [Nm], $n...$ [min^{-1}], $P...$ [kW]

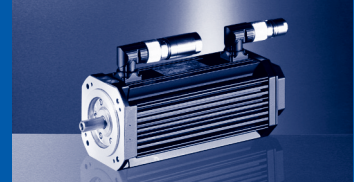

Mains connection 3x 400 V

Motors without fans

					ECS□□	004C□B	008C□B	016C□B	032C□B	048C□B	
					I_N	2.0	4.0	8.0	12.7	17.0	
					I_{0max}	2.3	4.6	9.1	18.1	27.2	
MDSKS	M_N	n_N	I_N	P_N	I_{max}	4.0	8.0	16.0	32.0	48.0	
036-13	0.6	4000	0.9	0.25	M_0	0.6	0.7				
					M_N	0.6	0.6				
					M_{0max}	1.6	2.8				
					M_{max}	2.5	3.1				
					η_{Eck}	3359	2414				
036-23	1.3	4000	1.1	0.54	M_0	1.5	1.5				
					M_N	1.3	1.3				
					M_{0max}	2.8	5.1				
					M_{max}	4.5	7.2				
					η_{Eck}	2501	1086				
056-23	2.8	3800	2.3	1.10	M_0		3.2	3.2			
					M_N		2.8	2.8			
					M_{0max}		5.9	10.7			
					M_{max}		9.6	11.6			
					η_{Eck}		2816	2452			
056-33	4.2	4000	3.6	1.80	M_0		4.7	4.7			
					M_N		4.2	4.2			
					M_{0max}		5.4	11.1			
					M_{max}		9.9	17.2			
					η_{Eck}		3620	2705			
071-03	5.7	3400	4.2	2.00	M_0		5.5	6.7			
					M_N		5.4	5.7			
					M_{0max}		6.2	14.1			
					M_{max}		12.7	21.4			
					η_{Eck}		3177	2750			
071-13	8.3	3700	7.0	3.20	M_0			9.5	10.0		
					M_N			8.3	8.3		
					M_{0max}			10.8	24.3		
					M_{max}			22.0	35.2		
					η_{Eck}			3517	3000		
071-33	12.3	3600	10.0	4.60	M_0			9.9	14.7	14.7	
					M_N			9.8	12.3	12.3	
					M_{0max}			11.2	27.6	38.1	
					M_{max}			24.8	42.7	52.0	
					η_{Eck}			3368	2840	2350	

► $I...$ [A], $M...$ [Nm], $n...$ [min^{-1}], $P...$ [kW]

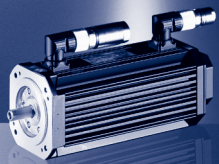

MDKS synchronous servo motor

Selection tables for the ECS servo system

Mains connection 3x 400 V

Motors with blower

ECS□□					008C□B	016C□B	032C□B	048C□B
I_N					4.0	8.0	12.7	17.0
I_{0max}					4.6	9.1	18.1	27.2
MDFKS	M_N	n_N	I_N	P_N	I_{max}			
					8.0	16.0	32.0	48.0
071-03	7.7	3300	5.6	2.60	M_0	5.3	8.8	
					M_N	5.4	7.5	
					M_{0max}	6.2	14.6	
					M_{max}	13.2	21.6	
					n_{Eck}	3177	2750	
071-13	11.7	3600	9.2	4.10	M_0		9.6	13.3
					M_N		9.6	11.0
					M_{0max}		10.9	25.0
					M_{max}		22.8	35.2
					n_{Eck}		3517	3000
071-33	17.0	3500	13.1	5.90	M_0			15.7
					M_N			15.7
					M_{0max}			22.4
					M_{max}			43.6
					n_{Eck}			2840
							19.3	
							16.2	
							39.2	
							52.0	
							2350	

► $I...$ [A], $M...$ [Nm], $n...$ [min^{-1}], $P...$ [kW]

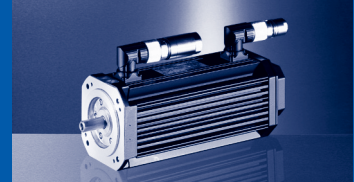

Mains connection 3x 400 V

Motors without fans

					EVS	9321-E□	9322-E□	9323-E□	9324-E□	9325-E□	9326-E□	9327-E□	
					I_N	1.5	2.5	3.9	7.0	13.0	23.5	32.0	
					I_{0max}	2.3	3.8	5.9	10.5	19.5	23.5	32.0	
MDSKS	M_N	n_N	I_N	P_N	I_{max}	2.3	3.8	5.9	10.5	19.5	35.3	48.0	
036-13	0.6	4000	0.9	0.25	M_0	0.6	0.6						
					M_N	0.6	0.6						
					M_{0max}	1.6	2.4						
					M_{max}	1.6	2.4						
					n_{Eck}	4845	3505						
036-23	1.3	4000	1.1	0.54	M_0	1.5	1.5	1.5					
					M_N	1.3	1.3	1.3					
					M_{0max}	2.8	4.3	6.1					
					M_{max}	2.8	4.3	6.1					
					n_{Eck}	3443	2598	1645					
056-23	2.8	3800	2.3	1.10	M_0		3.1	3.2	3.2				
					M_N		2.8	2.8	2.8				
					M_{0max}		4.9	7.4	11.6				
					M_{max}		4.9	7.4	11.6				
					n_{Eck}		3601	3248	2452				
056-33	4.2	4000	3.6	1.80	M_0			4.6	4.7	4.7			
					M_N			4.2	4.2	4.2			
					M_{0max}			7.6	12.5	17.2			
					M_{max}			7.6	12.5	17.2			
					n_{Eck}			3834	3360	2455			
071-03	5.7	3400	4.2	2.00	M_0			5.3	6.7	6.7			
					M_N			5.3	5.7	5.7			
					M_{0max}			9.7	15.8	23.6			
					M_{max}			9.7	15.8	23.6			
					n_{Eck}			3291	3047	2500			
071-13	8.3	3700	7.0	3.20	M_0				8.3	10.0	10.0		
					M_N				8.3	8.3	8.3		
					M_{0max}				15.5	25.7	29.3		
					M_{max}				15.5	25.7	35.2		
					n_{Eck}				3690	3418	3000		
071-33	12.3	3600	10.0	4.60	M_0					14.7	14.7	14.7	
					M_N					12.3	12.3	12.3	
					M_{0max}					29.3	34.1	42.7	
					M_{max}					29.3	45.4	52.0	
					n_{Eck}					3252	2716	2350	

► $I...$ [A], $M...$ [Nm], $n...$ [min^{-1}], $P...$ [kW]

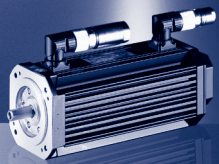

MD□KS synchronous servo motor

Selection tables for the EVS9300 servo inverter

Mains connection 3x 400 V

Motors with blower

					EVS	9323-E□	9324-E□	9325-E□	9326-E□	9327-E□
					I_N	3.9	7.0	13.0	23.5	32.0
					I_{0max}	5.9	10.5	19.5	23.5	32.0
MDFKS	M_N	n_N	I_N	P_N	I_{max}	5.9	10.5	19.5	35.3	48.0
071-03	7.7	3300	5.6	2.60	M_0	5.2	8.8	8.8		
					M_N	5.2	7.5	7.5		
					M_{0max}	7.9	16.3	23.6		
					M_{max}	7.9	16.3	23.6		
					η_{Eck}	3291	3047	2500		
071-13	11.7	3600	9.2	4.10	M_0		8.4	13.3	13.3	
					M_N		8.4	11.0	11.0	
					M_{0max}		12.6	26.4	29.9	
					M_{max}		12.6	26.4	35.2	
					η_{Eck}		3690	3418	3000	
071-33	17.0	3500	13.1	5.90	M_0			16.1	19.3	19.3
					M_N			16.1	16.2	16.2
					M_{0max}			30.5	35.2	43.6
					M_{max}			30.5	46.2	52.0
					η_{Eck}			3252	2716	2350

► $I...$ [A], $M...$ [Nm], $n...$ [min^{-1}], $P...$ [kW]

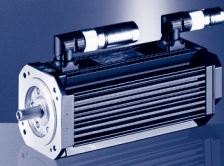

Mains connection 3x 400 V

MDSKS□□036-13

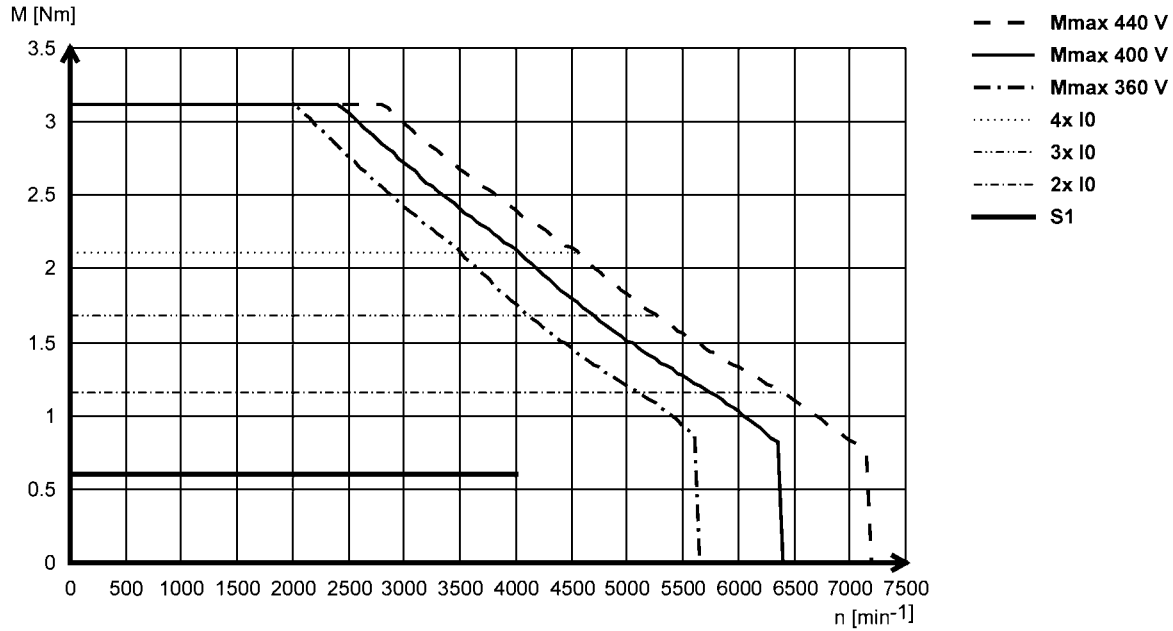

MDSKS□□036-23

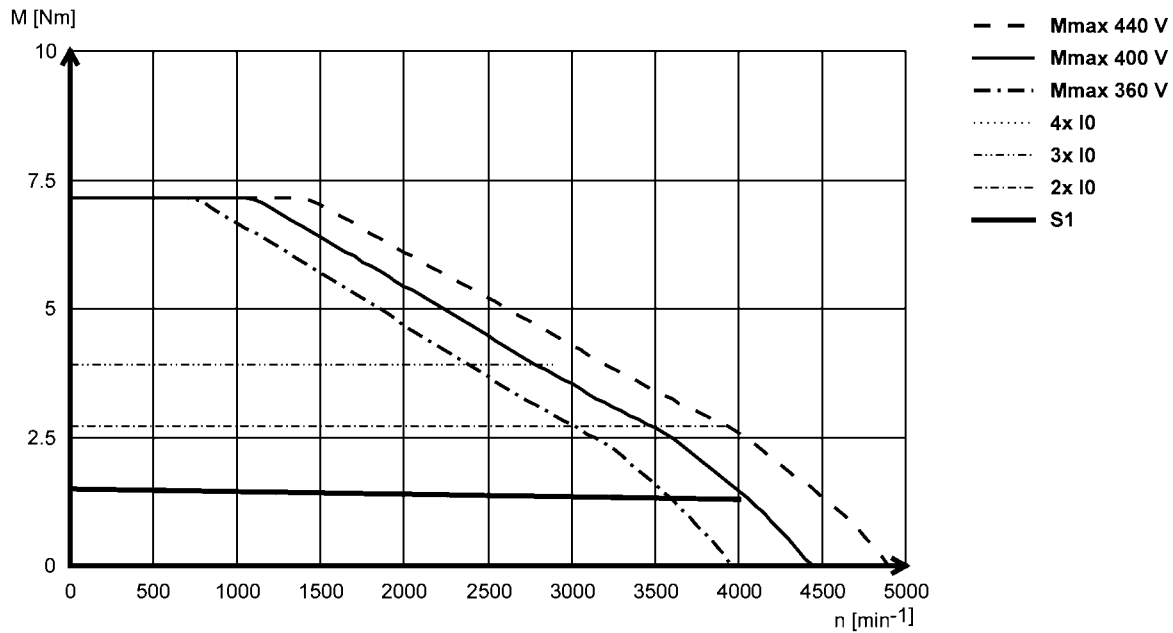

► Find more torque characteristics of the Lenze inverters at

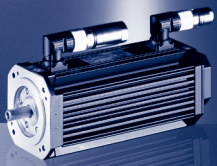

MD□KS synchronous servo motor

Torque characteristics

Mains connection 3x 400 V

MDSKS□□056-23

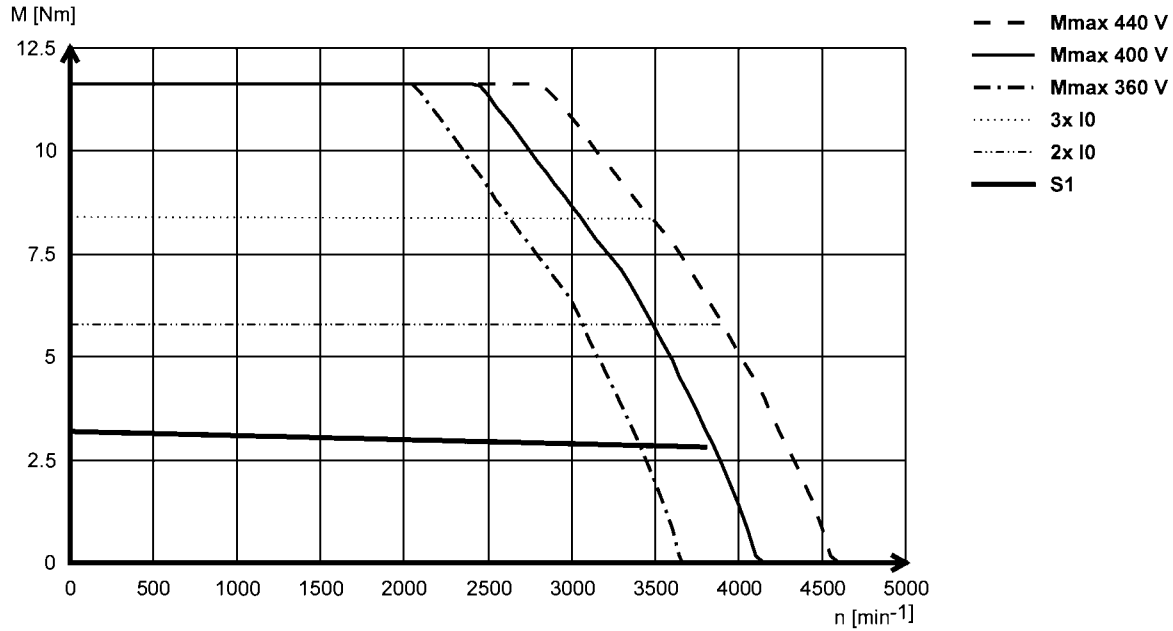

MDSKS□□056-33

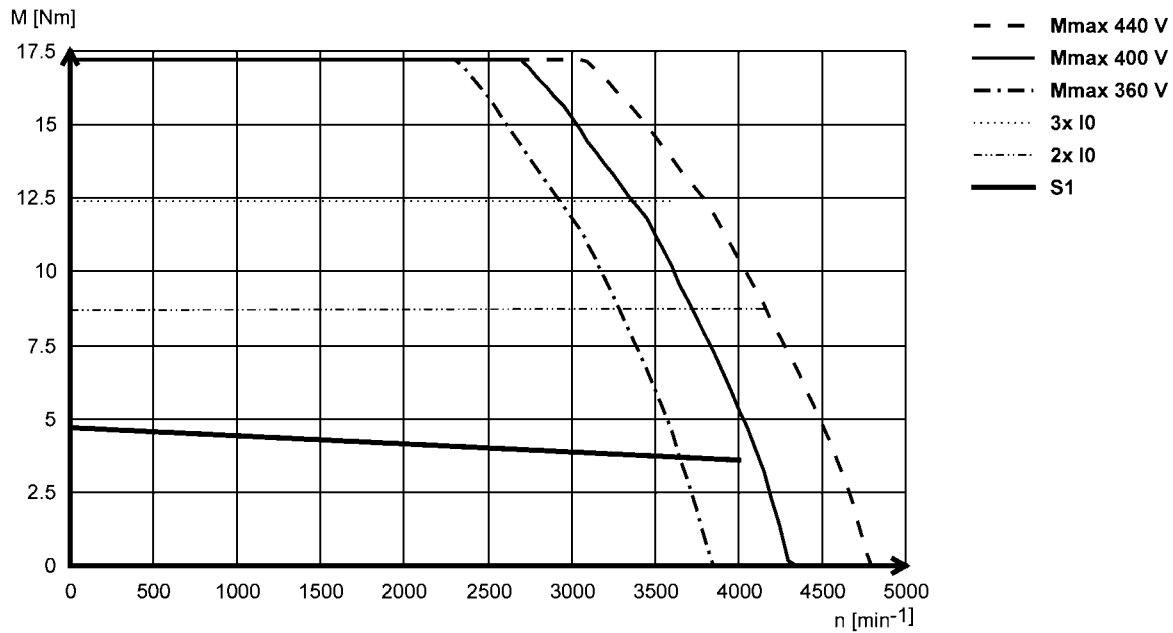

► Find more torque characteristics of the Lenze inverters at

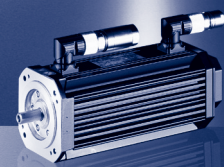

Mains connection 3x 400 V

MDSKS□□071-03

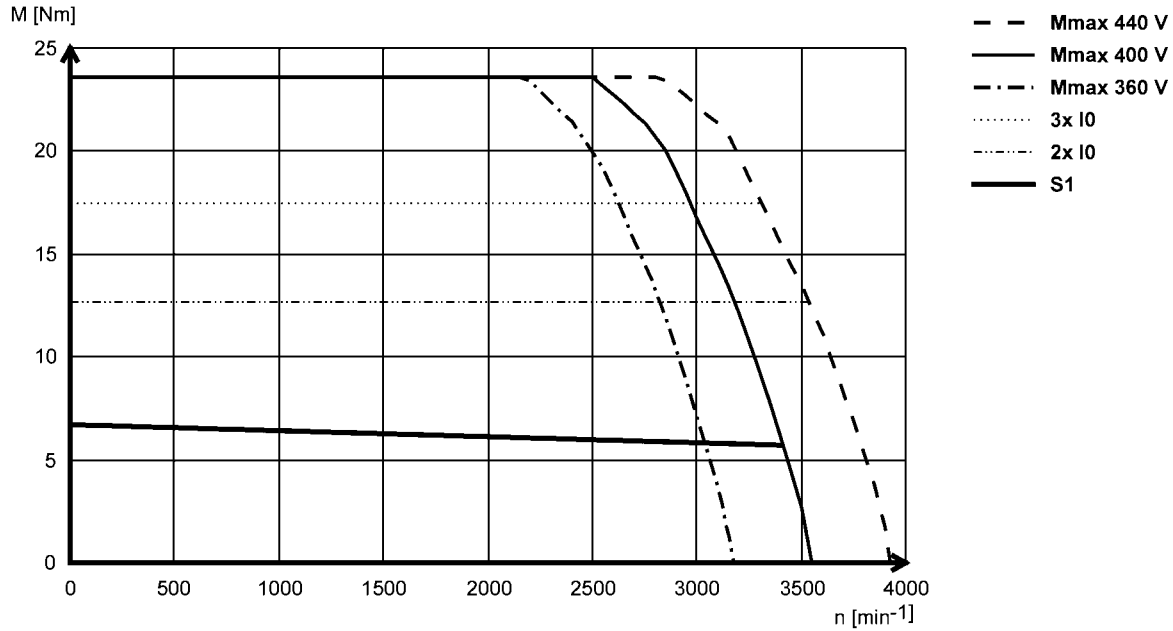

MDFKS□□071-03

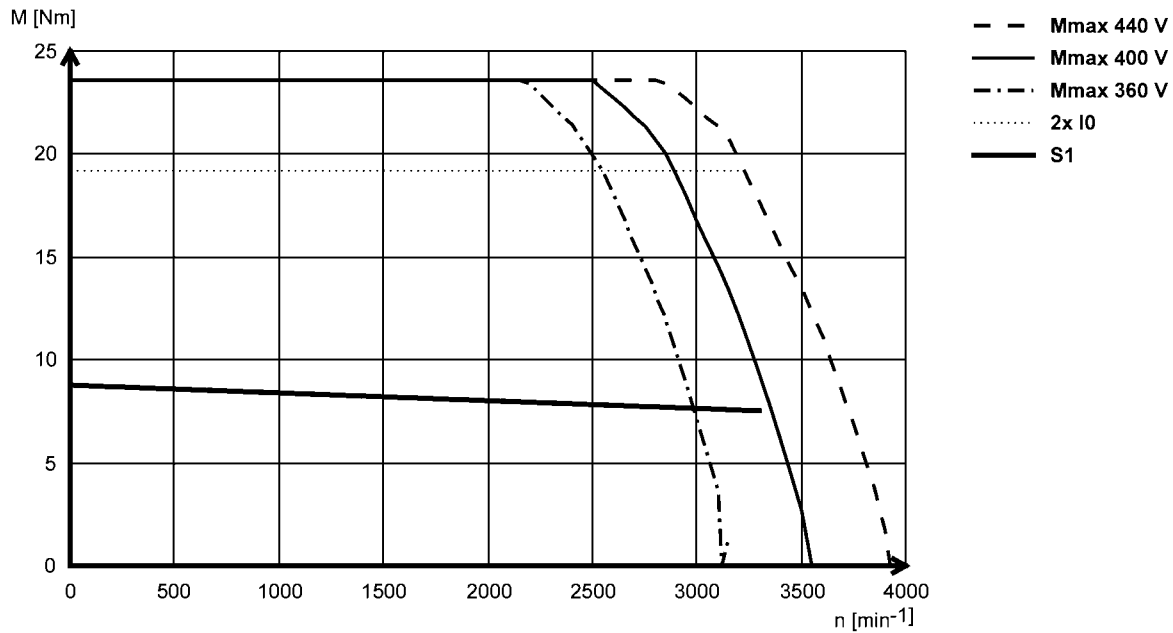

► Find more torque characteristics of the Lenze inverters at

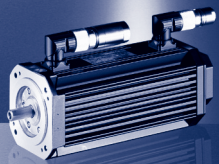

MDKS synchronous servo motor

Torque characteristics

Mains connection 3x 400 V

MDSKS□□071-13

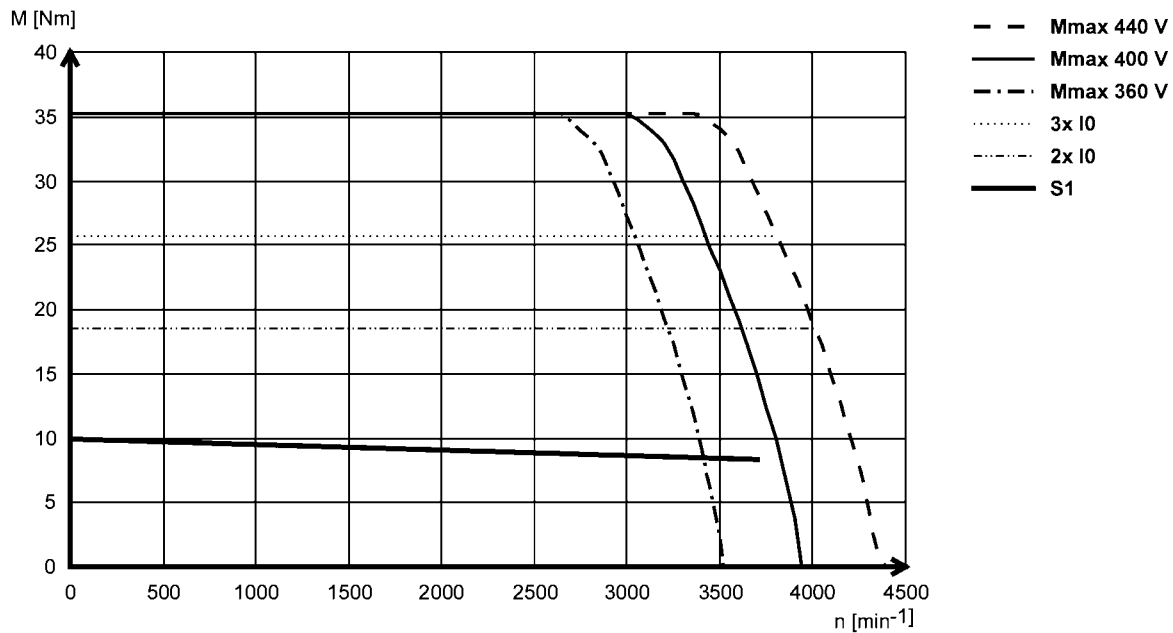

MDFKS□□071-13

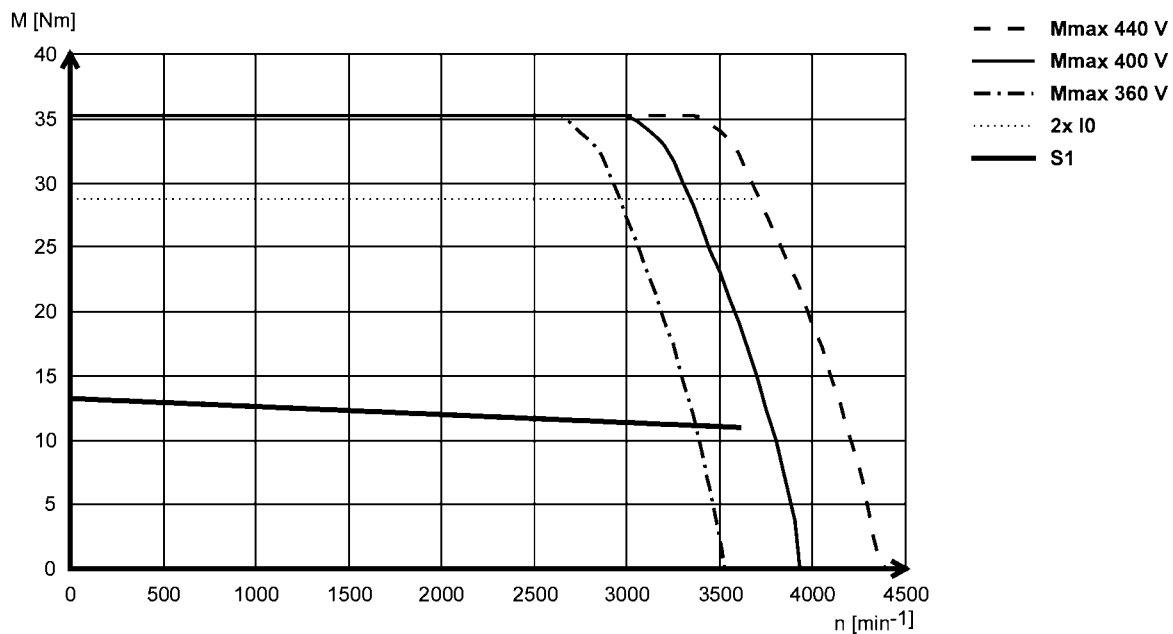

► Find more torque characteristics of the Lenze inverters at

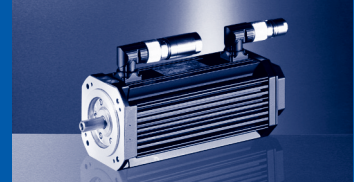

Mains connection 3x 400 V

MDSKS□□071-33

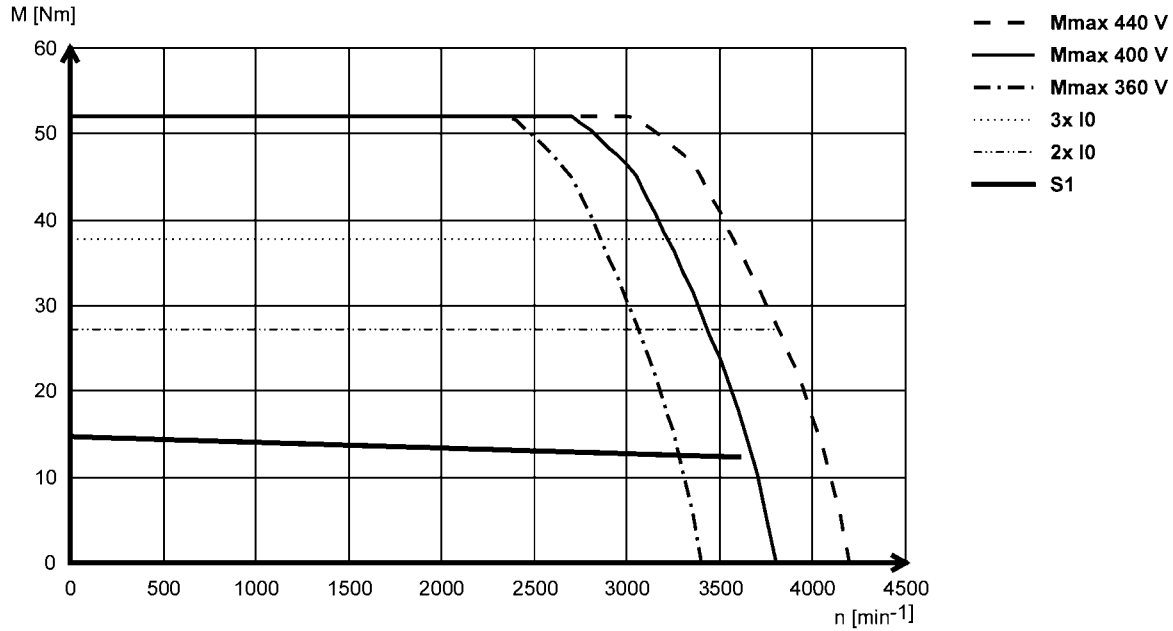

MDFKS□□071-33

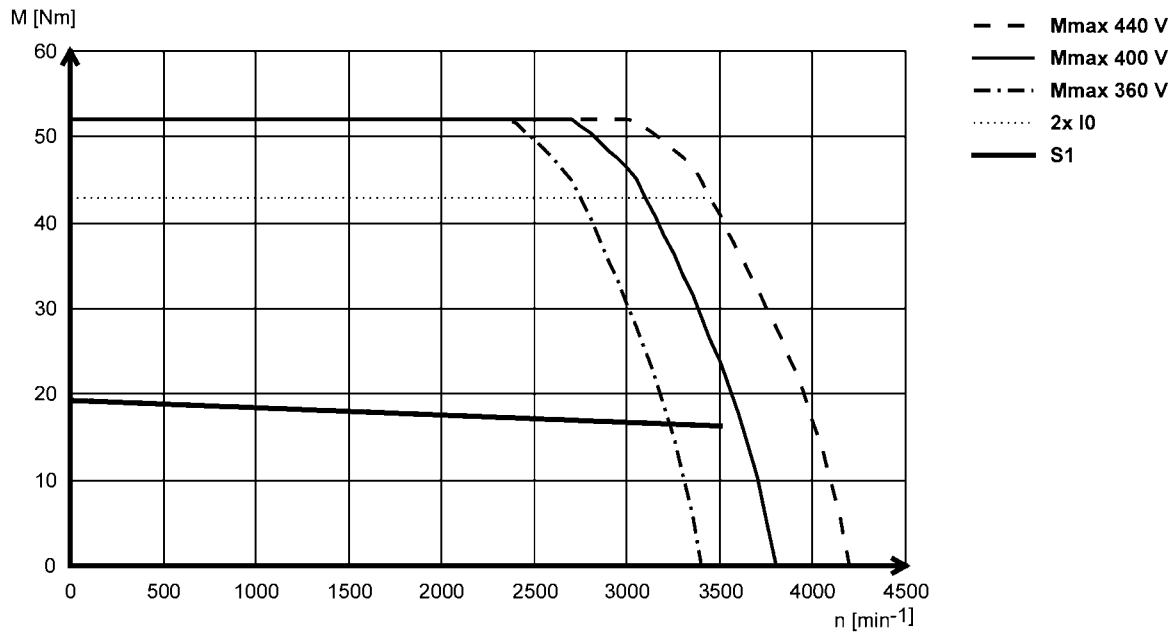

► Find more torque characteristics of the Lenze inverters at

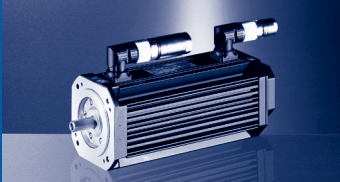

MD□KS synchronous servo motor Accessories

Terminal box for motor connection

If an MDKS servo motor is to be connected to an existing cable or where plug connectors are not to be used for other reasons, the connection can also be made via a terminal box.

Here, the motor can either be fitted with a terminal box for the power connection and motor holding brake or a second terminal box provided to connect the motor feedback and blower (if used).

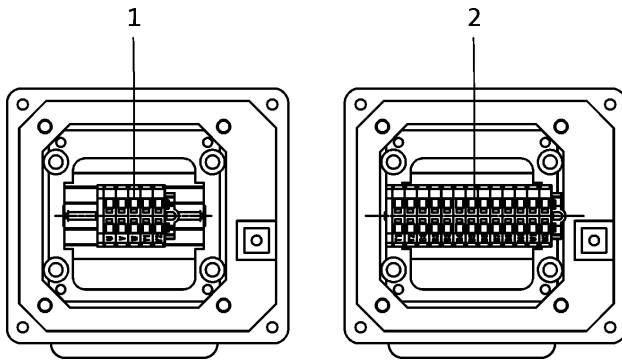

Position	Designation
1	Power connection Brake connection PE connection
2	Angle/speed sensor connection Temperature sensor connection



MD□KS synchronous servo motor with blower and terminal box

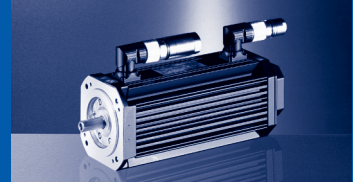

Holding brakes

The MD□KS synchronous servo motors can be fitted with integral permanent magnet holding brakes. Voltages of 24 V DC and 205 V DC are available for this purpose. The brakes are activated when the supply voltage is disconnected (closed-circuit current principle).

For traversing axes adherence to the permissible moment of inertia J_L/J_{MB} ensures that the permissible maximum switching rate of the brake will not be exceeded and up to 2000 emergency stop functions will be possible at a speed of 3000 min^{-1} .

For lifting axes the load torque resulting from the weight acts additionally. In this case the specifications for J_L/J_{MB} do not apply.

Caution:

The brakes used are not fail-safe in the true sense, because certain disruptive factors, e.g. oil ingress, may cause a reduction in torque.

If long motor supply cables are used, check the resistive voltage drop along the cable and compensate for it with a higher voltage at the cable entry.

For Lenze system cables, the following applies:

$$U[V] = U_B[V] + 0.08 \frac{[V]}{[A] \cdot [m]} \cdot I_{Lg}[m] \cdot I_B[A]$$

If an appropriate voltage is not supplied to the brake (incorrect dimension, incorrect polarity), the brake will fail and the continuing rotation of the motor could cause it to overheat, leading to irreparable damage.

DC voltage switching helps to minimise brake response times. A spark suppressor is required for interference suppression and to increase the service life of the relay contacts.



Permanent magnet holding brake

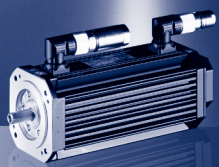

MD□KS synchronous servo motor Accessories

Holding brake data

- ▶ The data only applies to servo motors and to geared servo motors attached by means of a mounting flange.

Servo motors with B5/B14 design GPA geared servo motors

Motor type	Brake type	Brake size	Holding torque		Average dynamic torque	Rated voltage ^{3,4)} U _B [V]	Rated current ²⁾ I _B [A]	Engagement time ¹⁾ t ₁ [ms]	Disengagement time ¹⁾ t ₂ [ms]	Maximum switching energy per emergency stop with n = 3000 min ⁻¹ Q _E [J]	Moment of inertia J _B [kgcm ²]	Weight m [kg]	Brake motor moment of inertia J _{MB} [kgcm ²]	Permissible J _L / J _{MB}
			M _B [Nm] 20 °C	M _B [Nm] 120 °C	M _{Bm} [Nm] 120 °C									
MDSKSB□ 036-13	P1	05P1	4.5	4.0	3.0	24	0.34	7	35	220	0.19	0.3	0.41	107.7
MDSKSB□ 036-23	P1	05P1	4.5	4.0	3.0	24	0.34	7	35	220	0.19	0.3	0.55	80.1
MDSKSB□ 056-23	P1	06E	3.3	2.5	1.2	24	0.50	10	20	350	0.38	0.9	1.58	43.9
MDSKSB□ 056-23	P5	06E	3.3	2.5	1.2	205	0.06	10	20	350	0.38	0.9	1.58	43.9
MDSKSB□ 056-33	P1	06E	3.3	2.5	1.2	24	0.50	10	20	350	0.38	0.9	2.18	31.5
MDSKSB□ 056-33	P5	06E	3.3	2.5	1.2	205	0.06	10	20	350	0.38	0.9	2.18	31.5
MD□KSB□ 071-03	P1	07H	12.0	11.0	5.5	24	0.67	20	29	400	1.06	0.8	7.06	10.5
MD□KSB□ 071-03	P5	07H	12.0	11.0	5.5	205	0.08	20	29	400	1.06	0.8	7.06	10.5
MD□KSB□ 071-13	P1	07H	12.0	11.0	5.5	24	0.67	20	29	400	1.06	0.8	7.06	10.5
MD□KSB□ 071-13	P5	07H	12.0	11.0	5.5	205	0.08	20	29	400	1.06	0.8	7.06	10.5
MD□KSB□ 071-33	P1	07H	12.0	11.0	5.5	24	0.67	20	29	400	1.06	0.8	7.06	10.5
MD□KSB□ 071-33	P5	07H	12.0	11.0	5.5	205	0.08	20	29	400	1.06	0.8	7.06	10.5

¹⁾ Engagement and disengagement times are valid for rated voltage (± 0 %) and protective circuit for brakes with varistor for DC switching. The times may increase without a protective circuit.

²⁾ The currents are the maximum values when the brake is cold (value used for dimensioning the current supply). The values when the motor is at operating temperature are significantly lower.

³⁾ For DC 24 V brake: smoothed DC voltage, ripple ≤ 1 %.
For DC 205 V brake: connection to AC 230 V via rectifier.

⁴⁾ UR not possible in the case of a brake with a 205 V supply voltage.

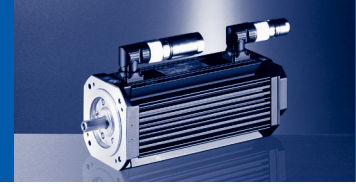

Holding brake data

- ▶ The data only applies to geared servo motors with integrated servo motor (without mounting flange).

Geared servo motors GST, GFL, GKR, GKS, GSS

Motor type	Brake type	Brake size	Holding torque		Average dynamic torque	Rated voltage ^{3,4)}	Rated current ²⁾	Engagement time ¹⁾	Disengagement time ¹⁾	Maximum switching energy per emergency stop with $n = 3000 \text{ min}^{-1}$	Moment of inertia	Weight	Brake motor moment of inertia	Permissible J_L / J_{MB}
			M_B [Nm]	M_B [Nm]	M_{Bm} [Nm]									
			20 °C	120 °C	120 °C	+ 5 % -10 %								
MDSKSB□ 056-23	P2	07H	6.0	5.0	2.5	24	0.67	20	29	400	1.06	0.8	2.26	34.9
MDSKSB□ 056-23	P6	07H	6.0	5.0	2.5	205	0.08	20	29	400	1.06	0.8	2.26	34.9
MDSKSB□ 056-33	P2	07H	6.0	5.0	2.5	24	0.67	20	29	400	1.06	0.8	2.86	27.3
MDSKSB□ 056-33	P6	07H	6.0	5.0	2.5	205	0.08	20	29	400	1.06	0.8	2.86	27.3
MD□KSB□ 071-03	P2	09E	15.0	12.0	6.0	24	0.75	13	30	550	3.60	1.4	9.60	10.6
MD□KSB□ 071-03	P6	09E	15.0	12.0	6.0	205	0.09	13	30	550	3.60	1.4	9.60	10.6
MD□KSB□ 071-13	P2	09E	15.0	12.0	6.0	24	0.75	13	30	550	3.60	1.4	9.60	10.6
MD□KSB□ 071-13	P6	09E	15.0	12.0	6.0	205	0.09	13	30	550	3.60	1.4	9.60	10.6
MD□KSB□ 071-33	P2	09E	15.0	12.0	6.0	24	0.75	13	30	550	3.60	1.4	9.60	10.6
MD□KSB□ 071-33	P6	09E	15.0	12.0	6.0	205	0.09	13	30	550	3.60	1.4	9.60	10.6

- Engagement and disengagement times are valid for rated voltage ($\pm 0\%$) and protective circuit for brakes with varistor for DC switching. The times may increase without a protective circuit.
- The currents are the maximum values when the brake is cold (value used for dimensioning the current supply). The values when the motor is at operating temperature are significantly lower.
- For DC 24 V brake: smoothed DC voltage, ripple $\leq 1\%$.
For DC 205 V brake: connection to AC 230 V via rectifier.
- UR not possible in the case of a brake with a 205 V supply voltage.

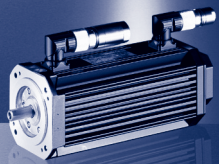

MD□KS synchronous servo motor

Accessories

Blower data

Motor type	P _N [W]	I _N [A]	U _N [V]	f _N [Hz]	T _{U,max} [°C]	Enclosure	Blower socket
MDFKS□□071-03	19	0.12	210...240, 1~	50 60	75	IP 54	EWS0003 EWS1003
MDFKS□□071-13							
MDFKS□□071-33							



Tailored to the various application cases and required accuracy, the following feedback systems are available.

Resolver

Stator-fed resolver with two stator windings offset by 90° and one rotor winding with transformer winding.

Product key		RS/BS
Resolution		0.8 '
Accuracy		± 10'
Absolute positioning		1 revolution
Design		Brushless hollow shaft "pancake" resolver
Max. speed (continuous)		8000 min ⁻¹
Max. speed (short-time)		10000 min ⁻¹
Input voltage		10 V amplitude
Input frequency		4 kHz
Stator/rotor ratio		0.3 ± 5%
Rotor impedance	Z _{ro}	51 Ω + j90 Ω
Stator impedance	Z _{so}	102 Ω + j150 Ω
Impedance	Z _{rs}	44 Ω + j76 Ω
Insulation resistance		>10 MΩ at 500 V DC
Number of pole pairs		1
Max. phase-angle error		± 10 angular minutes
Socket type		EWS0006 / EWS1006
Inverter family assignment		ECS... / EVS93... / E94A...

Incremental and SinCos absolute value encoder

Encoder type		TTL incremental	SinCos incremental	SinCos absolute value encoder			
Product key		IG/BI		AG/BA			
Designation		R35i	EQI1329	SRS50	SRM50	ECN1313	EQN1325
Vibration characteristic			Good			Very good	
Multi-turn			•		•		•
Design				Brushless			
Suspension		Metal spring		Rubber spring		Metal spring	
Pulses/cycles		4096	32	1024		2048	
Resolution (depends on device)	[°]	1.3	0.4				
Accuracy (reference value)	[°]	± 1	± 5	± 0.8		± 0.6	
Absolute revolutions		0	4096	1	4096	1	4096
Output signals		TTL 5 V		~ 1 V _{ss}			
Interface		-	EnDat	Hiperface		EnDat	
Voltage supply	[V]	5 ± 10%	5 ± 5%	7...12		5 ± 5%	
Maximum speed	[min ⁻¹]	8000	12000			15000	12000
Current consumption	[mA]	75	130	80		150	250
Limiting frequency	[kHz]	500	6	200			
Socket type		EWS0023 EWS1023	EWS0017 EWS1017	EWS0010 EWS1010		EWS0017 EWS1017	
Inverter family assignment		E94P... E94S...	E94A...	ECS... EVS93... E94A...		E94A...	

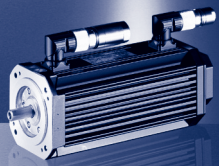

MD□KS synchronous servo motor Accessories

Thermal sensors

The thermal sensors used (1x KTY 83-110) continually monitor the motor temperature. The temperature information is passed to the servo controller via the system cable of the feedback system.

This enables the normal operating temperature of the motor to be measured very accurately and also, in the event of excess temperature in one of the winding phases, allows the controller to carry out the appropriate action.

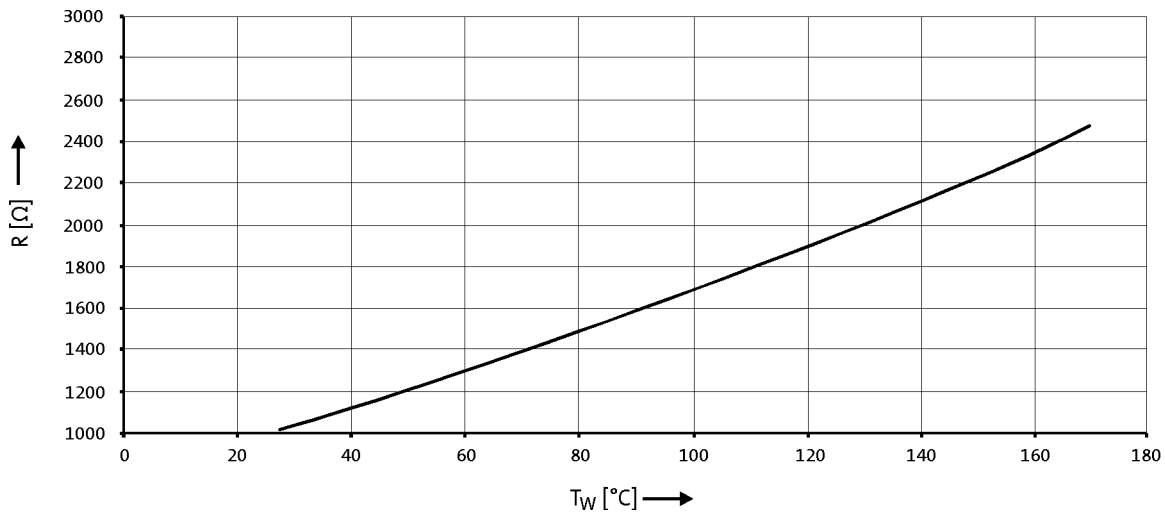

- ▶ If the sensors are supplied with a measured current of 1 mA, the above relationship between temperature and measured resistance applies.

MD□KS synchronous servo motor

Accessories

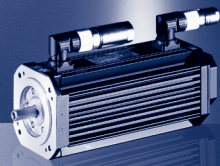

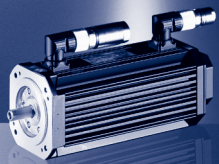

MD□KS synchronous servo motor

Dimensions [mm]

Motors without fans

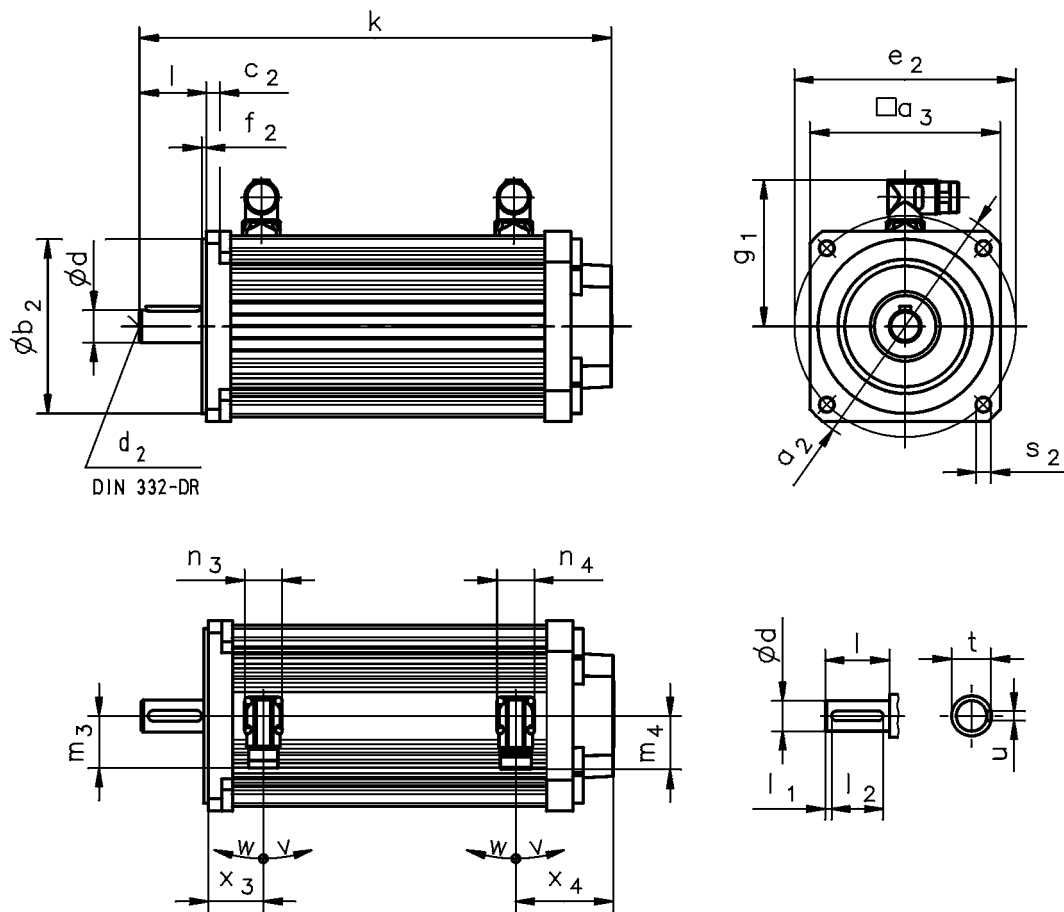

MDSKS□□		036-13	036-23	056-23	056-33	071-03	071-13	071-33
RS	k	166	190	240.5	275.5	259	294	329
	x ₃	81	105	34		37		
	x ₄	22		58		56.5		
BS	k	194	218	267	302	294	329	364
	x ₃	81	105	59		72		
	x ₄	50		58		56.5		
AG/IG	k			294	329	313	348	383
	x ₃			34		37		
	x ₄			54		110.5		
BA/BI	k			320.5	355.5	348	383	418
	x ₃			59		72		
	x ₄			54		110.5		

MD□KS synchronous servo motor

Dimensions [mm]

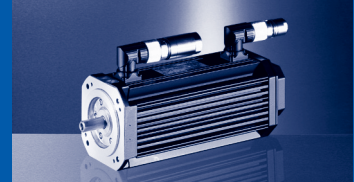

MDSKS□□			036-13	056-23	071-03
			036-23	056-33	071-13
			071-33		
	g₁		76.5	89.5	102
	n₃			28	
	n₄			28	
	m₃			40	
	m₄			40	
	v			195°	
	w			80°	

MDSKS□□			036-13	056-23	071-03
			036-23	056-33	071-13
			071-33		
	d	k6	11	14	19
	d₂		M4	M5	M6
	l		23	30	40
	l₁		3	2.5	2
	l₂		18	25	36
	u		4	5	6
	t		12.5	16	21.5

MDSKS□□			036-13	056-23		071-03	
			036-23	056-33		071-13	
			071-33				
			B5	B14	B5	B14	
				A120	C105	A160	C160
			FF75	FF100	FT85	FF130	FT130
	a₂		87	120		160	
	a₃		70	102		130	
	b₂	j6	60	80	70	110	
	c₂		14	8		9	
	e₂		75	100	85	130	
	f₂		2.5	3	2.5	3.5	
	s₂		6	7	M6	9	M8

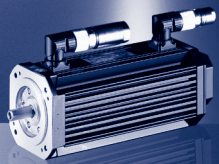

MDKS synchronous servo motor

Dimensions [mm]

Motors with blower

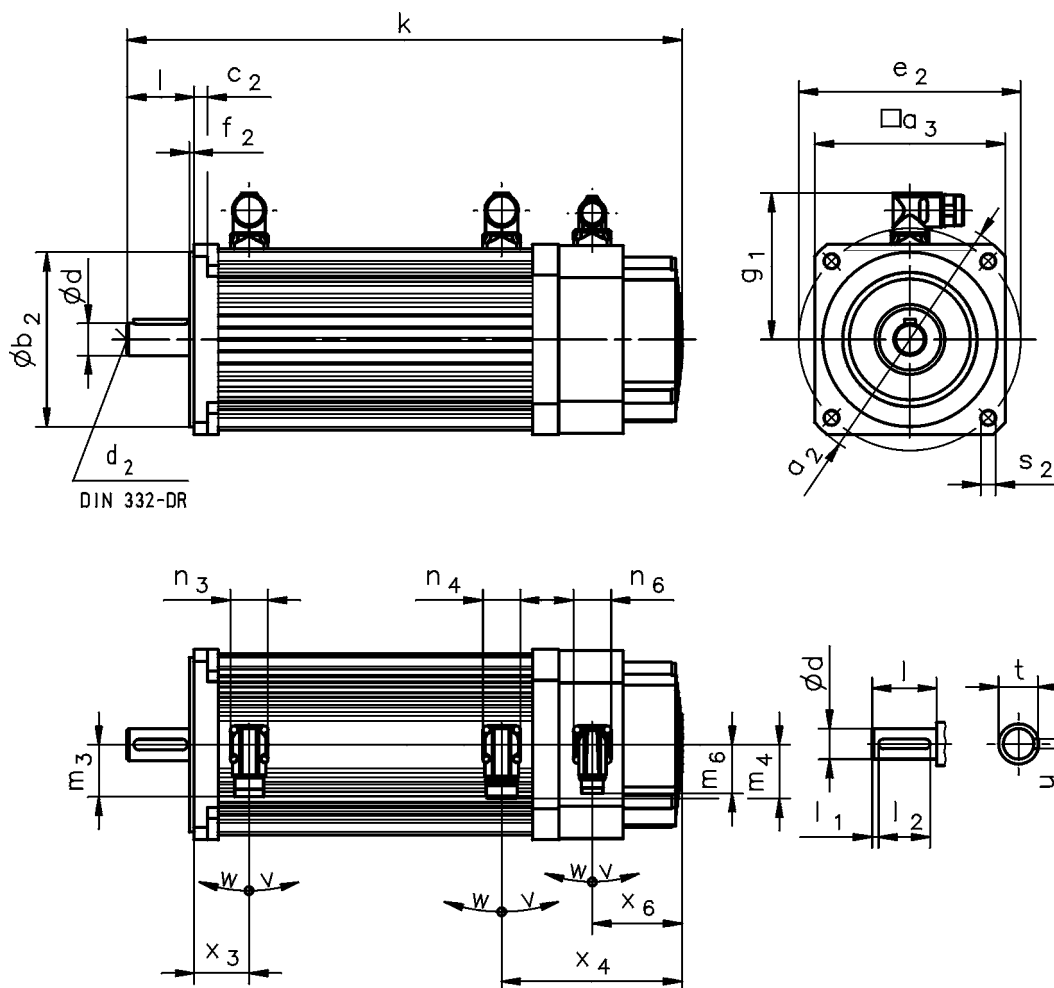

MDFKS□□		071-03	071-13	071-33
RS	k	327	362	397
	x ₃		37	
	x ₄		124.5	
BS	x ₆		73	
	k	362	397	432
	x ₃		72	
AG/IG	x ₄		124.5	
	x ₆		73	
	k	381	416	451
BA/BI	x ₃		37	
	x ₄		178.5	
	x ₆		73	
	k	416	451	486
	x ₃		72	
	x ₄		178.5	
	x ₆		73	

MD□KS synchronous servo motor

Dimensions [mm]

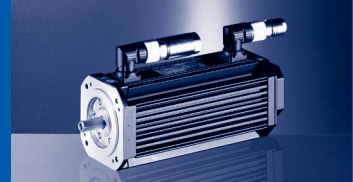

MDFKS□□		071-03
		071-13
		071-33
g₁		102
n₃		28
n₄		28
n₆		28
m₃		40
m₄		40
m₆		37
v		195 °
w		80 °

MDFKS□□		071-03
		071-13
		071-33
d	k6	19
d₂		M6
l		40
l₁		2
l₂		36
u		6
t		21.5

MDFKS□□		071-03	
		071-13	
		071-33	
		B5	B14
		A160	C160
		FF130	FT130
a₂		160	
a₃		130	
b₂	j6	110	
c₂		9	
e₂		130	
f₂		3.5	
s₂		9	M8

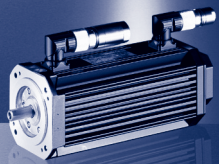

MD□KS synchronous servo motor

Dimensions [mm]

Motors with terminal box

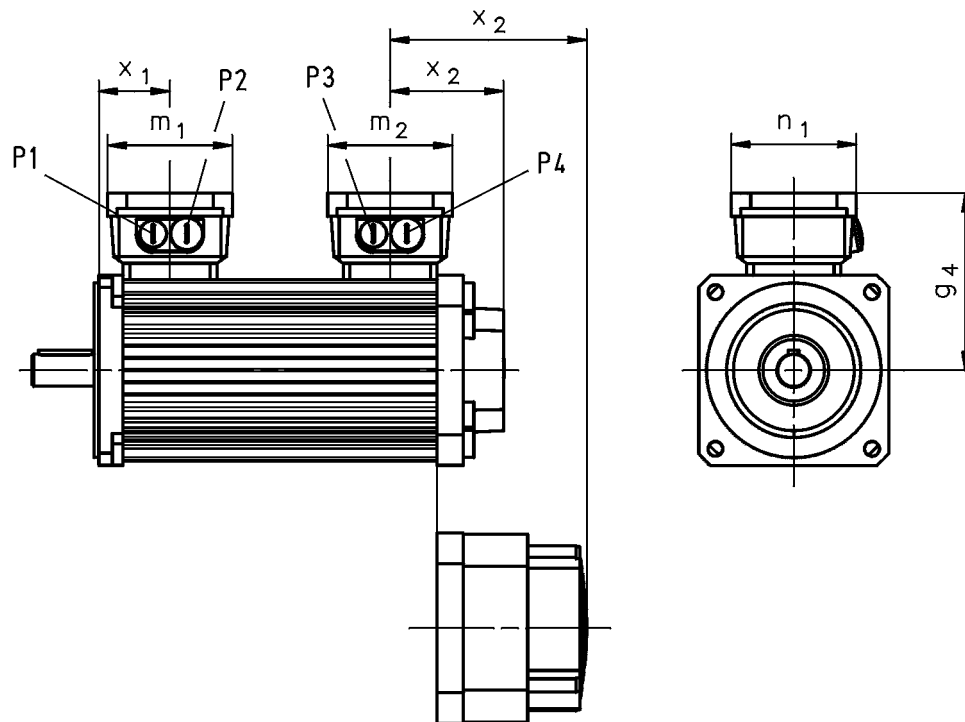

MDSKS□□		056-23	056-33	071-03	071-13	071-33
MDFKS□□				071-03	071-13	071-33
	g ₄	109		121		
	m ₁	93				
	m ₂	93				
	n ₁	93				
	x ₁	54		57		
	P1				M16x1.5	
	P2				M20x1.5	
	P3				M16x1.5	
	P4				M20x1.5	
MDSKS□□		056-23	056-33	071-03	071-13	071-33
RS	x ₂	63	78	68.5	76.5	
BS	x ₂	78		76.5		
AG/IG	x ₂	54		122.5	130.5	
BA/BI	x ₂	54		130.5		
MDFKS□□		071-03		071-13	071-33	
RS	x ₂	136.5		144.5		
BS	x ₂			144.5		
AG/IG	x ₂	190.5		198.5		
BA/BI	x ₂	198.5				