



Servoamplifiers for Brushless Motors Series:

BHL - RR

The material in this manual is for informational purposes only and is subject to change without notice. Dipl.-Ing. Engelhardt GmbH assumes no responsibility for errors or omissions, neither is any liability assumed for damages resulting from the use of the information contained herein.

All rights reserved. This document shall not be reproduced, either entirely or in part, without written authorization.

12/03/2003

Table of contents

BHL Servoamplifiers- RR Series	4
1.1 Description.....	4
1.2 Product Identification	4
1.3 Model Specification.....	4
1.4 Warning	5
1.5 Principle function	5
2. Technical Data	6
2.1 Supplies	6
2.2 Output current.....	6
2.3 Braking circuit	6
2.4 Dynamic braking.....	7
2.5 Electromagnetic brake	7
2.6 Resolver	7
2.7 Function mode.....	7
2.8 Input / Output signals.....	7
2.9 Protections.....	8
2.10 Customization	8
2.11 Connectors and LED	8
2.12 Housing	8
2.13 Operating temperature.....	9
2.14 Head sink.....	9
2.15 Others.....	9
3 Printed circuit board layout´s	10
3.1 Printed circuit board layout (new base board)	10
3.2 Printed circuit board layout (interface board)	11
4 Connections	12
4.1 Front Panel	12
4.2 Wiring diagram CNC version C-88; P-88; M-88.....	13
4.3 Wiring diagram CNC version D-22; F-22; S-44.....	14
4.4 Wiring diagram CNC version M-10	15
4.5 Main supply connections	16
4.6 Motor connections	16
4.7 Clamp resistor connections	17
4.8 Brake and auxiliary Connections	17
4.9 Connections to the control unit	18
4.10 Connections to resolver	19
4.11 Leds description.....	20
4.12 Trimmers description	21
4.13 Test points description.....	21
4.14 Jumpers.....	22
5 Customizations	23
5.1 Resolver converter resolution	24
5.2 Customization board.....	25
5.3 Customization jumper summary	26
5.4 Vref bandwidth.....	26
5.5 Tacho feedback scaling converter bandwidth.....	27

5.6 Speed loop compensation	28
5.7 Current loop compensation.....	30
5.8 Permanent current- / peak current.....	30
5.9 IxT Protection threshold.....	31
5.10 Dynamic braking current.....	31
5.11 Ramp duratio (option).....	32
5.12 Resolver's excitation voltage	32
5.13 Resolver's delay compensation	33
4.14 Number of motor´s poles	34
4.15 Encoder simulation setting.....	35
6. Cooling requirements	36
5.1 Natural convection.....	36
5.2 Forced ventilation	36
7. Dimensions and fixing	37
7.1 Lateral heatsink application	37
8 EMC prescription	38
8.1 Foreword	38
8.2 Reference standards	38
8.3 Installation with special filter for converter	39
8.4 Installation without special filter for converter	40
8.5 Installation without filters.....	41
8.6 Connecting cables	42

BHL Servoamplifiers- RR Series



1.1 Description

This servoamplifier is a PWM controlled converter with three-phase power stage configuration, suitable for driving brushless motors with resolver transducer.

The converter is built using IGBT transistors for the power stage, has an integrated switching power supply, integrated controller and protection circuits. The power ground and the signal ground are galvanically insulated.

1.2 Product Identification

An identification label is applied on the side of the unit, with the relevant identification data. When contacting the customer service, please report the Model, Serial number and Part number, which are indicated on the label.

Model: **BHL'98 5/12/300 RR** 
 Serial nr: **02/44-01134 - 08**
 Part nr: **4BARR0D0A001TCFI** 

1.3 Model Specification

Different models (4 sizes) are available:
 Specification depending on size are shown in the table below.

Ratings	Dim	05/12	12/30	20/50	30/60
Peak current	A	12	30	50	60
Rated current	A	5	12	20	30
Power loss at rated current (with electromechanical brake)	W	70	122	152	240
Quiescent power loss (disabled)	W	22	22	22	22
Quiescent power loss (with electromechanical brake)	W	40	40	40	40
Efficiency at rated current	%	90	96	97	97
PWM switching frequency	kHz	18	18	12	6

Mechanical specification	Dim	05/12	12/30	20/50	30/60
Weight	Kg	3,2	3,2	3,6	3,6
Dimensions	mm	268x55x230		268x65x230	

1.4 Warning

Warning

The drive operates with high voltage, only qualified personnel should be allowed to operate on the drive. ATTENTION, DANGEROUS VOLTAGES MAY REMAIN ON DRIVE TERMINALS AND INSIDE THE DRIVE ENCLOSURE UP TO 5 MINUTES AFTER THE POWER HAS BEEN SWITCHED OFF.

1.5 Principle function

A on the resolver installed rotor notifies the angleposition of the rotor to the servoamplifier. A sequential commutation (blockcommutation) allows the activation of the AC servoamplifiers. Sequential to the rotorposition, the individual power-output stages of the engine phases are controlled by the resolver. The servo amplifier also converts the resolver signals in incremental rectangle sequences by using the encoder-emulation. This signals are corresponding to the conventionally encoders with differential driver and zero impulses.

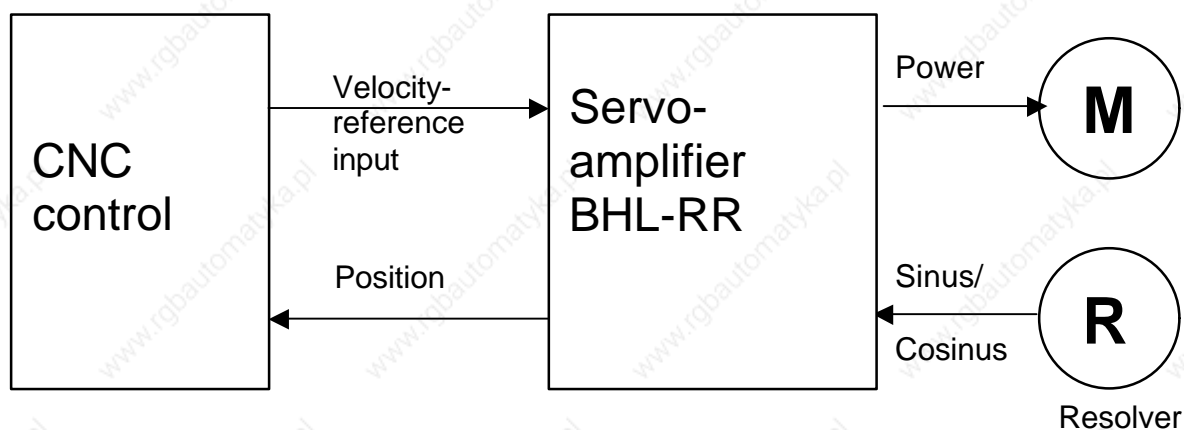

2. Technical Data

The main technical characteristics of the servoamplifiers are the following:

2.1 Supplies

- Three phase input 230 Vac +10% ÷ -20%
- DC bus nominal voltage 320Vdc
- Auxiliary supply 110Vac, 30VA
- Internal switching power supply for the control circuitry
- Maximum output voltage to the motor: $\approx 95\%$ of the DC bus (320Vdc)
- Galvanic insulation between the control circuitry and the power stage

The auxiliary 110 Vac supply is needed when the status of the LED indicators should be maintained also after removing the main power supply (230Vac three phase). When using the auxiliary 110 Vac supply, the input voltage on the main supply range can be reduced up to 35 Vac three phase minimum, by eliminating the undervoltage protection via a dedicated jumper on the base board. (see Jumpers)

2.2 Output current

Depends on the model:

- Continuous current : 5 / 12 / 20 / 30 A rms
- Maximum current : 12 / 30 / 50 / 60 A peak

The peak current can be sourced for no more than 10 seconds, with the motor rotating, or no more than 0.7 seconds at stall. After this time the Ixt protection trips, and the output current is automatically limited to the continuous rated current.

2.3 Braking circuit

- braking circuit short circuit protected.
- DC voltage threshold set at 380Vdc

Install the appropriate resistor according to the drive model, following the table below:

Model	Resistor Ω min.	Leistung W
BHL - 05.12.300 RR	33 Ω	100 W
BHL - 12.30.300 RR	15 Ω	240 W
BHL - 20.50.300 RR	10 Ω	420 W
BHL - 30.60.300 RR	10 Ω	420 W

2.4 Dynamic braking

The drive is capable of braking the motor shorting its windings, and controlling the motor current at a presetable level.

This feature is automatic in case of a fault or drive disable.

This feature can be disabled by connecting to +24V the input 24VSBLO (pin 11 of connector JP2). If an electromagnetic brake is connected to the drive, the brake is also energized (released).

2.5 Electromagnetic brake

- the brake can be connected on front panel terminals
- internal power supply for the brake 24Vdc, 0.8A max.
- brake release/lock is automatically operated by the drive
- connections for an optional emergency switch (potential free contact) in series with the brake are available

2.6 Resolver

- reference frequency 12kHz
- reference voltage selectable up to 7.1 V rms (100 mA max)
- input voltage for sin and cos signals: 2Vrms \pm 10%
- trimmer for phase shift compensation between reference output and sin/cos inputs

2.7 Function mode

- current regulated
- revolutions regulated
- mode can be set by a jumper
- ramp function with preselectable positiv and negative flank upward gradient

2.8 Input / Output signals

- digital input for power enable(ENABLE) 15÷24V 20mA
- digital input for reference input enable (ARMO) 15÷24V 20mA
- fault output (potential free contact)
- power supply output \pm 15V 50mA
- analog reference input \pm 10V (differential) 1k Ω impedance
- digital output for encoder emulation : A, B, Z (RS422 5V differential) with selectable resolution
- analog input (0÷10V, unipolar, 1k Ω impedance) for setting the limit of the output current from 0% (0V) to 100% (10V) of the rated current of the drive. Optional circuit (ILIMIT).

2.9 Protections

- under/overvoltage on DC bus
- short circuit between motor terminals and/or ground
- overcurrent
- resolver connection fault (wire broken)
- short circuit on output power supply +24V for the brake.
- drive overtemperature
- motor overtemperature

In case of intervention of any of the above protection, the FAULT contact is opened. The protections are cleared by cycling the ENABLE input off and on again.

- Ixt protection circuit

The peak current can be sourced for no more than 10 second rotating and 0.7s at stall. After this time the Ixt protection trips, and the output current is automatically limited to the rated current. The protection do not cause the opening of the FAULT contact.

Ixt protection is automatically reset after 10 seconds, provided that the rated continuous current is set at least 10% less than the Ixt threshold. The led indicator stays latched on until the power is removed to the unit, to indicate the occurrence of the problem.

2.10 Customization

On the front panel a plug in card allows setting of the following customization parameters:

- continuous current
- maximum current
- P.I regulation of the speed loop
- P.I regulation of the current loop
- dynamic braking current

On the plug in customization board there are solder jumper to set different modes of operation:

- resolver converter resolution 12 / 14 / 16 bit
- number of motor poles 2 / 4 / 6 / 8 / 12
- inversion of the input reference
- inversion of the speed feedback

2.11 Connectors and LED

All used connectors can be found on the frontpanel in the form of screwclamps or connecting plugs. Either LED can be seen on the Frontpanel and the customer board will be plugged in there.

2.12 Housing

The drive is put in a solid metalbox (safety class system IP20) with the possibility of fixation in vertiacal position by two srews on the carrierboard.

2.13 Operating temperature

- Operating temperature: $10^{\circ}\text{C} \div 40^{\circ}$. Depending on model and on average output power, forced ventilation could be necessary, for operation in the full temperature range (see Cooling requirements)
- Storage temperature: $-10^{\circ}\text{C} \div 70^{\circ}\text{C}$

2.14 Head sink

there are two ways of head sink configuration:

- side head sink (standard): here the head sink is installed on the side of the amplifier
- back front head sink (optional) : an minimal back front head sink is installed on the amplifier

The back front head sink is ideal for mounting of several drives side by side on a common pan head sink, like in more axles systems. The sizing of this head sink depends of the necessary power.

2.15 Others

- Current loop bandwidth: 3 kHz
- Speed loop bandwidth: 100 Hz
- Linearity better than: 0.6%
- Average efficiency: 98%.

3 Printed circuit board layout's

3.1 Printed circuit board layout (new base board)

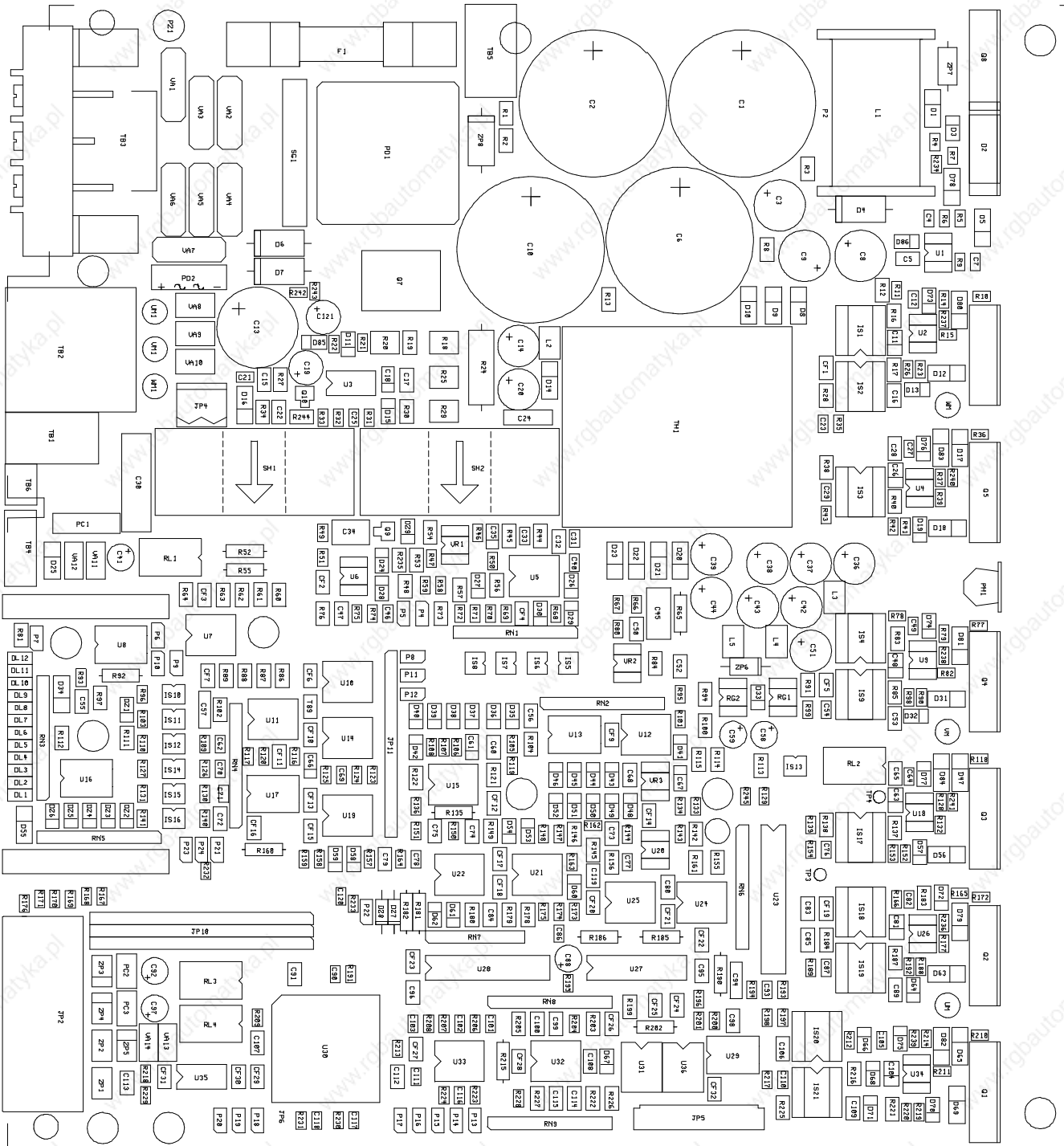

3.2 Printed circuit board layout (interface board)

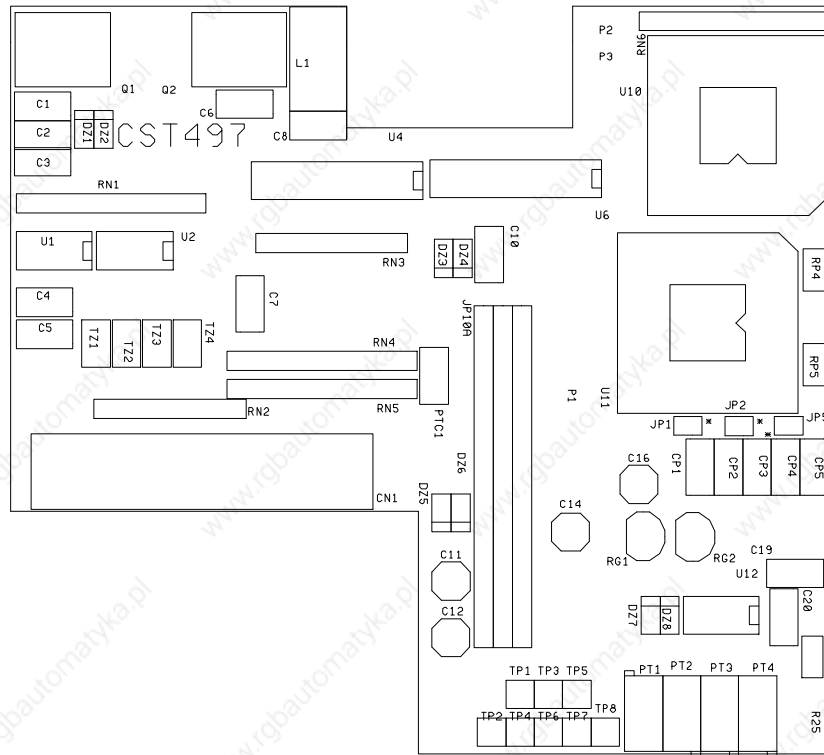

4 Connections

4.1 Front Panel

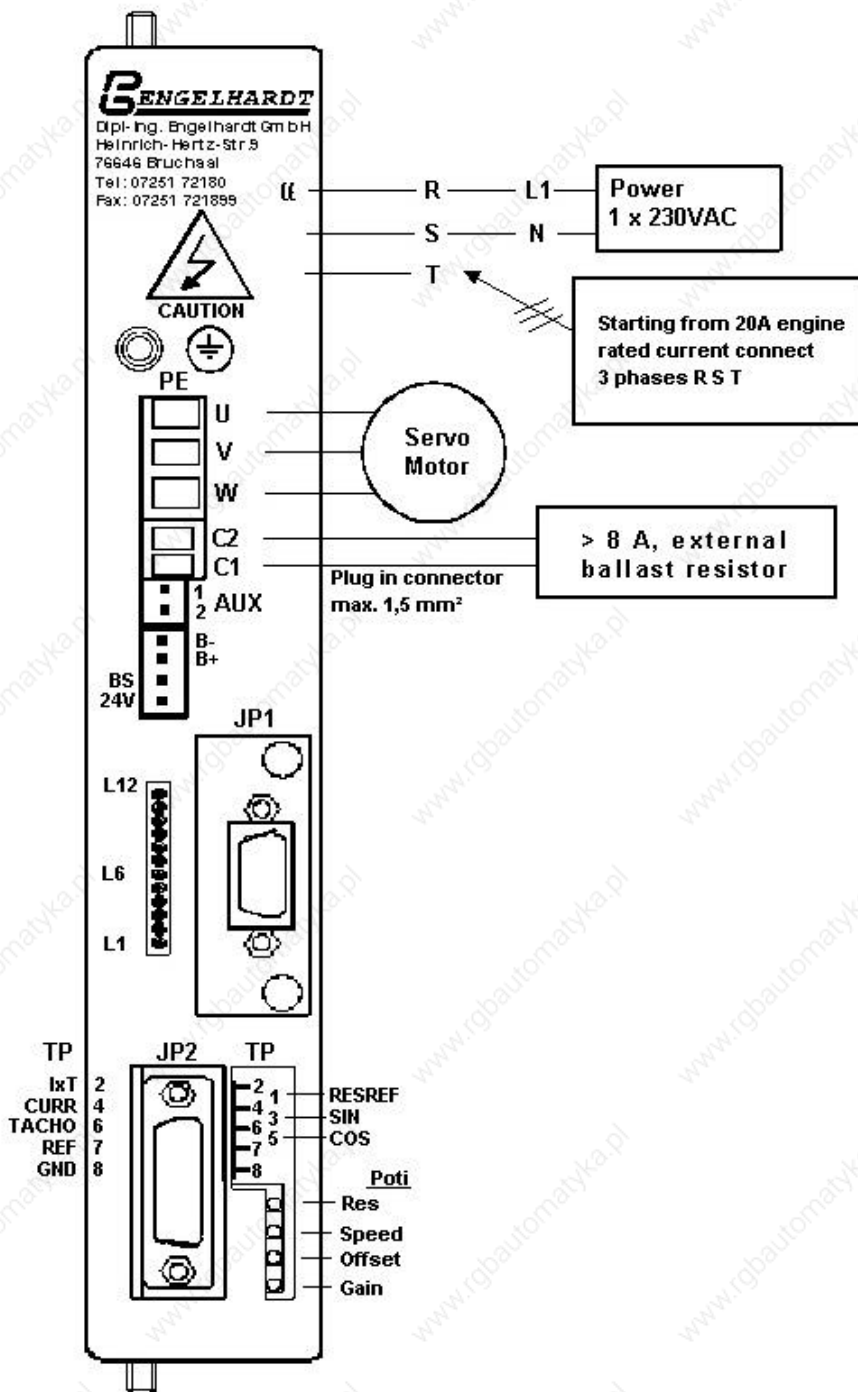

4.2 Wiring diagram CNC version C-88; P-88; M-88

Powersupply 1x 230V or 3x 230V

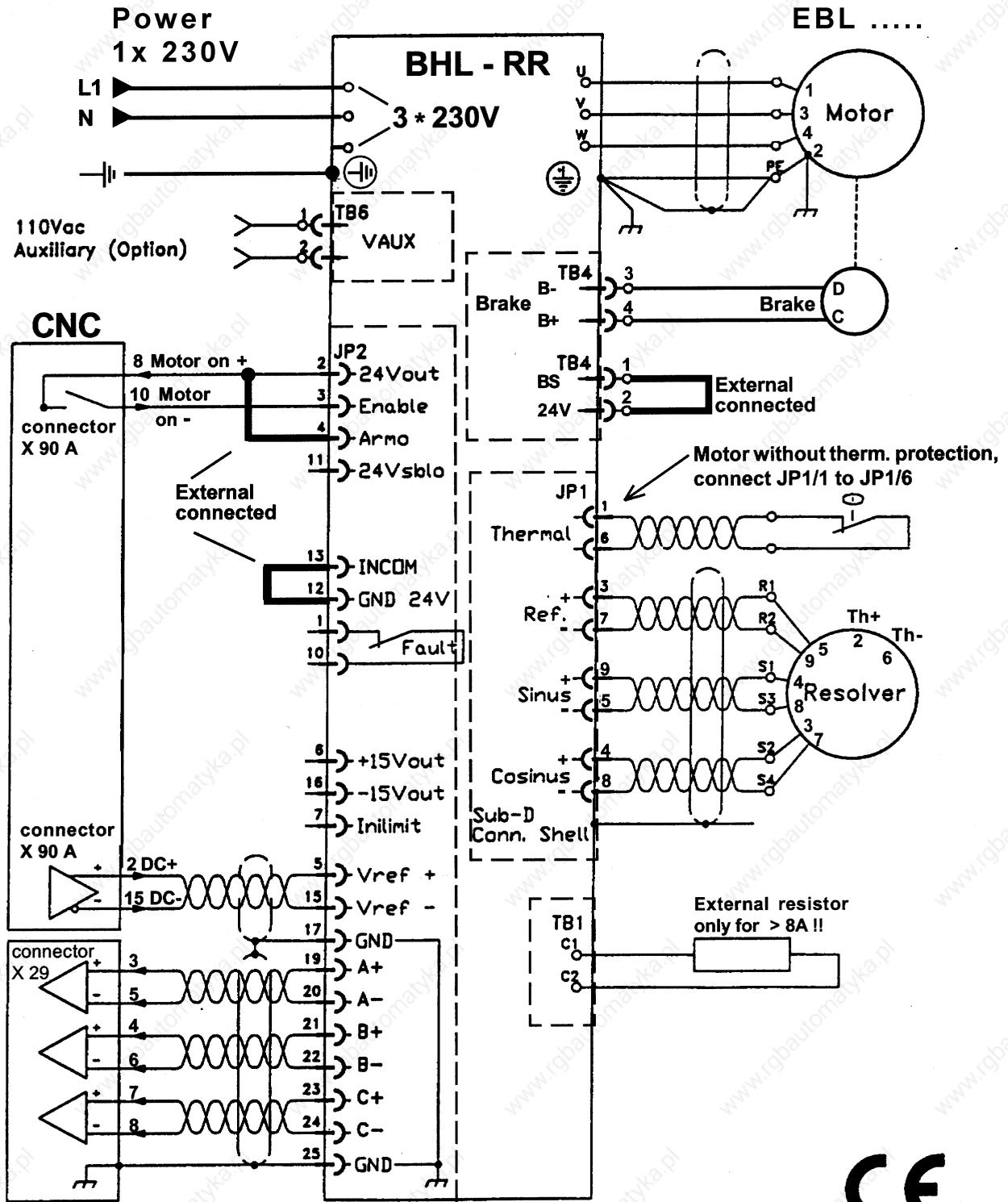

4.3 Wiring diagram CNC version D-22; F-22; S-44

Powersupply 1x 230V or 3x 230V

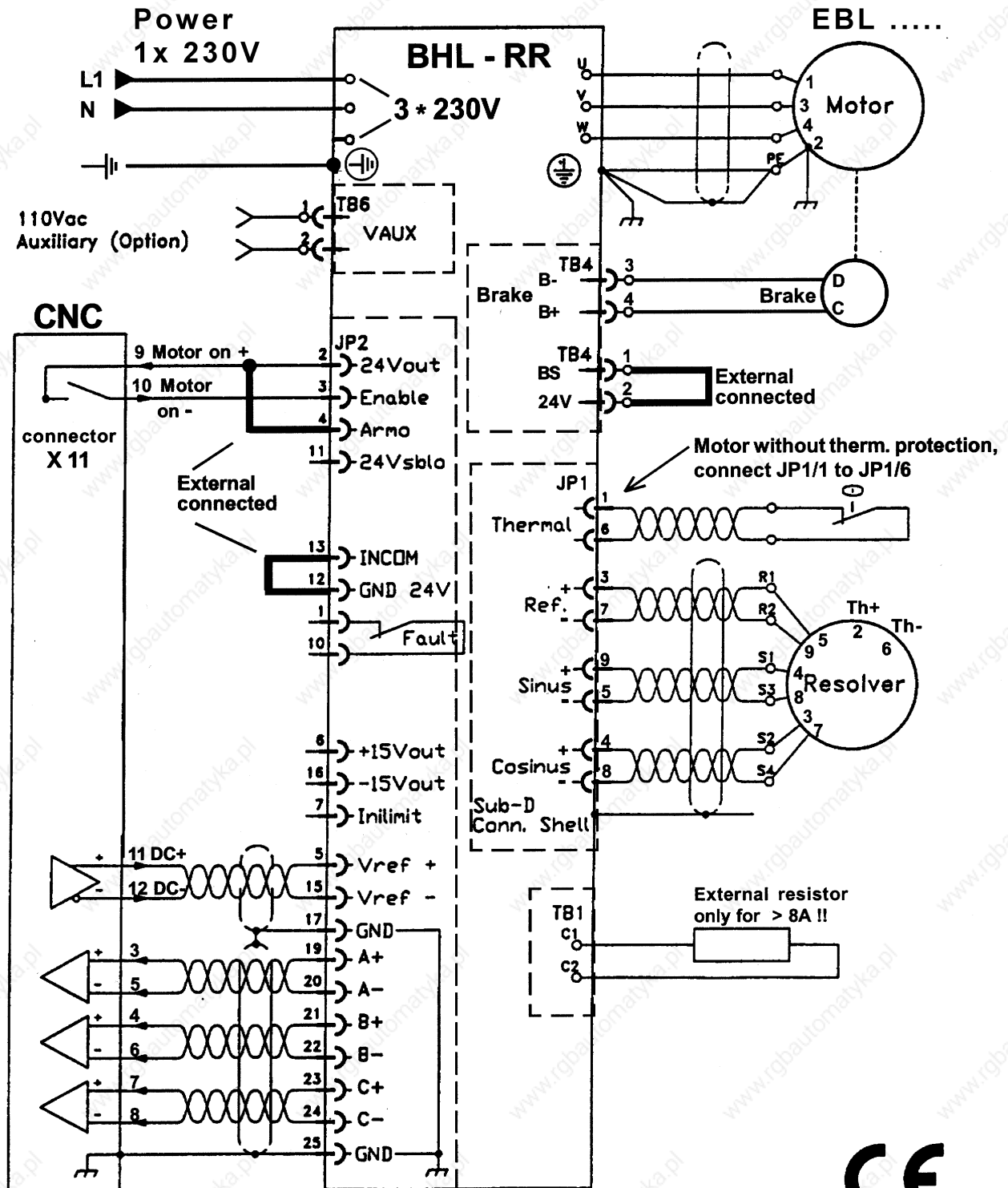

4.4 Wiring diagram CNC version M-10

Powersupply 1x 230V or 3x 230V

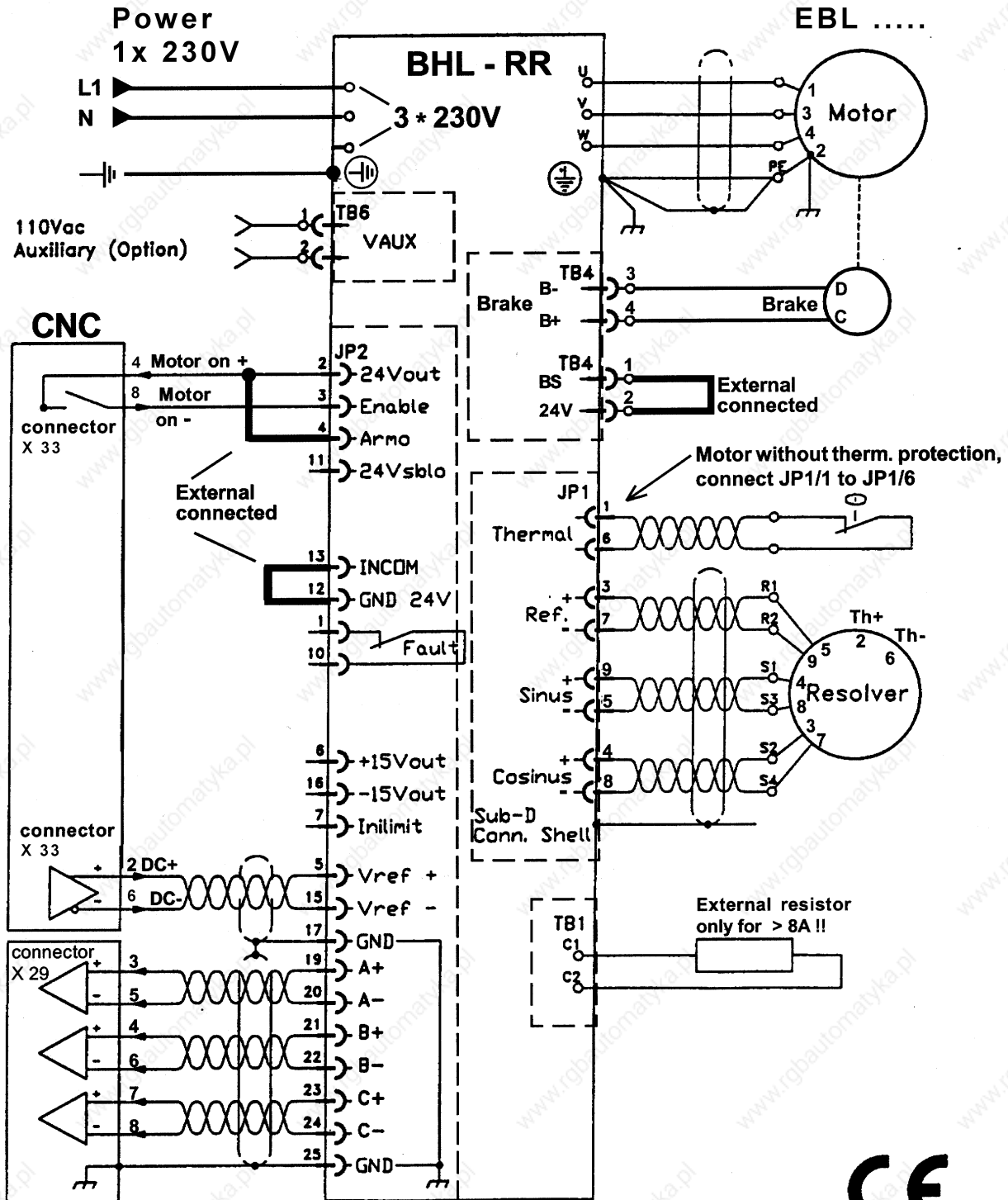

4.5 Main supply connections

TB3

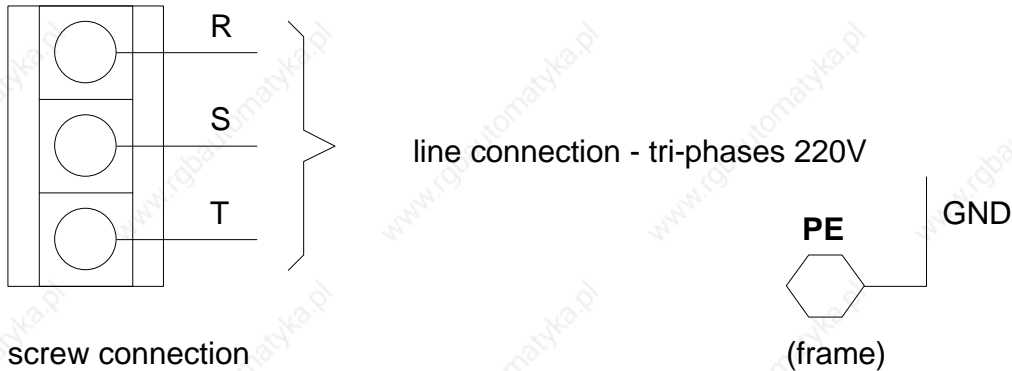

screw connection
ring or fork terminal
3.5 mm internal diameter
8.0 mm external diameter

When the line transformer or the autotransformer has a rated power higher than 6kVA, we recommend to limit the inrush current as depicted

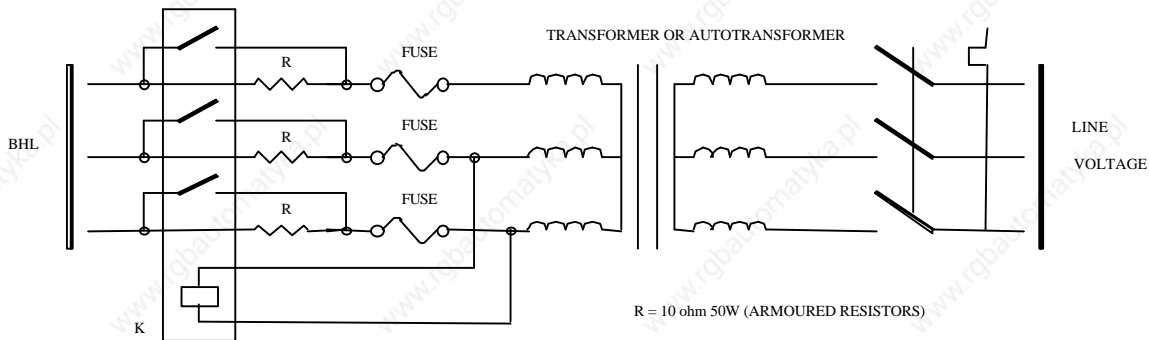

R = 10 ohm 50W (ARMOURED RESISTORS)
K = 220VAC 25A RELAYS

Fig 1: Wiring for a line transformer or autotransformer with rated power > 6kVA

4.6 Motor connections

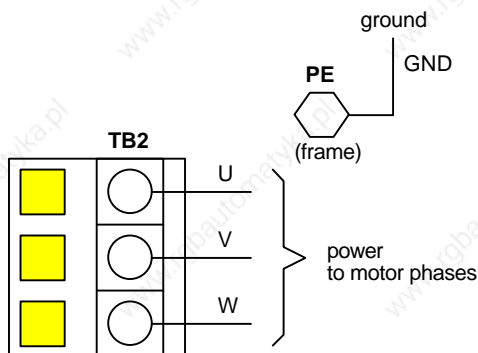

Note:

an optional noise suppressor ferrite clamp has been foreseen for motor cable

screw connection, max. 4mm² terminals

4.7 Clamp resistor connections

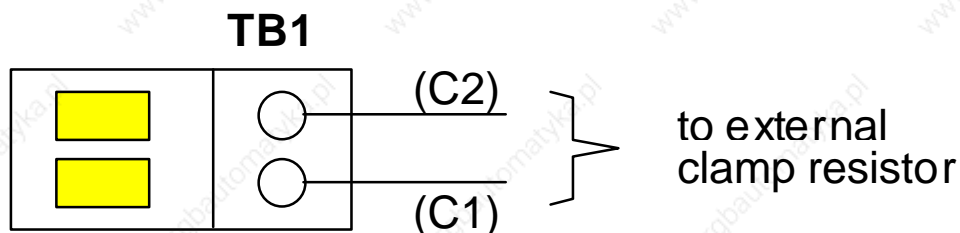

screw connection, max. 1.5mm² terminals

4.8 Brake and auxiliary Connections

TB6

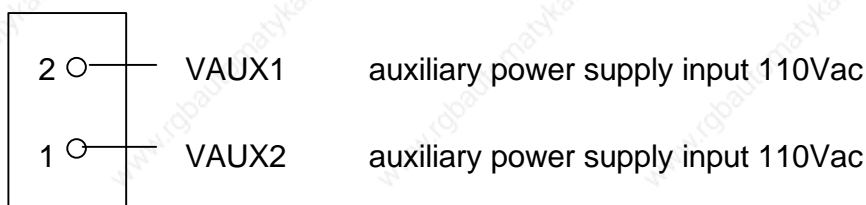

TB4

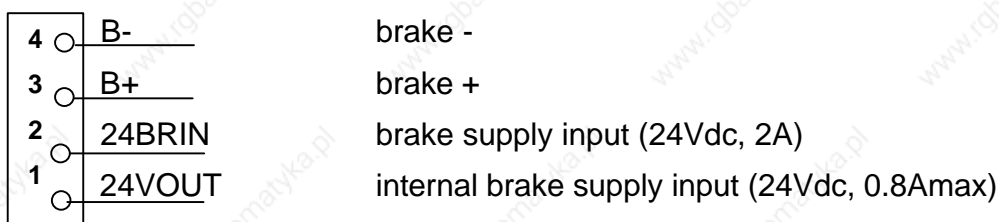

screw connection, max. 1mm² terminals

Note: The drive automatically cuts off power and releases the electromechanic brake when connection between pins 1 and 2 is open. Connect a potential free contact emergency switch between pins 1 and 2, or jumper them.

Brake supply input: connect between TB4-2 (24Vdc, 2A) and TB4-4 (GND 24Vdc, 2A).

4.9 Connections to the control unit

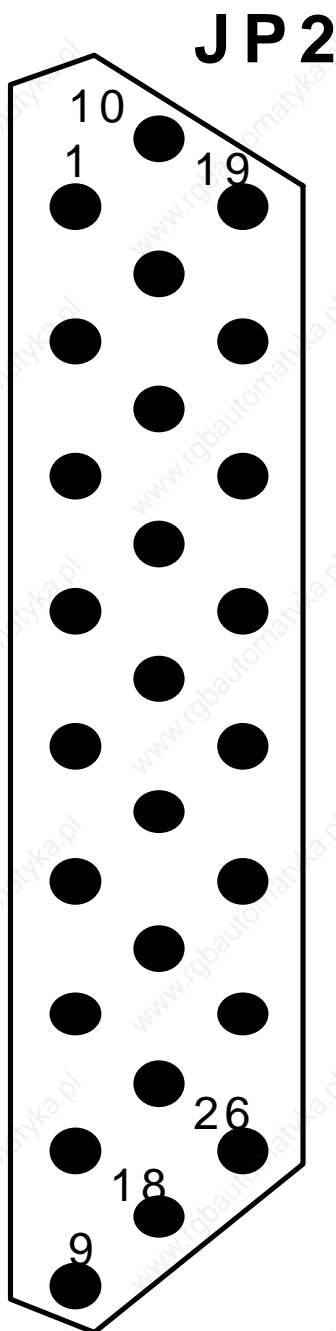

High density 26 pin
male sub-D connector

JP2 - Signals towards the control unit		
pin	reference	description
1	FAULT2	error signal input (relay contact)
2	+24VOUT	auxiliary voltage output (24Vdc 0.8A max.)
	ENABLE	power enable input
4	ARMO	reference input enable
5	VREF+	velocity (or current) reference input (+)
6	+15VOUT	auxiliary voltage output (50mA max.)
7	INILIMIT*	current limit analog input (0÷10V)
8		
9		
10	FAULT1	error output (relay contact)
11	24VSBLO	manual brake unlock
12	GND24V	auxiliary voltage ground (24Vdc)
13	INCOM	common ENABLE and ARMO signals ground
14	SHIELD	cable shield
15	VREF-	velocity (or current) reference input (-)
16	-15VOUT	auxiliary voltage output (50mA max.)
17	GND	analog ground
18		
19	ENCA+	RS422 encoder signal
20	ENCA-	RS422 encoder signal
21	ENCB+	RS422 encoder signal
22	ENCB-	RS422 encoder signal
23	ENCZ+	RS422 encoder signal
24	ENCZ-	RS422 encoder signal
25	GND	analog ground
26		

Note: signals marked with "*" are optional and supplied on Request.

Note: connecting 24VSBLO to +24OUT, the electromagnetic brake is unlocked and motor's dynamic braking is disabled.

4.10 Connections to resolver

JP1 - Signale to Resolver				
Servoamplifier Typ BHL – RR			Servomotor Resolver EBL...	
Pin		Funktion	Pin	
1	Thermal -	Motor thermal protection *	6	Thermal -
2	n.c.	n.c		
3	Reference +	Positive resolver reference	5	Reference +
4	Cosinus +	Positive resolver cosinus signal	3	Cosinus +
5	Sinus -	Negative resolver sinus signal	8	Sinus -
6	Thermal +	Motor thermal protection *	2	Thermal +
7	Reference -	Negative resolver reference	9	Reference -
8	Cosinus -	Negative resolver cosinus signal	7	Cosinus -
9	Sinus +	Positive resolver sinus signal	4	Sinus +

* Connect the thermostat potential free contact (n.c.), or PTC resistor between these pins

JP1

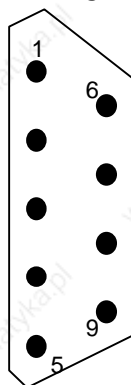





Male 9 pin
Sub-D connector





4.11 Leds description

On the front of the drive two sets (green and red ones) of LEDs are mounted to display the status.



The green LEDs are normally on and their meaning is :

-  DL12 : 24Vdc supply to the brake
-  DL11 : 230V tri-phase power on
-  DL10 : auxiliary voltage on
-  DL9 : power enable digital input (ENABLE) on
-  DL8 : reference enable digital input (ARMO) on

The red LEDs are normally off and they display a faults when lit :

-  DL7 : overvoltage or wrong clamp resistor value
-  DL6 : overcurrent
-  DL5 : resolver wrong connection
-  DL4 : lxt fault





Note: lxt fault automatically goes off after 10 s.; anyway the LED stays permanently on, to point out a protection intervention has occurred.

-  DL3 : thermal protection of the drive
-  DL2 : thermal protection of the motor
-  DL1 : undervoltage on the 230V tri-phases power supply.

4.12 Trimmers description

On the front of the drive four trimmers are accessible for the following tunings :









- PT1 : velocity loop gain adjust
- PT2 : velocity offset adjust ($\pm 80\text{mV}$)
- PT3 : motor speed adjust ($\pm 50\%$)
- PT4 : resolver's signals delay adjust

	PT4	RES
	PT3	SPEED
	PT2	OFFSET
	PT1	ω GAIN

For the correct adjust of trimmers, please refer to chapter "Customizations"

4.13 Test points description

On the front of the drive test points are accessible :

TP2		I _{xT} (average motor current)			
TP4		CURR (instantaneous motor current)	TP1		RESREF (resolver reference signal)
TP6		TACHO (speed)	TP3		SIN (resolver sinus input)
TP7		REF (reference voltage V _{ref})	TP5		COS (resolver cosinus input)
TP8		GND (analog ground)			

The voltage on TACHO test point depends on the maximum speed you set on customization board, according to the tables on page 27.

The voltage on the test point CURR depends on the drive's model, according to the following table:

Model	CURR signal
Mod. 5/12	0.3V / 1A
Mod. 12/30	0.1V / 1A
Mod. 20/50	0.082V / 1A
Mod. 30/60	0.082V / 1A

The voltage on Ixt test point is proportional to the motor's average current. When the voltage on this point reaches 4.5V, the Ixt protection trips.

4.14 Jumpers

The following jumpers on the base board are factory settings, and do not need to be changed by the user. These jumpers are not accessible and require opening the enclosure. The following jumpers are on the base board:

- P0, P1 : used for testing purposes (normally open)
- P5 : undervoltage disable
- P7 : connects GND24V to GND (GND24V is normally floating)
- P10 : if the electromechanical brake is not used, connection to the TB4 front connector can be avoided by closing this jumper

5 Customizations

In order to fit the characteristics of the actual brushless motor used, a set of parameters are customizable, changing the default values of the components mounted on the plug in card. Customizable parameters are the following ones :

- resolver converter resolution
- tacho feedback scaling and resolver converter bandwidth
- Vref bandwidth
- speed loop compensation
- current loop compensation
- continuous current setting
- maximum current setting
- Ixt protection threshold
- dynamic braking current setting
- ramp slopes
- resolver reference amplitude
- phasing of resolver signals
- number of motor poles
- encoder simulation resolution.

5.1 Resolver converter resolution

The resolver converter used in the drive has a programmable resolution: 12, 14 or 16 bit.

Depending on the resolution selected, the following operating conditions apply :

RESOLUTION	RPM MAX
12	15600
14	3900
16	975

RESOLUTION	ENCODER PULSES/TURN	
	min	max
12	128	1024
14	512	4096
16	2048	16384

RESOLUTION	BANDWIDTH	
	RESOLVER	SPEED LOOP
12	3 kHz	100 Hz
14	2 kHz	70 Hz
16	1.6 kHz	50 Hz

Note : these tables refer to a 2 poles resolver

The resolution is set with jumpers P2, P3 on the interface board.

RESOLUTION	P2	P3
12	open	closed
14	closed	open
16	open	open

Note : Using a AD2S82 resolver converter, setting of jumpers P2 and P3 must be swapped

Warning :

If the setting of P2 and P3 is changed by the user, this affects also the values of many customization components (R8, C6, C7, R7); the user should not change these jumpers. The resolution is a factory setting, and three different ordering codes are available for the different resolutions.

Note: AD2S82 checksum C6862 - AD2S83 checksum C5782

5.2 Customization board

A customization board is plugged on the front panel, allowing the setting of all the customization parameters. The setting is obtained mounting the appropriate passive components (resistors and capacitors). The values of customization components have to be computed using the formulas described further in this chapter.

Components

R1 = speed loop gain

R2 = maximum current

R3 = negative ramp slope

R4 = positive ramp slope

R5 = fixed value 10k Ω

R6 = resolver reference amplitude

R7 = resolver bandwidth

R8 = speed range scaling

R9 = current loop gain (not mounted)

R10 = Ixt threshold setting

R11 = dynamic brake current

R12 = continuous current

C1 = Vref bandwidth

C2 = speed loop gain (adjustable via PT1)

C3 = speed loop gain (fixed, PT1 excluded)

C4 = ramp slope range

C5 = resolver bandwidth

C6 = resolver bandwidth

C7 = current loop gain (not mounted)

D1, D2 = diodes BAT43

JP1 = Connector to resolver

CN1 = internal connector

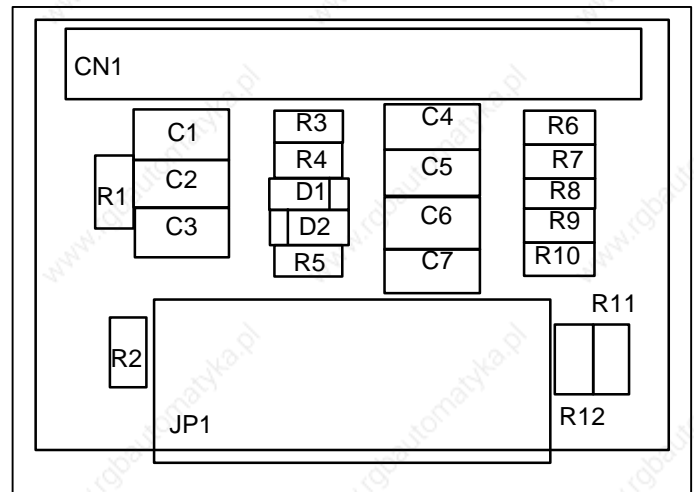

Fig. 6: Customization board layout

Note : customization jumpers are on the solder side of the board.

5.3 Customization jumper summary

The following jumpers are available on the plug in customization board:

Jumper	Customization board
P1	inverts the speed feedback sign (normally inverted = open)
P2, P6, P7	select number of motor poles, see relevant table
P3	selects Vref inverted (open) or Vref direct (closed)
P4, P5	select the pulse/turn resolution of encoder simulation, see relevant table
P8, P9	select operating mode: current mode (P9 closed) or speed mode (P8 closed) (mutually exclusive)
P10	motor phase (closed = 120°, open = 60°)
P11	disables thermal protection on motor (open = enable, closed = disable)
P12, P13	enable ramp function (P12 closed) or disable ramp function (P13 closed) (mutually exclusive)

Note: In some cases the motor can turn with maximum speed with nominal speed value 0! In this case the P1 speedsignal has to be inverted (colse) to work correctly.

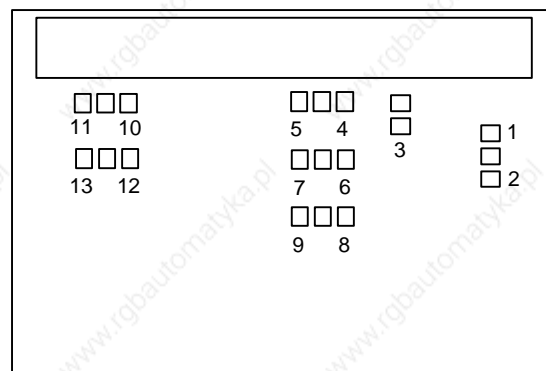

Fig. 7.: Jumper layout on customization board

5.4 Vref bandwidth

The setting of this parameter is determined by capacitor C1. Its value is calculated as follows:.

$$C1 = \frac{10^5}{2 \cdot \pi \cdot f} \text{ [nF]} \quad \text{where: } f = \text{maximum Vref frequency [Hz]}$$

The typical value for C1 is 150nF, corresponding to a Vref bandwidth of 100 Hz.

Bandwidth V ref (Hz)	Capacitor C1
50	330nF
100	330nF
200	82nF
300	39nF

5.5 Tacho feedback scaling converter bandwidth

Important notice:

What is described in this paragraph is referred to a standard 2 poles resolver. If a different resolver is used, with a number of pole pairs (PR) greater than one, you should keep this into account in the calculation by multiplying the speed (rpm) by PR.

The maximum motor speed and the converter bandwidth are linked together. In the following tables there are the typical (standard) customization values that should be used depending on the speed range of the motor and the resolution of the resolver converter.

The values in the tables are in **W**, **kW** f.e. in **MW** -, in pF or in nF.

12 Bit Resolution							
Rpm/min	Rpm/max	R8	C5	C6	R7	V/krpm Testpont Tacho	Bandwith
700	1600	470 k	10 pF	47 pF	3,3 M	3,77 V	2,1 kHz
1400	3200	240 k	15 pF	100 pF	2,2 M	1,92 V	2,4 kHz
2700	6400	120 k	33 pf	150 pf	1,0 M	0,96 V	2,3 kHz
3800	9500	82 k	47 pF	220 pF	680 k	0,66 V	2,3 kHz

14 Bit Resolution							
Rpm/min	Rpm/max	R8	C5	C6	R7	V/krpm Testpont Tacho	Bandwith
300	800	240 k	47 pF	220 pF	2 M	7,7 V	1,4 kHz
700	1600	120 k	100 pF	470 pF	1 M	3,8 V	1,3 kHz
1500	3900	51 k	220 pf	1 nF	0,47 M	1,6 V	1,4 kHz

16 Bit Resolution							
Rpm/min	Rpm/max	R8	C5	C6	R7	V/krpm Testpont Tacho	Bandwith
120	250	180 k	10 pF	470 pF	1,2 M	23,1 V	1,1 kHz
220	470	100 k	150 pF	1,0 nF	0,68 M	12,8 V	1,2 kHz
470	940	51 k	330 pf	1,5 nF	0,33 M	6,50 V	1,1 kHz

The speed can be adjusted in the range shown in the table using the SPEED trimmer, located on the front panel.

If the user wants to compute the values of these components please refer to App.

Note: Resolver compensation parameters for the appropriate formulas.

5.6 Speed loop compensation

The speed loop compensation is set by resistor R1 and by capacitors C2 or C3. If C3 is fitted, the gain of the loop is fixed (ω gain trimmer is not operating). If C2 is fitted instead, the gain of the loop can be regulated acting on ω gain trimmer on front panel. This last case has to be used when the load inertia is not known: the gain is set according to the inertia of the motor alone, and it can be regulated (incremented) via the trimmer until a satisfactory response is obtained, as shown in the following diagrams.

Case 1:

When the load inertia is known, R1 value is calculated as follow:

$$R1 = \frac{1}{\frac{K_T * I_{max}}{\omega_c * 1 \cdot 10^4 * J_{tot} * \omega_{max}} - \frac{1}{10 \cdot 10^6}} [\Omega]$$

where:

- ω_c = crossover of the speed loop (typically 200 ÷ 300 rad/s) [rad/s]
- J_{tot} = sum of motor inertia and load inertia seen from the motor shaft (inerzia of gearing should be included) [Kgm²]
- ω_{max} = max motor speed in the application [rad/s]
- K_T = torque constant of the motor [Nm/A]
- I_{max} = maximum current set for the application [A]

$$C3 = \frac{1}{R1 * \omega_z} [F]$$

where:

- ω_z = position of the zero of the compensation (typically $\omega_c / 6$ rad/s)

Case 2:

If the load inertia is not known, C2 should be fitted instead of C3, R1 is calculated as follows:

$$R1 = \frac{1}{\frac{K_T * I_{max}}{\omega_c * 1 \cdot 10^4 * J_{mot} * \omega_{max}} - \frac{1}{10 \cdot 10^6}} [\Omega]$$

where :

- ω_c = crossover of the speed loop (typically 200 ÷ 300 rad/s) [rad/s]
- J_{tot} = motor inertia [Kgm²]
- ω_{max} = max motor speed in the application [rad/s]
- K_T = torque constant of the motor [Nm/A]
- I_{max} = maximum current set for the application [A]

$$C2 = \frac{1}{R1 * \omega_z} [F]$$

where :

- ω_z = position of the zero of the compensation (typically $\omega_c / 6$) [rad/s]

After determining C2 and R1 as described above, rotate gain trimmer fully clockwise: the speed loop is so set for the minimum gain, which takes into account the inertia of the motor only. Optimize the gain rotating the trimmer counterclockwise until the desired response is obtained (see diagrams).

Verify that the response of the speed loop to a square wave doesn't produce too much overshoot and oscillations:

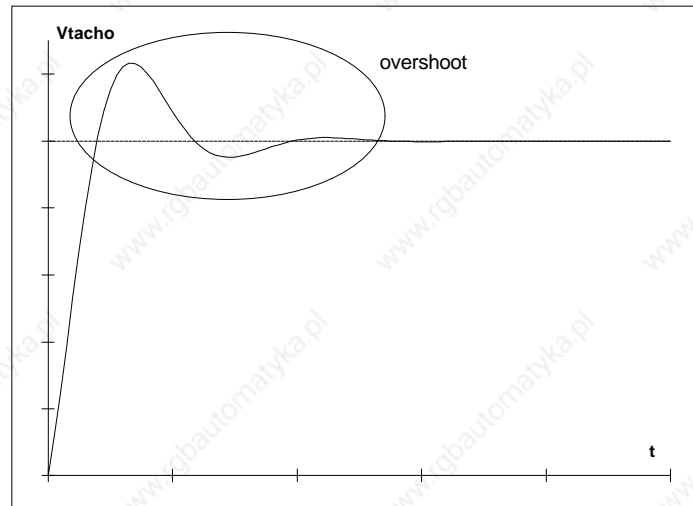

wgain low

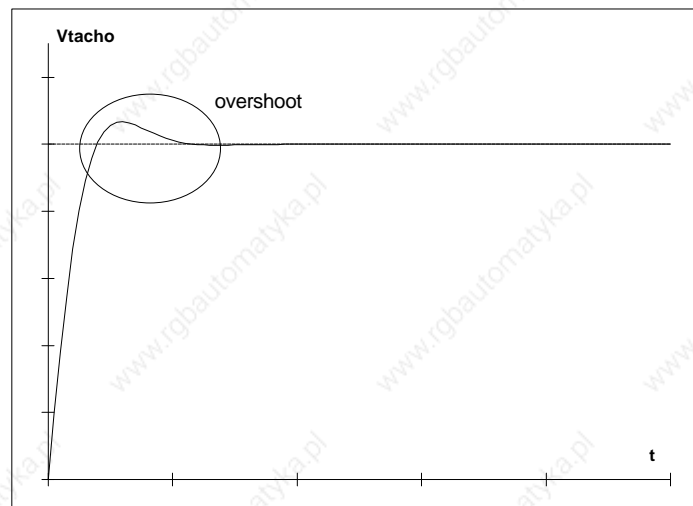

wgain correct

In the first figure, excessive overshoot and oscillation in the response is observed; the second figure shows a good response.

Proceed as following to regulate the gain:

- apply an input square wave to Vref ($\pm 1V$ amplitude, frequency $0.5 \div 1$ Hz, as shown:

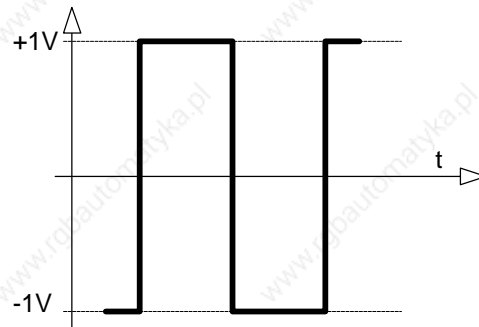

- rotate **w** gain trimmer counterclockwise until a correct response is obtained.

5.7 Current loop compensation

This parameter is set by fixed components on the base board, and normally does not need to be adjusted. If for special cases it should be adjusted, it can be done opening the jumper P22 on the base board, and installing desired values for R9 e C7 on the customization board.

Note : since this parameter affects the reliability of the power devices, if a different compensation for the current loop is needed, contact the supplier for parameter calculation.

5.8 Permanent current- / peak current

In the following table the values of R12 and R2 are registered for the respective continuous- and peak currents.

Permanent current in A	Peak current in A	BHL- 5.12.300 R12 / R2	BHL-12.30.300 R12 / R2	BHL-20.50.300 R12 / R2	BHL-30.60.300 R12 / R2
0,9	1,8	1,5k / 1,8k			
1,15	1,26	3,3k / 1,5k			
2,7	6,5	3,9k / 12k			
5	12	6,8k / -			
10,5	21		7,2k / 22k		
12	30		6,8k / -		
13,5	27			5,1k / 12k	
14,4	28,8			6,8k / 12k	
18	36			6,8k / 27k	
20	50			6,8k / -	
22	44				7,5k / 47k
25,5	51				7,5k / -
30	60				6,8k / -

5.9 IxT Protection threshold

This parameter is set through resistor R10. In the table values of R10 for the I x t protection threshold (current sinking after overload) are specified.

The resistor values in the table are indicated in **W** and/or in **kW**.

Stall - Current in Ampere	1	2	3	4	5	6	7	8	9	10	11
BHL- 05.12.300RR	150	560	1,8k	16k							
BHL- 12.30.300RR	35	150	270	407	680	1 k	1,8k	3k	6,8k	8,2k	
BHL- 20.50.300RR		39	91	150	220	330	430	560	680	910	1,2k
BHL- 30.60.300RR			33	68	100	150	180	240	300	470	560
Stall - Current in Ampere	12	13	14	15	16	17	18	19	20	21	
BHL- 20.50.300RR	1,5k	2,2k	3,3k	5,6 k	15k						
BHL- 30.60.300RR	680	820	1 k	1,2k	1,5k	2 k	2,7k	3,9k	7,5k	22k	

5.10 Dynamic braking current

When an error occurs or power is disabled, in order to stop the motor its phases are short circuited, and the current flowing is regulated to a custom value Ibrk. Depending on drive size, Ibrk can range within the extremes shown in the following table:

The resistor values in the table are indicated in **W** and/or in **kW**.

Braking current in ampere	1	2	3	4	5	6	7	8	9	10	11	12
BHL- 05.12.300RR	12	120	330	910	9,1k							
BHL- 12.30.300RR			15	51	100	150	240	330	510	820	1,2k	2,7k
BHL- 20.50.300RR				17		62		110		180		300
BHL- 30.60.300RR				12		39		75		120		150
Braking current in ampere	14	16	18	20	22	24	26	27				
BHL- 20.50.300RR	470	750	1,2k	3,3k								
BHL- 30.60.300RR	220	300	430	560	820	1,2k	2,2k	3,3k				

Note: I brk is the maximum braking current of the motor, which is led back in the normal operation into the intermediate circuit.

In order to have the maximum I brk brake current do not mount resistor R11.

5.11 Ramp duratio (option)

Ramp rise and fall times depend on R4, R3 respectively C4.

$$C4 = 1\mu\text{F} \text{ (50V, 10\%)}$$

Use only capacitors with good thermal stability and 10% tolerance.

In the following table there are the typical values for the ramp's rise time ($T_{\text{ramp}+}$) and the ramp's fall time ($T_{\text{ramp}-}$).

*The resistor values in the table are indicated in **W** and/or in **kW**.*

Values for ramp's rise and - fall time in ms	100	200	300	400	500	600	700	800	900	1000	100000
R3 (+ ramp's)	100k	220k	330k	430k	560k	620k	750k	820k	910k	1M	10M
R4 (- ramp's)	100k	220k	330k	430k	560k	620k	750k	820k	910k	1M	10M

Note : ramp's customization requires the ramp option card to be present; it is supplied only under request, if the ramp option is not present, R4, R3 and C4 are not mounted.

5.12 Resolver's excitation voltage

The resolver shall be excited by a voltage such that the output sinus and cosinus signals have a $2V_{\text{rms}}$ amplitude ($\pm 10\%$).

Depending on the actual resolver's transform ratio, R6 has to be computed as follows :

$$R6 = \frac{1}{\frac{7.1}{4.7 * 2} * n - \frac{1}{6.8}} [\text{k}\Omega]$$

where n is the transform ratio

secondary (sinus, cosinus)

primary (excitation)

5.13 Resolver's delay compensation

Due to the RC filters on resolver interface, cable characteristic and length, or to the reactive parameters of resolver itself, a phase shift (leading or lagging) can occur between the resolver's excitation and sinus and cosinus inputs. This phase shift must be less than 10 degrees, i.e. 2.3ms for a 12kHz excitation frequency. Greater phase shift degrades the system's performances in terms of speed regulation and current ripple, with consequent noise and heat on motor.

The resolver interface is equipped with a trimmer to compensate for this phase shift, adapting the drive for most of normally used resolver and cable combinations.

Please, operate as follows :

- Connect one scope probe to resolver's excitation signal (test point TP1)
- Connect another scope probe to sinus (test point TP3) or cosinus (t. point TP5) signal
- Align the two scope traces and set the trigger level at 0 V.

Operating on the time scale (about 1ms per square) and on traces amplitude (about 100mV per square) the delay between the zero crossings of the two traces can be precisely displayed (as shown).

- Act on the trimmer PT4 to obtain the minimum delay.

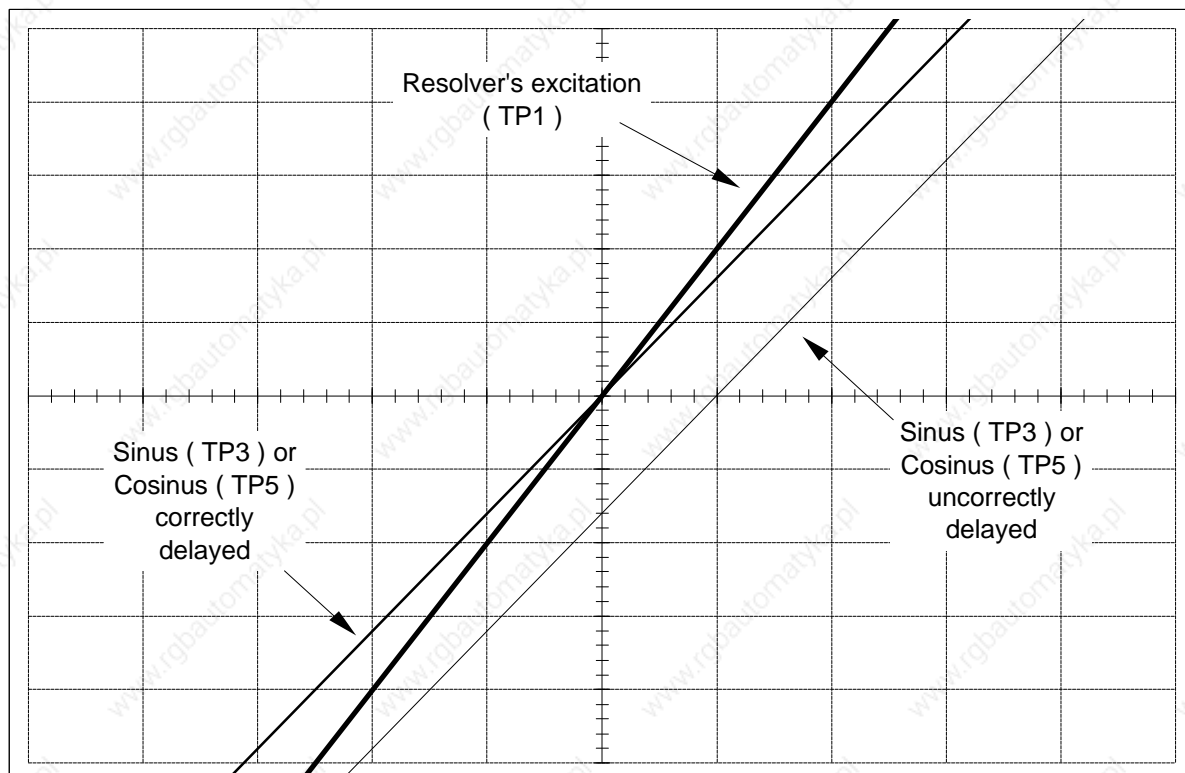

4.14 Number of motor's poles

The number of motor's poles is set acting on jumpers P2, P6, P7 according to the following table :

Motor's pole	P2	P6	P7
2	open	closed	closed
4	open	closed	open
6	closed	closed	closed
8	open	open	closed
12	closed	closed	open

This table is valid for two pole resolvers. If your resolver has a different number of poles, you must consider an equivalent number of poles equal to

$$2 \times \frac{\text{motor's poles number}}{\text{resolver's poles number}}$$

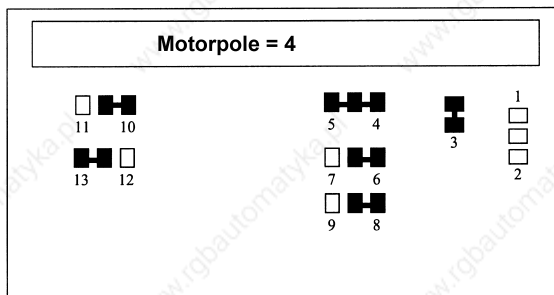

Layout der Jumper auf der Kunden - Steckplatine
Die Zahlen entsprechen Brücke P1 - P13

for 4 motor's pole:

- P2 = open
- P6 = closed
- P7 = open

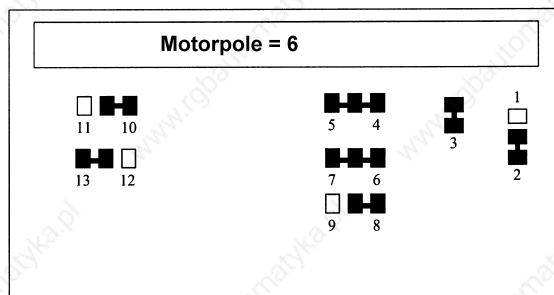

Layout der Jumper auf der Kunden - Steckplatine
Die Zahlen entsprechen Brücke P1 - P13

for 6 motor's pole:

- P2 = closed
- P6 = closed
- P7 = closed

4.15 Encoder simulation setting

You can set the number of pulses per turn generated by the encoder simulation, via jumpers P5 and P4.

Depending on the actual resolver's resolution a different table has to be considered :

12 Bit Resolution			14 Bit Resolution			16 Bit Resolution		
Pulse/turn	P5	P4	Pulse/turn	P5	P4	Pulse/turn	P5	P4
1024	closed	closed	4096	closed	closed	16348	closed	closed
512	closed	open	2048	closed	open	8192	closed	open
256	open	closed	1024	open	closed	4096	open	closed
128	open	open	512	open	open	2048	open	open
----- Standard -----								

These tables are valid for two pole resolvers. If your resolver has a different number of poles, you must multiply the pulses per turn by $\frac{\text{resolver's poles number}}{2}$.

6. Cooling requirements

5.1 Natural convection

In single axis application the unit is used with its lateral heatsink (standard). The following condition apply:

Size	Max continuous current
BHL - 05.12.300 RR	5A rms
BHL - 12.30.300 RR	12A rms
BHL - 20.50.300 RR	15A rms ⁽¹⁾
BHL - 30.60.300 RR	18A rms ⁽¹⁾

Note - ⁽¹⁾ for these models, forced ventilation is required to have 20A, 27A and 30A continuous current respectively.

The above table applies with an ambient temperature of 40°C, and unit mounted vertically with 20 mm free space on both sides and 200 mm above and below to ensure air circulation.

5.2 Forced ventilation

The unit has an internal temperature limit switch, set at 85°C. In the following table is shown the temperature rise **DT** of the heatsink at an ambient temperature of 40°C, using a fan model PAPST multifan 4314 (119x119 mm):

Size	Max. current	D Temperatur
BHL - 05.12.300 RR	5A rms	6°C
BHL - 12.30.300 RR	12A rms	13°C
BHL - 20.50.300 RR	15A rms	17°C
BHL - 30.60.300 RR	18A rms	20°C

The above table applies with an ambient temperature of 40°C, and unit mounted vertically with 20 mm free space on both sides and 200 mm above and below to ensure air circulation. The fan should be installed below the unit, with 100mm maximum spacing from the drive. The required airflow is 100 CFM.

When using a 24Vdc fan, as the above mentioned PAPST fan, its power supply can be obtained from the drive, using the brake 24V supply (TB4 connector, pin B+, B-). It should be checked that if the brake is used, the total current consumption on this power supply (brake+fan) is less than 0.8 A.

7. Dimensions and fixing

7.1 Lateral heatsink application

DIMENSIONI D'INGOMBRO PER APPLICAZIONI MONOASSE CON DISSIPATORE LATERALE
 OVER-ALL DIMENSIONS FOR MONOAXIS APPLICATIONS WITH SIDE DISSIPATION

Fissaggio mediante N.2 viti M5X30
 Fixing through N.2 screws M5X30

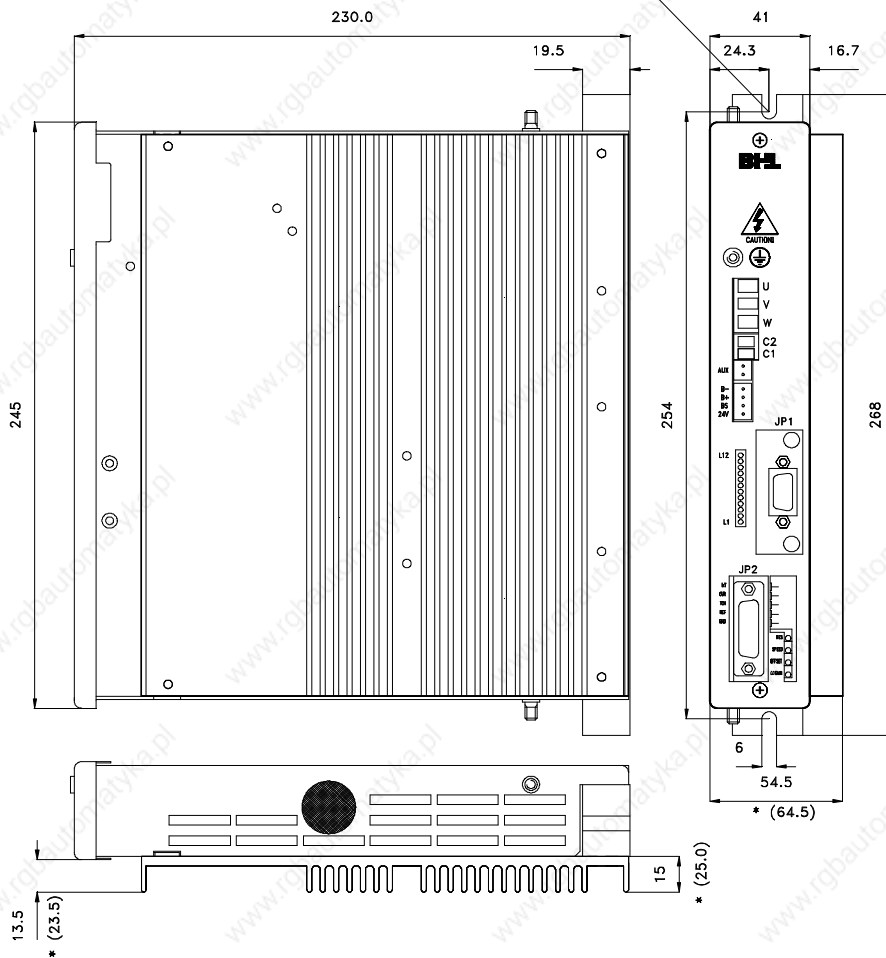

*Nota: le dimensioni tra parentesi sono valide per le sole taglie 20/50, 27/55, 30/60.

*Note: the dimensions between parenthesis are valid for the sizes 20/50, 27/55, 30/60 only.

Note : to guarantee an adequate air flow, it is needed to leave a 40 mm clearance between the units in the multi-axis application.

8 EMC prescription

8.1 Foreword

The converter is a product designed to be incorporated in a more complex equipment . Therefore electromagnetic compatibility depends by factors that are not totally under control of the manufacturer but depends on the installation, wiring and grounding of the equipment. In this manual are given instructions for installation in order to obtain conformity with actual standards for electromagnetic compatibility. This information have been collected after a comprehensive test campaign and their purpose is to make the job of the end user as easy as possible.

8.2 Reference standards

Generic Standard EN 50081-2 e EN 50082-2 (industrial environment)

- EN61000-4-2 Electrostatic discharge
- EN61000-4-4 Electrical fast transient burst
- EN61000-4-5 Surge immunity (FULL-LIGHTNING)
- EN61000-4-8 Power frequency magnetic field
- ENV50140 High frequency electromagnetic fields
- ENV50204 Electromagnetic field at 900 MHz with ON/OFF modulation
- ENV50141 Radiofrequency
- EN55011 Radiated and conducted emission
- EN61800-3 Semiconductor power converters for adjustable speed electric drive system

8.3 Installation with special filter for converter

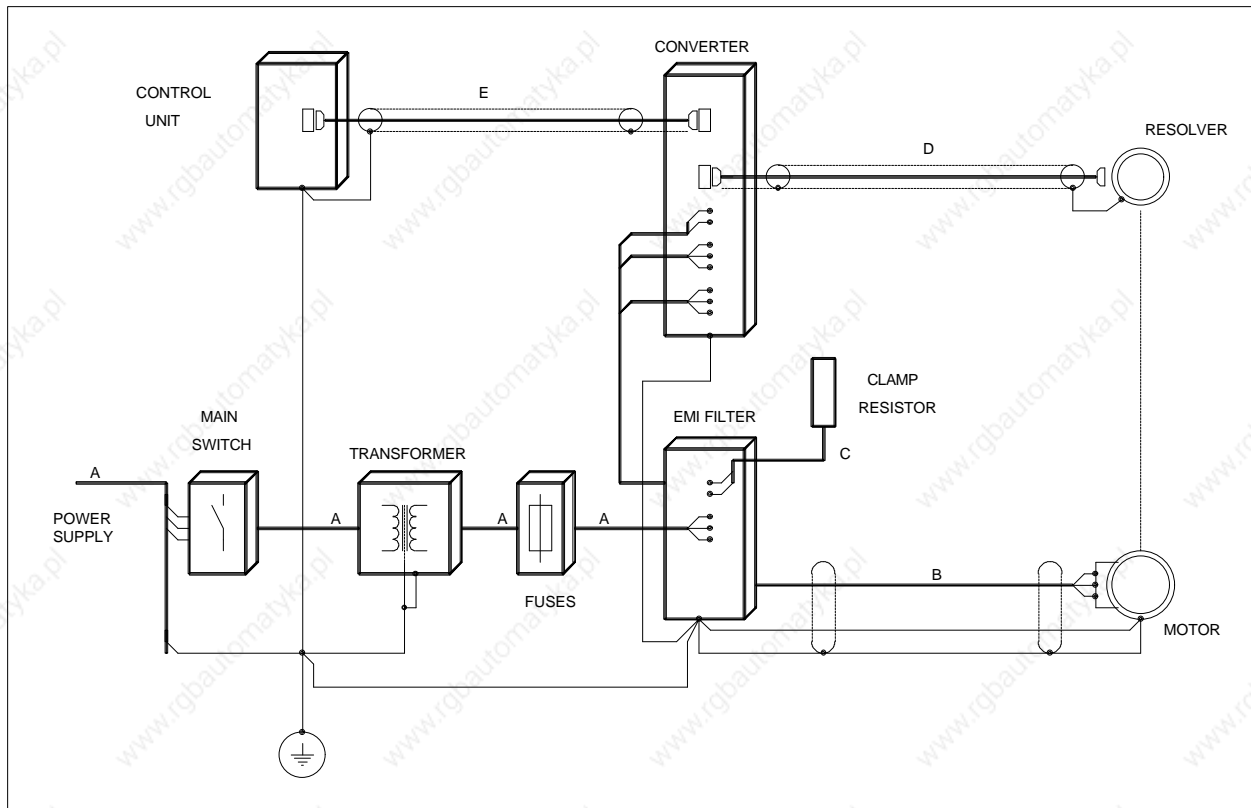

- Supply cable (A): no prescription
- Motor cable (B): to prevent emission of the motor cable is recommended to use shielded cable. The shielding must be connected to the ground of the converter and to the ground terminal of the motor.
In this configuration due to the characteristics of the special filter for converter, it is allowed to use unshielded cable. The cable length must be less or equal 25m.
- Transformer: must be shielded between primary and secondary windings and its rated power must be adequate for equipment requirements.
- Clamp resistor (C): connected through twisted cable with length less or equal 2m.
- Motor signal cable (D): shielded cable with length less or equal 25m.
- Control connections (E): shielded cable with length less or equal 3m.
- EMI filter: special filter for converter code 2SMPM3338/OC with cable.

Conformity

In this configuration the converter is compliant with the regulations referenced above .

8.4 Installation without special filter for converter

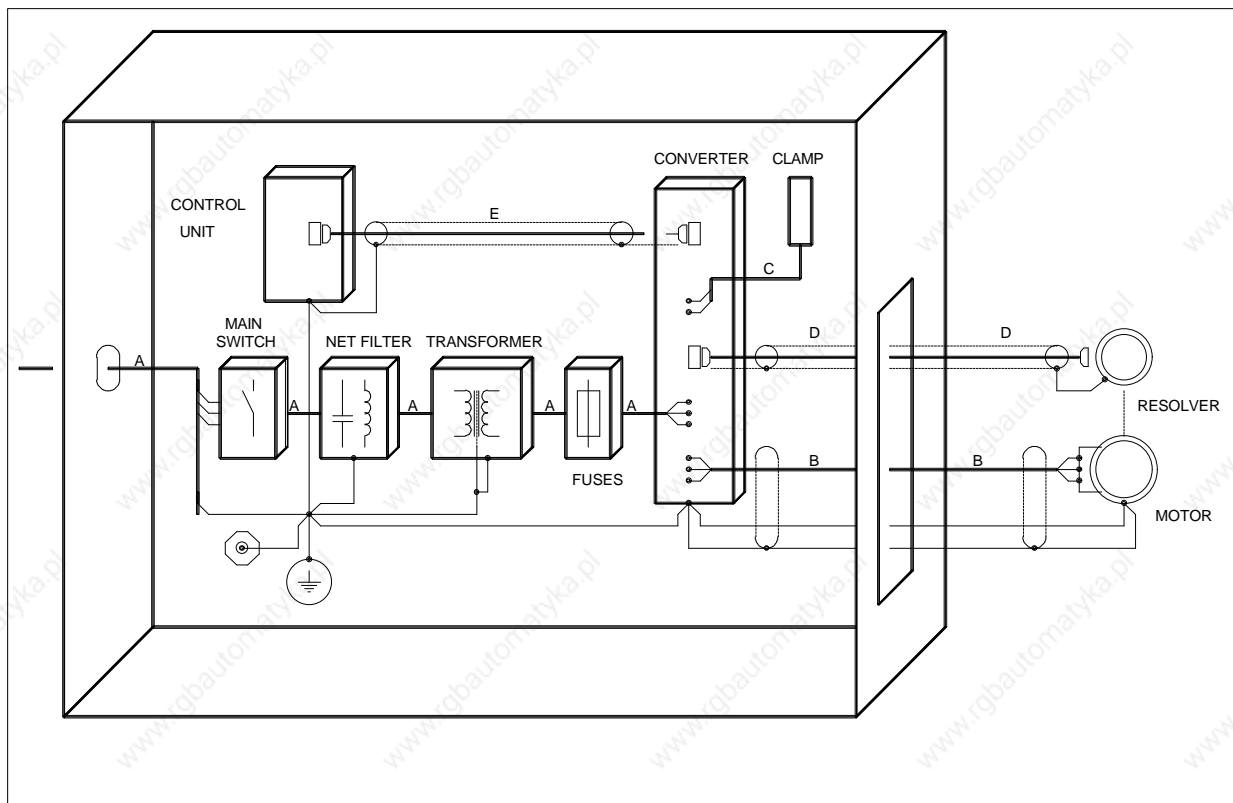

- Supply cable(A): no prescription
- Motor cable(B): to prevent emission of the motor cable is recommended to use of shielded cable. The shield must be connect to the converter ground terminal and to the ground terminal of the motor. The cable length must be less or equal 25m.
- Transformer: must be shielded between primary and secondary windings and its rated power must be adequate for equipment requirements.
- Clamp resistor (C): connected through twisted cable with length less or equal 2m.
- Motor signal cable (D): shielded cable with length less or equal 25m.
- Control connections (E): shielded cable with length less or equal 3m.
- Network filter: Siemens B84143-B XXR with following characteristics:
 - Nominal voltage: 440/250 Vac, 50/60Hz
 - Phase number: 3
 - Temperature range: -25...+40 gradi
 - Nominal current: range XX = 8-12-16-25-36A for different models
- Cabinet: All equipments should be installed in metal cabinet closed over all sides.

Conformity

In this configuration the converter is compliant with the regulations referenced above .

8.5 Installation without filters

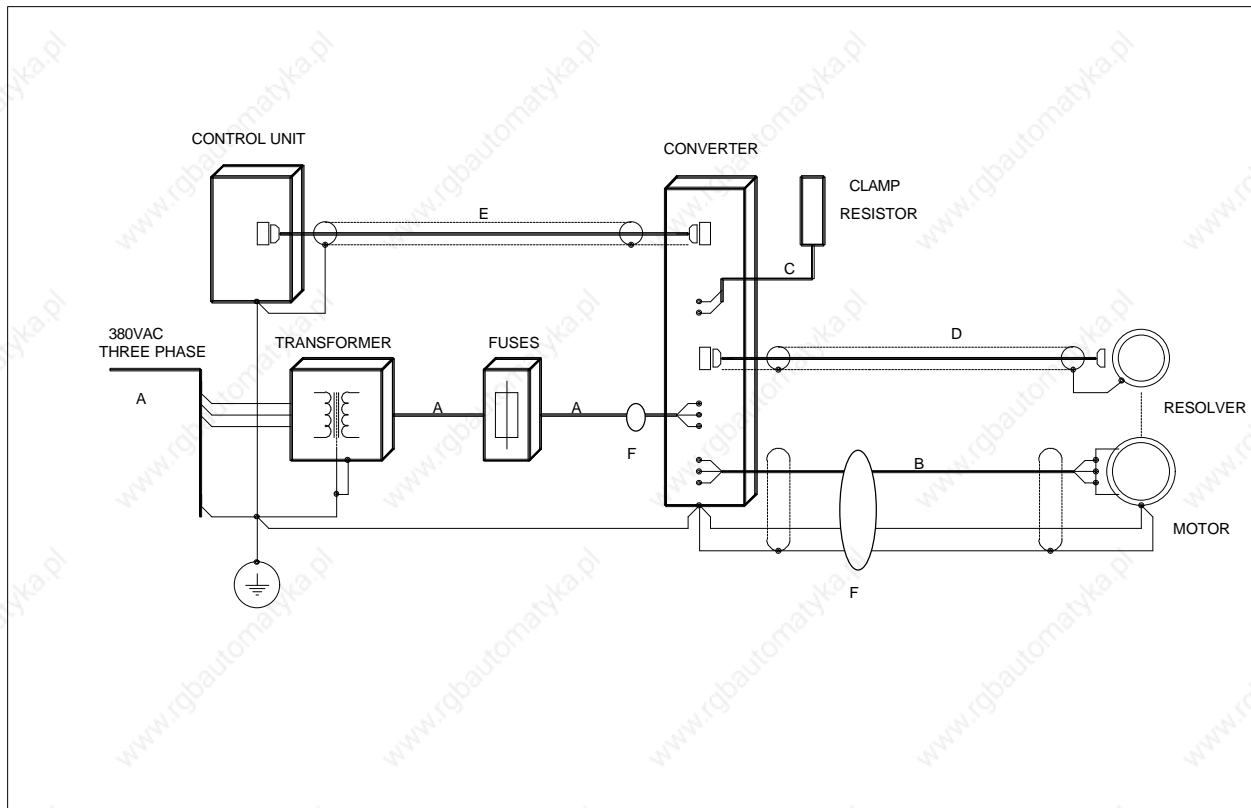

- Supply cable(A): no prescription. Install a suppression ferrite KITAGAWA SFC10 (F)
- Motor cable(B): to prevent emission of the motor cable is recommended to use of shielded cable. The shield must be connect to the converter ground terminal and to the ground terminal of the motor. The cable length must be less or equal 25m. Install a suppression ferrite KITAGAWA SFC10 (F)
- Transformer: must be shielded between primary and secondary windings and its rated power must be adequate for equipment requirements.
- Clamp resistor (C): connected through twisted cable with length less or equal 2m.
- Motor signal cable (D): shielded cable with length less or equal 25m.
- Control connections (E): shielded cable with length less or equal 3m.

Conformity

In this configuration the converter is compliant with all the regulation referenced above regarding immunity (EN50082-2).

In this configuration the converter is not compliant to the emission regulation EN55011 (Emission, Generic standard).

In this configuration the converter is compliant to the product specific regulation EN61800-3 for the class "Restricted distribution" and "Second environment".

Note:

Restricted distribution: The mode of sales distribution in which the manufacturer restricts the supply of equipment to supplier, customer or users who separately or jointly have technical competence in the EMC requirements of the application drives.

Second environment: The environment which includes all establishment other than those directly connected to a low voltage power supply network which supplies building used for domestic purposes.

It is available on request the documentation of the radiated and conducted emission measurements to perform adequate action.

If this equipment must work in the first environment please contact the manufacturer.

8.6 Connecting cables

Connector	Function	R05	R10, R15	R20, R30
TB 1	Clamp resistor connections		1,5 mm ²	
TB 2	Power to motor phases	1,5 mm ²	2,5 mm ²	4 mm ²
TB 3	Main supply	1,5 mm ²	2,5 mm ²	4 mm ²
TB 4	Brace connection		0,5 – 1 mm ²	
JP 1	Connections to resolver		0,14 – 0,22 mm ²	
JP 2	Connections to the control unit		0,14 mm ²	