

SA1U Heavy-duty Photoelectric Sensor

Features

- Four sensing methods:
 - Through-beam
 - Polarized retro-reflective
 - Diffuse
 - Background suppression
- Up to 50m sensing range
- Universal voltage type: 24 to 240V AC / 12 to 240V DC
- DC voltage type: 12 - 24V DC
- IP67
- Adjustable time delay: 0.1 to 5 seconds
- Operation and stable LED indicators
- NO/NC relay output, 3A
- Interference prevention allows two units to be mounted in close proximity (polarized retro-reflective, diffuse and background suppression)
- Spring-up terminal block structure enables easy wiring



Part Numbers

| Sensing Method | Detectable Object | Sensing Range | Power Voltage | Control Output | Included Accessories | Time Delay Functions | Part Numbers |
|--------------------------------|--------------------------|---------------|--|--|--|----------------------|--------------|
| Through-beam | Opaque | 50m max. | 24 to 240V AC (50/60Hz) 12 to 240V DC | Relay contact SPDT 250V AC/3A, 30V DC/3A (resistive load) | Sensitivity control screwdriver Mounting bracket Gland, gland washer Gland gaskets* | Without | SA1U-T50M |
| | | | 12 to 24V DC | NPN/PNP open collector | | With | SA1U-T50MT |
| Polarized Retro-reflective | Opaque Mirror surface | 7m max. | 24 to 240V AC (50/60Hz) 12 to 240V DC | Relay contact SPDT 250V AC/3A, 30V DC/3A (resistive load) | Sensitivity control screwdriver Reflector (IAC-R5) Mounting bracket Gland, gland washer Gland gaskets* | Without | SA1U-P07M |
| | | | 12 to 24V DC | NPN/PNP open collector | | With | SA1U-P07MT |
| Diffuse | Opaque Transparent | 1m max. | 24 to 240V AC (50/60Hz) 12 to 240V DC | Relay contact SPDT 250V AC/3A, 30V DC/3A (resistive load) | Sensitivity control screwdriver Mounting bracket Gland, gland washer Gland gaskets* | Without | SA1U-D01M |
| | | | 12 to 24V DC | NPN/PNP open collector | | With | SA1U-D01MT |
| Background Suppression | Opaque | 2m max. | 24 to 240V AC (50/60Hz) 12 to 240V DC | Relay contact SPDT 250V AC/3A, 30V DC/3A (resistive load) | Sensitivity control screwdriver Mounting bracket Gland, gland washer Gland gaskets* | Without | SA1U-B02M |
| | | | 12 to 24V DC | NPN/PNP open collector | | With | SA1U-B02MT |

*Two different-size gland gaskets are supplied. Select according to the cable diameter.

Small hole gasket: cable diameter ø8 to ø9 mm

Large hole gasket: cable diameter ø9 to ø10 mm

Specifications

Universal Voltage

| Sensing Method | Through-beam | Polarized Retro-reflective | Diffuse | Background Suppression |
|-------------------------|--|----------------------------|-----------------------|------------------------|
| Part Number | SA1U-T50M, SA1U-T50MT | SA1U-P07M, SA1U-P07MT | SA1U-D01M, SA1U-D01MT | SA1U-B02M, SA1U-B02MT |
| Power Voltage | 24 to 240V AC (21.6 to 264V AC) 50/60Hz, 12 to 240V DC (10.8 to 264V DC) | | | |
| Power Consumption | Projector: 3 VA maximum Receiver: 3 VA maximum | | 3 VA maximum | |
| Control Output | Relay contact SPDT, switching capacity: 250V AC/3A (resistive load), 30V DC/3A (resistive load) Electrical life (minimum operations): 100,000 (NO contact), 50,000 (NC contact) Mechanical life (minimum operations): 50,000,000 | | | |
| Minimum Applicable Load | 5V DC, 10 mA minimum (reference value) | | | |
| Response Time | 20 ms maximum | | | |
| Insulation Resistance | Between power and output terminals: 20 MΩ minimum (500V DC megger) | | | |
| Dielectric Strength | Between power and output terminals: 1500V AC, 1 minute, Between output terminals: 750V AC, 1 minute | | | |
| Weight (approx.) | Projector: 115g, Receiver: 130g | | 130g | |

DC Power Type

| Sensing Method | Through-Beam | Polarized Retro-reflective | Diffuse | Background Suppression |
|-----------------------|--|---|---------------------------|---------------------------|
| Part Number | SA1U-T50MW SA1U-T50MWT | SA1U-P07MW SA1U-P07MWT | SA1U-D01MW SA1U-D01MWT | SA1U-B02MW SA1U-B02MWT |
| Power Voltage | 12 to 24V DC (10 to 30V DC) ripple rate 10% p-p maximum | | | |
| Current Draw | Projector: 20mA max Receiver: 25mA max | 30mA maximum | | |
| Control Output | Type | NPN, PNP open collector (dual output) | | |
| | Load Current | NPN: 100 mA maximum, PNP: 100mA maximum | | |
| | Applied Voltage | 30V DC maximum | | |
| | Voltage Drop | NPN: 2.4V maximum, PNP: 2.4V maximum | | |
| Response Time | 1 ms maximum | | | |
| Insulation Resistance | Between live and dead parts: 20MΩ minimum (500V DC megger) | | | |
| Dielectric Strength | Between live and dead parts: 1000V AC, 1 minute | | | |
| Weight (approx.) | Projector: 105g, Receiver: 110g | 110g | | |

General Specifications

| Sensing Method | Through-beam | Polarized Retro-reflective | Diffuse | Background Suppression |
|---------------------------|--|--|--|--|
| Sensing Distance | 50m maximum | 0.2 to 7m (when using supplied reflector IAC-R5) | 1m maximum (200 × 200mm white matte paper) | 0.2 to 2m (200 × 200 mm white matte paper) |
| Preset Distance | | — | | 0.4 to 2m (200 × 200 mm white matte paper) |
| Detectable Object | Opaque | Opaque/Mirror surface | Opaque/Transparent | Opaque |
| Hysteresis | — | — | 20% of sensing distance max. | 15% of sensing distance max. |
| Operation Mode | Light ON or Dark ON (mode selector) | | | |
| Control Output | [Projector]Power LED: Green [Receiver] Operation LED: Yellow Stable LED: Green | Operation LED: Yellow Stable LED: Green | | Operation LED: Yellow |
| Light Emitting Element | Infrared LED (870nm) | Red LED (660 nm) | Infrared LED (870 nm) | |
| Sensitivity Adjustment | 1-turn control knob | | | 8-turn control knob |
| Extraneous Light Immunity | Sunlight: 10,000 lux maximum, Incandescent lamp: 5,000 lux maximum | | | |
| Vibration Resistance | Damage limits: 10 to 55Hz, amplitude 1.5mm, 30 minutes in each axis | | | |
| Shock Resistance | Damage limits: 500 m/s ² (50G), 3 shocks each in 6 axes 3 consecutive times | | | |
| Operating Temperature | -25 to +60°C (no freezing), storage temperature: -40 to +70°C | | | |
| Operating Humidity | 35 to 85% RH (no condensation), storage humidity: 35 to 85% RH | | | |
| Connection Method | Terminal block with M3 spring-up terminals | | | |
| Applicable Cable | Outside diameter ø8 to ø10 mm (core 0.3 to 0.75mm ²) | | | |
| Cable Extension | Extendable up to 100m with a cable of 0.3mm ² minimum | | | |
| Housing Material | PBT (indicator cover: PC) | | | |
| Lens Material | PC/PET | PMMA | PC/PET | |
| Degree of Protection | IP67 (IEC/EN60529) | | | |

Time Delay Specifications

| Sensing Method | Through-beam | Polarized Retro-reflective | Diffuse | Background Suppression |
|-----------------------------------|--|----------------------------|------------|------------------------|
| Part Number | SA1U-T50MT | SA1U-P07MT | SA1U-D01MT | SA1U-B02MT |
| Time Range | 0.1 to 5.0 sec (adjusted with a 1-turn control knob) | | | |
| Time Delay Function | One shot, ON delay, OFF delay, and normal (no time delay operation) modes | | | |
| Temperature Effect of Time Delay | ±10% maximum of the time delay at 20°C temperature rise within the operating temperature range | | | |
| Repetitive Accuracy of Time Delay | ±1.0% maximum of the time delay for repetitive inputs at 10 seconds or more | | | |

Dimensions (mm)

SA1U

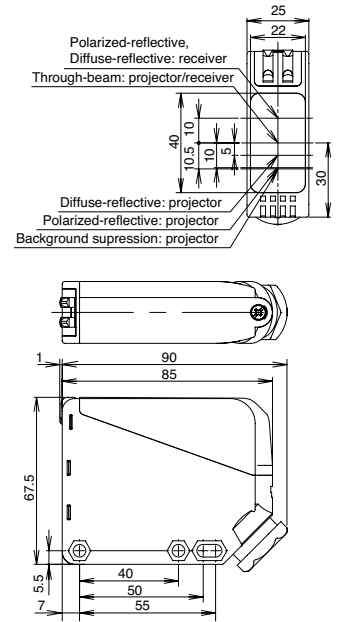

SA1U with Mounting Bracket

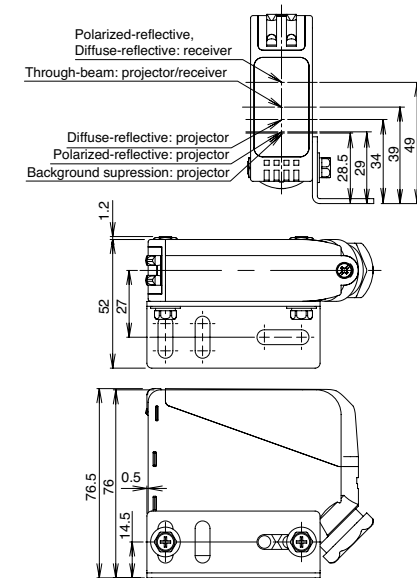

Mounting Bracket

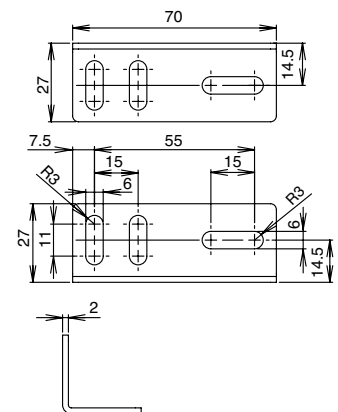

Models

Without Time Delay

SA1U-T50M
SA1U-P07M
SA1U-D01M

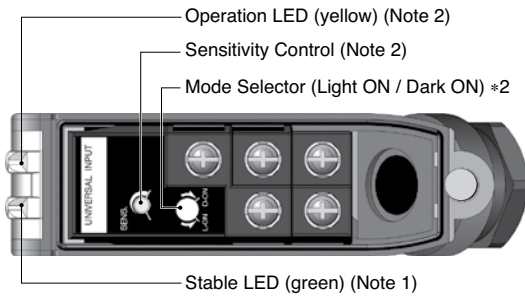

SA1U-B02M

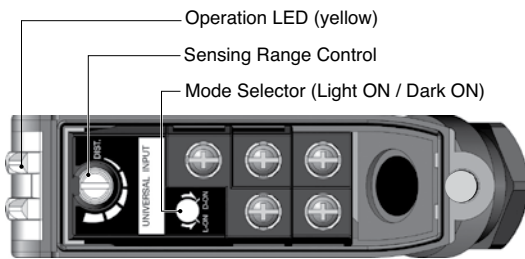

*1: Power LED for through-beam projector
*2: Not available on through-beam projector

Output Circuit / Connection Diagram

Universal Voltage Type

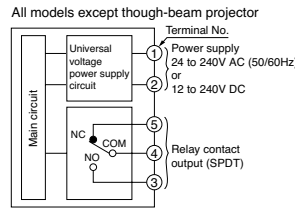

DC Voltage Type

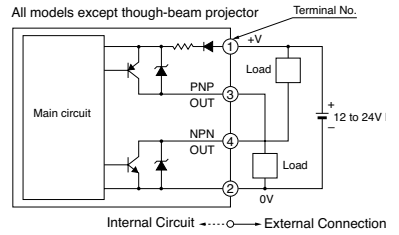

Though-beam projector

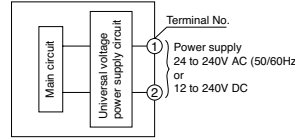

Though-beam projector

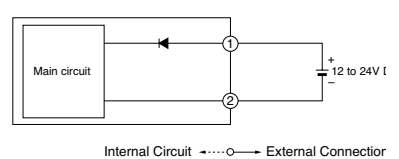

Terminal Arrangement

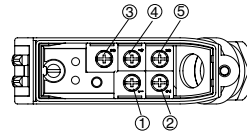

Operation Chart

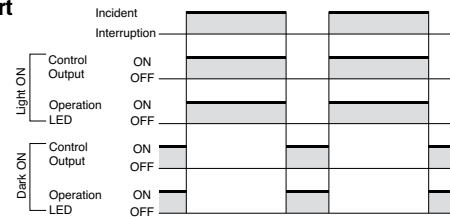

With Time Delay

SA1U-T50MT
SA1U-P07MT
SA1U-D01MT

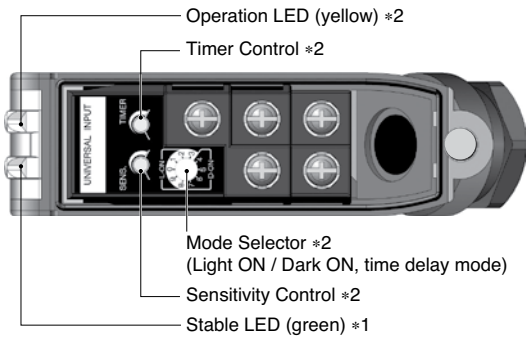

SA1U-B02MT

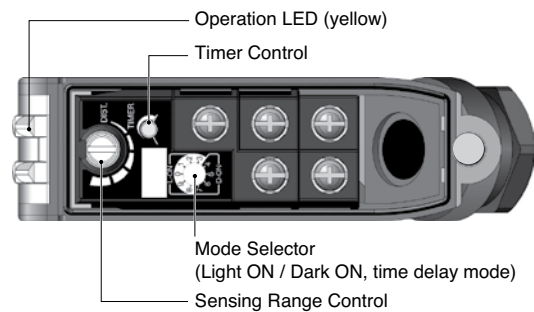

*1: Power LED for through-beam projector
*2: Not available on through-beam projector

Output Circuit / Connection Diagram

See the "Output Circuit / Connection Diagram" diagram above.

Terminal Arrangement

See the "Terminal Arrangement" diagram above.

Operation Chart

| Operation Mode | Mode Selector Position | Incident Interruption | Control Output | Operation LED |
|----------------|------------------------|-----------------------|----------------|---------------|
| Light ON | OFF delay (0) | ON | ON | ON |
| | Normal (1) | ON | ON | ON |
| | One shot (2) | ON | ON | ON |
| | ON delay (3) | ON | ON | ON |
| Dark ON | OFF delay (4) | ON | OFF | OFF |
| | Normal (5) | ON | OFF | OFF |
| | One shot (6) | ON | OFF | OFF |
| | ON delay (7) | ON | OFF | OFF |
| Light ON | Normal (8) | ON | ON | ON |
| | Normal (9) | OFF | ON | ON |

Characteristics (Typical)

Through-beam SA1U-T50M

Excess Gain
(transparency 1% ND filter is used)

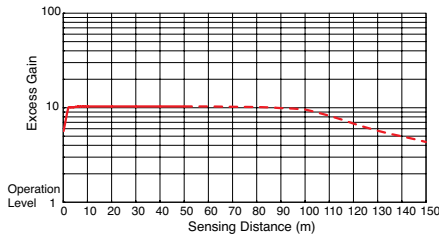

Lateral Displacement
(transparency 2.8% ND filter is used)

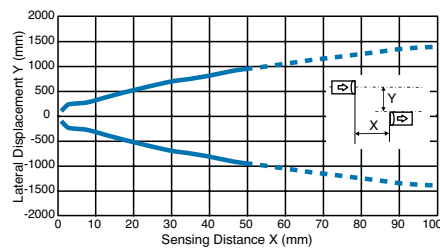

Angle

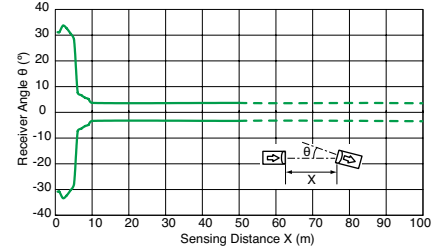

Polarized Retro-reflective SA1U-P07M

Excess Gain

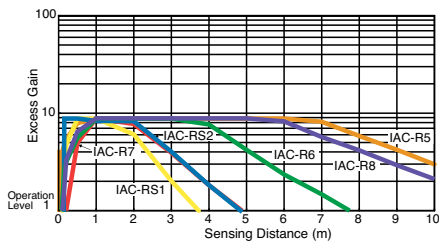

Lateral Displacement

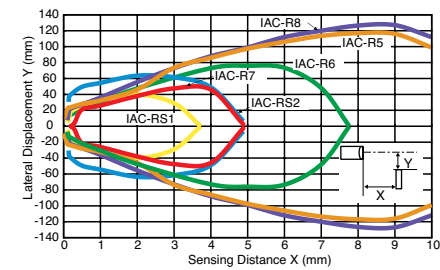

Angle

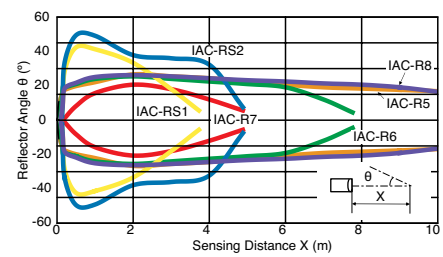

Diffuse SA1U-D01M

Excess Gain

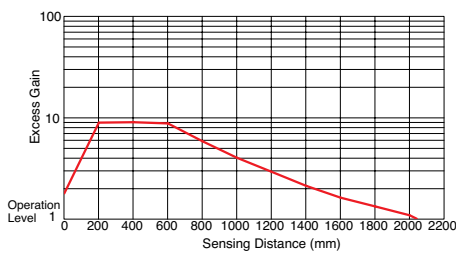

Lateral Displacement

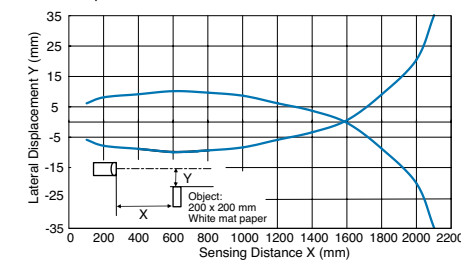

Object Size vs. Sensing Distance

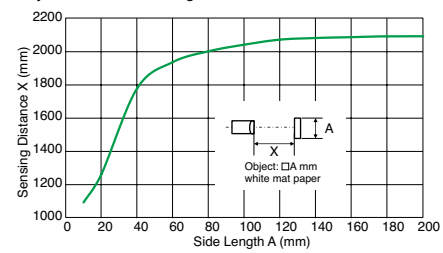

Background Suppression SA1U-B02M

Lateral Displacement (preset 1m)

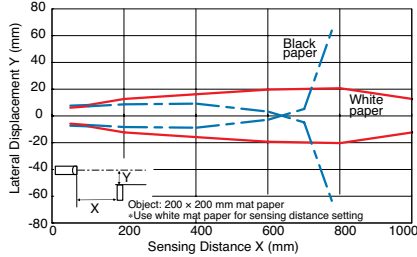

Lateral Displacement (preset 2m)

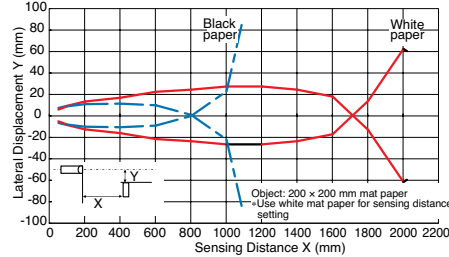

Light Beam Diameter

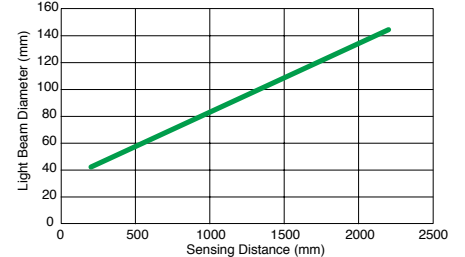

Sensing Distance vs. Hysteresis

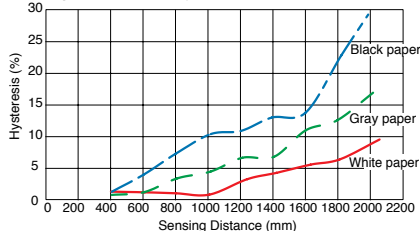

Control Knob vs. Sensing Distance

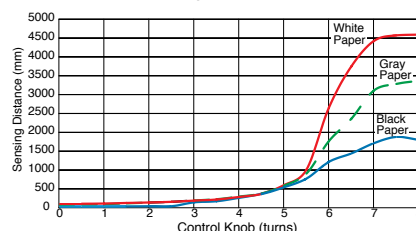

Colored Matte Paper and Other Materials

