

SIMATIC S5-115U/H/F

General

S5-115U

Application

3

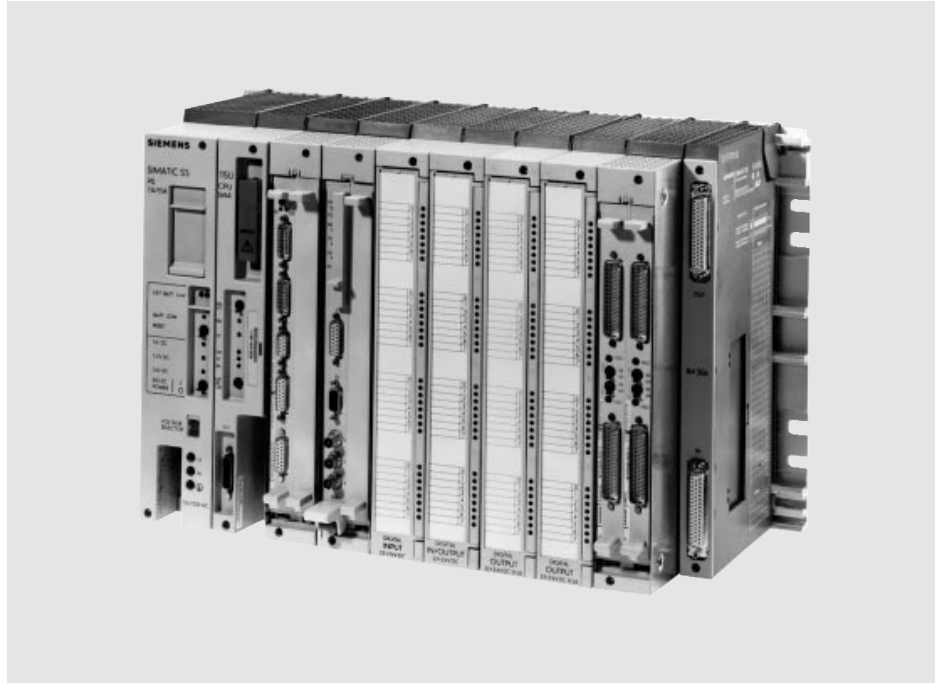

Fig. 3/1 S5-115U programmable controller (sample configuration)

The S5-115U programmable controller is suitable for automation tasks in the medium performance range.

Its highly modular design featuring five different powerful CPUs has set a new standard.

The S5-115U is suitable for such areas as:

- Machine control systems
- Process automation
- Process monitoring

The rugged construction of this PLC makes it suitable for use under harsh operating and environmental conditions, e.g. in the vicinity of power equipment, in cranes, on ocean-going ships, or in off-shore installations.

The standardized hardware technology, the highly modular design of the PLC and the high performance capabilities of the programming devices give the system the following features:

- Easy use due to simple assembly and connection
- Simple replaceability with snap-on block-type modules
- Adaptability through the use of different input and output voltages as well as the finely graduated modular expansion capability of the inputs, outputs and memory
- Operation without fans in all standard applications
- Simple and vibration-resistant mounting of modules, which are simply snapped onto the solid mounting rack and locked into position with screws
- Simple programming by means of structured programming and the use of standardized program sections (function blocks)
- Off-loading of the CPU and the program through the use of intelligent I/O modules (e.g. digital position decoder, valve control module)
- Simple communication with other programmable controllers and computers through the use of internal communications processors and LANs
- Easy system start-up by means of programming devices and service units with extensive programming and debugging aids

S5-115U (continued)

Design

An S5-115U programmable controller (PLC) consists of a central controller (with CR 700) and as many expansion units as required (with ER 701).

The central controller always contains a power supply module and a CPU module.

The expansion units can be configured with or without a power supply module, depending on the type. They are connected to the central controller using interface modules.

Depending on the automation task, different input/output modules can be plugged into the PLC:

- Digital and analog I/O modules
- Communications processors
- Intelligent I/O modules
- Modules for special functions

Adapter casings are available for modules which are not of block-type construction.

3

Possible configurations

Central configuration

In a central configuration the expansion units (EUs) are either in the same cabinet as the central controllers (CCs) or in a separate cabinet next to it. The maximum length for the cable connecting the CC to the furthest EU is 2.5 m (8.2 ft).

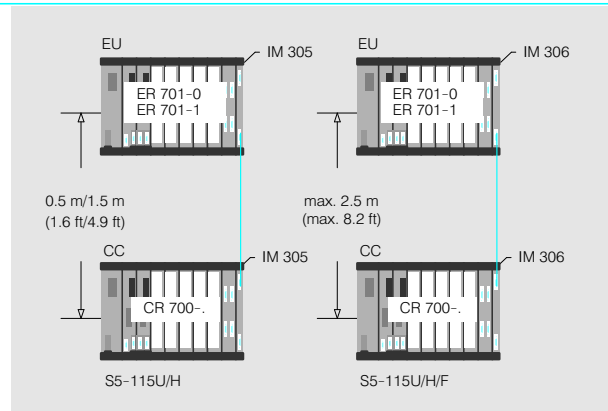

Fig. 3/2 Central connection of expansion units

Distributed configuration

In a distributed configuration the EUs are installed at a distance of up to 3000 m (9840 ft) from the CC. Three additional EUs can be connected in a central configuration to each distributed EU.

Note

The expansion units of other SIMATIC S5 programmable controllers, distributed peripherals and field devices can also be connected.

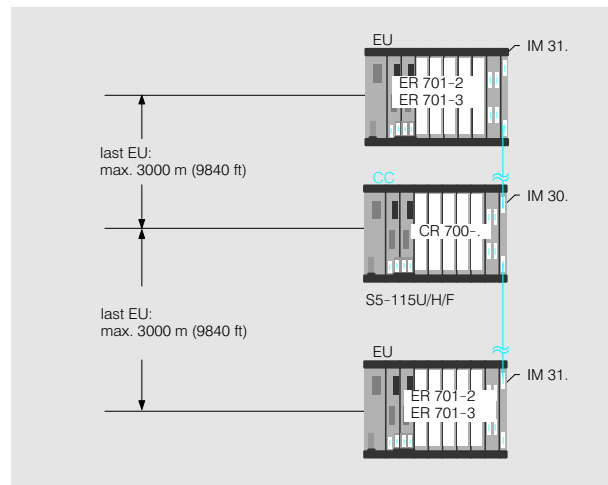

Fig. 3/3 Distributed connection of expansion units

General technical specifications

Insulation group	C in acc. with VDE 0110 (line-side), Para. 13 Group 2 (for 48 V, 24 V, 5 V input/output)	Humidity rating	F in acc. with DIN 40040 (15% to 95% non-condensing)
Degree of protection	IP 20 for power supply modules or modules with screw terminals, otherwise IP 00	Altitude rating	860...1060 hPa (660...1060 hPa during transport and storage)
Ambient temperature	0...55 °C (air inlet temperature below)	Mechanical loading	Mounting in fixed equipment which is free of vibrations; suitable precautions must be taken to prevent sustained vibration, shocks and bumping
Transport and storage temperature	- 40...+ 85 °C		

SIMATIC S5-115U/H/F

General

S5-115U (continued)

Principle of operation

The principle of operation of the S5-115U programmable controller is largely governed by the function components "program memory" and "processor".

In the versions of the S5-115H and S5-115F programmable controllers, the redundant functions are an additional factor.

Program memory

The program memory contains the user program.

Processor

The processor operates cyclically:

At the beginning of each cycle, the processor reads the signal states of all inputs and stores them in a process input image (PII).

The program is executed step by step.

The processor stores the calculated signal states in a process output image (POI). At the end of a cycle, the processor transfers the information from the process output image to the outputs.

The cycle can be stopped by interrupts (process and time interrupts).

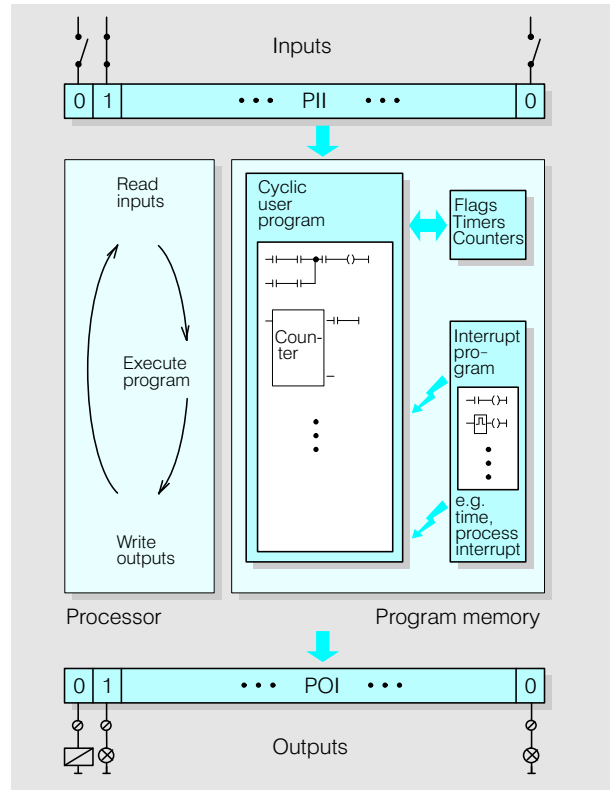

Fig. 3/4 Principle of operation of the S5-115U

Programming

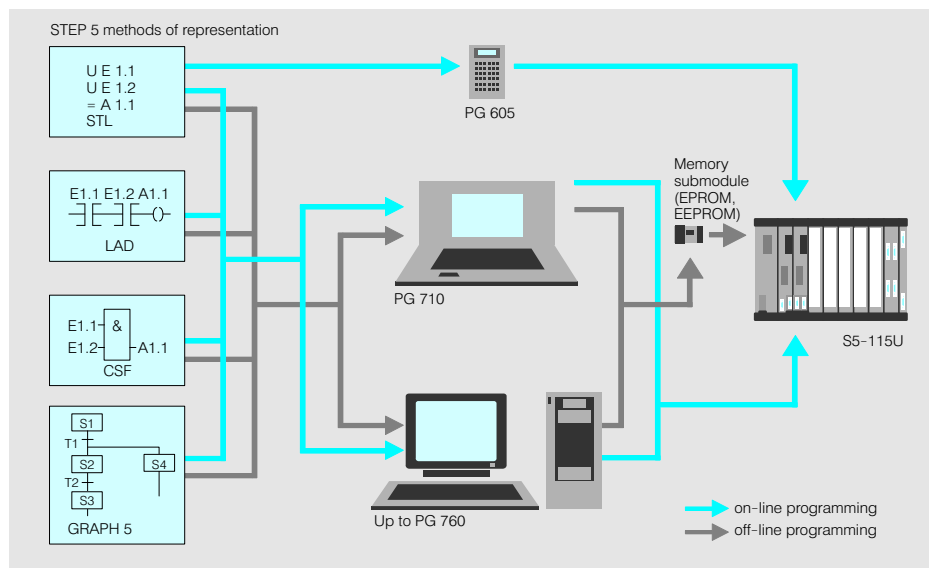

Fig. 3/5 Programming the S5-115U programmable controller

Programming language

The programming language for SIMATIC S5 programmable controllers is STEP 5 in one of the following representations:

- CSF - Control System Flowchart

- LAD - Ladder Diagram
 - STL - Statement List
- Programs for sequence control systems can be entered clearly in the form of a flow diagram using the

GRAPH 5 software package. Programmable controllers with CPU 945 can also be programmed in the SCL high-level language.

S5-115U (continued)

Programming devices

The following programming devices can be used for programming the S5-115U programmable controller:

- PG 605
- PG 720P
- PG 740
- PG 760

The programming devices have operator prompting to facilitate programming and numerous aids for debugging and system start-up. A printer can be connected to the programmer for program documenting.

Program input

There are two ways of entering the user program:

- Direct program entry to the CPU in the central controller (on-line programming)

- Programming the memory cards or memory submodules (flash EPROM, EPROM and EEPROM) in the programming device without connecting it to the programmable controller. The memory card or memory submodule is then plugged into the CPU (off-line programming)

Program execution

Cyclic program execution

OB 1: The blocks of the user program are executed in the sequence specified in organization block OB 1.

Interrupt-driven program execution

OB 2 to OB 5: When certain input signal changes (process interrupts) occur, cyclic execution is interrupted at the next statement and an organization block assigned to this event is started. The user can formulate his response program to this interrupt in this organization block. Cyclic program execution is then resumed at the point at which it was interrupted.

Time-controlled program execution

OB 10 to OB 13: The time when processing takes place depends on the call interval. This can be set between 1 ms and 1 min (CPU 945) or between 10 ms and 10 min (CPU 941 to CPU 944). It is therefore possible to process certain parts of the program independently of the scan time.

Time interrupt-controlled program execution

OB 6: After a specified period of time, a time interrupt is initiated and this organization block is called. Subsequent execution depends on the program contents of OB 6 defined by the user for this purpose.

The higher-priority execution levels (organization blocks) can interrupt the lower-priority execution levels after any STEP 5 operation. The order of priority is as follows (from the highest to the lowest priority): time interrupt-controlled, interrupt-controlled, time-controlled, cyclic.

SIMATIC S5-115U/H/F

General

S5-115U (continued)

Communication

Point-to-point connection

3

The communications processors enable the programmable controller to communicate with other programmable controllers, computers, operator control and process monitoring systems and peripherals via point-to-point connection.

They have their own memory for data, texts and displays. The communications processors handle data communications with the devices connected to them completely autonomously, thereby relieving the CPUs of time-consuming communications tasks.

For communication with computers, other programmable controllers and peripheral devices such as printers, either the CP 523, CP 524, CP 544 and CP 544B communications processors or the second interface of the CPU can be used (CPU 943, CPU 944, CPU 945).

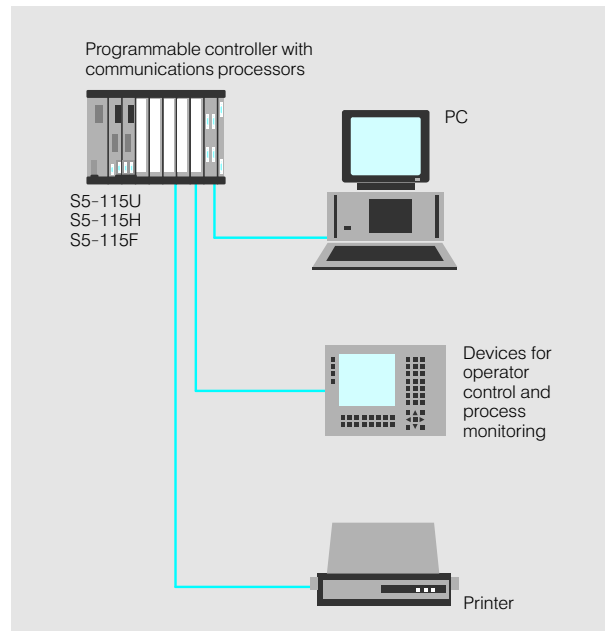

Fig. 3/6 Connections between programmable controller and PC, operator control and process monitoring equipment and printer

Communication with the equipment of the SIMATIC HMI operator control and process monitoring

system is handled by the CP 526, CP 527 and CP 528 communications processors.

Local area networks

SINEC L1 local area network
SINEC L1 (Siemens Network Communication Low Range) makes it possible to configure a small, distributed automation system on the lower level of communications technology by simple means.

The S5-90U, S5-95U/F, S5-100U, S5-115U/H/F, S5-135U and S5-155U/H programmable controllers can be connected.

Features

- Up to 31 nodes
- Baud rate 9.6 kbit/s
- Max. coverage 50 km (31 miles)
- Transmission medium: twisted pair cable

PROFIBUS local area network

See Section 10.

Industrial Ethernet local area network

See Section 10.

S5-115U (continued)**Quality assurance procedures**

To ensure correct operation of all SIMATIC S5 products and to prevent failures, extensive, cost-effective quality assurance procedures are carried out at every stage of the life of a product:

- During product planning
- During product development
- During production
- In product operation

Product planning

The product planning phase covers all the activities from market research to type specification. Quality assurance in the product planning phase ensures that the SIMATIC S5 product conforms to the right standards of quality required on the market.

Product development and production

The following are some examples of routing quality assurance precautions taken during development and production:

- Use of high-quality components

- Worst-case design of all circuits
- Systematic and computer-controlled testing of all components supplied by subcontractors
- Burn-in of all LSI circuits, e.g. processors and memories. Burning in is an aging process which helps to reduce the number of failures early in a product's life. The components are subjected to a high temperature for several hours in a burn-in cubicle
- Measures to prevent static charge from building up when handling MOS circuits
- Visual inspections at various stages of production
- In-circuit testing of all modules, i.e. computer-aided testing of all components and their interaction with other components in the complete circuit
- Continuous heat-run test at elevated ambient temperature over a period of several days

- Careful computer-controlled final testing
- Statistical evaluation of all failures to enable the immediate initiation of suitable corrective measures

Product operation

Even when the SIMATIC S5 products are in operation on the customer's premises, they are still under constant supervision. Extensive quality control precautions are taken in the following areas:

- Stockkeeping and despatch
- Service
- Field observation

Established methods are used in all these areas, which operate precisely, punctually and conscientiously, whilst also remaining flexible for special customer requirements.

Sometimes an even higher level of fault-tolerance or safety is required than that normally offered by the SIMATIC S5 U range. Fault-tolerant or failsafe programmable controllers, such as the S5-115H or S5-115F, are available for this purpose.

Availability

Availability is the probability of finding a system in a func-

tional state at a specified point in time.

Safety

Safety is defined by DIN 31000 as "A state of lower risk than the permitted limit". The "permitted limit is the maximum acceptable

degree of risk for a specific plant". The plant-specific degree of risk may be stipulated by law, by the plant ope-

rator or by an independent body of experts, e.g. the German Technical Inspectorate (TÜV).

Installation guidelines

SIMATIC programmable controllers are designed for use in harsh industrial environments. To ensure correct operation of the equipment, it must be installed and connected in accordance with certain rules. Certain principles must also be observed as regards wiring, earthing and shielding.

Timely planning of the necessary measures for improving the electromagnetic compatibility (EMC) of the programmable controllers is advisable in order to avoid retrofitting. These rules are explained in the section entitled "Installation guidelines" in the relevant product manuals.

For the installation of failsafe controls, the relevant regulations must be observed.

SIMATIC S5-115U/H/F

General

S5-115H

Application

3

In many fields of automation, increasingly high demands are being placed on the availability and fault tolerance of programmable controllers (PLCs). Particularly in fields where a plant shutdown would be extremely expensive. In such cases, only redundant systems can offer the standard of availability required.

Fault-tolerant systems will normally continue to operate even if one or more faults cause parts of the control system to fail.

The S5-115H programmable controller consists of two inter-linked central controllers. It operates on the "master/slave" principle. One subunit, the master, controls the process. If a fault occurs, the other subunit, the slave, immediately takes over control.

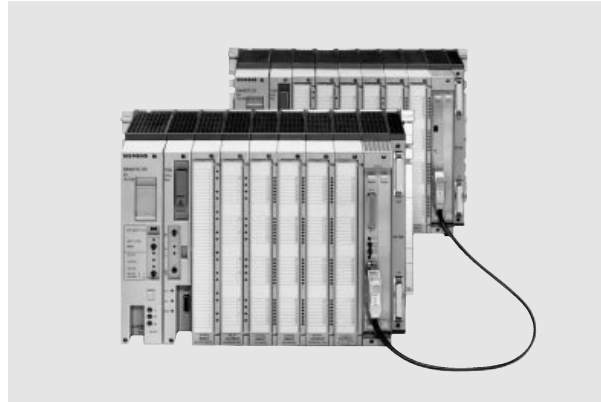

Fig. 3/7 S5-115H programmable controller

This ensures a high degree of fault tolerance, which makes the S5-115H especially suitable for applications in the following fields:

Fields with predominantly continuous processes, e.g.:

- Refineries
- Chemicals
- Power stations
- Steelworks
- Environmental protection (e.g. water treatment)
- Pipelines
- Off-shore installations

Areas of production employing batch processes, e.g.:

- The automotive industry
- The pharmaceutical industry
- The food industry
- In plants with flexible manufacturing systems
- In high-bay warehouses

The performance capability, user convenience and other technical features of the S5-115H fault-tolerant programmable controller correspond to a large extent to the features of the S5-115U.

Design

In the S5-115H programmable controller the central functions are always implemented in a redundant configuration. The I/Os can, however, also be configured with redundancy.

Three different levels of fault tolerance are possible, depending on the arrangement of the I/O modules:

- Normal fault tolerance (single-sided configuration)
- Enhanced fault tolerance (switched configuration)
- Maximum fault tolerance (fully redundant configuration)

Fig. 3/8 shows the configurations for the three levels of fault tolerance.

The different levels of fault tolerance can be combined as required.

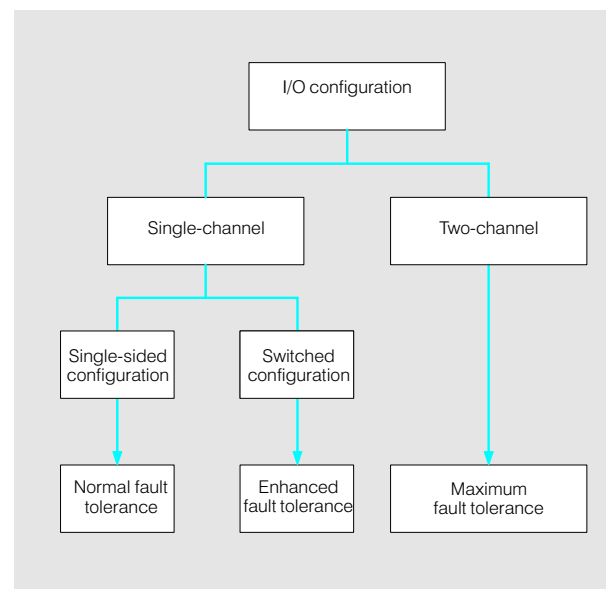

Fig. 3/8 Degrees of fault tolerance of the I/O area

S5-115H (continued)

Design (continued)

Normal fault tolerance

(single-sided configuration)

In the single-sided configuration (see Fig. 3/9) the I/Os are connected in single-channel mode and only addressed by one of the two subunits. The I/Os in this configuration can be plugged into either

- a central controller or,
- if the number of slots is not sufficient, expansion units.

Information read into the one subunit (e.g. from digital input modules) is automatically transmitted to the second subunit. It is immaterial whether one subunit is the master and the other the standby. What is important is whether or not the subunit which is connected to the I/Os is operational. In the event of a failure, the I/Os connected to the subunit concerned are also out of action.

This configuration is used for sections of a plant which do not require enhanced availability.

Enhanced fault tolerance
(switched configuration)

In the switched configuration (see Fig. 3/10) the I/Os are connected in single-channel mode, but they can be addressed by both subunits. The I/Os in this configuration must always be plugged into an expansion unit with an ER 701-3LH or EG 185U subrack.

Up to eight expansion units can be connected in switched configuration, distributed between up to two I/O bus lines.

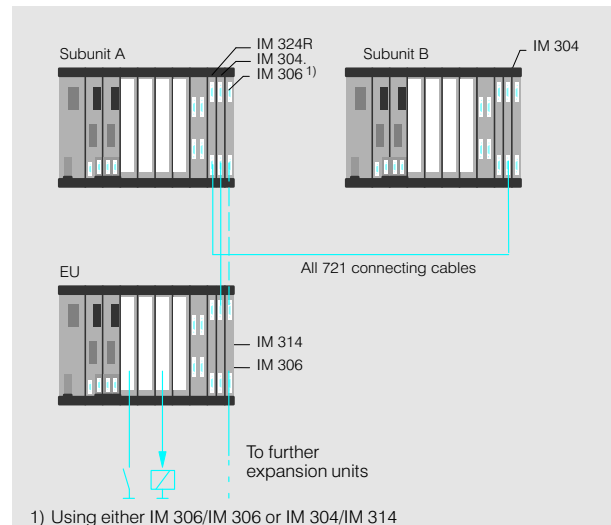

Fig. 3/9 Single-sided configuration (normal fault tolerance)

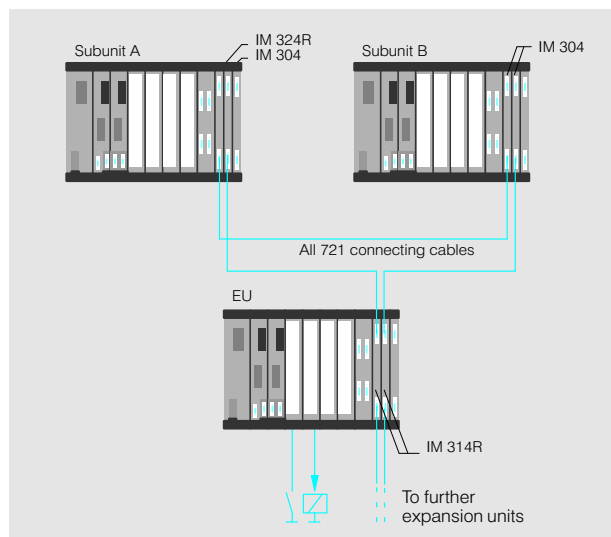

Fig. 3/10 Switched configuration (enhanced fault tolerance)

Expansion units in switched configuration are connected via the IM 304 interface module in the central controller and the IM 314R interface module in the expansion unit. The expansion units can also be expanded in a centralized configuration via the IM 306 interface module.

Expansion units in switched configuration are connected to both subunits and are addressed by the one currently acting as master.

This configuration is employed when failure of individual I/Os is not crucial.

SIMATIC S5-115U/H/F

General

S5-115H (continued)

Design (continued)

3

Maximum fault tolerance

(two-channel configuration)

In the two-channel configuration (see Fig. 3/11) identical I/Os are installed with the same addresses in both sub-units. Inputs and outputs can be used in redundant configuration in both the central controller and in additional expansion units. Both failure of central functions and failure of the I/Os on one channel can be tolerated. This configuration offers the maximum degree of availability.

The I/O modules in the redundant configuration must be made known to the operating system using the COM 115H parameterization software. The redundant I/O modules are addressed in the same way as single-channel I/O modules in the user program. The operating system does the rest.

The intelligent I/O modules and communications processors can also be used in two-channel, redundant configurations (see pages 3/53 and 3/56).

Expansion units can be connected to each central controller in the same way as for the S5-115U programmable controller, using the relevant interface modules (centralized and distributed configuration).

The ET 200 distributed I/O system can also be connected to the S5-115H programmable controller.

For further information on the configuration of the S5-115H fault-tolerant programmable controller, please see Section 11 (Configuring).

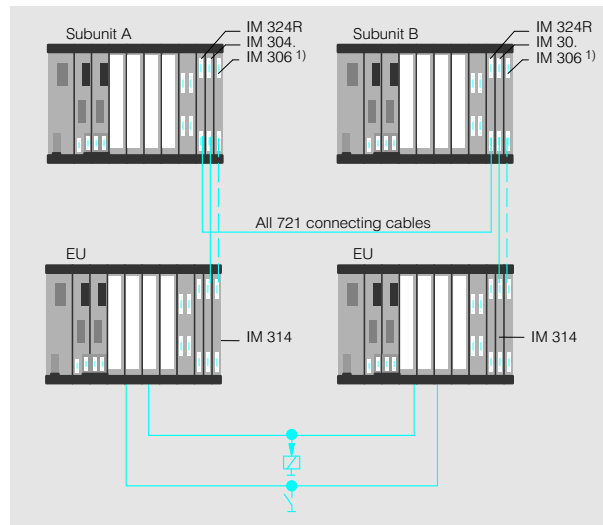

Fig. 3/11 Two-channel configuration (maximum fault tolerance)

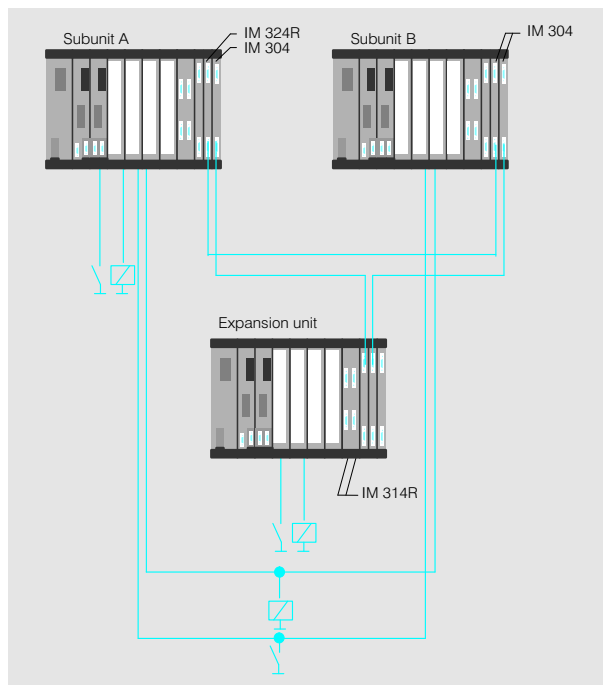

Fig. 3/12 Mixed configuration of an S5-115H

Mixed configuration

The different levels of fault tolerance can be combined as required. A mixed configuration (see Fig. 3/12), i.e. a combination of two-channel/redundant, switched and single-sided configuration is frequently the most economical solution.

S5-115H (continued)

Design (continued)

Redundancy of IPs and CPs

Intelligent I/O modules (IPs) and communications processors (CPs) can also be used redundantly. Both switched and two-channel redundant configurations are possible.

Criteria

Which configuration is the more suitable largely depends on the application.

Advantages of the switched redundant configuration:

- In the event of failure of one of the central controllers, the IPs/CPs retain their redundancy
- In the event of failure of one of the IPs/CPs, the central controllers retain their redundancy
- Shorter scan time

Disadvantages of the switched redundant configuration:

- At least two expansion units in switched configuration are required
- For repair of an IP/CP the expansion unit concerned needs to be switched off. All the other I/O modules in the same expansion unit are therefore out of action.

Advantages of the two-channel redundant configuration:

- No expansion units in switched configuration are required
- For repair of IPs/CPs it is usually only necessary to disconnect redundant components from the power supply.

Disadvantages of the two-channel redundant configuration:

- Longer scan time

Switched redundant configuration

At least two units are required for the switched redundant configuration. An IP or CP of the same type must be installed in each expansion unit. When data is received by one IP or CP, it is automatically transmitted to the other subunit.

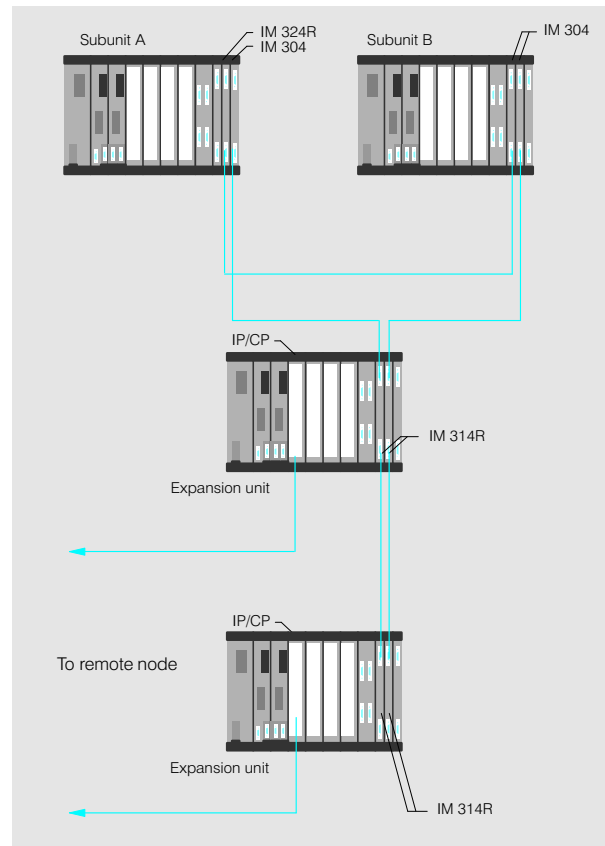

Fig. 3/13 IP/CP in switched redundant configuration

Two-channel redundant configuration

In the two-channel redundant configuration an IP or CP must be installed in each subunit. Unlike I/O modules in redundant configuration, the two IPs/CPs occupy different addresses or pages in the two subunits and operate independently of one another. When data is received by one IP or CP, it is automatically transmitted to the other subunit.

The redundancy function for the switched and two-channel redundant configurations must be programmed by the user. The user program defines which is the active IP or CP and must be able to detect a fault in one IP or CP in order to switch over to the other IP or CP if necessary. The operating system ensures that the data in the two subunits remains identical. The two IPs/CPs must be regarded as independent modules.

For further details, please see Configuring (Section 11).

SIMATIC S5-115U/H/F

General

S5-115H (continued)

Principle of operation

The principle of operation of the S5-115H fault-tolerant programmable controller can be compared with an "OR" operation. The programmable controller is in an operational state when at least one of the two subunits is functioning correctly (see Fig. 3/14).

Each of the central controllers contains a CPU 942H with a new firmware version compared with that of the CPU 942. This firmware performs all the additional functions of the S5-115H independently, e.g.:

- Data interchange
- Fault handling (switchover to standby)
- Synchronization of the two subunits
- Self-test
- Fault locating

The operating system of the S5-115H supports redundant operation of:

- Digital I/O modules
- Analog I/O modules

Data interchange and fault handling**Master-slave operation**

The S5-115H basically operates on the master-slave principle in hot-standby mode (see right). One subunit, the master, controls the process. If a fault occurs, the other subunit, the standby or slave, takes over the control functions. The faulty subunit can then be repaired without interrupting the process.

The combined operation of the two subunits differs according to the I/O configuration:

- Switched configuration. The master controls the process whilst the slave merely runs on standby. If a fault occurs, the standby immediately takes over control

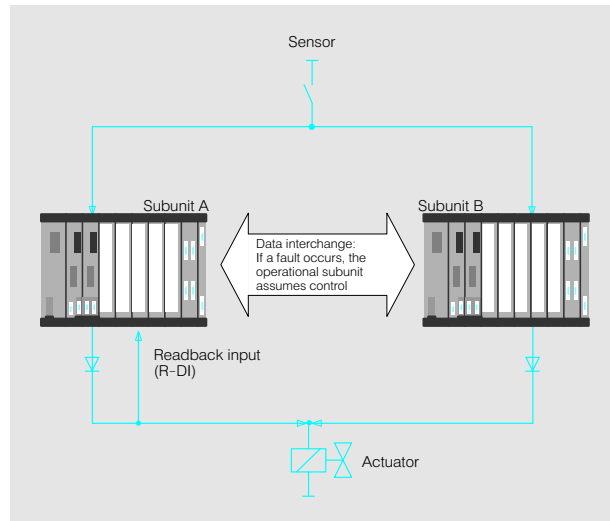

Fig. 3/14 Example of an S5-115H with redundant input and output

- Two-channel I/O configuration (fully redundant configuration). Both subunits control the process in parallel. The standby also issues output signals and reads in input signals. For further details please refer to Section 11

Hot-standby

Hot-standby is the ability to switch over to a standby device in the event of a fault automatically and without detrimental effect. For operation in this mode it is absolutely essential that both subunits should be able to exchange data quickly and reliably. In the S5-115H the two subunits are normally linked by the central controller interface via which they are both supplied with:

- The same user program
- The same data blocks
- The same process I/O image contents
- The same receive buffer contents, e.g. when using communications processors

The standby unit is therefore always up to date and ready to take over control immediately if a fault occurs.

Synchronization

To avoid in switching over from master to standby, synchronization of the subunits is essential. This includes interchange and comparison of data to ensure that both units have the same information at their disposal. The synchronization procedure used for the S5-115H is "event-driven synchronization".

Event-driven synchronization is carried out every time an event occurs which could change the internal state of the subunits, e.g.

- Commands with direct access to the I/Os
- Block call commands
- Time function commands

When programming, the user does not need to think about synchronization because this is taken care of by the operating system.

S5-115H (continued)**Principle of operation**
(continued)**Self-test**

Extensive self-test functions are implemented in the S5-115H programmable controller. The following components and functions are tested:

- Internal S5 bus
- Central controller link
- Fault location system
- CPUs
- Memories

Any faults detected during the self-test are reported.

Self-test on restart

Each subunit runs through all the self-test functions on restart.

Self-test in cyclic operation

For cyclic operation the operating system breaks down the self-test functions into short sections approximately 5 ms long. One or more of these are processed in a cycle. The number of sections per cycle is configured by the user.

Programming, parameter assignment**Programming**

Programming of the S5-115H is the same as for the S5-115U. All STEP 5 operations allowed in the S5-115U can be used.

Both on-line and off-line programming are possible.

On-line programming

For on-line programming the programming device is connected to the CPU of one of the subunits. The program is auto-matically relayed to the other subunit.

Off-line programming

Off-line programming is possible using an EPROM submodule in the programming device without connecting it to the programmable controller. The submodule is then duplicated and plugged into the CPUs of both subunits.

Parameter assignment

The COM 115H parameterization software supports the user in parameter assignment and error diagnostics:

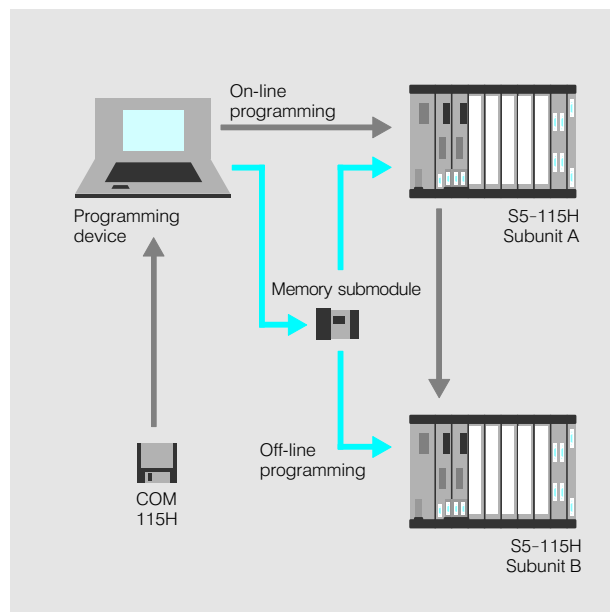

Fig. 3/15 On-line and off-line programming

- Interactive parameter assignment of data specific to the H version
- Generation of the parameter assignment data block from the parameter assignment data.
- System diagnostics using the error data blocks and the interrupt register
- Printout of data specific to the H version
- General system handling, e.g. loading blocks

SIMATIC S5-115U/H/F

General

S5-115H (continued)

Subracks for the S5-115H

Subracks for central controllers:

- CR 700-0LB
- CR 700-2
- CR 700-2F
- CR 700-3

Subracks for centralized expansion:

- ER 701-0
- ER 701-1

Subracks for distributed expansion:

- For single-sided or redundant configurations ER 701-2, ER 701-3 and ER 701-3LH
- For switched configurations ER 701-3LH and EG 185U

3

Interface modules for the S5-115H

In the S5-115H fault-tolerant programmable controller, interface modules are used

for connecting expansion units in centralized and distributed configurations, for

switched configurations and for linking the central controllers.

Configuration for	Interface module required in		
	Central controller	Expansion unit Single-sided or redundant configuration	Switched configuration
Centralized expansion	IM 305 IM 306	IM 305, IM 306 in ER 701-0/1	—
Distributed expansion	IM 304	IM 314 in ER 701-2/3/3 LH	2 x IM 314R in ER 701-3LH or EG 185U

CPU for the S5-115H

A CPU 942H is required in both subunits of the S5-115H fault-tolerant programmable controller.

I/O modules for the S5-115H

The following I/O modules can be used for the S5-115H fault-tolerant programmable controller:

- I/O modules; all digital I/Os except for the 776 power output module; all analog I/Os

- Intelligent I/O modules; all intelligent I/Os except for the IP 241 digital position encoder
- Communications processors

For further information on the I/O modules which can be used, see Section 11.

S5-115F

Application

Safety is becoming more and more important in modern manufacturing processes. That is why systems which represent a danger to man, machine, production and the environment in the case of a fault must meet increasingly stringent safety requirements. Redundant systems meet these safety requirements. Failsafe systems deactivate the defective part immediately if a fault occurs. This does not, however, increase the availability.

Failsafe operation of the S5-115F programmable controller is achieved by comprehensive quality assurance measures and by:

- The two-channel, i.e. redundant structure with comparison of results via the central controller interface

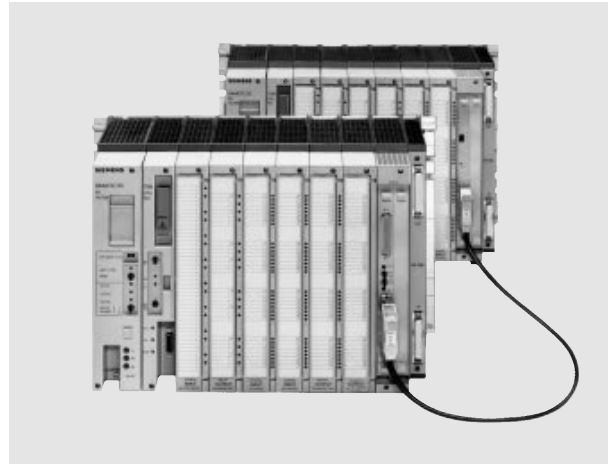

Fig. 3/16 S5-115F programmable controller

- Self-tests performed by the operating system
- The failsafety-specific external interconnection of I/Os

Requirement classes

The safety requirements which must be met by a control system are set down in DIN V 19250. This standard divides the control systems into eight safety requirement classes.

The requirement class for a certain application can be determined by means of the risk graph in accordance with DIN V 19250 shown in Fig. 3/17. Requirement class 1 represents the lowest safety requirements. Class 8 requires the highest safety standard.

The example illustrated in the risk graph shows how the requirement class for a burner control is determined. From the four risk parameters (extent of damage, duration of stay in hazardous areas, danger prevention and probability of occurrence) it is clear that the system must at least fulfill the conditions of requirement class 5.

In accordance with DIN V 19250, the failsafe S5-115F programmable controller corresponds to requirement class 6.

The S5-115F can therefore be used in the requirement classes 1 to 6.

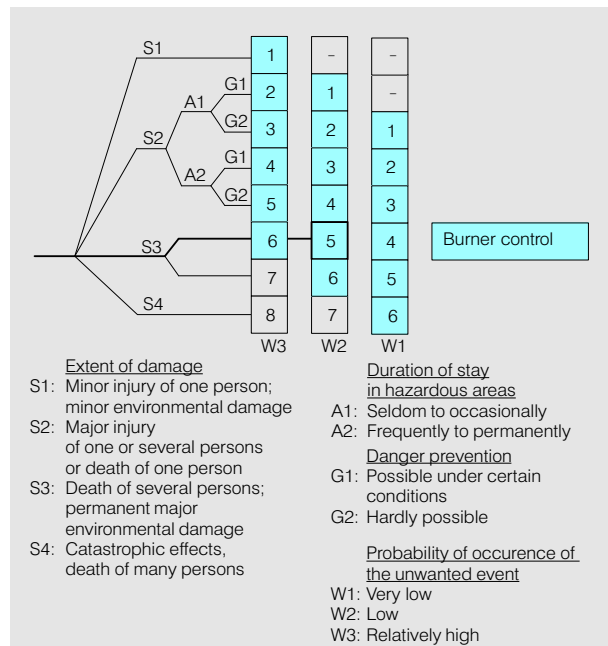

Fig. 3/17 Risk graph for the requirement classes in acc. with DIN V 19250 with examples of application

Applications for requirement class 6 include:

- Burner controls, e.g. in coal-fired power stations
- Passenger transport systems, such as cable railways, underground railways and fairground carousels
- Road traffic signal systems
- Telecontrol installations for gas and oil pipelines
- Environmental protection systems, e.g. pollutant filters
- Systems for the production of hazardous gases

SIMATIC S5-115U/H/F

General

S5-115F (continued)

Design

The S5-115F failsafe programmable controller consists of two interlinked central controllers. Only prototype-tested components may be used (see Section 11).

3

I/O configuration

The central functions of the S5-115F programmable controller are always redundant. For the I/O modules, a distinction is made between "safety-related" and "non-safety-related" areas.

Safety-related areas

In "safety-related" areas the I/O modules must always be in a two-channel, redundant configuration (see Fig. 3/18). This can be implemented in the central controllers or in expansion units. The operating system must be informed of which I/O modules are available in redundant configuration using the COM 115F parameter assignment software. The redundant I/O modules are addressed as single-channel I/O modules in the user program. The operating system does the rest.

Non-safety-related areas

In "non-safety-related" areas single-channel configuration of the I/O modules is sufficient (see Fig. 3/19).

The two-channel/redundant and single-channel configurations can be combined with one another. The I/Os in single-channel configuration can be allocated to the two subunits as desired.

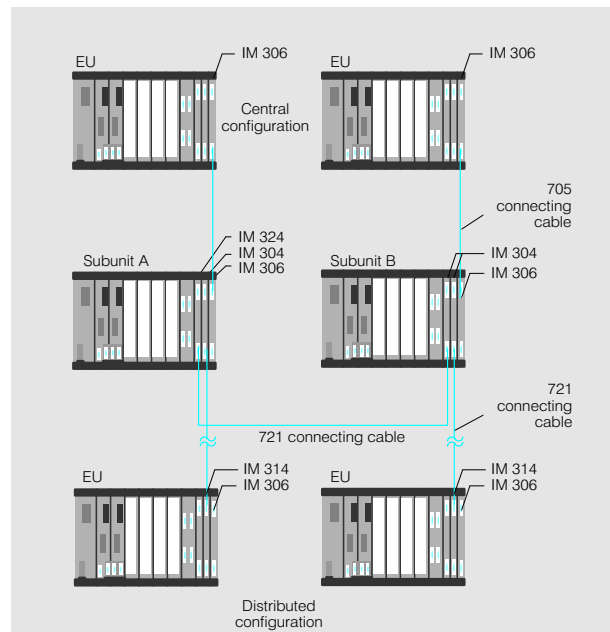

Fig. 3/18 Two-channel (redundant) I/O configuration (failsafe)

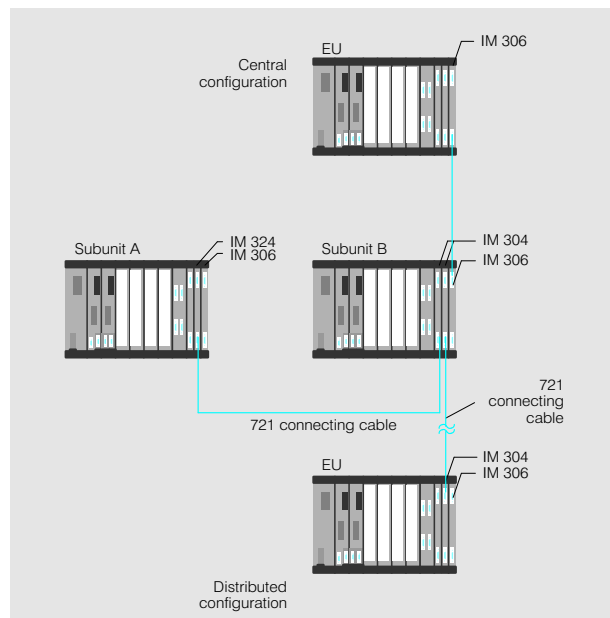

Fig. 3/19 Single-channel I/O configuration (failsafe in central controller, non-failsafe in expansion unit)

S5-115F (continued)**Principle of operation**

The principle of operation of the failsafe S5-115F programmable controller can be compared with an "AND" logic operation. It is in the operating state only when both subunits operate properly.

The two central controllers each contain a CPU 942F with firmware that is different from that of the S5-115U. This firmware executes all additional functions of the S5-115F independently as, for example:

- Data exchange and response to errors
- Synchronization
- Self-test

The failsafety of the I/O is ensured by the external interconnection of sensors and actuators (see Fig. 3/20 and Configuring in Section 11).

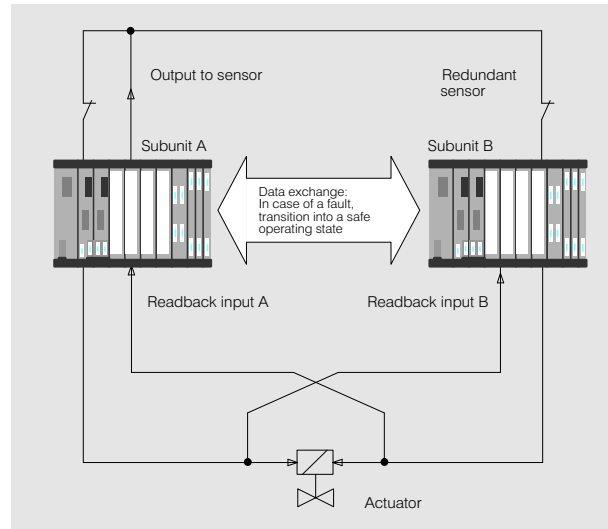

Fig. 3/20 Example of an S5-115F with safety-oriented input and output

Data exchange and response to errors

Both subunits can exchange data rapidly and reliably via the central controller interface, for the following purposes:

- Comparison
- Synchronization
- Passivation (switching off of functions)

Both subunits operate synchronously with the same user program. They carry out a cyclic comparison of:

- Their input signals
- Their output signals
- Other data, such as the timers and counters

Differences in the results of the two subunits indicate an error. A response to that error is then initiated. In the case of the failsafe S5-115F programmable controller this response and other protective functions have to be determined in the COM 115F parameter assignment software.

The following error response options are available:

- The entire unit is switched to STOP
- Only the defective components are deactivated
- User program response

Comparison of inputs

After reading the input signal states, the two subunits compare their process images. If they detect any differences between their process images, they read the input signals again - several times, if necessary - until the discrepancy time expires. If there are still any discrepancies between the two process images at that point, this indicates either an external or internal fault. The programmable controller immediately initiates the response to this error. The user can program the response and the discrepancy time himself as agreed with the acceptance authorities.

Comparison of outputs

At the end of one cycle, the two subunits compare their process images again. Different results indicate an internal fault. The selected error response is then initiated.

Comparison of further data

In addition, the two subunits compare

- The current state of timers and counters
- The current state of the logical program counter and, if necessary,
- The data from the SINEC L1 link

SIMATIC S5-115U/H/F

General

S5-115F (continued)

Principle of operation (continued) Synchronization

Both subunits must be continuously synchronized. That is why synchronization points are provided at the beginning and end of each program cycle and at every 20 ms in the operating system. At these points, data are exchanged and compared with each other.

During user program execution, the S5-115F subunits are also synchronized with the following events:

- Direct I/O accesses and clock scans; After such commands, the operating system automatically synchronizes both subunits

- Process and time interrupts; Process and time interrupts are processed only after a synchronization. At the operating system level, the S5-115F responds to an interrupt after a maximum of 20 ms. During user program execution the user himself must ensure synchronization by means of a standard function block.

3

Self-test

Extensive self-test functions are implemented in the S5-115F failsafe programmable controller.

The following components are tested:

- Internal S5 bus
- Central controller interface
- Processors
- Memory
- All redundant I/Os

These self-tests can even detect errors which have occurred in both subunits simultaneously.

Self-test during initialization

During initialization in failsafe operation, the whole range of self-test functions is run through completely in each subunit.

Self-test in cyclic operation

For cyclic operation, the operating system splits up the self-test functions into small test segments. Depending on the number of I/Os these are between 5 and 140 ms long. The number of test segments per cycle is determined by the user through the setting of the test cycle time.

Programming and parameter assignment

Programming

With the exception of certain restrictions, programming of the S5-115F is identical to that of the S5-115U. Program input can either be on-line or off-line (see S5-115H, page 3/14).

For on-line programming the CPUs of both subunits must be provided with the same memory submodule.

Frequently used functions, such as arithmetic and signalling functions, safety-oriented interfacing or burn control are available in the package of prototype-tested standard function blocks.

These function blocks have already been tested by the German Technical Inspectorate (TÜV) and therefore facilitate the system acceptance procedure (see Section 7).

Note

In the failsafe mode, the control program must be stored on an EPROM or EEPROM submodule.

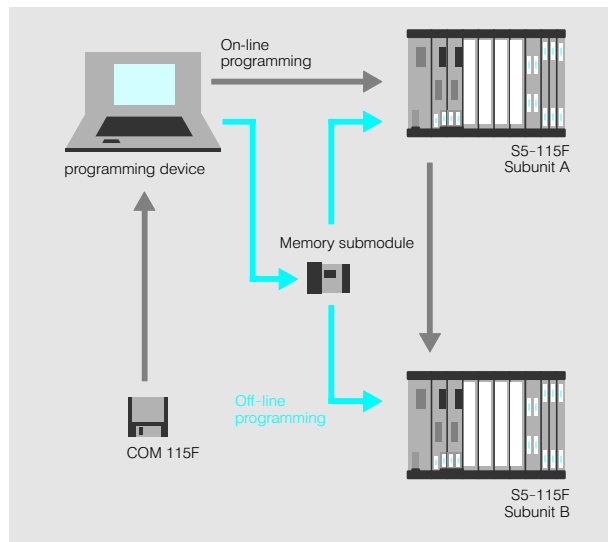

Fig. 3/21 On-line and off-line programming

Parameter assignment

The COM 115F parameterization software supports the user in parameter assignment and error diagnostics:

- Parameter assignment of safety-specific data in interactive mode
- Generation of the parameterization data block from the parameter assignment data

- System diagnostics via error data block and interrupt register
- Documentation of safety-specific data via printer
- General system handling, e.g. loading of block or reading of data
- Failsafe communication via SINEC L1 LAN

S5-115F (continued)**Communication**
Point-to-point link

A point-to-point link with the S5-115F programmable controller is made possible using the CP 523 communications processor. It is primarily used for

- Connection of printers, VDUs, keyboards, etc.
- Data exchange with other SIMATIC-S5 units
- Failsafe data exchange with the S5-115F
- Data exchange with any unit with a 20 mA (TTY) interface

For further details of the CP 523 communications processor see Section 4.

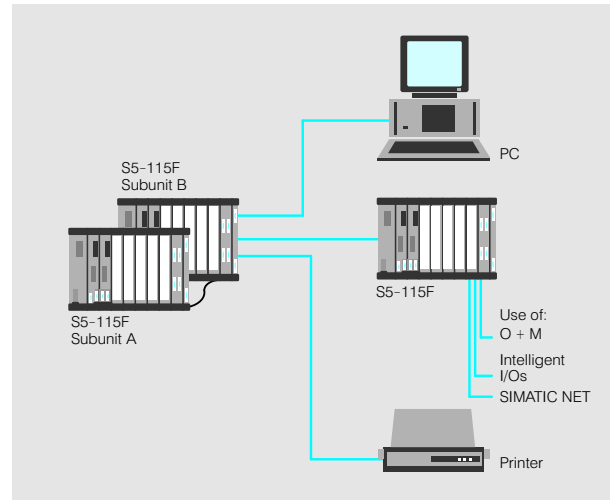

Fig. 3/22 Point-to-point link of the S5-115F with a CP 523 or via a programming device interface

SINEC L1 local area network

The moderately priced SINEC L1 local area network, which is designed for extensive communications networks, enables up to 30 S5-115F and S5-95F programmable controllers to communicate with each other. The PLCs are connected to the LAN via the CPU of one of the two subunits.

Features

- S5-115U, S5-135U or S5-155U programmable controllers with CP 530 communications processors or other devices with SINEC L1 master capability (e.g. PCs) can be used as active nodes (masters)
- The S5-115F and S5-95F programmable controllers can be operated and interrogated from the master
- SINEC L1 operation is reaction-free, i.e. faults of the individual nodes that might have occurred are not transferred
- Intelligent I/O modules and communications processors can be used in the master units

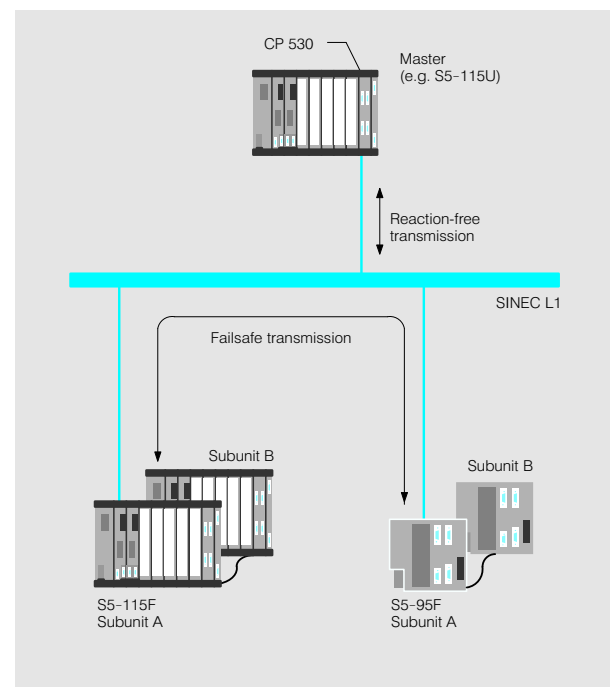

Fig. 3/23 Single-channel, safety-oriented link

The S5-115F failsafe programmable controllers can use these modules via the SINEC L1 LAN

- A failsafe link with the S5-95F programmable controller is also possible

SIMATIC S5-115U/H/F

General

S5-115F (continued)

Communication

(continued)
SINEC L1 local area network
(continued)

3

Possible configurations

Single-channel, non-safety-related link

The non-safety-related link is used for communication between programmable controllers of the U range (as master or slave) and failsafe S5-115F or S5-95F programmable controllers (as slaves).

Single-channel, safety-related link

The safety-related link can be established only with a programmable controller of the U range as master.

Safety-related links can only be established with S5-115F or S5-95F programmable controllers. The S5-115F failsafe programmable controllers are connected to the LAN via one of the two subunits. Data exchange is carried out by means of special protocols which are in accordance with the safety requirements. The connection to the master is not safety-related but only reaction-free.

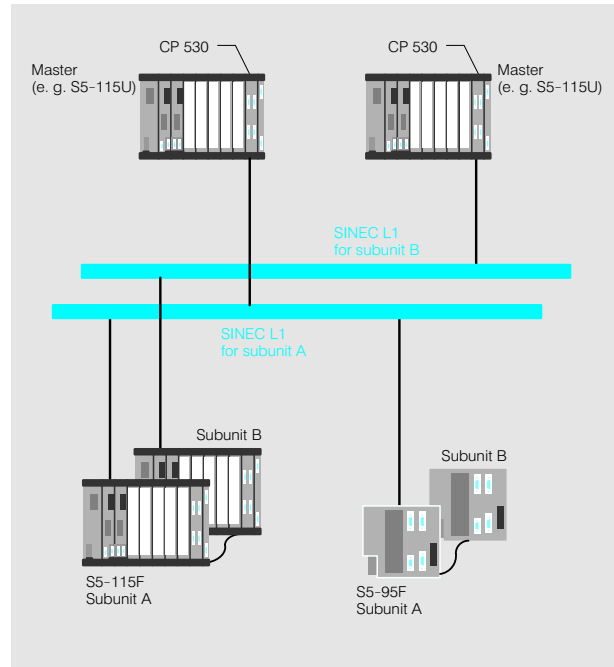

Fig. 3/24 Two-channel, safety-related link

Two-channel safety-related link

Data exchange is carried out in the same way as with the single-channel, safety-related link. The difference is that each subunit is connected to its own local area network. Both local area networks operate independently; merely the contents of

the send and receive buffers of the two subunits are cyclically compared with each other. Failure of one LAN (e.g. through line interruption) does not interrupt data exchange, as there remains a single-channel, safety-related link via the other still functioning LAN.

PROFIBUS local area network

With the CP 541 communications processor (see Section 2) the S5-115F programmable controller can be connected to the PROFIBUS LAN. Thus, communication with the whole range of SIMATIC programmable controllers is possible.

Like in the case of the SINEC L1, data transmission takes place reaction-free and the same types of link

- Single-channel, non-safety-related link
- Single-channel, safety-related link and
- Two-channel, safety-related link can be realized.

Operator-control and process monitoring

For the S5-115F programmable controller devices for operator control and process monitoring can be used, if they are connected via the CP 523 communications processor. It is also possible to connect the programming device terminal of the S5-115F in series with another SIMATIC S5 programmable controller of the U range, e.g. via the second programming-device terminal of a S5-115U.

The S5-115F programmable controller can be linked to devices for operator control and process monitoring via the SINEC L1 LAN.

A direct connection of TDs/OPs to the programming device interface of the S5-115F is not possible.

For further information on operator control and process monitoring systems, see Section 10 and Catalogs ST 80.

S5-115F (continued)**Subracks for the S5-115F****Subracks for central controllers:**

- CR 700-0LB
- CR 700-2F

The components to be used with the S5-115F subracks partly differ from those of the S5-115U subracks (see Section 11). Only prototype-tested modules may be installed into the S5-115F failsafe programmable controller.

Subracks for centralized expansion:

- ER 701-1
- ER 701-2 and ER 701-3, each without power supply

Subracks for distributed expansion:

- ER 701-2
- ER 701-3

Interfaces modules for the S5-115F

In the S5-115F failsafe programmable controller, interface modules are used for

connecting expansion units in centralized and distributed configurations, for switched

configurations and for linking the central controllers.

Configuration for	Interface module required in	
	Central controller	Expansion unit
Centralized expansion	IM 306	IM 306 in ER 701-1/2/3
Distributed expansion	IM 304	IM 314 in ER 701-2/3

CPU for the S5-115F

A CPU 942F is required in both subunits of the S5-115F failsafe programmable controller.

I/O modules for the S5-115F

The operating system of the S5-115F supports the use of

- Digital input modules
 - 6ES5 430-7LA12
 - 6ES5 434-7LA12
 - 6ES5 435-7LC11
 - 6ES5 436-7LC11
- Digital output modules
 - 6ES5 451-7LA12
 - 6ES5 454-7LA12
 - 6ES5 454-7LB11
 - 6ES5 456-7LB11
 - 6ES5 458-7LA11¹⁾
 - 6ES5 458-7LB11
 - 6ES5 453-4UA12
- Digital input/output modules
 - 6ES5 482-7LA11
 - 6ES5 482-7LF11
 - 6ES5 482-7LF21
 - 6ES5 482-7LF31

- Analog input modules
 - 6ES5 460-7LA13
 - 6ES5 463-4UA12
 - 6ES5 463-4UB12
- Analog output modules
 - 6ES5 470-7LA12
 - 6ES5 470-7LB12
 - 6ES5 470-7LC12

The CP 523 communications processor can also be used for the S5-115F. The CP 523 is used as:

- Fault indication module
- Safe communications module to further S5-115F programmable controllers
- Reaction-free communications module to other systems

Moreover, the communications processors and intelligent I/O modules in a programmable controller of the U range can exchange data with the S5-115F programmable controller via the SINEC L1 or PROFIBUS LAN. Nevertheless, they cannot be plugged directly into the S5-115F.

Note

When using other modules in the S5-115F, the operating permission expires.

1) For new systems the use of the 6ES5 453-4UA12 module is suggested.

SIMATIC S5-115U/H/F

Central processing units

CPU 941, CPU 942, CPU 943 and CPU 944 central processing units for the S5-115U

Application



3

The selection of the CPU to be used depends on the technical requirements of the automation task, especially with regard to processing times, memory capacities and functions. These criteria are the most important distinctive features of the CPUs.

The CPU 941, CPU 942, CPU 943 and CPU 944 can be programmed in the STEP 5 programming language. For programming under GRAPH 5 the standard function block of the same name is required.

Design

The CPU 941 to CPU 944 central processing units contain:

- STEP 5 processor for processing the user program
- Internal program memory (RAM)
- Integral hardware clock (in CPUs with 2 interfaces)
- Receptacle for 375 memory submodule (RAM/EPROM/EEPROM)
- RUN/STOP switch with corresponding LEDs
- Switch for setting retentiveness of bit memories, timers and counters
- Switch for overall reset (resetting the entire user RAM of the CPU)

- Built-in 20 mA (current loop) interface for connection of a programming device or operator panel or for connection to the SINEC L1 LAN
- CPU 943 and CPU 944 only: Optional 2nd interface for connection of a programming device or operator panel or for connection to the SINEC L1 LAN

Not all programming device functions can be used at the 2nd interface. Transmission without protocol is possible with the ASCII driver. On the CPU 944, the 2nd interface can also be used for links employing the 3964 or 3964R communications protocol (special operating system, to be ordered separately).

RAM submodules extend the internal RAM and are required for this purpose in the CPU 941 and CPU 942. When the RAM submodules are removed from their receptacles in the CPU, the data is erased. The CPU 943 and CPU 944 are already equipped with the necessary amount of RAM.

Programs and data can be stored on 375 memory submodules (EPROM or EEPROM) to protect them from power failures. The memory submodules are programmed on the programming device using the receptacle provided for this purpose and are then plugged into the CPU.

Functions

The functions of the CPU 941, CPU 942, CPU 943 and CPU 944 are as follows:

Program execution

- Cyclic (OB 1): Read-in of input statuses, execution of the control program and output of the output statuses
- Time-controlled (OB 10 to OB 13): Four independent levels for which the time of processing can be individually defined (times from 10 ms to 1 min).

- Interrupt-controlled (OB 2 to OB 5): Activation of four independent execution levels by process interrupts
- Time interrupt-controlled (OB 6): This level is activated after expiry of a programmed time (times from 3 ms to 1 min)

Execution levels of higher priority can interrupt those of lower priority after any STEP 5 operation (order of priority starting with the highest: time interrupt-controlled, interrupt-controlled, time-controlled, cyclic).

Monitoring

The CPUs monitor scan time, battery failure, or acknowledgement delay, for example.

Software protection for RAM operation

The software protection feature prevents inadvertent overwriting or read-out of programs by unauthorized persons.

Scan time measurement

The current, maximum and minimum scan times are measured.

SIMATIC S5-115U/H/F

Central processing units

CPU 941, CPU 942, CPU 943 and CPU 944 central processing units for the S5-115U (continued)

Functions (continued)

Clock

The clock can be set and read. It can also be used for counting operating hours or for interrupt functions.

Integral function blocks

The operating system incorporates a number of function blocks programmed in machine language, which can execute at extremely high speed and do not occupy any space in the internal RAM. These integral function blocks are called in the same way as any other blocks in the user program and can only be interrupted by process interrupts.

- Conversion blocks (BCD code converters)
- Arithmetic blocks (multiplication, division)
- Analog value processing

- Data handling blocks (these enable communications processors and intelligent I/O modules to be used and control the exchange of data with the CPU)
- COMPR function block for compressing the contents of the internal RAM
- DELETE function block (for deleting blocks)

Integral organization blocks

- Scan time triggering
- Variable time loop (range 160 µs to 65 ms)
- PID control algorithm
- Scan cycle-independent read-in of digital inputs and output of the process I/O image

Restart modes

- Manual cold restart using mode selector or programming device
- Cold restart following power failure

COM DB1 parameterization software

The COM DB1 parameterization software enables the user to assign parameters to the CPU quickly and easily and without errors. The software correctly applies all the rules for creating DB1. Any errors in DB1 or input errors are pointed out to the user. Further data blocks rendered necessary by the parameters of DB1 can also be created with COM DB1.

COM DB1 cannot be used for assigning parameters to the second interface of CPU 943 and CPU 944.

For technical specifications, see page 3/25.

3

Ordering data	Order No.		Order No.
CPU 941	6ES5 941-7UB11	3964, 3964R communications protocol	6ES5 816-1BB21
CPU 942	6ES5 942-7UB11	as an extension to the operating system for the CPU 944	
CPU 943	6ES5 943-7UB11	375 memory submodules	
With 1 serial interface	6ES5 943-7UB21	EPROM 8 Kbyte	6ES5 375-1LA15
With 2 serial interfaces	6ES5 943-7UB21	EPROM 16 Kbyte	6ES5 375-1LA21
CPU 944	6ES5 944-7UB11	EPROM 32 Kbyte	6ES5 375-1LA41
With 1 serial interface	6ES5 944-7UB21	EPROM 64 Kbyte ^{1), 2), 5)}	6ES5 375-1LA61
With 2 serial interfaces		EPROM 128 Kbyte ^{1), 2), 3), 5)}	6ES5 375-1LA71
To be ordered as a separate item:		EEPROM 8 Kbyte	6ES5 375-0LC31
S5-115U manual		EEPROM 16 Kbyte	6ES5 375-0LC41
(CPU 941 to CPU 944)		RAM 8 Kbyte ^{3), 4)}	6ES5 375-0LD11
with operating instructions for power supply modules, CPUs, digital and analog input/output modules, EU interface modules and programming instructions		RAM 16 Kbyte ^{3), 4)}	6ES5 375-0LD21
German	6ES5 998-0UF13	RAM 32 Kbyte ^{1), 3), 4)}	6ES5 375-0LD31
English	6ES5 998-0UF23	Standard function blocks	see Section 7
French	6ES5 998-0UF33	GRAPH 5/II, S5-115U closed-loop control	
Spanish	6ES5 998-0UF43	Programming software	see Section 7
Italian	6ES5 998-0UF53	GRAPH 5/II	
S5-115U quick reference guide		COM DB1 parameter assignment software	see Section 7
for CPU 941 to CPU 944		COM REG S5-115U parameter assignment software	see Section 7
German	6ES5 997-7LA11		
English	6ES5 997-7LA21		
French	6ES5 997-7LA31		
Spanish	6ES5 997-7LA41		
Italian	6ES5 997-7LA51		

1) Not suitable for CPU 941

2) Not suitable for CPU 942

3) Not suitable for CPU 943

4) Not suitable for CPU 944

5) Not suitable for CPU 942F

SIMATIC S5-115U/H/F

Central processing units

CPU 945 central processing unit for the S5-115U

Application



The CPU 945 is a new addition at the high end of the spectrum (CPU 941 to CPU 944). It is particularly suitable for fast, highly complex and calculation-intensive automation applications. Tasks are shared between several internal processors, enabling control tasks and communications tasks to be executed at the same time.

Interrupt response times are extremely short. In addition to STEP 5, the high-level language SCL can also be used for programming the CPU 945 (see Section 7). Even lengthy, complicated programs can therefore be written and edited clearly and easily.

Design

In addition to the points listed under CPU 941 to CPU 944, the module contains:

- STEP 5 processor with floating-point coprocessor
- Bus controller for autonomous handling of communications via the S5 internal backplane bus

- Microcontroller for interface communications
- Integral hardware clock
- Receptacle for memory card
- Slot for one of the following interface modules:
 - programming device interface module, V.24 module, 20 mA (current loop) module, RS 422-A/RS 485 module, SINEC L1 module

Memory cards based on flash EPROMs (electrically erasable) are used in place of memory submodules.

Instead of a fixed second interface, a slot is provided for a replaceable interface module with a selection of different types.

Functions

The CPU 945 has the same basic function scope as the CPU 941 to CPU 944 with the following exceptions:

Program execution

The call interval for time-controlled program execution can be set between 1 ms and 1 min.

Monitoring

A monitoring facility for collision of two timed interrupts is also installed.

Process I/O image transfer

- DELTA transfer (parameter-selectable): When transferring the process output image, only the data which has changed since the last cycle is transferred
- Parallel process I/O image transfer (parameter-selectable): the process I/O image is updated parallel to cyclic program execution

Changing the operating system

The operating system of the CPU can be reloaded with the

programming device, either via the PROFIBUS, the Industrial Ethernet or using Teleservice.

Integral function blocks

There is an PID control algorithm integrated in the operating system. Additional standard function blocks are available (see Section 7).

The CPU 945 can also process function and data extension blocks (FX and DX).

For technical specifications, see page 3/25.

Ordering data		Order No.	Order No.
CPU 945 With 256 Kbyte RAM With 384 Kbyte RAM		6ES5 945-7UA13 6ES5 945-7UA23	
S5-115U quick reference guide for CPU 945 German English French		6ES5 997-7LB11 6ES5 997-7LB21 6ES5 997-7LB31	
Memory card for CPU 945 128 Kbyte flash EPROM 256 Kbyte flash EPROM 512 Kbyte flash EPROM		6ES5 374-1KG11 6ES5 374-1KH21 6ES5 374-1KJ11	
		Interface modules 20 mA module V.24 module RS 422-A/RS 485 module programming device module SINEC L1 module	6ES5 752-0LA12 6ES5 752-0LA22 6ES5 752-0LA42 6ES5 752-0LA52 6ES5 752-0LA62 6ES5 985-2MC11
		Programming adapter for memory cards (for programmers without integral adapter only)	
		Parameter assignment software To be ordered as a separate item: Manual for the S5-115U with CPU 945 German English French Italian	see Section 7
			6ES5 998-3UF11 6ES5 998-3UF21 6ES5 998-3UF31 6ES5 998-3UF51

SIMATIC S5-115U/H/F

Central processing units

CPU 941, CPU 942, CPU 943, CPU 944 and CPU 945 central processing units for the S5-115U

Technical specifications						
CPU		CPU 945	CPU 944	CPU 943	CPU 942	CPU 941
Memory capacity						
• Total	max.	256/384 Kbyte	96 Kbyte	48 Kbyte	42 Kbyte	18 Kbyte
• Internal RAM		256/384 Kbyte	96 Kbyte	48 Kbyte	10 Kbyte	2 Kbyte
• Submodule/memory card RAM/EPROM/EEPROM	max.	—	—/128 ¹⁾ /16Kbyte	—/64 ¹⁾ /16 Kbyte	32/32/16 Kbyte	16/16/16 Kbyte
Flash EPROM	max.	256/512 ¹⁾ Kbyte	—	—	—	—
Memory extension with CP 516/CP 581		8/120 Mbyte	8/120 Mbyte	8/120 Mbyte	8/120 Mbyte	8/120 Mbyte
Programming language		STEP, SCL	STEP 5	STEP 5	STEP 5	STEP 5
Types of blocks		Organization blocks (OB), programming blocks (PB), function blocks (FB), sequence blocks (SB), data blocks (DB) FX, DX				
Number of blocks	max.	256 per block type				
Block nesting depth	max.	50	32	32	32	32
Program execution		Interruption possible after any STEP 5 operation				
• Cyclic		Yes				
• Time-controlled		4 execution levels OB 10 to OB 13				
Call interval		1 ms to 1 min		10 ms to 10 min		
• Interrupt-controlled		4 execution levels OB 2 to OB 5				
• Time interrupt-controlled		1 execution level OB 6				
Monitoring functions		Coll. 2 timed interr.	—	—	—	—
		Timeout, I/O error, acknowledgement delay, substitution error in FB/FX, transfer error in DB/DX, battery failure				
Execution time for						
• Bit operations		0.1 µs	0.8 µs	0.8 µs	1.6 µs	1.6 µs
• Load and transfer (data)		0.2 µs	1.5 µs	1.5 µs	3.0 µs	3.0 µs
• Timer/counter operations		0.1 µs	1.8 µs	1.8 µs	3.7 µs	3.7 µs
• Data word comparison		0.1 µs	0.8 µs	0.8 µs	1.6 µs	1.6 µs
• Substitution operations		0.5 µs	3.6 µs	160 µs	160 µs	160 µs
• Block call operations		0.1/1.0 µs	0.8/3.6 µs	0.8/3.6 µs	1.6/6.7 µs	1.6/6.7 µs
Fixed point arithmetic						
• Addition, subtraction		0.1 µs	0.8 µs	0.8 µs	1.6 µs	1.6 µs
• Multiplication		0.35 µs	2)	2)	2)	2)
• Division		0.4 µs	2)	2)	2)	2)
Floating-point arithmetic						
• Addition, subtraction, multiplication		0.75 µs	2)	2)	2)	2)
• Division		1.35 µs	2)	2)	2)	2)
Interrupt response time	typ.	50 µs	2 ms	2 ms	2 ms	2 ms
Principle supplementary functions						
• Software protection, scan time measurement		Yes				
• Scan time monitoring		Selectable as required				
• Real-time clock		Integral	Optional ³⁾	Optional ³⁾	—	—
• PID control algorithm		—	Integral	Integral	Integral	Integral
Flags/S flags		2048/32768	2048/-	2048/-	2048/-	2048/-
		All, half or none of which retentive, as required				
Nesting levels		6 (for binary logic operations)				
Timers						
• Number		256	128	128	128	128
• Range		0.01 to 9990 s, all, 64 or none of which retentive, as required				
Counters						
• Number		256	128	128	128	128
• Range		0 to 999 (up/down), all, 64 or none of which retentive, as required				
Digital inputs/outputs		4096/4096	4096/4096	4096/4096	4096/4096	4096/4096
• No. with process I/O image		1024 each	1024 each	1024 each	1024 each	512 each
Analog inputs/outputs		256/256	256/256	256/256	256/256	256/256

1) Physical capacity, not all available for use

2) With integral standard function blocks

3) Version with second interface

SIMATIC S5-115U/H/F

Central processing units

CPU 941, CPU 942, CPU 943, CPU 944 and CPU 945 central processing units for the S5-115U (continued)

Technical specifications (continued)						
CPU		CPU 945	CPU 944	CPU 943	CPU 942	CPU 941
Interfaces						
1st interface (built-in)		PG/OP/SINEC L1	PG/OP/SINEC L1	PG/OP/SINEC L1	PG/OP/SINEC L1	PG/OP/SINEC L1
2nd interface, optional (CPU 945: replaceable interface module, CPU 943/CPU 944: with two interfaces)		PG/OP/3964/3964R, SINEC L1, ASCII driver	PG/OP/3964/3964R, SINEC L1, ASCII driver	PG/OP, SINEC L1 ASCII driver	—	—
Current consumption (5 V; with memory submodule)						
• With 1 interface (serial)	max.	0.55 A	—	—	0.16 A	0.16 A
• With 2 interfaces (serial)	max.	0.64 to 1.25 A ⁴⁾	0.45 A	0.45 A	—	—
Weight						
• Module	approx.	0.8 kg (1.7 lb)	1.5 kg (3.3 lb)	1.5 kg (3.3 lb)	1.5 kg (3.3 lb)	1.5 kg (3.3 lb)
• Memory submodule	approx.	0.1 kg (0.2 lb)	0.1 kg (0.2 lb)	0.1 kg (0.2 lb)	0.1 kg (0.2 lb)	0.1 kg (0.2 lb)

4) Depending on the interface module

SIMATIC S5-115U/H/F

Central processing units

CPU 942H central processing unit for the S5-115H

Application



The CPU 942H is required for the setup of a S5-115H fault-tolerant programmable controller.

3

Principle of operation

The CPU 942H central processing unit contains a firmware which is able to carry out all additional functions of the S5-115H fault-tolerant

programmable controller autonomously. Part of that are the following functions:

- Data interchange
- Synchronization of both subunits

- Self-test
- Fault handling (switchover to standby unit)
- Fault locating

Technical specifications

Memory capacity				Counters			
• Internal RAM			5 Kbyte	• Number			128
• Submodule	RAM	max.	32 Kbyte	• Range			0 ... 999 (up, down)
	EPROM	max.	32 Kbyte	Digital inputs	max.		1024
	EEPROM	max.	16 Kbyte	Digital outputs	max.		1024
			(1 statement normally requires 2 byte in the program memory)	Analog inputs	max.		64
Execution time for 1000 binary statements		approx.	1.6 ms	Analog outputs	max.		64
Execution time for 1000 statements		approx.	15 ms (for 65 % binary and 35 % word operations)	Programming			Structured
Execution time for load and transfer operations to peripheral word			430 to 1700 μ s	Organization blocks	max.		256
Execution time for block call			66 to 1100 μ	Program blocks	max.		256
Basic cycle time (without user program)		typ.	50 ms	Function blocks	max.		256 (configurable)
Interrupt detection time		approx.	2 ms	Sequence blocks	max.		256
Interrupt response time		max.	30 ms	Data blocks	max.		254
Scan time monitoring			Configurable	Nesting depth	max.		32
Bit memories			2032	Program execution			Cyclic, interrupt-driven, time-controlled
Timers				Nesting levels	max.		6 (for binary logic operations)
• Number			128	PID control algorithm			
• Range			0.01 to 9990 s	• Processing time	approx.		1.7 ms
				Closed-loop control			
				• Scan time			0.1 to 12.8 s
				• Individual controllers	max.		8
							(for further details please see Section 7)
				Current consumption (at 5 V) (with memory submodule)	max.		0.7 A
				Power loss	max.		3.5 W
				Weight			
				• Module	approx.		1.5 kg (3.3 lb)
				• Memory submodule	approx.		0.1 kg (0.2 lb)

Ordering data

	Order No.		Order No.
CPU 942H	6ES5 942-7UH11	375 memory submodule (EPROM, max. 32 Kbyte)	see page 3/23
for the S5-115H programmable controller, with receptacle for 375 memory submodule, connection for programmer or SINEC-L1 LAN and standard function blocks using communications processors		COM 115H parameterization software	see Section 7
		Manual	
		German	6ES5 998-0UH11
		English	6ES5 998-0UH21
		French	6ES5 998-0UH31
		Spanish	6ES5 998-0UH41
		Italian	6ES5 998-0UH51

SIMATIC S5-115U/H/F

Central processing units

CPU 942F central processing unit for the S5-115F

Application



The CPU 942F is designed for the setup of a S5-115F failsafe programmable controller.

3

Principle of operation

The CPU 942F contains a firmware which is able to carry out all additional functions of the S5-115F fail-safe programmable controller autonomously.

Part of that are functions like:

- Data interchange
- Synchronization of both subunits
- Self-test
- Fault handling

Technical specifications

Memory capacity				Counters			
• Internal RAM			5 Kbyte	• Number			128
• Submodule	RAM	max.	32 Kbyte	• Range			0 ... 999 (up, down)
	EPROM	max.	32 Kbyte	Digital inputs	max.		1024
	EEPROM	max.	16 Kbyte	Digital outputs	max.		1008
			(1 statement normally requires 2 byte in the program memory)	Analog inputs	max.		64
				Analog output	max.		64
Execution time for 1000 binary statements		approx.	1.6 ms	Programming			Structured
Execution time for 1000 statements		approx.	15 ms (for 64 % binary and 35 % word operations)	Organization blocks	max.		6
Execution time for load and transfer operations to peripheral word			430 to 1700 μ	Program blocks	max.		256
Execution time for block call			66 to 1100 μ	Function blocks	max.		256 (configurable)
Basic cycle time (without user program)			60 to 140 ms (depending on the number of redundant I/O modules)	Sequence blocks	max.		256
Interrupt detection time	approx.		2 ms	Data blocks	max.		254
Interrupt response time	max.		30 ms	Nesting depth	max.		16
Scan time monitoring			Configurable	Program execution			Cyclic, interrupt-driven, time-controlled
Bit memories			2032	Nesting levels	max.		6 (for binary logic operations)
Timers				PID control algorithm			
• Number			128	• Processing time	approx.		1.7 ms
• Range			0.01 to 9990 s	S5-115U closed loop control			
				• Scan time			0.1 to 12.8 s
				• Individual controller	max.		8 (for further details please see Section 7)
				Current consumption (at 5 V) (with memory submodule)	max.		0.7 A
				Power loss	max.		3.5 W
				Weight			
				• Module	approx.		1.5 kg (3.3 lb)
				• Memory submodule	approx.		0.1 kg (0.2 lb)

Ordering data

	Order No.		Order No.
CPU 942F with receptacle for 375 memory submodule and connection for programming device or SINEC-L1 LAN	6ES5 942-7UF15	COM 115F parameterization software S5-115F manual German English French Italian	see Section 7 6ES5 998-1UF15 6ES5 998-1UF25 6ES5 998-1UF35 6ES5 998-1UF55
375 memory submodule (EPROM, max. 32 Kbyte)	see page 3/23		

SIMATIC S5-115U/H/F

Digital input/output modules

Overview

Digital input and output modules

Input modules			Output modules		
Voltage values	Module ID	Page	Voltage values	Module ID	Page
5... 15 V DC (NAMUR)	434-4	3/30	Transistor outputs		
24 V DC	420-7 430-7 434-7	3/30	5/24 V DC; 0.1 A	457-7	3/35
24/48 V UC	431-7	3/30	24 V DC; 0.5 A	441-7 451-7LA1 451-7LA2	3/35
48/60 V UC	432-7	3/30	24 V DC; 2 A	453-4UA12 454-7LA 454-7LB	3/35
115 V UC	435-7LA 435-7LB 435-7LC	3/30	24/48/60 V DC; 0.5 A	453-7	3/35
230 V UC	436-7LA 436-7LB 436-7LC	3/30	48/115 V AC; 1 A	455-7	3/35
			115/230 V AC; 1 A	456-7LA	3/35
			115/230 V AC; 1.5 A	456-7LB	3/35
			Relay outputs		
			30 V UC; 0.5 A	458-7LA	3/35
			250 V AC; 5 A	458-7LB	3/35
			250 V AC; 5 A	458-7LC	3/35
			24 V DC; 5 A		
			Input/output modules		
			Voltage values	Module ID	Page
			24 V DC (inputs)	482-7LA/-7LF11	3/41
			24 V DC; 0.5 A (outputs)	/-7LF21	
			24 V DC (inputs)	482-7LF31	3/41
			24 V DC; 2.5 A (outputs)		
			24 V DC (inputs)	485-7	3/41
			24 V DC; 1.5 A (outputs)		

SIMATIC S5-115U/H/F

Digital input/output modules

Digital input modules

Application



The digital input modules convert the external binary signals from the process to the internal signal level of the programmable controllers.

3

Design

Digital input modules are available with 8, 16 or 32 inputs and for a range of input voltages. The modules require 1/2 or 1 slot (depending on the subrack).

The modules comprise:

- Green LEDs for indicating signal status
- Enable input F (434-4 digital input module for NAMUR sensors only) for disabling input signals

- Relay contact (MELD) and 24 V input (RESET) for interrupt processing

The signal leads must be connected with front connectors. They can be labelled in the fields next to the LEDs.

Principle of operation

Enable input

Digital input 434-4 only:
The input signals can be disabled by means of enable input F. This enable input can be deactivated by removing a jumper on the module.

Interrupt processing

Digital input 434-7 only:
A group signal generates an interrupt in the CPU when a particular input signal changes. The group signal drives a latching relay on the module (the relay contact MELD is accessible from the front panel), which can be reset via a 24 V input (RESET).

In the user program the user can specify for each input whether the interrupt is to be set by the positive- or negative-going edge.

If interrupt processing is not essential, the 434-7 module can be used in any type of subrack. Interrupt evaluation by the 434-7 digital input module is only possible in a central controller. The module takes up two bytes for input addresses and two bytes for output addresses.

Interrupt evaluation is only possible in an expansion unit (ER 701-3 subrack) which is connected using the IM 307 and IM 317 interface modules and if the 432-4 digital input module (S5-135/-155U) is used in the expansion unit instead of the 434-7 digital input module generating the interrupt.

Note

All digital input modules of the S5-135U/-155U programmable controllers (see Section 4) can be used in the S5-115U with adapter casings.

The 434-4 digital input module requires an adapter casing (see page 3/98).

Technical specifications

Digital input module	6ES5 420-7LA11	6ES5 430-7LA12	6ES5 431-7LA11	6ES5 432-7LA11	6ES5 434-7LA12	6ES5 434-4UA12
Number of inputs	32	32	16	16	8 (with group signal)	see page 4/36 (S5-135U, S5-155U/H)
Galvanic isolation	No	Yes (optocoupler)	Yes (optocoupler)	Yes (optocoupler)	Yes (optocoupler)	
• In groups of	—	8	4	4	1	
Input voltage	24 V DC	24 V DC	24/48 V UC	48/60 V UC	24 V DC	
• Rated value	—	—	47 ... 63 Hz	47 ... 63 Hz	—	
• Frequency with AC	—	—	0 ... 5 V	0 ... 10 V	—	
• For "0" signal	- 30 ... + 5 V	- 30 ... + 5 V	13 ... 60 V	30 ... 72 V	- 30 ... + 5 V	
• For "1" signal	+ 13 ... + 30 V	+ 13 ... + 30 V	8.5/10.5 mA	9/10 mA	+ 13 ... + 30 V	
Input current for "1" signal typ.	8.5 mA	8.5 mA			8.5 mA	
Delay						
• At "0" → "1"	1.4 ... 5 ms	2.2 ... 4.6 ms	2 ... 13 ms	2 ... 13 ms	0.5 ... 1.5 ms	
• At "1" → "0"	1.4 ... 5 ms	4.5 ... 12 ms	10 ... 25 ms	10 ... 25 ms	0.5 ... 1.5 ms	
Load factor ¹⁾ at 55 °C	100 %	100 %	100 %	100 %	100 %	

1) With respect to number of inputs in a group

SIMATIC S5-115U/H/F

Digital input/output modules

Digital input modules (continued)

Technical specifications (continued)						
Digital input module (cont.)	6ES5 420-7LA11	6ES5 430-7LA12	6ES5 431-7LA11	6ES5 432-7LA11	6ES5 432-7LA12	6ES5 434-4UA12
Cable length						see page 4/36
• Unshielded	max. 600 m (1968 ft)	600 m (1968 ft)	600 m (1968 ft)	600 m (1968 ft)	600 m (1968 ft)	(S5-135U,
• Shielded	max. 1000 m (3280 ft)	1000 m (3280 ft)	1000 m (3280 ft)	1000 m (3280 ft)	1000 m (3280 ft)	S5-155U/H)
Interrupt output	—	—	—	—	—	Latching relay contact
• Permissible load	max. —	—	—	—	—	100 V DC; 0.2 A
• Switching capacity	max. —	—	—	—	—	20 W; 35 VA
Reset input	—	—	—	—	—	24 V DC
Insulation voltage rating (external connections to housing, internal connections, other groups)						
• In acc. with VDE 0160	—	30 V DC	60 V AC	60 V AC	30 V DC	
• Tested with	—	500 V AC	500 V AC	500 V AC	500 V AC	
Current consumption						
• Internal (from power supply module; 5 V)	max. 5 mA	5 mA	5 mA	5 mA	70 mA	
Power loss (rated operation)	typ. 6.5 W	6.5 W	9.0 W	10.0 W	2 W	
Front connector	46-pin	46-pin	24-pin	24-pin	46-pin	
Weight	approx. 0.7 kg (1.5 lb)	0.7 kg (1.5 lb)	0.7 kg (1.5 lb)	0.7 kg (1.5 lb)	0.7 kg (1.5 lb)	
Digital input module	6ES5 435-7LA11	6ES5 435-7LB11	6ES5 435-7LC11	6ES5 436-7LA11	6ES5 436-7LB11	6ES5 436-7LC11
Number of inputs	16	16	8	16	16	8
Galvanic isolation	Yes (optocoupler)	Yes (optocoupler)	Yes (optocoupler)	Yes (optocoupler)	Yes (optocoupler)	Yes (optocoupler)
• in groups of	4	2	1	4	2	1
Input voltage						
• Rated value	115 V UC	115 V UC	115 V UC	230 V UC	230 V UC	230 V UC
• Frequency with AC	47 ... 63 Hz	47 ... 63 Hz	47 ... 63 Hz	47 ... 63 Hz	47 ... 63 Hz	47 ... 63 Hz
• For "0" signal	0 ... 40 V	0 ... 40 V	0 ... 40 V	0 ... 70 V	0 ... 70 V	0 ... 100 V
• For "1" signal	85 ... 135 V	85 ... 135 V	85 ... 135 V	170 ... 264 V	170 ... 264 V	170 ... 264 V
Input current at "1" signal	typ. 6 mA DC	6 mA DC	6 mA DC	2.2 mA DC	2.2 mA DC	2.2 mA DC
Delay						
• At "0" → "1"	2 ... 13 ms	2 ... 13 ms	2 ... 13 ms	2 ... 13 ms	2 ... 13 ms	2 ... 13 ms
• At "1" → "0"	10 ... 25 ms	10 ... 25 ms	10 ... 25 ms	10 ... 35 ms	10 ... 35 ms	10 ... 25 ms
Load factor 1)						
• At 55 °C	75 %	75 %	75 %	75 %	75 %	100 %
• At 20 °C	100 %	100 %	100 %	100 %	100 %	100 %
Cable length						
• Unshielded	max. 600 m (1968 ft)	600 m (1968 ft)	600 m (1968 ft)	600 m (1968 ft)	600 m (1968 ft)	600 m (1968 ft)
• Shielded	max. 1000 m (3280 ft)	1000 m (3280 ft)	1000 m (3280 ft)	1000 m (3280 ft)	1000 m (3280 ft)	1000 m (3280 ft)
Insulation voltage rating (external connections to housing, internal connections, other groups)						
• In acc. with VDE 0160	250 V AC	250 V AC	250 V AC	250 V AC	250 V AC	250 V AC
• Tested with	1500 V AC	1500 V AC	2700 V AC	1500 V AC	1500 V AC	2700 V AC
Current consumption						
• Internal (from power supply module; 5 V)	max. 5 mA	5 mA	5 mA	5 mA	5 mA	5 mA
Power loss (rated operation)	typ. 11.0 W	11.0 W	5.5 W	11.0 W	11.0 W	5.5 W
Front connector	24-pin	24-pin	24-pin	24-pin	24-pin	24-pin
Weight	approx. 0.7 kg (1.5 lb)	0.7 kg (1.5 lb)	0.7 kg (1.5 lb)	0.7 kg (1.5 lb)	0.7 kg (1.5 lb)	0.7 kg (1.5 lb)

1) With respect to number of inputs in a group

SIMATIC S5-115U/H/F

Digital input/output modules

Digital input modules (continued)

3

Ordering data	Order No.		Order No.
<p>Non-floating: 420-7 digital input module for S5-115U/H 32 inputs, 24 V DC</p>	6ES5 420-7LA11	<p>436-7 digital input module for S5-115U/H 16 inputs, 230 V UC, in groups of 4 in groups of 2</p> <p>for S5-115U/H/F 8 inputs, 230 V UC, in groups of 1</p> <p>The operating instructions are included in the S5-115U manual (see page 3/23).</p> <p>490 front connector For screw terminals</p> <ul style="list-style-type: none"> • 24-pin • 46-pin <p>For crimp terminals, 46-pin</p> <ul style="list-style-type: none"> • With 59 crimp contacts • Without crimp contacts <p>For snap-on clip terminals, 46-pin</p> <p>497 front connector for 434-4 digital input module</p> <ul style="list-style-type: none"> • Crimp terminals, single-width, 42-pin • Screw terminals, single-width, 42-pin <p>Adapter casing</p>	<p>6ES5 436-7LA11 6ES5 436-7LB11</p>
<p>Floating: 430-7 digital input module for S5-115U/H/F 32 inputs, 24 V DC, in groups of 8</p>	6ES5 430-7LA12		6ES5 436-7LC11
<p>431-7 digital input module for S5-115U/H 16 inputs, 24/48 V UC, in groups of 4</p>	6ES5 431-7LA11		
<p>432-7 digital input module for S5-115U/H 16 inputs, 48/60 V UC, in groups of 4</p>	6ES5 432-7LA11		<p>6ES5 490-7LB11 6ES5 490-7LB21</p>
<p>434-4 digital input module for NAMUR¹⁾ sensor for S5-115U/H 32 inputs, 5/15 V DC (TTL, CMOS, NAMUR)</p>	6ES5 434-4UA12		<p>6ES5 490-7LA11 6ES5 490-7LA21 6ES5 490-7LC11</p>
<p>434-7 digital input module for S5-115U/H/F with interrupt group signal 8 inputs, 24 V DC, in groups of 1</p>	6ES5 434-7LA12		6ES5 497-4UA12
<p>435-7 digital input module for S5-115U/H 16 inputs, 115 V UC, in groups of 4 in groups of 2</p>	<p>6ES5 435-7LA11 6ES5 435-7LB11</p>		6ES5 497-4UB31
<p>for S5-115 U/H/F 8 inputs, 115 V UC, in groups of 1</p>	6ES5 435-7LC11		see page 3/98

1) NAMUR = Working group on standards in the measurement technique and control engineering

Digital input modules (continued)

Connection diagrams

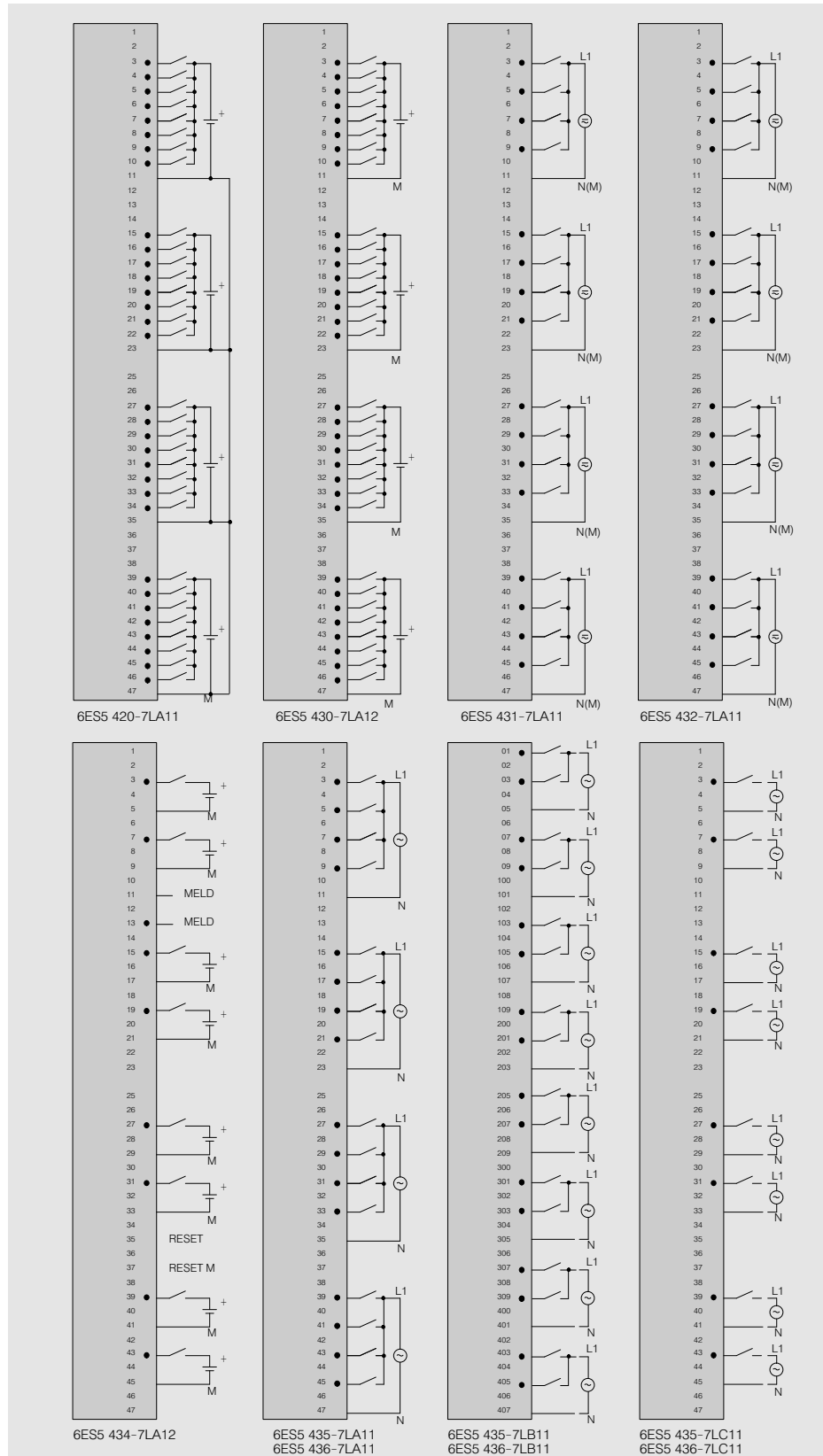

Fig. 3/25 Connection diagrams for digital input modules

SIMATIC S5-115U/H/F

Digital input/output modules

Digital input modules (continued)

Connection diagrams (continued)

3

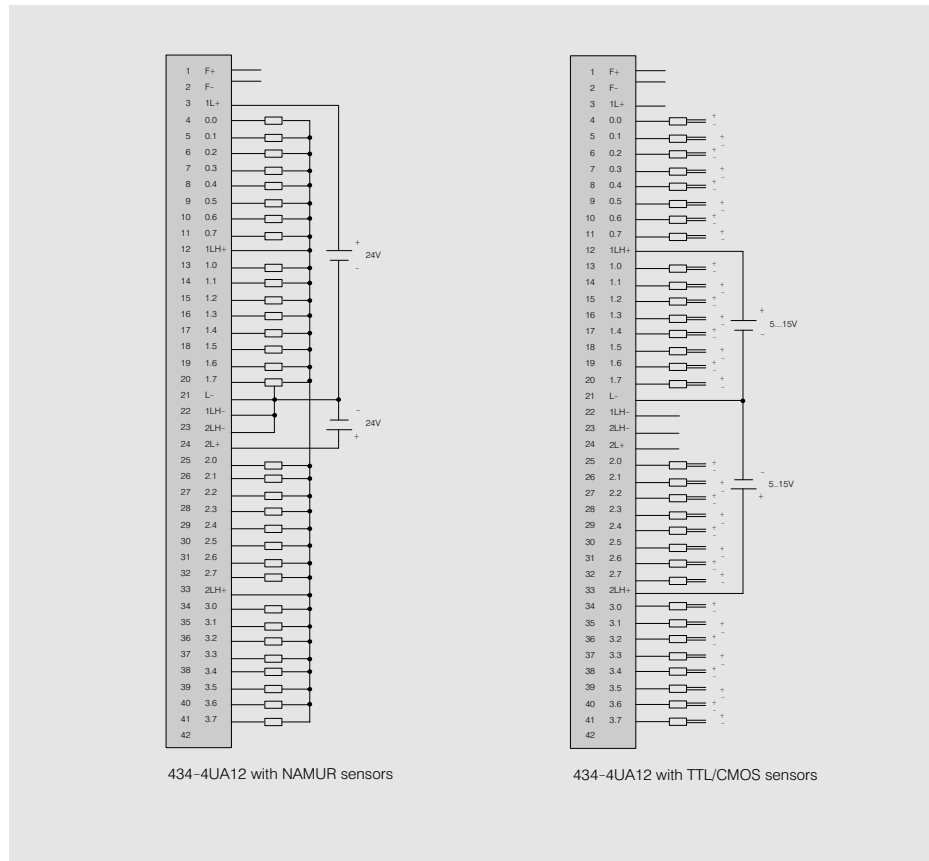

Fig. 3/26 Connection diagrams for digital input modules

SIMATIC S5-115U/H/F

Digital input/output modules

Digital output modules

Application



The digital output modules convert the internal signal levels of the programmable controllers into the binary signal levels required externally by the process.

3

Design

Digital output modules are available with 8, 16 or 32 outputs and for a range of supply voltages (load) and rated load currents. The modules require one slot.

Depending on the version, the modules comprise:

- Green LEDs for indicating signal status
- Short-circuit detection

- Group signalling output for short-circuits (latching relay) with reset input
- Red LEDs for indicating a short-circuit

The signal leads must be connected with front connectors. They can be labelled in the field next to the LEDs.

The module address (byte parameter when programming) is slot-dependent and need therefore not be set on the module.

Principle of operation

The module converts the internal output signals of the programmable controller to the load voltage levels (DC or AC) used to control the process. The output voltage ranges are fixed. A selection of 2 or 3 ranges is available on some modules.

Short-circuit protection

The digital output modules are short-circuit-protected (except for the relay outputs and the DA 457-7 digital output module).

Protection is provided either electronically or by means of fuses. In the DA 451-7 and 453-7 modules, the short-circuit signal is stored via a latching relay contact and indicated by a red LED for each group. In both modules a signal can be reset with a separate 24 V input (RES) or internally by a BASP signal. On the modules protected with fuses, red LEDs also indicate when a fuse has blown.

Parallel connection of outputs

Parallel connection of the outputs is only possible with the relay output modules.

Note

All the digital output modules of the S5-135U/-155U programmable controllers (see Section 4) can be used in the S5-115U with adapter casings.

SIMATIC S5-115U/H/F

Digital input/output modules

Digital output modules (continued)

Technical specifications					
Digital output module	6ES5 441-7LA12	6ES5 451-7LA11	6ES5 451-7LA21	6ES5 453-7LA11	6ES5 453-4UA12
Number of outputs	32	32	32	16	see page 4/40
Galvanic isolation	No	Yes (optocoupler)	Yes (optocoupler)	Yes (optocoupler)	(S5-135U, S5-155U/H)
• In groups of	—	8	8	8	
Supply voltage					
V_{pos} (for load)					
• Rated value	24 V DC	24 V DC	24 V DC	24/48/60 V DC	
• Ripple V_{pp} max.	3.6 V	3.6 V	3.6 V	3.6 V	
• Permissible range (with ripple)	20 ... 30 V	20 ... 30 V	20 ... 30 V	20 ... 75 V	
Value at $t < 0.5$ s max.	35 V	35 V	35 V	87 V	
Output current at "1" signal					
• Rated value	0.5 A	0.5 A	0.5 A	0.5 A	
• Permissible range	5 mA ... 0.5 A	5 mA ... 0.5 A	5 mA ... 0.5 A	5 mA ... 0.5 A	
Lamp load max.	5 W	5 W	5 W	5 W	
Short-circuit protection	Electronic	Electronic	Electronic	Electronic	
Short-circuit display	—	—	1 LED/group with one common group signal	1 LED/group with one common group signal	
Short-circuit group signal output	—	—	Latching relay cont.	Latching relay cont.	
• Permissible load	—	—	100 V DC ; 0.2 mA	100 V DC ; 0.2 mA	
• Switching capacity	—	—	20 W; 35 VA	20 W; 35 VA	
Reset input	—	—	24 V DC	24 V DC	
Inductive surge voltage on circuit interruption (internal) limited to	- 15 V	- 15 V	- 15 V	- 30 V	
Switching frequency					
• Resistive loads max.	100 Hz	100 Hz	100 Hz	100 Hz	
• Lamp loads max.	8 Hz	8 Hz	8 Hz	8 Hz	
• Inductive loads max.	0.5 Hz	0.5 Hz	0.5 Hz	0.5 Hz	
Load factor ¹⁾					
• At 25 °C	100 %	100 %	100 %	100 %	
• At 55 °C	50 %	50 %	50 %	100 %	
Residual current at "0" signal max.	1 mA	1 mA	1 mA	1 mA	
Signal level of the outputs					
• At "0" signal max.	+ 3 V	+ 3 V	+ 3 V	+ 3 V	
• At "1" signal min.	$V_{pos} - 2.5$ V	$V_{pos} - 2.5$ V	$V_{pos} - 2.5$ V	$V_{pos} - 2.5$ V	
Cable length					
• Unshielded max.	600 m (1968 ft)	600 m (1968 ft)	600 m (1968 ft)	600 m (1968 ft)	
• Shielded max.	1000 m (3280 ft)	1000 m (3280 ft)	1000 m (3280 ft)	1000 m (3280 ft)	
Insulation voltage rating (external connections to housing, internal connections, other groups)					
• In acc. with VDE 0160	—	30 V DC	30 V DC	75 V DC	
• Tested with	—	500 V AC	500 V AC	500 V AC	
Current consumption					
• Internal (at 5 V) typ.	10 mA	100 mA	100 mA	50 mA	
• External (at 24 V, no load) typ.	17 mA/group	17 mA/group	17 mA/group	50 mA/group	
Power loss (rated operation) typ.	20 W	20 W	20 W	16 W	
Front connector	46-pin	46-pin	46-pin	24-pin	
Weight approx.	0.7 kg (1.5 lb)	0.7 kg (1.5 lb)	0.7 kg (1.5 lb)	0.7 kg (1.5 lb)	

1) Referred to the sum of the rated currents via an L + supply

SIMATIC S5-115U/H/F

Digital input/output modules

Digital output modules (continued)

Technical specifications						
Digital output module	6ES5 454-7LA12	6ES5 454-7LB11	6ES5 455-7LA11	6ES5 456-7LA11	6ES5 456-7LB11	6ES5 457-7LA11
Number of outputs	16	8	16	16	8	32 (m switch)
Galvanic isolation	Yes (optocoupler)	Yes (optocoupler)	Yes (optocoupler)	Yes (optocoupler)	—	Yes (optocoupler)
• In groups of	4	1	2	4	1	8
Supply voltage						
V_p, V_{pos} (for load)						
• Rated value	24 V DC	24 V DC	48/115 V AC	115/230 V AC	115/230 V AC	5/12/24 V DC
• Frequency	—	—	47 ... 63 Hz	47 ... 63 Hz	47 ... 63 Hz	—
• Ripple V_{pp} max.	3.6 V	3.6 V	—	—	—	2.4 V at 24 V
• Permissible range (with ripple)	20 ... 30 V	20 ... 30 V	40 ... 140V	89 ... 264V	89 ... 264V	4.75 ... 30V
Value at $t < 0.5$ s max.	35 V	35 V	—	—	—	35 V
Output current at "1" signal						
• Rated value	2 A	2 A	2 A/group	1 A	2 A	100 mA
• Permissible range	10 mA ¹⁾ ... 2 A	10 mA ¹⁾ ... 2 A	40 mA ... 2 A	40 mA ... 1 A	40 mA ... 2 A	—
Lamp load max.	10 W	10 W	50/100 W/group	25/50 W	25/50 W	—
Short-circuit protection	Electronic	Fuse (8 · 2.55 A FF)	Fuse (8 · 2.55 A FF)	Fuse (4 · 10 A FF)	Fuse (8 · 6.3 A FF)	None
Short-circuit display	—	8 LEDs	1 LED/group	1 LED/group	8 LEDs	—
Inductive surge voltage on circuit interruption (internal) limited to	- 15 V	- 23 V	—	—	—	- 10 V
Switching frequency						
• Resistive loads max.	100 Hz	100 Hz	10 Hz	10 Hz	10 Hz	10 Hz
• Lamp loads max.	8 Hz	8 Hz	10 Hz	10 Hz	10 Hz	8 Hz
• Inductive loads max.	0.27 Hz	0.27 Hz	10 Hz	10 Hz	10 Hz	2 Hz
Load factor ¹⁾						
• At 25 °C	50 %	100 %	100 %	100 %	100 %	100 %
• At 55 °C	50 %	50 %	100 %	100 %	100 %	100 %
Residual current at "0" signal max.	1 mA	1 mA	1/3 mA	3/5 mA	3/5 mA	100 μ A
Signal level of the outputs						
• At "0" signal max.	+ 3 V	+ 3 V	+ 3 V	+ 3 V	+ 3 V	Open collector output
• At "1" signal min.	$V_{pos} - 3$ V	$V_{pos} - 3$ V	$V_{pos} - 7$ V	$V_{pos} - 7$ V	$V_{pos} - 7$ V	—
Cable length						
• Unshielded max.	600 m (1968 ft)	600 m (1968 ft)	300 m (984 ft)	300 m (984 ft)	300 m (984 ft)	300 m (984 ft)
• Shielded max.	1000 m (3280 ft)	1000 m (3280 ft)	1000 m (3280 ft)	1000 m (3280 ft)	1000 m (3280 ft)	1000 m (3280 ft)
Insulation voltage rating (external connections to the housing, internal connections, other groups)						
• In acc. with VDE 0160	30 V DC	30 V DC	250 V AC	250 V AC	250 V AC	30 V DC
• Tested with	500 V AC	500 V AC	1500 V AC	1500 V AC	2700 V AC	500 V AC
Current consumption						
• Internal (at 5 V) typ.	50 mA	50 mA	175 mA	70 mA	35 mA	100 mA
• External (at 24 V, no load) typ.	8.5 mA/group	—	—	—	—	4 mA
Power loss (rated operation) typ.	20 W	20 W	16 W	16 W	16 W	6 W
Front connector	24-pin	24-pin	24-pin	24-pin	24-pin	46-pin
Weight approx.	1.1 kg (2.4 lb)	0.8 kg (1.8 lb)	1.1 kg (2.4 lb)	1.1 kg (2.4 lb)	1.1 kg (2.4 lb)	0.7 kg (1.5 lb)

1) Referred to the sum of the rated currents via an L + or L1 supply

SIMATIC S5-115U/H/F

Digital input/output modules

Digital output modules (continued)

3

Technical specifications				
Digital output module	6ES5 458-7LA11 ¹⁾	6ES5 458-7LB11	6ES5 458-7LC11	
Number of outputs	16	8	16	
Galvanic isolation	Yes (relay contacts) ⁴⁾	Yes (relay contacts) ³⁾	Yes (relay outputs)	
• In groups of	1	1	4	
Continuous current I_{th}	0.5 A	5 A	5 A	
Switching capacity of the contacts				
• Resistive loads max.	10 W/0.5 A/30 V UC	5 A at 250 V AC 2.5 A at 30 V DC	5 A at 250 V AC 5 A at 30 V DC 0.4 A at 110 V DC	
• Inductive loads max.	Not permitted	1.5 A at 250 V AC 0.5 A at 30 V DC	1.5 A at 250 V AC 1 A at 30 V DC 0.08 A at 110 V DC	
Service life: Switching cycles (VDE 0660, Part 200)	1 · 10 ⁹ (to DC-11)	1.5 · 10 ⁶ (to AC-11) 0.5 · 10 ⁶ (to DC-11)	1.5 · 10 ⁶ (to AC-11) 0.5 · 10 ⁶ (to DC-11)	
Short-circuit protection	None	None	None	
Switching frequency				
• Resistive loads max.	60 Hz	10 Hz	10 Hz	
• Inductive loads max.	Not permitted	10 Hz	2 Hz	
Insulation voltage rating (external connections to housing, internal connections, other groups)				
• In acc. with VDE 0160	30 V DC	250 V AC	250 V AC	
• Tested with	500 V AC	1500 V AC	1500 V AC	
Supply voltage V_{pos}				
• Rated value	24 V DC	24 V DC	24 V DC	
• Ripple V_{pp} max.	3.6 V	3.6 V	3.6 V	
• Permissible range (with ripple) Value at $t < 0.5$ s	20 ... 30 V 35 V	20 ... 30 V 35 V	20 ... 30 V 35 V	
Current consumption				
• Internal (at 5 V) typ.	50 mA	50 mA	50 mA	
• External (at 24 V) typ.	240 mA	200 mA	256 mA	
Power loss (rated operation) typ.	5 W	4 W	6.5 W	
Front connector	46-pin	24-pin	46-pin	
Weight approx.	0.8 kg (1.8 lb)	0.8 kg (1.8 lb)	0.8 kg (1.8 lb)	

Ordering data	Order No.	Order No.
Non-floating: 441-7 digital output module for S5-115U/H; 32 outputs, 24V DC; 0.5 A	6ES5 441-7LA12	457-7 digital output module for S5-115U/H; 32 outputs, 5/24 V DC; 100 mA
Floating: 451-7 digital output module for S5-115U/H/F; 32 outputs, 24V DC; 0.5 A	6ES5 451-7LA12	458-7 digital output module for S5-115U/H/F 16 relay contact outputs ¹⁾ 30 V UC; 0.5 A
451-7 digital output module for S5-115U/H; 32 outputs, 24V DC; 0.5 A with short-circuit indication	6ES5 451-7LA21	8 relay contact outputs, 250 V AC; 5 A
453-7 digital output module for S5-115U/H; 16 outp., 24/60 V DC; 0.5 A	6ES5 453-7LA11	for S5-115U/H 16 relay contact outputs 250 V AC; 5 A, 30 V DC; 5 A
453-4 digital output module for S5-115U/H/F ²⁾ ; 16 outputs, 24V DC; 2 A	6ES5 453-4UA12	The operating instructions are included in the S5-115U manual (see page 3/23)
454-7 digital output module for S5-115U/H/F 16 outputs, 24 V DC; 2 A 8 outputs, 24 V DC; 2 A	6ES5 454-7LA12 6ES5 454-7LB11 6ES5 455-7LA11	490 front connector For screw terminals • 24-pin • 46-pin For crimp terminals, 46-pin • With 50 crimp contacts • Without crimp contacts For snap-on clip terminals, 46-pin
455-7 digital output module for S5-115U/H; 16 outp., 48/115 V DC; 1 A	6ES5 456-7LA11	6ES5 457-7LA11
456-7 digital output module for S5-115U/H 16 outputs, 115/230 V AC; 1 A for S5-115U/H/F 8 outputs, 115/230 V AC; 1.5 A	6ES5 456-7LB11	6ES5 458-7LA11 6ES5 458-7LB11 6ES5 458-7LC11 6ES5 490-7LB11 6ES5 490-7LB21 6ES5 490-7LA11 6ES5 490-7LA21 6ES5 490-7LC11

1) For new systems the use of the 6ES5 453-4UA12 module is suggested

3) Each contact is jumpered with a varistor (residual current max. 1 mA at 250 V AC)

2) Adapter casing required

4) Reed relay for measuring circuits

Digital output modules (continued)

Connection diagrams

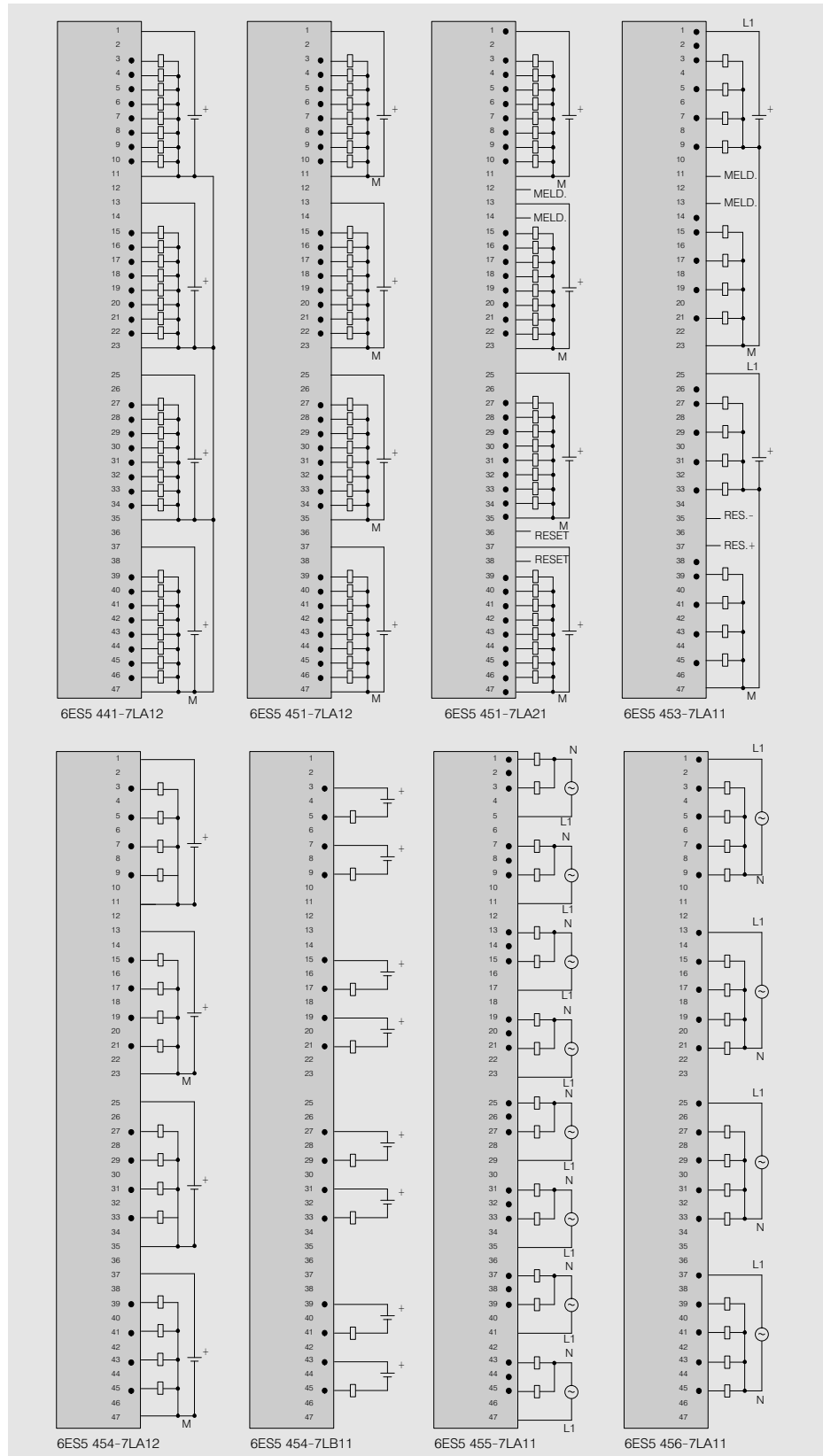

Fig. 3/27 Connection diagrams for digital output modules

SIMATIC S5-115U/H/F

Digital input/output modules

Digital output modules (continued)

Connection diagrams (continued)

3

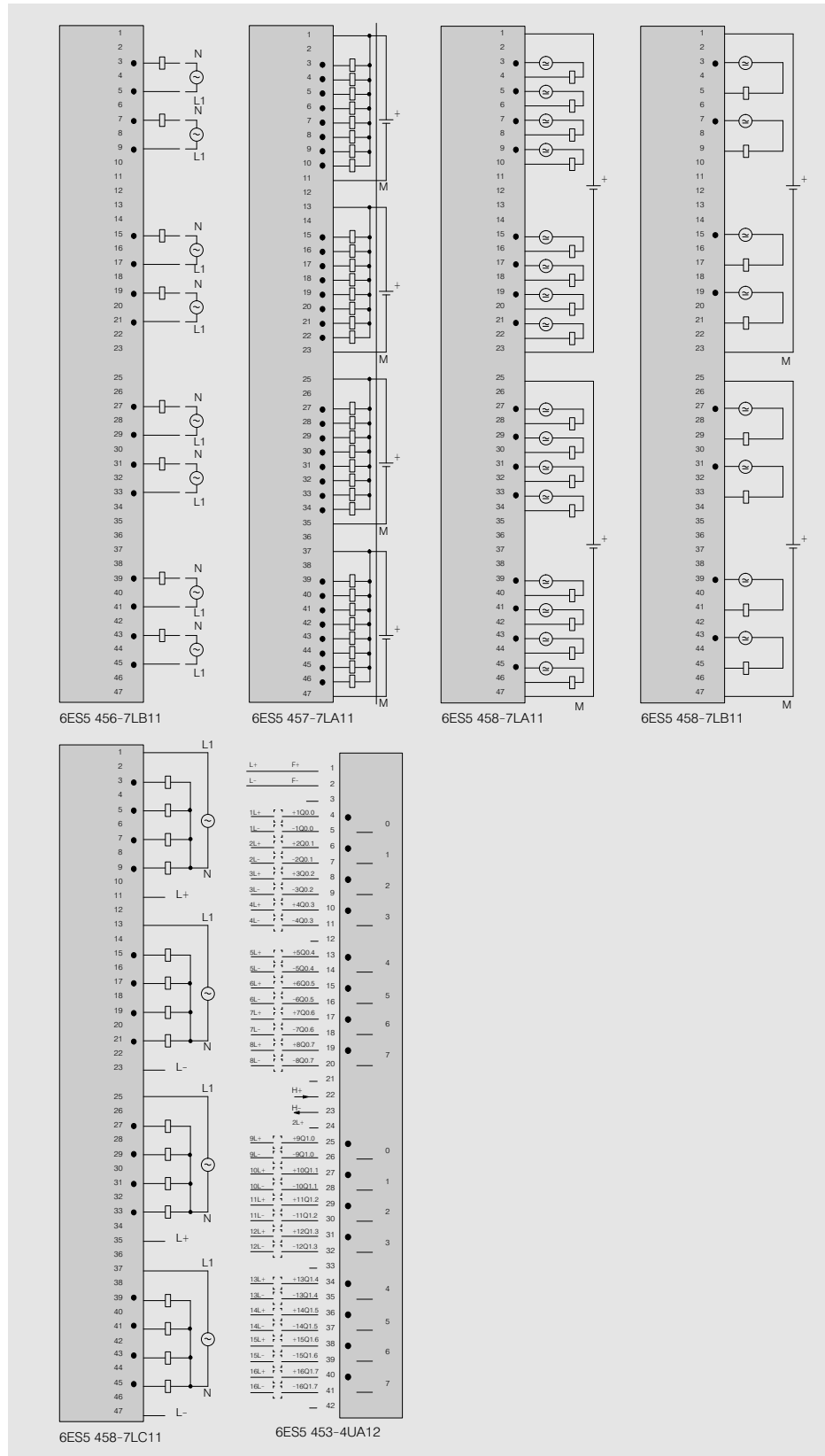

Fig. 3/28 Connection diagrams for digital output modules

SIMATIC S5-115U/H/F

Digital input/output modules

Digital input/output modules

Application



The digital input/output modules combine the functions of the digital input and output modules on one module. In the digital input section external binary signals from the process are converted to the internal signal levels of the programmable controller.

In the digital output section the internal signal levels of the programmable controller are converted to the binary signal levels required externally by the process.

3

Design

Digital input/output modules are available with 8 inputs and 8 outputs, 16 inputs and 16 outputs or 24 inputs and 16 outputs. The modules require 1/2 or 1 slot (depending on the subrack).

The signal leads must be connected with front connectors. They can be labelled in the field next to the LEDs.

The inputs and outputs can be addressed with the same addresses (e.g. E 4.0 to E 5.7 and A 4.0 to A 5.7). The input/output connection (sink input/source input or sink output/source output) is fixed for the 482-7 and 485-7 modules, but parameter-selectable for the 482-7LF31 module.

Principle of operation

Interrupt processing

485-7 digital input/output module only:
The 485-7 digital input/output module can be operated with or without interrupt processing. Four of the total of 24 inputs can be used to gene-

rate a group signal which triggers an interrupt when one of the input signals changes on the positive-going edge. Interrupt evaluation is only possible in the central controller.

Note

All the digital input/output modules of the S5-135U/-155U programmable controllers (see Section 4) can be used in the S5-115U with adapter casings.

Technical specifications

Digital input/output module	6ES5 482-7LA11	6ES5 482-7LF11	6ES5 482-7LF21	6ES5 482-7LF31	6ES5 485-7LA11
Number of inputs	16 , sink input	16 , source readback	16 , sink readback	8 , source/sink readb.	24
Galvanic isolation	Yes (optocoupler)	Yes (optocoupler)	Yes (optocoupler)	Yes (optocoupler)	No
• In groups of	8	8	—	8	—
Interrupt inputs	—	—	—	—	4
Suitable for safety signals	No	Yes	Yes	Yes	No
Input voltage	24 V DC	24 V DC	24 V DC	24 V DC	24 V DC
• Rated value	— 30 ... + 5 V	— 10 ... + 30 V ¹⁾	— 30 ... + 5 V	— 30 ... + 15 V (10 ... + 30 V) ¹⁾	— 30 ... + 5 V
• For "0" signal	—	—	—	—	—
• For "1" signal	+ 13 ... + 30 V	— 30 ... + 5 V ¹⁾	+ 13 ... + 30 V	+ 20 ... + 30 V (— 30 ... + 5 V) ¹⁾	+ 13 ... + 30 V
Input current at "1" signal	typ. 8.5 mA	0.8 mA	0.8 mA	0.8 mA	7.2 mA
Delay	—	—	—	—	—
• At "0" → "1"	2.2 ... 4.6 ms	1.4 ... 5 ms	1.4 ... 5 ms	1.4 ... 5 ms	3 ms
• At "1" → "0"	4.5 ... 12 ms	1.4 ... 5 ms	1.4 ... 5 ms	1.4 ... 5 ms	3 ms
• For interrupt inputs	—	—	—	—	1.5 ms
Cable length	—	—	—	—	—
• Unshielded	max. 600 m (1968 ft)	60 m (196.8 ft)	60 m (196.8 ft)	60 m (196.8 ft)	60 m (196.8 ft)
• Shielded	max. 1000 m (3280 ft)	100 m (328 ft)	100 m (328 ft)	100 m (328 ft)	100 m (328 ft)

1) Values for source input

SIMATIC S5-115U/H/F

Digital input/output modules

Digital input/output modules (continued)

Technical specifications (continued)						
Digital input/output module		6ES5 482-7LA11	6ES5 482-7LF11	6ES5 482-7LF21	6ES5 482-7LF31	6ES5 485-7LA11
Number of outputs		16 , source output	16 , source output	16 , sink output	8 , source/sink output	16
Galvanic isolation		Yes (optocoupler)	Yes (optocoupler)	Yes (optocoupler)	Yes (transformer)	No
• In groups of		8	8			—
Supply voltage						
V_{pos} (for load)		24 V DC	24 V DC	24 V DC	24 V DC	24 V DC
• Rated value		3.6 V	3.6 V	3.6 V	3.6 V	—
• Ripple V_{pp}	max.					
• Permissible range (with ripple)		20 ...30 V	20 ...30 V	20 ...30 V	20 ...30 V	20 ...30 V
Value at $t < 0.5$ s	max.	35 V	35 V	35 V	35 V	35 V
Output current at "1" signal						
• Rated value		0.5 A	0.5 A	0.5 A	2.5 A	1.5 A
• Permissible range		5 mA ... 0.5 A	5 mA ... 0.5 A	5 mA ... 0.5 A	5 mA ... 2.5 A	5 mA ... 1.5 A
Lamp load	max.	5 W	5 W	5 W	40 W	5 W
Inductive load	max.	8.5 W	8.5 W	8.5 W	60 W	
Short-circuit protection		Electronic	Electronic	Electronic	Electronic	Electronic
Voltage induced on circuit interruption (internal) limited	to	$V_{pos} - 47$ V	$V_{pos} - 47$ V	$V_{pos} - 47$ V	$V_{pos} - 47$ V	(from 3.6 A) - 15 V
Switching frequency						
• Resistive loads	max.	100 Hz	100 Hz	100 Hz	100 Hz	100 Hz
• Lamp loads	max.	8 Hz	8 Hz	8 Hz	8 Hz	8 Hz
• Inductive loads	max.	0.5 Hz	0.5 Hz	0.5 Hz	0.5 Hz	0.5 Hz
Load factor ¹⁾						
• At 25 °C		100 %	100 %	100 %	100 %	50 %
• At 55 °C		50 %	50 %	50 %	100 %	50 %
Residual current at "0" signal	max.	1 mA	1 mA	1 mA	0.5 mA	1 mA
Signal level of the outputs						
• At "0" signal	max.	+ 3 V	+ 3 V	V_{pos}	+ 3 V; $V_{pos}^{2)}$	
• At "1" signal	min.	$V_{pos} - 2.5$ V	$V_{pos} - 2.5$ V	$V_{pos} + 2.5$ V	$V_{pos} - 1$ V; (+ 1 V) ²⁾	$V_{pos} - 2.5$ V
Cable length						
• Unshielded	max.	600 m (1968 ft)	600 m (1968 ft)	600 m (1968 ft)	600 m (1968 ft)	600 m (1968 ft)
• Shielded	max.	1000 m (3280 ft)	1000 m (3280 ft)	1000 m (3280 ft)	1000 m (3280 ft)	1000 m (3280 ft)
Insulation voltage rating (external connections to housing, internal connections, other groups)						
• In acc. with VDE 0160		30 V DC	30 V DC	30 V DC	30 V DC	30 V DC
• Tested with		500 V AC	500 V AC	500 V AC	500 V AC	500 V AC
Current consumption						
• Internal (at 5 V)		50 mA	50 mA	50 mA	150 mA	100 mA
• External (at 24 V, no load)		10 mA	10 mA	10 mA	95 mA	80 mA per output module
Power loss (rated operation)	typ.	20 W	18 W	18 W	23 W	15 W
Front connector		46-pin	46-pin	46-pin	46-pin	46-pin
Weight	approx.	0.7 kg (1.5 lb)	0.7 kg (1.5 lb)	0.7 kg (1.5 lb)	0.9 kg (2 lb)	0.7 kg (1.5 lb)

1) Referred to the sum of rated currents of a group.

2) Values for sink output

Ordering data	Order No.	Order No.
482-7 digital input/output module³⁾ for S5-115U/H/F 16 inputs, 24 V DC and 16 outputs, 24 V DC; 0.5 A, source input, source output sink input, source output source input, sink output 8 inputs, 24 V DC and 8 outputs, 24 V DC; 2.5 A either source input/ sink input or source output/ sink output	6ES5 482-7LA11	485-7 digital input/output module for S5-115U 24 inputs, 24 V DC and 16 outputs, 24 V DC 490 front connector For screw terminals, 46-pin For crimp terminals, 46-pin • With 50 crimp contacts • Without crimp contacts For snap-on clip terminals, 46-pin
	6ES5 482-7LF11	
	6ES5 482-7LF21	
	6ES5 482-7LF31	
		6ES5 485-7LA11
		6ES5 490-7LB21
		6ES5 490-7LA11
		6ES5 490-7LA21
		6ES5 490-7LC11

3) Operating instructions are included in the S5-115U manual (see page 3/23).

SIMATIC S5-115U/H/F

Digital input/output modules

Digital input/output modules (continued)

Connection diagrams

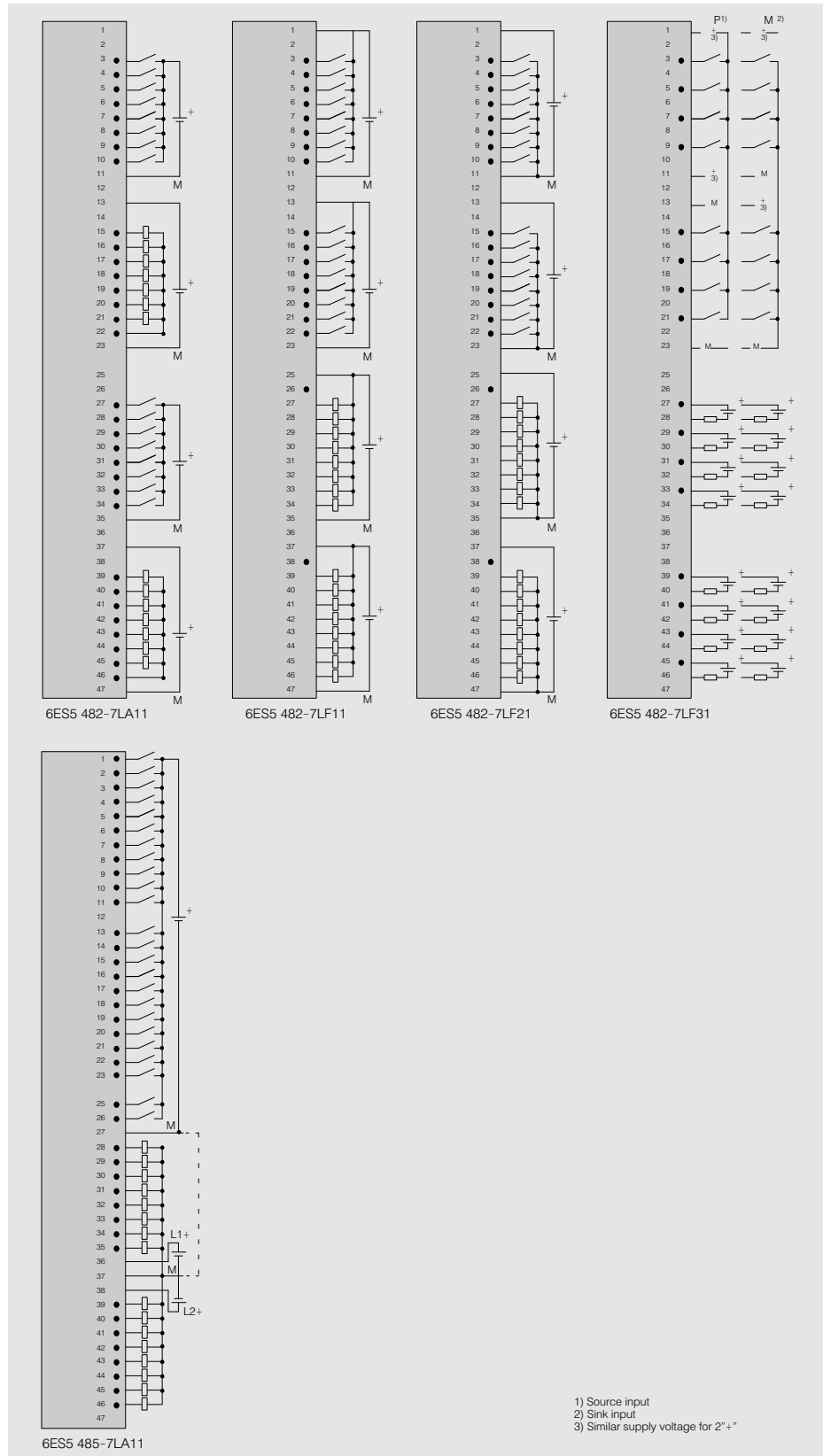

Fig. 3/29 Connection diagrams for digital input/output modules

SIMATIC S5-115U/H/F

Analog input/output modules

Analog input modules

Application

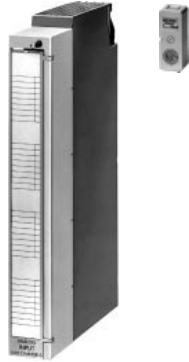

The analog input modules convert the analog signals from the process into digital values which can be processed by the programmable controller.

3

Design

Modules with 4, 8 or 16 inputs are available. The modules each require one slot.

The signal leads must be connected with front connectors. They can be labelled in the field on the front panel.

Measuring range modules required for signal conditioning are plugged into the module. Each module sets the measuring range for a group of 4 channels (inputs).

The 460-7 and 463-4 modules are reaction-free, the 463-4 module is also suitable for failsafe operation.

Functions such as wire break signalling, line frequency or measuring range are set using switches at the rear of the module.

Principle of operation

The analog input modules have different methods of operation. The 460-7, 465-7 and 463-4 modules work on an integrating measuring principle, whereas the 466-3 analog input module uses instantaneous value encoding. Analog-digital conversion is performed in the 460-7 and 465-7 modules by voltage-time conversion and in the 463-4 by voltage-frequency conversion. The 466-3 module employs successive approximation and has the shortest encoding time.

All modules indicate over-range errors. The 460-7 and 465-7 can also detect wire breakage in the sensor line for the Pt 100 (user-configurable). All modules have a high degree of noise suppression.

Note

All the analog input modules of the S5-135U/-155U programmable controllers (see Section 4) can be used in the S5-115U with adapter casings.

An adapter casing is required for the 463-4 and 466-3 analog input modules (page 3/98).

The 463-4 module must not be operated in the third centrally connected ER 701-3 subrack for S5-115F.

Technical specifications

Analog input module	6ES5 460-7LA13	6ES5 465-7LA13	6ES5 463-4U.12
Number of inputs	8 voltage/current inputs or 8 inputs for Pt 100 resistance thermometer	16 voltage/current inputs or 8 inputs for Pt 100 resistance thermometer	4 voltage/current inputs
Galvanic isolation	Yes	No	Yes
Input ranges (rated values)	± 50 mV; ± 500 mV; Pt 100; ± 1 V; ± 5 V; ± 10 V; ± 20 mA; + 4 ... 20 mA Input ranges can be selected for 4 channels at a time using measuring range modules		0 ... 1 V, 0 ... 10 V, 0 ... 20 mA + 4 ... 20 mA for two-wire and four-wire measuring transducers
Input resistance in the individual ranges	50 mV: ≥ 10 MΩ 500 mV: ≥ 10 MΩ Pt 100 : ≥ 10 MΩ	1 V: 90 kΩ; 2 % 5 V: 50 kΩ; 2 % 10 V: 50 kΩ; 2 %	20 mA: 25 Ω; 1 % 4 ... 20 mA: 31.2 Ω; 1 %
Types of connection of sensors	Two-wire connection; four-wire connection for Pt 100		Two-wire connection
Digital representation of the input signal	12 bit + sign or 13 bit two's complement (2048 units = rated value)		11 bit two's complement (1024 units = rated value)

SIMATIC S5-115U/H/F

Analog input/output modules

Analog input modules (continued)

Technical specifications				
Analog input module	6ES5 460-7LA13	6ES5 465-7LA13	6ES5 463-4U.12	
Measuring principle	Integrating	Integrating	Integrating	
Conversion principle	Voltage-time conversion	Voltage-time conversion	Voltage-time conversion	
Integration time (adjustable for optimum noise suppression)	20 ms at 50 Hz 16 ² / ₃ ms at 60 Hz	20 ms at 50 Hz 16 ² / ₃ ms at 60 Hz	20 ms at 50 Hz 16 ² / ₃ ms at 60 Hz	
Encoding time max. (single value encoding possible)	60 ms at 50 Hz 50 ms at 60 Hz (referred to nominal value)	60 ms at 50 Hz 50 ms at 60 Hz (referred to nominal value)	60 ms at 50 Hz 16 ² / ₃ ms at 60 Hz	
Cycle time for 4 inputs	—	—	20 ms at 50 Hz 16 ² / ₃ ms at 60 Hz	
8 inputs	0.48 s at 50 Hz	0.48 s at 50 Hz	—	
16 inputs	—	0.96 s at 50 Hz	—	
Permissible voltage between inputs or between inputs and the central earthing point (destruction limit) max.	± 18 V or max. ± 75 V for 1 ms with a pulse repeat rate of 50 pulses/second		± 30 V or max. ± 75 V for 1 ms with a pulse repeat rate of 100 pulses/second	
Permissible voltage between the reference potential of a non-floating sensor and the central earthing point max.	75 V DC/60 V AC	± 1 V	75 V DC/60 V AC	
Error indication for	At 200 % of the nominal value (4095 units) It can be designed for the ranges 50 mV, 500 mV and Pt 100		At 150 % of the nominal value No	
• Overranging				
• Wire breakage of the sensor line				
Noise suppression for $f = n \cdot (50/60 \text{ Hz} \pm 1\%)$; $n = 1, 2, \dots$				
• Common mode noise ($V_p < 1 \text{ V}$) min.	120 dB	86 dB	80 dB	
• Series mode noise min. (peak noise value < rated value of the range)	40 dB	40 dB	40 dB	
Basic error limits ¹⁾	50 mV: ± 2 % 500 mV: ± 1.5 % Pt 100: ± 2 %	1 V: ± 3.5 % 5 V: ± 3.5 % 10 V: ± 3.5 %	20 mA: ± 2.5 % 4 ... 20 mA: ± 2.5 %	1.1 %
Operational error limits ¹⁾ (0 °C to 60 °C)	50 mV: ± 5 % 500 mV: ± 4.5 % Pt 100: ± 5 %	1 V: ± 7.7 % 5 V: ± 7.7 % 10 V: ± 7.7 %	20 mA: ± 6.7 % 4 ... 20 mA: ± 6.7 %	3.7 %
Cable length (shielded) max.	200 m (650 ft); max. 50 m (164 ft) at 50 mV	200 m (650 ft); max. 50 m (164 ft) at 50 mV	200 m (650 ft)	
Supply voltage				
• Rated value	+ 24 V	+ 24 V	+ 24 V	
• Ripple V_{pp}	3.6 V	3.6 V	3.6 V	
• Permissible range (including ripple)	20 ... 30 V	20 ... 30 V	20 ... 30 V	
• Value at $t < 0.1 \text{ s}$	36 V	36 V	36 V	
Current consumption				
• Internal (at 5 V) typ.	0.15 A	0.15 A	0.2 A	
• External (at 24 V) typ.	0.1 A	—	0.15 A	
Front connector	46-pin	46-pin	42-pin	
Weight approx.	0.4 kg (0.9 lb)	0.4 kg (0.9 lb)	0.4 kg (0.9 lb)	

1) In accordance with DIN 43 745; referred to nominal measuring range (5 V supply from power supply module).

SIMATIC S5-115U/H/F

Analog input/output modules

Analog input modules (continued)

3

Technical specifications	
Analog input module	6ES5 466-3LA11
Number of inputs	8 differential inputs or 16 individual inputs (referred to ground) in 4 or 2 groups (selectable)
Galvanic isolation	Yes
Input ranges (rated values)	0 ... 20 mA; 4 ... 20 mA; ± 20 mA 0 ... 1.25 V; 0 ... 2.5 V; 0 ... 5 V; 1 ... 5 V; 0 ... 10 V ± 1.25 V; ± 2.5 V; ± 5 V; ± 10 V } selector switch lets you select these values for 4 channels separately
Input resistance in the individual ranges	Voltage measuring range: $\geq 10 \text{ M}\Omega$ Current measuring range: $125 \text{ M}\Omega$
Types of connection of signal sensors	Two-wire connection
Digital representation of the input signal	13 bit two's complement or 12 bit abs. value + sign or 12 bit binary
Measuring principle	Instantaneous value encoding
Conversion principle	Successive approximation
Encoding time per channel	max. 250 μs
Cycle time for	
8 inputs	max. 2 ms
16 inputs	max. 4 ms
Permissible voltage between inputs or between inputs and the central earthing point (destruction limit)	max. $\pm 30 \text{ V}$ (static) or $\pm 75 \text{ V}$ for 1 ms with a pulse repeat rate of 50 pulses/second
Permissible voltage between the reference potential of a non-floating sensor and the central earthing point	max. 75 V DC/60 V AC
Error indication for	
• Overranging	Yes (overflow bit)
• Wire breakage of the sensor line	No
Noise suppression for $f = n \cdot (50/60 \text{ Hz} \pm 1\%)$; $n = 1, 2 \dots$	
• Common mode noise	min. 70 dB
• Series mode noise ($V_p < 1 \text{ V}$)	min. 40 dB
• Series mode noise (peak noise value < rated value of the range)	
Basic error limits ¹⁾ (at 20 °C)	Voltage ranges (except 0... 1.25 V; $\pm 1.25 \text{ V}$): 0.1 % Current ranges and 0... 1.25 V; $\pm 1.25 \text{ V}$: 0.12%
Operational error limits ¹⁾ (0 °C to 60 °C; for one year)	Voltage ranges (except 0... 1.5 V; $\pm 1.25 \text{ V}$): 0.2 % Current ranges and 0... 1.25 V; $\pm 1.25 \text{ V}$: 0.24%
Cable length (shielded)	max. 200 m (650 ft)
Current consumption	
• Internal (at 5 V)	typ. 0.7 A
• External (at 24 V)	typ. —
Front connector	43-pin
Weight	approx. 0.4 kg (0.9 lb)

1) In accordance with DIN 43 745; referred to nominal measuring range (5 V supply from power supply module).

SIMATIC S5-115U/H/F

Analog input/output modules

Analog input modules (continued)

Ordering data	Order No.		Order No.
<p>460-7 analog input module for S5-115U/H/F 8 inputs (current/voltage or Pt 100), input range set by measuring range module, floating</p> <p>465-7 analog input module for S5-115U/H 16 inputs (current/voltage) or 8 inputs (Pt 100), input range set by measuring range module, non-floating</p> <p>To be ordered as a separate item: 498 measuring range module for 4 channels ± 50 mV; ± 500 mV; Pt 100 ± 1 V ± 5 V ± 10 V ± 20 mA + 4 ... 20 mA; for 2-wire transducer + 4 ... 20 mA; for 4-wire transducer</p> <p>463-4 analog input module for S5-115U/H/F 4 inputs, floating For 50 Hz systems For 60 Hz systems</p>	6ES5 460-7LA13	<p>466-3 analog input module for S5-115U/H 16 individual inputs/ 8 differential inputs floating, with short encoding time</p> <p>Operating instructions are included in the S5-115U manual (see page 3/23).</p> <p>490 front connector for AE 463-4, 466-3 For screw terminals, 46-pin</p> <p>For crimp terminals, 46-pin</p> <ul style="list-style-type: none"> • With 50 crimp contacts • Without crimp contacts <p>For snap-on clip terminals, 46-pin</p> <p>497 front connector for AE 463-4 Crimp terminals, 42-pin Screw terminals, 42-pin</p> <p>K front connector for AE 466-3 Crimp terminals, single-width, 43-pin Screw terminals, single-width, 42-pin</p> <p>Adapter casing for 463-4, 466-3 analog input modules</p>	6ES5 466-3LA11
	6ES5 465-7LA13		6ES5 490-7LB21
	6ES5 498-1AA11 6ES5 498-1AA21 6ES5 498-1AA61 6ES5 498-1AA31 6ES5 498-1AA41 6ES5 498-1AA51		6ES5 490-7LA11 6ES5 490-7LA21 6ES5 490-7LC11
	6ES5 498-1AA71		6ES5 497-4UA12 6ES5 497-4UB31
	6ES5 463-4UA12 6ES5 463-4UB12		6XX3 068 6XX3 081
			see page 3/98

3

Connection diagrams

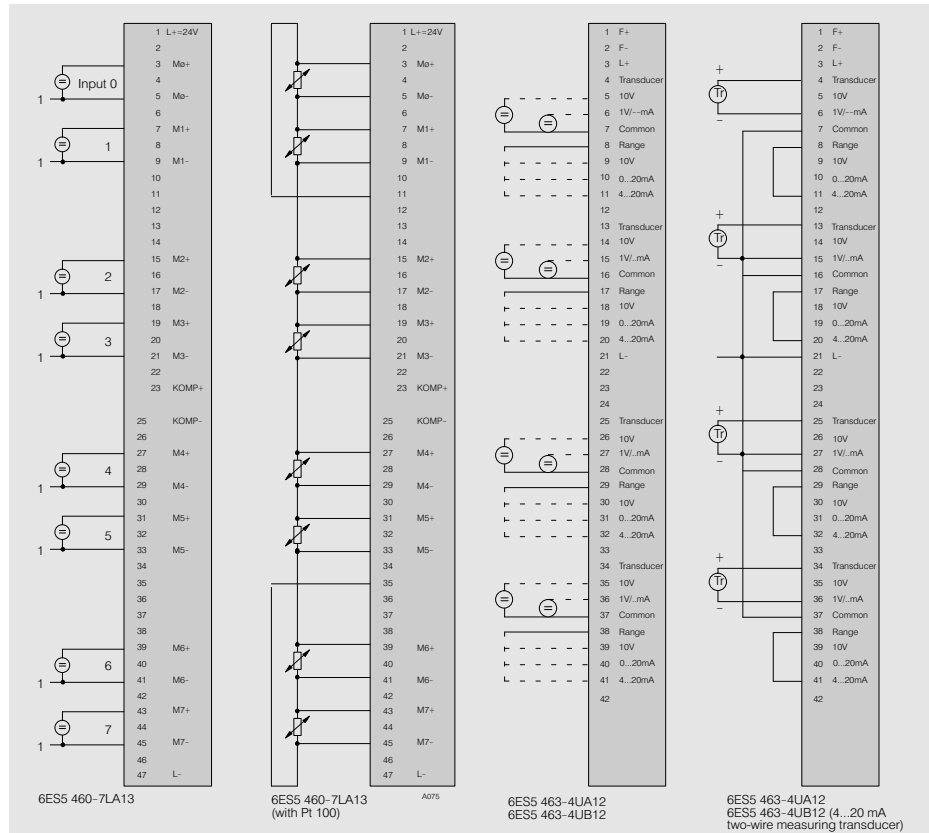

Fig. 3/30 Connection diagram for analog input modules

SIMATIC S5-115U/H/F

Analog input/output modules

Analog input modules (continued)

Connection diagrams

3

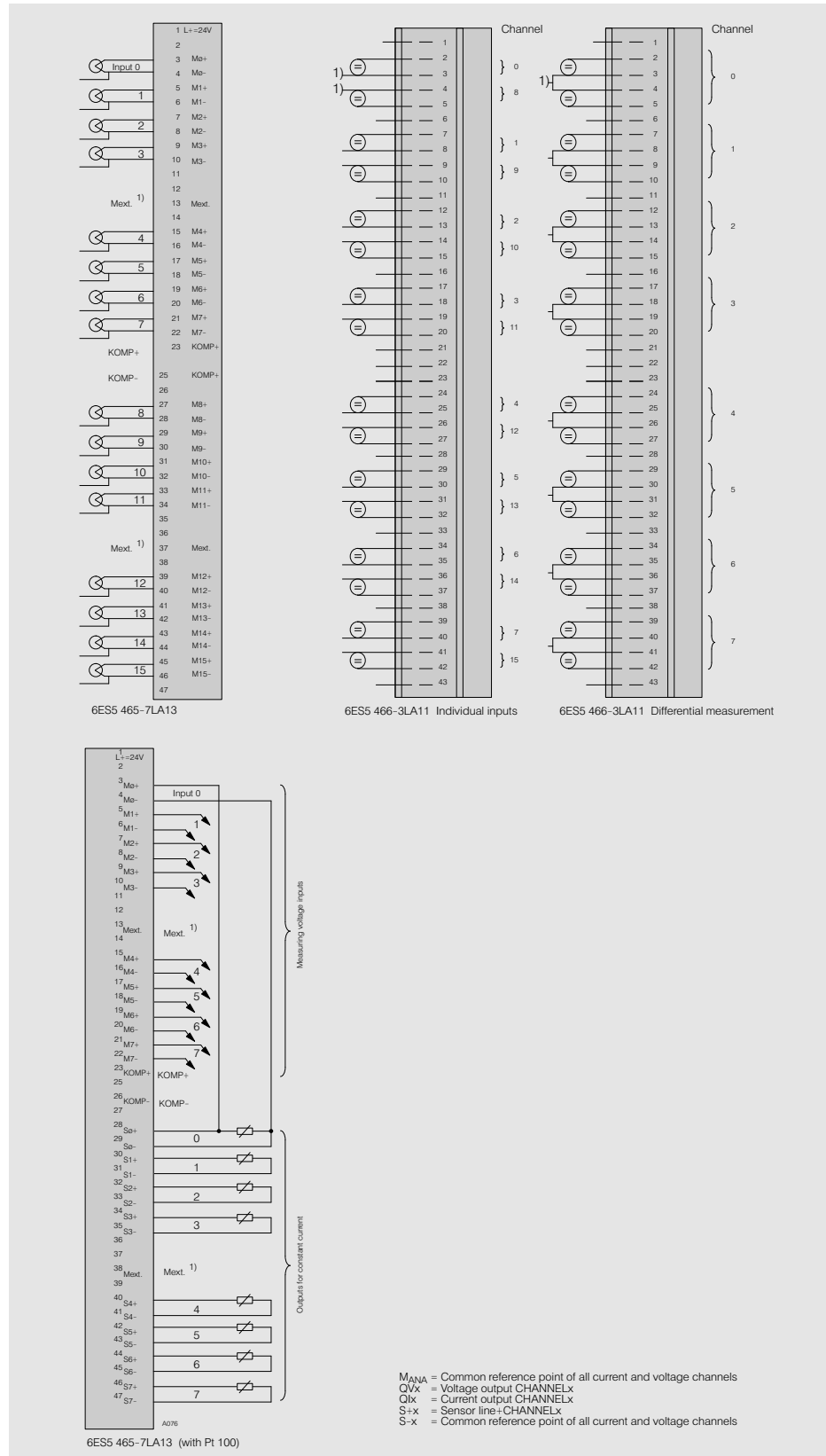

Fig. 3/31 Connection diagrams for analog input modules

SIMATIC S5-115U/H/F

Analog input/output modules

Analog output modules

Application



The analog output modules convert digital values from the programmable controller into the analog signals required by the process.

3

Design

Three analog output modules are available with 8 outputs each and a range of output voltages. The modules each require one slot.

The signal leads must be connected with front connectors. They can be labelled in the fields on the front panel. The modules and front connectors can be inserted

and removed under power. The module address (byte parameter when programming) is slot-dependent and need therefore not be set on the module.

Principle of operation

The CPU of the central controller transmits output values in digital form to the processor of the analog output module. These are converted to analog voltages by a digital-analog converter and a sample-and-hold procedure.

A voltage-current converter is also used to generate the corresponding output currents. The voltage and current output ranges for each module are fixed.

Note

All the analog output modules of the S5-135U/155U programmable controllers (see Section 4) can be used in the S5115U with adapter casings.

Technical specifications

Analog output module		6ES5 470-7L.13	Analog output module		6ES5 470-7L.13
Number of outputs (voltage and current outputs)		8	Open-circuit voltage (current output)	approx.	18 V
Galvanic isolation		Yes (not between the outputs)	Voltage between the reference potential of the load (0 V connection) and the housing	max.	60 V AC/75 V DC
Output ranges (rated values)		±10 V; 0...20 mA	Linearity in the rated range		± 2.5 ‰; ± 3 units
• 6ES5 470-7LA12		±10 V	Operational limits (0 to + 55 °C)		± 6 ‰
• 6ES5 470-7LB12		+1...5 V; +4...20 mA	Cable length (shielded)	max.	200 m (650 ft)
• 6ES5 470-7LC12			Supply voltage		
Load resistance		Only ohmic resistance	• Rated value		+ 24 V
• For voltage outputs	min.	3.3 kΩ	• Ripple V_{pp}		3.6 V
• For current outputs	max.	300 Ω	• Permissible range (including ripple)		20...30 V
Load connection		Load to the 0 V terminal	• Value at $t < 0.1$ s		36 V
Digital representation of the output signal		12 bit two's complement (1024 units = rated value)	Power consumption		
Conversion time		1 ms	• Internal (at 5 V)	typ.	0.25 A
Permiss. overload capability	approx.	25 % (up to 1280 units)	• External (at 24 V)	typ.	0.3 A
Short-circuit protection		Yes	Front connector		46-pin
Short-circuit current (voltage output)	approx.	25 mA	Weight	approx.	0.4 kg (0.9 lb)

SIMATIC S5-115U/H/F

Analog input/output modules

Analog output modules (continued)

3

Ordering data	Order No.		Order No.
470-7LA analog output module for S5-115U/H/F 8 outputs; ± 10 V/0 ... 20 mA	6ES5 470-7LA13	Operating instructions are included in the S5-115U manual (see page 3/23). 490 front connector For screw terminals, 46-pin For crimp terminals, 46-pin • With 50 crimp contacts • Without crimp contacts For snap-on clip terminals, 46-pin	6ES5 490-7LB21 6ES5 490-7LA11 6ES5 490-7LA21 6ES5 490-7LC11
470-7LB analog output module for S5-115U/H/F 8 outputs; ± 10 V	6ES5 470-7LB13		
470-LC analog output module for S5-115U/H/F 8 outputs; + 1 ... 5 V; + 4 ... 20 mA	6ES5 470-7LC13		

Connection diagrams

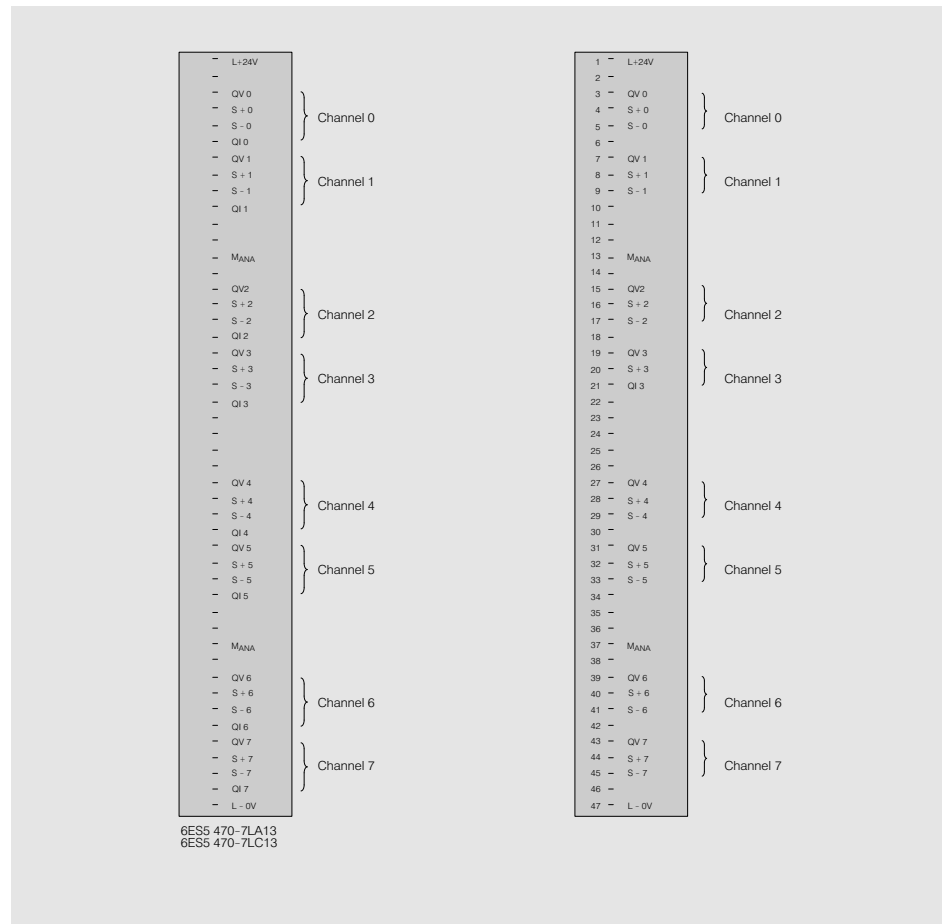

Fig. 3/32 Connection diagrams for analog output modules

SIMATIC S5-115U/H/F

Intelligent I/O modules

Intelligent I/O modules

Overview

Intelligent I/O modules are used for high-speed, high accuracy

- Closed-loop control
- Positioning
- Counting and proportioning
- Processing

of analog signals.

The advantage of the intelligent I/O modules lies in the fact that they execute these time-critical tasks completely autonomously (in most cases with their own processor). The CPU can then concentrate on its own control tasks more closely.

These intelligent I/O modules are linked directly with the process via input and output channels. There is an entire range of intelligent I/O modules for the S5-115U programmable controller, which can be used for the S5-135U and S5-155U/H.

For further information, see Section 4.

SIMATIC S5-115U/H/F

Special modules

Overview

Overview

Special tasks			
Memory	Page	PC functions	Page
CP 516 memory submodule	4/96	CP 581, the integral PC in the SIMATIC	4/97
		CP 581 with COROS LS-B	4/101
Supplementary equipment			
Communication	Page	Simulation	Page
TK 858 telecommunications unit	8/16	Simulation connectors	3/54
		Simulation panel	3/55
		Simulation modules	4/108
		313 monitoring module	4/109

3

Simulation connectors

Application

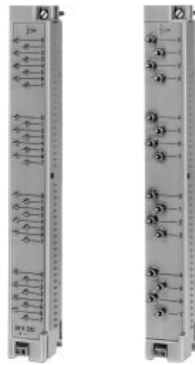

For simulating binary input signals on the S5-115U programmable controller.

Design

The simulation connectors must be plugged into digital input modules in the same way as front connectors and must be supplied with the signal voltage. They have switches which can be used as maintained-contact switches (up position) or as momentary-contact switches (down position).

2 versions are available:

- With 32 switches for 420-7LA and 430-7LA digital input modules
- With 16 switches for 431-7LA, 432-7LA, 435-7LA and 436-7LA digital input modules

Ordering data

Order No.

Simulation connectors

With 32 switches
With 16 switches

6ES5 490-7SA11
6ES5 490-7SA21

SIMATIC S5-115U/H/F

Communications modules

Communications modules and bus systems

Overview

3

Communications processors are used for data interchange between the S5-115U/H/F programmable controllers and the I/Os or other programmable controllers connected to them.

Programmable controllers can be linked in two ways:

Point-to-point connection

Point-to-point connection is used for connecting one or more I/Os or programmable controllers to a single S5115U/H/F programmable controller. The link can, for example, be made via the second interface of the CPU 943, CPU 944 and CPU 945. The CP 523,

CP 524, CP 544 and CP 544B communications processors can also be used. These primarily relieve the CPU of the responsibility for communications, thus enabling a large number of I/Os to be connected.

Bus systems

LANs are used for interlinking a number of nodes. Possible nodes include:

- S5-115U/H/F programmable controllers
- Third-party programmable controllers
- Personal computers
- Minicomputers or workstations
- Field equipment

There are three different LANs to choose from, depending on the area to be covered, the number and type of nodes and the transmission speed:

- SINEC L1
- PROFIBUS
- Industrial Ethernet

A communications processor is available for each of these three bus systems.

For further information, selection and ordering data, see Section 4.

CP 523 communications processor for the S5-115F**Application**

The CP 523 communications processor makes linking to any desired devices with serial interfaces possible. The module is especially suitable for:

- Direct safety-related link between two programmable controllers
- Direct reaction-free link between a S5-115F programmable controller and another SIMATIC programmable controller

- Link with a personal computer as well as operator control and process monitoring equipment

Devices with serial interfaces like, for example, printers, terminals, keyboards, barcode readers, CP 523, etc. can be connected.

3

Design

In the S5-115F programmable controller it must be observed that the V.24 interface must only be used if the partner device ensures an electrical separation in accordance with VDE 0160.

For further information, see Section 4.

Principle of operation**Interfacing**

The FB 252 integral function block in the S5-115F programmable controller delivers block-wise data transfer to the CP 523.

A safety-related link of further S5-115F programmable controllers is possible with standard function blocks (see Section 7).

Message printout

In the S5-115F programmable controller the CP 523 can be used for the output of system fault signals. For that, it assigns the top 256 signals and in the event of system faults gives out one of these signals automatically. The signal texts for the system fault signals are contained in the diskette with the COM 115F parameterization software as an example.

For further information, see Section 4.

SIMATIC S5-115U/H/F

Subracks

CR 700-0LA subrack for S5-115U central controllers

Application

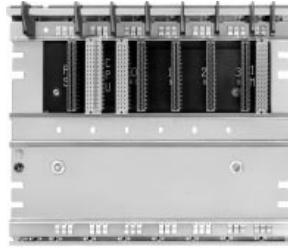

A small central controller with up to four I/O modules can be configured with the CR 700-0LA subrack. A power supply and CPU module are always required. Hardware interrupt evaluation is possible on all admissible slots for the corresponding modules.

3

Design

Up to three expansion units can be connected in series in centralized configuration (via IM 305 and IM 306 interface modules).

- Type: Aluminium baseplate of extruded section with bus board for connecting the modules

- Dimensions (W x H x D) in mm: 353 x 303 x 47
- Weight: approx. 4 kg

Module locations

	Slot No.	PS	CPU	0	1	2	3	IM
PS 951 power supply module								
CPU 941 to CPU 945								
Digital input and output, digital input/output, analog input and output modules (block type: 6ES5 4..-7....)								
Digital input and output, analog input and output modules (compact modules: 6ES5 4..-4....., 6ES5 466-3LA11)								
Communications processors		For slot assignment, see Section 11						
Intelligent I/O modules		For slot assignment, see Section 11						
IM 305, IM 306								

Ordering data

Order No.

CR 700-0LA subrack

6ES5 700-0LA12

SIMATIC S5-115U/H/F

Subracks

CR 700-0LB subrack for S5-115U central controllers

Application

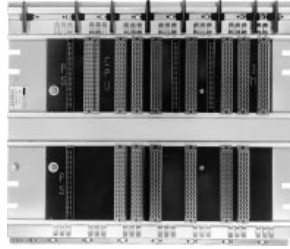

A small central controller with up to six I/O modules can be configured with the CR 700-0LB subrack. A power supply and CPU module are always required.

3

Design

Two single-width modules in one adapter casing can be plugged into slots 0 and 3. Where two or more modules are installed in one casing, a fan subassembly is always required.

Hardware interrupt evaluation is possible on the admissible slots for the corresponding modules.

Connection of expansion units the same as for the CR 700-2 subrack, but 2 interface modules can be used for distributed configuration in 1 adapter casing in slot 3.

Type, dimensions and weight: see CR 700-0LA subrack.

Module locations

Slot No.	Slot No.						
	PS	CPU	0	1	2	3	IM
PS 951 power supply module							
CPU 941 to CPU 945							
Digital input and output, digital input/output, analog input and output modules (block type: 6ES5 4..-7....)							
Digital input and output, analog input and output modules (compact modules: 6ES5 4..-4....., 6ES5 466-3LA11)							
Communications processors	For slot assignment, see Section 11						
Intelligent I/O modules	For slot assignment, see Section 11						
IM 304, IM 308, IM 308-B							
IM 305, IM 306							
IM 307							1)

1) No interrupt processing possible in slot 3.

Ordering data

Order No.

CR 700-0LB subrack

6ES5 700-0LB11

SIMATIC S5-115U/H/F

Subracks

CR 700-1 subrack for S5-115U central controllers

Application

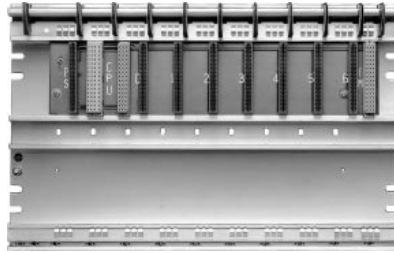

A central controller with up to seven I/O modules can be configured with the CR 700-1 subrack. A power supply and CPU module are always required. Hardware interrupt evaluation is possible on the admissible slots for the corresponding modules.

3

Design

Up to 3 expansion units can be connected in series in centralized configuration.

- Type: Aluminium baseplate of extruded section with bus board for connecting the modules

- Dimensions (W x H x D) in mm: 483 x 303 x 47
- Weight: approx. 5 kg

Module locations

Slot No.	PS	CPU	0	1	2	3	4	5	6	IM
PS 951 power supply module										
CPU 941 to CPU 945										
Digital input and output, digital input/output, analog input and output modules (block type: 6ES5 4..-7...), 776 power output										
Digital input and output, analog input and output modules (compact modules: 6ES5 4..-4...., 6ES5 466-3LA11)										
Communications processors	For slot assignment, see Section 11									
Intelligent I/O modules	For slot assignment, see Section 11									
IM 305, IM 306										

1) Analog modules in slots 4, 5 and 6 only possible when using the IM 306 interface module.

Ordering data

Order No.

CR 700-1 subrack

6ES5 700-1LA12

SIMATIC S5-115U/H/F

Subracks

CR 700-2 subrack for S5-115U central controllers

Application

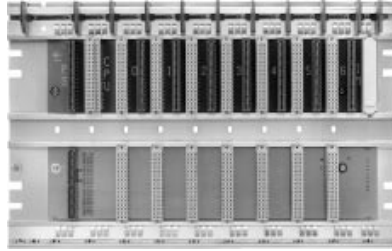

A central controller with up to seven I/O modules can be configured with the CR 700-2 subrack. A power supply and CPU module are always required.

Hardware interrupt evaluation is possible on the admissible slots for the corresponding modules.

3

Design

In centralized configuration up to 3 expansion units can be connected in series.

In distributed configuration the following can be connected:

- Up to 600 m, up to 2 times 4 expansion units (via IM 304)
- Up to 3000 m, up to 63 expansion units (via IM 308)

- For a distance of 50 to 500 m between 2 interface modules, max. 3 expansion units (via IM 307)

- Up to 23 km, max. 122 ET 200 distributed I/O modules (in two phases, via IM 308-B)

In addition to that, up to 3 expansion units can be connected in centralized configuration to distributed expansion units.

Type, dimensions and weight: see CR 700-1 subrack.

Module locations

	Slot No.									
	PS	CPU	0	1	2	3	4	5	6	IM
PS 951 power supply module										
CPU 941 to CPU 945										
Digital input and output, digital input/output, analog input and output modules ¹⁾ (block type: 6ES5 4..-7....)										
Digital input and output ²⁾ , analog input and output modules (compact modules: 6ES5 4..-4....., 6ES5 466-3LA11)										
Communications processors	For slot assignment, see Section 11									
Intelligent I/O modules	For slot assignment, see Section 11									
IM 304, IM 308, IM 308-B										
IM 305, IM 306										
IM 307										3)

1) Analog modules in slots 4, 5 and 6 only possible when using the IM 306 interface module.

2) 434-4 digital input module not in slot 6.

3) No interrupt processing possible in slot 6.

Ordering data

Order No.

CR 700-2 subrack

6ES5 700-2LA12

SIMATIC S5-115U/H/F

Subracks

CR 700-3 subrack for S5-115U central controllers

Application

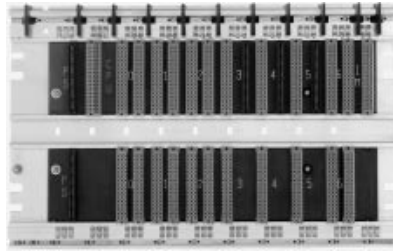

A central controller with up to eleven I/O modules can be configured with the CR 700-3 subrack. A power supply and CPU module are always required.

3

Design

Two single-width modules in one adapter casing can be plugged into slots 0, 1, 2 and 6. Where two or more modules are installed in one casing, a fan subassembly is always required.

Hardware interrupt evaluation is possible in the admissible slots for the corresponding modules.

Connection of expansion units the same as for the CR 700-2 subrack, but 2 interface

modules can be used for distributed configuration in one adapter casing in slot 6.

Type, dimensions and weight: see CR 700-1 subrack.

Module locations

Slot No.	PS	CPU	0	1	2	3	4	5	6	IM
PS 951 power supply module										
CPU 941 to CPU 945										
Digital input and output, digital input/output, analog input and output modules ¹⁾ (block type: 6ES5 4..-7....)										
Digital input and output ²⁾ , analog input and output modules (compact modules: 6ES5 4..-4...., 6ES5 466-3LA11)										
Communications processors	For slot assignment, see Section 11									
Intelligent I/O modules	For slot assignment, see Section 11									
IM 304, IM 308, IM 308-B										
IM 305, IM 306										
IM 307										2)

1) Analog modules in slots 4, 5 and 6 only possible when using the IM 306 interface module.
2) No interrupt processing possible in slot 6.

Ordering data

Order No.

CR 700-3 subrack

6ES5 700-3LA12

SIMATIC S5-115U/H/F

Subracks

ER 701-0 subrack for S5-115U expansion units

Application

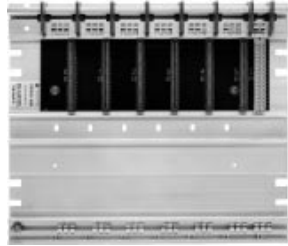

An expansion unit containing up to six I/O modules can be configured with the ER 701-0 subrack. Power supply by the central controller or an expansion unit with the ER 701-2 or ER 701-3 subrack.

Design

An expansion unit with the ER 701-0 subrack must always be connected in centralized configuration (IM 305 or IM 306 interface module).

Interrupt evaluation is not possible in this expansion unit.

Type, dimensions and weight: see CR 700-0 subrack.

Module locations

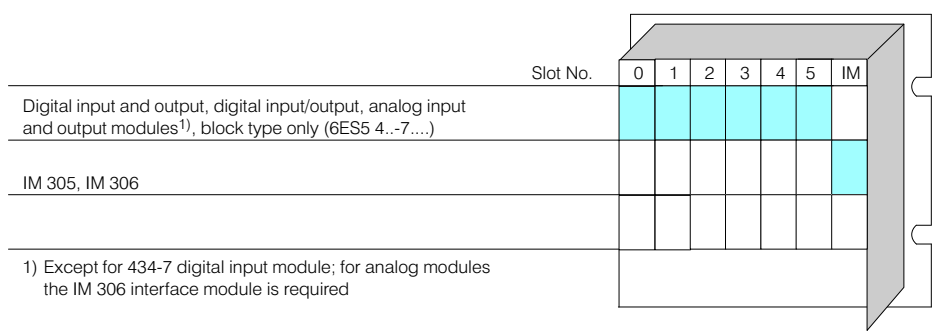

Ordering data	Order No.
ER 701-0 subrack	6ES5 701-0LA11

SIMATIC S5-115U/H/F

Subracks

ER 701-1 subrack for S5-115U expansion units

Application



An expansion unit containing up to nine I/O modules can be configured with the ER 701-1 subrack. Power supply by the central controller or an expansion unit with the ER 701-2 or ER 701-3 subrack.

3

Design

An expansion unit with the ER 701-1 subrack must always be connected in centralized configuration (IM 305 or IM 306 interface module).

Interrupt evaluation is not possible in this expansion unit.

Type, dimensions and weight: see CR 700-1 subrack.

Module locations

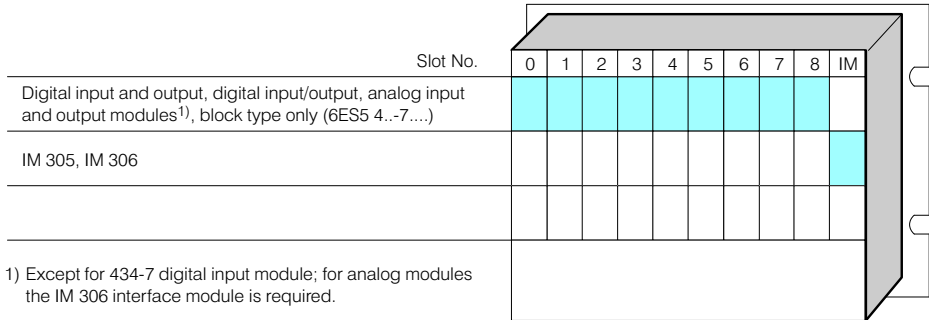

Ordering data	Order No.
ER 701-1 subrack	6ES5 701-1LA12

SIMATIC S5-115U/H/F

Subracks

3

ER 701-2 subrack for S5-115U expansion units

Application

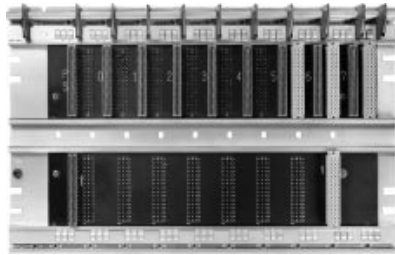

An expansion unit containing up to seven I/O modules can be configured with the ER 701-2 subrack. A power supply module and the IM 306 interface module (for modules in block design) are always required.

Design

An expansion unit with the ER 701-2 subrack must always be connected in distributed configuration (IM 314, IM 317 or IM 318 interface modules).

Interrupt evaluation is not possible in this expansion unit.

Type, dimensions and weight: see CR 700-1 subrack.

Module locations

Slot No.	PS	0	1	2	3	4	5	6	7	IM
PS 951 power supply module										
Digital input and output, digital input/output, analog input and output modules ¹⁾ (block type: 6ES5 4..-7....),										
Digital input and output, analog input and output modules ¹⁾ (compact modules: 6ES5..-4.-....., 6ES5 466-3LA11)										
Communications processors	For slot assignment, see Section 11									
IM 306										
IM 314, IM 317, IM 318										
313 monitoring module										

1) The IM 306 interface module is necessary for modules in block design (for address setting).

Ordering data	Order No.
ER 701-2 subrack	6ES5 701-2LA12

SIMATIC S5-115U/H/F

Subracks

ER 701-3 subrack for S5-115U expansion units

Application

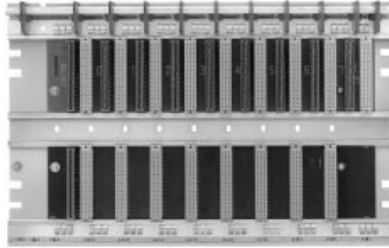

An expansion unit containing up to seven I/O modules can be configured with the ER 701-3 subrack. A power supply module and the IM 306 interface module (for modules in block design) are always required.

3

Design

An expansion unit with the ER 701-3 subrack must always be connected in distributed configuration (IM 314, IM 317 or IM 318 interface modules). When using IM 314 or IM 317 interface modules, also communications processors and intelligent I/O modules with page frame address can be plugged in.

In the ER 701-3 expansion unit interrupt processing is only possible when using the IM 307/IM 317 fiber optic interface modules.

Type, dimensions and weight: see CR 700-1 subrack.

Module locations

Slot No.	PS	0	1	2	3	4	5	6	7	IM
PS 951 power supply module										
Digital input and output, analog input and output modules ¹⁾ (block type: 6ES5 4..-7....),										
Digital input and output, digital input/output, analog input and output modules (compact mod.: 6ES5..-4-...., 6ES5 466-3LA11)										
Communications processors	For slot assignment, see Section 11									
Intelligent I/O modules	For slot assignment, see Section 11									
IM 306 (always required)										
IM 314 (also IM 310) or IM 318										
IM 307, IM 317										2)
313 monitoring module										

1) Except for 434-7 digital input module.

2) No interrupt processing possible in slot 7.

3) The IM 306 interface module is necessary for modules in block design (for address setting).

Ordering data

Order No.

ER 701-3 subrack

6ES5 701-3LA13

SIMATIC S5-115U/H/F

Subracks

3

CR 700-0LB subrack for S5-115H central controllers

Application

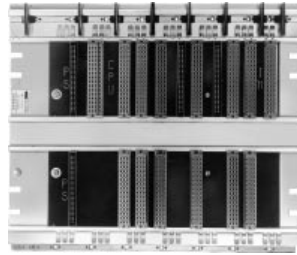

A small central controller with up to four I/O modules can be configured with the CR 700-0LB subrack. A power supply and CPU module are always required, as well as an IM 304 or IM 324R interface module for linking the two central controllers.

Design

Up to three expansion units can be connected in centralized configuration (for redundant or single-sided configurations).

Up to two times four expansion units (each with three additional EUs in centralized configuration) can be connected in distributed configuration up to 600 m (1968 ft).

Module locations

Slot No.	PS	CPU	0	1	2	3	IM
PS 951 power supply module							
CPU 942H							
Digital input and output, digital input/output, analog input and output modules (block type: 6ES5 4..-7....)							
Digital input and output, analog input and output modules (compact modules: 6ES5 4..-4....., 6ES5 466-3LA11)							
Communications processors	For slot assignment, see Sec. 11						
Intelligent I/O modules	For slot assignment, see Sec. 11						
IM 304 for linking central controllers or for distributed expansion							
IM 304, IM 306							
IM 307							
IM 324R for linking central controllers							

Ordering data	Order No.
CR 700-0LB subrack	6ES5 700-0LB11

SIMATIC S5-115U/H/F

Subracks

CR 700-2 subrack for S5-115H central controllers

Application

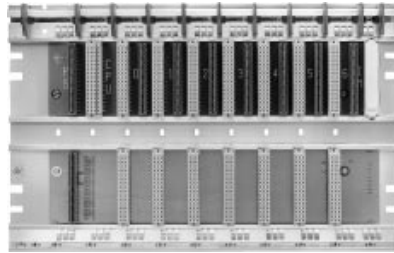

A central controller with up to six I/O modules can be configured with the CR 700-2 subrack. A power supply and CPU module are always required, as well as an IM 304 or IM 324R interface module for linking the two central controllers.

3

Design

Up to three expansion units can be connected in centralized configuration (for redundant or single-sided configurations).

Expansion units in switched or distributed configurations cannot be used with this subrack.

Module locations

Slot No.	Module Locations									
	PS	CPU	0	1	2	3	4	5	6	IM
PS 951 power supply module										
CPU 942H										
Digital input and output, digital input/output, analog input and output modules (block type: 6ES5 4...-7...)										
Digital input and output, analog input and output modules ¹⁾ (compact modules: 6ES5 4...-4..., 6ES5 466-3LA11)										
Communications processors ²⁾	For slot assignment, see Section 11									
Intelligent I/O modules	For slot assignment, see Section 11									
IM 304 for linking central controllers										
IM 305, IM 306										
IM 324R for linking central controllers										

1) 434-4 digital input module not in slot 6
 2) CP 526 and CP 527 basic boards only

Ordering data

Order No.

CR 700-2 subrack

6ES5 700-2LA12

SIMATIC S5-115U/H/F

Subracks

CR 700-2F subrack for S5-115H central controllers

Application

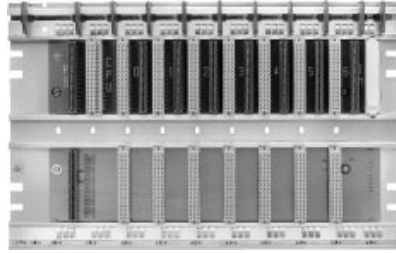

A central controller with up to six I/O modules can be configured with the CR 700-2F subrack. A power supply and CPU module are always required, as well as an IM 304 or IM 324R interface module for linking the two central controllers.

3

Design

Up to three expansion units can be connected in centralized configuration (for redundant or single-channel I/O configurations).

Up to two times four expansion units can be connected in distributed configuration up to 600 m (1968 ft).

Module locations

Slot No.	PS	CPU	0	1	2	3	4	5	6	IM
PS 951 power supply module										
CPU 942H										
Digital input and output, digital input/output, analog input and output modules (block type: 6ES5 4...7....)										
Digital input and output, analog input and output modules (compact modules: 6ES5 4...4...., 6ES5 466-3LA11)										
Communications processors ¹⁾	For slot assignment, see Section 11									
Intelligent I/O modules	For slot assignment, see Section 11									
IM 304 for linking central controllers or for distributed expansion										
IM 305, IM 306										
IM 307										
IM 324R for linking central controllers										

1) CP 526 and CP 527 as basic board only

Ordering data

Order No.

CR 700-2F subrack

6ES5 700-2LA22

SIMATIC S5-115U/H/F

Subracks

CR 700-3 subrack for S5-115H central controllers

Application

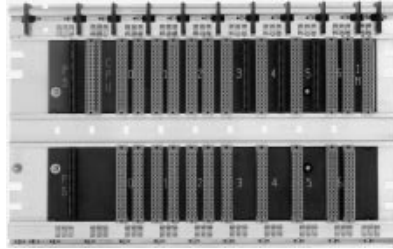

A central controller with up to nine I/O modules can be configured with the CR 700-3 subrack. A power supply and CPU module are always required, as well as an IM 304 or IM 324R interface module for linking the two controllers.

3

Design

Two single-width modules in one adapter casing can be plugged into slots 0, 1, 2 and 6. Where two modules are installed in one casing, a fan subassembly is always required (see page 3/77).

Up to three expansion units can be connected in centralized configuration (for redundant or single-channel I/O configurations).

Up to two times four expansion units can be connected in distributed configuration up to 600 m (1968 ft).
Two interface modules in one adapter casing can be plugged into slot 6.

Module locations

	Slot No.	PS	CPU	0	1	2	3	4	5	6	IM
PS 951 power supply module		■									
CPU 942H			■								
Digital input and output, digital input/output, analog input and output modules (block type: 6ES5 4...-7....)							■	■	■		
Digital input and output, analog input and output modules (compact modules: 6ES5 4...-4...., 6ES5 466-3LA11)				■	■	■	■	■	■		
Communications processors		For slot assignment, see Section 11									
Intelligent I/O modules		For slot assignment, see Section 11									
IM 304 for linking central controllers or for distributed expansion										■	
IM 305, IM 306											■
IM 307				■	■	■	■	■	■	■	
IM 324R for linking central controllers										■	■

Ordering data

Order No.

CR 700-3 subrack

6ES5 700-3LA12

SIMATIC S5-115U/H/F

Subracks

3

ER 701-3LH subrack for I/O modules in switched configuration with S5-115H

Application

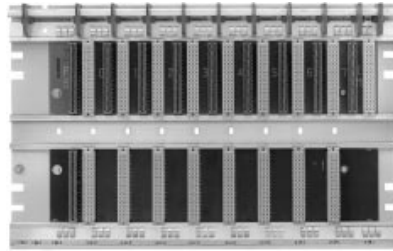

An expansion unit in switched configuration containing up to six I/O modules can be configured with the ER 701-3LH subrack. A power supply module and an IM 306 interface module for address setting are always required.

Design

A switched expansion unit with the ER 701-3LH subrack is connected to the central controllers in distributed configuration via two IM 314R interface modules.

Note on single-sided and two-channel configuration:

The ER 701-2 and ER 701-3 subracks can also be used for single-sided and two-channel configuration for the S5-115H programmable controller.

The possible configurations are the same as those for the S5-115U. For further details of these subracks please see pages 3/65 and 3/66.

Module locations

Slot No.	PS	0	1	2	3	4	5	6	7	IM
PS 951 power supply module										
Digital input and output, digital input/output, analog input and output modules ¹⁾ (block type: 6ES5 4..-7....)										
Digital input and output, analog input and output modules (compact modules: 6ES5 4..-4...., 6ES5 466-3LA11)										
Communications processors	For slot assignment, see Section 11									
Intelligent I/O modules	For slot assignment, see Section 11									
IM 306 (always required)										
IM 314R										

1) except 434-7 digital input module

Ordering data	Order No.
ER 701-3LH subrack	6ES5 701-3LH11

SIMATIC S5-115U/H/F

Subracks

CR 700-OLB subrack for S5-115F central controllers

Application

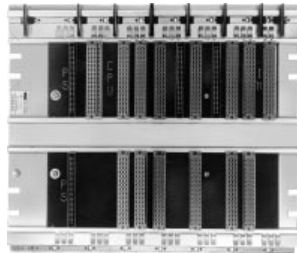

A central controller with up to four I/O modules can be configured with the CR 700-OLB subrack. A power supply and CPU module are always required, as well as an IM 304 or IM 324R interface module for linking the two central controllers.

3

Design

Two communications processors in one adapter casing can be plugged into slot 0, two interface modules in one adapter casing can be plugged into slot 3.

Up to three expansion units can be connected in centralized configuration (for redundant or single-sided configurations).

Up to two times four expansion units (each with three additional EUs in centralized configuration) can be connected in distributed configuration up to 600 m (1968 ft) (for redundant or single-channel I/O configurations).

Module locations

Slot No.	Module Locations						
	PS	CPU	0	1	2	3	IM
PS 951F power supply module							
CPU 942F							
Digital input and output, digital input/output, analog input and output modules (block type: 6ES5 4...7....)							
6ES5 463-4U.12 analog input module, 6ES5 453-4UA12 digital output module (compact modules)							
CP 523 communications processor							
IM 304 for linking central controllers or for distributed expansion							
IM 306							
IM 324 for linking central controllers							

Ordering data

Order No.

CR 700-OLB subrack

6ES5 700-OLB11

SIMATIC S5-115U/H/F

Subracks

3

CR 700-2F subrack for S5-115F central controllers

Application

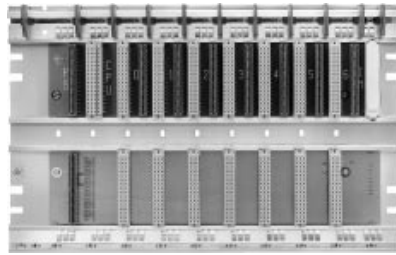

A central controller with up to six I/O modules can be configured with the CR 700-2F subrack. A power supply and CPU module are always required, as well as an IM 304 or IM 324R interface module for linking the two central controllers.

Design

Up to three expansion units can be connected in centralized configuration (for redundant or single-channel I/O configurations).

Up to two times four expansion units (each with three additional EUs in centralized configuration) can be connected in distributed

configuration up to 600 m (1968 ft) (for redundant or single-channel I/O configurations).

Module locations

Slot No.	PS	CPU	0	1	2	3	4	5	6	IM
PS 951F power supply module										
CPU 942F										
Digital input and output, digital input/output, analog input and output modules (block type: 6ES5 4 ...-7)										
6ES5 463-4U.12 analog input module, 6ES5 453-4UA12 digital output module (compact modules)										
CP 523 communications processor										
IM 304 for linking central controllers or for distributed expansion										
IM 306										
IM 324 for linking central controllers										

Ordering data	Order No.
CR 700-2F subrack	6ES5 700-2LA22

SIMATIC S5-115U/H/F

Subracks

ER 701-1 subracks for S5-115F expansion units

Application



A central controller with up to nine I/O modules can be configured with the ER 701-1 subrack. Power supply by the central controller or an expansion unit with the ER 701-2 or ER 701-3 subrack.

3

Design

An expansion unit with the ER 701-1 subrack must always be connected in centralized configuration.

The IM 306 interface module is required for the expansion unit.

Interrupt processing is not possible in this expansion unit.

Module locations

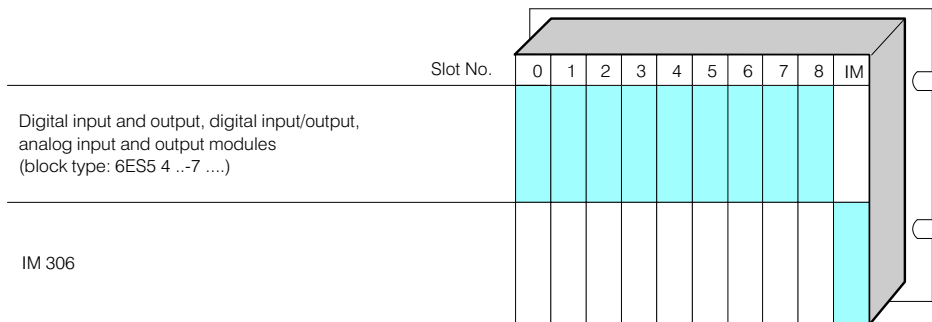

Ordering data

Order No.

ER 701-1 subrack

6ES5 701-1LA12

SIMATIC S5-115U/H/F

Subracks

ER 701-2 subrack for S5-115F expansion units

Application

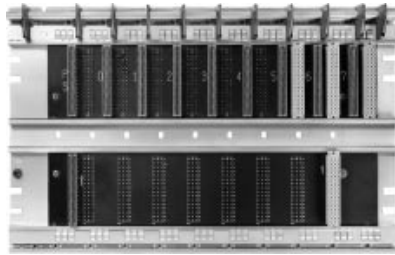

A central controller with up to seven I/O modules can be configured with the ER 701-2 subrack. The IM 306 interface module is always required for address setting.

Design

Expansion units with ER 701-2 subracks can be connected to a central controller or an expansion unit with power supply with the IM 306 interface module in centralized configuration or in distributed configuration with the IM 314 interface module to a central controller.

In centralized configuration, no power supply module must be plugged into the ER 701-2 subrack. In distributed configuration, a power supply module is absolutely necessary.

This subrack makes two-channel, redundant configuration of I/O modules possible (see page 3/16). Interrupt evaluation is not possible in expansion units.

Module locations

	Slot No.	PS	0	1	2	3	4	5	6	7	IM
Power supply module											
Digital input and output, digital input/output, analog input and output modules (block type 6ES5 4 .. -7 ...)											1)
IM 306											
IM 314											

1) Only possible in this slot for centralized links (without power supply in the ER 701-2 subrack).

Ordering data	Order No.
ER 701-2 subrack	6ES5 701-2LA12

SIMATIC S5-115U/H/F

Subracks

ER 701-3 subrack for S5-115F expansion units

Application

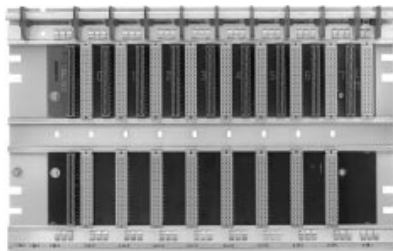

A central controller with up to eight I/O modules can be configured with the ER 701-3 subrack. The IM 306 interface module is always required for address setting.

3

Design

Expansion units with ER 701-3 subracks can be connected to a central controller or an expansion unit with power supply with the IM 306 interface module in centralized configuration or in distributed configuration with the IM 314 interface module to a central controller.

In centralized configuration, no power supply module must be plugged into the ER 701-3 subrack. In distributed configuration, a power supply module is absolutely necessary.

In an expansion unit with this subrack also the 463 analog input module can be plugged in.

This subrack makes two-channel, redundant configuration of I/O modules possible (see page 3/16).

Interrupt evaluation is not possible in expansion units.

Module locations

Slot No.	PS	0	1	2	3	4	5	6	7	IM
Power supply module										
Digital input and output, digital input/output, analog input and output modules ¹⁾ (block type: 6ES5 4 ...-7)										
6ES5 463-4U.12 analog input module ³⁾ , 6ES5 453-4UA12 digital output module (compact modules)										
CP 523 communications processor										
IM 306										
IM 314										

- 1) Except for 434-7LA12 digital input module
- 2) Only possible in this slot for centralized configuration (without power supply in the ER 701-3 subrack).
- 3) In centralized link with ER 701-3 subracks the 463 analog input module must only be used in the central controller and in the first and second expansion unit. Only the 6ES5 705-0AF00 cable (length 0.5 m) may be used for that.

Ordering data

Order No.

ER 701-3 subrack

6ES5 701-3LA13

SIMATIC S5-115U/H/F

Subracks

Fan subassembly

Application



A fan subassembly is required:

- If the power supply module has an output load of more than 7 A
- If several modules are installed in one adapter casing (except for IM 304/IM 308 in one casing)
- If certain modules are used (see Section 11 for further details)

3

Design

The fan subassembly contains two fans, a dust filter and fan monitors with floating contacts.

The fan subassembly and mounting accessories are available in two versions:

- For long subracks (483 mm/19")
- For short subracks (353 mm/14")

The fan subassembly should be installed under the PLC, using the relevant mounting accessories. A wiring duct is supplied along the mounting accessories. The field cables can be run off neatly to the sides in this duct.

Technical specifications

	For long subracks	For short subracks
Supply voltage	115/230 V AC or 24 V DC	115/230 V AC or 24 V DC
Current consumption	0.6/0.3 A or 0.8 A	0.6/0.3 A or 0.8 A
Dimensions (W x H x D) in mm (in)	480 x 172 x 264 (19 x 6.77 x 10.4)	359 x 172 x 264 (14 x 6.77 x 10.4)
Weight		
• Cable duct with mounting brackets	approx. 0.5 kg (1.1 lb)	0.5 kg (1.1 lb)
• Fan subassembly	approx. 1.5 kg (3.3 lb)	1.4 kg (3.3 lb)

Ordering data

Fan subassembly

- 115/230 V AC
- 24 V DC

Mounting accessories

Dust filter (filter mat)

For long subracks
For short subracks

Order No.

6ES5 981-0H 11

6ES5 981-0H 21



6ES5 981-0G 11



6ES5 981-0J 11



A

B

Order No.

Replacement fan

for above fan subassembly, comprising:
1 fan, plug-in connector, replacement instructions

6ES5 988-7NA11

SIMATIC S5-115U/H/F

Power supply modules

PS 951 power supply modules for the S5-115U/H

Application



Power supply modules generate the voltages required by the programmable controller from the external power supply:

- + 5 V**
as supply voltage for all modules;
- + 5,2 V**
as supply voltage for the PG 605 programmer, the OP 393 and OP 396 operator panels and the BT 777 (observe max. current);
- + 24 V**
for the 20 mA current loop interfaces.

3

Design

Power supply modules are available with one or two backup batteries, depending on the model. These can be replaced even when the power supply is switched off. In the case of the power

supply modules with only one backup battery, the backup voltage is supplied via sockets during replacement. In those with two backup batteries, the second battery begins to supply the backup

voltage as soon as the first one fails. This also applies when it is removed for replacement. Five power supply modules are available for the S5-115U/H programmable controller.

Technical specifications

Power supply module	6ES5 951-7LB21	6ES5 951-7LD21	6ES5 951-7NB21	6ES5 951-7ND51	6ES5 951-7ND41
Supply voltage					
• Rated value	230/120 V AC	230/120 V AC	24 V DC	24 V DC	24 V DC
• Ripple V_{pp}	max. —	—	3.6 V	3.6 V	3.6 V
• Permissible range (including ripple)	187 ... 264 V 94 ... 132 V	187 ... 264 V 94 ... 132 V	19.2 ... 30 V	9.2 ... 30 V	9.2 ... 30 V
• Frequency range	47 ... 63 Hz	47 ... 63 Hz	—	—	—
Current consumption					
• Rated value I_N	0.4/0.6 A	0.4/0.6 A	1.5 A	5 A	5.6 A
• Inrush current	max. 0.8/1.4 A	0.8/1.4 A	15 x I_N	15 x I_N	15 x I_N
• I^2t	15 x I_N 15 x I_N 0.2 A ² s 1.8 A ² s	15 x I_N 15 x I_N 0.2 A ² s 1.8 A ² s	0.4 A ² s	16 A ² s	4.5 A ² s
Mains buffering	20 ms	20 ms	20 ms	20 ms	20 ms
Output voltage V_1	+ 5 V ± 1.5 %	+ 5 V ± 1.5 %	+ 5 V ± 1.5 %	+ 5 V ± 1.5 %	+ 5 V ± 1.5 %
Auxiliary voltages					
• V_2 (e.g. for programmers)	+ 5.2 V (1 A)	+ 5.2 V (2.5 A)	+ 5.2 V (1 A)	+ 5.2 V (2.5 A)	+ 5.2 V (2.5 A)
• V_3 (e.g. for CP 525)	+ 24 V (0.2 A)	+ 24 V (0.35 A)	+ 24 V (0.2 A)	+ 24 V (0.35 A)	+ 24 V (0.35 A)
Output current¹⁾					
• Rated value for operation					
Without fan	3 A	7 A	3 A	7 A	7 A
With fan	3 A	15 A	3 A	15 A	15 A
• Permissible range	0.3 ... 3 A	0.3 ... 15 A	0.3 ... 15 A	0.3 ... 15 A	0.3 ... 15 A
Backup battery	1 x lithium battery Size C, (3.6 V/5 Ah)	2 x lithium battery Size AA, (3.6 V/2 x 1.75 Ah)	1 x lithium battery Size C, (3.6 V/5 Ah)	2 x lithium battery Size AA, (3.6 V/2 x 1.75 Ah)	2 x lithium battery Size AA, (3.6 V/2 x 1.75 Ah)
• Backup time	min. 1 year (at 0.3 mA, 25 °C and uninterrupted buffering)				
• External backup voltage	+ 3.4 ... + 9 V				
Short-circuit protection	Electronic				
Open-circuit protection	Yes				
Fuse (primary circuit)	Integral				
Class of protection	Class 1				
Galvanic isolation	Yes	Yes	No	No	Yes
Test voltage	2.5 kV AC	2.5 kV AC	—	—	500 V AC
RI specification	A in acc. with VDE 0871	A in acc. with VDE 0871	A in acc. with VDE 0871	A in acc. with VDE 0871	A in acc. with VDE 0871
Weight	approx. 1.6 kg (3.5 lb)	1.9 kg (4.1 lb)	1.6 kg (3.5 lb)	1.6 kg (3.5 lb)	1.6 kg (3.5 lb)

1) Fan subassembly required for output currents from 7 to 15 A (page 3/77)

SIMATIC S5-115U/H/F

Power supply modules

PS 951 power supply modules for the S5-115U/H (continued)

Ordering data	Order No.	Order No.
<p>PS 951 power supply module for internal power supply of the S5-115U/H (without backup battery) 230/120 V AC; 5 V, 3 A 230/120 V AC; 5 V, 7/15 A¹⁾ 24 V DC; 5 V, 3 A; non-floating 24 V DC; 5 V, 7/15 A¹⁾; non-floating DC 24 V; 5 V, 7/15 A¹⁾; floating Operating instructions included in the S5-115U manual (see page 3/23).</p>	<p>6ES5 951-7LB21 6ES5 951-7LD21 6ES5 951-7NB21 6ES5 951-7ND51 6ES5 951-7ND41</p>	<p>Backup battery, lithium battery Size C, 3.6 V/5 Ah Size AA, 3.6 V/1.75 Ah</p> <p>6EW1 000-7AA 6ES5 980-0AE11</p>

1) Fan subassembly required in the subrack (see page 3/77)

SIMATIC S5-115U/H/F

Power supply modules

3

PS 951 power supply module for the S5-115F

Application



The PS 951 power supply module generates the internal operating voltage of 5 V DC required by the programmable controller from the external power supply 24 V DC. Only the PS 951-7ND41 is approved for the S5-115F failsafe programmable controller.

Moreover, the module makes backup supply of the RAM modules of the CPU possible. Two backup batteries are installed for that in the PS 951-7ND41. These can be replaced even when the power supply is switched off. The second battery begins to supply the backup voltage as soon as the first one fails or is removed for replacement.

Design

The PS 951 power supply module is potential-isolated and is suitable for applications

where the input circuit of the I/O modules is operated without ground connection.

The lines with the supply voltage are connected to the bottom of the power supply module with the help of screw terminals.

Technical specifications

Supply voltage

• Rated value		24 V DC
• Ripple V_{pp}	max.	3.6 V
• Permissible range (including ripple)		19.2 ... 30 V

Current consumption

• Rated value I_N		5.6 A
• Inrush current	max.	$15 \times I_N$
• $I^2 t$		4.5 A ² s
Mains buffering		20 ms
Output voltage V_1		+ 5 V \pm 1.5 %
Auxiliary voltage		
• V_2 (e.g. for programming devices)		+ 5.2 V (2.5 A)
• V_3 (e.g. for CP 525)		+ 24 V (0.35 A)

Output current

• Rated value for operation			
Without fan			7 A
With fan			15 A
• Permissible range			0.3 ... 15 A
Backup battery			2 x lithium battery Size AA, (3.6 V/2 x 1.75 Ah)
• Backup time	min.		1 year (at 0.3 mA, 25 °C and uninterrupted buffering) + 3.4 ... + 9 V
• External backup voltage			Electronic Yes Integral Class 1
Short-circuit protection			Yes
Open-circuit protection			Yes
Fuse (primary circuit)			Class 1
Class of protection			Yes
Galvanic isolation			500 V AC
Test voltage			A in acc. with VDE 0871
RI specification			
Weight	approx.		1.9 kg (4.1 lb)

Ordering data

	Order No.		Order No.
PS 951 power supply module for S5-115F for internal power supply (without backup battery) 24 V DC; 5 V, 7 A; non-floating	6ES5 951-7ND41	Backup battery (lithium battery) Size AA, 3.6 V/1.75 Ah	6ES5 980-0AE11

SIMATIC S5-115U/H/F

Interface modules

Interface modules

Overview

The following table shows the interface modules and connecting cables required to link the various expansion units to the central controllers.

Configuration/ Transmission mode	Central controller		Expansion unit			Connecting cable
	PLC type	Type of interface	EU type for S5-115U/H/F	EU type for S5-135U, S5-155U/H	Type of interface	Type Length
Centralized up to 2 m, asymmetric	S5-115U S5-115H ¹⁾	IM 305	ER 701-0 ER 701-1		IM 305	Permanently connected 0.5 m (1.6 ft) or 1.5 m (5 ft)
	S5-115U S5-115H ¹⁾ S5-115F ⁴⁾	IM 306	ER 701-0 ER 701-1		IM 306	705-0 0.5 m (1.6 ft) ... 2.5 m (8.2 ft)
Distributed up to 200 m, symmetric	S5-115U S5-115H ¹⁾	IM 301 (see Section 4)	ER 701-2 ²⁾ ER 701-3 ²⁾	EG 183U	IM 310 (see Section 4)	721-0 0.5 m (1.6 ft) ... 200 m (656 ft)
Distributed up to 600 m symmetric	S5-115U S5-115H ¹⁾ S5-115F	IM 304	ER 701-2 ²⁾ ER 701-3 ²⁾	EG 183U EG 185U	IM 314	721-0 1 m (3.28 ft) ... 600 m (1968 ft)
	S5-115H ³⁾	IM 304	ER 701-3LH ²⁾	EG 185U	IM 314R	721-0 1 m (3.28 ft) ... 600 m (1968 ft)
Distributed 50 ... 1500 m (between every 2 modules), serial optical	S5-115U	IM 307	ER 701-2 ²⁾ ER 701-3 ²⁾	EG 183U EG 185U	IM 317	722-2 (fiber optic cable)
			ER 701-3 ²⁾		IM 307	
Distributed up to 3000 m, serial electrical	S5-115U	IM 308	ER 701-2 ²⁾ ER 701-3 ²⁾	EG 183U EG 185 U	IM 318-3	Shielded twisted two-wire cable (on request)
			ET 100U		IM 318-8	
Distributed up to 23 km, serial electrical or optical	S5-115U S5-115H ¹⁾	IM 308-B	ET 200U		IM 318-B/C	Shielded twisted two-wire cable (on request) or fiber optic cable

1) S5-115H with two-channel I/O modules (fully redundant configuration) or single-channel/single-sided I/O configuration

2) An IM 306 interface module is required for setting the addresses of modules of block design

3) S5-115H with single-sided I/O (switched)

4) The 463 analog input module can only be used in the 1st and 2nd EU and only with a 0.5 m (1.6 ft) cable.

SIMATIC S5-115U/H/F

Interface modules

IM 305 and IM 306 interface modules; centralized configuration with S5-115U

Application



The IM 305 and IM 306 interface modules enable expansion units (EUs) to be connected in centralized configuration. The IM 305 interface module is used for connecting one expansion unit to the central controller.

The IM 306 interface module can be used for connecting up to three expansion units to the central controller (CC) or to an expansion unit with a power supply module.

3

Design

IM 305 interface module

The IM 305 interface module consists of two modules which are permanently connected by a cable (0.5 or 1.5 m (1.5 ft or 4.7 ft) long). It provides the expansion unit (in an ER 701-0 or ER 701-1 subrack) with the supply voltage and the signals from the internal bus. The expansion unit must be positioned either above the central controller or (with a 1.5 m (4.7 ft) cable) adjacent to it. In this configuration, the addresses for the input and output modules are permanently assigned to the slots. For example, slot 0 in the central controller is reserved for byte addresses 0 to 3 (binary signals 0.0 to 3.7, inputs or outputs) and slot 3 for byte addresses 12 to 15.

IM 306 interface module

One IM 306 interface module must be plugged into the central controller and one into an expansion unit connected in centralized configuration (in an ER 701-0 or ER 701-1 subrack). It is also used in expansion units connected in a distributed configuration (in an ER 701-2 or ER 701-3 subrack) for setting the addresses of the I/O modules of block design. The IM 306 provides the expansion units with the supply voltage and the signals from the internal bus. The cable length from the central controller to the last expansion unit can be up to 2.5 m (8 ft). The minimum vertical clearance between two units is 100 mm (4").

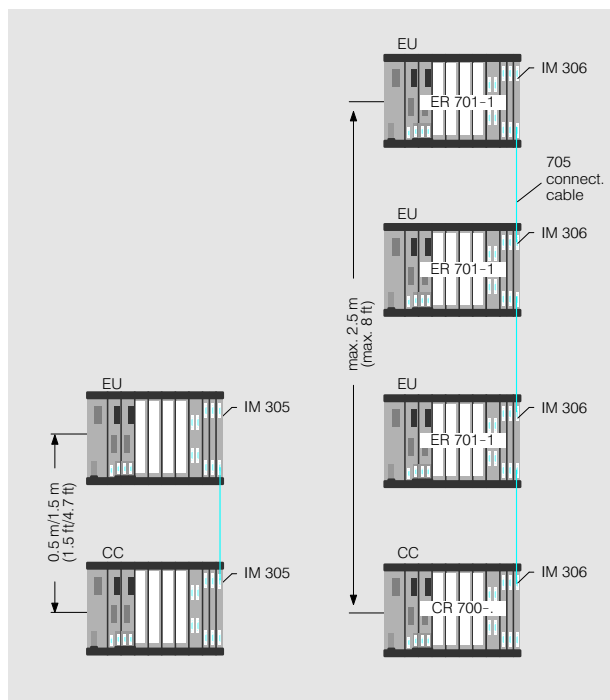

Fig. 3/33 Connection of expansion units to the central controller in centralized configuration using IM 305 (left) and IM 306 (right) interface modules

In this configuration, the addresses for the input and output modules must be assigned to the slots using DIL switches on the IM 306 interface module. The fixed address assignments do not apply. Inputs and outputs can have the same address.

The IM 306 interface module is also required for the ER 701-2 and ER 701-3 subracks if they contain I/O modules of block design (6ES5 4..-7.).

Expansion units in the ER 701-0 and ER 701-1 subracks can also be connected in a centralized configuration to the S5135U and S5-155U programmable controllers (see Section 4) using the IM 306 interface module. An IM 300-5LB interface module must be plugged into the central controller for this purpose.

SIMATIC S5-115U/H/F

Interface modules

IM 305 and IM 306 interface modules; centralized configuration with S5-115U (continued)

Technical specifications

IM 305 interface module

Current supplied to EU	max.	1 A
Current consumption (at 5V)		10 mA
Power loss	max.	0.05 W
Weight (total)	approx.	0.6 kg (1.3 lb)

IM 306 interface module

Current supplied to EU	max.	2 A
Current consumption (at 5V)		50 mA
Power loss	max.	0.25 W
Weight	approx.	0.3 kg (0.6 lb)

3

Ordering data

IM 305 interface module

for S5-115 U/H
With 0.5 m (1.5 ft) cable
With 1.5 m (4.7 ft) cable

6ES5 305-7LA11

6ES5 305-7LB11

IM 306 interface module

for S5-115U/H/F
Operating instructions included
in the S5-115U manual
(see page 3/23).

6ES5 306-7LA11

705 connecting cable

for connecting IM 306 to IM 306
or IM 300-5LB interface modules
to IM 306

Length	0.5 m (1.6 ft)
	1.25 m (4.1 ft)
	1.5 m (4.9 ft)
	2.5 m (8.2 ft)

6ES5 705-0AF00

6ES5 705-0BB20

6ES5 705-0BB50

6ES5 705-0BC50

SIMATIC S5-115U/H/F

Interface modules

IM 304 and IM 314 interface modules; distributed configuration up to 600 m with S5-115U

Application

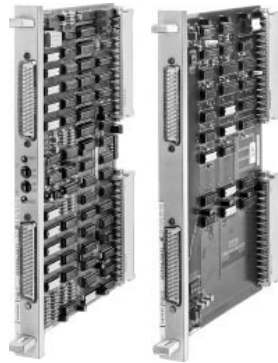

The IM 304 and IM 314 interface modules are used for distributed configuration of expansion units (EUs) with a central controller (CC). The expansion units can be up to 600 m (1969 ft) away from the central controller.

3

Design

The IM 304 interface module is plugged into the central controller (CR 700-0LB, CR 700-2 and CR 700-3 subracks) and the IM 314 interface module into the expansion unit (ER 701-2 and ER 701-3 subracks).

Up to two times four expansion units (with power supply module) can be connected in distributed configuration to one IM 304 interface module.

The central controller and the distributed expansion units can be expanded with up to three additional expansion units (ER 701-0 and ER 701-1 subracks) connected in a centralized configuration.

An IM 306 interface module must be plugged into each expansion unit to enable the addresses for the input and output modules to be assigned to the slots. This interface module is required even if no additional expansion unit is connected.

Up to four areas of 256 bytes each in the S5-115U programmable controller can be addressed with an IM 304 interface module. The areas can be set with a switch on the IM 314 interface module.

A terminator must always be inserted in the last IM 314 interface module.

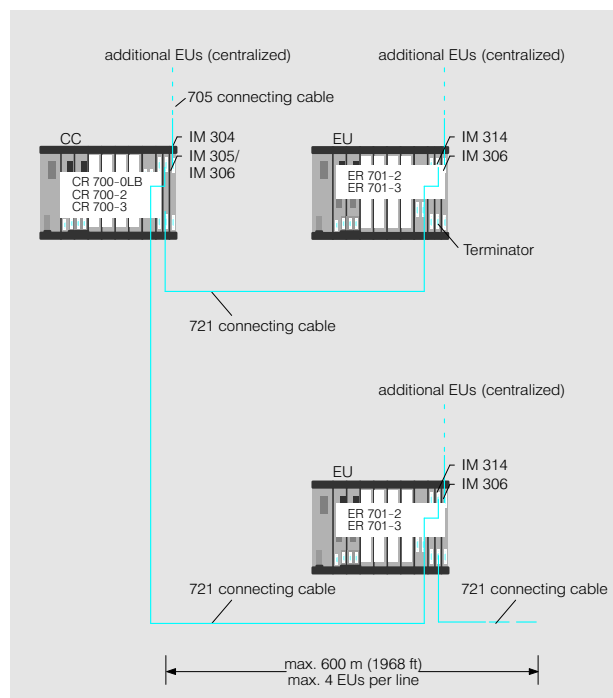

Fig. 3/34 Connection of expansion units to the central controller in distributed configuration using IM 304 and IM 314 interface modules

Connection of other programmable controllers

Expansion units in ER 701-2 and ER 701-3 subracks can also be connected to the S5-135U and S5-155U programmable controllers using the IM 304 and IM 314 interface modules (see Section 4).

These two interface modules can also be used for connecting the EU 183U and EU 185U expansion units to the S5-115U programmable controller.

Adapter casing required (page 3/98)

SIMATIC S5-115U/H/F

Interface modules

IM 304 and IM 314 interface modules; distributed configuration up to 600 m (1968 ft) with S5-115U (continued)

Technical specifications

Current consumption (at 5 V)			Space requirements		1/2 slot or 1 slot (see subracks, page 3/58f.)
• IM 304	max.	1.5 A			
• IM 314	max.	1.0 A	Weight	approx,	0.3 kg (0.6 lb)
Power loss					
• IM 304	max.	7.5 W			
• IM 314	max.	5 W			

3

Ordering data

	Order No.		Order No.
IM 304 interface module for the central controller of an S5-115U/H/F	6ES5 304-3UB11	Terminator for IM 314 interface module	6ES5 760-1AA11
IM 314 interface module for the expansion unit of an S5-115U/H/F	6ES5 314-3UA11	Adapter casing	see page 3/98
Operating instructions included in the S5-115U manual (see page 3/23).		721 connecting cable	
		Standard lengths	1 m (3.2 ft) 1.6 m (5.2 ft) 2 m (6.5 ft) 5 m (16.4 ft) 10 m (32.8 ft) 50 m (164.0 ft)
		Special lengths	2.5 m (8.2 ft) 3.2 m (10.5 ft) 8 m (26.2 ft) 12 m (39.3 ft) 16 m (52.5 ft) 20 m (65.6 ft) 25 m (82.0 ft) 32 m (105.0 ft) 40 m (131.2 ft) 63 m (206.6 ft) 80 m (262.4 ft) 100 m (328.0 ft) 500 m (1640.4 ft)
			6ES5 721-0BB00 6ES5 721-0BB60 6ES5 721-0BC00 6ES5 721-0BF00 6ES5 721-0CB00 6ES5 721-0CF00 6ES5 721-0BC50 6ES5 721-0BD20 6ES5 721-0BJ00 6ES5 721-0CB20 6ES5 721-0CB60 6ES5 721-0CC00 6ES5 721-0CC50 6ES5 721-0CD20 6ES5 721-0CE00 6ES5 721-0CG30 6ES5 721-0CJ00 6ES5 721-0DB00 6ES5 721-0DF00

SIMATIC S5-115U/H/F

Interface modules

IM 308 and IM 318 interface modules; distributed configuration up to 3000 m with S5-115U

Application



The IM 308 and IM 318 interface modules are used for connecting I/O modules in the following expansion units (EUs) to a central controller (CC) in distributed configuration:

- ER 701-2
- ER 701-3
- EG 183U
- EG 185U

The ET 100U electronic terminator (see Section 6) can also be connected.

The expansion units and the ET 100U electronic terminator can be up to 3000 m (9900 ft) away from the central controller.

3

Design

The IM 308 interface module is plugged into the central controller and the IM 318-3 interface module into the expansion unit or the IM 318-8 interface module into the ET 100U electronic terminator.

Two lines, each containing up to 32 expansion units (with IM 318-3) or electronic terminators (with IM 318-8) in any order can be connected to one IM 308 interface module. A total of 63 expansion units and ET 100U electronic terminators can operate via one IM 308 interface module. Digital and analog I/Os, intelligent I/O modules and communications processors with linear addressing can be used in the expansion units.

The central controller and distributed expansion units (ER 701-2 and ER 701-3 sub-racks) can be expanded with up to three additional expansion units in centralized configuration.

A memory submodule with the address list for the IM 308 interface module is only required for connecting ET 100U electronic terminators.

In the S5-115U programmable controller up to four areas of 256 bytes each can be addressed with an IM 308 interface module. These areas can be set with a switch on the IM 318 interface module.

The central controller and the expansion units or electronic terminators are isolated from one another.

Cables

The interface modules must be connected via two-core cables. They are supplied together with connectors for connecting the cables using screw terminals. The connectors are provided with screw terminals for the incoming and the outgoing line.

A terminating resistor (120 Ω ; supplied with the IM 308 interface module) must be fitted to the connector of the last IM 318 in place of the outgoing line. An expansion unit can be switched off without affecting the operation of the other units.

Selecting the cables:

Shielded, twisted two-core cables are to be used. The resistance of a core must not exceed 50 Ω , irrespective of the cable length. The surge impedance should be around 120 Ω . The capacity per unit length must be as low as possible (<60 pF/m). The bottom table shows two types of cables that can be used.

Adapter casing required (page 3/98)

Type of cable	Transmission speed		
	Distance 500 m/1640	1000 m/3280 ft	3000 m/9840 ft
Siemens control cable type A ¹⁾ 6XV1 830-0AH10	375 kbit/s	187 kbit/s	—
Siemens control cable type B V45551-F21-B5 (1.5 mm ² , paired)	187 kbit/s	62 kbit/s	31 kbit/s

1) Available by the meter

SIMATIC S5-115U/H/F

Interface modules

IM 308 and IM 318 interface modules; distributed configuration up to 3000 m with S5-115U (continued)

Design (continued)

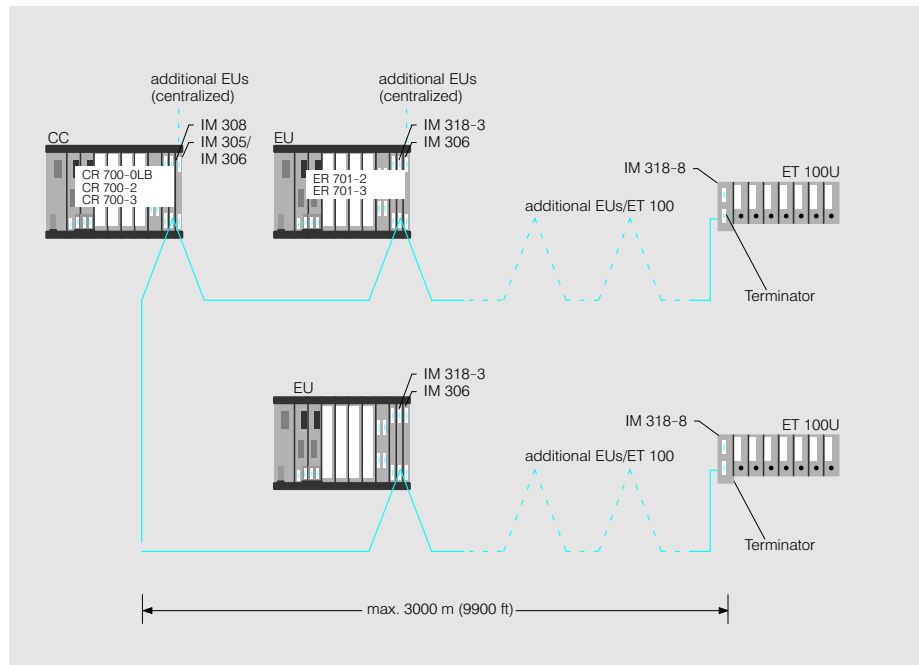

Fig. 3/37 Connection of expansion units and ET 100U electronic terminators to the central controller in distributed configuration using IM 308 and IM 318 interface modules

Technical specifications

Transmission speed (selectable)	31, 62, 187 or 375 kbit/s	Power loss	
Number of units that can be connected		• IM 308	max. 2.5 W
• Per connection	max. 32	• IM 318-3	max. 1.5 W
• Total	max. 63	Space requirements	1 slot or 1/2 slot (see subracks, starting page 3/58)
Addressing range for I/O modules	max. 1 Kbyte	Weight	approx. 0.4 kg (0.9 lb)
Current consumption (at 5 V)			
• IM 308	max. 0.5 A		
• IM 318-3	max. 0.3 A		

Ordering data

	Order No.		Order No.
IM 308 interface module for the S5-115U central controller	6ES5 308-3UA12	IM 318-8 interface module for the ET 100U electronic terminator	6ES5 318-8MA12
376 memory submodule (EPROM) for storing the address list for the ET 100U (not required for other expansion units); to be plugged into the IM 308	6ES5 376-1AA11	Adapter casing To be ordered as a separate item: IM 308/IM 318 manual	see page 3/98
IM 318-3 interface module for the EG 183U, EG 185U, ER 701-2 and ER 701-3 expansion units	6ES5 318-3UA11	German	6ES5 998-2DP11
		English	6ES5 998-2DP21
		French	6ES5 998-2DP31

SIMATIC S5-115U/H/F

Interface modules

3

IM 308-C interface module; PROFIBUS-DP interface for the S5-115U/H (up to S5-155U/H)

Application



The IM 308-C is a PROFIBUS-DP master and/or slave module for SIMATIC S5-115U/H up to S5-155U/H.

Up to 122 passive users like, for example, ET 200 distributed I/O devices, the S5-95U/DP programmable controller or field devices with PROFIBUS-DP interface can be connected to an IM 308-C interface module.

Design

The IM 308-C interface module must be plugged into the slot designed for it in the S5-115U/H up to S5-155U/H programmable controller.

The module needs a single-width slot.

The connection to the PROFIBUS LAN is made via

- a RS 485 bus interface plug or
- a RS 485 bus terminal

Adapter casing required (page 3/98)

Principle of operation

As master module, the IM 308-C interface module coordinates the bus access and the data transfer to the PROFIBUS-DP.

It can also operated as PROFIBUS-DP slave and thus makes data exchange with other PROFIBUS-DP masters possible.

The master and slave function can be used in combination, i.e. as a slave, an IM 308-C interface module receives data from another programmable controller and simultaneously works as master of e.g. ET 200 I/O components.

- Global control: Sync, Freeze of I/O devices
- Address volume: 13 Kbyte data from the CPU can be addressed per IM 308-C
- Shared inputs: the inputs of a slave can be read by several IM 308-C interface modules

Configuring

Configuring takes place with the COM ET 200 Windows configuring package (see Section 9).

Technical specifications

Transfer rate	9.6 kbit/s up to 12 Mbit/s	Permissible environmental conditions	
Interfaces			
• Connection to PROFIBUS	9-pin Sub D socket	• Operating temperature	0 °C to +60 °C
Supply voltage	+5 V DC via backplane bus	• Transport/storage temperature	-40 °C to +70 °C
Current consumption	max. 0.6 A at +5 V DC	• Relative humidity	5 to 95 %
Address volume	13 Kbyte for inputs, outputs and diagnostics	Mechanical design	
Number of I/O devices which can be connected	max. 122 ET 200 U/B/C, S5-95U/DP and/or other field devices	• Module format	Double eurocard
Data volume	244 byte inputs and outputs per slave	• Dimensions (W × H) in mm	160 × 233.4
		• Weight approx.	0.5 kg
		• Space requirements	1 slot

Ordering data

	Order No.		Order No.
IM 308-C interface module for connecting the SIMATIC S5-115U/H, S5-135U, S5-155U/H to PROFIBUS-DP, with memory card (256 Kbyte)	6ES5 308-3UC11	Memory card 256 Kbyte EPROM 1 Mbyte EPROM	6ES5 374-1FH21 6ES5 374-1KK21

SIMATIC S5-115U/H/F

Interface modules

IM 304 and IM 324R interface modules, for interfacing the S5-115H central controllers

Application



The IM 324R and IM 304 interface modules are used for linking the two central controllers of an S5-115H failsafe programmable controller.

3

Design

The IM 324R interface module is plugged into the first central controller (subunit A) and the IM 304 interface module into the second central controller (subunit B). The two interface modules are connected via a 721 connecting cable (up to 100 m (328 ft)). The IM 324R interface module has two memory areas where the necessary process data for data communications between the two central controllers is stored.

Adapter casing required
(page 3/98)

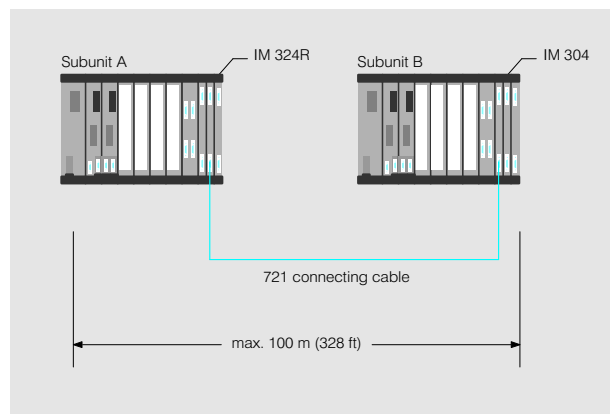

Fig. 3/38 Interfacing of central controllers

Principle of operation

The IM 324R and IM 304 interface modules handle all data communications between the

two central controllers of the failsafe programmable controller.

Technical specifications

Current consumption (at 5 V)

• IM 304	max.	1.5 A
• IM 324R	max.	1.0 A

Power loss

• IM 304	max.	7.5 W
• IM 324R	max.	5 W

Space requirements

Weight approx. 1 slot or 1/2 slot

0.3 kg (0.66 lb)

Ordering data

Order No.

Order No.

IM 304 interface module

for linking the central controllers of the S5-115H programmable controller

6ES5 304-3UB11

Adapter casing

see page 3/98

721 connecting cable

see page 3/83

IM 324R interface module

for linking the central controllers of the S5-115H programmable controller

6ES5 324-3UR11

SIMATIC S5-115U/H/F

Interface modules

IM 304 and IM 314R interface modules, for distributed configuration of I/O modules at S5-115H

Application

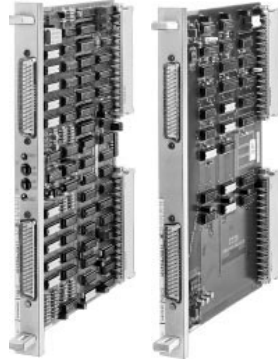

The IM 314R and IM 304 interface modules are used for connection of I/O modules to the S5-115H failsafe programmable controller in a single-channel switched configuration.

3

Design

An IM 304 interface module is plugged into each of the two central controllers. Two IM 314R interface modules are plugged into each expansion unit. The interface modules must be interconnected via 721 connecting cables (up to 600 m (1968 ft)). A terminator must be plugged into the last interface module in each chain.

A maximum of two chains, each with up to four expansion units, can be connected to the central controllers, i.e. a total of eight expansion units.

The IM 306 interface module can also be used for connecting additional expansion units to each of the expansion units connected in switched configuration. Moreover, all other interface modules of the S5-115U programmable controller can be used in the S5-115H failsafe programmable controller.

Adapter casing required
(page 3/98)

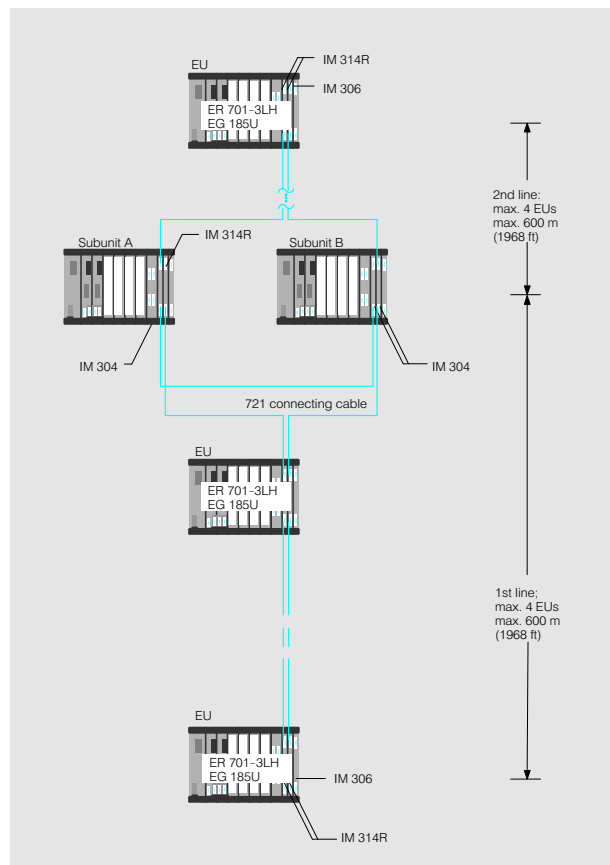

Fig. 3/39 Distributed switched configuration of I/O modules

Technical specifications

	IM 304	IM 314R		
Current consumption (at 5 V)	max. 1.5 A	1.0 A	Space requirements	1 slot or 1/2 slot
Power loss	max. 7.5 W	5 W	Weight	approx. 0.3 kg (0.66 lb)

Ordering data

	Order No.		Order No.
IM 304 interface module for the S5-115H programmable controller	6ES5 304-3UB11	Terminator for the IM 314R	6ES5 760-0HA11
IM 314R interface module for the expansion unit	6ES5 314-3UR11	Adapter casing	see page 3/98
		721 connecting cable (up to 600 m (1968 ft))	see page 3/85

SIMATIC S5-115U/H/F

Interface modules

IM 304 and IM 324 interface modules; for interfacing the S5-115F central controllers

Application

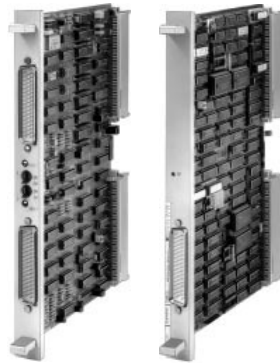

The IM 324 and IM 304 interface modules are used for linking the two central controllers of an S51-115F failsafe programmable controller.

3

Design

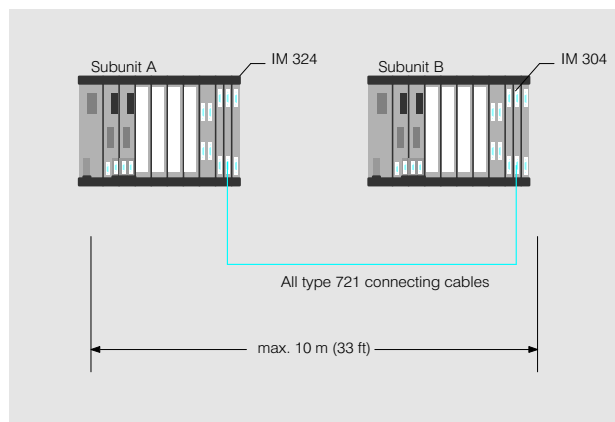

Fig. 3/40 Interfacing of central controllers

The IM 324 interface module is plugged into the first central controller (subunit A) and the IM 304 interface module into the second central controller (subunit B). The two interface modules are connected via a 721 connecting cable (up to 10 m (33 ft)). The IM 324 interface module has two memory areas with a capacity of 2 K words each where the necessary process data for data communications between the two central controllers is stored.

Technical specifications

Current consumption (at 5 V)

• IM 304	max.	1.5 A
• IM 324	max.	1.0 A

Power loss

• IM 304	max.	7.5 W
• IM 324	max.	5 W

Weight

approx. 0.3 kg (0.66 lb)

Ordering data

Order No.

Order No.

IM 304 interface module

for linking the central controllers of the S5-115F programmable controller

6ES5 304-3UB11

Adapter casing

721 connecting cable

6ES5 491-0LB11

see page 3/85

IM 324 interface module

for linking the central controllers of the S5-115F programmable controller

6ES5 324-3UA12

Operating instructions included in the S5-115F manual (see page 3/29)

SIMATIC S5-115U/H/F

Interface modules

IM 306 interface module; for centralized configuration of I/O modules at S5-115F

Application



The IM 306 interface module is used for connecting up to three expansion units in a centralized configuration to a central controller or distributed expansion unit.

3

Design

The ER 701-1, ER 701-2 and ER 701-3 subracks, without power supply modules, can be used for the expansion units. The IM 306 interface module must be plugged into the central expansion units and into the central controller or distributed expansion unit. The interface modules are connected via a 705 connecting cable.

Note

When the 6ES5 463-4U.12 analog input module is used, only cable 6ES5 705-0AF00 (length 0.5 m (1.5 ft)) may be used for connecting the expansion units.

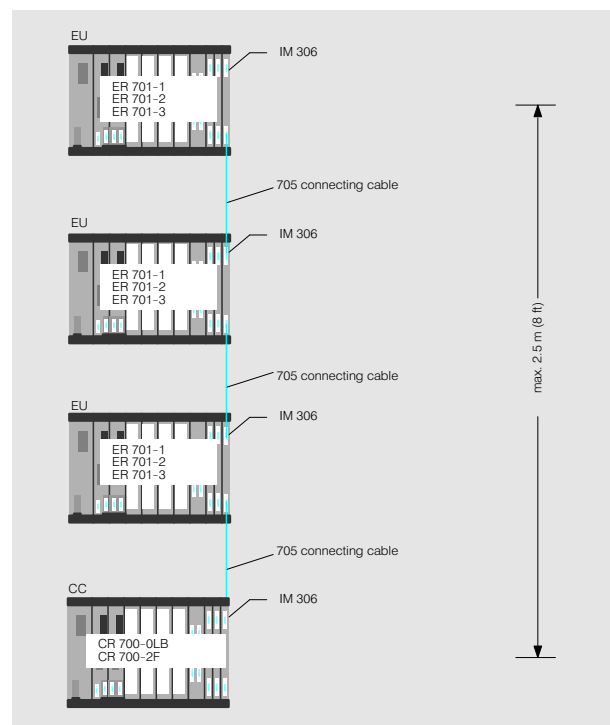

Fig. 3/41 Central configuration of expansion units with IM 306 (1 subunit)

Principle of operation

The IM 306 interface modules handle all data communications between the connected central controller and expansion units. The addresses to the input and output modules

must be allocated to the slots of the subrack using the DIP switches on the IM 306 interface module. It is possible for inputs and outputs to have the same addresses.

For technical data, see page 3/83.

Ordering data	Order No.	Order No.
IM 306 interface module Operating instructions included in the S5-115F manual (see page 3/29).	6ES5 306-7LA11	705 connecting cable between IM 306 and IM 306
		Length 0.50 m (1.5 ft) 1.25 m (3.9 ft) 1.50 m (4.7 ft) 2.50 m (8.2 ft)
		6ES5 705-0AF00 6ES5 705-0BB20 6ES5 705-0BB50 6ES5 705-0BC50

SIMATIC S5-115U/H/F

Interface modules

IM 304 and IM 314 interface modules for distributed configuration of I/O modules at S5-115F

Application

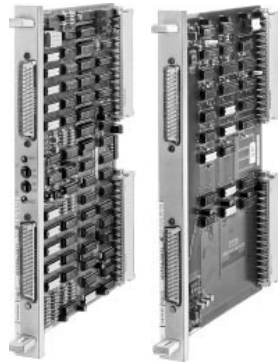

The IM 314 and IM 304 interface modules are used for connection of expansion units to the S5-115F failsafe programmable controller in a distributed configuration.

3

Design

The ER 701-1 and ER 701-3 subracks, without power supply modules, can be used for the expansion units. The IM 304 interface module is plugged into the central controller and the IM 314 interface module into the expansion unit. The interface modules must be interconnected via type 721 connecting cables (max. 600 m (1968 ft)). A terminator must be plugged into the last interface module in each chain.

Up to two chains with an expansion unit in direct configuration each or 3 expansion units in centralized configuration via an IM 306 3 interface module each can be connected. A total of 8 expansion units can be connected.

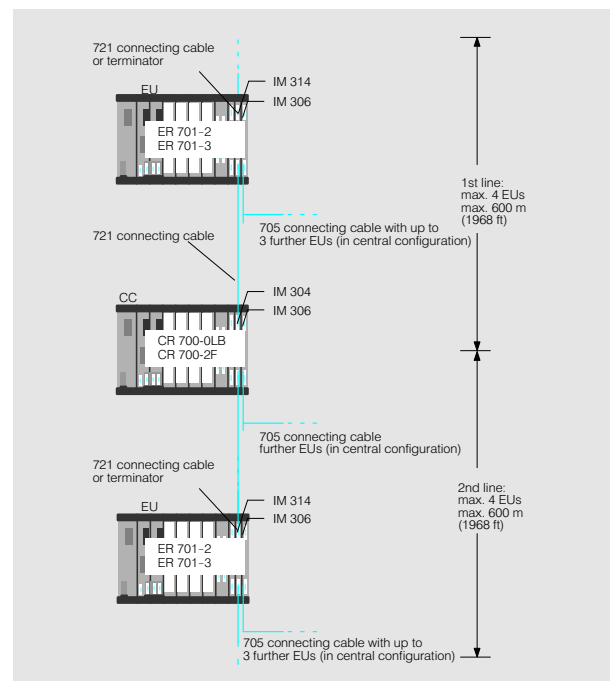

Fig. 3/42 Distributed configuration of expansion units

Principle of operation

The IM 314 and IM 304 interface modules handle all data communications between the central controller and the expansion unit and between the expansion units.

An IM 306 interface module must be plugged into each central controller and expansion unit to enable addresses for the input and output modules to be allocated to the slots of the subracks.

This interface module is still required if no additional expansion units are to be connected. For technical data, see page 3/85.

Ordering data

Order No.

IM 304 interface module
for the central controller

6ES5 304-3UB11

IM 314 interface module
for the expansion unit

6ES5 314-3UA11

Operating instructions included
in the S5-115F manual
(see page 3/28)

**Terminator for IM 314 interface
module**

Adapter casing
721 connecting cable

Order No.

6ES5 760-1AA11

see page 3/98

see page 3/85

SIMATIC S5-115U/H/F

Supplementary equipment

Front connector

Application

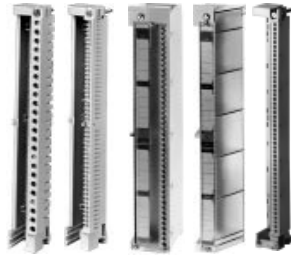

Front connectors are required for connecting signal leads to input and output modules. They simplify the installation and, if necessary, replacement of modules.

490 front connectors are suitable for all modules of block design and 497 front connectors for compact modules used in the S5-115U in adapter casings.

3

Design

Modules can be connected by the following methods:

- Screw terminals (end sleeves not required)
- Crimp terminals
- Snap-on clip terminals (490 front connector only)

The front connectors are hooked onto the module at the bottom and screwed down at the top. Each front connector has a duct for the signal leads, thus enabling the 490 front connector to be completely covered by the module frontplate.

Individual leads can be removed with the front connector in place. For the duplication of connections (e.g. incoming feeders) in 490 front connectors with screw terminals, the 763 bridge jumper is available.

Technical specifications

Front connector	6ES5 490-7LB11	6ES5 490-7LB21	6ES5 490-7LA..	6ES5 490-7LC11	6ES5 497- ...
Connectors	Screw terminals 24-pin	Screw terminals 46-pin	Crimp terminals 46-pin	Snap-on clip terminals 46-pin	see Section 4
Wire cross-section for stranded conductors	1 x (1.0 ... 2.5) mm ² or 2 x (0.5 ... 2.5) mm ²	1 x (0.5 ... 2.5) mm ² or 2 x (0.5 ... 1) mm ² or max. 1.5 mm ² with bridge jumper	1 x (1.0 ... 2.5) mm ² or 2 x (0.5 ... 0.75) mm ²	1 x (0.25 ... 1.5) mm ² or max. 1.5 mm ² with conductors com- bined in an end sleeve	
Duct:					
• Cross-section	approx. 470 mm ² (729 in ²)				
• Number of leads					
2.5 mm ² cross-section	max. 24				
1.5 mm ² cross-section	max. 36				
1.0 mm ² cross-section	max. 48				
Weight	approx. 0.18 kg (0.3 lb)	0.22 kg (0.4 lb)	0.11 kg (0.2 lb)	0.15 kg (0.3 lb)	

Ordering data

	Order No.		Order No.
490 front connector For screw terminals		K front connector for 466-3LA11 analog input module	
• 24-pin	6ES5 490-7LB11	For screw terminals	6XX3 081
• 46-pin	6ES5 490-7LB21	single-width, 43-pin	
For crimp terminals, 24/46-pin		For crimp terminals	6XX3 068
• With 50 crimp contacts	6ES5 490-7LA11	single-width, 43-pin	
• Without crimp contacts	6ES5 490-7LA21	Crimp contacts	6XX3 070
For snap-on clip terminals, 46-pin	6ES5 490-7LC11	1 package contains 250 contacts	
763 bridge jumper for use with screw terminal 490 front connector; 1 package contains 10 jumpers	6ES5 763-7LA 11	Crimping tool for crimping the crimp contacts	6XX3 071
497 front connector for 463-4 analog input module	see Section 4	Extraction tool for crimp contacts (for S5-115U modules)	6ES5 497-8MA11
		Labelling strips for the front cover; 1 sheet contains 6 strips	6ES5 497-7LA11

SIMATIC S5-115U/H/F

Supplementary equipment

Adapter casings

Application



Compact modules (ES 902 design) can also be used in the S5-115U/H/F programmable controller with adapter casings.

The casings protect the modules against environmental effects. They are mounted on the rack in block design as the other modules.

3

Technical specifications

Adapter casing	6ES5 491-0LB11	6ES5 491-0LD11	6ES5 491-0LC11
Width	Single-width	Double-width	Triple-width
Number of accommodated compact modules	2	4	6
Dimensions (W x H x D) in mm	43 x 303 x 187	86 x 303 x 187	129 x 303 x 187
Weight	0.45 kg	0.8 kg	1.8 kg
For use in subracks	CR 700-0 CR 700-1 CR 700-2 CR 700-3 ER 701-2 ER 701-3	CR 700-0LB CR 700 700-2 CR 700-3 ER 701-3	CR 700-0LB CR 700 700-2 CR 700-3 ER 701-3

Ordering data

Order No.

Adapter casing

with 1 protective cover

- Single-width, for up to 2 compact modules
- Double-width, for up to 4 compact modules
- Triple-width, for up to 6 compact modules

6ES5 491-0LB11**6ES5 491-0LD11****6ES5 491-0LC11**

SIMATIC S5-115U/H/F

Supplementary equipment

Text Display TD 390

Application



The TD 390 text display is a compact text display unit for SIMATIC S5 systems. Its small dimensions enable it to be installed where space is limited.

The TD 390 can be used with the

- S5-90U, S5-95U/F, S5-100U
- S5-115U and
- S5-135U, S5-155U/H

programmable controllers.

Text can be displayed in standard mode (one line, 20 characters) or extended mode (two lines, 40 characters).

The TD 390 provides the following functions:

- Display of up to 120 texts with or without variables
- Display and setting of time-of-day and prompter interval
- Operating hours counter (display and reset)
- Display and modification of 24 timer or counter values and 24 other process values as required.

3

Design

The TD 390 text display is connected to the programmable controller direct via the programmer interface of the CPU. It can be installed directly in a cabinet door or control panel without a special mounting frame.

The TD 390 comprises:

- Two-line display panel (LCD)
- Three membrane keys.

A cable for connection to the CPU of the programmable controller (5 m/16 ft.) and a cable for the 24 V power supply (5 m/16 ft.) are also supplied with the unit.

Application

For the time-of-day, prompter interval and operating hours counting the TD 390 accesses the relevant function in the CPU of the programmable controller direct.

Text, timers, counters and other process values are displayed and modified using data blocks in the CPU previously defined in the user program. Information is written to and read out from values (data) stored in the data blocks is possible during operation. A display can be requested in the user program by setting flags or on the TD 390 by calling and scrolling with the membrane keys.

The system texts are stored in the TD 390 in German, English, French, Spanish and Italian.

Technical specifications

Display	Backlit LCD 2 lines 20 characters/line	Transport and storage temperature	-40 to 70 °C
Character size	5 mm	Degree of protection	IP 65 at the front
Power supply	24 V external average 60 mA max. 120 mA	Dimensions (W x H x D) in mm	
Ambient temperature	0 to 60 °C	• Unit	144 x 72 x 27
		• Panel cutout	
		Standard size (W x H)	138 x 68
		• Thickness of cabinet/ control panel	max. 4
		Weight	0.25 kg

Ordering data

Order No.

TD 390 text display
incl. product manual
(German, English, French, Spanish, Italian)

6ES5 390-0UA11