



**Servomotori a C.C.
a magneti permanenti
serie BR**

***Permanent magnet
DC servomotors
BR series***

Generalità

I servomotori a corrente continua con eccitazione a magneti permanenti della serie BR hanno ingombri contenuti, ottime caratteristiche dinamiche associate ad elevate coppie continue; sono quindi particolarmente adatti per azionare gli assi delle macchine utensili a controllo numerico.

Si impiegano comunque con successo in ogni azionamento dove sono richieste coppie elevate con grande regolarità di moto anche a bassissime velocità (inferiori a 1 giro/min.). Grazie alle loro caratteristiche possono essere accoppiati direttamente senza bisogno di riduttori a ruote o a cinghia, migliorando così il rendimento del sistema e diminuendo la costante di tempo meccanica.

Caratteristiche principali

- Eccitazione a magneti permanenti in ferrite con caratteristiche tali da non smagnetizzarsi né con gli elevati sovraccarichi previsti dalle curve di funzionamento né estraendo il rotore per eventuali ispezioni.
- Forma B5 trasformabile in V1 o V3 senza modifiche.
- Esecuzione chiusa (IP54).
- Rotore con elevato numero di cave inclinate per ridurre al minimo le oscillazioni di velocità ai bassi giri.
- Spazzole di lunga durata facilmente sostituibili. Nelle manutenzioni si raccomanda di montare spazzole identiche alle originali o comunque equivalenti e sempre tutte uguali.
- Rumorosità contenuta (inferiore a 60dbA).
- Equilibratura accurata (grado S secondo le DIN 45665) eseguita con mezza chiave, asse pieno.
- Anello angus: assieme al motore, a richiesta, viene fornito sciolto un anello paraolio, che va montato solo se è previsto un accoppiamento dove la flangia del motore è a contatto diretto con l'olio del riduttore.
- Protezione termica prevista di serie, contatto normalmente chiuso, portata max 10A: apre se si raggiungono temperature pericolose.
- Uscita cavi su scatola morsettiera orientabile di 90° nelle 4 direzioni .
- Isolamento con gran parte dei materiali in classe H con sovratemperatura di classe F.
- Cuscinetto lato accoppiamento bloccato per evitare spostamenti dell'albero.
- Cuscinetti prelubrificati, ampiamente dimensionati, che non richiedono manutenzione.

General features

The DC servomotors BR series, with permanent magnets have compact dimensions, optimal dynamic characteristics combined with high constant torques; they are therefore particularly suitable for driving machine tool axes with CNC.

They are successfully employed in all drives requiring high torques, max uniformity of speed even at lowest regimes (<1 RPM).

Thanks to their features, they can be coupled directly, without tooth-gear or belt transmissions, thus improving the system efficiency and the mechanical time constant.

Main specifications

- Permanent magnet field excitation (ferroxide), not subject to demagnetizing either through the overloads foreseen by the function curves, or when extracting the rotor for inspection.
- Format B5 may be transformed into V1 or V3 without modifications.
- Protection class IP 54 (TENV).
- Rotor with many slanting slots, reducing to a minimum the speed variations at low RPM.
- Long life brushes, easily replaceable. Original spares are recommended, or at least equivalent, and all of same type.
- Low noise (<60 dbA).
- Accurate balancing (class S DIN 45665), carried out with halfkey, full shaft.
- Angus ring: or request an oil ring is supplied with the motor and must be assembled only if there is a coupling where the motor flange is in direct contact with the oil of the reduction unit.
- Standard thermal protection; contact normally closed (max 10A), opening on overtemperature.
- Cable connection over terminal box rotating by 90° in 4 directions .
- Insulation with great part of materials in class H, and overtemperature class F.
- Bearing on coupling side sits tight, to avoid axial displacement of shaft.
- Prelubricated, largely dimensioned, maintenance-free bearings.

Tabella dei Cuscinetti

Table of Bearings

Motore tipo <i>Motor type</i>	Cuscinetto lato accoppiamento <i>Coupling side bearing</i>	Cuscinetto lato collettore <i>Commutator side bearing</i>
BR 45	6302 - 2Z	6202 - 2Z
BR 60	6005 - 2Z	6204 - 2Z
BR 80	6006 - 2Z	6204 - 2Z
BR 100	6006 - 2Z	6205 - 2Z

Accessori standard

Dinamo tachimetrica

Ogni motore viene fornito completo di dinamo tachimetrica. E' incorporata, salvo su BR45, nel motore e quindi protetta da urti accidentali.

La dinamo è fissata direttamente sull'asse del motore, in maniera rigida senza giunti, eliminando quindi ogni possibile vibrazione torsionale e di conseguenza il suo segnale segue fedelmente le variazioni dei giri del motore senza pendolazioni. Tensione normale 20 volt a 1000 g/min., a richiesta possono essere fornite altre tensioni.

Standard accessories

Tachogenerator

Each motor is supplied with a tachogenerator. It is incorporated, excepted for BR45, in the motor for protection against accidental shocks.

The tachogenerator is fixed directly to the motor axle in rigid coupling (no joints), thus eliminating any twist vibrations, so that the signal accurately follows the motor RPM, without any oscillation.

Normal voltage is 20 V at 1000 RPM. Other voltages may be supplied on request.

Accessori a richiesta

- Freno di stazionamento o di emergenza incorporato nel motore lato accoppiamento, del tipo a caduta di corrente. Tensione di alimentazione 24 Vcc. Collegamento previsto con connettore tipo MS.

Optional accessories

- Stopping or emergency brake, incorporated in the motor (coupling side) and working on current drop. Supply voltage 24 Vdc. Connection foresees by MS connector.

Motore tipo Motor type	Coppia frenante Braking torque [Nm]	Corrente Current [A _{dc}]	Inerzia aggiuntiva Additional inertia [10 ⁻⁴ x kgm ²]	Peso aggiuntivo Additional weight [kg]
BR 45	2.5	0.46	0.5	0.6
BR 60	5	0.64	1.4	2.8
BR 80	20	0.89	12	4
BR 100	40	1.46	36	6

- Estremità d'albero speciale.
- Predisposizione per encoder secondo dimensioni di ingombro cod. 1012 su BR60-80-100 e cod. 1023 su BR45.
- Predisposizione per encoder completa di relativa lanterna e giunto già adattati per i principali tipi di encoder in commercio. Richiedere le dimensioni di ingombro alla nostra organizzazione commerciale.
- Special shaft end.
- Pre-arrangement for encoder, according to drawing code 1012 for BR60-80-100 and code 1023 for BR45.
- Pre-arrangement for encoder, with relevant coupling flange and joint, suitable for the main encoder types in trade. Ask our sales organisation for overall sizes.

Prestazioni dei Motori

- Nella seguente tabella sono riepilogate le principali caratteristiche dei motori per agevolarne la scelta.

Motor characteristics

- Main characteristic values of motors are shown on the following table for an easy choice.

Motore tipo Motor type	Coppia nominale Nominal torque [Nm] *	Coppia di picco Peak torque [Nm] *	Inerzia Inertia [10 ⁻⁴ x kgm ²] *	Velocità Max Max speed [RPM]	Dalla pagina .. From page ..
BR 45	0.9 - 2.0	7.0 - 21	4 - 12	4000	4
BR 60	2.5 - 7.7	15 - 45	21 - 48	4000	8
BR 80	5.0 - 21	23 - 93	82 - 260	4000	14
BR 100	8.3 - 36	63 - 317	120 - 550	3000	22

* Valori minimi e massimi

* Min - max values

BR 45 S-M

Parametri / Parameters	Simboli Symbols	Unità di misura Measure unit	BR 45 S				BR 45 M			
			20/09	30/09	40/10	40/06	20/10	30/10	40/10	40/07
Coppia nominale continuativa a rotore bloccato, esecuzione chiusa Ta = 40°C <i>Continuous stall torque totally enclosed non ventilated version Amb. t. = 40°C</i>	C _n	Nm	0.9	0.9	0.9	0.9	1.5	1.5	1.5	1.5
Corrente nominale in esecuzione chiusa <i>Nominal current</i>	I _n	A	2.1	3.1	3.8	6.4	3.0	4.8	6.2	8.6
Velocità nominale <i>Nominal speed</i>	n _{max}	g/min	2000	3000	4000	4000	2000	3000	4000	4000
F.C.E.M. alla velocità nominale * <i>C.E.M.F. at nominal speed *</i>	E _{max}	Volt	88	93	102	59	102	98	102	74
Picco di coppia allo spunto a 25°C <i>Peak stall torque at 25°C</i>	C _p	Nm	7.0	7.0	7.0	7.0	14.0	14.0	14.0	14.0
Corrente al picco di coppia a 25°C <i>Current at peak torque at 25°C</i>	I _p	A	16.7	24.1	29.2	51.2	28.6	45.2	58.3	81.9
Max accelerazione teorica allo spunto <i>Max theoretical acceleration at peak torque</i>	α _p	rad/s ²	17500	17500	17500	17500	17800	17800	17800	17800
Tensione al picco di coppia a 25°C <i>Voltage at peak torque at 25°C</i>	V _p	Volt	86	57	46	29	66	49	37	29
Resistenza d'armatura a 25°C <i>Armature resistance at 25°C</i>	R _a	Ω	4.8	2.16	1.40	0.45	2.15	0.97	0.54	0.28
Resistenza d'armatura a 25°C <i>Armature resistance at 25°C</i>	R _m	Ω	5.0	2.36	1.60	0.65	2.35	1.17	0.74	0.48
Induttanza d'armatura * <i>Armature inductance *</i>	L _a	mH	19.4	9.76	6.62	2.16	13.24	5.47	3.31	1.69
Costante di tempo elettrica a 25°C * <i>Electrical time constant at 25°C *</i>	T _e	ms	3.84	4.13	4.12	3.33	5.62	4.69	4.45	3.48
Costante di tempo meccanica a 25°C * <i>Mechanical time constant at 25°C *</i>	T _m	ms	11.4	11.2	11.1	13.2	7.6	9.4	10.0	12.3
Costante di tempo termica * <i>Thermal time constant *</i>	T _t	min	40	40	40	40	50	50	50	50
Costante di tensione a 25°C * <i>Voltage constant at 25°C *</i>	K _e	Vs/rad	0.42	0.29	0.24	0.14	0.49	0.31	0.24	0.175
Costante di coppia a 25°C * <i>Torque constant at 25°C *</i>	K _t	Nm/A	0.42	0.29	0.24	0.14	0.49	0.31	0.24	0.175
Ondulazione di coppia <i>Torque ripple</i>	—	%	2	2	2	2	2	2	2	2
Massima temperatura ambiente <i>Maximum room temperature</i>	t _{max}	°C	40	40	40	40	40	40	40	40
Classe d'isolamento <i>Insulation class</i>	—	—	F	F	F	F	F	F	F	F
Momento d'inerzia * <i>Moment of inertia *</i>	J	Kgm ²	4x10 ⁻⁴				7.8x10 ⁻⁴			
Peso <i>Weight</i>	G	kg	4.6	4.6	4.6	4.6	6.5	6.5	6.5	6.5

(*) Tolleranza ±10% Tolerance ± 10%

Curve operative con alimentazione in corrente continua
 fattore di forma = 1 e temperatura ambiente 40° C

Operating curves with Dc supply
 form factor = 1 and ambient temperature 40° C

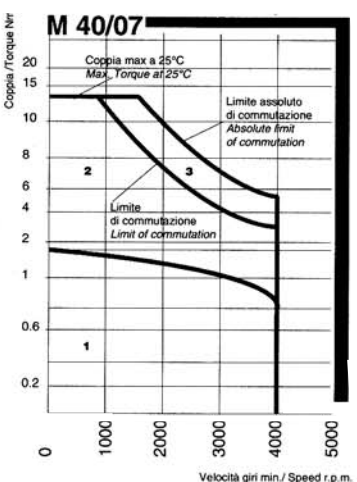
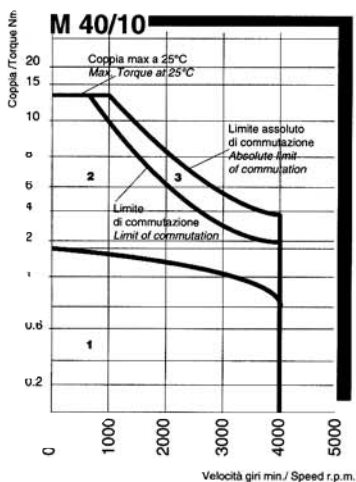
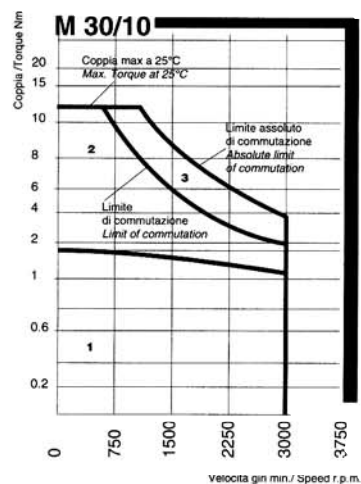
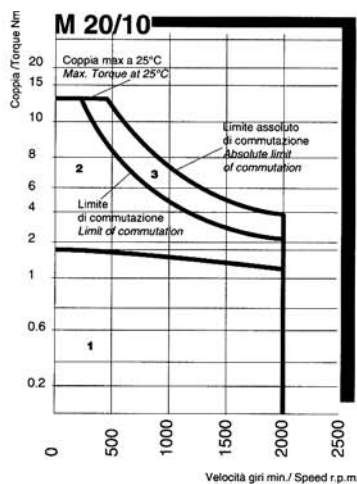
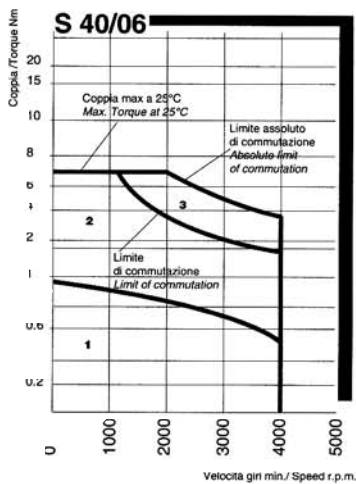
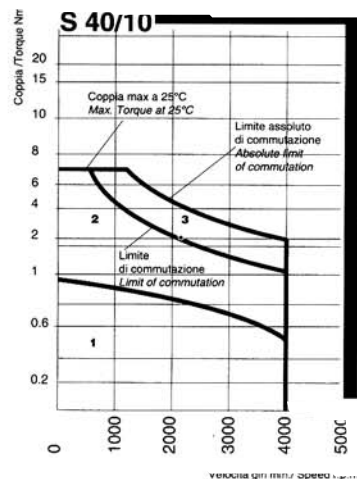
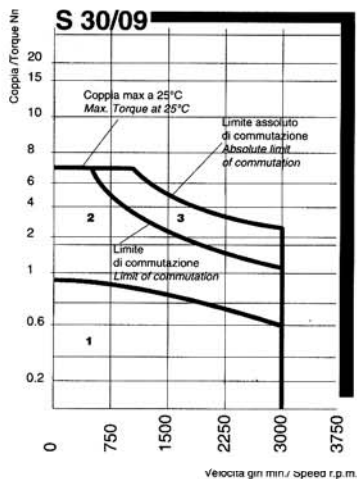
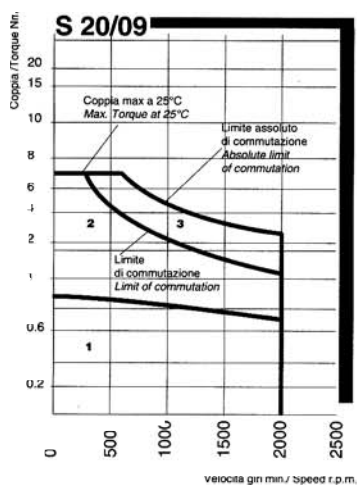

- 1) Area di funzionamento continuo
- 2) Area di funzionamento intermittente
- 3) Area di accelerazione o decelerazione

- 1) Continuous duty area
- 2) Intermittent duty area
- 3) Area of acceleration and deceleration

BR 45 L

Parametri / Parameters	Simboli Symbols	Unità di misura Measure unit	BR 45 L		
			20/10	30/10	40/10
Coppia nominale continuativa a rotore bloccato, esecuzione chiusa Ta = 40°C <i>Continuous stall torque totally enclosed non ventilated version Amb. t. = 40°C</i>	C _n	Nm	2.0	2.0	2.0
Corrente nominale in esecuzione chiusa <i>Nominal current</i>	I _n	A	4.2	6.5	8.7
Velocità nominale <i>Nominal speed</i>	n _{max}	g/min	2000	3000	4000
F.C.E.M. alla velocità nominale * <i>C.E.M.F. at nominal speed *</i>	E _{max}	Volt	98	98	98
Picco di coppia allo spunto a 25°C <i>Peak stall torque at 25°C</i>	C _p	Nm	21.0	21.0	21.0
Corrente al picco di coppia a 25°C <i>Current at peak torque at 25°C</i>	I _p	A	44.7	67.7	91.3
Max accelerazione teorica allo spunto <i>Max theoretical acceleration at peak torque</i>	α _p	rad/s ²	17800	17800	17800
Tensione al picco di coppia a 25°C <i>Voltage at peak torque at 25°C</i>	V _p	Volt	64	43	34
Resistenza d'armatura a 25°C senza spazzole * <i>Armature resistance at 25°C without brushes *</i>	R _a	Ω	1.30	0.56	0.30
Resistenza d'armatura a 25°C con spazzole * <i>Armature resistance at 25°C with brushes *</i>	R _m	Ω	1.50	0.76	0.50
Induttanza d'armatura * <i>Armature inductance *</i>	L _a	mH	8.21	3.65	2.05
Costante di tempo elettrica a 25°C * <i>Electrical time constant at 25°C *</i>	T _e	ms	5.46	4.82	4.09
Costante di tempo meccanica a 25°C * <i>Mechanical time constant at 25°C *</i>	T _m	ms	8.0	9.3	11.1
Costante di tempo termica * <i>Thermal time constant *</i>	T _t	min	60	60	60
Costante di tensione a 25°C * <i>Voltage constant at 25°C *</i>	K _e	Vs/rad	0.47	0.31	0.23
Costante di coppia a 25°C * <i>Torque constant at 25°C *</i>	K _t	Nm/A	0.47	0.31	0.23
Ondulazione di coppia <i>Torque ripple</i>	—	%	2	2	2
Massima temperatura ambiente <i>Maximum room temperature</i>	t _{max}	°C	40	40	40
Classe d'isolamento <i>Insulation class</i>	—	—	F	F	F
Momento d'inerzia * <i>Moment of inertia *</i>	J	Kgm ²	11.8x10 ⁻⁴		
Peso <i>Weight</i>	G	kg	8.4	8.4	8.4

(*) Tolleranza ±10% Tolerance ± 10%

Curve operative con alimentazione in corrente continua
fattore di forma = 1 e temperatura ambiente 40° C

Operating curves with Dc supply
form factor = 1 and ambient temperature 40° C

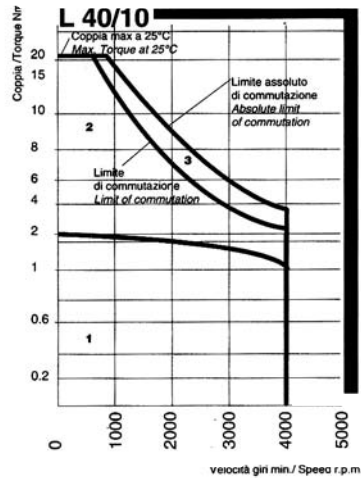
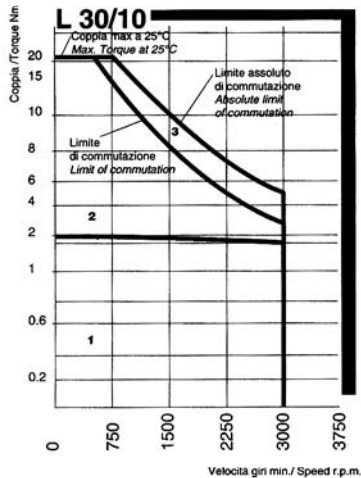
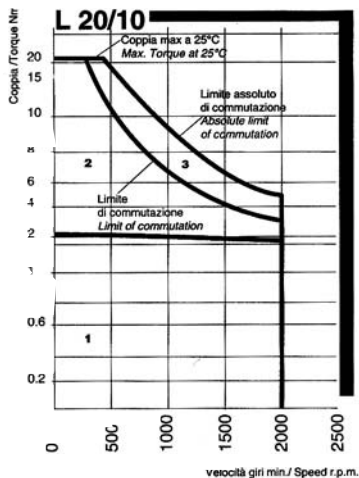

Dimensioni d'ingombro

Overall dimensions

2327/B - BR45

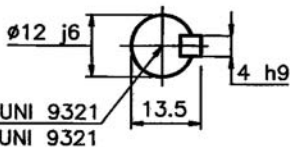
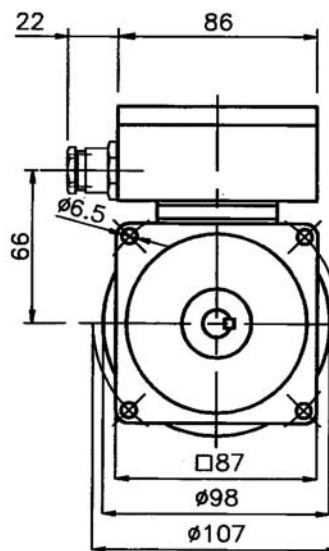
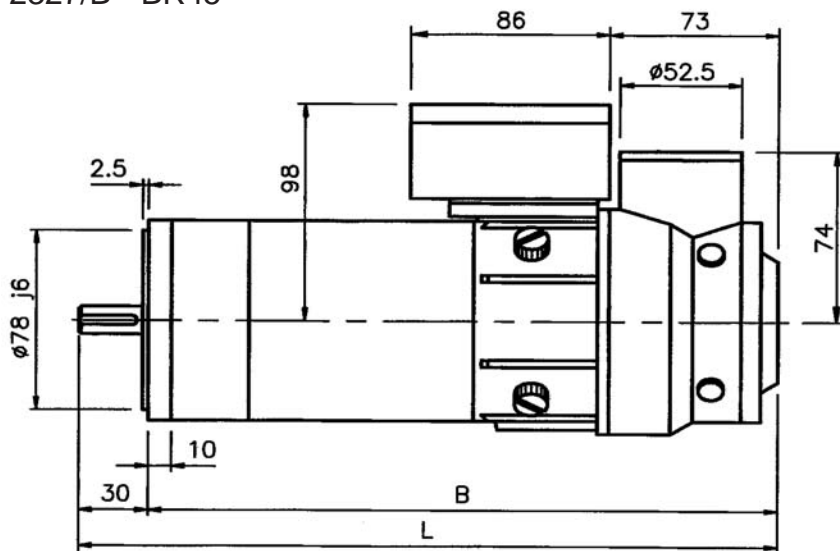

1023/A

Predisposizione per encoder
Pre-arrangement for encoder

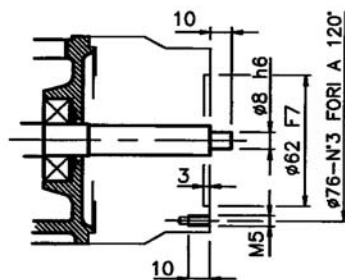

TIPO	B	L	
S	272	302	Nelle versioni complete di freno, le quote A,B,L aumentano di 29mm
BR45	M	329	In the version with brake, the quotas A,B,L increase by 29mm
	L	386	

BR 60 S

Parametri / Parameters	Simboli Symbols	Unità di misura Measure unit	Tipo di avvolgimento Types of winding							
			12/12	20/11	30/12	40/14	12/17	20/17	30/17	40/17
Coppia nominale continuativa a rotore bloccato, esecuzione chiusa Ta = 40°C <i>Continuous stall torque totally enclosed non ventilated version Amb. t. = 40°C</i>	C _n	Nm	2.87	2.75	2.57	2.52	2.81	2.70	2.70	2.57
Corrente nominale in esecuzione chiusa <i>Nominal current</i>	I _n	A	3.0	4.9	6.5	7.6	2.0	3.2	4.8	6.1
Velocità nominale <i>Nominal speed</i>	n _{max}	g/min	1200	2000	3000	4000	1200	2000	3000	4000
F.C.E.M. alla velocità nominale * <i>C.E.M.F. at nominal speed *</i>	E _{max}	Volt	120	118	123	141	176	176	176	176
Picco di coppia allo spunto a 25°C <i>Peak stall torque at 25°C</i>	C _p	Nm	15	15	15	15	15	15	15	15
Corrente al picco di coppia a 25°C <i>Current at peak torque at 25°C</i>	I _p	A	15.7	26.7	38	45	10.7	17.8	26.7	35.6
Max accelerazione teorica allo spunto <i>Max theoretical acceleration at peak torque</i>	α _p	rad/s ²	7140	7140	7140	7140	7140	7140	7140	7140
Tensione al picco di coppia a 25°C <i>Voltage at peak torque at 25°C</i>	V _p	Volt	85	54	40	30	136	86	55	45
Resistenza d'armatura a 25°C <i>Armature resistance at 25°C</i>	R _a	Ω	5.37	1.98	1.00	0.69	12.6	4.79	2.01	1.22
Resistenza d'armatura a 25°C <i>Armature resistance at 25°C</i>	R _m	Ω	5.42	2.03	1.05	0.71	12.7	4.84	2.06	1.27
Induttanza d'armatura * <i>Armature inductance *</i>	L _a	mH	20.0	7.0	3.4	2.6	43	15.6	7.0	4.0
Costante di tempo elettrica a 25°C * <i>Electrical time constant at 25°C *</i>	T _e	ms	3.7	3.4	3.2	3.7	3.4	3.2	3.4	3.1
Costante di tempo meccanica a 25°C * <i>Mechanical time constant at 25°C *</i>	T _m	ms	12.4	13.6	14.5	13.8	13.4	14.4	13.8	15.1
Costante di tempo termica * <i>Thermal time constant *</i>	T _t	min	50	50	50	50	50	50	50	50
Costante di tensione a 25°C * <i>Voltage constant at 25°C *</i>	K _e	Vs/rad	0.96	0.56	0.39	0.33	1.41	0.84	0.56	0.42
Costante di coppia a 25°C * <i>Torque constant at 25°C *</i>	K _t	Nm/A	0.96	0.56	0.39	0.33	1.41	0.84	0.56	0.42
Ondulazione di coppia <i>Torque ripple</i>	—	%	1.8	1.8	1.8	1.8	1.8	1.8	1.8	1.8
Massima temperatura ambiente <i>Maximum room temperature</i>	t _{max}	°C	40	40	40	40	40	40	40	40
Classe d'isolamento <i>Insulation class</i>	—	—	F	F	F	F	F	F	F	F
Momento d'inerzia * <i>Moment of inertia *</i>	J	Kgm ²	0.0021	0.0021	0.0021	0.0021	0.0021	0.0021	0.0021	0.0021
Peso <i>Weight</i>	G	kg	10	10	10	10	10	10	10	10

(*) Tolleranza ±10% Tolerance ± 10%

Curve operative con alimentazione in corrente continua
 fattore di forma = 1 e temperatura ambiente 40° C

Operating curves with Dc supply
 form factor = 1 and ambient temperature 40° C

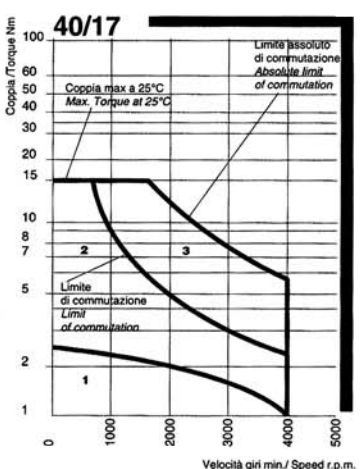
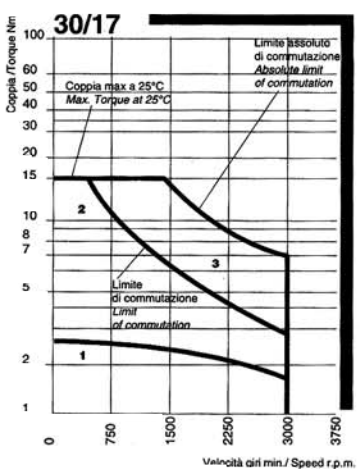
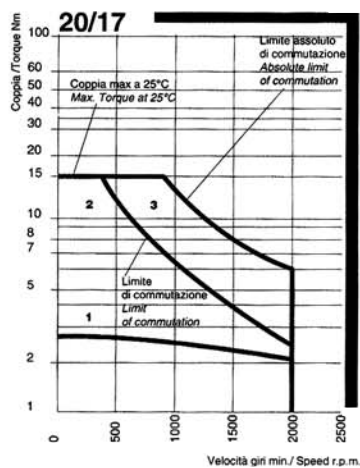
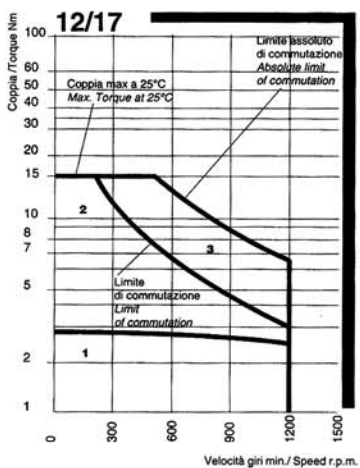
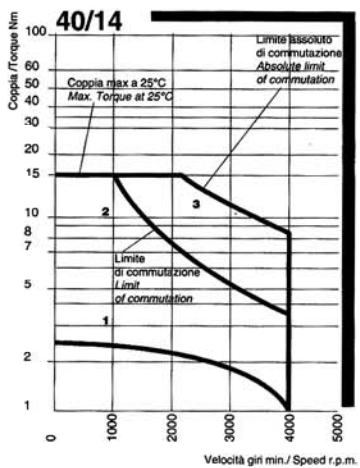
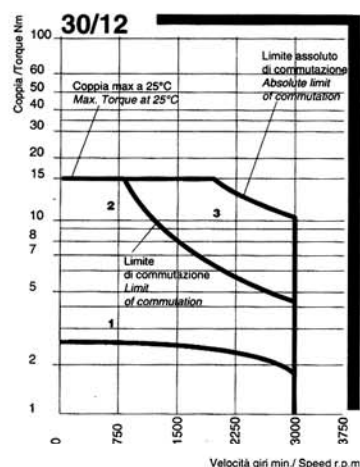
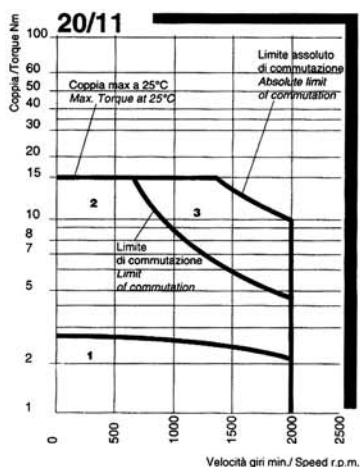
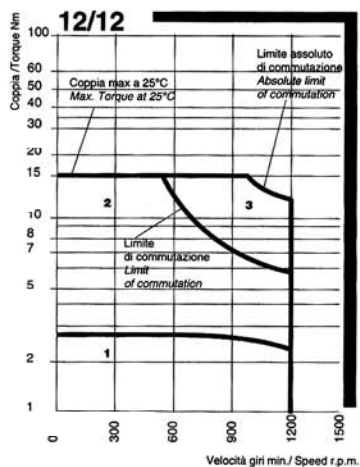

- 1) Area di funzionamento continuo
- 2) Area di funzionamento intermittente
- 3) Area di accelerazione o decelerazione

- 1) Continuous duty area
- 2) Intermittent duty area
- 3) Area of acceleration and deceleration

BR 60 M

Parametri / Parameters	Simboli Symbols	Unità di misura Measure unit	Tipo di avvolgimento Types of winding							
			12/12	20/11	30/14	40/14	12/17	20/17	30/17	40/16
Coppia nominale continuativa a rotore bloccato, esecuzione chiusa Ta = 40°C <i>Continuous stall torque totally enclosed non ventilated version Amb. t. = 40°C</i>	C _n	Nm	5.4	5.2	5.0	4.7	5.5	5.5	5.2	4.8
Corrente nominale in esecuzione chiusa <i>Nominal current</i>	I _n	A	5.4	9.2	11.1	14	3.9	6.5	9.2	12.2
Velocità nominale <i>Nominal speed</i>	n _{max}	g/min	1200	2000	3000	4000	1200	2000	3000	4000
F.C.E.M. alla velocità nominale * <i>C.E.M.F. at nominal speed *</i>	E _{max}	Volt	127	118	141	141	176	176	176	165
Picco di coppia allo spunto a 25°C <i>Peak stall torque at 25°C</i>	C _p	Nm	30	30	30	30	30	30	30	30
Corrente al picco di coppia a 25°C <i>Current at peak torque at 25°C</i>	I _p	A	30	53	66.6	89	21.3	35.5	53	76
Max accelerazione teorica allo spunto <i>Max theoretical acceleration at peak torque</i>	α _p	rad/s ²	88200	88200	88200	88200	88200	88200	88200	88200
Tensione al picco di coppia a 25°C <i>Voltage at peak torque at 25°C</i>	V _p	Volt	67	41	34	28	96	56	41	31
Resistenza d'armatura a 25°C <i>Armature resistance at 25°C</i>	R _a	Ω	2.25	0.72	0.46	0.26	4.47	1.53	0.72	0.36
Resistenza d'armatura a 25°C <i>Armature resistance at 25°C</i>	R _m	Ω	2.30	0.77	0.51	0.31	4.52	1.58	0.77	0.41
Induttanza d'armatura * <i>Armature inductance *</i>	L _a	mH	11.0	3.50	2.20	1.26	22	7.8	3.5	1.72
Costante di tempo elettrica a 25°C * <i>Electrical time constant at 25°C *</i>	T _e	ms	4.8	4.5	4.3	4.1	4.9	4.99	4.5	4.2
Costante di tempo meccanica a 25°C * <i>Mechanical time constant at 25°C *</i>	T _m	ms	7.8	8.1	8.6	9.2	7.8	7.5	8.1	9.2
Costante di tempo termica * <i>Thermal time constant *</i>	T _t	min	60	60	60	60	60	60	60	60
Costante di tensione a 25°C * <i>Voltage constant at 25°C *</i>	K _e	Vs/rad	1.00	0.57	0.45	0.34	1.41	0.85	0.57	0.39
Costante di coppia a 25°C * <i>Torque constant at 25°C *</i>	K _t	Nm/A	1.00	0.57	0.45	0.34	1.41	0.85	0.57	0.39
Ondulazione di coppia <i>Torque ripple</i>	—	%	1.8	1.8	1.8	1.8	1.8	1.8	1.8	1.8
Massima temperatura ambiente <i>Maximum room temperature</i>	t _{max}	°C	40	40	40	40	40	40	40	40
Classe d'isolamento <i>Insulation class</i>	—	—	F	F	F	F	F	F	F	F
Momento d'inerzia * <i>Moment of inertia *</i>	J	Kgm ²	0.0034	0.0034	0.0034	0.0034	0.0034	0.0034	0.0034	0.0034
Peso <i>Weight</i>	G	kg	13.5	13.5	13.5	13.5	13.5	13.5	13.5	13.5

(*) Tolleranza ±10% Tolerance ± 10%

Curve operative con alimentazione in corrente continua
 fattore di forma = 1 e temperatura ambiente 40° C

Operating curves with Dc supply
 form factor = 1 and ambient temperature 40° C

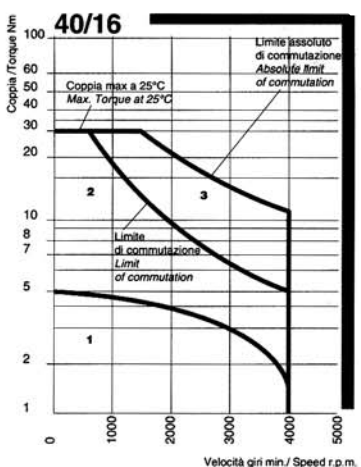
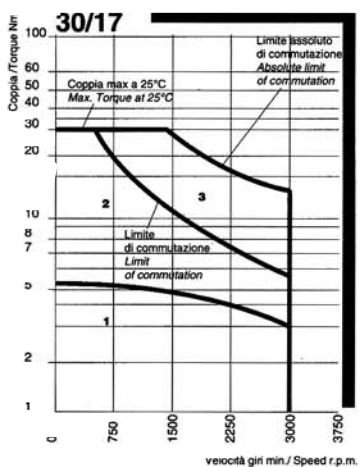
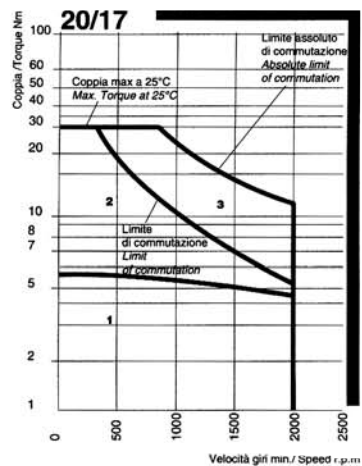
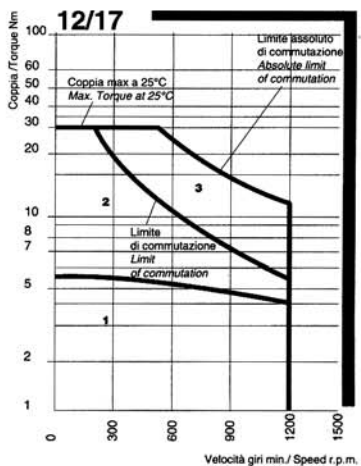
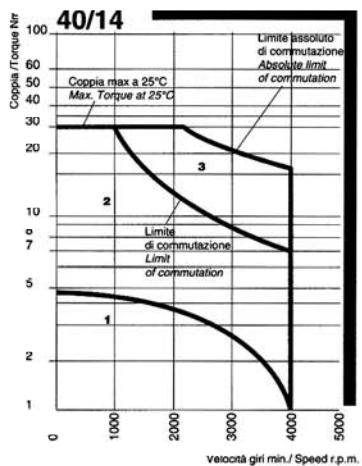
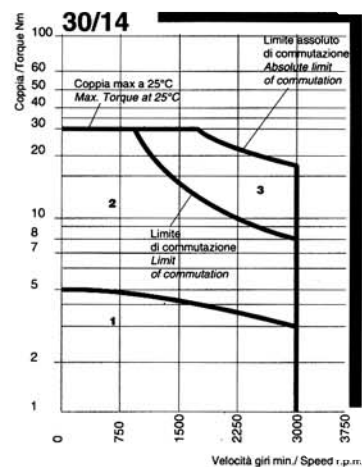
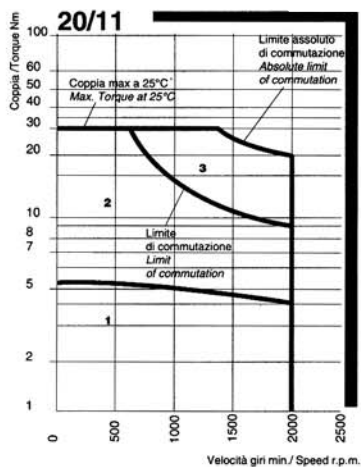
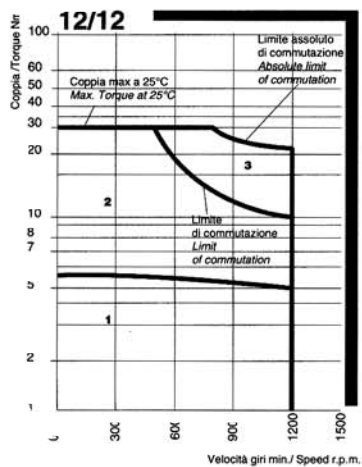

- 1) Area di funzionamento continuo
- 2) Area di funzionamento intermittente
- 3) Area di accelerazione o decelerazione

- 1) Continuous duty area
- 2) Intermittent duty area
- 3) Area of acceleration and deceleration

BR 60 L

Parametri / Parameters	Simboli Symbols	Unità di misura Measure unit	Tipo di avvolgimento Types of winding							
			12/12	20/14	30/13	40/14	12/17	20/17	28/17	40/17
Coppia nominale continuativa a rotore bloccato, esecuzione chiusa Ta = 40°C <i>Continuous stall torque totally enclosed non ventilated version Amb. t. = 40°C</i>	C _n	Nm	7.8	7.5	7.2	7.1	7.7	7.7	7.7	7.2
Corrente nominale in esecuzione chiusa <i>Nominal current</i>	I _n	A	7.8	11.3	17	21	5.8	9.1	13	17
Velocità nominale <i>Nominal speed</i>	n _{max}	g/min	1200	2000	3000	4000	1200	2000	2800	4000
F.C.E.M. alla velocità nominale * <i>C.E.M.F. at nominal speed *</i>	E _{max}	Volt	127	141	132	141	170	176	173	176
Picco di coppia allo spunto a 25°C <i>Peak stall torque at 25°C</i>	C _p	Nm	45	45	45	45	45	45	45	45
Corrente al picco di coppia a 25°C <i>Current at peak torque at 25°C</i>	I _p	A	45	68	106	133	34	53	76	106
Max accelerazione teorica allo spunto <i>Max theoretical acceleration at peak torque</i>	α _p	rad/s ²	9370	9370	9370	9370	9370	9370	9370	9370
Tensione al picco di coppia a 25°C <i>Voltage at peak torque at 25°C</i>	V _p	Volt	59	44	31	27	82	52	39	31
Resistenza d'armatura a 25°C <i>Armature resistance at 25°C</i>	R _a	Ω	1.27	0.59	0.23	0.14	2.36	0.93	0.45	0.23
Resistenza d'armatura a 25°C <i>Armature resistance at 25°C</i>	R _m	Ω	1.32	0.64	0.28	0.19	2.41	0.98	0.50	0.28
Induttanza d'armatura * <i>Armature inductance *</i>	L _a	mH	7.5	3.3	1.25	0.80	13.2	5.2	2.4	1.25
Costante di tempo elettrica a 25°C * <i>Electrical time constant at 25°C *</i>	T _e	ms	5.7	5.2	4.3	4.1	5.5	5.3	4.7	4.3
Costante di tempo meccanica a 25°C * <i>Mechanical time constant at 25°C *</i>	T _m	ms	6.4	7.1	7.9	8.3	6.5	6.5	7.0	7.9
Costante di tempo termica * <i>Thermal time constant *</i>	T _t	min	70	70	70	70	70	70	70	70
Costante di tensione a 25°C * <i>Voltage constant at 25°C *</i>	K _e	Vs/rad	1.00	0.66	0.42	0.34	1.33	0.85	0.59	0.42
Costante di coppia a 25°C * <i>Torque constant at 25°C *</i>	K _t	Nm/A	1.00	0.66	0.42	0.34	1.33	0.85	0.59	0.42
Ondulazione di coppia <i>Torque ripple</i>	—	%	1.8	1.8	1.8	1.8	1.8	1.8	1.8	1.8
Massima temperatura ambiente <i>Maximum room temperature</i>	t _{max}	°C	40	40	40	40	40	40	40	40
Classe d'isolamento <i>Insulation class</i>	—	—	F	F	F	F	F	F	F	F
Momento d'inerzia * <i>Moment of inertia *</i>	J	Kgm ²	0.0048	0.0048	0.0048	0.0048	0.0048	0.0048	0.0048	0.0048
Peso <i>Weight</i>	G	kg	17	17	17	17	17	17	17	17

(*) Tolleranza ±10% Tolerance ± 10%

Curve operative con alimentazione in corrente continua
 fattore di forma = 1 e temperatura ambiente 40° C

Operating curves with Dc supply
 form factor = 1 and ambient temperature 40° C

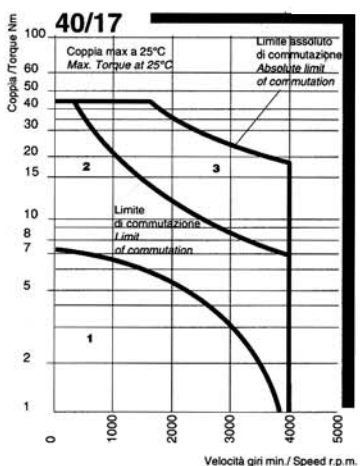
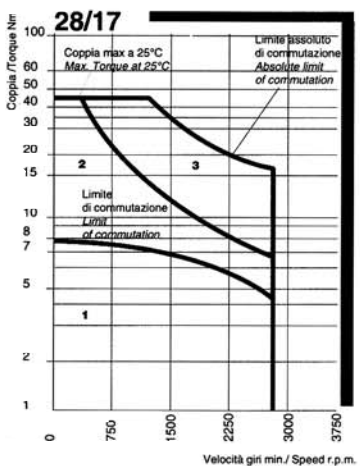
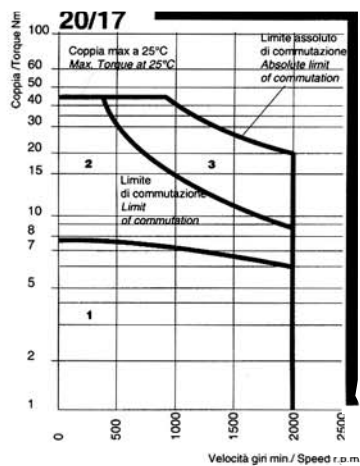
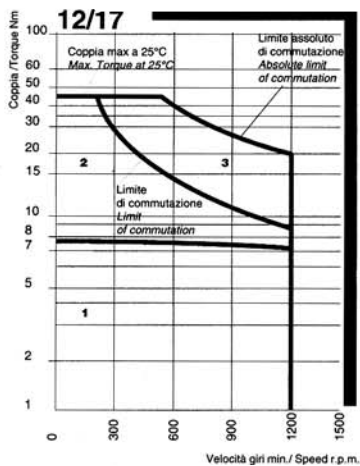
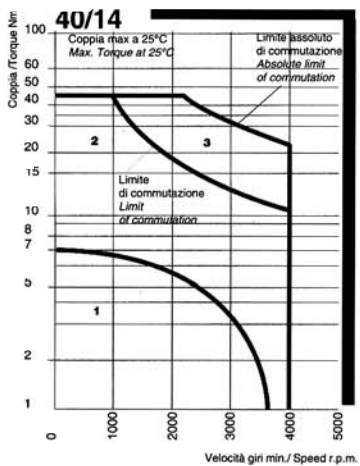
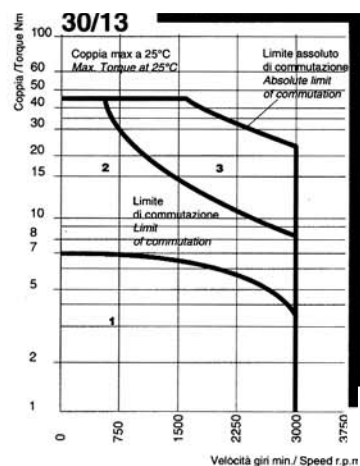
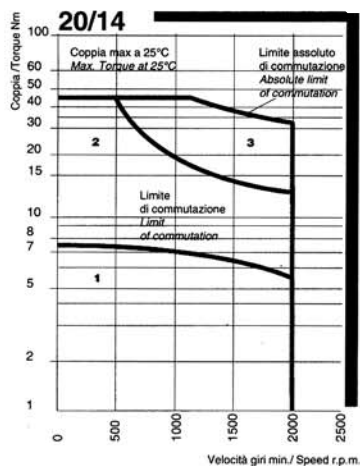
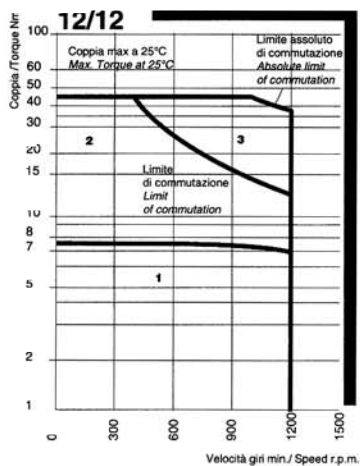

- 1) Area di funzionamento continuo
 - 2) Area di funzionamento intermittente
 - 3) Area di accelerazione o decelerazione
- 1) Continuous duty area
 2) Intermittent duty area
 3) Area of acceleration and deceleration.

BR 80 S

Parametri / Parameters	Simboli Symbols	Unità di misura Measure unit	Tipo di avvolgimento Types of winding							
			12/13	20/11	30/14	40/11	12/17	20/17	30/17	40/17
Coppia nominale continuativa a rotore bloccato, esecuzione chiusa Ta = 40°C <i>Continuous stall torque totally enclosed non ventilated version Amb. t. = 40°C</i>	C _n	Nm	5.8	5.5	5.3	5.0	5.6	5.6	5.5	5.2
Corrente nominale in esecuzione chiusa <i>Nominal current</i>	I _n	A	5.5	10	11.4	18	4.1	6.8	10.0	12.6
Velocità nominale <i>Nominal speed</i>	n _{max}	g/min	1200	2000	3000	4000	1200	2000	3000	4000
F.C.E.M. alla velocità nominale * <i>C.E.M.F. at nominal speed *</i>	E _{max}	Volt	134	117	145	117	175	175	175	175
Picco di coppia allo spunto a 25°C <i>Peak stall torque at 25°C</i>	C _p	Nm	23.3	23.3	23.3	23.3	23.3	23.3	23.3	23.3
Corrente al picco di coppia a 25°C <i>Current at peak torque at 25°C</i>	I _p	A	22.1	42.4	50.2	84	17.1	28.3	42.4	56.5
Max accelerazione teorica allo spunto <i>Max theoretical acceleration at peak torque</i>	α _p	rad/s ²	2840	2840	2840	2840	2840	2840	2840	2840
Tensione al picco di coppia a 25°C <i>Voltage at peak torque at 25°C</i>	V _p	Volt	50	30	26	18	78	45	30	25
Resistenza d'armatura a 25°C senza spazzole * <i>Armature resistance at 25°C without brushes *</i>	R _a	Ω	2.40	0.65	0.47	0.16	4.50	1.52	0.65	0.38
Resistenza d'armatura a 25°C con spazzole * <i>Armature resistance at 25°C with brushes *</i>	R _m	Ω	2.45	0.70	0.52	0.21	4.55	1.57	0.70	0.43
Induttanza d'armatura * <i>Armature inductance *</i>	L _a	mH	10.6	2.9	2.0	0.73	18.0	6.5	2.9	1.6
Costante di tempo elettrica a 25°C * <i>Electrical time constant at 25°C *</i>	T _e	ms	4.3	4.1	3.8	3.4	4.0	4.0	4.1	3.7
Costante di tempo meccanica a 25°C * <i>Mechanical time constant at 25°C *</i>	T _m	ms	18.2	19.0	20.2	22.4	20.0	19.2	19.0	21.0
Costante di tempo termica * <i>Thermal time constant *</i>	T _t	min	80	80	80	80	80	80	80	80
Costante di tensione a 25°C * <i>Voltage constant at 25°C *</i>	K _e	Vs/rad	1.05	0.55	0.46	0.28	1.37	0.82	0.55	0.41
Costante di coppia a 25°C * <i>Torque constant at 25°C *</i>	K _t	Nm/A	1.05	0.55	0.46	0.28	1.37	0.82	0.55	0.41
Ondulazione di coppia <i>Torque ripple</i>	—	%	1.5	1.5	1.5	1.5	1.5	1.5	1.5	1.5
Massima temperatura ambiente <i>Maximum room temperature</i>	t _{max}	°C	40	40	40	40	40	40	40	40
Classe d'isolamento <i>Insulation class</i>	—	—	F	F	F	F	F	F	F	F
Momento d'inerzia * <i>Moment of inertia *</i>	J	Kgm ²	0.0082	0.0082	0.0082	0.0082	0.0082	0.0082	0.0082	0.0082
Peso <i>Weight</i>	G	kg	20	20	20	20	20	20	20	20

(*) Tolleranza ±10% Tolerance ± 10%

Curve operative con alimentazione in corrente continua
 fattore di forma = 1 e temperatura ambiente 40° C

Operating curves with Dc supply
 form factor = 1 and ambient temperature 40° C

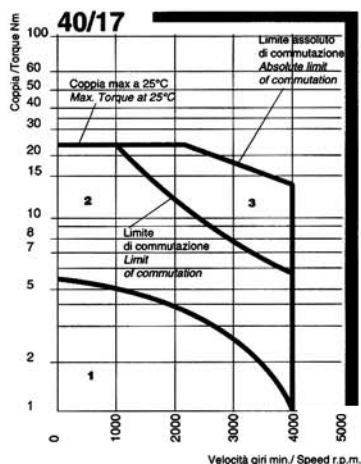
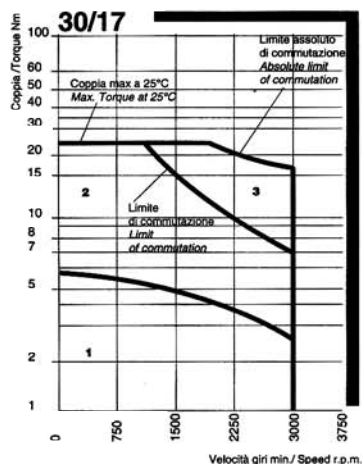
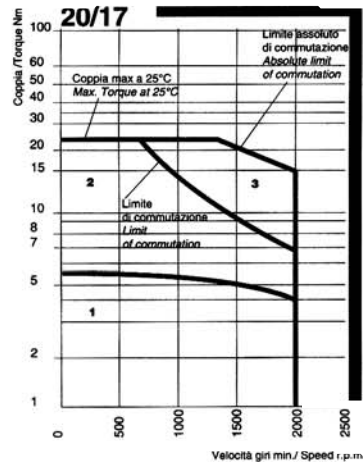
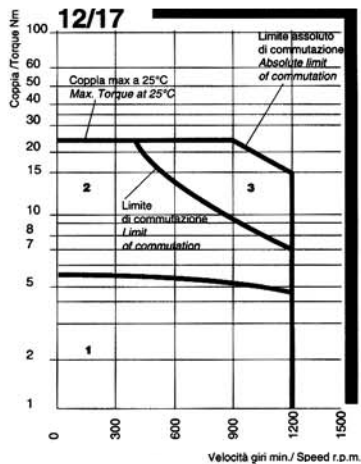
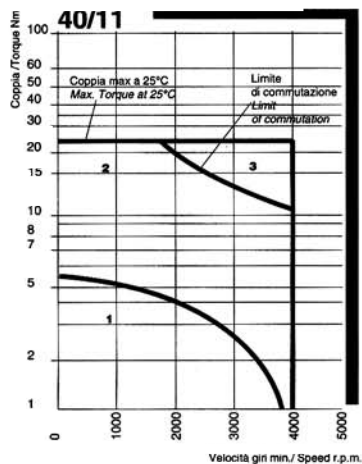
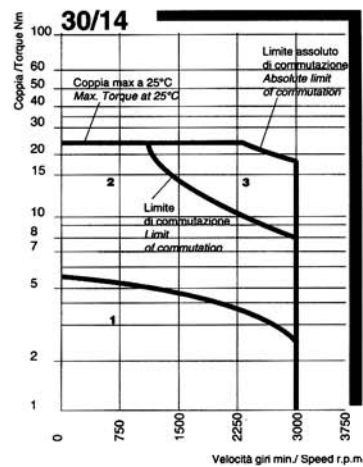
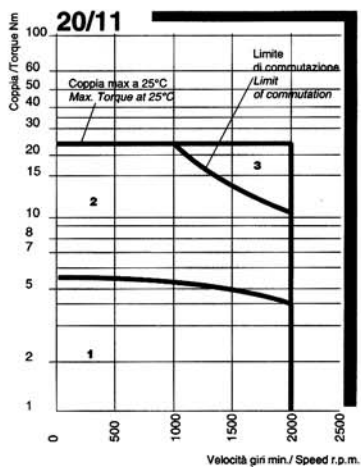
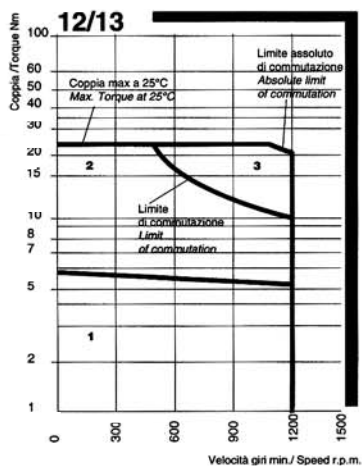

- 1) Area di funzionamento continuo
- 2) Area di funzionamento intermittente
- 3) Area di accelerazione o decelerazione

- 1) Continuous duty area
- 2) Intermittent duty area
- 3) Area of acceleration and deceleration

BR 80 M

Parametri / Parameters	Simboli Symbols	Unità di misura Measure unit	Tipo di avvolgimento Types of winding							
			12/14	20/11	30/14	40/15	12/17	20/17	30/17	36/17
Coppia nominale continuativa a rotore bloccato, esecuzione chiusa Ta = 40°C <i>Continuous stall torque totally enclosed non ventilated version Amb. t. = 40°C</i>	C _n	Nm	11.6	11.1	10.6	10.3	11.8	11.4	11.1	10.6
Corrente nominale in esecuzione chiusa <i>Nominal current</i>	I _n	A	10.5	20.1	23.0	28.0	8.6	13.8	20.1	23.0
Velocità nominale <i>Nominal speed</i>	n _{max}	g/min	1200	2000	3000	4000	1200	2000	3000	3600
F.C.E.M. alla velocità nominale * <i>C.E.M.F. at nominal speed *</i>	E _{max}	Volt	141	117	145	155	175	175	175	175
Picco di coppia allo spunto a 25°C <i>Peak stall torque at 25°C</i>	C _p	Nm	46.6	46.6	46.6	46.6	46.6	46.6	46.6	46.6
Corrente al picco di coppia a 25°C <i>Current at peak torque at 25°C</i>	I _p	A	42.2	84.4	101	127	34	56	84	101
Max accelerazione teorica allo spunto <i>Max theoretical acceleration at peak torque</i>	α _p	rad/s ²	3320	3320	3320	3320	3320	3320	3320	3320
Tensione al picco di coppia a 25°C <i>Voltage at peak torque at 25°C</i>	V _p	Volt	40	23	20	18	49	32	23	20
Resistenza d'armatura a 25°C senza spazzole * <i>Armature resistance at 25°C without brushes *</i>	R _a	Ω	0.89	0.22	0.15	0.09	1.39	0.52	0.22	0.15
Resistenza d'armatura a 25°C con spazzole * <i>Armature resistance at 25°C with brushes *</i>	R _m	Ω	0.94	0.27	0.20	0.14	1.44	0.57	0.27	0.20
Induttanza d'armatura * <i>Armature inductance *</i>	L _a	mH	5.8	1.5	1.0	0.67	9.1	3.4	1.5	1.0
Costante di tempo elettrica a 25°C * <i>Electrical time constant at 25°C *</i>	T _e	ms	6.2	5.5	4.9	4.7	6.3	5.9	5.5	5.1
Costante di tempo meccanica a 25°C * <i>Mechanical time constant at 25°C *</i>	T _m	ms	10.9	12.6	13.5	15.2	10.8	11.7	12.6	13.5
Costante di tempo termica * <i>Thermal time constant *</i>	T _t	min	90	90	90	90	90	90	90	90
Costante di tensione a 25°C * <i>Voltage constant at 25°C *</i>	K _e	Vs/rad	1.10	0.55	0.46	0.37	1.37	0.83	0.55	0.46
Costante di coppia a 25°C * <i>Torque constant at 25°C *</i>	K _t	Nm/A	1.10	0.55	0.46	0.37	1.37	0.83	0.55	0.46
Ondulazione di coppia <i>Torque ripple</i>	—	%	1.5	1.5	1.5	1.5	1.5	1.5	1.5	1.5
Massima temperatura ambiente <i>Maximum room temperature</i>	t _{max}	°C	40	40	40	40	40	40	40	40
Classe d'isolamento <i>Insulation class</i>	—	—	F	F	F	F	F	F	F	F
Momento d'inerzia * <i>Moment of inertia *</i>	J	Kgm ²	0.014	0.014	0.014	0.014	0.014	0.014	0.014	0.014
Peso <i>Weight</i>	G	kg	27	27	27	27	27	27	27	27

(*) Tolleranza ±10% Tolerance ± 10%

Curve operative con alimentazione in corrente continua
 fattore di forma = 1 e temperatura ambiente 40° C

Operating curves with Dc supply
 form factor = 1 and ambient temperature 40° C

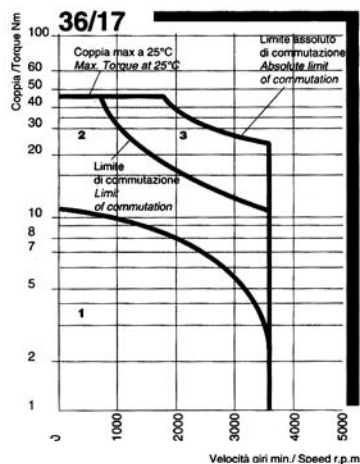
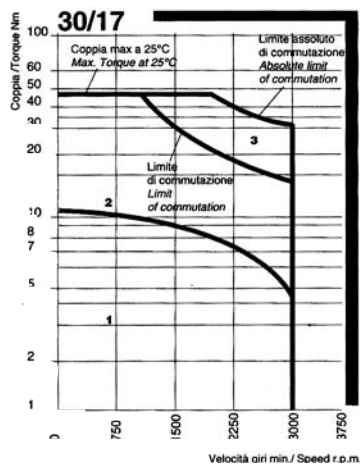
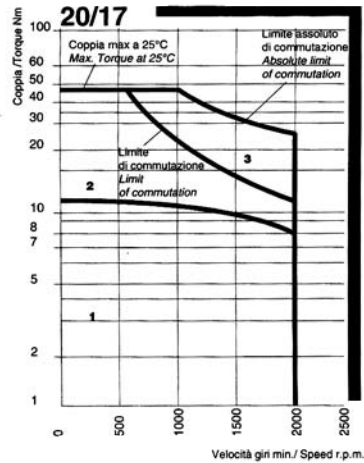
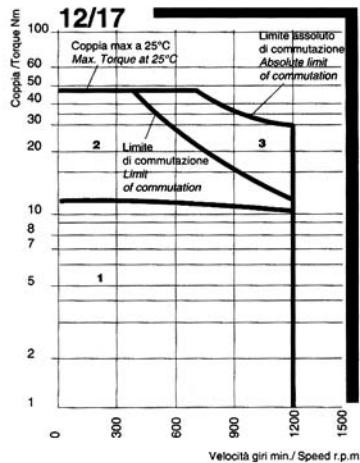
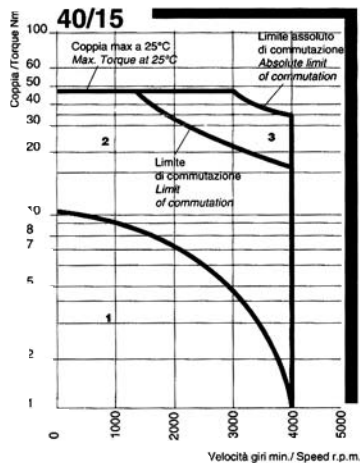
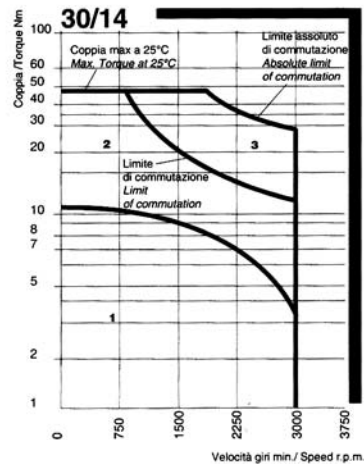
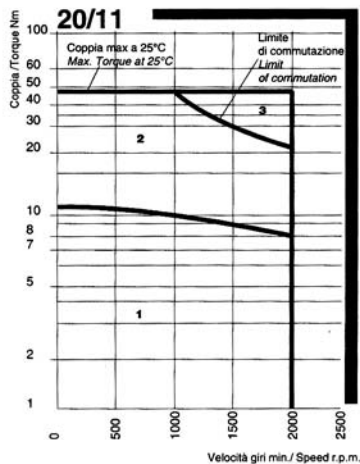
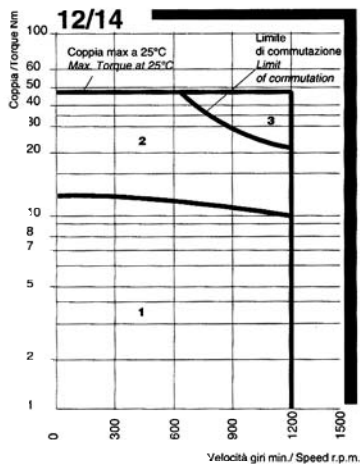

- 1) Area di funzionamento continuo
- 2) Area di funzionamento intermittente
- 3) Area di accelerazione o decelerazione

- 1) Continuous duty area
- 2) Intermittent duty area
- 3) Area of acceleration and deceleration

BR 80 L

Parametri / Parameters	Simboli Symbols	Unità di misura Measure unit	Tipo di avvolgimento Types of winding							
			12/13	20/14	24/13	30/13	12/17	20/17	30/17	36/15
Coppia nominale continuativa a rotore bloccato, esecuzione chiusa Ta = 40°C <i>Continuous stall torque totally enclosed non ventilated version Amb. t. = 40°C</i>	C _n	Nm	16.4	15.9	15.6	14.8	16.7	16.2	15.6	14.8
Corrente nominale in esecuzione chiusa <i>Nominal current</i>	I _n	A	14.9	23.2	28.5	36	12.2	19.8	28.5	36
Velocità nominale <i>Nominal speed</i>	n _{max}	g/min	1200	2000	2400	3000	1200	2000	3000	3600
F.C.E.M. alla velocità nominale * <i>C.E.M.F. at nominal speed *</i>	E _{max}	Volt	139	144	138	130	173	173	173	155
Picco di coppia allo spunto a 25°C <i>Peak stall torque at 25°C</i>	C _p	Nm	70	70	70	70	70	70	70	70
Corrente al picco di coppia a 25°C <i>Current at peak torque at 25°C</i>	I _p	A	63.6	102	127	170	51	85	127	170
Max accelerazione teorica allo spunto <i>Max theoretical acceleration at peak torque</i>	α _p	rad/s ²	3500	3500	3500	3500	3500	3500	3500	3500
Tensione al picco di coppia a 25°C <i>Voltage at peak torque at 25°C</i>	V _p	Volt	37	25	23	21	45	29	23	21
Resistenza d'armatura a 25°C senza spazzole * <i>Armature resistance at 25°C without brushes *</i>	R _a	Ω	0.52	0.19	0.12	0.07	0.82	0.28	0.12	0.007
Resistenza d'armatura a 25°C con spazzole * <i>Armature resistance at 25°C with brushes *</i>	R _m	Ω	0.57	0.24	0.17	0.12	0.87	0.33	0.17	0.12
Induttanza d'armatura * <i>Armature inductance *</i>	L _a	mH	3.9	1.5	0.97	0.55	6.1	2.1	0.97	0.55
Costante di tempo elettrica a 25°C * <i>Electrical time constant at 25°C *</i>	T _e	ms	6.8	6.1	5.5	4.5	7.0	6.3	5.5	4.5
Costante di tempo meccanica a 25°C * <i>Mechanical time constant at 25°C *</i>	T _m	ms	9.6	10.4	11.7	14.4	9.3	10.0	11.7	14.4
Costante di tempo termica * <i>Thermal time constant *</i>	T _t	min	100	100	100	100	100	100	100	100
Costante di tensione a 25°C * <i>Voltage constant at 25°C *</i>	K _e	Vs/rad	1.10	0.69	0.55	0.41	1.37	0.82	0.55	0.41
Costante di coppia a 25°C * <i>Torque constant at 25°C *</i>	K _t	Nm/A	1.10	0.69	0.55	0.41	1.37	0.82	0.55	0.41
Ondulazione di coppia <i>Torque ripple</i>	—	%	1.5	1.5	1.5	1.5	1.5	1.5	1.5	1.5
Massima temperatura ambiente <i>Maximum room temperature</i>	t _{max}	°C	40	40	40	40	40	40	40	40
Classe d'isolamento <i>Insulation class</i>	—	—	F	F	F	F	F	F	F	F
Momento d'inerzia * <i>Moment of inertia *</i>	J	Kgm ²	0.020	0.020	0.020	0.020	0.020	0.020	0.020	0.020
Peso <i>Weight</i>	G	kg	34	34	34	34	34	34	34	34

(*) Tolleranza ±10% Tolerance ± 10%

Curve operative con alimentazione in corrente continua
 fattore di forma = 1 e temperatura ambiente 40° C

Operating curves with Dc supply
 form factor = 1 and ambient temperature 40° C

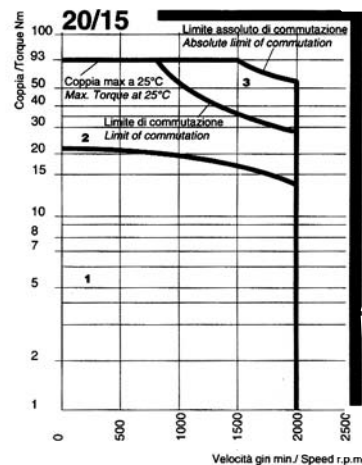
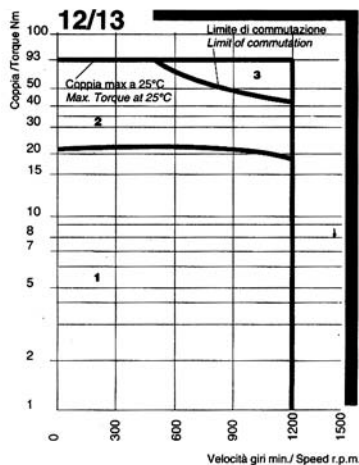
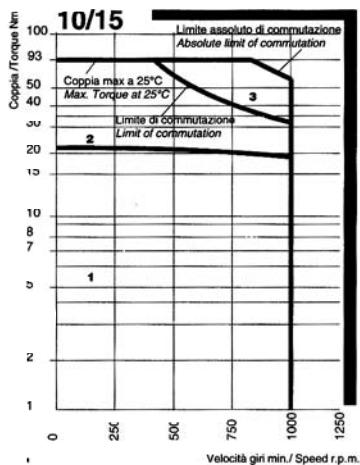

- 1) Area di funzionamento continuo
- 2) Area di funzionamento intermittente
- 3) Area di accelerazione o decelerazione

- 1) Continuous duty area
- 2) Intermittent duty area
- 3) Area of acceleration and deceleration

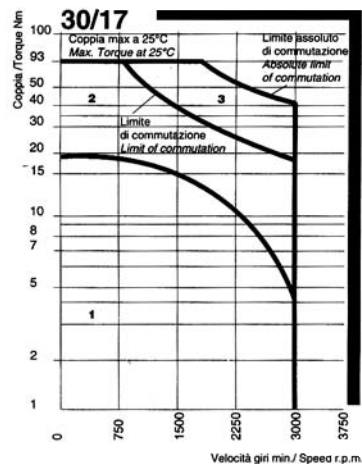
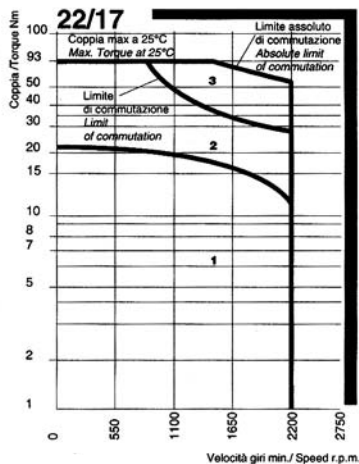
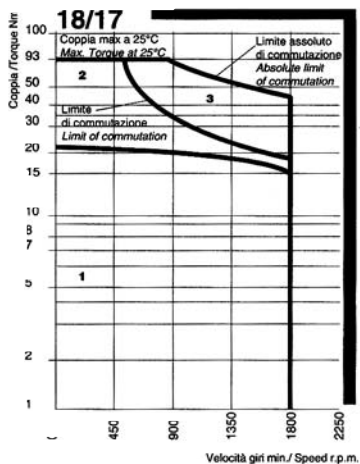

BR 80 P

Parametri / Parameters	Simboli Symbols	Unità di misura Measure unit	Tipo di avvolgimento Types of winding					
			10/15	12/13	20/15	18/17	22/17	30/17
Coppia nominale continuativa a rotore bloccato, esecuzione chiusa Ta = 40°C <i>Continuous stall torque totally enclosed non ventilated version Amb. t. = 40°C</i>	C _n	Nm	21.8	21.2	20.6	21.2	20.6	19.6
Corrente nominale in esecuzione chiusa <i>Nominal current</i>	I _n	A	14.8	19.2	28.2	23	28.2	35.4
Velocità nominale <i>Nominal speed</i>	n _{max}	g/min	1000	1200	2000	1800	2200	3000
F.C.E.M. alla velocità nominale * <i>C.E.M.F. at nominal speed *</i>	E _{max}	Volt	154	138	154	173	170	173
Picco di coppia allo spunto a 25°C <i>Peak stall torque at 25°C</i>	C _p	Nm	93	93	93	93	93	93
Corrente al picco di coppia a 25°C <i>Current at peak torque at 25°C</i>	I _p	A	63	84	127	101	127	168
Max accelerazione teorica allo spunto <i>Max theoretical acceleration at peak torque</i>	α _p	rad/s ²	3575	3575	3575	3575	3575	3575
Tensione al picco di coppia a 25°C <i>Voltage at peak torque at 25°C</i>	V _p	Volt	44	35	26	29	26	23
Resistenza d'armatura a 25°C senza spazzole * <i>Armature resistance at 25°C without brushes *</i>	R _a	Ω	0.64	0.36	0.15	0.23	0.15	0.08
Resistenza d'armatura a 25°C con spazzole * <i>Armature resistance at 25°C with brushes *</i>	R _m	Ω	0.69	0.41	0.20	0.28	0.20	0.13
Induttanza d'armatura * <i>Armature inductance *</i>	L _a	mH	4.9	2.9	1.3	1.9	1.3	0.7
Costante di tempo elettrica a 25°C * <i>Electrical time constant at 25°C *</i>	T _e	ms	7.1	7.0	6.4	6.6	6.4	5.1
Costante di tempo meccanica a 25°C * <i>Mechanical time constant at 25°C *</i>	T _m	ms	8.4	8.8	9.6	8.9	9.6	11.8
Costante di tempo termica * <i>Thermal time constant *</i>	T _t	min	110	110	110	110	110	110
Costante di tensione a 25°C * <i>Voltage constant at 25°C *</i>	K _e	Vs/rad	1.47	1.10	0.73	0.92	1.73	0.55
Costante di coppia a 25°C * <i>Torque constant at 25°C *</i>	K _t	Nm/A	1.47	1.10	0.73	0.92	1.73	0.55
Ondulazione di coppia <i>Torque ripple</i>	—	%	1.5	1.5	1.5	1.5	1.5	1.5
Massima temperatura ambiente <i>Maximum room temperature</i>	t _{max}	°C	40	40	40	40	40	40
Classe d'isolamento <i>Insulation class</i>	—	—	F	F	F	F	F	F
Momento d'inerzia * <i>Moment of inertia *</i>	J	Kgm ²	0.026	0.026	0.026	0.026	0.026	0.026
Peso <i>Weight</i>	G	kg	41	41	41	41	41	41

(*) Tolleranza ±10% Tolerance ± 10%

Curve operative con alimentazione in corrente continua
fattore di forma = 1 e temperatura ambiente 40° C

Operating curves with Dc supply
form factor = 1 and ambient temperature 40° C

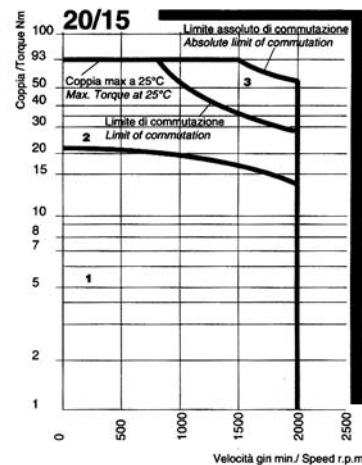
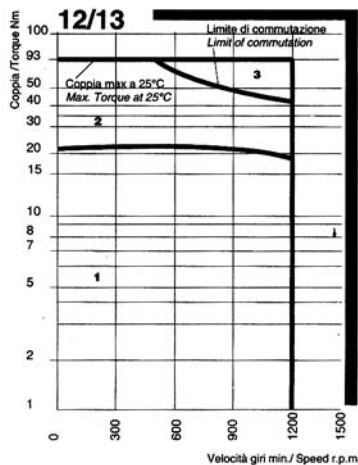
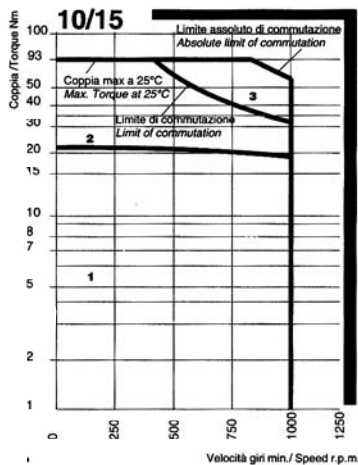

- 1) Area di funzionamento continuo
- 2) Area di funzionamento intermittente
- 3) Area di accelerazione o decelerazione

- 1) Continuous duty area
- 2) Intermittent duty area
- 3) Area of acceleration and deceleration

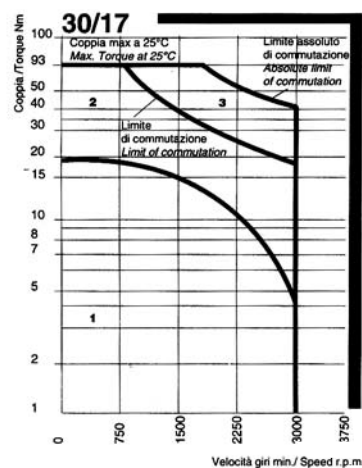
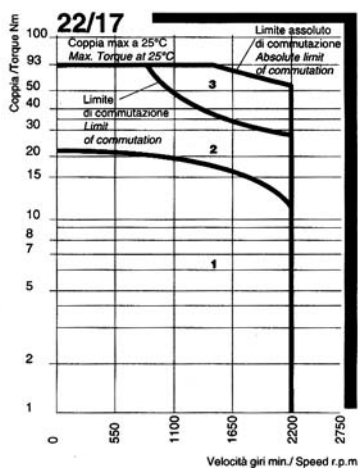
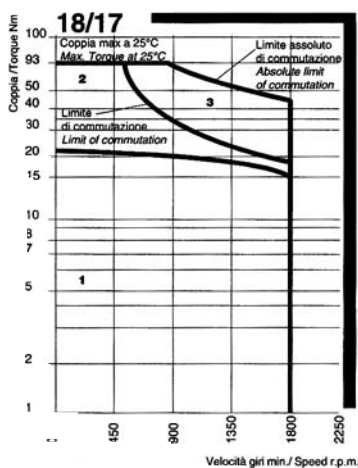

BR100 S - M

Parametri / Parameters	Simboli Symbols	Unità di misura Measure unit	BR 100 S				BR 100 M			
			10/11	15/12	20/11	30/12	10/11	15/12	20/11	30/12
Coppia nominale continuativa a rotore bloccato, esecuzione chiusa Ta = 40°C <i>Continuous stall torque totally enclosed non ventilated version Amb. t. = 40°C</i>	C _n	Nm	8.3	8.3	8.3	8.3	15	15	15	15
Corrente nominale in esecuzione chiusa <i>Nominal current</i>	I _n	A	7.9	10.5	15.8	20.8	14.2	18.9	28.4	37.4
Velocità nominale <i>Nominal speed</i>	n _{max}	g/min	1000	1500	2000	3000	1000	1500	2000	3000
F.C.E.M. alla velocità nominale * <i>C.E.M.F. at nominal speed *</i>	E _{max}	Volt	110	124	110	124	110	124	110	124
Picco di coppia allo spunto a 25°C <i>Peak stall torque at 25°C</i>	C _p	Nm	63	63	63	63	125	125	125	125
Corrente al picco di coppia a 25°C <i>Current at peak torque at 25°C</i>	I _p	A	60	80	120	160	119	159	238	318
Max accelerazione teorica allo spunto <i>Max theoretical acceleration at peak torque</i>	α _p	rad/s ²	5250	5250	5250	5250	5950	5950	5950	5950
Tensione al picco di coppia a 25°C <i>Voltage at peak torque at 25°C</i>	V _p	Volt	81	60	43	34	58	44	34	29
Resistenza d'armatura a 25°C senza spazzole * <i>Armature resistance at 25°C without brushes *</i>	R _a	Ω	1.301	0.702	0.325	0.176	0.460	0.249	0.115	0.062
Resistenza d'armatura a 25°C con spazzole * <i>Armature resistance at 25°C with brushes *</i>	R _m	Ω	1.391	0.790	0.395	0.246	0.520	0.309	0.175	0.122
Induttanza d'armatura * <i>Armature inductance *</i>	L _a	mH	5.3	2.9	1.3	0.8	2.29	1.25	0.55	0.32
Costante di tempo elettrica a 25°C * <i>Electrical time constant at 25°C *</i>	T _e	ms	3.8	3.7	3.3	3.2	4.4	4.0	3.2	2.6
Costante di tempo meccanica a 25°C * <i>Mechanical time constant at 25°C *</i>	T _m	ms	15.1	15.2	16.8	18.4	9.7	10.4	13.1	16
Costante di tempo termica * <i>Thermal time constant *</i>	T _t	min	50	50	50	50	70	70	70	70
Costante di tensione a 25°C * <i>Voltage constant at 25°C *</i>	K _e	Vs/rad	1.05	0.79	0.53	0.40	1.06	0.79	0.53	0.40
Costante di coppia a 25°C * <i>Torque constant at 25°C *</i>	K _t	Nm/A	1.05	0.79	0.53	0.40	1.06	0.79	0.53	0.40
Ondulazione di coppia <i>Torque ripple</i>	—	%	1	1	1	1	1	1	1	1
Massima temperatura ambiente <i>Maximum room temperature</i>	t _{max}	°C	40	40	40	40	40	40	40	40
Classe d'isolamento <i>Insulation class</i>	—	—	F	F	F	F	F	F	F	F
Momento d'inerzia * <i>Moment of inertia *</i>	J	Kgm ²	0.012	0.012	0.012	0.012	0.021	0.021	0.021	0.021
Peso <i>Weight</i>	G	kg	24	24	24	24	33	33	33	33

(*) Tolleranza ±10% Tolerance ± 10%

Curve operative con alimentazione in corrente continua
 fattore di forma = 1 e temperatura ambiente 40° C

Operating curves with Dc supply
 form factor = 1 and ambient temperature 40° C

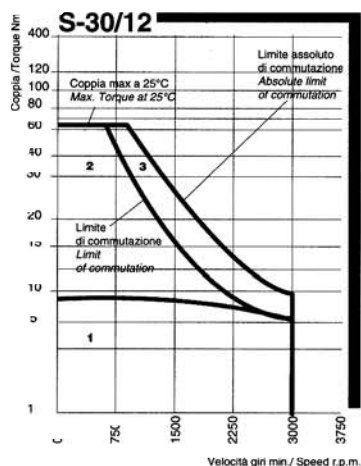
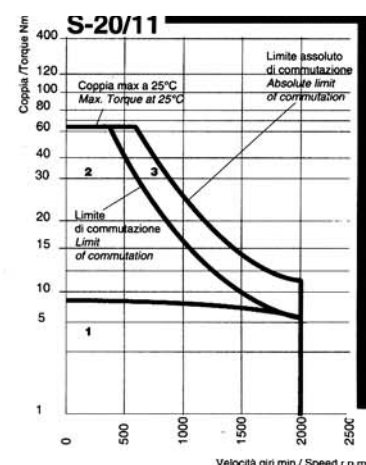
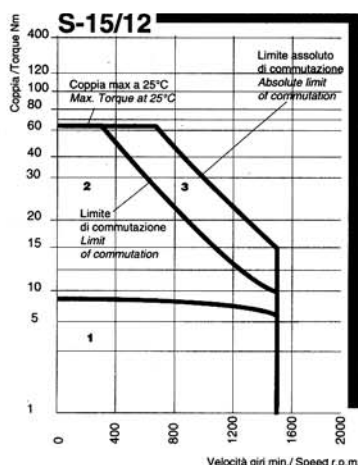
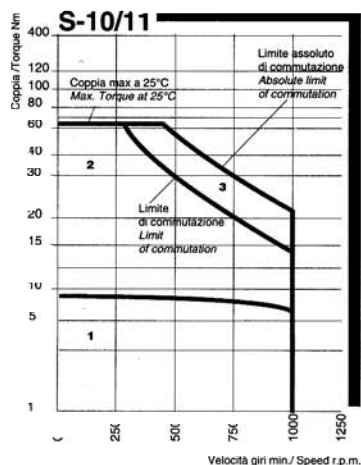

- 1) Area di funzionamento continuo
 - 2) Area di funzionamento intermittente
 - 3) Area di accelerazione o decelerazione
- 1) Continuous duty area
 2) Intermittent duty area
 3) Area of acceleration and deceleration

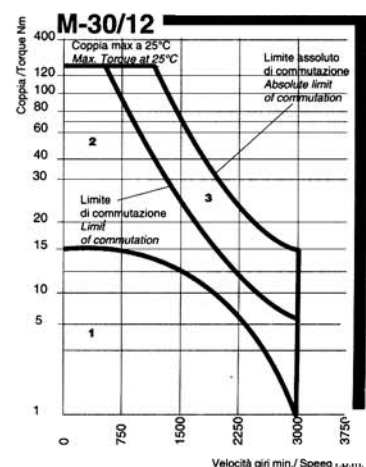
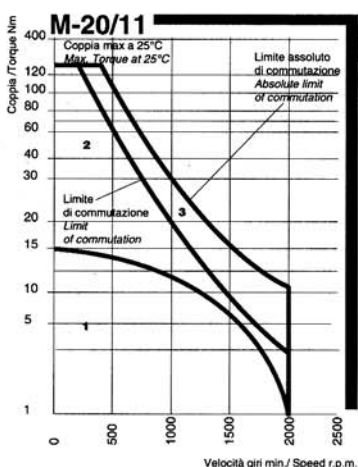
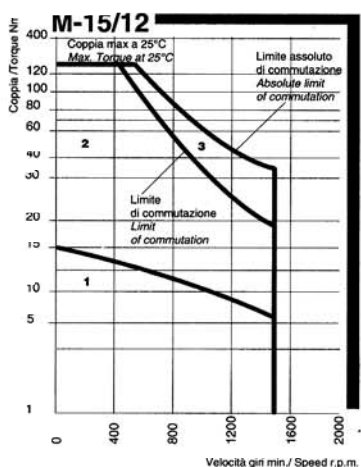
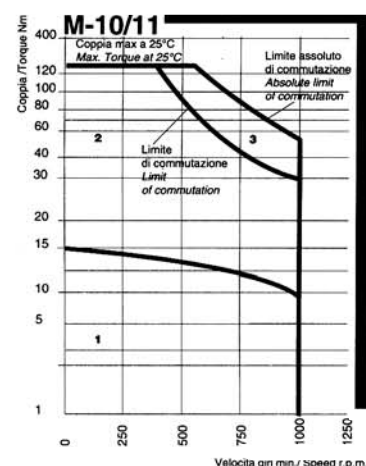

BR 100 L - P - X

Parametri / Parameters	Simboli Symbols	Unità di misura Measure unit	BR 100 L				BR 100 P			BR 100 X	
			10/12	15/12	20/12	30/12	10/11	15/12	25/13	12/12	20/13
Coppia nominale continuativa a rotore bloccato, esecuzione chiusa Ta = 40°C <i>Continuous stall torque totally enclosed non ventilated version Amb. t. = 40°C</i>	C _n	Nm	21.3	21.3	21.3	18	28	26	22	36	30
Corrente nominale in esecuzione chiusa <i>Nominal current</i>	I _n	A	18.1	27	36.2	44.7	27	33	42	36.2	44.4
Velocità nominale <i>Nominal speed</i>	n _{max}	g/min	1000	1500	2000	3000	1000	1500	2500	1200	2000
F.C.E.M. alla velocità nominale * <i>C.E.M.F. at nominal speed *</i>	E _{max}	Volt	124	124	124	124	110	124	138	124	138
Picco di coppia allo spunto a 25°C <i>Peak stall torque at 25°C</i>	C _p	Nm	190	190	190	190	250	250	250	317	317
Corrente al picco di coppia a 25°C <i>Current at peak torque at 25°C</i>	I _p	A	161	240	321	480	240	320	480	319	470
Max accelerazione teorica allo spunto <i>Max theoretical acceleration at peak torque</i>	α _p	rad/s ²	5930	5930	5930	5930	5680	5685	5685	5760	5760
Tensione al picco di coppia a 25°C <i>Voltage at peak torque at 25°C</i>	V _p	Volt	57	43	36	38	50	40	40	46	46
Resistenza d'armatura a 25°C senza spazzole * <i>Armature resistance at 25°C without brushes *</i>	R _a	Ω	0.322	0.149	0.080	0.048	0.181	0.098	0.058	0.116	0.069
Resistenza d'armatura a 25°C con spazzole * <i>Armature resistance at 25°C with brushes *</i>	R _m	Ω	0.382	0.209	0.140	0.108	0.236	0.153	0.113	0.171	0.124
Induttanza d'armatura * <i>Armature inductance *</i>	L _a	mH	1.60	0.77	0.38	0.28	0.92	0.54	0.24	0.67	0.30
Costante di tempo elettrica a 25°C * <i>Electrical time constant at 25°C *</i>	T _e	ms	4.2	3.7	2.7	2.6	3.9	3.5	2.1	3.9	2.4
Costante di tempo meccanica a 25°C * <i>Mechanical time constant at 25°C *</i>	T _m	ms	8.8	10.7	12.8	21.6	9.6	10.8	18.4	9.6	14.7
Costante di tempo termica * <i>Thermal time constant *</i>	T _t	min	90	90	90	90	110	110	110	130	130
Costante di tensione a 25°C * <i>Voltage constant at 25°C *</i>	K _e	Vs/rad	1.18	0.79	0.59	0.40	1.04	0.79	0.52	0.99	0.68
Costante di coppia a 25°C * <i>Torque constant at 25°C *</i>	K _t	Nm/A	1.18	0.79	0.59	0.40	1.04	0.79	0.52	0.99	0.68
Ondulazione di coppia <i>Torque ripple</i>	—	%	1	1	1	1	1	1	1	1	1
Massima temperatura ambiente <i>Maximum room temperature</i>	t _{max}	°C	40	40	40	40	40	40	40	40	40
Classe d'isolamento <i>Insulation class</i>	—	—	F	F	F	F	F	F	F	F	F
Momento d'inerzia * <i>Moment of inertia *</i>	J	Kgm ²	0.032	0.032	0.032	0.032	0.044	0.044	0.044	0.055	0.055
Peso <i>Weight</i>	G	kg	42	42	42	42	51	51	51	60	60

(*) Tolleranza ±10% Tolerance ± 10%

Curve operative con alimentazione in corrente continua
 fattore di forma = 1 e temperatura ambiente 40° C

Operating curves with Dc supply
 form factor = 1 and ambient temperature 40° C

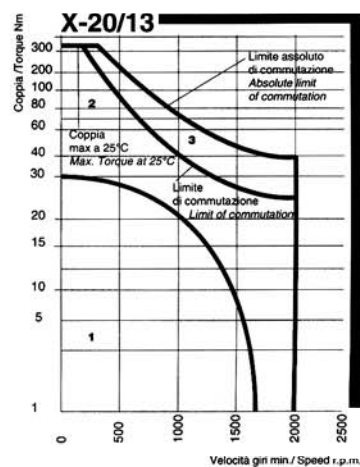
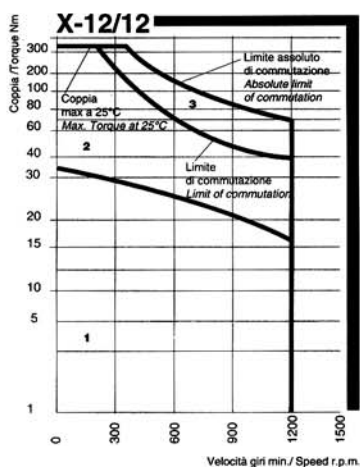
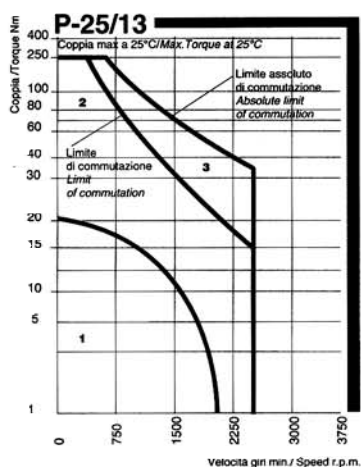
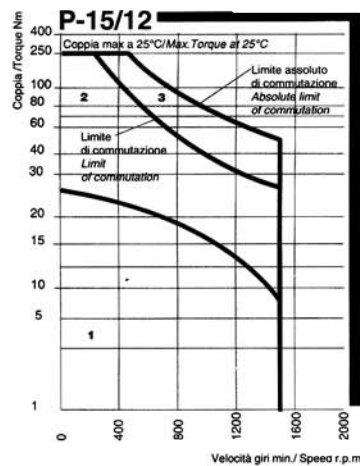
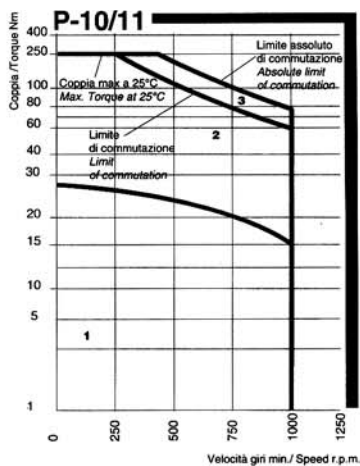
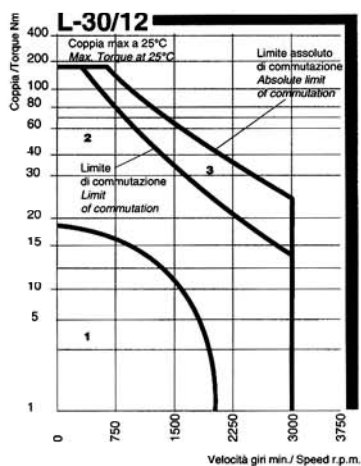
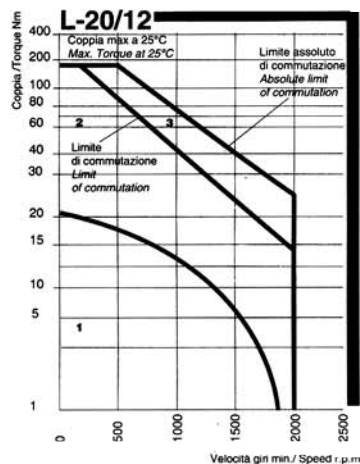
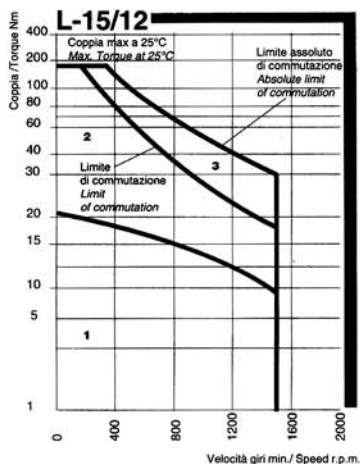
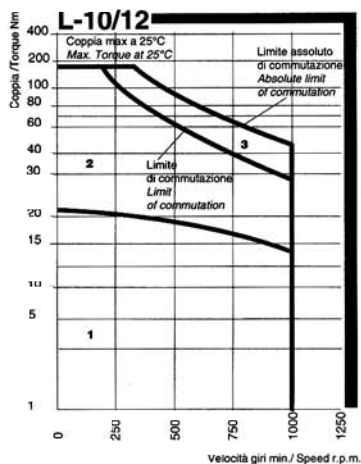

Dimensioni d'ingombro

Overall dimensions

2059/B - BR60

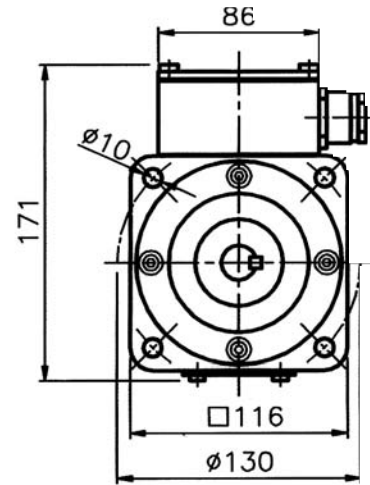
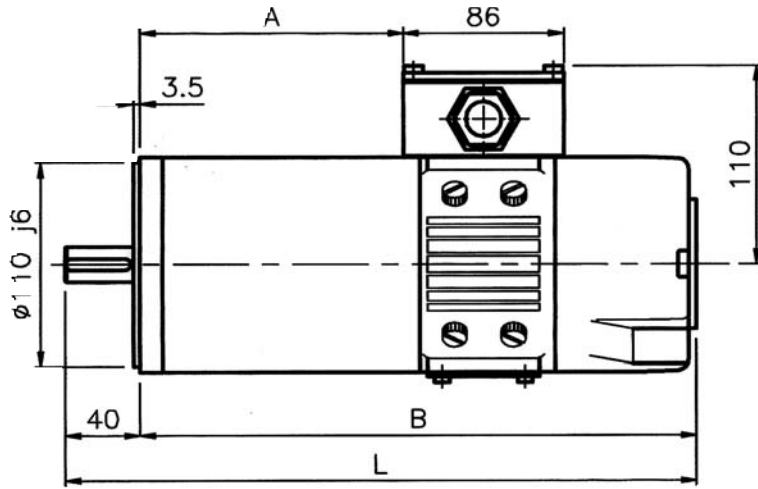

TIPO	A	B	L		
BR60	S	141	298	338	Nelle versioni complete di freno, le quote A,B,L aumentano di 44mm In the version with brake, the quotas A,B,L increase by 44mm
	M	207	364	404	
	L	273	430	470	

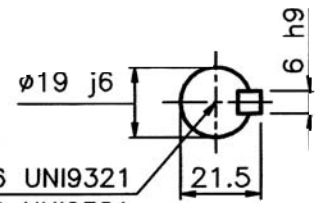

CENTRO M6 UNI9321
CENTRE M6 UNI9321

2061/B - BR80

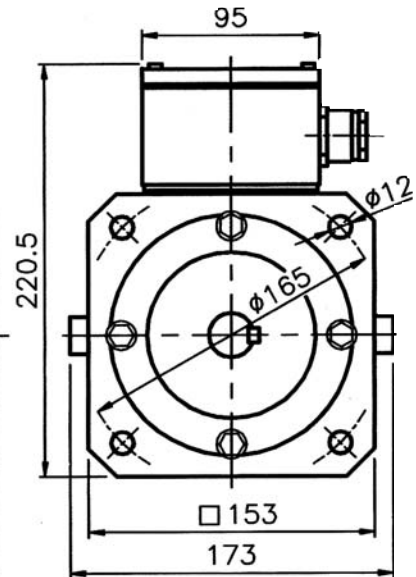
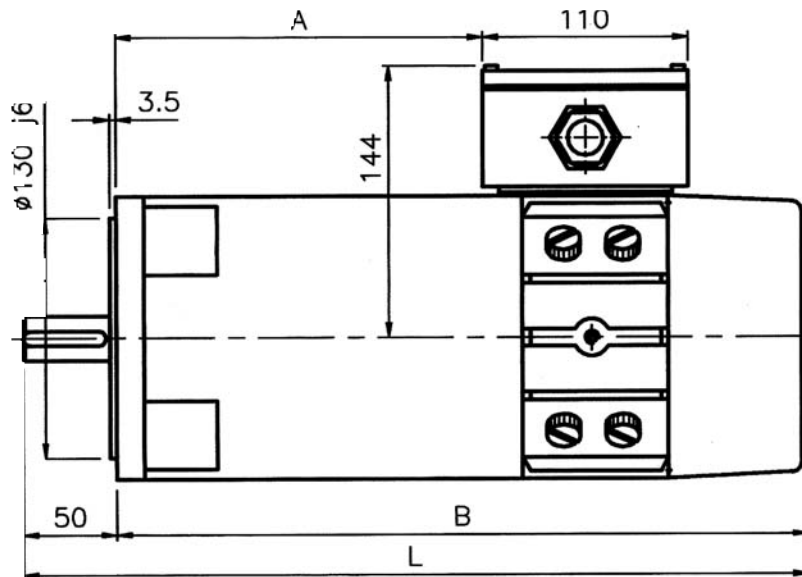

TIPO	A	B	L		
BR80	S	136	310	360	Nelle versioni complete di freno, le quote A,B,L aumentano di 52mm In the version with brake, the quotas A,B,L increase by 52mm
	M	197	371	421	
	L	258	432	482	
	P	319	493	543	

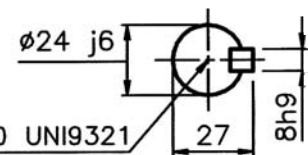

CENTRO M10 UNI9321
CENTRE M10 UNI9321

Dimensioni d'ingombro

Overall dimensions

2054/B - BR100

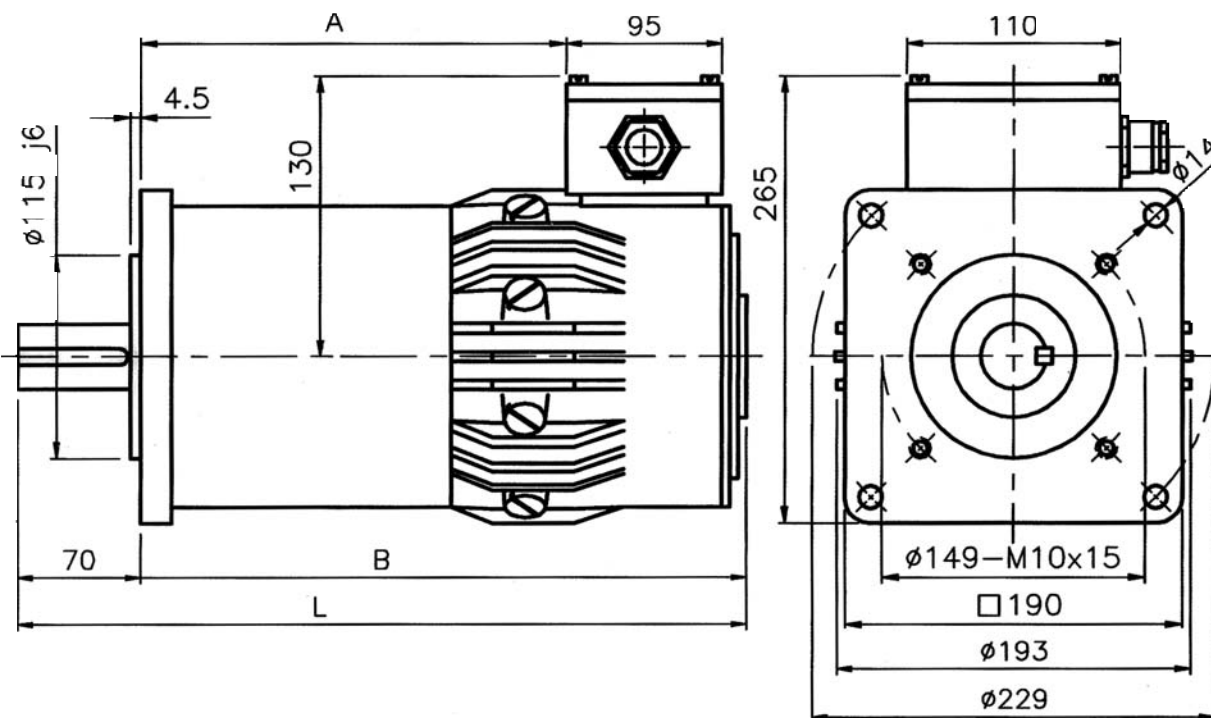

TIPO	A	B	L
S	195	308	378
M	265	378	448
BR100 L	335	448	518
P	405	518	588
X	475	588	658

Nelle versioni complete di freno, le quote A,B,L aumentano di 52mm
 In the version with brake, the quotas A,B,L increase by 52mm

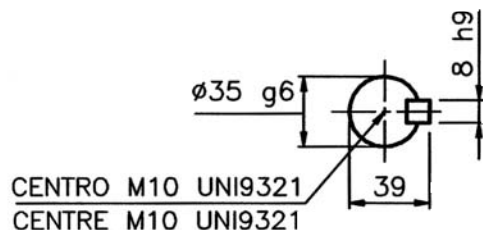

1010/0 - BR60 / 80 / 100

PREDISPOSIZIONE PER ENCODER
 PRE-ARRANGEMENT FOR ENCODER

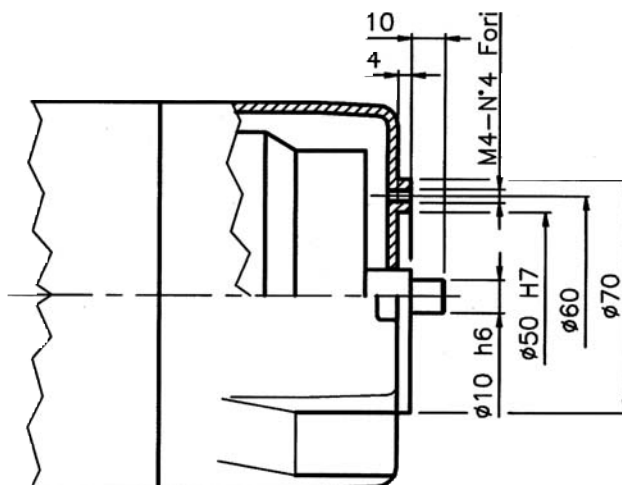



PRODUCTION PROGRAM

DC Motors

DC Servomotors

Brushless Servomotors

Tachogenerators and centrifugal relays

DC servomotor converters

Brushless servomotor converters

Asynchronous vectorial motors

PROGRAMMA DI PRODUZIONE

Motori in corrente continua

Servomotori in corrente continua

Servomotori Brushless

Dinamo tachimetriche e Relè centrifughi

Convertitori per servomotori in C.C.

Convertitori per servomotori Brushless

Motori asincroni vettoriali



MAGNETIC SpA

Sede Amm.va e Stabilimento:
Via Fracanzana, 14
36054 Montebello Vicentino (VI) Italy
Tel. (0444) 649399
Fax (0444) 440495
E-mail: info@magneticspa.it
Web site: www.magneticspa.it

