



Section		Page
1	<i>Presentation</i>	
	Contents	3
	1.1 General	4
	1.2 Hardware Installation	9
2	<i>Software Installation</i>	
	Contents	13
	2.1 Principles	14
	2.2 Examples of Communication Between PLCs	28
	2.3 Application Example	38
	2.4 Additional Programming Information	44
3	<i>Appendix</i>	
	Contents	47
	3.1 Performance Levels	48
	3.2 Requests Supported by TSX Series 7 PLCs	49
	3.3 Standard Requests	51
	3.4 Specific Read Requests	55
	3.5 Specific Write Requests	67
	3.6 Exchange Possibilities	77



Sub-section	Page
1.1 General	4
1.1-1 Overview	4
1.1-2 Reminders	5
1.1-3 Exchanges Between PLCs and XBT Terminals	6
1.1-4 Exchanges Between PLCs and Sensors and Actuators	7
1.1-5 Exchanges Between PLCs	8
1.2 Hardware Installation	9
1.2-1 Hardware Description	9
1.2-2 Connection to the Uni-Telway Bus	10
1.2-3 Connecting the Programming Terminal	11
1.2-4 Using the programming port on the TSX 17-20 PLC	12

1.1 General

1.1-1 Overview

The Uni-Telway industrial bus is the standard means of communication between Telemecanique control devices including: PLCs, operator dialog terminals, speed drives, numerical controls, weighing indicators.

Uni-Telway also simplifies communication with devices from other vendors, such as supervision and control computers.

Uni-Telway can be used for two types of application:

- **Control and surveillance of system devices by PLC:**

Devices such as ATV45 speed drives, LT8 protection relays, ASN specialized couplers, numerical controls.

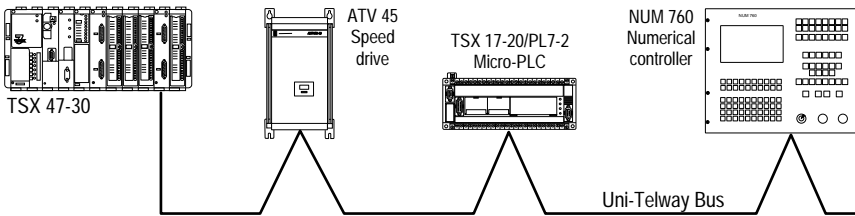

- **Man-Machine dialog and supervision:**

Devices such as XBT operator dialog terminals or Monitor 77, and the capacity to support open communications with networks and computers from other vendors.



Uni-Telway requires:

- **1 Master**

This device supervises the data link and checks its operation. It controls the allocation of bus access time to the various connected devices. This location comprises a TSX Series 7 PLC equipped with a TSX SCM 21.6 (for TSX 47/67/87 PLCs) or a TSX SCG 116 (for TSX 17-20 PLCs) serial communication module.

- **1 to 27 Slaves**

The services available depend on the devices connected. Services are accessed through a standard or specific question and answer dialog.

Standard requests are described in the Uni-Telway Reference Manual. Requests that are specific to TSX-17 PL7-2 Micro-PLCs are described in the Appendix of this manual.

Operating Modes

The Micro-PLC is a Slave supporting Client and/or Server status.

The TSX 17-20 controls the physical and data link layers of the Uni-Telway protocol. It performs the routing to and from the PLC processor that handles Uni-Telway protocol control.

1.1-2 Reminders

CLIENT: The device that initiates communications. It asks questions (reads), sends answers (writes) or orders (Run, Stop, etc.).

SERVER: The device that executes the order sent by the client and sends a confirm after execution.

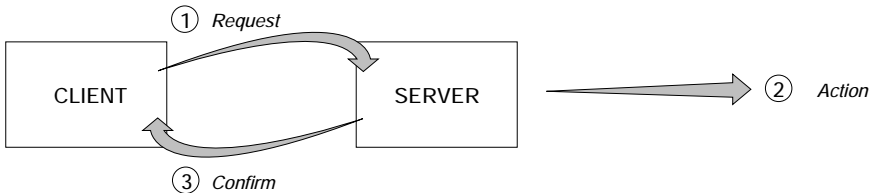

A PLC is a server for its system tasks (programming, adjust, diagnostics). It is also a Client of other PLCs (and machine tool numerical controls, sensors, actuators) via the user program text blocks (when sending commands, reading status data).

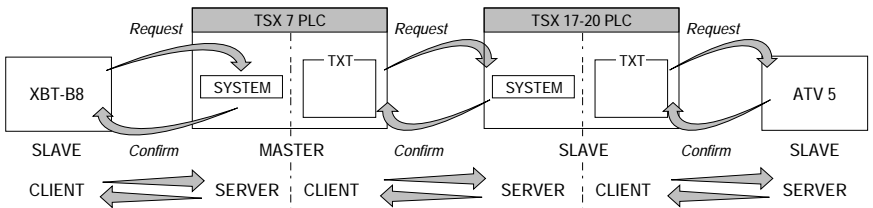

Important: Being a Client or a Server is completely separate from the master/slave relationship on the bus.

1.1-3 Exchanges Between PLCs and XBT Terminals

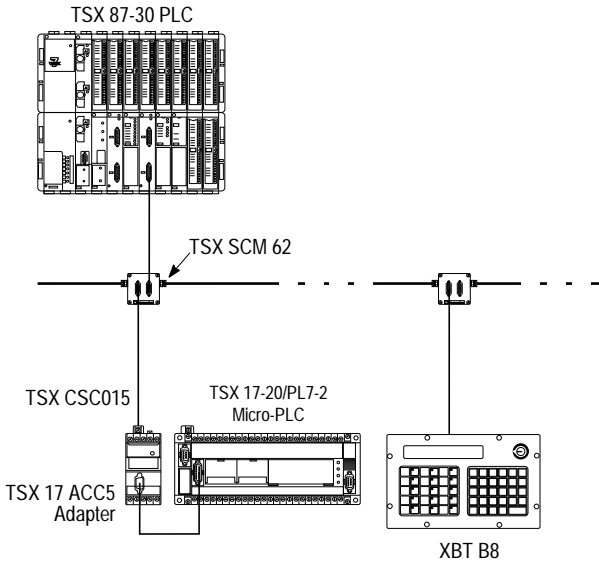

TSX 87-30 The TSX SCM 21.6 module is the data link **master**. The PLC system is a **server** that answers requests from Monitor 77 and XBT terminals.

TSX 17-20 A **slave** with **client** status from its application program or **server** status from its system.

XBT-B8 A **slave** with **client** or **server** status.
As a **client** it can be used to adjust TSX Series 7 PLCs (adjust bits, words, function blocks, etc.).
As a **server** it can display messages received, etc.

1.1-4 Exchanges Between PLCs and Sensors and Actuators

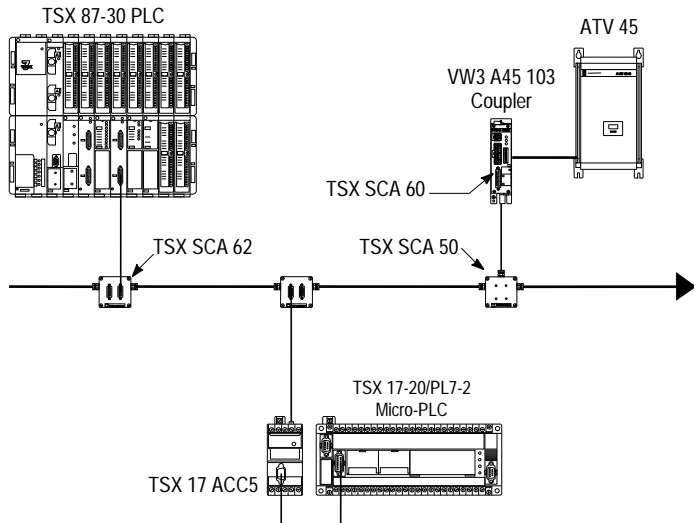

PLC

The TSX SCM 21.6 module in the TSX 87-30 is the data link **master**. The TSX 17 ACC5 Adapter on the TSX 17-20 is a **slave**. Their application programs, via the text blocks are **clients** that can:

- . start and stop the ATV45,
- . set the acceleration or deceleration slopes,
- . set the direction of motion (forward or reverse),
- . display a velocity instruction,
- . request information (status, reading values),
- . etc.

ATV45

A slave with **server** status, that can provide the PLC with various types of information:

- . mains voltage,
- . stator current,
- . rotation frequency,
- . thermal status,
- . etc.

1.1-5 Exchanges Between PLCs

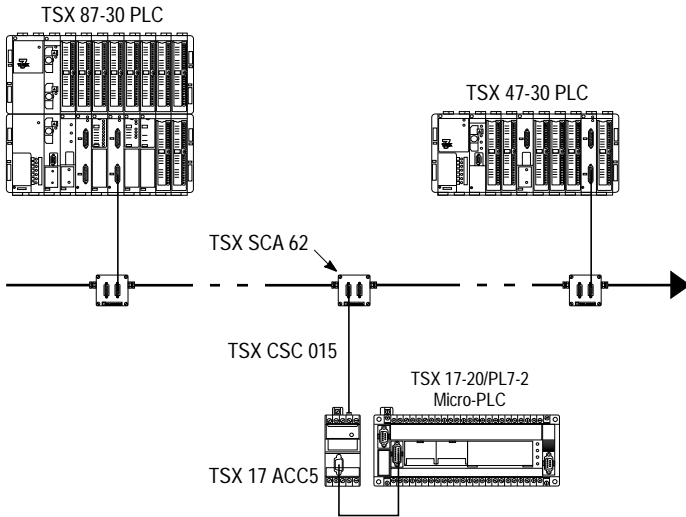

PLCs

In the configuration illustrated above, the TSX SCM 21.6 module in the TSX 87-30 PLC is the data link **master**.

The TSX 17-20 PLC and the TSX SCM 21.6 module in the TSX 47-30 PLC are **slaves**.

Each PLC is a **client** via its application program and a **server** via its system.

1.2 Hardware Installation

1.2-1 Hardware Description

Connection to a Uni-Telway Bus requires:

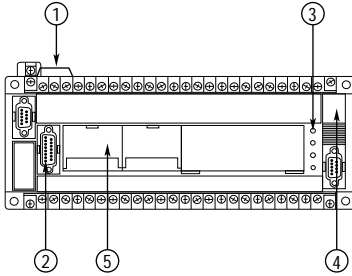

A TSX 17 Micro-PLC with a PL7-2 language software cartridge, Ref. number TSXP17 20F., comprising:

- ① power supply,
- ② processor with programming port (15-pin connector),
- ③ processor status indicator,
- ④ 24K byte RAM program memory (and 2K bytes of data when using PL7-2 language) that can be battery backed-up,
- ⑤ location for the plug-on PL7-2 language cartridge.

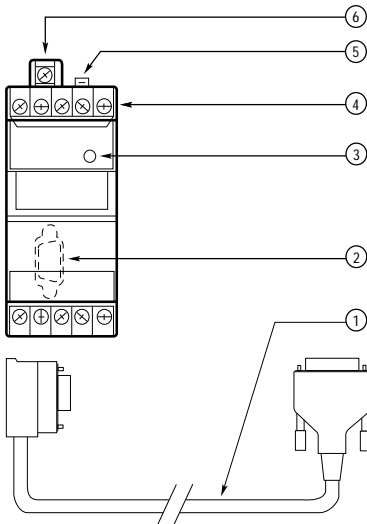

An adapter module (Ref. TSX 17 ACC5) that connects the Micro-PLC to the Uni-Telway bus via the programming port, comprising:

- ① 0.90 meter cable that is used to connect the TSX 17 ACC5 adapter to the programming port of the PLC,
- ② 9-pin connector, that connects to the programming port of the PLC,
- ③ indicator LED that indicates when the module is connected to the PLC's programming port,
- ④ connector to connect by cable directly to the Uni-Telway bus,
- ⑤ 15-pin connector that is used to connect the adapter to a TSX SCA 62 subscriber socket and the Uni-Telway bus,
- ⑥ ground connector for grounding the device.

There are two ways of connecting a TSX 17 ACC5 adapter:

- . standard connection: use connector ⑤ ,
- . specific connection: use connector ④ .

1.2-2 Connection to the Uni-Telway Bus

Connection to the TSX 17-20 PLC can be made in two ways:

- by **standard connection** via a TSX SCA 62 subscriber socket and a TSX CSC 015 cable (length 1.5 meters) that connects to the 15-pin connector on the top of the TSX 17 ACC5 Adapter module.

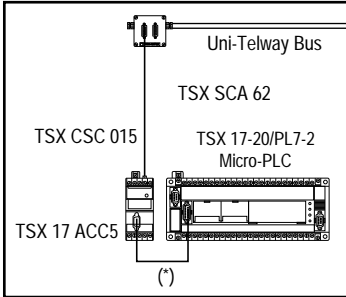

(*) Cable supplied with TSX 17 ACC5 adapter

The address coding of a TSX 17-20 Micro-PLC on a Uni-Telway bus is defined by software configuration. The settings of the microswitches located in the subscriber sockets are overridden.

When a TSX 17-20 Micro-PLC is located at the end of the line, the line adapter jumper must be set to ON refer to the Uni-Telway Bus Reference Manual (TSX D24 004E).

- by **specific connection** directly to the Uni-Telway bus via the screw connectors on the terminal block of the TSX 17 ACC5 adapter module. This type of connection is difficult to implement and requires strict observation of the wiring precautions when making the connections including cutting power to the PLC and the Adapter, to the Uni-Telway bus and all devices connected to it, for the entire duration of wiring operations.

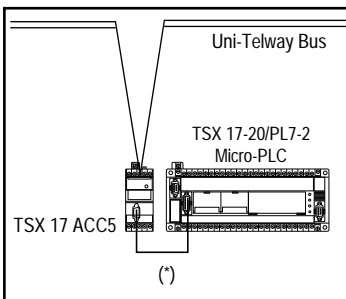

(*) Cable supplied with the TSX 17 ACC5 adapter.

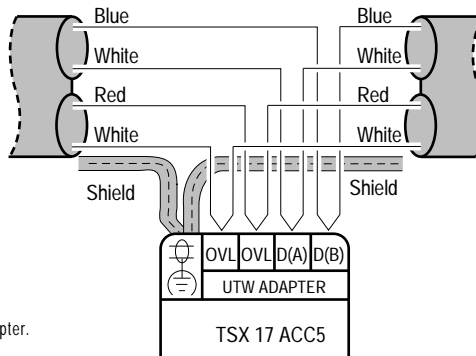

Important, for specific connections:

The TSX 17 ACC5 adapter does not ensure end of line termination and impedance adaptation. Therefore, never install a TSX 17-20 PLC as the last device on the Uni-Telway bus.

1.2-3 Connecting the Programming Terminal

For connected mode operation, e.g. programming or debug, the TSX T407 terminal must be connected to the TSX 17-20 Micro-PLC via the TSX 17 ACC7 Adapter that provides its power supply and performs line adaptation between current loop and RS-485.

TSX T407 or TSX T607 Terminals

These terminals are connected to the Micro-PLC via the the TSX 17 ACC7 adapter. The adapter can be fitted over the programming port and attached to the Micro-PLC (as shown opposite) or connected by a TSX CTC 03 cable, between the adapter and the Micro-PLC.

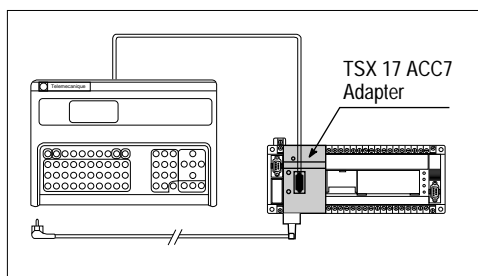

IBM PC-PS/2 Micro Computer

To connect an IBM micro computer to a TSX 17 Micro-PLC, use the TSX 17 ACC PC connection kit.

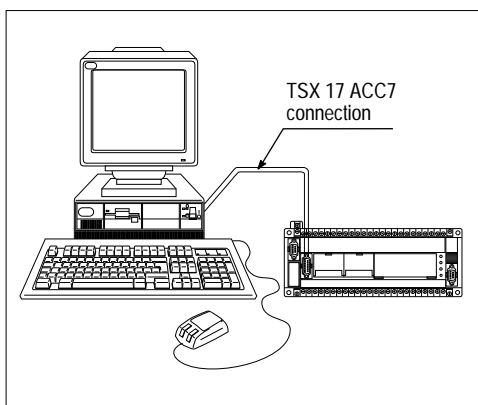

Important

When the TSX 17-20 Micro-PLC is connected to a Uni-Telway bus via a TSX 17 ACC5 Adapter, a TSX T407 programming terminal cannot be connected to it.

Therefore, when a TSX T407 programming terminal is connected, the TSX 17-20 Micro-PLC cannot be connected to the Uni-Telway bus.

1.2-4 Using the Programming Port on the TSX 17-20 PLC

To use the programming port for connecting to a Uni-Telway bus and to a terminal, follow the set-up procedure described below:

- **Step 1** Programming and debugging the application

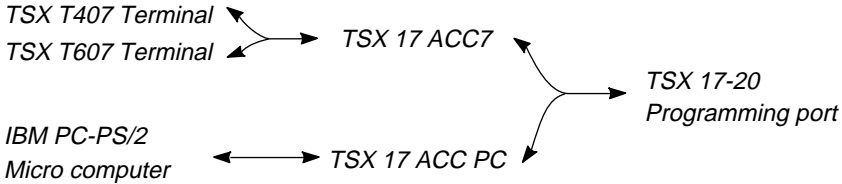

- **Step 2** Using the application with a Uni-Telway bus.

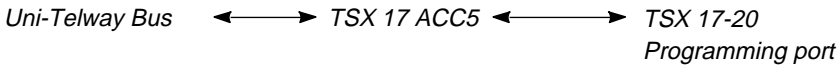

- **Step 3** Adjust and Diagnostics

- with Uni-Telway Bus Connected:

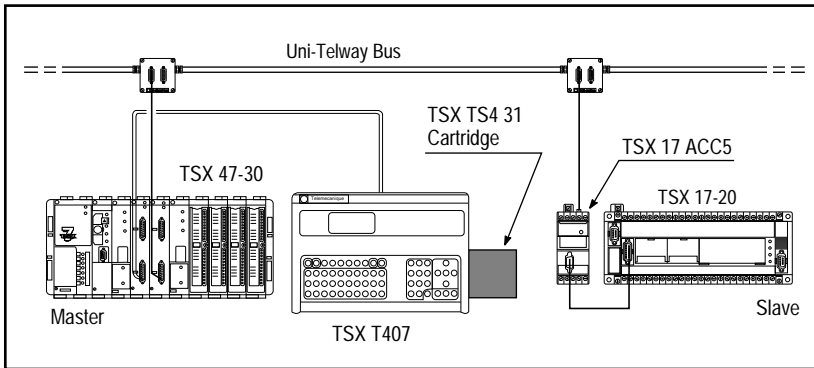

A TSX T407 terminal fitted with the TSX TS4 31 adjustment cartridge and connected to the programming port of the Uni-Telway bus Master PLC can perform adjust and diagnostics functions on the TSX 17-20 PLC and diagnostics on the Uni-Telway bus.

- with Uni-Telway Bus Disconnected:

The TSX T407 terminal is connected to the Micro-PLC as described on the previous page. All local mode adjust and diagnostics functions are available.



Sub-section	Page
2.1 Principles	14
2.1-1 Configuring the TSX ACC5 Adapter	14
2.1-2 Using a Text Block	16
2.1-3 Exchanges Between PLCs and Sensors and Actuators	19
2.1-4 Exchanges Between PLCs	20
2.1-5 Limits to Operation	25
2.1-6 Communication via Telway 7	26
2.2 Examples of Communication Between PLCs	28
2.2-1 Slave to Master (System Gate) Exchange	29
2.2-2 Master to Slave (Text Block) Exchange	31
2.2-3 Slave to Master (Application) Exchange	33
2.2-4 Slave to Slave (System Gate) Exchange	35
2.2-5 Slave to Slave (Text Block) Exchange	36
2.3 Application Example	38
2.3-1 Presentation	38
2.3-2 Application Description	38
2.3-3 Slave B	39
2.3-4 Slave A	40
2.4 Additional Programming Information	44
2.4-1 Broadcast Messages	44
2.4-2 Events	45

2.1 Principles

2.1-1 Configuring the TSX 17 ACC5 Adapter

The TSX 17-20 Micro-PLC has two link addresses on the Uni-Telway bus:

- **Server and line monitoring application address (Ad0)**

This address is assigned by software configuration. It allows access to the Micro-PLC's system (adjust, debug, etc.). All requests received on this address are sent to the system gate of the PLC that is the destination of the exchange. This address also enables the reception of unsolicited data from other devices on the Uni-Telway bus (using request H'FE'). The messages received on the address are sent to the application program and a text block that is set to receive.

- **Client application address (Ad1)**

This address is assigned automatically and follows address Ad0. It is controlled by the application program of the slave module (text block). It enables messages to be sent to any other address on the Uni-Telway bus (system gate or text block in the master or in another slave PLC or any other device) and the reception of related confirms or answers.

The modification of addresses Ad0, Ad1 and the binary data flow is performed by changing the configuration of the programming port of the TSX 17-20 Micro-PLC.

Entering another configuration requires a TSX T407, TSX T607 programming terminal or an IBM PC-PS/2 micro-computer with PL7-2 programming software for use with TSX 17-20 Micro-PLCs.

Uni-Telway mode configuration example with TSX T407 terminal

Access to the configuration of the programming port of the TSX 17-20 Micro-PLC is gained from the mode selection screen by pressing the following dynamic soft keys:

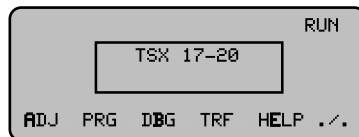

PRG

Allows access to Program mode,

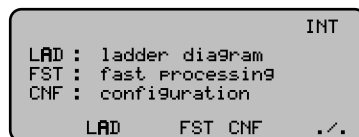

CNF

Allows access to the main configuration mode screen.

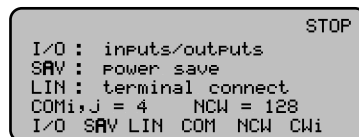

LIN

Enables access to PLC programming port configuration modification. When using a TSX 17-20, the programming port can be configured for connection to a Uni-Telway bus or a peripheral in character mode.

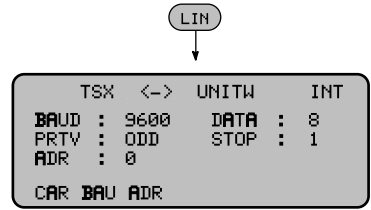

BAUD

The transmission speed (baud rate) of the line used to transmit data is configured by repeated pressure on the baud key. The transmission speeds that can be selected are 300, 600, 1200, 2400, 4800 or 9600 bits/second. The transmission speed selected must be the same for all devices connected to the Uni-Telway bus (normally 9600 Bits/second).

ADR

Pressing this key allows the user to enter the data link address (Ad0) of the PLC connected to the Uni-Telway bus. The entry is validated by pressing <ENT>. The other addresses on the bus are set automatically by incrementation (Ad1 = Ad0+1). The value of the Ad0 data link address must be between 1 and 151.

Note: The character format cannot be modified in Uni-Telway mode. The selected values are:

- . DATA = 8 data bits,
- . STOP = 1 stop bit,
- . PRTY = ODD (odd parity).

CAR

Pressing this key allows the user to configure the programming port of the PLC in character mode.

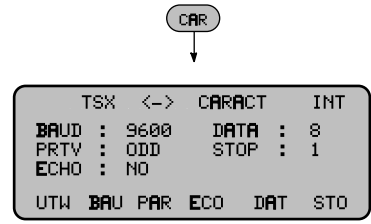

UTW

Pressing this key allows the user to configure the programming port of the PLC in Uni-Telway mode.

Important

A new configuration only becomes effective after the PLC is initialized.

2.1-2 Using a Text Block

When a TSX 17-20 Micro-PLC slave is only a server on the Uni-Telway Bus, communication is performed automatically without requiring a specific application program.

When a client slave PLC needs to send a request, it is sent through a text block. Request structure and text block utilization is described below.

Communication is essentially performed via a question and answer dialog referred to as Request/Confirm.

Request structure

A request comprises 32 bytes:

- . the request code (one byte),
- . the category code (one byte),
- . parameters and/or data limited to 30 bytes.



Confirm structure

A confirm comprises 32 bytes:

- . the confirm code (one byte),
- . parameters and/or data limited to 31 bytes.



The request is sent by the application program from the Client TSX 17-20 PLC by text block. This Coupler type text block (set with S, I and O at 1 for requests that require a confirm) must comprise all request parameters.

The existing relationship between the structure of a request/confirm and the text block parameters are described on the next page.

Transmission

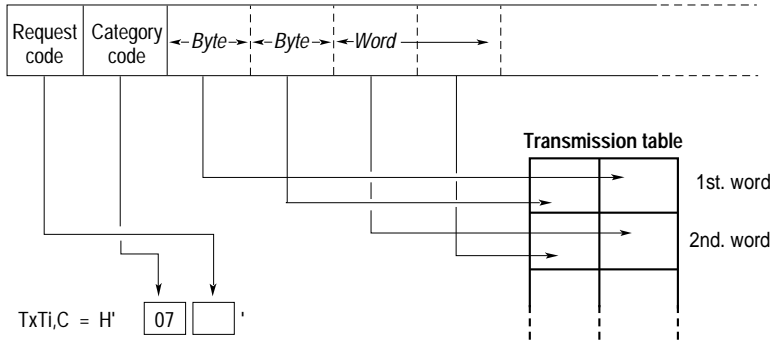

Note: The category code must always take the value H'07'.

TXTi,C The least significant byte comprises the request code. The most significant byte comprises the category code and always takes the value H'07'.

Examples:

TXTi,C = H'07FC' corresponds to the "unsolicited data" request. No confirm will be sent by the destination device. The destination can be a text block in another slave device or the TSX SCM 21.6 that is the Uni-Telway bus master.

TXTj,C <> H'07FC' corresponds to a standard or specific request that requires a confirm from the destination. The destination device can be the system gate of the master PLC or a slave.

TXTi,M The LSB comprises the physical location of the exchange destination device.

In Uni-Telway mode, the MSB always takes the value H'00'.

Examples:

TXTi,M = H'0000' corresponds to the bus master module at data link address 1.

TXTj,M = H'0004' corresponds to the device at data link address 4.

TXTi,L Comprises the length of the transmission table (in bytes).

Reception

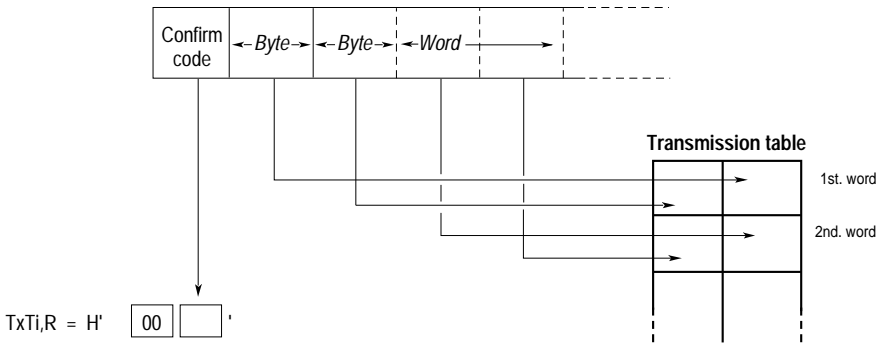

TXTi,M On reception of a message, the LSB comprises the data link address of the request sender device. In Uni-Telway mode, the MSB always takes the value H'00'.

Examples:

$TXTi,M = H'0000'$ corresponds to reception of a message from bus master.

$TXTj,M = H'0008'$ corresponds to reception of a message from the device with data link address 8 on the bus.

TXTi,R Takes the value H'00FC' if the text block receives the unsolicited data request. It takes the value of the exchange confirm if it originated the request.

TXTi,S Contains the number of bytes received in the text block reception table, if the exchange was correct. If an exchange error occurs, $TXTi,S$ takes the following values:

- 1 : exchange cancelled by Reset,
- 2 : transmission table length error,
- 3 : message refused,
- 11 : text block type not supported.

2.1-3 Exchanges Between PLCs and Sensors and Actuators

Reading the velocity reference of an ATV45 speed drive.

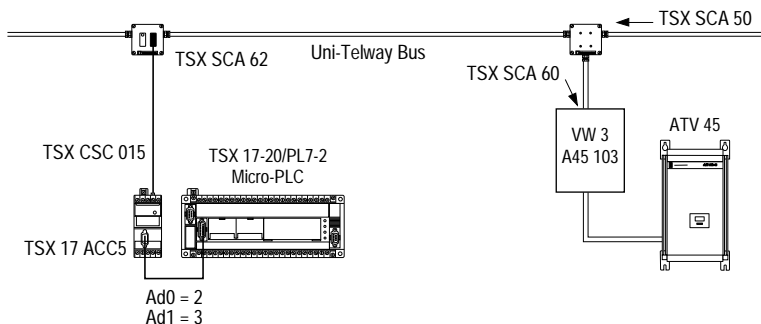

Data

- . ATV45:
 - . Velocity reference = W193 (see ATV45 documentation).
 - . Data link address = 1
- . Read word request:
 - . request code = H'04' (see list of services)
 - . parameter = number of the word to read.
- . Text block:
 - . The request is sent by application program text block TXT2.
 - . Start of the transmission table = W31.
 - . Start of the reception table = W0.

Transmission

- . Text block:
 - . TXT2,C = H'0704' category code = H'07', request code H'04'.
 - . TXT2,M = H'0001' destination link address = 1,
 - . TXT2,L = 2 length (in bytes) of the transmission table.
 - . Transmission table: W31 = 193 number of the word to read.

Reception

- . Text block:
 - . TXT2,R = H'34' correct exchange confirm.
 - . TXT2,D = 1
 - . TXT2,E = 0
 - . Transmission table: W0 = 400 (velocity reference = 40 Hz).

The ATV45 documentation specifies that the velocity reference is expressed with a time-base of 0.1 Hz.

2.1-4 Exchanges Between PLCs

Dialog between PLCs connected to the Uni-Telway bus uses text blocks.

The transmission text block can send its messages or data to:

- the system gate of the PLC that is the destination of the exchange (access to all standard and specific requests as described in the Appendix).
- an application program text block (message system access).

The table below shows all the various possibilities for dialog between a master PLC and slave PLCs:

MASTER PLC		SLAVE PLC	SLAVE PLC
Text block	----->	System gate (**)	
System gate	←-----	Text block (*)	
Text block	----->	Text block (*)	
Application	←-----	Text block (*)	
		Text block (*) ----->	System gate (*)
		Text block (*) ----->	Text block (*)

(*) Each of the possibilities listed above will be described in an example corresponding to the bus layout shown below.

(**) This type of exchange is described in the TSX SCM 21.6 User's Manual (TSX D24 005E).

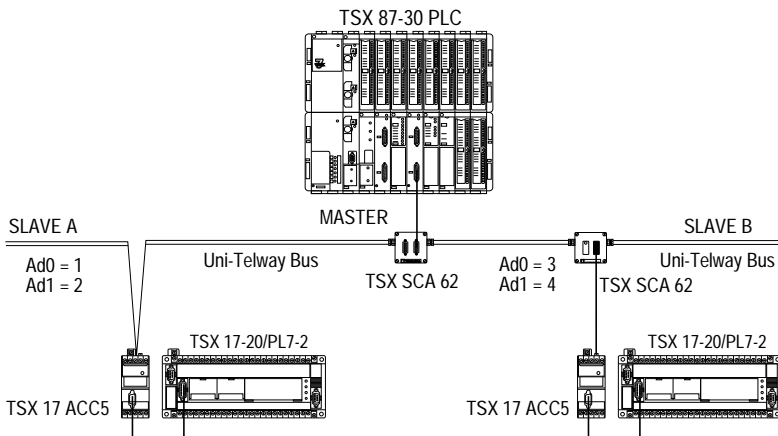

Addressing

Two data link addresses can be assigned to a slave TSX 17-20 PLC:

- . Address Ad0 (system address and line monitoring application),
- . Address Ad1 (client application address),

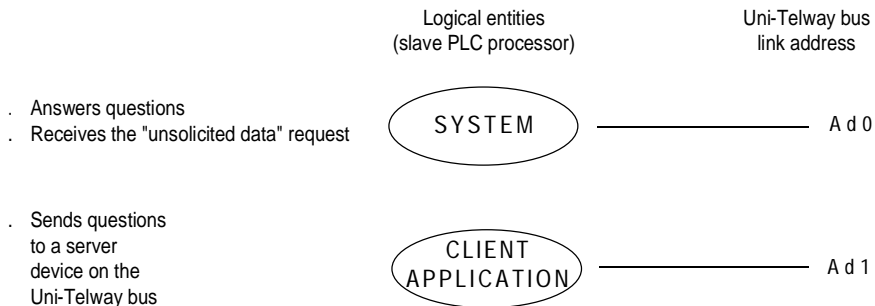

Access to the system gate is always available through address Ad0. This address is defined by configuration.

Access to the client application address (Ad1) is optional. This address is automatically defined when the address Ad0 is configured (Ad0 = Ad0+1).

Master to slave exchange

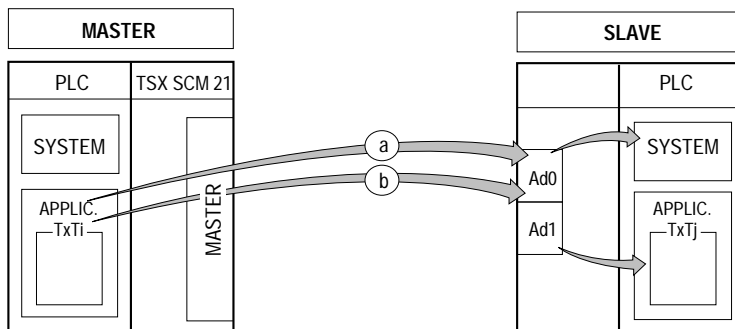

Master ---> Ad0

- a) For communication from the master application program (text block) to the system of the slave PLC (access to PL7 objects).
- b) To send messages from the master application program (text block) to the application program of the slave PLC (text block).

Routing is performed automatically by the TSX 17-20.

Slave to master exchange

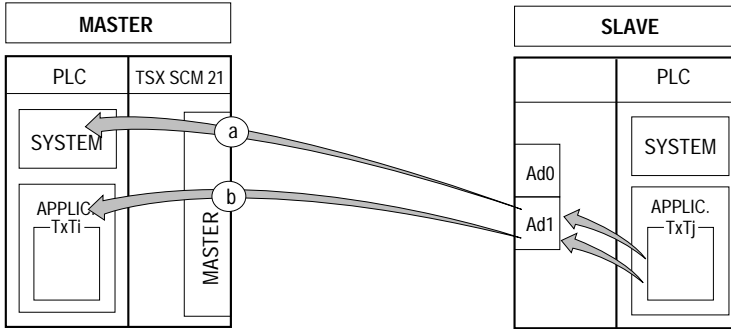

Slave (Ad1) ---> Master

- a) For communication from the application program of the slave (text block) to the system of the master.
- b) For sending messages from the application program of the slave (text block) to the application program of the master (text block).

Slave to slave exchange

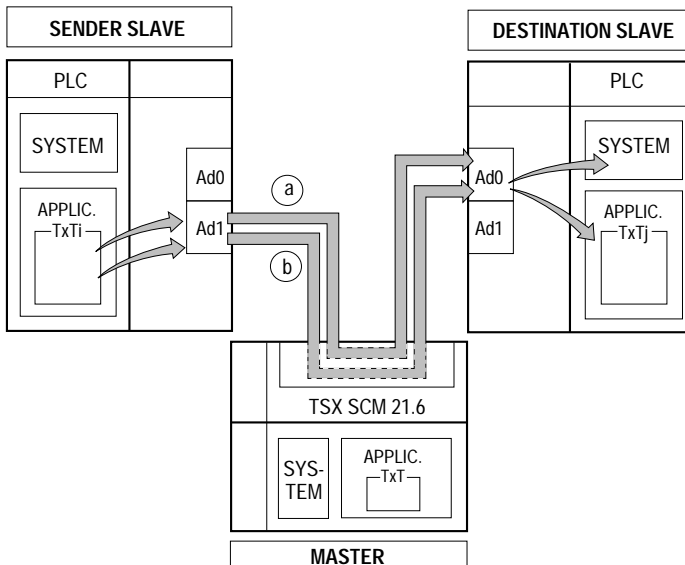

From sender slave (Ad1) to destination slave (Ad0)

- a) For communication from the application program of the sender slave (text block) to the system of the destination slave.
- b) To send messages from the application program of the sender slave (text block) to the application program of the destination slave (text block).

A list of standard and specific services is shown below:

Family	Service	Request		Confirm		Description
		Hex.	Dec.	Hex.	Dec.	
Data (read)	Read a Bit (*)	00	00	30	48	Reads a bit (B).
	Read a Word (*)	04	04	34	52	Reads a word (W).
	Read Objects (*)	36	54	66	102	Reads objects (bits, words, bit or word strings, etc.).
	Read a System Bit	01	01	31	49	Reads a system bit (SY).
	Read the Memory Image of an I/O Bit	02	02	32	50	Reads the image of an I/O bit.
	Read a Constant Word	05	05	35	53	Reads a constant word (CW).
	Read a System Word	06	06	36	54	Reads a system word (SW).
	Read a Timer	09	09	39	57	Reads the parameters of a timer (T).
	Read a Monostable	0A	10	3A	58	Reads the parameters of a monostable (M).
	Read a Counter	0B	11	3B	59	Reads the parameters of a counter (C).
	Read the Current Step of a Drum Controller	0C	12	3C	60	Reads the current step of a drum controller.
	Read a Step from a Drum Controller	0D	13	3D	61	Reads a step from a drum controller.
	Read a Register	0E	14	3E	62	Reads the parameters of a register (R).
	Read Grafct Steps	2A	42	5A	90	Reads Grafct steps (Xi).

(*) Standard requests, the coding of which is given in the Uni-Telway Reference Manual (TSX D24 004E).

Only specific requests are described in Appendix 3.2-2.

Family	Service	Request		Confirm		Description
		Hex.	Dec.	Hex.	Dec.	
Data (write)	Write a Bit (*)	10	16	FE	254	Writes a bit (B).
	Write a Word (*)	14	20	FE	254	Writes a word (W).
	Write Objects (*)	37	55	FE	254	Writes objects (bits, words, bit or word strings, etc.).
	Write a System Bit	11	17	FE	254	Writes a system bit (SY).
	Write the Memory Image of an I/O Bit	12	18	FE	254	Writes the image of an I/O bit.
	Write a System Word	15	21	FE	254	Writes a system word (SW).
	Write Timer Preset	17	23	FE	254	Writes a timer preset (T).
	Write Monostable	18	24	FE	254	Writes a monostable Preset (M).
	Write Counter Preset	19	25	FE	254	Writes a counter preset (C).
	Write a Register Input	1A	26	FE	254	Writes a register Word input word (R).
	Stop a Drum Controller	26	38	FE	254	Stops a drum controller (D).
	Move to the Next Drum Controller Step	27	39	FE	254	Moves to the next step of a drum controller.
	Run Drum Controller	28	40	58	88	Runs a drum controller.
	Unsolicited Data	Unsolicited Data	FC	252	X	X
Operating Modes	RUN (*)	24	36	FE	254	Sets a device to Run.
	STOP (*)	25	37	FE	254	Sets a device to Stop.

(*) Standard requests, the coding of which is given in the Uni-Telway Reference Manual (TSX D24 004E).

Only specific requests are described in Appendix 2.3-2.

Note: There are other standard or specific requests supported by the TSX 17-20 PLC. These are used for specific applications such as programming or diagnostics using Telemecanique terminals and are not described in this manual.

2.1-5 Limits to Operation

Exchanges of messages or data on the Uni-Telway bus are limited by:

- . Exchanges between the Uni-Telway bus and the PLC processor,
- . The limits of the master module (refer to the TSX SCM 21.6 User's Manual),
- . The limits of the slave PLC processor,
- . Flow checking (message loss on power break).

Exchanges between Uni-Telway bus and master PLC

The time that elapses between reception of a request and transfer of a response to the output buffer of the TSX 17-20 PLC is a maximum of two PLC cycles.

Slave PLC Limits

. System Access (Ad0)

The slave PLC can only control one exchange with the system (request/confirm cycle or reception of unsolicited data) at a time. If a message is received on the line while an exchange is in progress, it is refused (NACK).

. Client Application Address (Ad1)

The module can only control one exchange with the application program at a time. Before starting another exchange, the first must be completed (reception of a text block that resets bit D of the text block).

. Processor Limits

- . It is possible to access the system gate of the TSX 17-20 PLC even if it is stopped,
- . The system can only process one request at a time,
- . The maximum message size is 32 bytes (request or confirm + parameters + data).

Flow control

When a text block set for transmission (with S, I and O at 1) sends a request, it awaits reception and remains in this state until it receives an answer. If the destination station suffers a power supply fault or is disconnected, the sender text block will remain blocked:

Bits TXTi,D and TXTi,E remain at 0.

The application program of the client PLC must allow for this situation by including a "time-out" in sender text block operation.

If no answer is received before time-out, then the text block is reset to 0 (RESET TXTi).

2.1-6 Communication via Telway 7

Exchanges between devices connected to the Uni-Telway bus and stations connected to the Telway 7 network are fully user transparent and performed via the Uni-Telway master.

Important A TSX 17-20 slave PLC can only be a server for a station connected to the Telway 7 network. It cannot send a message to a Telway 7 station.

Example: Telway 7 Station 2 to Slave A

The TSX 47-30 PLC, that is station 2 on the Telway 7 network must write the value 2345 in word W1000 of TSX 17-20 Slave A on the Uni-Telway bus.

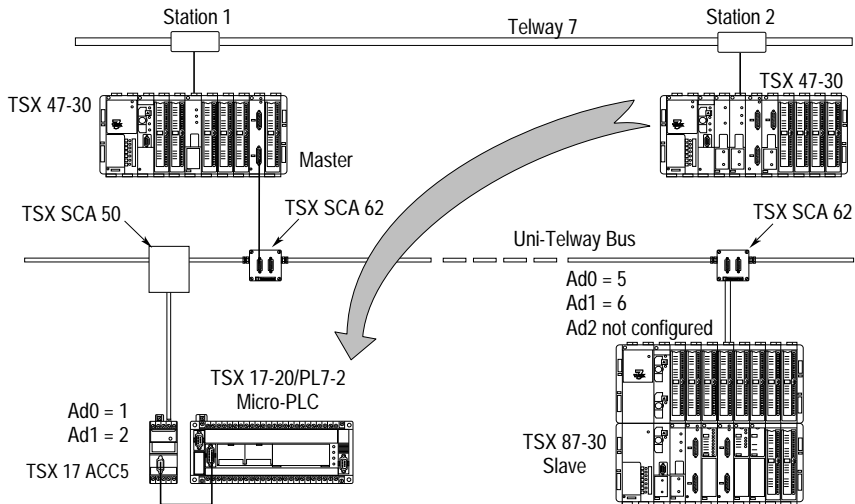

Data

- . Master: The TSX SCM 21.6 Uni-Telway master module is located in rack 0, slot 6. The PLC with the Uni-Telway Master module is also Station 1 on the Telway 7 network.
- . TSX 17-20: Uni-Telway slave, Data link address 1,
- . Write word request:
 - . Request code = H'14',
 - . Parameters = number and value of the word to write.

- . Text block:
 - . As the message sender is on the Telway 7 network, the sender text block is a coupler type network text block (NET). Its TXTi,A parameter must correspond to the Telway 7 network address of the PLC where the Uni-Telway master module is installed.
 - . The request is sent by text block TXT6 of the sender PLC's application program.
 - . Start of the transmission table = W200. The transmission table comprises only the parameters and the data for the request.
 - . There is no reception table as there is no data assigned to the confirm.

Transmission

- . Text block:
 - . TXT6,A = 1 Uni-Telway master = Telway 7 station 1
 - . TXT6,C = H'0714' Category code = H'07', request code = H'14'.
 - . TXT6,M = H'0665' Master location (rack 0, slot 6),
Destination data link address = 1.
 - . TXT6,L = 4 Transmission table length (in bytes).
 - . Transmission table:

W 2 0 0	1 0 0	Nbr. of word to write
W 2 0 1	2 3 4 5	Contents of W100

Reception

- . Text block:
 - TXT6,V = H'FE' correct exchange

2.2 Examples of Communication Between PLCs

The various possibilities for communication between master and slave PLCs are described in the examples of dialog between devices connected to the Uni-Telway bus as shown below:

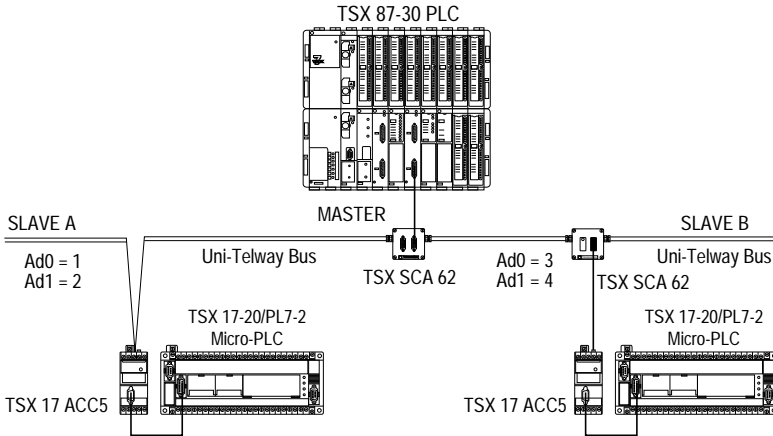

The various examples will be discussed in detail in the rest of this section. The main points covered are:

Slave (text block) → Master (system gate)

Read the parameters of timer T10 of the TSX 87-30 Master PLC by Slave A.

Master (text block) → Slave (text block)

Send the message "PIN FAULT" from the TSX 87-30 Master PLC to Slave B.

Slave (text block) → Master (text block)

Send the message "TEXT OK" from Slave B to the TSX 87-30 Master PLC.

Slave (text block) → Slave (system gate)

Transfer word W10 from Slave A to word W54 of Slave B.

Slave (text block) → Slave (text block)

Send the message "HIGHER THRESHOLD NOT REACHED" from Slave A to Slave B.

2.2-1 Slave to Master (System Gate) Exchange

Read the parameters of timer T10 in the TSX 87-30 Master PLC by Slave A.

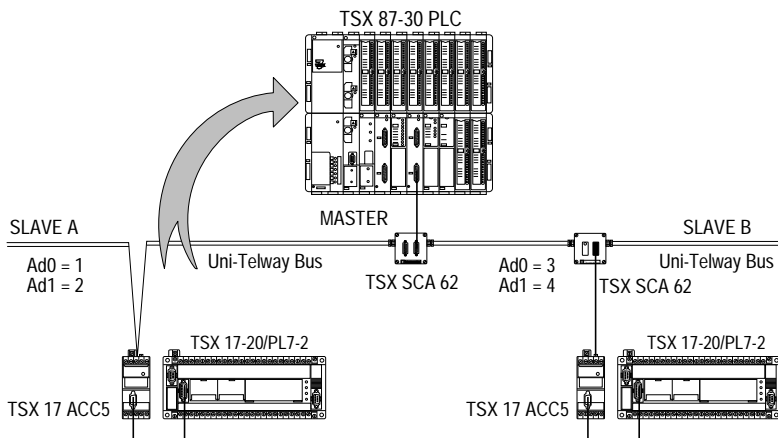

Data

- . Read timer request:
 - . request code = H'09' (see list of services)
 - . parameter = number of the timer to read.
- . Text block:
 - . the request is sent by text block TXT2 of the application program,
 - . start of transmission table = W30,
 - . start of reception table = W0.

Transmission

- . Text block:
 - . TXT2,C = H'0709' category code = H'07', request code = H'09'
 - . TXT2,M = H'0000' master PLC, data link address = 0,
 - . TXT2,L = 2 transmission table length (in bytes),
 - . transmission table:

W30	10	Timer number
W31		
W32		

Reception

. Text block:

. TXT2,R = H'39' correct exchange confirm.

. TXT2,D = 1

. TXT2,E = 0

. TXT2,S = 8 receive 8 bytes.

. Reception table

W0	00	02
W1	01	01
W2	3600	
W3	1712	

. Response analysis:

W0 = H'0002'

LSB = 02 → time base 1 second,

MSB = 00 → not timed-out.

W1 = H'0101'

LSB = 01 → timer running,

MSB = 01 → preset can be modified.

W2 = 3600

The configuration preset value is 3600.

W3 = 1712

The current value when the request was processed was 1712.

2.2-2 Master to Slave (Text Block) Exchange

Send the message "PIN FAULT" from the TSX 87-30 Master PLC to Slave B.

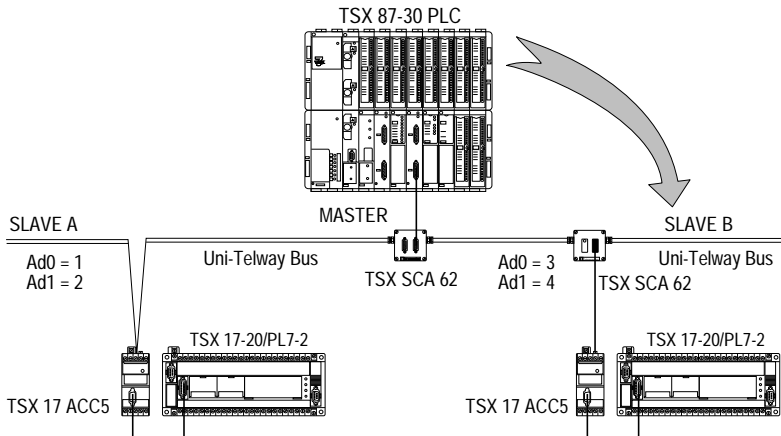

Data

- . Unsolicited data request:
 - . request code = H'FC' (see request list)
 - . parameter = message to send.
- . Sender text block (master):
 - . The request is sent by text block TXT3 of the application program (set-up as an output with S and O at 1 as there is no answer or confirm),
 - . start of transmission table = W300,
 - . there is no reception table as there is no answer.
- . Destination text block (slave):
 - . When a message is sent by a device connected to the Uni-Telway bus, to data link address Ad0 of a TSX 17-20, the destination application program must comprise a text block set to receive (S and I at 1), ready to receive request H'FC'.
 - . As the message received does not specify a destination text block in the Micro-PLC, if more than one are active at the time and set to receive, the text block with the lowest number will receive request H'FC'.
 - . Message reception is ensured by text block TXT2 of the application program,
 - . Start of reception table = W10. The reception table comprises the message sent by the master.

Transmission (Master)

The detailed coding of the request by the PLC that comprises the master TSX SCM 21.6 module (located in Rack 0, Slot 3) is described in the TSX SCM 21.6 Channel 1 - Uni-Telway Bus - User's Manual (TSX D24 005E). The parameters of the text block are listed for reference only.

- . TXT3,C = H'07FC' Category code = H'07', request code = H'FC',
- . TXT3,M = H'0367' Rack 0, slot 3, data link address Ad0 = 3,
- . TXT3,L = 13 Transmission table length in bytes.
- . Transmission table:

W300	49 (I)	50 (P)
W301	20 (Space)	4E (N)
W302	41 (A)	46 (F)
W303	4C (L)	55 (U)
W304		54 (T)

Reception (slave)

- . Text block (S and I at 1): (before reception of the request)
 - . TXT2,C = H'0000'
 - . TXT2,M = H'0000'
 - . TXT2,L = 0 no transmission table.
- . Text block (after data reception)
 - . TXT2,M = H'0000' receive message from the Master,
 - . TXT2,R = H'00FC' receive request H'FC',
 - . TXT2,D = 1
 - . TXT2,E = 0
 - . TXT2,S = 13 receive 13 bytes.
- . Reception table:

W10	49 (I)	50 (P)
W11	20 (Space)	4E (N)
W12	41 (A)	46 (F)
W13	4C (L)	55 (U)
W14		54 (T)

2.2-3 Slave to Master (Application) Exchange

Send the message "TEXT OK" from Slave B to the TSX 87-30 Master.

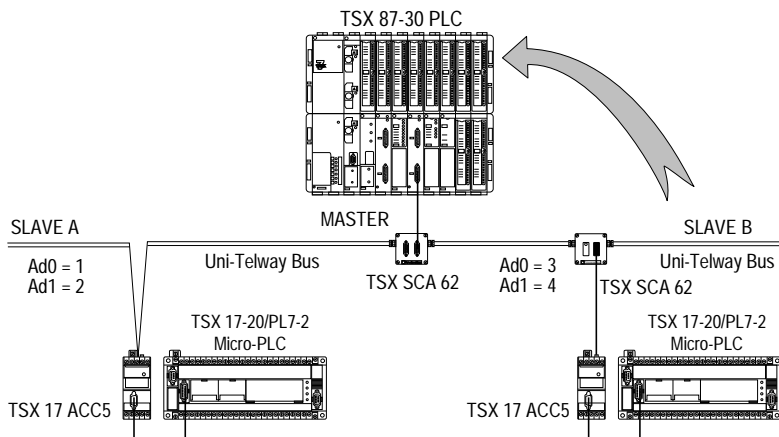

Data

TSX 17-20: sender data link address = 4 (Ad1).

- . Unsolicited data request:
 - . request code = H'FC' (see request list)
 - . parameter = message to send.
- . Sender text block (slave):
 - . Sending a message (request H'FC') to the master **is performed automatically using simplified addressing (event triggered data comprising up to 8 bytes)**. The TSX 17-20 directs the message to the TSX SCM 21.6 module in the master, that stores it in a buffer.
 - . The request is sent by text block TXT1 of the application program (set with S and O at 1 as there is no acknowledgement or confirm from the application program),
 - . Start of transmission table = W100. The transmission table comprises the message to be sent,
 - . There is no reception table as there is no answer.
- . Destination application (master):
 - . Event triggered data sent by the TSX 17-20 is read by the application program of the master (sending request H'A8' to channel 1) when it detects a change in the data.
 - . The amount of data sent is restricted to 8 bytes max. and can be set when the master TSX SCM 21.6 module is configured.

For additional information on reception and processing of event triggered data by the master, refer to the TSX SCM 21.6 User's Manual (TSX D24 005E).

Transmission

- . Text block:
 - . TXT1,C = H'07FC' Category code = H'07', request code = H'FC',
 - . TXT1,M = H'0000' Master PLC (data link address 0),
 - . TXT1,L = 8 Transmission table length (in bytes).
- . Transmission table:

W100	45 (E)	54 (T)
W101	54 (T)	53 (S)
W102	4F (0)	20 (Space)
W103	20 (Space)	4B (K)

Reception (master)

A detailed description of text block parameters that can be used to read the event triggered data received by the TSX SCM 21.6 that is the destination of the exchange (Rack 0, Slot 6) can be found in the TSX SCM 21.6 User's Manual (TSX D24 005E), in sub-section 3.2. The parameters of this text block (TXT5 for example) are given for information only.

- . Text block (transmission):
 - . Start of transmission table = W264,
 - . Start of reception table = W200,
 - . TXT5,C = H'00A8' read events request code H'FC',
 - . TXT5,M = H'0601' rack 0, slot 6, module channel 1,
 - . TXT5,L = 2 transmission table length in bytes.
- . Transmission table

W264	Content of IW06,4
-------------	-------------------

- . Text block (data reception)
 - . TXT5,V = H'D8' if the exchange is correct, if not H'FD',
 - . TXT5,D = 1
 - . TXT5,E = 0
 - . TXT5,S = 8 receive 8 bytes.
- . Reception table:

W200	45 (E)	54 (T)	} Data from Slave B
W201	54 (T)	53 (S)	
W202	4F (0)	20 (Space)	
W203	20 (Space)	4B (K)	

2.2-4 Slave to Slave (System Gate) Exchange

Transfer word W10 from Slave A to word W54 of Slave B:

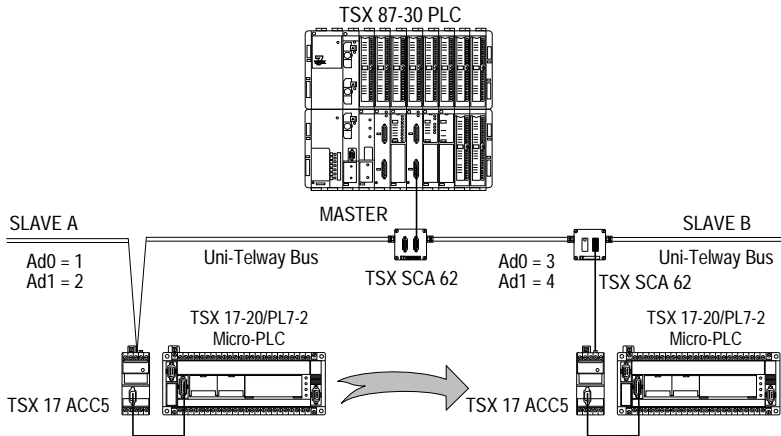

Data

- . Slave A: sender data link address = 2 (Ad1).
- . Slave B: destination data link address = 3 (Ad0).
- . Write word request:
 - . request code = H'14'
 - . parameters = number and value of the word to write.
- . Text block:
 - . The request is sent by text block TXT4 of the application program,
 - . Start of transmission table = W400. The transmission table comprises the number and the value of the word to write,
 - . There is no reception table as there is no data assigned to the confirm.

Transmission

- . Text block:
 - . TXT4,C = H'0714'
 - . TXT4,M = H'0003'
 - . TXT4,L = 4
 - . transmission table:

W400	54	Nbr. of the word to write
W401	4534	Value of word W10

Reception

- . Text block:
 - . TXT4,R = H'FE' correct exchange.

2.2-5 Slave to Slave (Text Block) Exchange

Send the message "HIGHER THRESHOLD REACHED" from Slave A to Slave B:

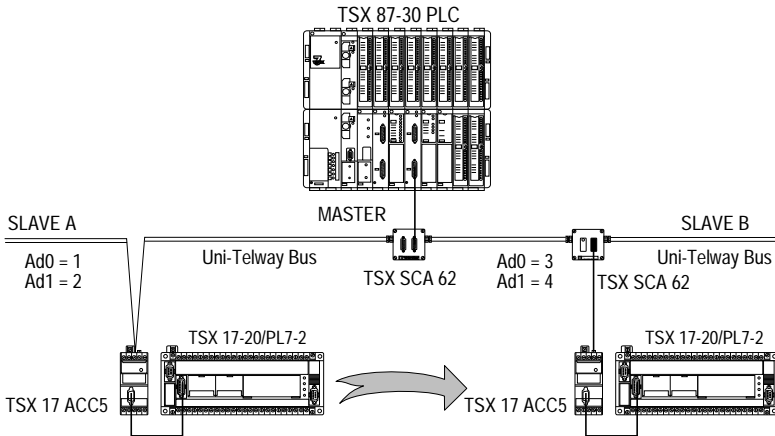

Data

- . Slave A: sender data link address = 2 (Ad1).
- . Slave B: destination data link address = 3 (Ad0).
- . Unsolicited data request:
 - . request code = H'FC',
 - . parameter = message to send.
- . Sender text block (Slave A):
 - . When the TSX 17-20 sends a message to a slave (request H'FC'), the maximum message length is 30 bytes,
 - . The request is sent by text block TXT7 (with S and I set to 1), of the application program,
 - . Start of transmission table = W800. The transmission table comprises the message to be sent,
 - . There is no reception table as there is no confirm.
- . Destination text block (Slave B):
 - . When a message is sent to the data link address Ad0 of a TSX 17-20, by a device connected to the Uni-Telway bus, the destination application program must have a text block set to await reception (S and I at 1), ready to receive request H'FC'.
 - . The message received does not specify a destination Micro-PLC text block number. Therefore, if a number of text blocks are awaiting reception at the same time, the one with the lowest number will effectively receive request H'FC'.

- . Message reception is ensured by text block 4 (set to await reception) of the application program,
- . Start of reception table = W200. The reception table comprises the message sent by slave A.

Transmission

- . Text block:
 - . TXT7,C = H'07FC' Category code = H'07', request code = H'FC',
 - . TXT7,M = H'0004' Data link address = 4 (Ad1),
 - . TXT7,L = 20 Transmission table length in bytes.
- . Transmission table:

W800	49 (I)	48 (H)
W801	48 (H)	47 (G)
W802	52 (R)	45 (E)
W803	54 (T)	20 (Space)
W804	52 (R)	48 (H)
W805	53 (S)	45 (E)
W806	52 (R)	20 (Space)
W807	41 (A)	45 (E)
W808	48 (H)	43 (C)
W809	44 (D)	45 (E)

Reception

- . Text block before reception (S and I at 1):
 - . TXT4,C = H'0000'
 - . TXT4,M = H'0000'
 - . TXT4,L = 0 no transmission table.
- . Text block (data reception)
 - . TXT4,M = H'0002' message from data link address 2 (Slave A),
 - . TXT4,R = H'FC' receive request H'FC',
 - . TXT4,D = 1
 - . TXT4,E = 0
 - . TXT4,S = 20 receive 20 bytes.
- . Reception table:

Sender Category Code

W200	49 (I)	48 (H)
W201	48 (H)	47 (G)
W202	52 (R)	45 (E)
W203	54 (T)	20 (Space)
W204	52 (R)	48 (H)
W205	53 (S)	45 (E)
W206	52 (R)	20 (Space)
W207	41 (A)	45 (E)
W208	48 (H)	43 (C)
W209	44 (D)	45 (E)

2.3 Application Example

2.3-1 Presentation

The program described below is an example of a dialog between TSX 17-20 PLCs connected to the bus illustrated below:

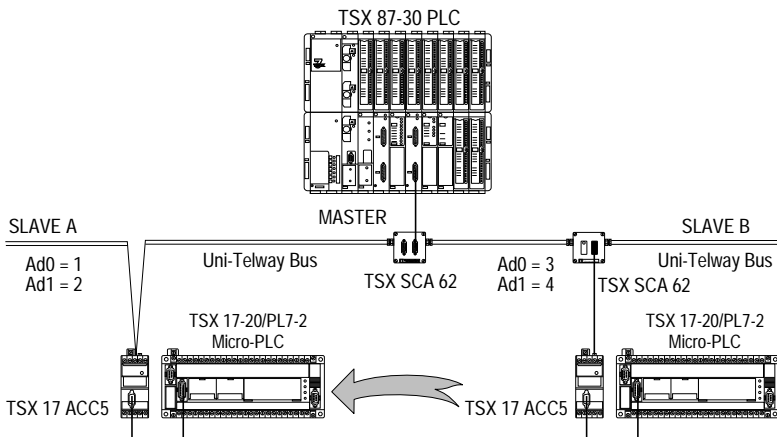

Slave A A TSX 17-20 PLC that is fitted with:

- a PL7-2 language cartridge,
- a TSX 17 ACC5 adapter,
- a TSX 17 ACC2 display unit.

Configuration: Ad0 = 1,
Ad1 = 2.

Slave B A TSX 17-20 PLC that is fitted with:

- a PL7-2 language cartridge,
- a TSX 17 ACC5 adapter,

Configuration: Ad0 = 3,
Ad1 = 4.

2.3-2 Application Description

On each change of value of word W100, the application program of the TSX 17-20 PLC configured as Slave B will transfer the new value of the word system word SW16 of the TSX 17-20 PLC configured as Slave A, for display on the TSX 17 ACC2 display unit.

Reminder The TSX ACC2 display unit increases the amount of data displayed by the PLC by adding a 4-digit BCD display of the content of system word SW16, if SW14=1.

2.3-3 Slave B

Flowchart

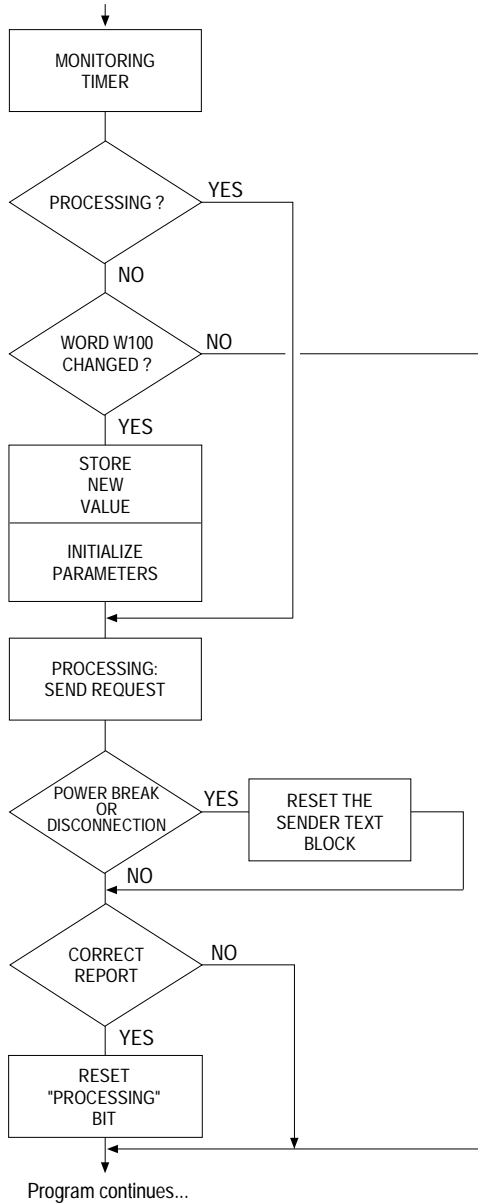

Setting the Request Parameters

Sending the "write system word" request is performed by text block TXT0 of the application program in Slave B. This coupler type (CPL) text block must be set for to send and receive (send word W100 and receive a report).

The transmission table, located after W10 comprises two words:

- . W10 = number of the system word to write (16),
- . W11 = contents of the system word number (W100).

There is no reception table as there is no data assigned to the confirm.

The text block parameters are:

- . TXT0,C = H'7015' category code = H'07', request code = H'15',
- . TXT0,M = H'0001' destination data link address (Ad0 = 1),
- . TXT0,L = 4 transmission table length (in bytes)

2.3-4 Slave A

Flowchart

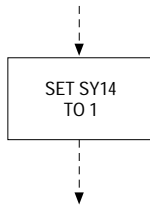

The "write system word" request does not require a specific application program in Slave PLC A.

It is necessary to set system bit SY14 to 1, to enable the display of system word SW16 by the TSX ACC2 display unit.

The value of SW16 is displayed with Slave PLC A in Run or in Stop.

Program

```

O          LABEL : 11          "POWER RETURN"          O
O      !SY0                      SY14          !      O
O  +--+ ] [---+-----+-----+-----+-----+---( S )---+      O
O      !                               !           !           !           !      O
O      !                               !           !           !           !      O
  
```

Slave B Program Analysis

When the value of word W100 changes (W100 different from W50), its new value is stored in W50 (labels 20 and 30).

The initialization of the various sender text block parameters with the "write system word" request is done at label 40:

- . set B10 to 1 Processing in progress,
- . set B20 to 1 Start the text block,
- . Load the value 16 in W10 (start of the transmission table),
- . Load W11 with the new value of W100 (converted to BCD) for display by the TSX ACC2 display unit.

Once the text block has been started (at Label 50), bits B20 and B30 (start and reset the text block) must be reset to 0 (at Label 60).

When a text block set to send and receive sends a request, it then awaits reception of a confirm. If a power break or a disconnection from the bus occurs at the destination end, the text block will remain blocked with bits TXTi,D and TXTi,E at 0. The application program must allow for this.

Provision for this is made by using timer T0 (set for 5seconds). As soon as a request is sent, T0 is triggered (by Label 10). If no confirm has been received by the text block after 5 seconds, it will be reset to 0 by B30 (at Label 60).

As soon as a correct confirm is received (TXT0,R = H'00FE'), Bit B10 (processing in progress) is reset to 0 (at Label 60). The program is then set to await a change in the value of W100 before starting a new exchange.

2.4 Additional Programming Information

2.4-1 Broadcast Messages

The "broadcast message" service allows a message to be sent from the data link master device to all of the slave devices connected to the same Uni-Telway bus.

The "broadcast message" service does not support acknowledgements at data link level nor confirms at application level.

If one of the slaves is not available when this service is used, it will not receive the message.

Reception of request H'FC'

When a broadcast message is sent by the data link master on the Uni-Telway bus, the application program of the TSX 17-20 must comprise a text block set to await reception (S and I at 1), ready to receive request H'FC'.

The message received does not specify a destination Micro-PLC text block number. Therefore, if a number of text blocks are awaiting reception at the same time, the one with the lowest number will effectively receive request H'FC'.

TXTi,M After reception, comprises the data link address of the sender: H'0000'.

TXTi,R Takes the value H'00FC'.

Reception of another request

When another request is broadcast, it is received by the system gate of the TSX 17-20 PLC in a fully user transparent manner.

2.4-2 Events

This service enables a slave server that supports this function to send data on events to the TSX SCM 21.6 Uni-Telway master module on its own initiative.

This data is sent by the "unsolicited data" request that does not require an answer from the destination.

The amount of data sent is restricted to 8 bytes and can be set when the TSX SCM 21.6 master module is configured. For further information refer to the TSX SCM 21.6 User's Manual (TSX D24 005E), sub-section 2.2.

Addressing

When the TSX 17-20 Micro-PLC sends a message to the master PLC using the "events" request, this message comprising event related data is automatically directed to channel 1 of the master module.

- . message: 8 bytes max.
- . TXTi,C = H'07FC' category code = H'07', request code = H'FC',
- . TXTi,M = H'0000' message destined for the master.

Data Acquisition

The data (stored in TSX SCM 21.6 master module RAM) is read by the the application program of the master when the read events data request (code H'A8') is sent to channel 1 of the TSX SCM 21.6 module.

For more information on the processing of events data by the master, refer to the TSX SCM 21.6 User's Manual (TSX D24 005E), sub-section 3.2.



Sub-section	Page
3.1 Performance Levels	48
3.2 Requests Supported by TSX Series 7 PLCs	49
3.2-1 Standard Requests	49
3.2-2 Specific Requests	50
3.3 Standard Requests	51
3.3-1 Read Objects	51
3.3-2 Write Objects	53
3.4 Specific Read Requests	55
3.4-1 Read a System Bit	55
3.4-2 Read the Memory Image of an I/O Bit	56
3.4-3 Read a Constant Word	58
3.4-4 Read a System Word	59
3.4-5 Read a Timer	60
3.4-6 Read a Monostable	61
3.4-7 Read a Counter	62
3.4-8 Read the Current Drum Controller Step	63
3.4-9 Read a Drum Controller Step	64
3.4-10 Read a Register	65
3.4-11 Read Grafcet Steps	66
3.5 Specific Write Requests	67
3.5-1 Write a System Bit	67
3.5-2 Write the Memory Image of an I/O Bit	68
3.5-3 Write a System Word	69
3.5-4 Write a Timer Preset	70
3.5-5 Write a Monostable Preset	71
3.5-6 Write a Counter Preset	72
3.5-7 Write a Register Input Word	73
3.5-8 Stop a Drum Controller	74
3.5-9 Move to the Next Drum Controller Step	75
3.5-10 Start a Drum Controller	76
3.6 Exchange Possibilities	77
This section ends on page	78

3.1 Performance Levels

The overall response time from the transmission of a request to the reception of an answer depends on:

- . The network cycle time,
- . The software response time of the PLC processor,
- . The variation in synchronization between the client, network and server cycles.

Bus Cycle Time

The bus cycle time (BCT) corresponds to the time between two polls of the same network address. (Refer to Sub-section 4.3 of the Uni-Telway Reference Manual).

Module software response time

The PLC processor response time is a maximum of two cycles between the reception of a request and the availability of a response in the output buffer of the TSX 17-20 Micro-PLC.

Difference between client, network and server cycles

The difference between the client, network and server cycles depends on:

- . the cycle time of the master PLC,
- . the bus cycle time,
- . the server cycle time (slave PLC cycle time, etc.).

3.2 Requests Supported by TSX Series 7 PLCs

3.2-1 Standard Requests

Family	Service	Request		Confirm		Description
		Hex	Dec.	Hex.	Dec.	
Data (Read)	Read a Bit (*)	00	00	30	48	Reads a bit (B)
	Read a Word (*)	04	04	34	52	Reads a word (W)
	Read Objects	36	54	66	102	Reads objects (bits, words, word, strings, etc.).
Data (Write)	Write a Bit (*)	10	16	FE	254	Writes a bit (B)
	Write a Word (*)	14	20	FE	254	Writes a word (W)
	Write Objects	37	55	FE	254	Writes objects (bits, words, bit or word strings, etc.).
Unsolicited Data	Unsolicited Data (*)	FC	254	X	X	Sends data without receiving a request first.
Operating Modes	RUN (*)	24	36	FE	254	Sets a device to Run.
	STOP (*)	25	36	FE	254	Sets a device to Stop.

(*) : Standard requests are described in detail in the *Appendix of the Uni-Telway Reference Manual* (TSX D24 004E), sub-section 5.4.

3.2-2 Specific Requests

Service	Request		Confirm		Description
	Hex	Dec.	Hex.	Dec.	
Read a System Bit	01	01	31	49	Reads a system bit (SY).
Read the Memory Image of an I/O Bit	02	02	32	50	Reads the image of an I/O bit.
Read a Constant Word	05	05	35	53	Reads a constant word (CW).
Read a System Word	06	06	36	54	Reads a system word (SW).
Read a Timer	09	09	39	57	Reads the parameters of a timer (T).
Read a Monostable	0A	10	3A	58	Reads the parameters of a monostable (M).
Read a Counter	0B	11	3B	59	Reads the parameters of a counter (C).
Read the Current Drum Controller Step	0C	12	3C	60	Reads a drum controller (D).
Read a Drum Controller Step	0D	13	3D	61	Reads a drum controller (D).
Read a Register	0E	14	3E	62	Reads the parameters of a register (R) .
Read a Grafcet Step	2A	42	5A	90	Reads a Grafcet step (Xi).
Write a System Bit	11	17	FE	254	Writes a system bit (SY).
Write the Memory Image of an I/O Bit	12	18	FE	254	Writes the image of an I/O bit.
Write a System Word	15	21	FE	254	Writes a system word (SW).
Write a Timer Preset	17	23	FE	254	Writes a timer preset (T).
Write a Monostable Preset	18	24	FE	254	Writes a monostable preset (M).
Write a Counter Preset	19	25	FE	254	Writes a counter preset (C).
Write a Register Input	1A	26	FE	254	Writes a register input (R).
Stop a Drum Controller	26	38	FE	254	Stops a drum controller (D).
Move to the Next Drum Step	27	39	FE	254	Moves to the next drum controller step (D).
Start Drum Controller	28	40	58	88	Starts a drum controller (D).

3.3 Standard Requests

3.3-1 Read Objects

This request permits reading of simple objects (words or bit strings etc.).

Request format

Request code H/D	Category code	Segment	Type of object	Object address	Number of objects to read
36/54	0 → 7				

Segment : Specifies the addressing mode used for the objects to be read and the position where they are located (in hexadecimal notation).

The segments accessible by TSX Series 7 PLCs are (in hexadecimal notation):

10 : common object segment,

68 : internal word space.

Type of object : specifies the object to be read:

7 : a 16-bit signed integer.

Object address : . The physical or logical address n the segment,

. The sequence number of the object in the segment:

. 0 : the current date and time, in the common segment,

. 1 : the stored time and date, in the common segment.

Confirm format

Positive confirm

Confirm code H/D	Type of object	Data			
66/102					

Type of object : Returns the type of object selected when the question is sent.

Negative confirm

Confirm code H/D
FD/253

Causes for rejection :

- . Unknown request,
- . Unknown segment or object,
- . Address out of range,
- . Too many objects for the reception buffer.

Request Examples

Read words

Segment : 68
Type of object : 7 → Wi
Object address : index of the first Wi to read

Read Date and Time

Segment : 10 (common)
Type of object : 0 by default
Object address : 0 → current time and date
 : 1 → saved time and date
Quantity : 0 by default.

3.3-2 Write Objects

This request writes simple objects (words, word strings, etc.).

Request format

Request code H/D	Category code	Segment	Type of object	Object address	Number of objects to write	Data
37/55	0 → 7					

Segment : Specifies the addressing mode and the addressing field.
 10 : common object segment,
 68 : internal word space.

Type of object : specifies the object to write:
 7 : a 16-bit signed integer.

Object address : . The physical or logical address in the segment,
 . The sequence number of the object in the segment:
 . 0 : the current date and time, in the common segment,
 . 1 : the stored time and date, in the common segment.

Confirm format

Positive confirm

Confirm code H/D
FE/254

Negative confirm

Confirm code H/D
FD/253

Causes for rejection : . Unknown request,
. Inadequate access rights,
. Unknown object,
. Address of the last object out of range.

Request Examples

Write words

Segment : 68
Type of object : 7 → Wi
Object address : index of the first Wi to write
Quantity : number
Data : table of n objects

Write Date and Time

Segment : 10 (common)
Type of object : 0 by default
Object address : 0 → current time and date
Quantity : 0 by default.
Data : 17 ASCII characters that contain the time and date information:
YYYYMMDDHHMMSS.TZ
(*T: tenths of a second, Z: trailer*).

3.4 Specific Read Requests

3.4-1 Read a System Bit

This request reads a system bit SY.

Request format

Request code H/D	Category code	System bit number
01/01	0 → 7	

Confirm format

Positive confirm

Confirm code H/D	Value
31/49	

Value : comprises a string of 8 bits, where the address of the first bit is the largest multiple of 8 contained in the system bit number that is to be read.
Only the bit corresponding to the bit to be found is significant.

Negative confirm

Confirm code H/D
FD/253

Causes for rejection : . Unknown request.
. Bit number out of range.

3.4-2 Read the Memory Image of an I/O Bit

This request reads the memory image generated by an I/O module.

Request format

Request code H/D	Category code	Module Number
02/02	0 → 7	

Confirm format

Positive confirm

Confirm code H/D	Fault object	Configuration	Reserved	Reserved	Reserved	Reserved	Nbr. of output Bits	Value of output bits
32/50			00	0F	00	1F	10	

Nbr. of input bits	Value of input bits	Nbr. of output bits	Output bit forcing list	Nbr. of input bits
20		10		20

Input bit forcing list

Fault Code : Bit 7 = Fault: (0 = no, 1 = yes)
 Bit 6 = 1 if extended format confirm
 Bits 5 and 4 = 0
 Bits 0 to 3 = Type of fault

- 0000 : OK
- 0001 : OK, minor fault present
- 0010 : module absent
- 0011 : module failure
- 0100 : not an I/O module
- 0101 : incompatible with configuration
- 0110 : module not required
- 0111 : not used
- 1000 : not used

Configuration: bit 7 = module presence required (0=no, 1=yes),
 bit 6 = 0 (reserved),
 bits 0 to 5 = module code
 (if module presence is required: bit 7 = 1),
 Configuration = 0, if no configuration is declared.

Number of output bits:

The TSX 17-20 PLC always returns the maximum number of output bits (16 or H'10').

Value of the output bits:

The value of the module output bits. If the module comprises 8 or 16 outputs, the unused bits take null or insignificant values.

Number of input bits:

The TSX 17-20 PLC always returns the maximum number of input bits (32 or H'20').

Value of the input bits:

The value of the input bits from the module. If the module comprises 12, 22 or 24 inputs, the unused bits comprise null or insignificant values.

Output bit forcing list:

Output bit forcing status:

- . 0 the bit is not forced,
- . 1 the bit is forced, its forcing status is found in the output bit value parameter.

Input bit forcing list:

Input bit forcing status:

- . 0 the bit is not forced,
- . 1 the bit is forced, its forcing status is found in the input bit value parameter.

Negative confirm

Confirm code H/D
FD/253

Reasons for rejection: . Unknown request,
 . Module number out of range.

3.4-3 Read a Constant Word

This request reads constant words (CW).

Request format

Request code Hex.	Category code	Word number
05/05	0 → 7	-----

Confirm format

Positive confirm

Confirm code Hex.	Value
35/53	-----

Negative confirm

Confirm code Hex.
FD/253

Causes for rejection:

- . Unknown request,
- . Word number out of range.

3.4-4 Read a System Word

This request reads system words (CW).

Request format

Request code Hex.	Category code	Word number
06/06	0 → 7	⋮

Confirm format

Positive confirm

Confirm code Hex.	Value
36/54	⋮

Negative confirm

Confirm code Hex.
FD/253

Causes for rejection:

- . Unknown request,
- . Word number out of range.

3.4-5 Read a Timer

This request reads all of the parameters of a timer.

Request format

Request code Hex.	Category code	Timer Number
09/09	0 → 7	⋮

Confirm format

Positive confirm

Confirm code Hex.	Time base	Timer timed-out	Timer running	Type of preset	Preset value	Current value
39/57					⋮	⋮

Time base: 0 → 10 ms
 1 → 100 ms
 2 → 1 sec.
 3 → 1 min.

Timer timed-out: 0 → no
 1 → yes

Timer running: 0 → no
 1 → yes

Type of preset: 0 → preset cannot be modified
 1 → preset can be modified

Negative confirm

Confirm code Hex.
FD/253

Causes for rejection: . Unknown request,
 . Timer number out of range,
 . RAM cannot be executed.

3.4-6 Read a Monostable

This request reads all of the parameters of a monostable.

Request format

Request code Hex.	Category code	Monostable number
0A/10	0 → 7	

Confirm format**Positive confirm**

Confirm code Hex.	Time base	Monostable running	Type of preset	Preset value	Current value
3A/58					

Time base:

- 0 → 10 ms
- 1 → 100 ms
- 2 → 1 sec.
- 3 → 1 min.

Monostable running:

- 0 → no
- 1 → yes

Type of preset:

- 0 → preset cannot be modified
- 1 → preset can be modified

Negative confirm

Confirm code Hex.
FD/253

Causes for rejection:

- . Unknown request,
- . Monostable number out of range,
- . RAM cannot be executed.

3.4-7 Read a Counter

This request reads all of the parameters of a counter.

Request format

Request Code Hex.	Category code	Counter Number
0B/11	0 → 7	⋮

The fast counter is numbered counter 31.

Confirm format

Positive confirm

Confirm code Hex.	Down-count overflow	Upcount overflow	Counter running	Type of preset	Preset value	Current value
3B/59					⋮	⋮

Downcount overflow: 1 if the current counter value has gone from 0 to 9999.

Upcount overflow 1 if the current counter value has gone from 9999 to 0.

Counter running: 0 → no
1 → yes

Type of preset: 0 → preset cannot be modified
1 → preset can be modified

Negative confirm

Confirm code Hex.
FD/253

Causes for rejection:

- . Unknown request,
- . Counter number out of range,
- . RAM cannot be executed.

3.4-8 Read the Current Drum Controller Step

This request reads all of the parameters of a drum controller.

Request format

Request code Hex.	Category code	Drum number
0C/12	0 → 7	

Confirm format**Positive confirm**

Confirm code Hex.	Time base	Drum full	Duration of step in progress	Drum length in steps	Current step
3C/60					

Value of the required step

Time base:

0 → 10 ms,
 1 → 100 ms,
 2 → 1 sec.,
 3 → 1 min.

Drum full: Indicates that the last step defined is being executed.

0 → no
 1 → yes

Negative confirm

Confirm code Hex.
FD/253

Causes for rejection:

- . Unknown request,
- . Drum controller number out of range,
- . RAM cannot be executed.

3.4-9 Read a Drum Controller Step

This request reads the parameters of any step of a drum controller.

Request format

Request code Hex.	Category code	Drum number	Step number
0D/13	0 → 7	-----	-----

Confirm format

Positive confirm

Confirm code Hex.	Time base	Drum full	Duration of step in progress	Drum length in steps	Current step
3D/61	-----	-----	-----	-----	-----

Value of the required step

Time base:

- 0 → 10 ms,
- 1 → 100 ms,
- 2 → 1 sec.,
- 3 → 1 min.

Drum full: Indicates that the last step defined is being executed.

- 0 → no
- 1 → yes

Negative confirm

Confirm code Hex.
FD/253

Causes for rejection:

- . Unknown request,
- . Drum number out of range,
- . Step number out of range,
- . RAM cannot be executed.

3.4-10 Read a Register

This request reads all of the parameters of a register.

Request format

Request code Hex.	Category code	Register number
0E/14	0 → 7	⋮

Confirm format

Positive confirm

Confirm code Hex.	Register type	Register empty	Register full	Register length	Input word	Output word
3E/62				⋮	⋮	⋮

Register type: 0 = FIFO register,
 1 = LIFO register,

Register empty: 0 → no
 1 → yes

Register full: 0 → no
 1 → yes

Negative confirm

Confirm code Hex.
FD/253

Causes for rejection: . Unknown request,
 . Register number out of range,
 . RAM cannot be executed.

3.4-11 Read Grafcet Steps

This request reads the Grafcet step activity bits (Xi).

Request format

Request code Hex.	Category code	Register number
2A/42	0 → 7	-----

Portion number: 0 = portion [X0.....X127]

Confirm format

Positive confirm

Confirm code Hex.	Data
5A/90	-----

Register type: A succession of 128 bits corresponding to the step number in the selected portion.
 bit i = 0: step Xi inactive,
 bit i = 1: step Xi active.

The TSX 17-20 PLC will only allow 96 Grafcet steps, therefore bits X96 to X127 are always at 0.

Negative confirm

Confirm code Hex.
FD/253

Causes for rejection: . Unknown request,
 . Portion number out of range,
 . No reservation.

3.5 Specific Write Requests

3.5-1 Write a System Bit

This request writes a system bit SY...

Request format

Request code Hex.	Category code	System bit number	Bit value
11/17	0→7	-	

Bit value: 0 or 1.

Confirm format

Positive confirm

Confirm code Hex.
FE/254

Negative confirm

Confirm code Hex.
FD/253

Causes for rejection: . Unknown request,
 . Inadequate access rights,
 . Bit number out of range,

3.5-2 Write the Memory Image of an I/O Bit

This request writes the memory image of an I/O module.
As memory image processing is used, no check is made to ensure that the module exists.

Request format

Request code Hex.	Category code	I/O module number	Input or output selection	I/O bit number	Bit value
12/18	0 → 7	⋮			

I/O module number: Bits 0 to 7: Logical module number (0...3),

Input or output selection: 0 : Outputs,
 1 : Inputs.

I/O Bit number: 0 → 15 : for outputs,
 0 → 31 : for inputs,
 Bit 15 must always be set to 1.

Bit value: 0 or 1,

Confirm format

Positive confirm

Confirm code Hex.
FE/254

Negative confirm

Confirm code Hex.
FD/253

Causes for rejection:

- . Unknown request,
- . Inadequate access rights,
- . I/O module number out of range,
- . I/O bit number out of range.

3.5-3 Write a System Word

This request writes a system word (SW..).

Request format

Request code Hex.	Category code	System word number	Value
15/21	0 → 7	⋮	⋮

Confirm format

Positive confirm

Confirm code Hex.
FE/254

Negative confirm

Confirm code Hex.
FD/253

Causes for rejection:

- . Unknown request,
- . Inadequate access rights,
- . System word number out of range.

3.5-4 Write a Timer Preset

This request writes the preset value of a timer (T) if it can be modified.

Request format

Request code Hex.	Category code	Timer number	Preset value
17/23	0 → 7	-----	-----

Preset value: Between 0 and 9999 (H'00' to H270F') inclusive.

Confirm format

Positive confirm

Confirm code Hex.
FE/254

Negative confirm

Confirm code Hex.
FD/253

Causes for rejection:

- . Unknown request,
- . Timer number out of range,
- . Preset cannot be modified,
- . Preset value out of range,
- . Cannot execute RAM.

3.5-5 Write the Monostable Preset

This request writes the preset value of a monostable (M), if it can be changed.

Request format

Request code Hex.	Category code	System word number	Value
18/24	0 → 7	 	

Preset value: Between 0 and 9999 (H'00' to H'270F') inclusive.

Confirm format

Positive confirm

Confirm code Hex.
FE/254

Negative confirm

Confirm code Hex.
FD/253

Causes for rejection:

- . Unknown request,
- . Monostable number out of range,
- . Preset cannot be changed,
- . Preset value out of range,
- . Cannot execute RAM.

3.5-6 Write a Counter Preset

This request writes the preset value of a counter.

Request format

Request code Hex.	Category code	Counter number	Value
19/25	0 → 7	 	

Preset value: Between 0 and 9999 (H'00' to H'270F') inclusive.

Confirm format

Positive confirm

Confirm code Hex.
FE/254

Negative confirm

Confirm code Hex.
FD/253

- Causes for rejection:
- . Unknown request,
 - . Counter number out of range,
 - . Preset cannot be modified,
 - . Preset value out of range,
 - . Cannot execute RAM.

3.5-7 Write a Register Input Word

This request writes a register input word (R).

Request format

Request code Hex.	Category code	Register number	Input word value
1A/26	0 → 7	 	

Confirm format

Positive confirm

Confirm code Hex.
FE/254

Negative confirm

Confirm code Hex.
FD/253

Causes for rejection:

- . Unknown request,
- . Inadequate access rights,
- . Register number out of range,
- . Cannot execute RAM.

3.5-8 Stop a Drum Controller

This request stops a drum controller.

Request format

Request code Hex.	Category code	Drum controller number	Step number
26/38	0 → 7	 	

Confirm format

Positive confirm

Confirm code Hex.
FE/254

Negative confirm

Confirm code Hex.
FD/253

- Causes for rejection:
- . Unknown request,
 - . Inadequate access rights,
 - . Drum controller number out of range,
 - . Step number out of range,
 - . Cannot execute RAM,
 - . No reservation.

3.5-9 Move to the Next Drum Controller Step

This request moves a drum controller to the next step and updates the order bits.

Request format

Request code Hex.	Category code	Drum controller number
27/39	0 → 7	⋮

Confirm format

Positive confirm

Confirm code Hex.
FE/254

Negative confirm

Confirm code Hex.
FD/253

Causes for rejection:

- . Unknown request,
- . Inadequate access rights,
- . No reservation,
- . Drum controller number out of range,
- . Cannot execute RAM.

3.5-10 Start a Drum Controller

This request starts a drum controller.

Request format

Request code hex.	Category code	Drum controller number
28/40	0 → 7	-----

Confirm format

Positive confirm

Confirm code Hex.
FE/254

Negative confirm

Confirm code Hex.
FD/253

- Causes for rejection:
- . Unknown request,
 - . Inadequate access rights,
 - . Drum controller number out of range,
 - . Cannot execute RAM,
 - . No reservation.

3.6 Exchange Possibilities

A Uni-Telway Bus

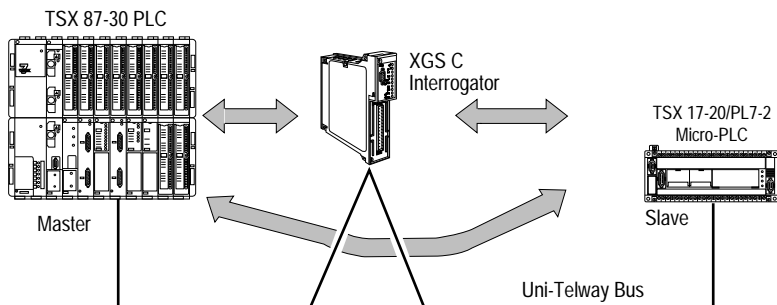

A Uni-Telway bus with a Telway 7 Network

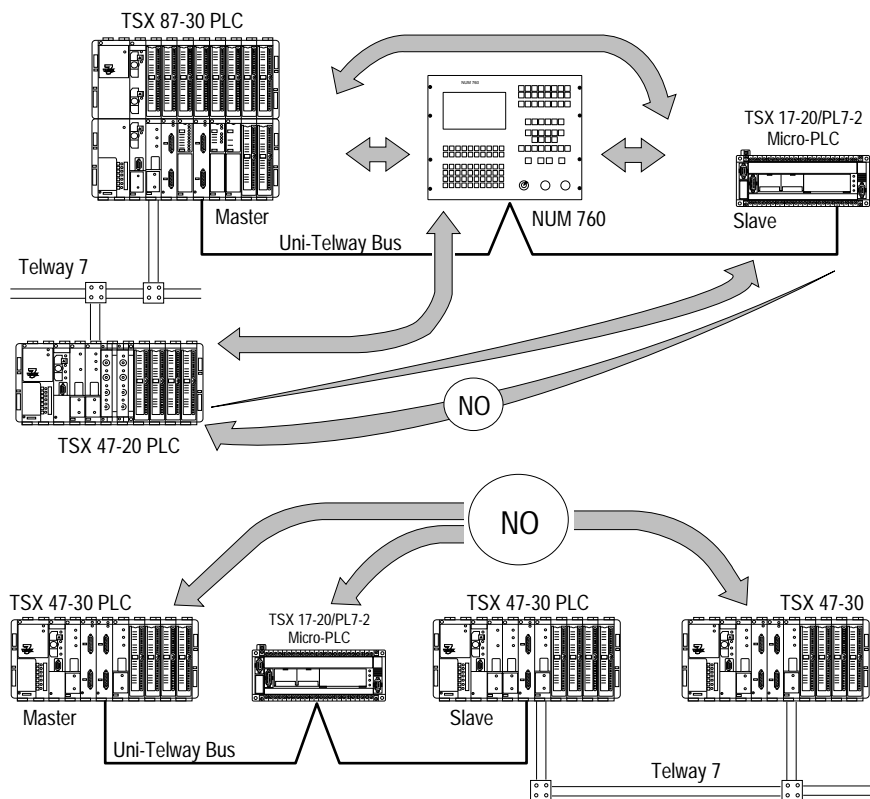

Transparent communications stop when a slave PLC is reached. To go beyond that point communications have to be processed by the application program of the slave PLC.
