

Thyristor Modules

Thyristor/Diode Modules

$$I_{TRMS} = 2x 520 A$$

$$I_{TAVM} = 2x 320 A$$

$$V_{RRM} = 1200-1800 V$$

V_{RSM}	V_{RRM}	Type	
V_{DSM}	V_{DRM}		
V	V		
1300	1200	MCC 312-12io1	MCD 312-12io1
1500	1400	MCC 312-14io1	MCD 312-14io1
1700	1600	MCC 312-16io1	MCD 312-16io1
1900	1800	MCC 312-18io1	MCD 312-18io1



Symbol	Conditions	Maximum Ratings	
I_{TRMS}, I_{FRMS}	$T_{VJ} = T_{VJM}$	520	A
I_{TAVM}, I_{FAVM}	$T_C = 85^{\circ}C; 180^{\circ}$ sine	320	A
I_{TSM}, I_{FSM}	$T_{VJ} = 45^{\circ}C; t = 10$ ms (50 Hz)	9200	A
	$V_R = 0; t = 8.3$ ms (60 Hz)	10100	A
I^2t	$T_{VJ} = T_{VJM}; t = 10$ ms (50 Hz)	8000	A
	$V_R = 0; t = 8.3$ ms (60 Hz)	8800	A
$(di/dt)_{cr}$	$T_{VJ} = T_{VJM};$ repetitive, $I_T = 960$ A	100	A/ μ s
	$f = 50$ Hz; $t_p = 200$ μ s; $V_D = 2/3 V_{DRM};$ $I_G = 1$ A; $di_G/dt = 1$ A/ μ s	500	A/ μ s
$(dv/dt)_{cr}$	$T_{VJ} = T_{VJM}; V_D = 2/3 V_{DRM};$	1000	V/ μ s
	$R_{GK} = \infty;$ method 1 (linear voltage rise)		
P_{GM}	$T_{VJ} = T_{VJM}; t_p = 30$ μ s	120	W
	$I_T = I_{T(AV)M}; t_p = 500$ μ s	60	W
P_{GAV}		20	W
V_{RGM}		10	V
T_{VJ}		-40...+140	$^{\circ}C$
T_{VJM}		140	$^{\circ}C$
T_{stg}		-40...+125	$^{\circ}C$
V_{ISOL}	50/60 Hz, RMS $t = 1$ min	3000	V~
	$I_{ISOL} \leq 1$ mA $t = 1$ s	3600	V~
M_d	Mounting torque (M6)	4.5 - 7	Nm
	Terminal connection torque (M8)	11 - 13	Nm
Weight	Typical including screws	750	g

Data according to IEC 60747 and refer to a single diode unless otherwise stated.



Features

- International standard package
- **D**irect **C**opper **B**onded Al_2O_3 -ceramic with copper base plate
- Planar passivated chips
- Isolation voltage 3600 V~
- UL registered, E 72873
- Keyed gate/cathode twin pins

Applications

- Motor control, softstarter
- Power converter
- Heat and temperature control for industrial furnaces and chemical processes
- Lighting control
- Solid state switches

Advantages

- Simple mounting
- Improved temperature and power cycling
- Reduced protection circuits

Symbol	Conditions	Characteristic Values	
		typ.	max.
I_{RRM}, I_{DRM}	$V_R / V_D = V_{RRM} / V_{DRM}$	$T_{VJ} = T_{VJM}$	40 mA
V_T, V_F	$I_T, I_F = 600 \text{ A}$	$T_{VJ} = 25^\circ\text{C}$	1.32 V
V_{T0}	For power-loss calculations only		0.8 V
r_t		$T_{VJ} = T_{VJM}$	0.68 mΩ
V_{GT}	$V_D = 6 \text{ V}$	$T_{VJ} = 25^\circ\text{C}$	2 V
		$T_{VJ} = -40^\circ\text{C}$	3 V
I_{GT}	$V_D = 6 \text{ V}$	$T_{VJ} = 25^\circ\text{C}$	150 mA
		$T_{VJ} = -40^\circ\text{C}$	220 mA
V_{GD}	$V_D = 2/3 V_{DRM}$	$T_{VJ} = T_{VJM}$	0.25 V
I_{GD}			10 mA
I_L	$t_p = 30 \mu\text{s}; V_D = 6 \text{ V}$ $I_G = 0.45 \text{ A}; di_G/dt = 0.45 \text{ A}/\mu\text{s}$	$T_{VJ} = 25^\circ\text{C}$	200 mA
I_H	$V_D = 6 \text{ V}; R_{GK} = \infty;$	$T_{VJ} = 25^\circ\text{C}$	150 mA
t_{gd}	$V_D = 1/2 V_{DRM}$ $I_G = 1 \text{ A}; di_G/dt = 1 \text{ A}/\mu\text{s}$	$T_{VJ} = 25^\circ\text{C}$	2 μs
t_q	$V_D = 2/3 V_{DRM}$ $dv/dt = 50 \text{ V}/\mu\text{s}; -di/dt = 10 \text{ A}/\mu\text{s}$ $I_T = 300 \text{ A}; V_R = 100 \text{ V}; t_p = 200 \mu\text{s}$	$T_{VJ} = T_{VJM}$	200 μs
Q_S	$I_T = 300 \text{ A}; -di/dt = 50 \text{ A}/\mu\text{s}$	$T_{VJ} = T_{VJM}$	760 μC
I_{RM}			275 A
R_{thJC}	per thyristor; DC current per module		0.12 K/W 0.06 K/W
R_{thJK}	per thyristor; DC current per module		0.16 K/W 0.08 K/W
d_S	Creeping distance on surface		12.7 mm
d_A	Creepage distance in air		9.6 mm
a	Maximum allowable acceleration		50 m/s ²

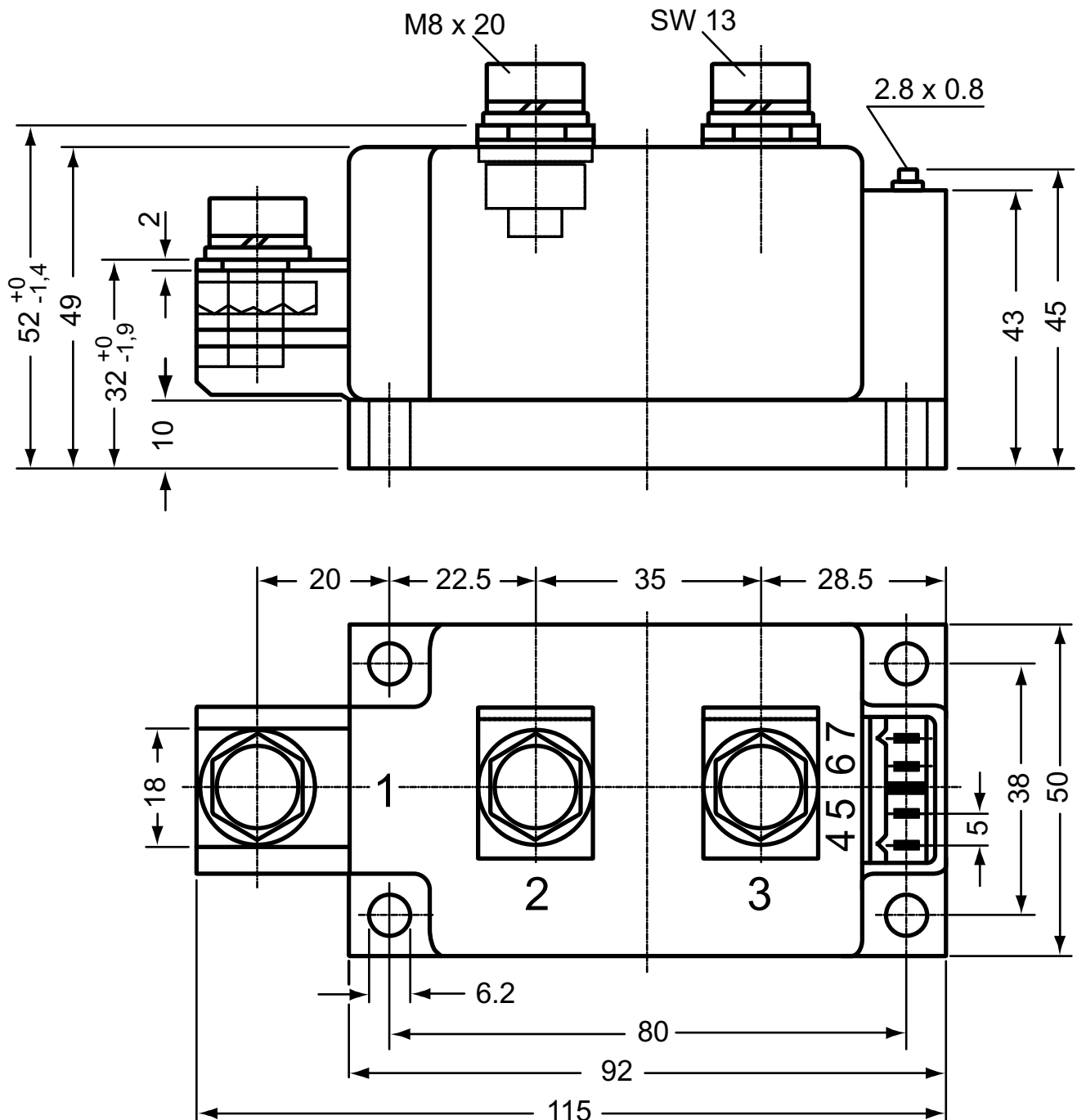

Fig. 3 Surge overload current
 $I_{TSM/FSM}$: Crest value, t: duration



Fig. 2 Gate trigger delay time

Dimensions in mm (1 mm = 0.0394")



Optional accessories for modules

Keyed gate/cathode twin plugs with wire length = 350 mm, gate = white, cathode = red

Type ZY 180L (L = Left for pin pair 4/5)

Type ZY 180R (R = Right for pin pair 6/7) } UL 758, style 3751

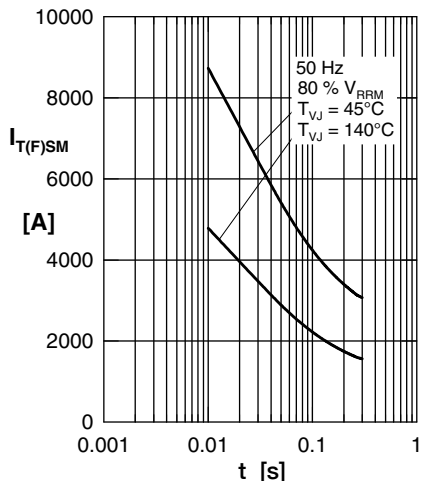

Fig. 3 Surge overload current
 $I_{T(F)SM}$: Crest value, t: duration

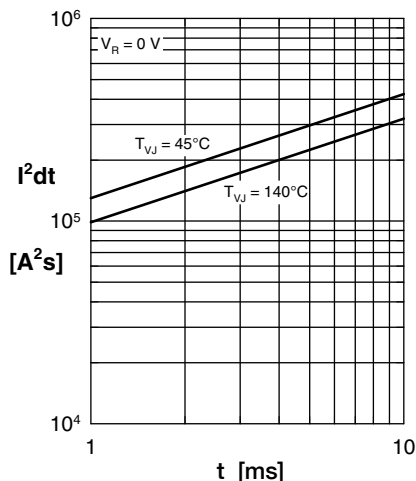

Fig. 4 I^2dt versus time

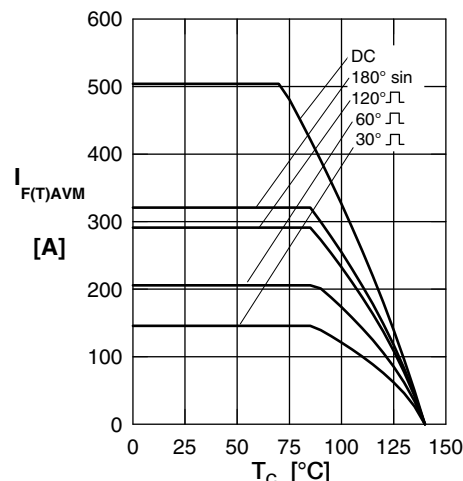

Fig. 4a Max. forward current at case temperature

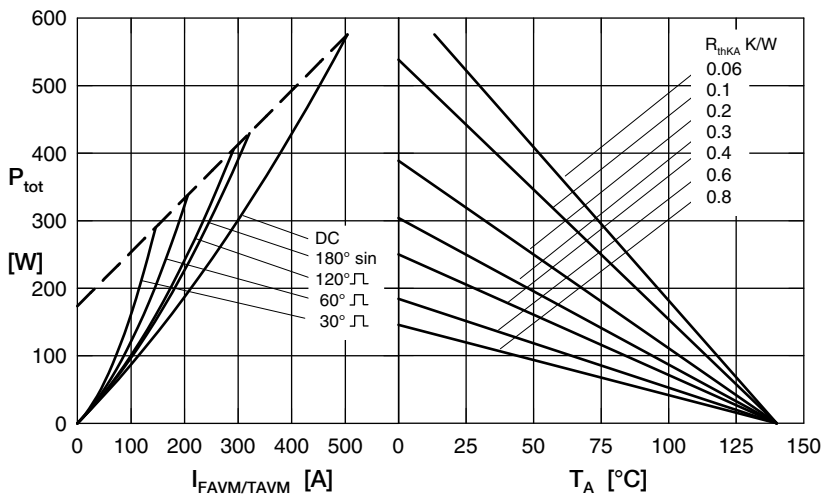

Fig. 5 Power dissipation versus on-state current and ambient temperature (per thyristor or diode)

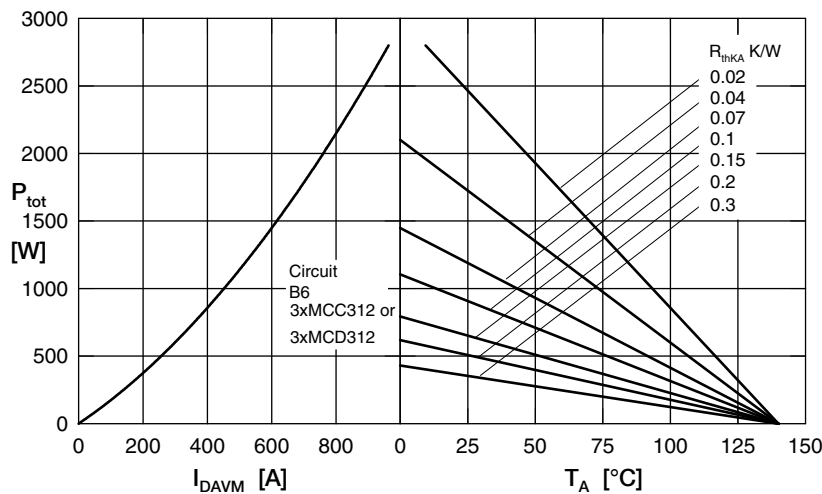

Fig. 6 Three phase rectifier bridge: Power dissipation versus direct output current and ambient temperature



Fig. 7 Three phase AC-controller: Power dissipation versus R_{MS} output current and ambient temperature

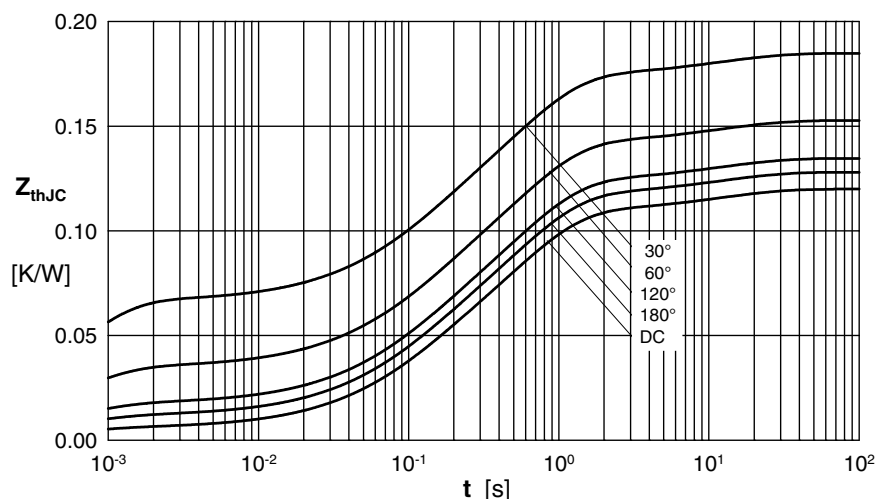

Fig. 8 Transient thermal impedance junction to case (per thyristor/diode)

R_{thjC} for various conduct. angles d:

d	R_{thjC} (K/W)
DC	0.120
180°	0.128
120°	0.135
60°	0.153
30°	0.185

Constants for Z_{thjC} calculation:

i	R_{thi} (K/W)	t_i (s)
1	0.0058	0.00054
2	0.031	0.098
3	0.072	0.54
4	0.0112	12



Fig. 9 Transient thermal impedance junction to heatsink (per thyristor/diode)

R_{thjK} for various conduct. angles d:

d	R_{thjK} (K/W)
DC	0.160
180°	0.168
120°	0.175
60°	0.193
30°	0.225

Constants for Z_{thjK} calculation:

i	R_{thi} (K/W)	t_i (s)
1	0.0058	0.00054
2	0.031	0.098
3	0.072	0.54
4	0.0112	12
5	0.04	12

Mouser Electronics

Authorized Distributor

Click to View Pricing, Inventory, Delivery & Lifecycle Information:

[IXYS:](#)

[MCD312-12io1](#) [MCD312-14io1](#) [MCD312-16io1](#) [MCD312-18io1](#) [MCC312-12io1](#) [MCC312-14io1](#) [MCC312-16io1](#)
[MCC312-18io1](#)