

TLP719

- Digital logic ground isolation
- Line receivers
- Microprocessor system interfaces
- Switching power supply feedback control
- Industrial invertors

The TOSHIBA TLP719 consists of a GaAlAs high-output light-emitting diode and a high-speed detector.

This unit is a 6-lead SDIP. The TLP719 is 50% smaller than the 8-pin DIP and meets the reinforced insulation class requirements of international safety standards. Therefore the mounting area can be reduced in equipment requiring safety standard certification.

The TLP719 has a Faraday shield integrated on the photodetector chip to provide an effective common mode noise transient immunity. Therefore this product is suitable for application in noisy environmental conditions.

- Open collector
- Package type : SDIP6
- Isolation voltage : 5000 Vrms (min)
- Common mode transient immunity : ± 10 kV/ μ s (min) @ $V_{CM} = 400$ V
- Switching speed : $t_{PHL}/t_{PLH} = 0.8$ μ s (max)
@ $I_F = 16$ mA, $V_{CC} = 5$ V,
 $R_L = 1.9$ k Ω , $T_a = 25$ °C
- TTL compatible
- Construction mechanical rating

	7.62-mm pitch standard type	10.16-mm pitch TLPXXXF type
Creepage Distance	7.0 mm (min)	8.0 mm (min)
Clearance	7.0 mm (min)	8.0 mm (min)
Insulation Thickness	0.4 mm (min)	0.4 mm (min)

- UL recognized : UL1577, File No. E67349
- c-UL approved : CSA Component Acceptance Service
No. 5A, File No. E67349
- Option (D4) VDE approved : EN60747-5-5 (Note 1)

Note 1: When a EN60747-5-5 approved type is needed, please designate the "Option(D4)"

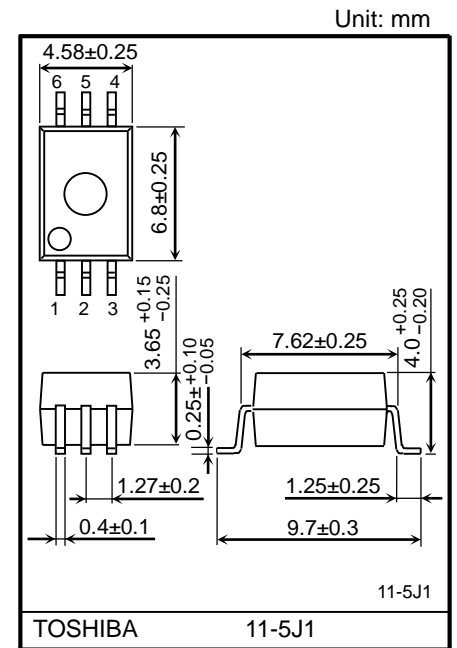

Weight: 0.26 g (typ.)

PIN CONFIGURATION (Top View)

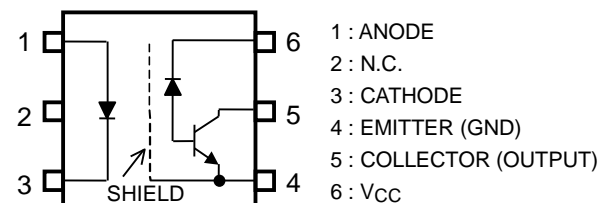

SCHEMATIC

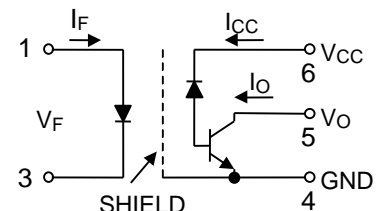

A 0.1- μ F bypass capacitor must be connected between pins 4 and 6.

Start of commercial production
2007-09

Absolute Maximum Ratings (Ta = 25 °C)

Characteristic		Symbol	Rating	Unit
LED	Forward current	IF	25	mA
	Forward current derating (Ta ≥ 70 °C)	IF / Ta	-0.45	mA / °C
	Pulse forward current (Note 1)	IFP	50	mA
	Peak transient forward current (Note 2)	IFPT	1	A
	Reverse voltage	VR	5	V
	Diode power dissipation (Note 3)	PD	45	mW
	Junction temperature	Tj	125	°C
Detector	Output current	IO	8	mA
	Peak output current	IOP	16	mA
	Output voltage	VO	-0.5 to 20	V
	Supply voltage	VCC	-0.5 to 30	V
	Output power dissipation	PO	100	mW
	Output power dissipation derating (Ta ≥ 70 °C)	Po / Ta	-1.8	mW / °C
	Junction Temperature	Tj	125	°C
Operating temperature range		Topr	-55 to 100	°C
Storage temperature range		Tstg	-55 to 125	°C
Lead soldering temperature (10 s)		Tsol	260	°C
Isolation voltage (AC, 60 s, R.H. ≤ 60 %)		BVs	5000	Vrms

Note: Using continuously under heavy loads (e.g. the application of high temperature/current/voltage and the significant change in temperature, etc.) may cause this product to decrease in the reliability significantly even if the operating conditions (i.e. operating temperature/current/voltage, etc.) are within the absolute maximum ratings.

Please design the appropriate reliability upon reviewing the Toshiba Semiconductor Reliability Handbook ("Handling Precautions"/"Derating Concept and Methods") and individual reliability data (i.e. reliability test report and estimated failure rate, etc).

Note : A ceramic capacitor (0.1 μF) should be connected from pin 6 to pin 4 to stabilize the operation of the high-gain linear amplifier. Failure to provide the bypassing may impair the switching property.
The total lead length between capacitor and coupler should not exceed 1 cm.

Note 1: 50% duty cycle, 1 ms pulse width.
Derate 0.9 mA / °C above 70 °C.

Note 2: Pulse width ≤ 1 μs, 300 pps.

Note 3: Derate 0.8 mW / °C above 70 °C.

Note 4: Device considered a two-terminal device: pins 1, 2 and 3 paired with pins 4, 5 and 6 respectively.

Electrical Characteristics (Ta = 25 °C)

Characteristic		Symbol	Test Condition	Min	Typ.	Max	Unit
LED	Forward voltage	V_F	$I_F = 16 \text{ mA}$	—	1.65	1.85	V
	Forward voltage Temperature coefficient	$\Delta V_F / \Delta T_a$	$I_F = 16 \text{ mA}$	—	-2	—	mV / °C
	Reverse current	I_R	$V_R = 5 \text{ V}$	—	—	10	μA
	Capacitance between terminals	C_T	$V_F = 0 \text{ V}, f = 1 \text{ MHz}$	—	45	—	pF
Detector	HIGH-level output current	$I_{OH(1)}$	$I_F = 0 \text{ mA}, V_{CC} = V_O = 5.5 \text{ V}$	—	3	500	nA
		$I_{OH(2)}$	$I_F = 0 \text{ mA}, V_{CC} = 30 \text{ V}$ $V_O = 20 \text{ V}$	—	—	5	μA
		I_{OH}	$I_F = 0 \text{ mA}, V_{CC} = 30 \text{ V}$ $V_O = 20 \text{ V}, T_a = 70 \text{ }^\circ\text{C}$	—	—	50	
	HIGH-level supply current	I_{CCH}	$I_F = 0 \text{ mA}, V_{CC} = 30 \text{ V}$	—	0.01	1	μA
	Supply voltage	V_{CC}	$I_{CC} = 0.01 \text{ mA}$	30	—	—	V
	Output voltage	V_O	$I_O = 0.5 \text{ mA}$	20	—	—	V

Coupled Electrical Characteristics (Ta = 25 °C)

Characteristic	Symbol	Test Condition	Min	Typ.	Max	Unit
Current transfer ratio	I_O / I_F	$I_F = 16 \text{ mA}, V_{CC} = 4.5 \text{ V}$ $V_O = 0.4 \text{ V}$	20	—	—	%
LOW-level output voltage	V_{OL}	$I_F = 16 \text{ mA}, V_{CC} = 4.5 \text{ V}$ $I_O = 2.4 \text{ mA}$	—	—	0.4	V

Isolation Characteristics (Ta = 25 °C)

Characteristic	Symbol	Test Condition	Min	Typ.	Max	Unit
Capacitance input to output	C_S	$V = 0 \text{ V}, f = 1 \text{ MHz}$ (Note 1)	—	0.8	—	pF
Isolation resistance	R_S	R.H. $\leq 60\%, V_S = 500 \text{ V}$ (Note 1)	1×10^{12}	10^{14}	—	Ω
Isolation voltage	BV_S	AC, 60 s	5000	—	—	V_{rms}
		AC, 1 s, in oil	—	10000	—	
		DC, 60 s, in oil	—	10000	—	Vdc

Note 1: Device considered a two-terminal device: pins 1, 2 and 3 paired with pins 4, 5 and 6 respectively.

Switching Characteristics (Ta = 25 °C, Vcc = 5 V)

Characteristic	Symbol	Test Circuit	Test Condition	Min	Typ.	Max	Unit
Propagation delay time (H → L)	tpHL	Fig1	IF = 0 → 16 mA RL = 1.9kΩ	—	—	0.8	μs
Propagation delay time (L → H)	tpLH		IF = 16 → 0 mA RL = 1.9kΩ	—	—	0.8	μs
Common mode transient immunity at logic HIGH output (Note 1)	CMH	Fig2	IF = 0 mA VCM = 400 Vp-p RL = 1.9kΩ	10000	—	—	V / μs
Common mode transient immunity at logic LOW output (Note 1)	CML		IF = 16 mA VCM = 400 Vp-p RL = 1.9 kΩ	-10000	—	—	V / μs

Note 1 : CML is the maximum rate of fall of the common mode voltage that can be sustained with the output voltage in the logic LOW state (VO < 0.8 V).

CMH is the maximum rate of rise of the common mode voltage that can be sustained with the output voltage in the logic HIGH state (VO > 2.0 V).

Figure 1. Switching Time Test Circuit

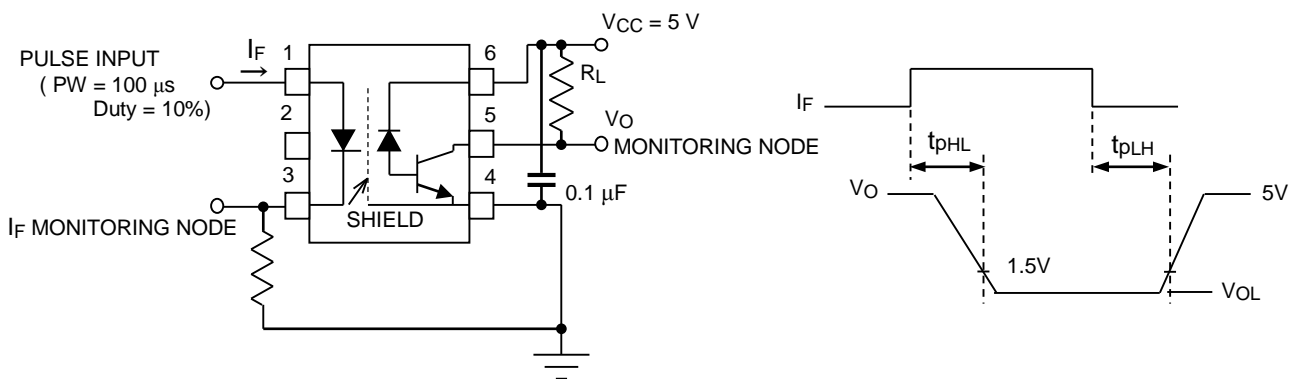
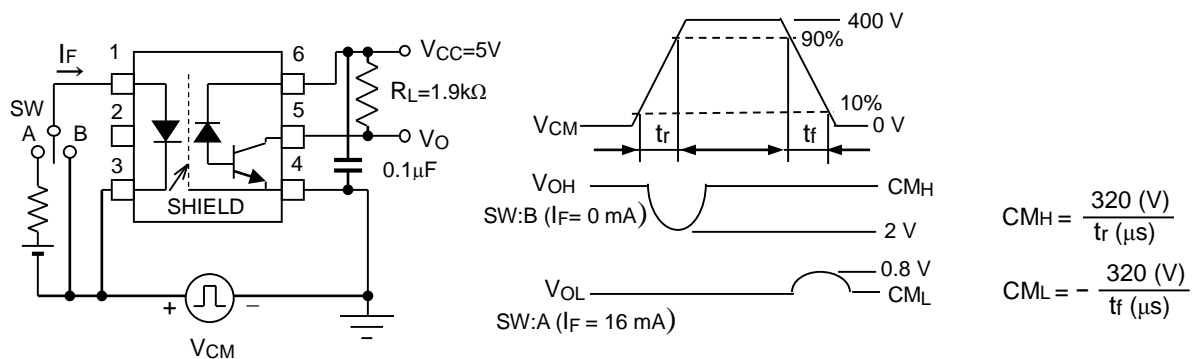
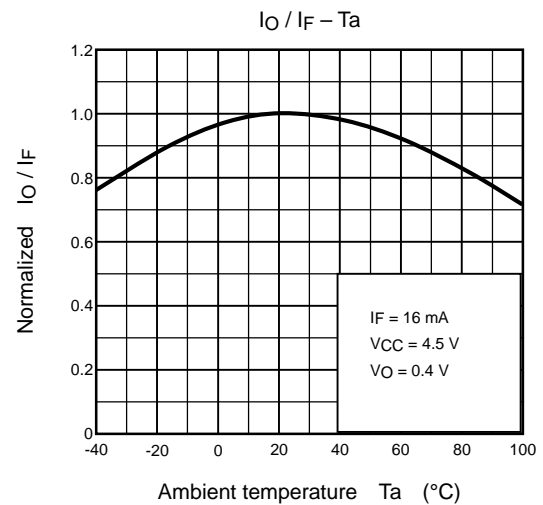
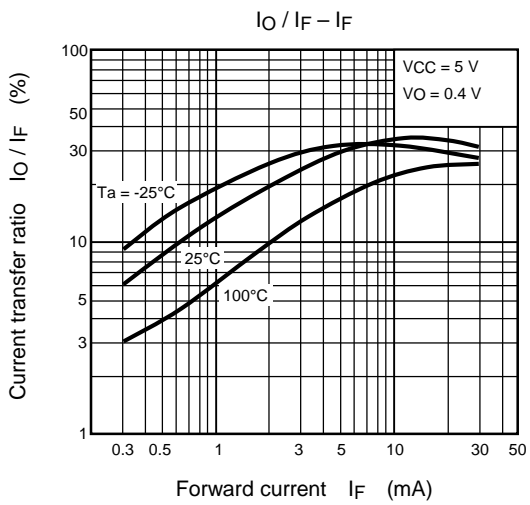
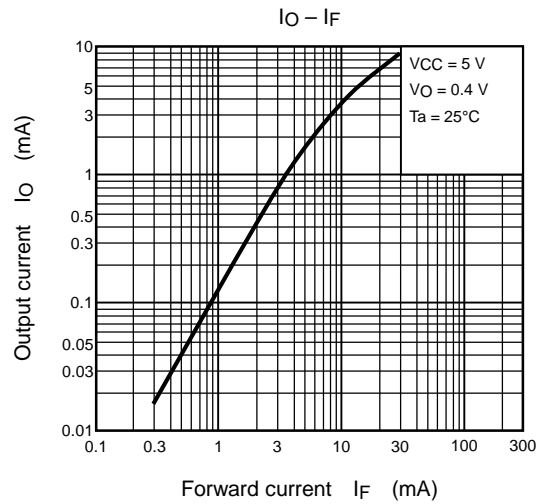
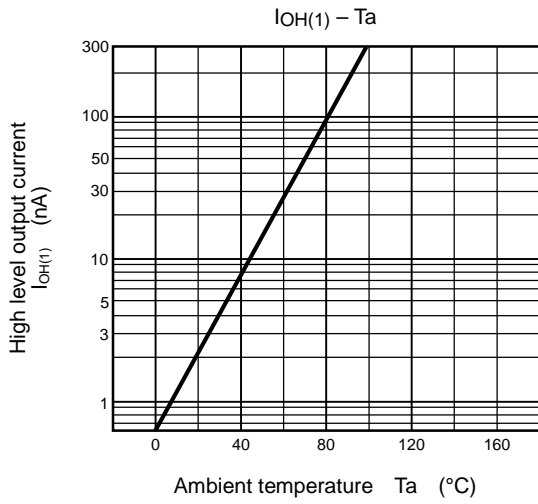
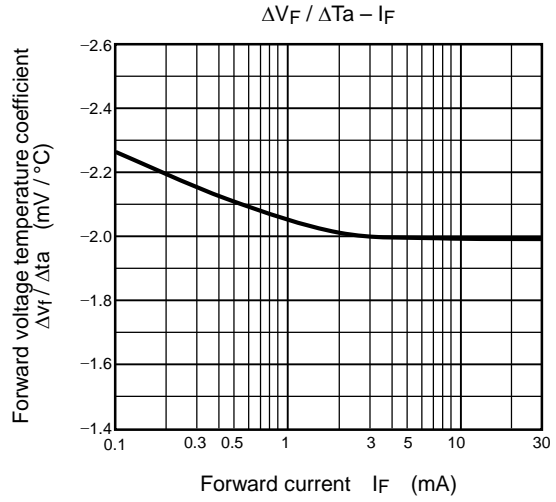
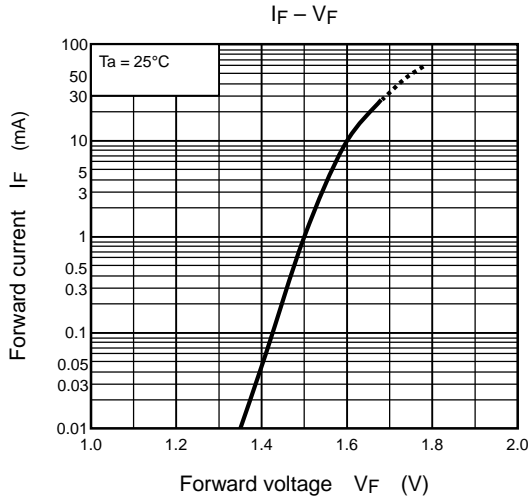
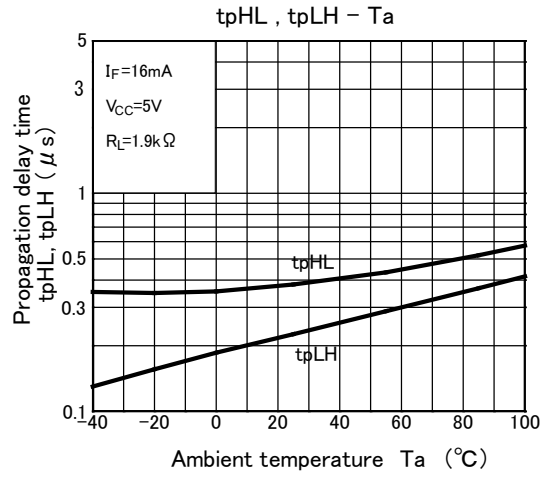
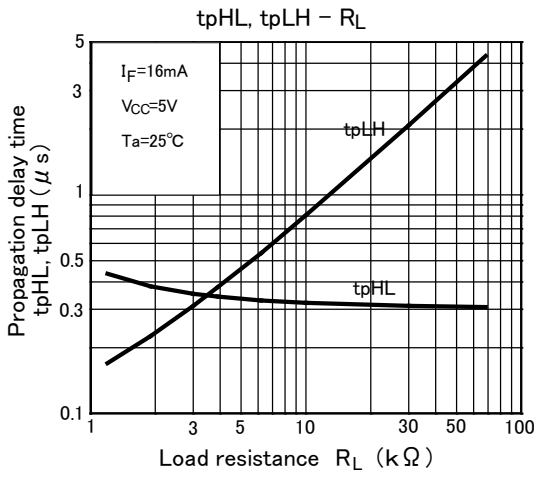
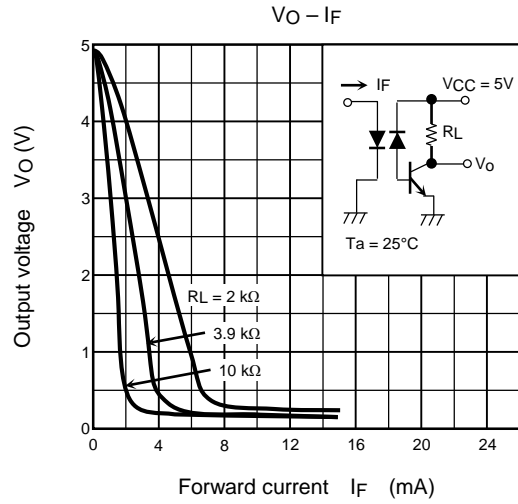
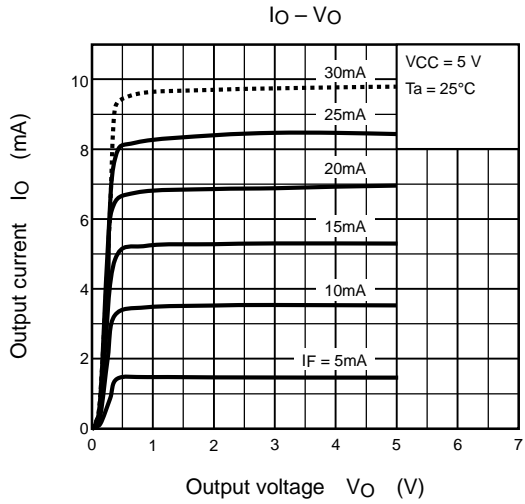

Figure 2. Common Mode Noise Immunity Test Circuit.







RESTRICTIONS ON PRODUCT USE

- Toshiba Corporation, and its subsidiaries and affiliates (collectively "TOSHIBA"), reserve the right to make changes to the information in this document, and related hardware, software and systems (collectively "Product") without notice.
- This document and any information herein may not be reproduced without prior written permission from TOSHIBA. Even with TOSHIBA's written permission, reproduction is permissible only if reproduction is without alteration/omission.
- Though TOSHIBA works continually to improve Product's quality and reliability, Product can malfunction or fail. Customers are responsible for complying with safety standards and for providing adequate designs and safeguards for their hardware, software and systems which minimize risk and avoid situations in which a malfunction or failure of Product could cause loss of human life, bodily injury or damage to property, including data loss or corruption. Before customers use the Product, create designs including the Product, or incorporate the Product into their own applications, customers must also refer to and comply with (a) the latest versions of all relevant TOSHIBA information, including without limitation, this document, the specifications, the data sheets and application notes for Product and the precautions and conditions set forth in the "TOSHIBA Semiconductor Reliability Handbook" and (b) the instructions for the application with which the Product will be used with or for. Customers are solely responsible for all aspects of their own product design or applications, including but not limited to (a) determining the appropriateness of the use of this Product in such design or applications; (b) evaluating and determining the applicability of any information contained in this document, or in charts, diagrams, programs, algorithms, sample application circuits, or any other referenced documents; and (c) validating all operating parameters for such designs and applications. **TOSHIBA ASSUMES NO LIABILITY FOR CUSTOMERS' PRODUCT DESIGN OR APPLICATIONS.**
- **PRODUCT IS NEITHER INTENDED NOR WARRANTED FOR USE IN EQUIPMENTS OR SYSTEMS THAT REQUIRE EXTRAORDINARILY HIGH LEVELS OF QUALITY AND/OR RELIABILITY, AND/OR A MALFUNCTION OR FAILURE OF WHICH MAY CAUSE LOSS OF HUMAN LIFE, BODILY INJURY, SERIOUS PROPERTY DAMAGE AND/OR SERIOUS PUBLIC IMPACT ("UNINTENDED USE").** Except for specific applications as expressly stated in this document, Unintended Use includes, without limitation, equipment used in nuclear facilities, equipment used in the aerospace industry, medical equipment, equipment used for automobiles, trains, ships and other transportation, traffic signaling equipment, equipment used to control combustions or explosions, safety devices, elevators and escalators, devices related to electric power, and equipment used in finance-related fields. **IF YOU USE PRODUCT FOR UNINTENDED USE, TOSHIBA ASSUMES NO LIABILITY FOR PRODUCT.** For details, please contact your TOSHIBA sales representative.
- Do not disassemble, analyze, reverse-engineer, alter, modify, translate or copy Product, whether in whole or in part.
- Product shall not be used for or incorporated into any products or systems whose manufacture, use, or sale is prohibited under any applicable laws or regulations.
- The information contained herein is presented only as guidance for Product use. No responsibility is assumed by TOSHIBA for any infringement of patents or any other intellectual property rights of third parties that may result from the use of Product. No license to any intellectual property right is granted by this document, whether express or implied, by estoppel or otherwise.
- **ABSENT A WRITTEN SIGNED AGREEMENT, EXCEPT AS PROVIDED IN THE RELEVANT TERMS AND CONDITIONS OF SALE FOR PRODUCT, AND TO THE MAXIMUM EXTENT ALLOWABLE BY LAW, TOSHIBA (1) ASSUMES NO LIABILITY WHATSOEVER, INCLUDING WITHOUT LIMITATION, INDIRECT, CONSEQUENTIAL, SPECIAL, OR INCIDENTAL DAMAGES OR LOSS, INCLUDING WITHOUT LIMITATION, LOSS OF PROFITS, LOSS OF OPPORTUNITIES, BUSINESS INTERRUPTION AND LOSS OF DATA, AND (2) DISCLAIMS ANY AND ALL EXPRESS OR IMPLIED WARRANTIES AND CONDITIONS RELATED TO SALE, USE OF PRODUCT, OR INFORMATION, INCLUDING WARRANTIES OR CONDITIONS OF MERCHANTABILITY, FITNESS FOR A PARTICULAR PURPOSE, ACCURACY OF INFORMATION, OR NONINFRINGEMENT.**
- GaAs (Gallium Arsenide) is used in Product. GaAs is harmful to humans if consumed or absorbed, whether in the form of dust or vapor. Handle with care and do not break, cut, crush, grind, dissolve chemically or otherwise expose GaAs in Product.
- Do not use or otherwise make available Product or related software or technology for any military purposes, including without limitation, for the design, development, use, stockpiling or manufacturing of nuclear, chemical, or biological weapons or missile technology products (mass destruction weapons). Product and related software and technology may be controlled under the applicable export laws and regulations including, without limitation, the Japanese Foreign Exchange and Foreign Trade Law and the U.S. Export Administration Regulations. Export and re-export of Product or related software or technology are strictly prohibited except in compliance with all applicable export laws and regulations.
- Please contact your TOSHIBA sales representative for details as to environmental matters such as the RoHS compatibility of Product. Please use Product in compliance with all applicable laws and regulations that regulate the inclusion or use of controlled substances, including without limitation, the EU RoHS Directive. **TOSHIBA ASSUMES NO LIABILITY FOR DAMAGES OR LOSSES OCCURRING AS A RESULT OF NONCOMPLIANCE WITH APPLICABLE LAWS AND REGULATIONS.**