

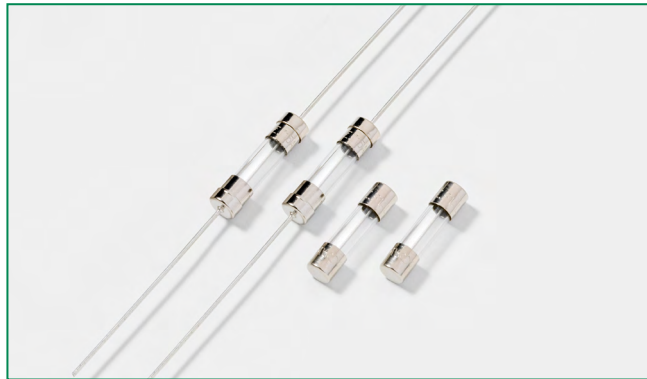

### 201P Series, 5×20mm, Medium-Acting Fuse



#### Agency Approvals

Agency	Agency File Number	Ampere Range
	E67006	0.050A-1.25A

#### Additional Information



Datasheet



Resources



Samples

#### Description

5×20mm Medium-Acting, Time-lag, Glass Body Cartridge Fuse.

#### Features

- Visual fault indication
- Direct solderable or plug-in versions
- Worldwide availability
- RoHS compliant and Lead-free

#### Applications

Used as supplementary protection in appliance or utilization equipment to provide individual protection for components or internal circuits.

#### Electrical Characteristics for Series

% of Ampere Rating	Opening Time
150	1 Hour Minimum
210	600 s Maximum
400	40 ms Minimum 2 s Maximum
1000	5 ms Minimum 90 ms Maximum

#### Electrical Characteristic Specifications by Item

Amp Code	Amp Rating	Voltage Rating	Interrupting Rating	Nominal Resistance Cold Ohms (mohms)	Nominal Melting Integral $10 \times I_N$ max. (A <sup>2</sup> s)	Voltage Drop $1.0 \times I_N$ max. (mV)	Power Dissipation $1.5 \times I_N$ max. (W)	Agency Approvals 
0050	0.050	250V	80A @ 250V AC	9200	0.00900	640	0.10000	x
0063	0.063	250V		7400	0.01100	600	0.10000	x
0080	0.080	250V		5330	0.01700	540	0.20000	x
0100	0.100	250V		3550	0.03100	500	0.20000	x
0125	0.125	250V		2650	0.05700	440	0.20000	x
0160	0.160	250V		1780	0.08500	400	0.20000	x
0200	0.200	250V		1250	0.12000	340	0.30000	x
0250	0.250	250V		870	0.13000	320	0.30000	x
0315	0.315	250V		590	0.16000	300	0.30000	x
0400	0.400	250V		435	0.28000	230	0.40000	x
0500	0.500	250V		160	0.35000	210	0.40000	x
0630	0.630	250V		130	0.80900	190	0.50000	x
0800	0.800	250V		85	1.10000	170	0.60000	x
1100	1.000	250V		70	2.00000	160	0.70000	x
1125	1.250	250V		50	5.12000	160	0.80000	x

Note: 1.00 means the number one with two decimal places. 1,000 means the number one thousand.

**Temperature Re-rating Curve**

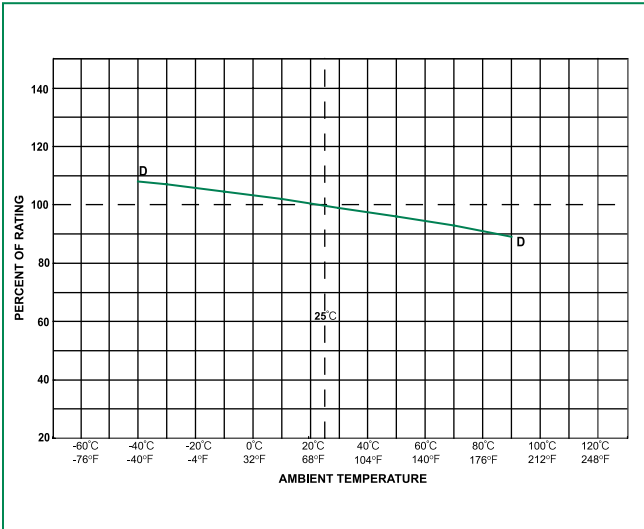

Note:  
Rerating depicted in this curve is in addition to the standard derating of 25% for continuous operation.

**Average Time Current Curves**

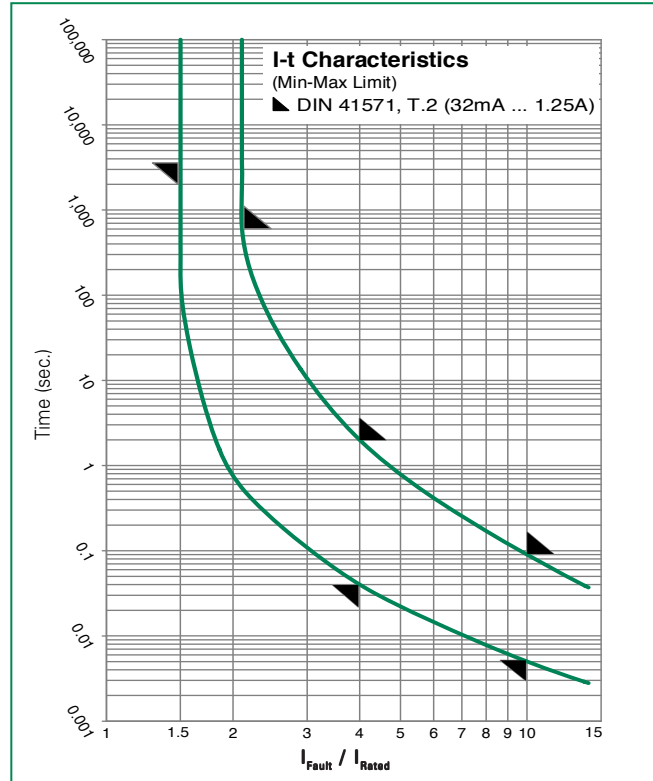

**Soldering Parameters - Wave Soldering**

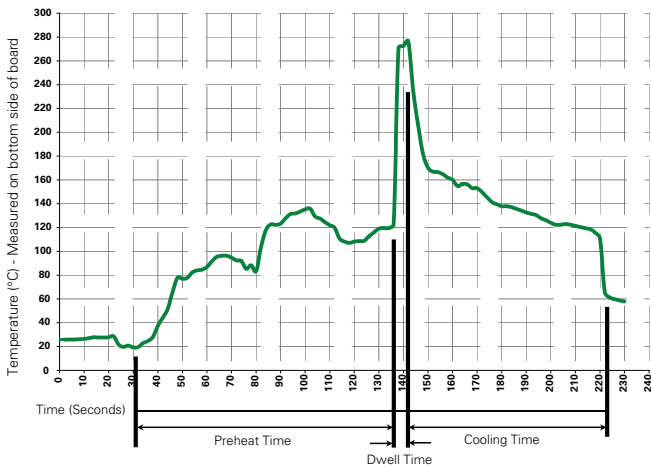

**Recommended Process Parameters:**

Wave Parameter	Lead-Free Recommendation
<b>Preheat:</b> (Depends on Flux Activation Temperature)	(Typical Industry Recommendation)
Temperature Minimum:	100°C
Temperature Maximum:	150°C
Preheat Time:	60-180 seconds
<b>Solder Pot Temperature:</b>	260°C Maximum
<b>Solder Dwell Time:</b>	2-5 seconds

**Recommended Hand-Solder Parameters:**

Solder Iron Temperature: 350°C +/- 5°C  
Heating Time: 5 seconds max.

**Note: These devices are not recommended for IR or Convection Reflow process.**

### Product Characteristics

<b>Materials</b>	Body: Glass End Caps: Nickel-plated brass Optional Holders: Nickel-plated caps Tin-plated wires
<b>Product Marking</b>	Cap1: Brand mark, current and voltage ratings Cap2: Series and agency approval marks
<b>Solderability</b>	MIL-STD-202, Method 208
<b>Soldering Heat Resistance</b>	260°C, 10 sec. (IEC 60068-2-20)

<b>Operating Temperature</b>	-25°C to +70°C
<b>Climatic Category</b>	-25°C/+70°C/21 days (IEC 60068-1-3)
<b>Stock Conditions</b>	-10°C to +60°C RH, ≤ 75% yearly average, without dew, maximum value for 30 days-95%
<b>Vibration Resistance</b>	24 cycles at 15 min. each (EN 60068-2-6) 10 - 60 Hz at 0.75 mm amplitude 60 - 2000 Hz at 10 g acceleration

### Dimensions

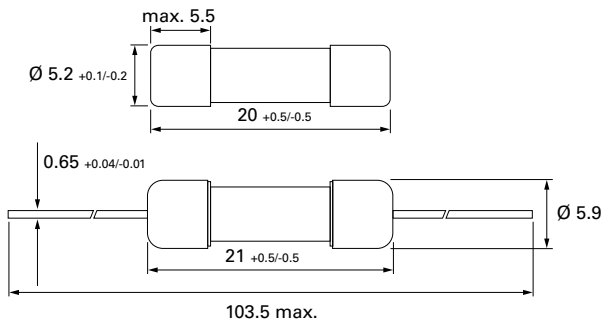

Optional Holders

### Part Numbering System

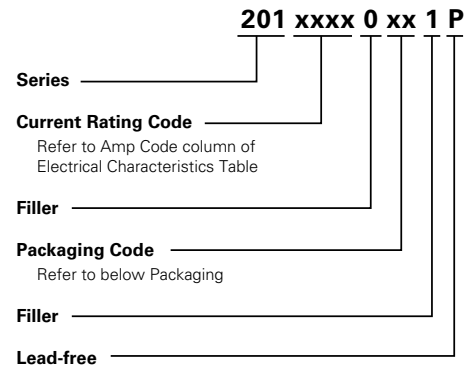

### Packaging

Packaging Code	Packing Option	Quantity
00	Bulk	1000
02	Bulk	100
30	Bulk with Four Color Code	1000
43	Tape and Reel	1250
53	Tape and Reel with Four Color Code	1250