

Fuses for Semiconductor Protection

Cylindrical Fuses



SIBA cylindrical ultra-rapid fuses are available in six different sizes. They can be fitted with or without a built-in striker pin for fuse blown indication or operation of microswitches.

Approval: 
 Standards: IEC 60269-1 and -4
 DIN VDE 0636-40
 UL 248-13
 Classes: gR/aR/gRL (gS)
 Current ratings: 100 mA – 250 A

Sizes and voltage ratings:

5 x 20 mm: AC 250 V
 6.35 x 32 mm: AC 500 – 1000 V
 10 x 38 mm: AC 600 – 1000 V
 14 x 51 mm: AC 500/600V – 690/700 V
 22 x 58 mm: AC 500/600 V – 690/700 V
 27 x 60 mm: AC 660 V – 1000 V

Features / Benefits

- ▶ High interrupting rating up to 300 kA
- ▶ Voltage rating AC 250 V to AC 1000 V
- ▶ Protection of Power Semiconductors according to IEC 60269-1 and -4
- ▶ Available with integrated striker pin
- ▶ Classes according to IEC 60269-4 and DIN VDE 0636-40
- ▶ Fuse-holder / fuse-clips and accessories are available



Fuses for Semiconductor Protection

Cylindrical Fuses

Selection Guide Fuse-Links

Size	Rated Voltage	Indicator Type	Part No.	Selector Guide [Page]	Techn. Data [Page]
5 x 20	AC 250 V	–	70 001 40	URZ 4	URZ 16
5 x 20	AC 250 V	–	70 007 40	URZ 4	URZ 16
6.35 x 32	AC 500/700 V	–	70 125 40	URZ 5	URZ 18
6.35 x 32	AC 400 V	–	70 065 84	URZ 5	URZ 17
6.35 x 32	AC/DC 1000 V	–	70 172 40	URZ 6	URZ 19
10 x 38	AC 600 V	–	60 034 34	URZ 7	URZ 20
10 x 38	AC 600 V	–	60 064 34	URZ 7	URZ 20
10 x 38	AC 600 V	–	60 033 05	URZ 7	URZ 21
10 x 38	AC 660 V	–	50 179 06	URZ 8	URZ 22
10 x 38	AC/DC 1000 V	–	50 199 06	URZ 8	URZ 23
10 x 35	AC/DC 1000 V	–	50 210 06	URZ 8	URZ 24
14 x 51	AC 500/600 V	–	50 058 06	URZ 9	URZ 25
14 x 51	AC 500/600 V	with striker	50 059 06	URZ 9	URZ 25
14 x 51	AC 690 V	–	50 124 06	URZ 9	URZ 27
14 x 51	AC 690 V	with striker	50 126 06	URZ 9	URZ 27
14 x 51	AC 690 V	–	50 124 34	URZ 10	URZ 26
14 x 51	AC 690 V	with striker	50 126 34	URZ 10	URZ 26
14 x 51	DC 700 V	–	50 118 06	URZ 11	URZ 28
14 x 51	DC 700 V	–	50 201 06	URZ 11	URZ 29
22 x 58	AC 500/660 V	–	50 060 06	URZ 12	URZ 30
22 x 58	AC 500/660 V	with striker	50 061 06	URZ 12	URZ 30
22 x 58	AC 690 V	–	50 140 06	URZ 12	URZ 31
22 x 58	AC 690 V	with striker	50 142 06	URZ 12	URZ 31
22 x 58	AC 690 V	–	50 140 34	URZ 13	URZ 32
22 x 58	AC 690 V	with striker	50 142 34	URZ 13	URZ 32
27 x 60	AC 660 V	–	50 193 20	URZ 14	URZ 33
27 x 60	AC 660 V	with striker	50 194 20	URZ 14	URZ 33
27 x 60	AC 1000 V	–	50 196 20	URZ 14	URZ 34
27 x 60	AC 1000 V	with striker	50 197 20	URZ 14	URZ 34
27 x 60	DC 660 V	–	50 190 06	URZ 15	URZ 35



Fuses for Semiconductor Protection

Cylindrical Fuses

Selection Guide Fuse-Holder ZS-Modul

ZS-Module	Number of Poles	Indicator Type	Part No.	Techn. Data [Page]
10 x 38	1	-	51 063 04.DC	URZ 37
10 x 38	1	-	51 063 04	URZ 37
10 x 38	2	-	51 063 04.2	URZ 37
10 x 38	3	-	51 063 04.3	URZ 37
10 x 38	1	LED indicator	51 063 04.L	URZ 37
10 x 38	2	LED indicator	51 063 04.2L	URZ 37
10 x 38	3	LED indicator	51 063 04.3L	URZ 37
14 x 51	1	-	51 058 04	URZ 37
14 x 51	2	-	51 058 04.2	URZ 37
14 x 51	3	-	51 058 04.3	URZ 37
14 x 51	1	micro switch	51 058 04.S	URZ 37
14 x 51	2	micro switch	51 058 04.2S	URZ 37
14 x 51	3	micro switch	51 058 04.3S	URZ 37
22 x 58	1	-	51 060 04	URZ 37
22 x 58	2	-	51 060 04.2	URZ 37
22 x 58	3	-	51 060 04.3	URZ 37
22 x 58	1	micro switch	51 060 04.S	URZ 37
22 x 58	3	micro switch	51 060 04.3S	URZ 37

Selection Guide Fuse-Clips

Size	Part No.	Techn. Data [Page]	Type
10 mm	61 017 01.2	URZ 35	
14 mm	61 001 01.2	URZ 35	screw
22 mm	61 002 01.3	URZ 35	mountable
27 mm	61 004 01.3	URZ 35	
14 mm	58 058 06	URZ 36	PCB
22 mm	58 060 06	URZ 36	mountable



Fuses for Semiconductor Protection

Cylindrical Fuses

Size
5 x 20 mm

Rated Voltage
AC 250 V

Class
aR

Rated Current [A]	Part No.	Rated Breaking Capacity [kA]	UL Rec.	Weight [kg/100]	Pack
100 mA	70 001 40.0.100	300	✓	0.14	100
125 mA	70 001 40.0.125	300	✓	0.14	100
160 mA	70 001 40.0.160	300	✓	0.14	100
200 mA	70 001 40.0.200	300	✓	0.14	100
250 mA	70 001 40.0.250	300	✓	0.14	100
315 mA	70 001 40.0.315	300	✓	0.14	100
400 mA	70 001 40.0.400	300	✓	0.14	100
500 mA	70 001 40.0.500	300	✓	0.14	100
630 mA	70 001 40.0.630	300	✓	0.14	100
800 mA	70 001 40.0.800	300	✓	0.14	100
1	70 001 40.1	300	✓	0.14	100
1.25	70 001 40.1.25	300	✓	0.14	100
1.6	70 001 40.1.6	300	✓	0.14	100
2	70 001 40.2	300	✓	0.14	100
2.5	70 001 40.2.5	300	✓	0.14	100
3.15	70 001 40.3.15	300	✓	0.14	100
4	70 001 40.4	300	✓	0.14	100
5	70 001 40.5	300	✓	0.14	100
6.3	70 001 40.6.3	1 500 A		0.14	100
8	70 001 40.8	1 500 A		0.14	100
10	70 001 40.10	1 500 A		0.14	100
6.3	70 007 40.6.3	300	✓	0.14	100
8	70 007 40.8	300	✓	0.14	100
10	70 007 40.10	300	✓	0.14	100
12.5	70 007 40.12.5	300	✓	0.14	100

A 0.79" (20 mm)

B 0.2" (5 mm)

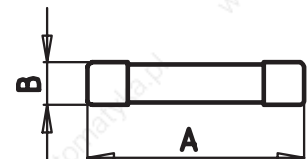



Fuses for Semiconductor Protection

Cylindrical Fuses

Size **6.35 x 32 mm** Rated Voltage **AC 400 V** Class **gRL(gS)**

Rated Current [A]	Part No.	Rated Breaking Capacity [kA]	Rated Voltage [AC]	UL Rec.	Weight [kg/100]	Pack
6.3	70 065 84.6.3	120 kA	400 V	✓	0.9	10
8	70 065 84.8	120 kA	400 V	✓	0.9	10
10	70 065 84.10	120 kA	400 V	✓	0.9	10
12.5	70 065 84.12.5	120 kA	400 V	✓	0.9	10
16	70 065 84.16	120 kA	400 V	✓	0.9	10
20	70 065 84.20	120 kA	400 V	✓	0.9	10

Size **6.35 x 32 mm** Rated Voltage **AC 500/700 V** Class **aR**

Rated Current [A]	Part No.	Rated Breaking Capacity [kA]	Rated Voltage [V]	UL Rec.	c UL	Weight [kg/100]	Pack
160 mA	70 125 40.0.160	50	700	✓	✓	0.24	100
200 mA	70 125 40.0.200	50	700	✓	✓	0.24	100
250 mA	70 125 40.0.250	50	700	✓	✓	0.24	100
315 mA	70 125 40.0.315	50	700	✓	✓	0.24	100
400 mA	70 125 40.0.400	50	700	✓	✓	0.24	100
500 mA	70 125 40.0.500	50	700	✓	✓	0.24	100
630 mA	70 125 40.0.630	50	700	✓	✓	0.24	100
800 mA	70 125 40.0.800	50	700	✓	✓	0.24	100
1	70 125 40.1	50	700	✓	✓	0.24	100
1.25	70 125 40.1.25	50	700	✓	✓	0.24	100
1.6	70 125 40.1.6	50	700	✓	✓	0.24	100
2	70 125 40.2	50	700	✓	✓	0.24	100
2.5	70 125 40.2.5	50	500	✓	✓	0.24	100
3.15	70 125 40.3.15	50	500	✓	✓	0.24	100
4	70 125 40.4	50	500	✓	✓	0.24	100
5	70 125 40.5	50	500	✓	✓	0.24	100
6.3	70 125 40.6.3	50	500	✓	✓	0.24	100
8 ¹	70 125 40.8	50	500	✓	✓	0.24	100
10 ¹	70 125 40.10	50	500	✓	✓	0.24	100
12.5 ¹	70 125 40.12.5	50	500	✓	✓	0.24	100
16 ¹	70 125 40.16	50	500	✓	✓	0.24	100
20 ¹	70 125 40.20	50	500	✓	✓	0.24	100

¹ Consideration should be given to heat dissipation.

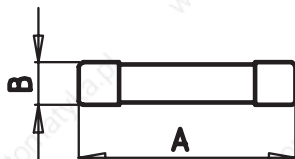

A 1.26" (32 mm)
B 0.25" (6.35 mm)

Fuses for Semiconductor Protection

Cylindrical Fuses



Size **6.35 x 32 mm** Rated Voltage **AC/DC 1000 V** **DMI Fuse for Digital Measuring Instruments** Class **aR**

Rated Current [A]	Part No.	UL Rec.	Weight [kg/100]	Pack
315 mA	70 172 40.0.315		0.24	100
500 mA	70 172 40.0.500		0.24	100
1.6 A	70 172 40.1.6		0.24	100
2 A	70 172 40.2		0.24	100

A 1.26" (32 mm)
B 0.25" (6.35 mm)

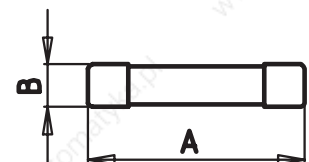



Fuses for Semiconductor Protection
Cylindrical Fuses

Size **10 x 38 mm** Rated Voltage **AC 500 V (IEC) · AC 600 V (UL)** Class **gRL(gS)**

Rated Current [A]	Part No.	Part No. PCB Mounting	UL Rec.	Weight [kg/100]	Pack
6	60 034 34.6	60 064 34.6	✓	0.9	10
8	60 034 34.8	60 064 34.8	✓	0.9	10
10	60 034 34.10	60 064 34.10	✓	0.9	10
12	60 034 34.12	60 064 34.12	✓	0.9	10
16	60 034 34.16	60 064 34.16	✓	0.9	10
20	60 034 34.20	60 064 34.20	✓	0.9	10
25	60 034 34.25	60 064 34.25	✓	0.9	10
30	60 034 34.30	60 064 34.30	✓	0.9	10

Size **10 x 38 mm** Rated Voltage **AC 600 V** Class **aR**

Rated Current [A]	Part No.	UL Rec.	Weight [kg/100]	Pack
1	60 033 05.1		0.9	10
2	60 033 05.2		0.9	10
4	60 033 05.4		0.9	10
5	60 033 05.5	✓	0.9	10
6	60 033 05.6	✓	0.9	10
8	60 033 05.8	✓	0.9	10
10	60 033 05.10	✓	0.9	10
12	60 033 05.12	✓	0.9	10
16	60 033 05.16	✓	0.9	10
20	60 033 05.20	✓	0.9	10
25	60 033 05.25	✓	0.9	10
30	60 033 05.30	✓	0.9	10

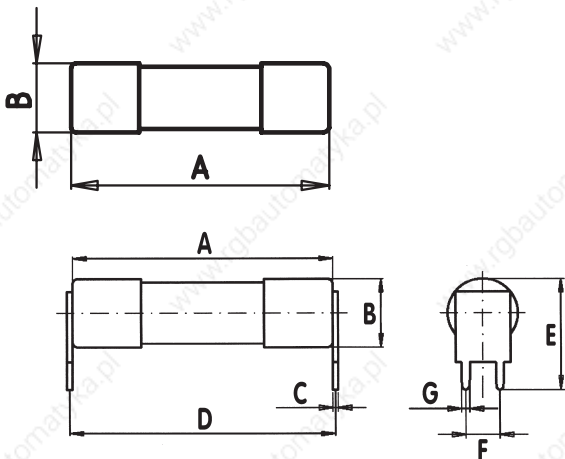

- A 1.50" (38 mm)
- B 0.40" (10 mm)

- PCB Mounting**
- A 1.50" (38 mm)
 - B 0.40" (10 mm)
 - C 0.03" (0.8 mm)
 - D 1.53" (16.4 mm)
 - E 0.65" (16.4 mm)
 - F 0.20" (5.1 mm)
 - G 0.05" (1.2 mm)



Fuses for Semiconductor Protection
Cylindrical Fuses

Size **10 x 38 mm** Rated Voltage **AC 660 V (IEC) · AC 700 V (UL)**

Class **gR**

Rated Current [A]	Part No.	UL Rec.	CSA	Weight [kg/100]	Pack
1	50 179 06.1	✓	✓	0.9	10
2	50 179 06.2	✓	✓	0.9	10
4	50 179 06.4	✓	✓	0.9	10
5	50 179 06.5	✓	✓	0.9	10
6	50 179 06.6	✓	✓	0.9	10
8	50 179 06.8	✓	✓	0.9	10
10	50 179 06.10	✓	✓	0.9	10
12	50 179 06.12	✓	✓	0.9	10
16	50 179 06.16	✓	✓	0.9	10
20	50 179 06.20	✓	✓	0.9	10
25	50 179 06.25	✓	✓	0.9	10
30	50 179 06.30	✓	✓	0.9	10

Size **10 x 38 mm** Rated Voltage **AC/DC 1000 V** **DMI Fuse for Digital Measuring Instruments**

Class **aR**

Rated Current [A]	Part No.	UL Rec.	Weight [kg/100]	Pack
4	50 199 06.4		0.9	10
6	50 199 06.6		0.9	10
8	50 199 06.8		0.9	10
10	50 199 06.10		0.9	10
12	50 199 06.12		0.9	10
16	50 199 06.16		0.9	10

Size **10 x 35 mm** Rated Voltage **AC/DC 1000 V** **DMI Fuse for Digital Measuring Instruments**

Class **aR**

Rated Current [A]	Part No.	UL Rec.	Weight [kg/100]	Pack
0.2	50 210 06.0.2		0.8	10
0.25	50 210 06.0.25		0.8	10
0.315	50 210 06.0.315		0.8	10
0.4	50 210 06.0.4		0.8	10
0.44	50 210 06.0.44		0.8	10

Part No.
50 179 06 + 50 199 06

A **1.50"** (38 mm)
B **0.40"** (10 mm)

Part No.
50 210 06

A **1.38"** (35 mm)
B **0.40"** (10 mm)

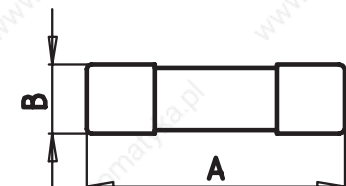



Fuses for Semiconductor Protection
Cylindrical Fuses

Size **14 x 51 mm** Rated Voltage **AC 500 V (IEC) · AC 600 V (UL)** Class **aR**

Rated Current [A]	Part No. without Striker	Part No. with Striker	UL Rec.	Weight [kg/100]	Pack
6	50 058 06.6	50 059 06.6		2.2	10
8	50 058 06.8	50 059 06.8		2.2	10
10	50 058 06.10	50 059 06.10		2.2	10
12	50 058 06.12	50 059 06.12		2.2	10
16	50 058 06.16	50 059 06.16		2.2	10
20	50 058 06.20	50 059 06.20		2.2	10
25	50 058 06.25	50 059 06.25		2.2	10
32	50 058 06.32	50 059 06.32		2.2	10
40	50 058 06.40	50 059 06.40		2.2	10
50	50 058 06.50	50 059 06.50		2.2	10

Size **14 x 51 mm** Rated Voltage **AC 690 V (IEC) · AC 700 V (UL)** Class **gR**

Rated Current [A]	Part No. without Striker	Part No. with Striker	UL Rec.	Weight [kg/100]	Pack
6	50 124 06.6	50 126 06.6	✓	2.2	10
8	50 124 06.8	50 126 06.8	✓	2.2	10
10	50 124 06.10	50 126 06.10	✓	2.2	10
12	50 124 06.12	50 126 06.12	✓	2.2	10
16	50 124 06.16	50 126 06.16	✓	2.2	10
20	50 124 06.20	50 126 06.20	✓	2.2	10
25	50 124 06.25	50 126 06.25	✓	2.2	10
32	50 124 06.32	50 126 06.32	✓	2.2	10
40	50 124 06.40	50 126 06.40	✓	2.2	10
50	50 124 06.50	50 126 06.50	✓	2.2	10

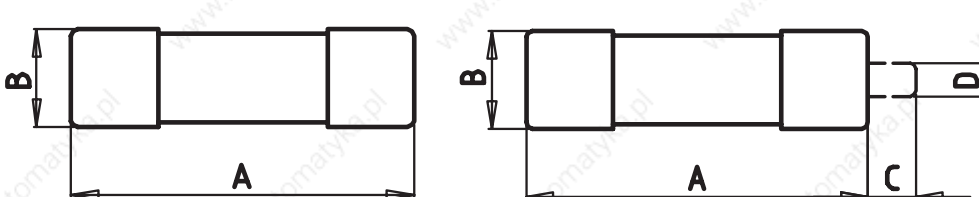

Without Striker
A 2.00" (51 mm)
B 0.55" (14 mm)

With Striker
A 2.00" (51 mm)
B 0.55" (14 mm)
C_{min} 0.28" (7 mm)
D 0.20" (4.9 mm)



Fuses for Semiconductor Protection
Cylindrical Fuses

Size
14 x 51 mm

Rated Voltage
AC 690 / 700 V

Class
gRL(gS)

Rated Current [A]	Part No. without Striker	Part No. with Striker	Part No. Fixing Center 63,5 mm	UL Rec.	Weight [kg/100]	Pack
10	50 124 34.10	50 126 34.10	50 129 34.10	✓	2.2	10
12	50 124 34.12	50 126 34.12	50 129 34.12	✓	2.2	10
16	50 124 34.16	50 126 34.16	50 129 34.16	✓	2.2	10
20	50 124 34.20	50 126 34.20	50 129 34.20	✓	2.2	10
25	50 124 34.25	50 126 34.25	50 129 34.25	✓	2.2	10
30	50 124 34.30	50 126 34.30	50 129 34.30	✓	2.2	10
32	50 124 34.32	50 126 34.32	50 129 34.32	✓	2.2	10
35	50 124 34.35	50 126 34.35	50 129 34.35	✓	2.2	10
40	50 124 34.40	50 126 34.40	50 129 34.40	✓	2.2	10

Without Striker

A 2.00" (51 mm)

B 0.55" (14 mm)

With Striker

A 2.00" (51 mm)

B 0.55" (14 mm)

C_{min} 0.28" (7 mm)

D 0.20" (4.9 mm)

Part No. 50 124 34. ...

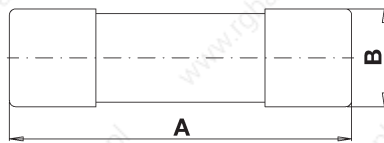

Part No. 50 129 34. ...

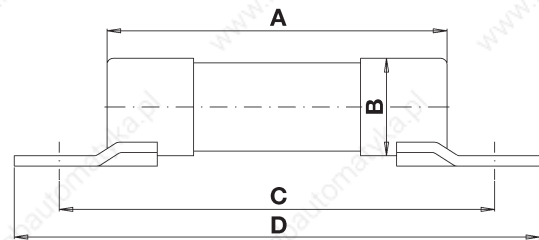

Part No. 50 126 34. ...

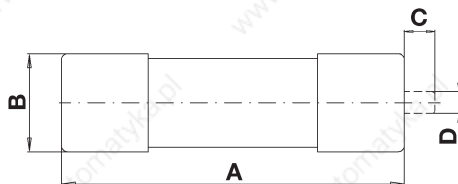

Fixing Center 63,5 mm

A 2.00" (51 mm)

B 0.55" (14 mm)

C 0.00" (63.5 mm)

D 0.00" (77 mm)

E 0.00" (8.7 mm)

F 0.00" (5.5 mm)





Fuses for Semiconductor Protection
Cylindrical Fuses

Size **14 x 51 mm** Rated Voltage **DC 700 V (UL)** Class **aR**

Rated Current [A]	Part No.	UL Rec.	Weight [kg/100]	Pack
10	50 201 06.10	✓	2.2	10
12	50 201 06.12	✓	2.2	10
16	50 201 06.16	✓	2.2	10
20	50 201 06.20	✓	2.2	10
25	50 201 06.25	✓	2.2	10
32	50 201 06.32	✓	2.2	10
40	50 201 06.40	✓	2.2	10
50	50 201 06.50	✓	2.2	10

Size **14 x 51 mm** Rated Voltage **DC 700 V (UL)** Class **aR**

Rated Current [A]	Part No.	UL Rec.	Weight [kg/100]	Pack
6	50 118 06.6	✓	2.2	10
8	50 118 06.8	✓	2.2	10
10	50 118 06.10	✓	2.2	10
12	50 118 06.12	✓	2.2	10
16	50 118 06.16	✓	2.2	10
20	50 118 06.20	✓	2.2	10
25	50 118 06.25	✓	2.2	10
30	50 118 06.30	✓	2.2	10
35	50 118 06.35		2.2	10
40	50 118 06.40		2.2	10
50	50 118 06.50		2.2	10

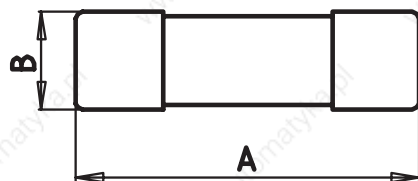

A 2.00" (51 mm)
B 0.55" (14 mm)



Fuses for Semiconductor Protection
Cylindrical Fuses

Size **22 x 58 mm** Rated Voltage **AC 500 V (IEC) · AC 600 V (UL)** Class **aR**

Rated Current [A]	Part No. without Striker	Part No. with Striker	UL Rec.	Weight [kg/100]	Pack
12	50 060 06.12	50 061 06.12		5.5	10
16	50 060 06.16	50 061 06.16		5.5	10
20	50 060 06.20	50 061 06.20		5.5	10
25	50 060 06.25	50 061 06.25		5.5	10
32	50 060 06.32	50 061 06.32		5.5	10
40	50 060 06.40	50 061 06.40		5.5	10
50	50 060 06.50	50 061 06.50		5.5	10
63	50 060 06.63	50 061 06.63		5.5	10
80	50 060 06.80	50 061 06.80		5.5	10
100	50 060 06.100	50 061 06.100		5.5	10

Size **22 x 58 mm** Rated Voltage **AC 690 V (IEC) · AC 700 V (UL)** Class **gR/aR**

Rated Current [A]	Part No. without Striker	Part No. with Striker	UL Rec.	Weight (kg/100)	Pack	Class
12	50 140 06.12	50 142 06.12	✓	5.5	10	gR
16	50 140 06.16	50 142 06.16	✓	5.5	10	gR
20	50 140 06.20	50 142 06.20	✓	5.5	10	gR
25	50 140 06.25	50 142 06.25	✓	5.5	10	gR
32	50 140 06.32	50 142 06.32	✓	5.5	10	gR
40	50 140 06.40	50 142 06.40	✓	5.5	10	gR
50	50 140 06.50	50 142 06.50	✓	5.5	10	gR
63	50 140 06.63	50 142 06.63	✓	5.5	10	gR
80	50 140 06.80	50 142 06.80	✓	5.5	10	gR
100	50 140 06.100	50 142 06.100	✓	5.5	10	gR
125*	50 140 06.125	50 142 06.125		5.5	10	aR
135*	50 140 06.135	50 142 06.135		5.5	10	aR

* AC 600 V

Without Striker

- A** 2.28" (58 mm)
- B** 0.87" (22 mm)

With Striker

- A** 2.28" (58 mm)
- B** 0.87" (22 mm)
- C_{min}** 0.28" (7 mm)
- D** 0.20" (4.9 mm)

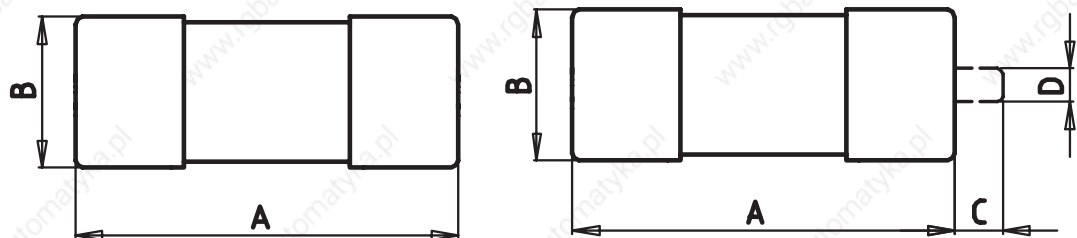



Fuses for Semiconductor Protection
Cylindrical Fuses

Size **22 x 58 mm** Rated Voltage **AC 690 V (IEC) · AC 700 V (UL)** Class **gRL(gS)**

Rated Current [A]	Part No. without Striker	Part No. with Striker	UL Rec.	Weight [kg/100]	Pack
25	50 140 34.25	50 142 34.25	✓	5.5	10
30	50 140 34.30	50 142 34.30	✓	5.5	10
32	50 140 34.32	50 142 34.32	✓	5.5	10
35	50 140 34.35	50 142 34.35	✓	5.5	10
50	50 140 34.50	50 142 34.50	✓	5.5	10
63	50 140 34.63	50 142 34.63	✓	5.5	10
80	50 140 34.80	50 142 34.80	✓	5.5	10
100	50 140 34.100	50 142 34.100	✓	5.5	10

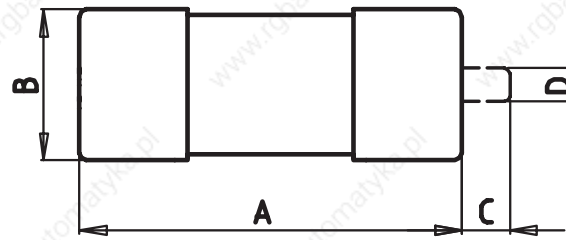
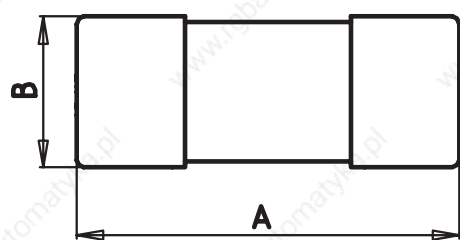

Without Striker	
A	2.28" (58 mm)
B	0.87" (22 mm)
With Striker	
A	2.28" (58 mm)
B	0.87" (22 mm)
C _{min}	0.28" (7 mm)
D	0.20" (4.9 mm)



Fuses for Semiconductor Protection
Cylindrical Fuses

Size
27 x 60 mm

Rated Voltage
AC 660 V

Class
aR

Rated Current [A]	Part No. without Striker	Part No. with Striker	UL Rec.	Weight [kg/100]	Pack
20	50 193 20.20	50 194 20.20		6.0	10
25	50 193 20.25	50 194 20.25		6.0	10
32	50 193 20.32	50 194 20.32		6.0	10
40	50 193 20.40	50 194 20.40		6.0	10
50	50 193 20.50	50 194 20.50		6.0	10
63	50 193 20.63	50 194 20.63		6.0	10
100	50 193 20.100	50 194 20.100		6.0	10
125	50 193 20.125	50 194 20.125		6.0	10
200	50 193 20.200	50 194 20.200		6.0	10
250	50 193 20.250	50 194 20.250		6.0	10

Size
27 x 60 mm

Rated Voltage
AC 1000 V

Class
aR

Rated Current [A]	Part No. without Striker	Part No. with Striker	UL Rec.	Weight [kg/100]	Pack
32	50 196 20.32	50 197 20.32		6.0	10
40	50 196 20.40	50 197 20.40		6.0	10
50	50 196 20.50	50 197 20.50		6.0	10
63	50 196 20.63	50 197 20.63		6.0	10
80	50 196 20.80	50 197 20.80		6.0	10
100	50 196 20.100	50 197 20.100		6.0	10
125	50 196 20.125	50 197 20.125		6.0	10
160	50 196 20.160	50 197 20.160		6.0	10
170	50 196 20.170	50 197 20.170		6.0	10

Without Striker

- A** 2.36" (60 mm)
- B** 1.06" (27 mm)

With Striker

- A** 2.36" (60 mm)
- B** 1.06" (27 mm)
- C_{min}** 0.28" (7 mm)
- D** 0.20" (4.9 mm)

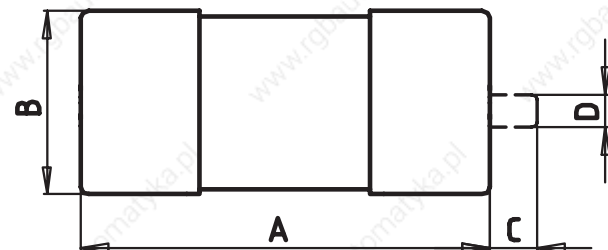
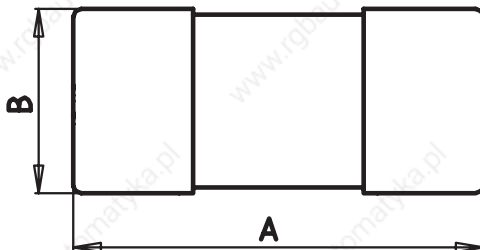



Fuses for Semiconductor Protection
Cylindrical Fuses

Size **27 x 60 mm** Rated Voltage **DC 660 V** Class **gR**

Rated Current [A]	Part No.	UL Rec.	Weight [kg/100]	Pack
8	50 190 06.8		6.0	10
10	50 190 06.10		6.0	10
12	50 190 06.12		6.0	10
16	50 190 06.16		6.0	10
20	50 190 06.20		6.0	10
25	50 190 06.25		6.0	10
32	50 190 06.32		6.0	10
40	50 190 06.40		6.0	10
50	50 190 06.50		6.0	10
63	50 190 06.63		6.0	10
80	50 190 06.80		6.0	10
100	50 190 06.100		6.0	10
110	50 190 06.110		6.0	10

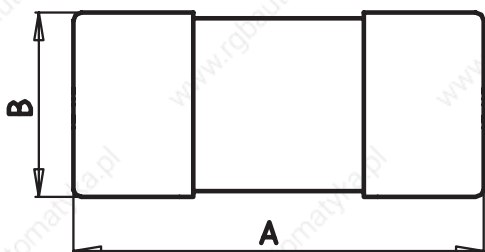

Without Striker
A 2.36" (60 mm)
B 1.06" (27 mm)

Size
5 x 20 mm

Rated Voltage
AC 250 V

Ceramic Tube

Class
FF

Rated Current [A]	Part No.	Max. Voltage Drop [mV]	Power Loss [W]	Pre-arcing I ² t-value [A ² s]	Total I ² t-value [A ² s]	Rated Breaking Capacity
100 mA	70 001 40.0.100	4 000	0.4	0.0016	0.0023	
125 mA	70 001 40.0.125	3 500	0.5	0.0024	0.0034	
160 mA	70 001 40.0.160	1 300	0.3	0.004	0.0056	
200 mA	70 001 40.0.200	1 100	0.3	0.008	0.011	
250 mA	70 001 40.0.250	1 000	0.3	0.019	0.027	
315 mA	70 001 40.0.315	900	0.3	0.03	0.042	
400 mA	70 001 40.0.400	850	0.4	0.065	0.09	
500 mA	70 001 40.0.500	800	0.4	0.12	0.17	
630 mA	70 001 40.0.630	700	0.5	0.17	0.24	
800 mA	70 001 40.0.800	600	0.5	0.26	0.36	
1	70 001 40.1	750	0.8	0.17	0.26	300 kA at AC 250 V cos phi < 0.2
1.25	70 001 40.1.25	750	1.0	0.26	0.39	
1.6	70 001 40.1.6	700	1.2	0.31	0.51	
2	70 001 40.2	650	1.3	0.64	1	
2.5	70 001 40.2.5	600	1.5	0.88	1.5	
3.15	70 001 40.3.15	550	1.8	1.6	2.7	
4	70 001 40.4	500	2.0	3.2	5.4	
5	70 001 40.5	500	2.4	5.9	10	
6.3	70 007 40.6.3	250	2.8	1.6	4.8	
8	70 007 40.8	250	3.0	4.5	14	
10	70 007 40.10	200	3.4	8.8	26	
12.5	70 007 40.12.5	200	4.0	15	44	
6.3	70 001 40.6.3	450	2.8	10	17	1500 kA at AC 250 V
8	70 001 40.8	400	3.2	19	32	
10	70 001 40.10	400	4.0	30	54	

Pre-Arcing Time Limits

Part No. 70 001 40

Rated Current	1.0 I _{rat}	2.0 I _{rat}	2.75 I _{rat}	4 I _{rat}	10 I _{rat}
100 mA ▼ 800 mA	> 1 h	-	-	< 60 ms	< 6 ms
1 A ▼ 10 A		< 1 s	4 ms ▼ 100 ms	1 ms ▼ 25 ms	< 3 ms

Part No. 70 007 40

Rated Current	1.2 I _{rat}	1.5 I _{rat}	2.75 I _{rat}	4 I _{rat}	10 I _{rat}
6.3 A ▼ 12.5 A	> 1 h	< 30 min	4 ms ▼ 300 ms	1 ms ▼ 30 ms	< 1 ms

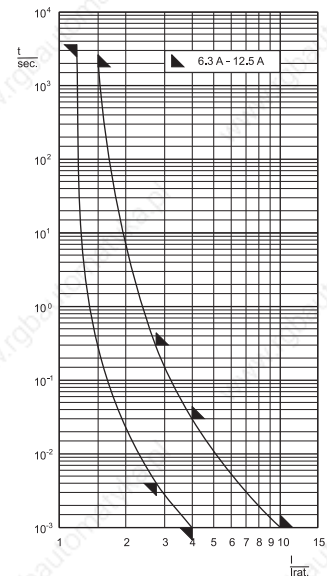
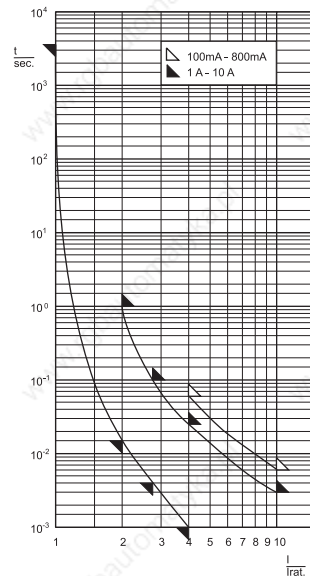

Size 6.35 x 32 mm	Rated Voltage AC 400 V	Operating Class gRL (gS)	Rated Breaking Capacity 120 kA
-----------------------------	----------------------------------	------------------------------------	--

Rated Current [A]	Part No.	Max. Voltage Drop [mV]	Power Loss [W]	Pre-arcing I ² t-value [A ² s]	Total I ² t-value [A ² s]
6.3	70 065 84.6.3	190	1.2	1.8	11
8	70 065 84.8	190	1.5	3.0	18
10	70 065 84.10	180	1.8	5.1	31
12.5	70 065 84.12.5	150	1.9	12	69
16	70 065 84.16	150	2.3	20	120
20	70 065 84.20	160	3.2	35	210

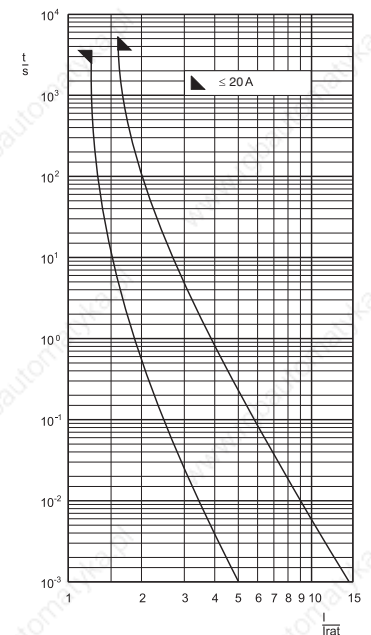

Size
6.35 x 32 mm

Rated Voltage
AC 500/700 V

Ceramic Tube

Class
FF

Rated Current [A]	Part No.	Max. Voltage Drop [mV]	Pre-arcing I ² t _s -value [A ² s]	Total I ² t _s -value [A ² s]	Rated Breaking Capacity	Rated Voltage
160 mA	70 125 40.0.160	2 000	0.004	0.014		
200 mA	70 125 40.0.200	1 600	0.008	0.03		
250 mA	70 125 40.0.250	1 500	0.024	0.08		
315 mA	70 125 40.0.315	1 350	0.035	0.12		
400 mA	70 125 40.0.400	1 030	0.07	0.24		
500 mA	70 125 40.0.500	950	0.14	0.48	50 kA at AC 700 V cos phi < 0.2	AC 700 V
630 mA	70 125 40.0.630	860	0.14	0.5		
800 mA	70 125 40.0.800	760	0.22	0.8		
1	70 125 40.1	1 100	0.14	0.5		
1.25	70 125 40.1.25	1 000	0.22	0.8		
1.6	70 125 40.1.6	900	0.31	1.1		
2	70 125 40.2	800	0.64	2.2		
2.5	70 125 40.2.5	800	1.2	3		
3.15	70 125 40.3.15	700	2	5		
4	70 125 40.4	500	5	13		
5	70 125 40.5	400	10	25	50 kA at AC 500 V cos phi < 0.2	AC 500 V
6.3	70 125 40.6.3	400	3	14		
8	70 125 40.8	350	6.5	30		
10	70 125 40.10	350	12	55		
12.5	70 125 40.12.5	300	18	80		
16	70 125 40.16	300	31	140		
20	70 125 40.20	300	46	200		

Pre-Arcing Time Limits

Rated Current	1.0 I _{rat}	2.0 I _{rat}	2.75 I _{rat}	4 I _{rat}	10 I _{rat}
160 mA ▼ 800 mA	> 1 h	-	-	< 60 ms	< 6 ms
1 A ▼ 5 A		-	4 ms ▼ 100 ms	1 ms ▼ 25 ms	< 5 ms

Rated Current	1.2 I _{rat}	1.5 I _{rat}	2.75 I _{rat}	4 I _{rat}	10 I _{rat}
6.3 A ▼ 20 A	> 1 h	< 30 min	4 ms ▼ 300 ms	1 ms ▼ 30 ms	< 2 ms

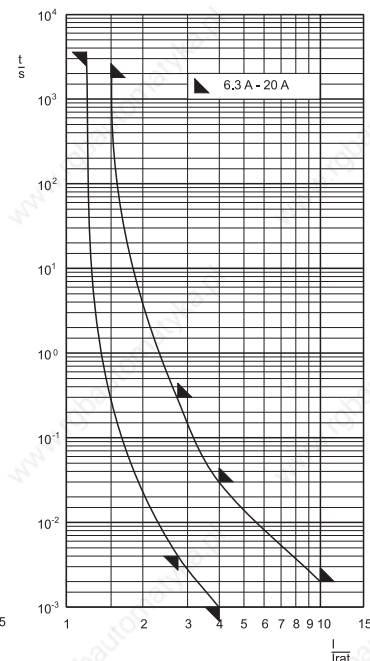
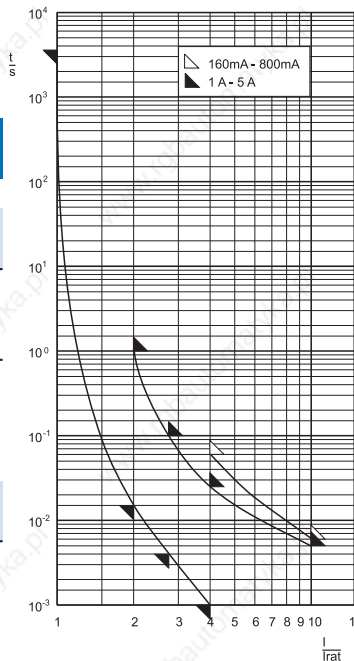

Size 6.35 x 32 mm	Rated Voltage AC/DC 1000 V	DMI
-----------------------------	--------------------------------------	------------

Rated Current [A]	Part No.	Power Loss [W]	Pre-arcing I ² t-value [A ² s]	Total I ² t-value @ 600 V [A ² s]	Rated Breaking Capacity
315 mA	70 172 40.0.315	0.3	0.035	0.35	50 kA at AC 1000 V cos phi < 0.19 50 kA at DC 1000 V L/R = 1 ms
500 mA	70 172 40.0.500	0.4	0.15	1.5	
1.6	70 172 40.1.6	1.1	0.31	3	30 kA at DC 1000 V
2	70 172 40.2	1.4	0.64	6	

Pre-Arcing Time Limits

Rated Current	1.0 I _{rat}	2.0 I _{rat}	2.75 I _{rat}	4 I _{rat}	10 I _{rat}
315 mA	> 1 h	-	-	< 60 ms	< 6 ms
500 mA		-	-	< 60 ms	< 6 ms
1.6 A		-	-	1 ms	< 5 ms
2 A		-	-	25 ms	< 5 ms

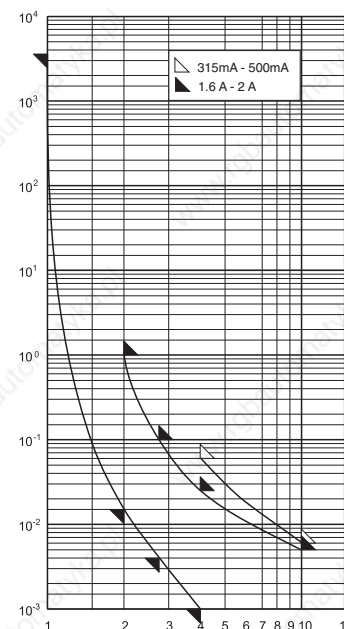

Size
10 x 38 mm

Rated Voltage
AC 600 V

Class
gRL(gS)

Rated Breaking Capacity
200 kA

Rated Current [A]	Part No.	Part No. PCB Mounting	Power Loss [W]	Pre-arcing I ² t-value [A ² s]	Total I ² t-value @ 500 V [A ² s]
6	60 034 34.6	60 064 34.6	1	2.5	20
8	60 034 34.8	60 064 34.8	1.3	3.3	36
10	60 034 34.10	60 064 34.10	1.1	5.1	41
12	60 034 34.12	60 064 34.12	1.9	8.7	69
16	60 034 34.16	60 064 34.16	2.4	17	130
20	60 034 34.20	60 064 34.20	3.5	29	240
25	60 034 34.25	60 064 34.25	3.8	66	530
30	60 034 34.30	60 064 34.30	4.3	120	950

Cut-Off Characteristics

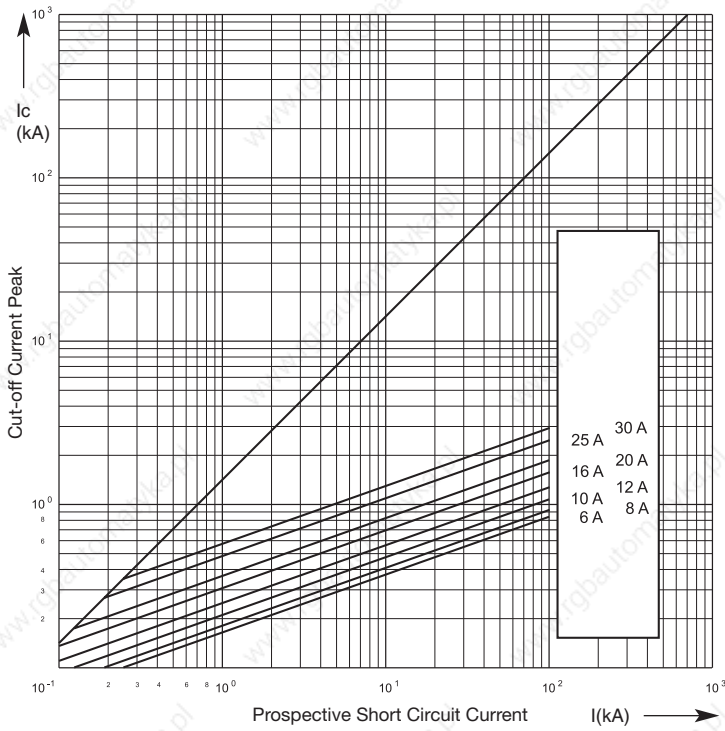

Time-Current Characteristics

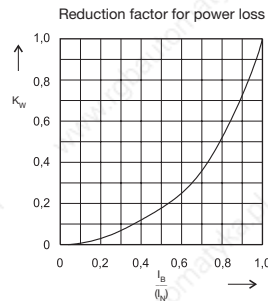
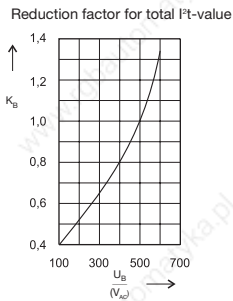
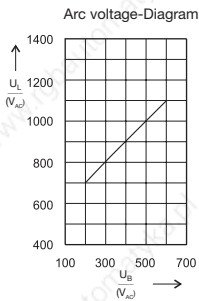
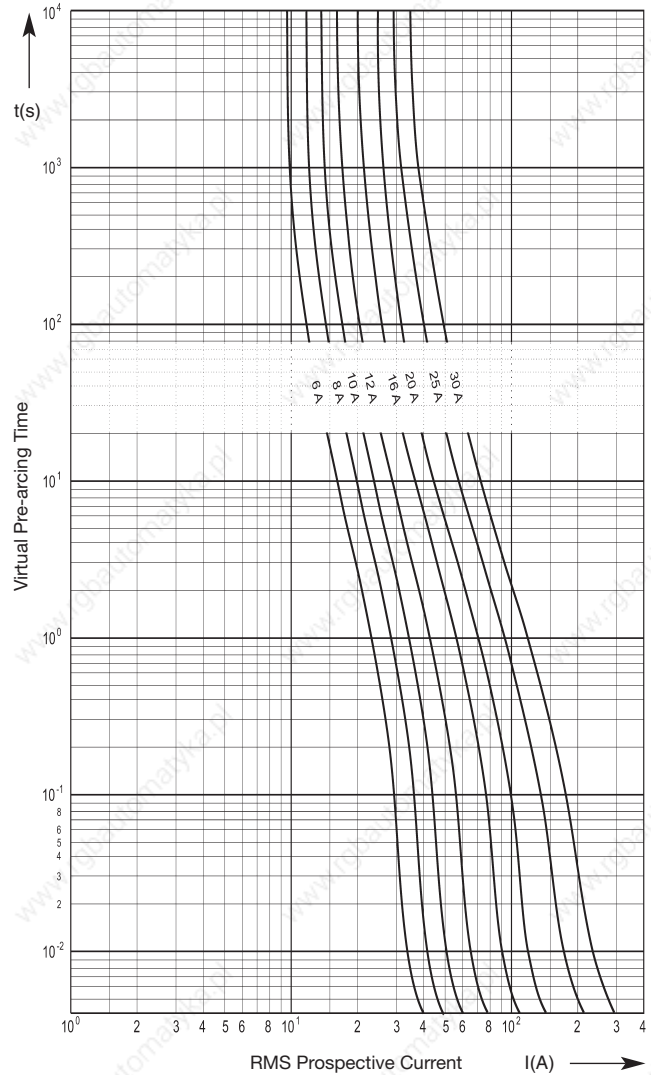

Size 10 x 38 mm	Rated Voltage AC 600 V	Class aR	Rated Breaking Capacity 300 kA
---------------------------	----------------------------------	--------------------	--

Rated Current [A]	Part No.	Power Loss [W]	Pre-arcing I ² t-value [A ² s]	Total I ² t-value @ 600 V [A ² s]
1	60 033 05.1	1	0.1	0.9
2	60 033 05.2	1.8	0.64	5.8
4	60 033 05.4	1.1	1.1	6
5	60 033 05.5	1.4	1.3	12
6	60 033 05.6	1.6	2.0	18
8	60 033 05.8	1.8	3	28
10	60 033 05.10	2.1	5.1	48
12	60 033 05.12	2.5	7.4	63
16	60 033 05.16	3	13	120
20	60 033 05.20	3.6	29	200
25	60 033 05.25	4.5	52	420
30	60 033 05.30	5.8	81	730

Cut-Off Characteristics

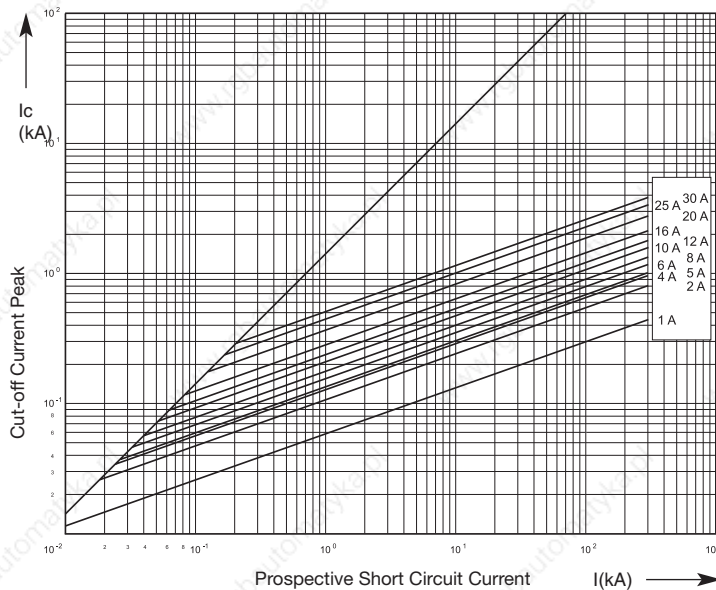

Time-Current Characteristics

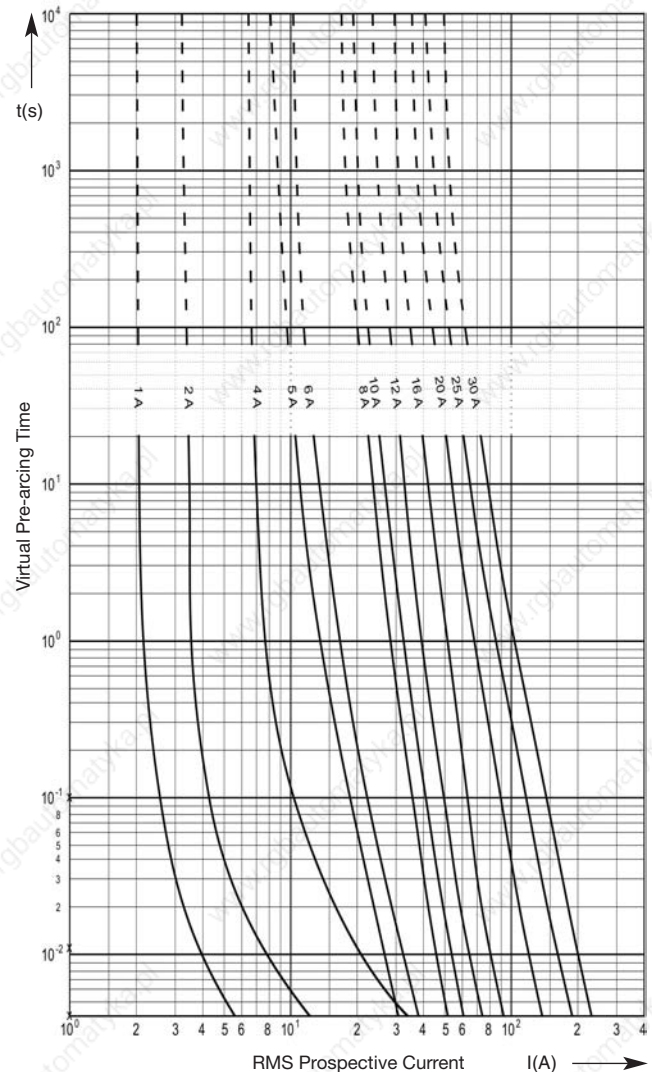

Arc voltage-Diagram

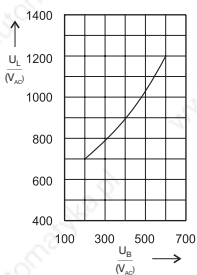

Reduction factor for total I²t-value

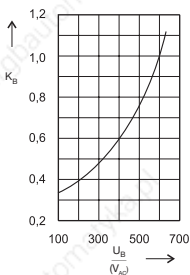

Reduction factor for power loss

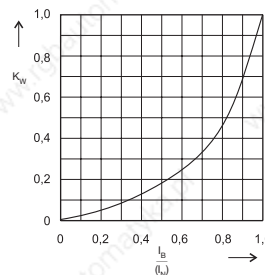

Size **10 x 38 mm** Rated Voltage **AC 660 V (IEC) · AC 700 V (UL)** Class **gR** Rated Breaking Capacity **200 kA**

Rated Current [A]	Part No.	Power Loss [W]	Pre-arcing I ² t-value [A ² s]	Total I ² t-value @ 660 V [A ² s]
1	50 179 06.1	1.0	0.93	1.6
2	50 179 06.2	1.8	0.64	8
4	50 179 06.4	1.1	0.8	10
5	50 179 06.5	1.5	2.0	25
6	50 179 06.6	1.8	3.0	38
8	50 179 06.8	1.8	3.1	39
10	50 179 06.10	2.3	5.1	64
12	50 179 06.12	2.8	7.4	93
16	50 179 06.16	3.7	13.1	164
20	50 179 06.20	4.7	29	360
25	50 179 06.25	5.4	52	650
30	50 179 06.30	6.4	81	1 010

Cut-Off Characteristics

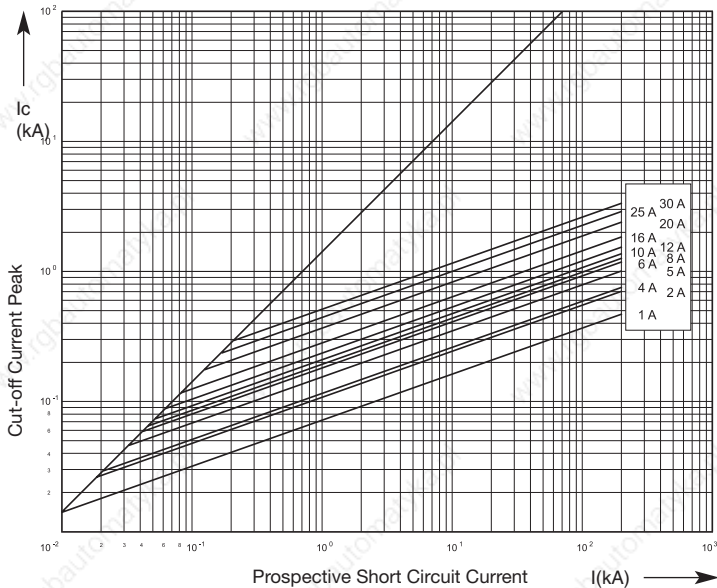

Time-Current Characteristics

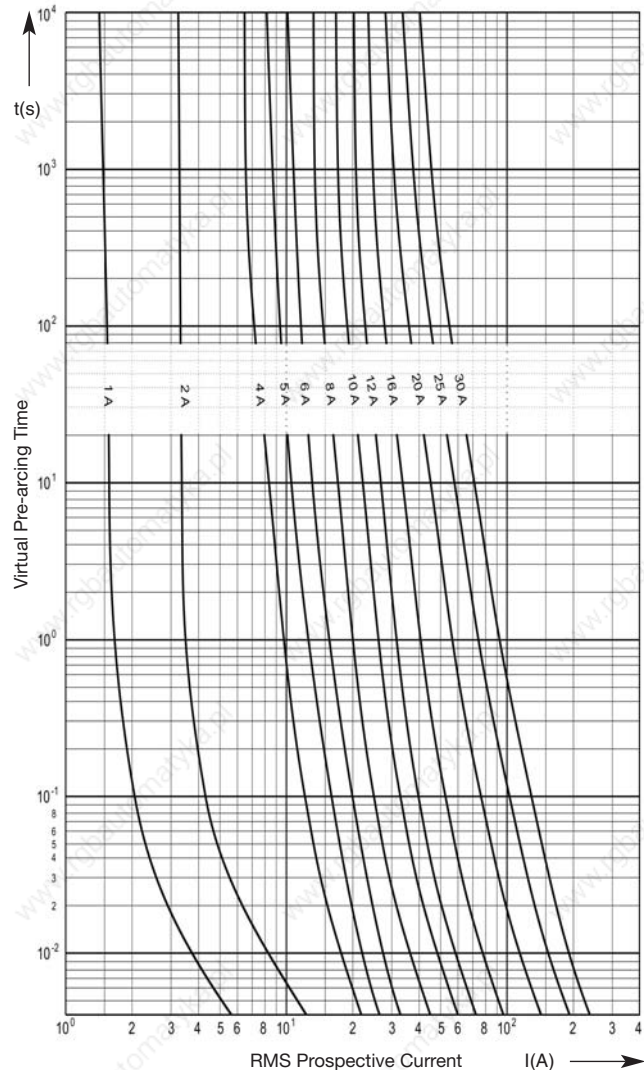

Size **10 x 38 mm** Rated Voltage **AC/DC 1000 V** **DMI** Rated Breaking Capacity **30 kA (cos phi 0.5 / L/R = 1 ms)**

Rated Current [A]	Part No.	Power Loss [W]	Pre-arcing I ² t-value [A ² s]	Total I ² t-value @ AC 1000 V [A ² s]	Total I ² t-value @ DC 1000 V [A ² s]
4	50 199 06.4	0.5	3	35	18
6	50 199 06.6	0.7	5	55	28
8	50 199 06.8	1.1	7	79	40
10	50 199 06.10	1.5	10	106	53
12	50 199 06.12	1.6	17	180	90
16	50 199 06.16	2.1	30	320	160

Cut-Off Characteristics

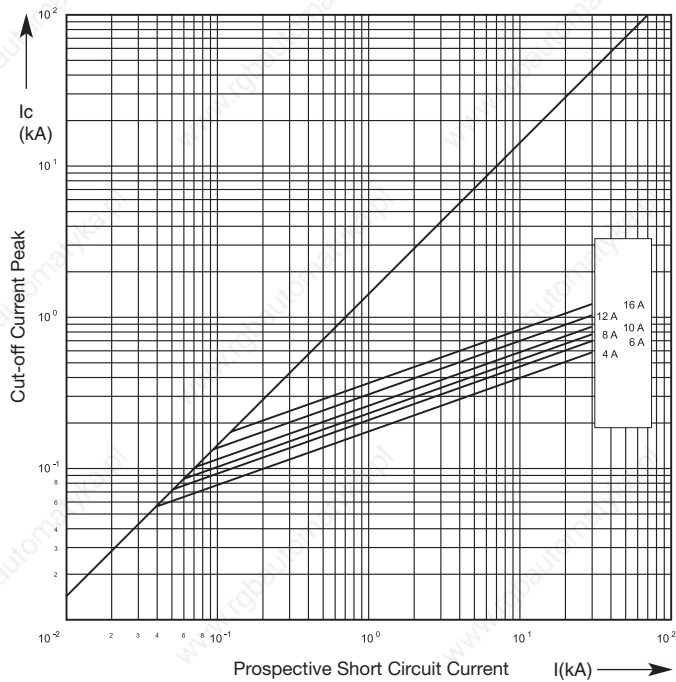

Time-Current Characteristics

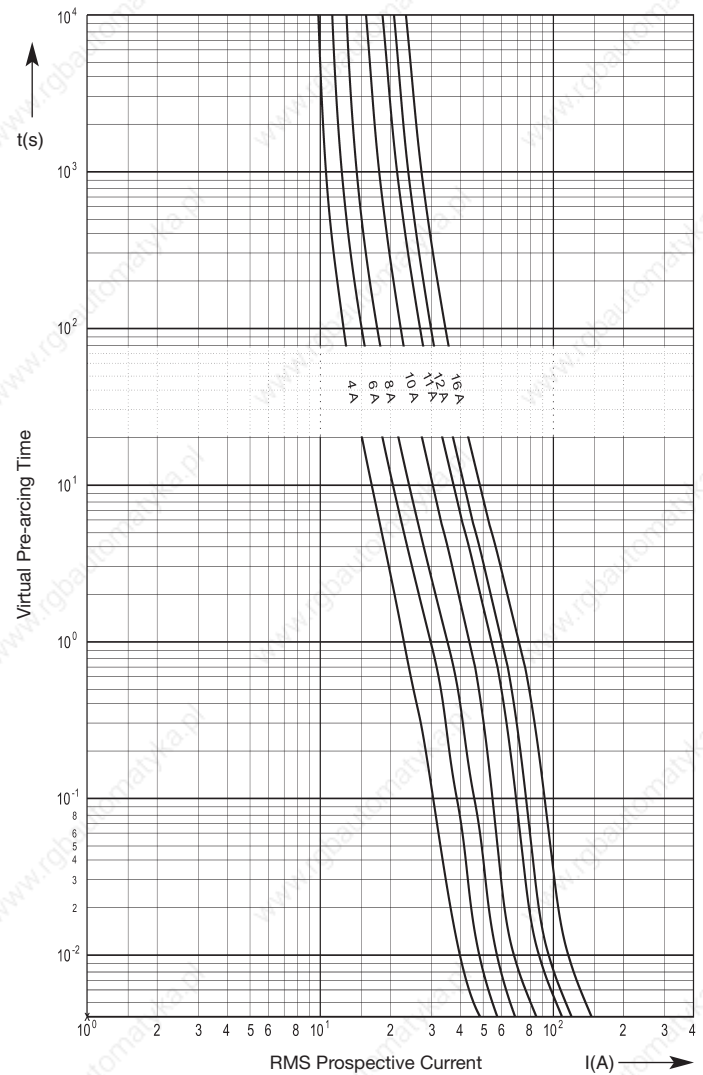

Size
10 x 35 mm

Rated Voltage
AC/DC 1000 V DMI

Rated Breaking Capacity
30 kA (cos phi 0.5 / L/R = 1 ms)

Rated Current [A]	Part No.	Power Loss [W]	Pre-arcing I ² t-value [A ² s]	Total I ² t-value @ AC 1000 V [A ² s]	Total I ² t-value @ DC 1000 V [A ² s]
0.2	50 210 06.0.2	0.12	0.02	0.15	0.12
0.25	50 210 06.0.25	0.13	0.04	0.28	0.2
0.315	50 210 06.0.315	0.16	0.07	0.5	0.4
0.4	50 210 06.0.4	0.2	0.11	0.8	0.7
0.44	50 210 06.0.44	0.2	0.17	1.2	1

Cut-Off Characteristics

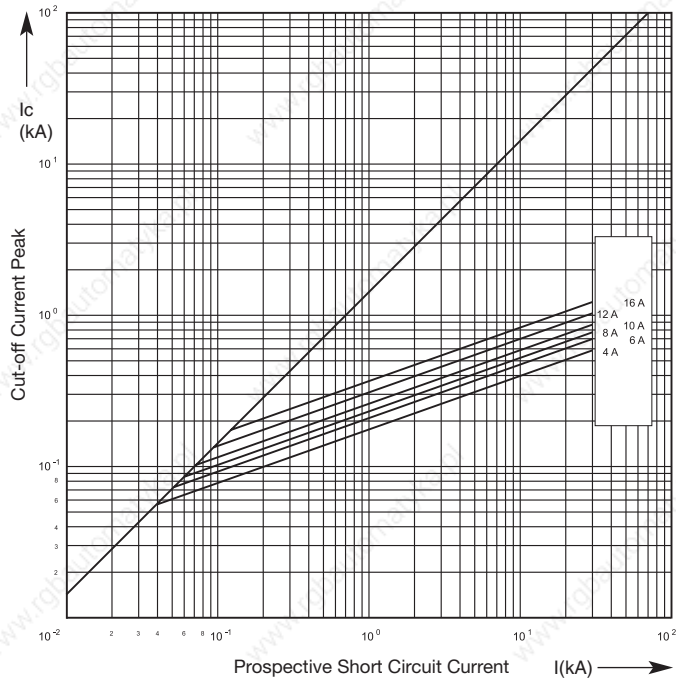

Time-Current Characteristics

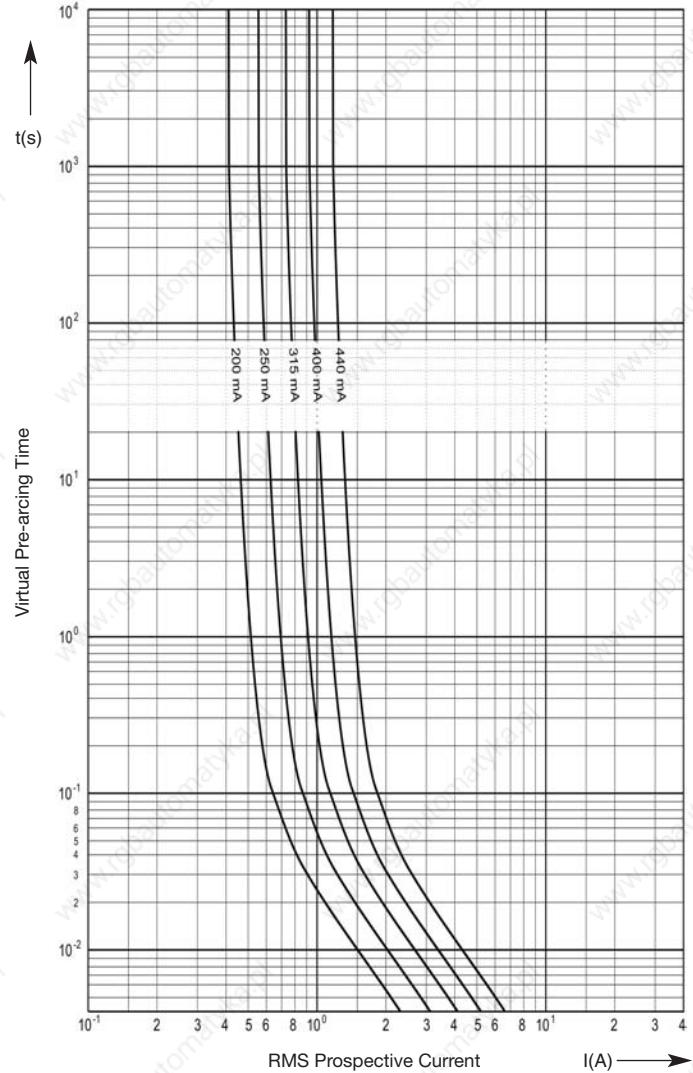

Size 14 x 51 mm	Rated Voltage AC 600 V	Class aR	Rated Breaking Capacity 100 kA
---------------------------	----------------------------------	--------------------	--

Rated Current [A]	Part No. without Striker	Part No. with Striker	Power Loss [W]	Pre-arcing I ² t-value [A ² s]	Total I ² t-value @ 500 V [A ² s]
6	50 058 06.6	50 059 06.6	1.3	3	18
8	50 058 06.8	50 059 06.8	1.7	5	27
10	50 058 06.10	50 059 06.10	2.4	8	48
12	50 058 06.12	50 059 06.12	2.5	12	93
16	50 058 06.16	50 059 06.16	4.0	21	150
20	50 058 06.20	50 059 06.20	4.6	32	250
25	50 058 06.25	50 059 06.25	6.4	63	400
32	50 058 06.32	50 059 06.32	8.2	104	680
40	50 058 06.40	50 059 06.40	9.1	140	1 200
50	50 058 06.50	50 059 06.50	12.0	230	1 600

Cut-Off Characteristics

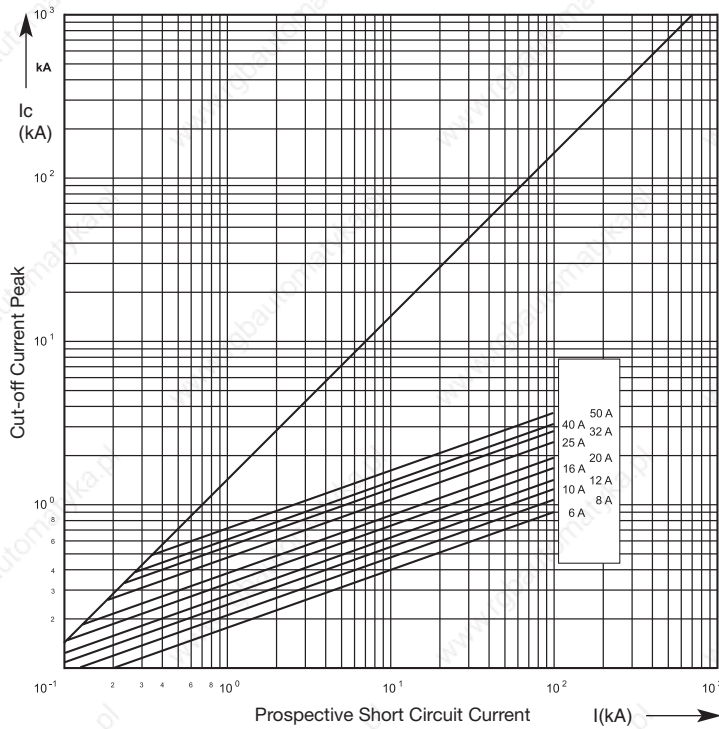

Time-Current Characteristics

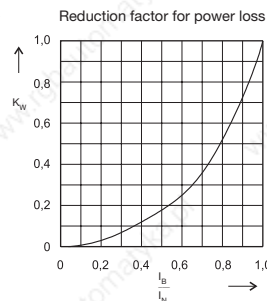
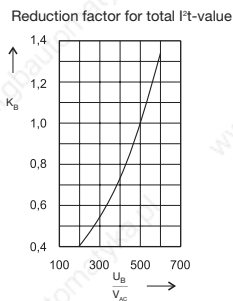
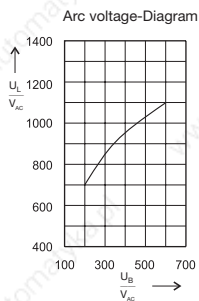
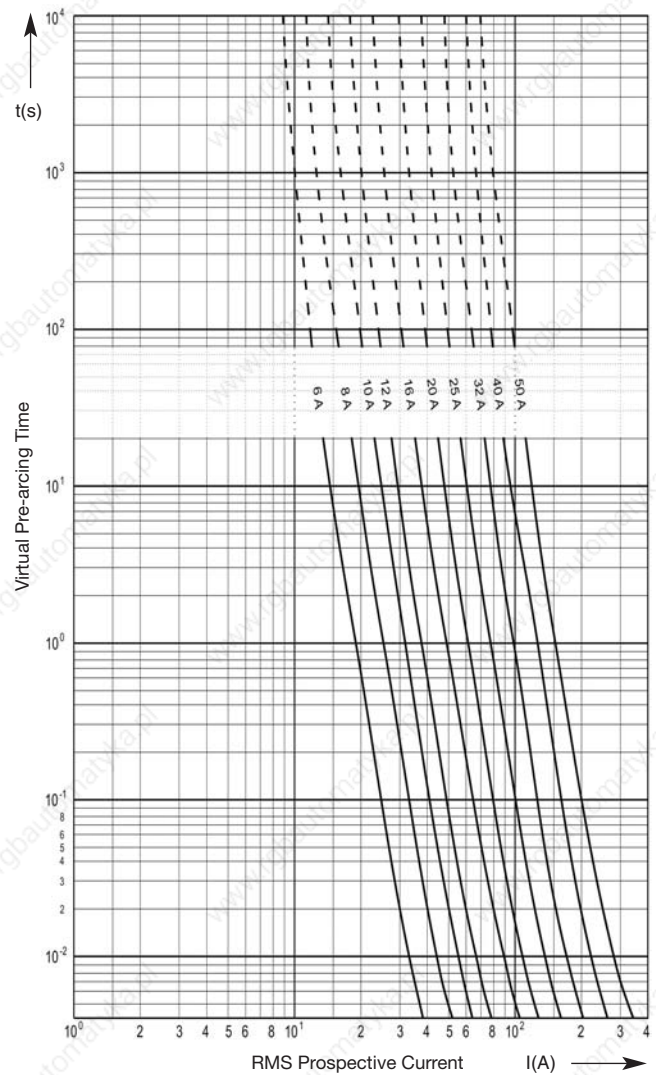

Size
14 x 51 mm

Rated Voltage
AC 690 V

Operating Class
gRL (gS)

Rated Breaking Capacity
200 kA

Rated Current [A]	Part No. without Striker	Part No. with Striker	Part No. Fixing Center 63,5 mm	Power Loss [W]	Pre-arcing I ² t-value [A ² s]	Total I ² t-value @ 690 V [A ² s]
10	50 124 34.10	50 126 34.10	50 129 34.10	1.9	8	60
12	50 124 34.12	50 126 34.12	50 129 34.12	2.3	12	90
16	50 124 34.16	50 126 34.16	50 129 34.16	2.8	25	190
20	50 124 34.20	50 126 34.20	50 129 34.20	3.0	46	340
25	50 124 34.25	50 126 34.25	50 129 34.15	3.2	100	740
30	50 124 34.30	50 126 34.30	50 129 34.30	3.8	190	1 400
32	50 124 34.32	50 126 34.32	50 129 34.32	4.0	250	1 900
35	50 124 34.35	50 126 34.35	50 129 34.35	4.2	370	2 800
40	50 124 34.40	50 126 34.40	50 129 34.40	4.4	420	3 100

Cut-Off Characteristics

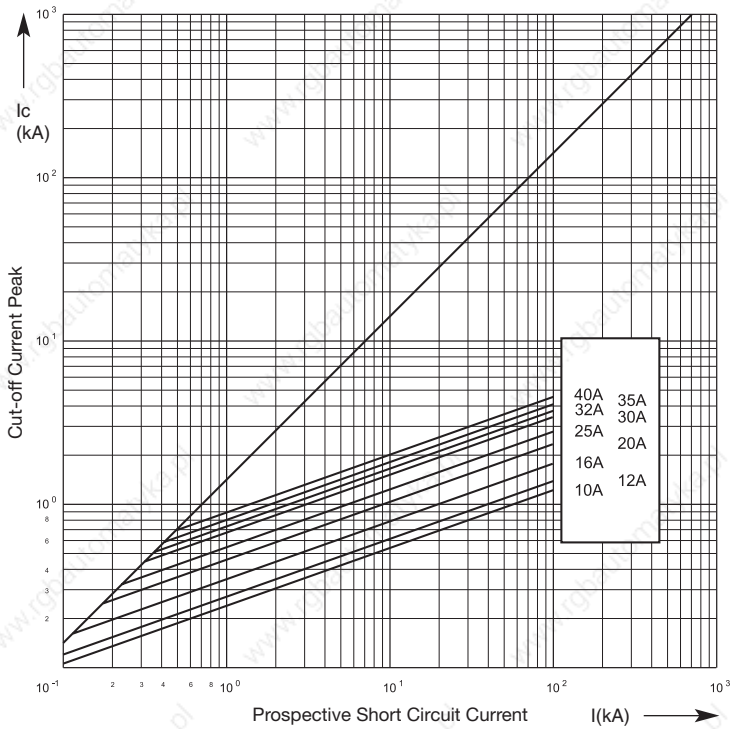

Time-Current Characteristics

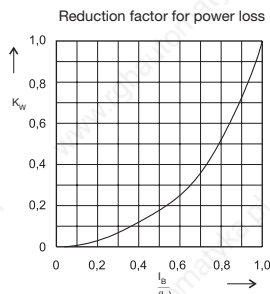
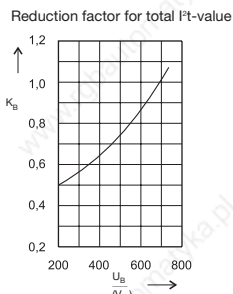
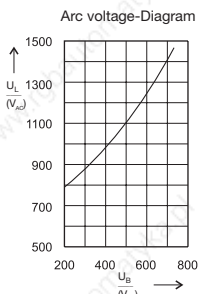
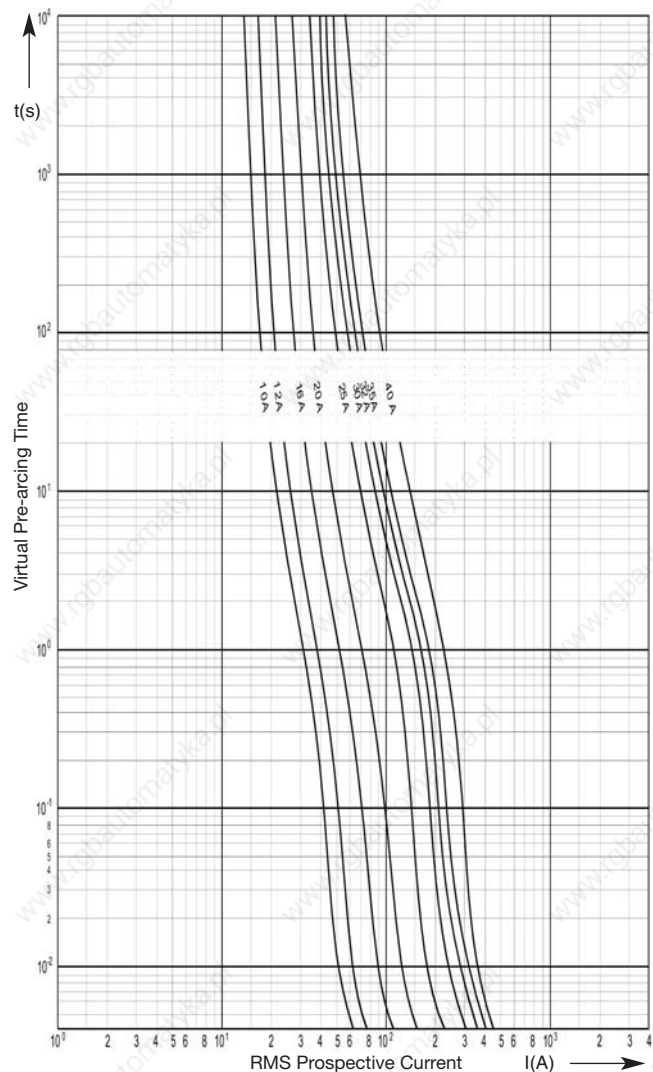

Size 14 x 51 mm	Rated Voltage AC 690 V (IEC) · AC 700 V (UL)	Class gR	Rated Breaking Capacity 200 kA
---------------------------	--	--------------------	--

Rated Current [A]	Part No. without Striker	Part No. with Striker	Power Loss [W]	Pre-arcing I ² t-value [A ² s]	Total I ² t-value @ 660 V [A ² s]
6	50 124 06.6	50 126 06.6	1.3	2.9	18
8	50 124 06.8	50 126 06.8	1.7	5.1	28
10	50 124 06.10	50 126 06.10	2.6	7.7	39
12	50 124 06.12	50 126 06.12	3.1	8.1	75
16	50 124 06.16	50 126 06.16	4.7	11	115
20	50 124 06.20	50 126 06.20	6.0	21	190
25	50 124 06.25	50 126 06.25	7.6	32	340
32	50 124 06.32	50 126 06.32	9.5	63	620
40	50 124 06.40	50 126 06.40	10.0	140	1 050
50	50 124 06.50	50 126 06.50	12.0	250	1 900

Cut-Off Characteristics

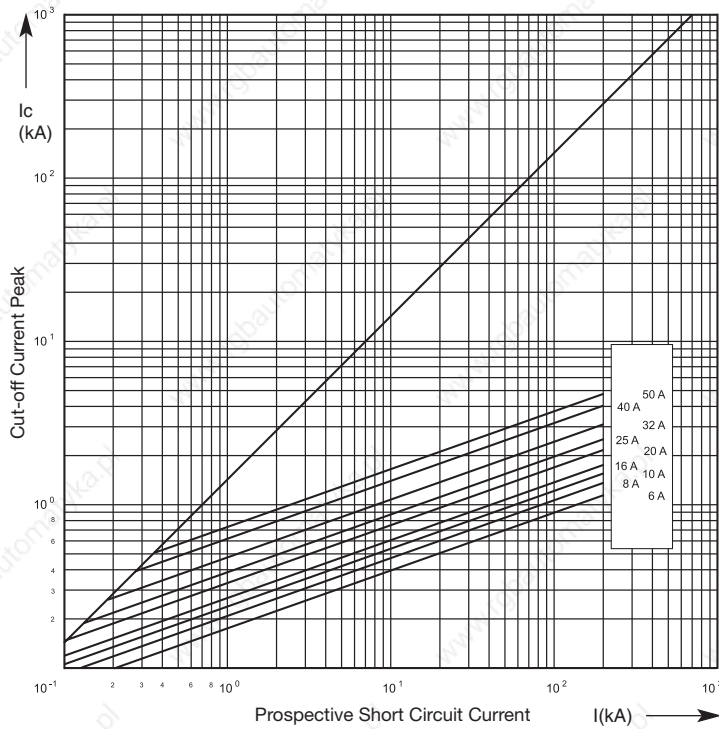

Time-Current Characteristics

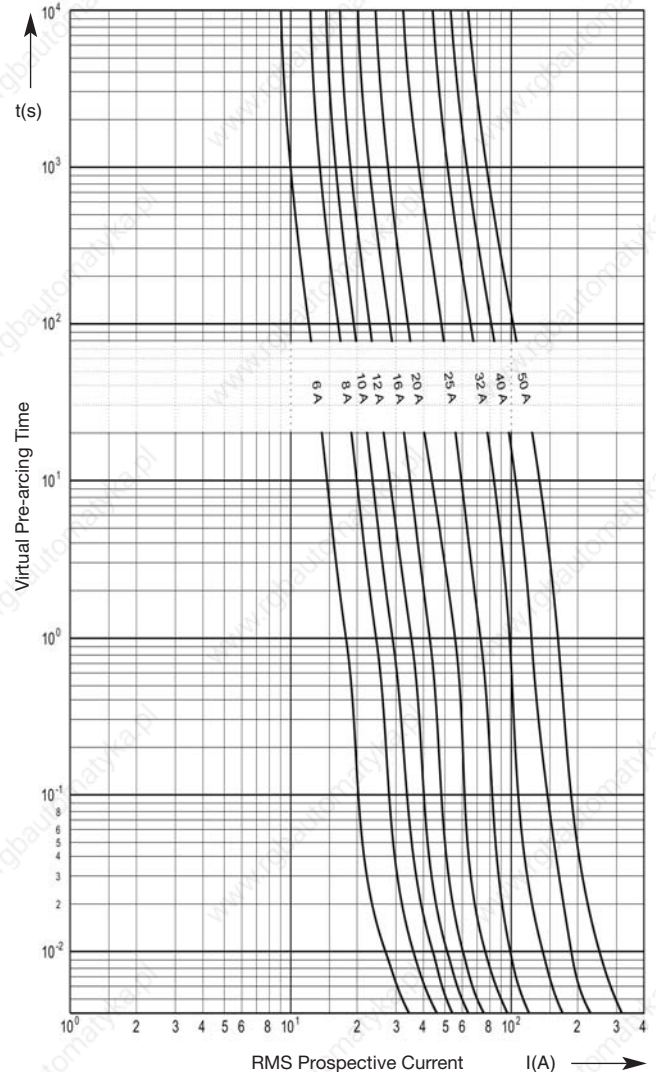

Arc voltage-Diagram

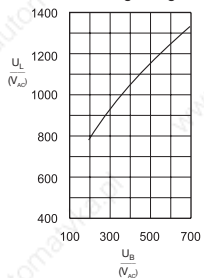

Reduction factor for total I²t-value

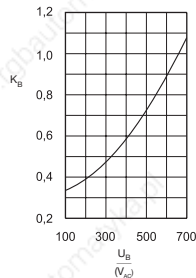

Reduction factor for power loss

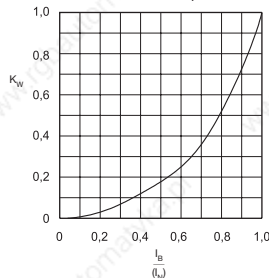

Size
14 x 51 mm

Rated Voltage
DC 700 V

Class
aR

Rated Breaking Capacity
50 kA

Rated Current [A]	Part No.	Power Loss [W]	Pre-arcing I ² t-value [A ² s]	Total I ² t-value @ 700 V [A ² s (L/R = 1 ms)]
6	50 118 06.6	1.3	2.0	12
8	50 118 06.8	1.7	2.9	17
10	50 118 06.10	2.6	3.9	25
12	50 118 06.12	3.1	6.5	41
16	50 118 06.16	4.7	8.0	52
20	50 118 06.20	6.0	12	70
25	50 118 06.25	7.6	20	130
30	50 118 06.30	9.8	32	190
35	50 118 06.35	10.3	72	430
40	50 118 06.40	11.2	103	620
50	50 118 06.50	12.6	128	770

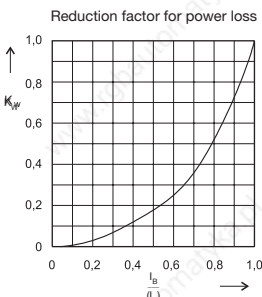
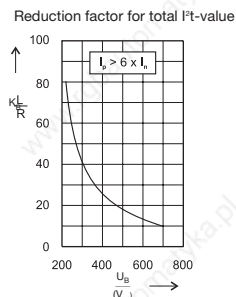
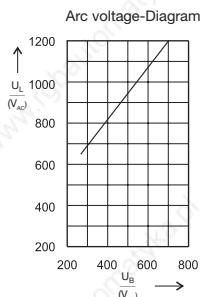
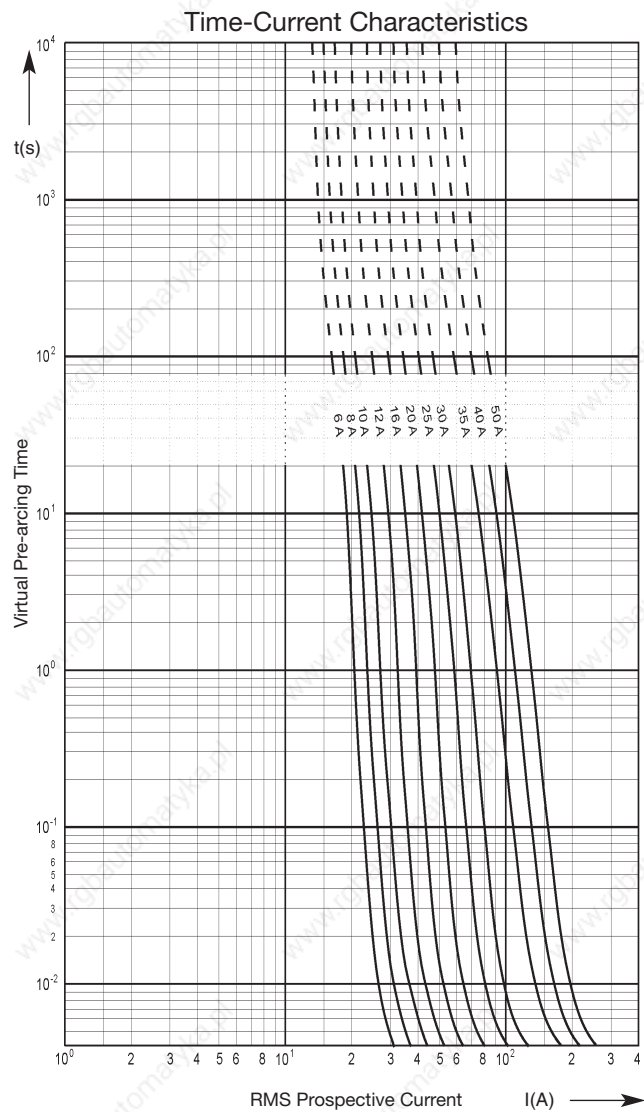

Size 14 x 51 mm	Rated Voltage DC 700 V	Class aR	Rated Breaking Capacity 30 kA
---------------------------	----------------------------------	--------------------	---

Rated Current [A]	Part No.	Power Loss [W]	Pre-arcing I ² t-value [A ² s]	Total I ² t-value @ 700 V [A ² s (L/R = 1 ms)]
10	50 201 06.10	1.1	12	67
12	50 201 06.12	1.2	20	120
16	50 201 06.16	2.0	32	190
20	50 201 06.20	2.3	63	360
25	50 201 06.25	3.1	82	480
32	50 201 06.32	4.1	130	740
40	50 201 06.40	4.6	250	1 460
50	50 201 06.50	7.0	330	1 900

Time-Current Characteristics

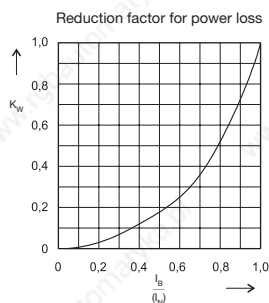
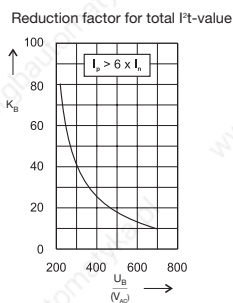
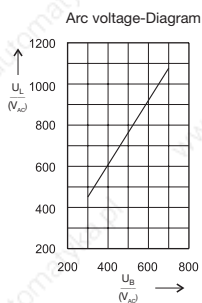
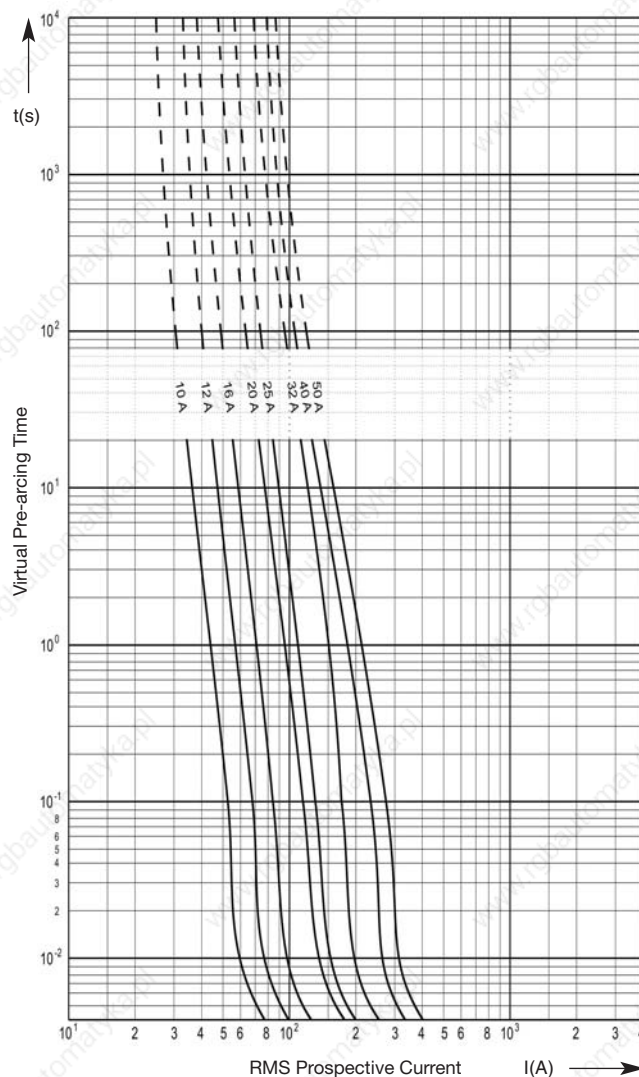

Size
22 x 58 mm

Rated Voltage
AC 600 V

Class
aR

Rated Breaking Capacity
100 kA

Rated Current [A]	Part No. without Striker	Part No. with Striker	Power Loss [W]	Pre-arcing I ² t-value [A ² s]	Total I ² t-value @ 500 V [A ² s]
12	50 060 06.12	50 061 06.12	2.1	16	93
16	50 060 06.16	50 061 06.16	3.6	21	170
20	50 060 06.20	50 061 06.20	4.6	32	250
25	50 060 06.25	50 061 06.25	5.3	63	400
32	50 060 06.32	50 061 06.32	8.2	104	730
40	50 060 06.40	50 061 06.40	8.6	140	1 000
50	50 060 06.50	50 061 06.50	11	230	1 800
63	50 060 06.63	50 061 06.63	15	350	2 600
80	50 060 06.80	50 061 06.80	18	740	5 000
100	50 060 06.100	50 061 06.100	20	1 400	10 000

Cut-Off Characteristics

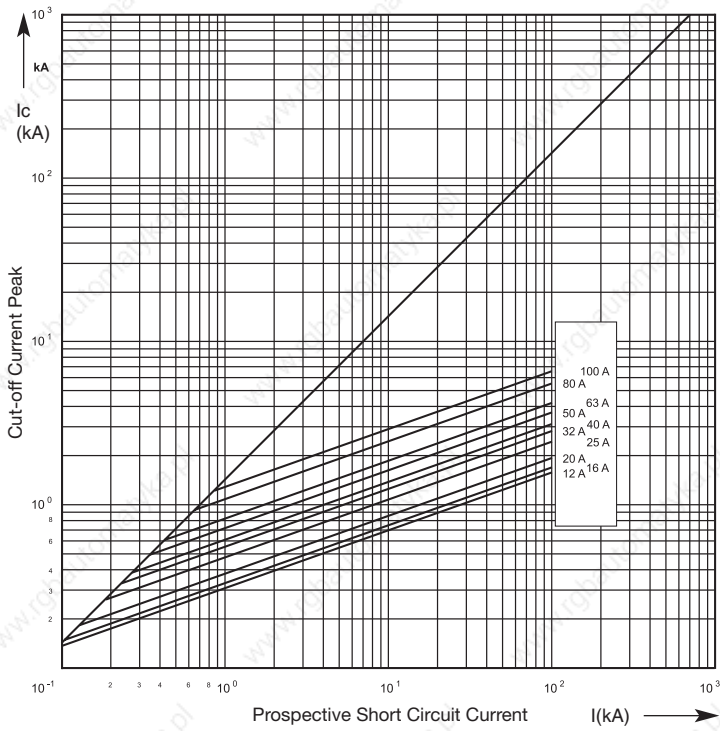

Time-Current Characteristics

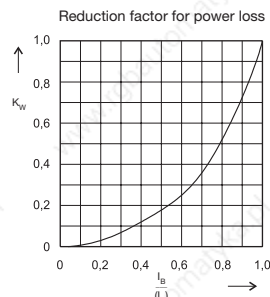
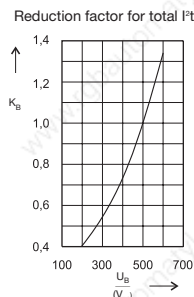
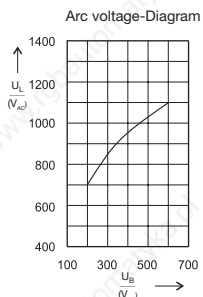
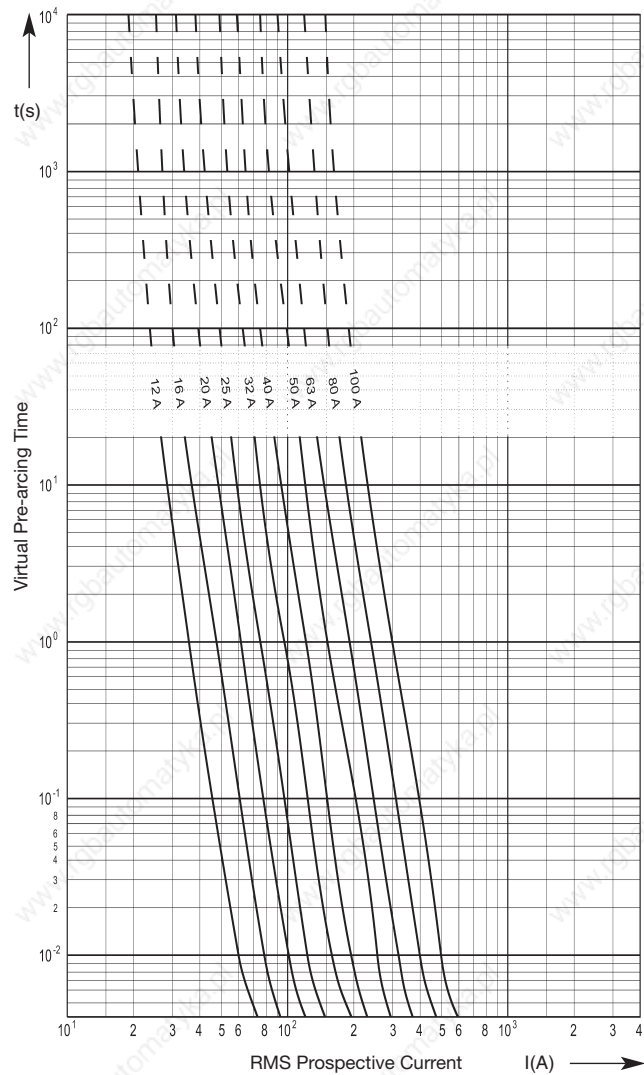

Size 22 x 58 mm	Rated Voltage AC 690 V (IEC) · AC 700 V (UL)	Class gR	Rated Breaking Capacity 200 kA
---------------------------	--	--------------------	--

Rated Current [A]	Part No. without Striker	Part No. with Striker	Power Loss [W]	Pre-arcing I ² t-value [A ² s]	Total I ² t-value @ 660 V [A ² s]	Class
12	50 140 06.12	50 142 06.12	4.8	8	35	gR
16	50 140 06.16	50 142 06.16	5.5	12	52	gR
20	50 140 06.20	50 142 06.20	6.0	21	91	gR
25	50 140 06.25	50 142 06.25	7.2	32	140	gR
32	50 140 06.32	50 142 06.32	9.6	63	315	gR
40	50 140 06.40	50 142 06.40	12	140	610	gR
50	50 140 06.50	50 142 06.50	15	210	910	gR
63	50 140 06.63	50 142 06.63	16	510	2 260	gR
80	50 140 06.80	50 142 06.80	18	1 000	4 400	gR
100	50 140 06.100	50 142 06.100	19	2 050	8 900	gR
125*	50 140 06.125	50 142 06.125	23	3 000	22 000	aR
135*	50 140 06.135	50 142 06.135	26	3 500	25 000	aR

* AC 600 V

Cut-Off Characteristics

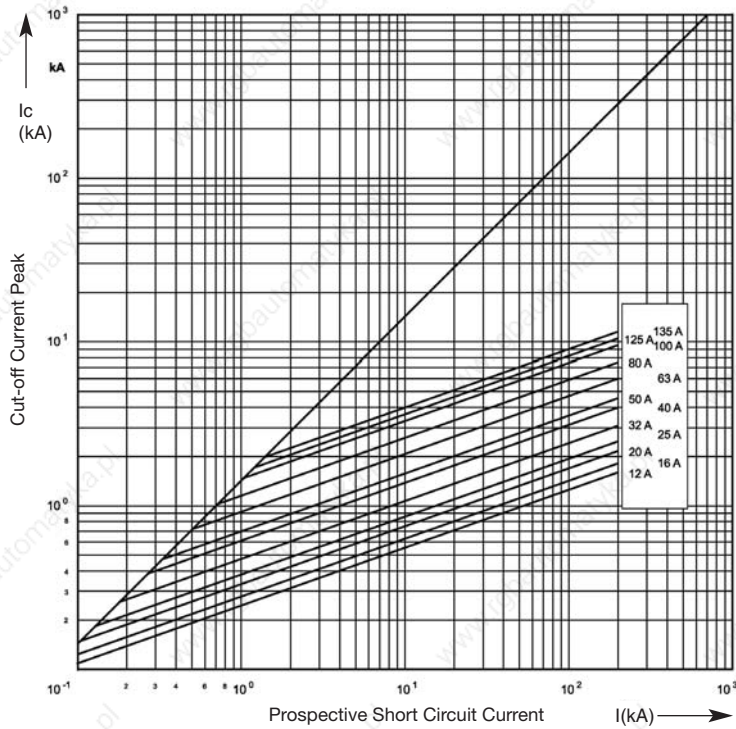

Time-Current Characteristics

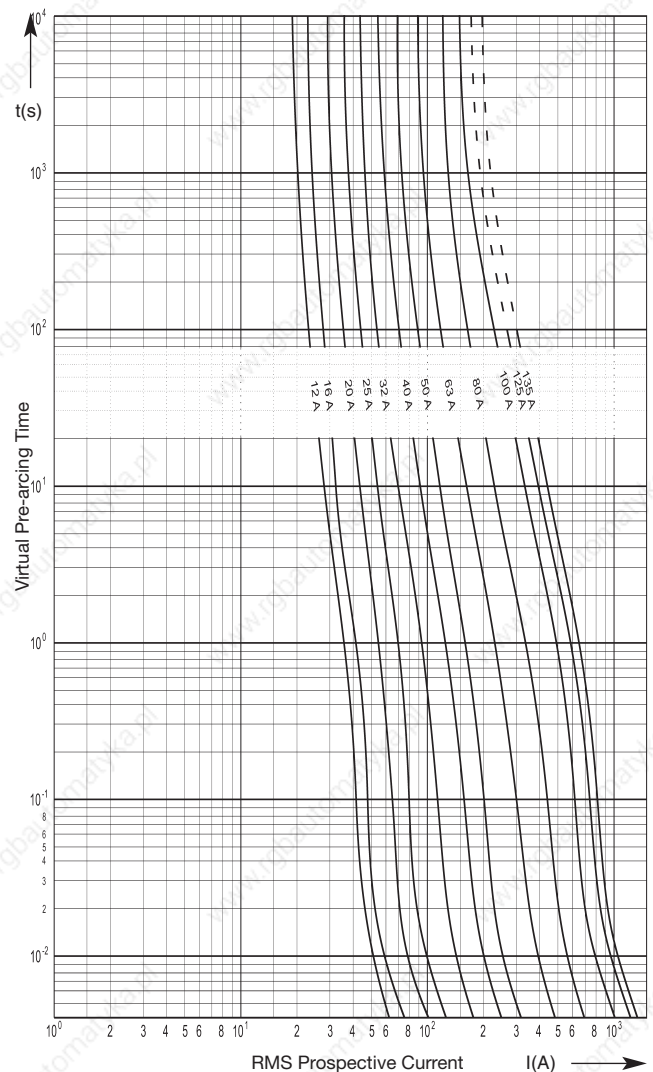

Arc voltage-Diagram

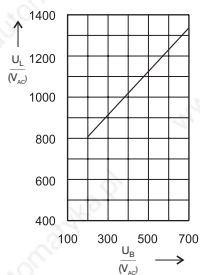

Reduction factor for total I²t-value

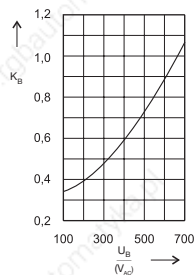

Reduction factor for power loss

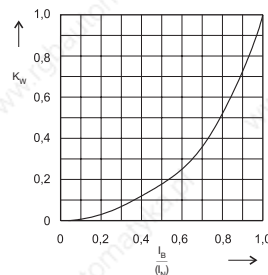

Size **22 x 58 mm** Rated voltage **AC 690 V (IEC) · AC 700 V (UL)** Class **gRL(gS)** Rated Breaking Capacity **200 kA**

Rated Current [A]	Part No. without Striker	Part No. with Striker	Power Loss [W]	Pre-arcing I ² t-value [A ² s]	Total I ² t-value @ 660 V [A ² s]
25	50 140 34.25	50 142 34.25	3.6	100	800
30	50 140 34.30	50 142 34.30	4.6	190	1 500
32	50 140 34.32	50 142 34.32	4.8	250	2 000
35	50 140 34.35	50 142 34.35	5.0	370	3 000
40	50 140 34.40	50 142 34.40	5.2	420	3 400
50	50 140 34.50	50 142 34.50	5.4	870	7 000
63	50 140 34.63	50 142 34.63	6.8	1 300	10 500
80	50 140 34.80	50 142 34.80	7.5	2 500	20 000
100	50 140 34.100	50 142 34.100	7.7	4 600	37 000

Cut-Off Characteristics

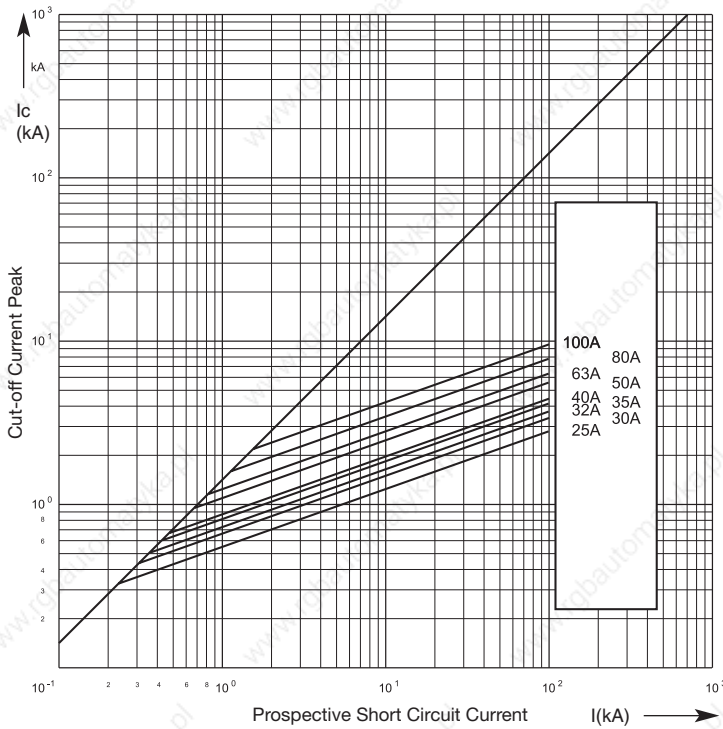

Time-Current Characteristics

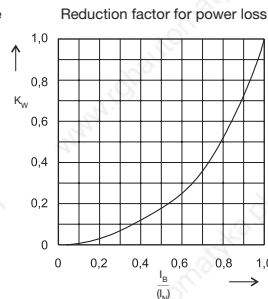
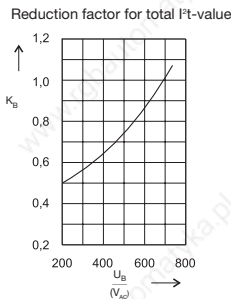
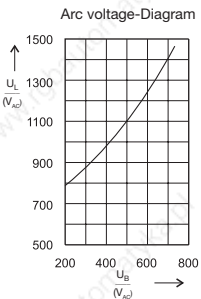
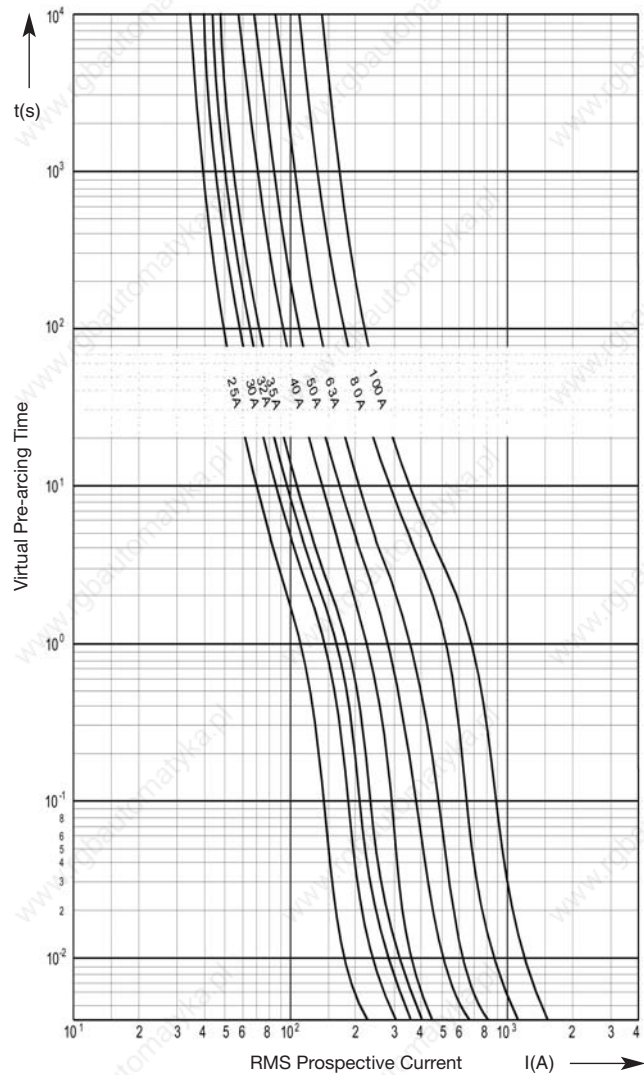

Size 27 x 60 mm	Rated Voltage AC 660 V	Class aR	Rated Breaking Capacity 200 kA
---------------------------	----------------------------------	--------------------	--

Rated Current [A]	Part No. without Striker	Part No. with Striker	Power Loss [W]	Pre-arcing I ² t-value [A ² s]	Total I ² t-value @ 660 V [A ² s]
20	50 193 20.20	50 194 20.20	8	17	100
25	50 193 20.25	50 194 20.25	9	30	180
32	50 193 20.32	50 194 20.32	10	67	400
40	50 193 20.40	50 194 20.40	13	90	550
50	50 193 20.50	50 194 20.50	15	150	900
63	50 193 20.63	50 194 20.63	16	330	2 000
80	50 193 20.80	50 194 20.80	22	472	2 900
100	50 193 20.100	50 194 20.100	25	850	5 400
125	50 193 20.125	50 194 20.125	30	1 310	7 900
160	50 193 20.160	50 194 20.160	32	2 950	17 700
200	50 193 20.200	50 194 20.200	37	5 000	30 000
250	50 193 20.250	50 194 20.250	43	8 100	49 000

Cut-Off Characteristics

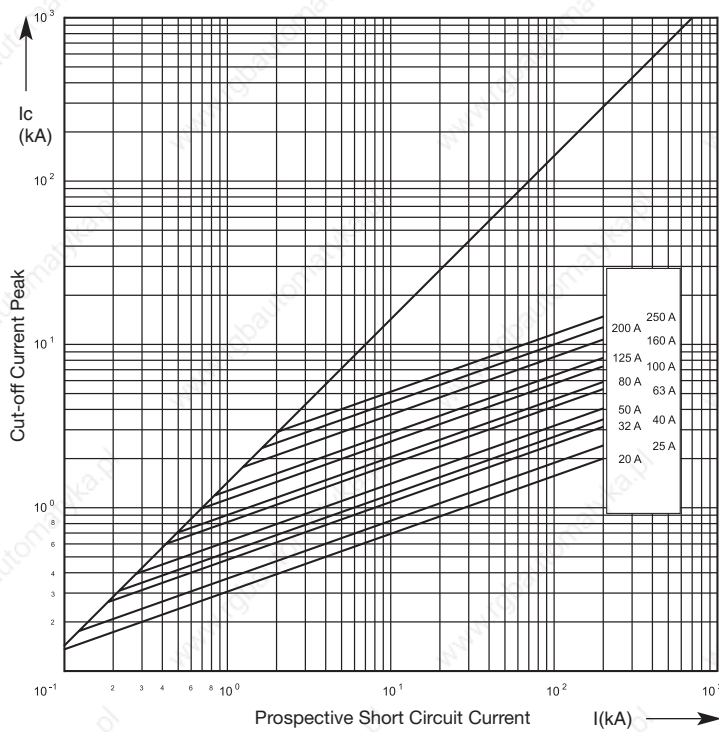

Time-Current Characteristics

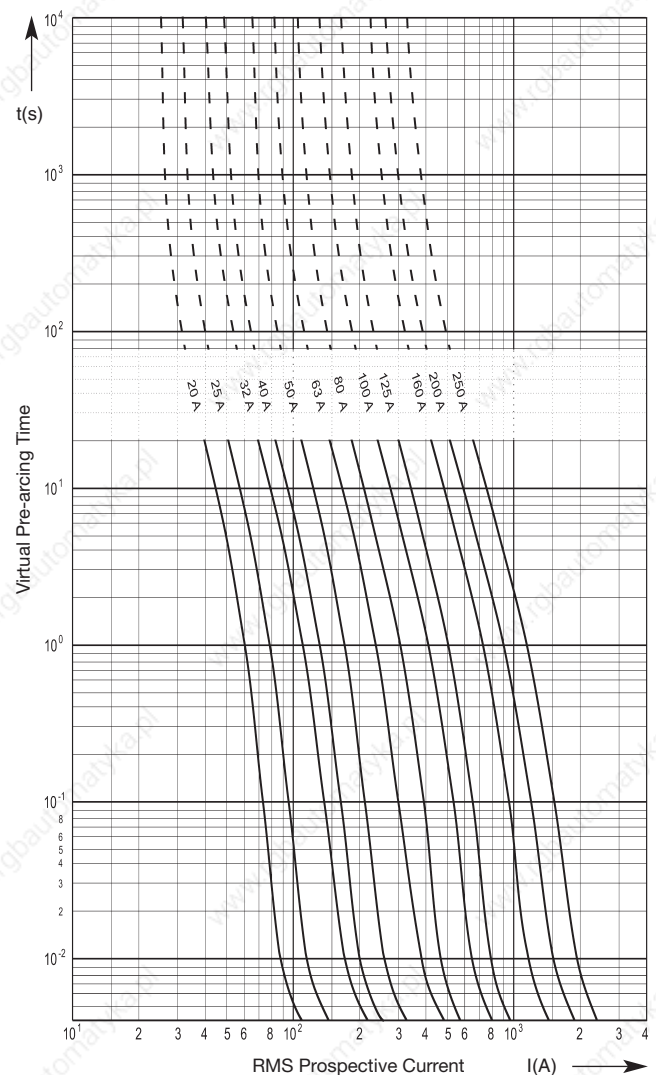

Arc voltage-Diagram

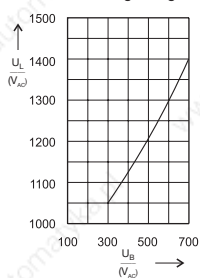

Reduction factor for total I²t-value

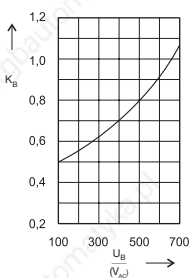

Reduction factor for power loss

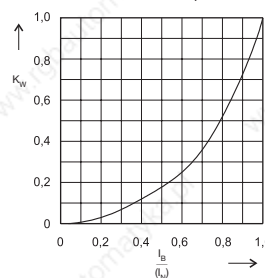

Size
27 x 60 mm

Rated Voltage
AC 1000 V

Class
aR

Rated Breaking Capacity
100 kA

Rated Current [A]	Part No. without Striker	Part No. with Striker	Power Loss [W]	Pre-arcing I ² t-value [A ² s]	Total I ² t-value @ 1000 V [A ² s]
32	50 196 20.32	50 197 20.32	17	32	210
40	50 196 20.40	50 197 20.40	17	82	530
50	50 196 20.50	50 197 20.50	20	141	920
63	50 196 20.63	50 197 20.63	22	250	1 630
80	50 196 20.80	50 197 20.80	24	512	3 330
100	50 196 20.100	50 197 20.100	26	1 000	6 500
125	50 196 20.125	50 197 20.125	26	2 260	14 700
160	50 196 20.160	50 197 20.160	34	4 600	30 000
170	50 196 20.170	50 197 20.170	30	7 790	50 600

Cut-Off Characteristics

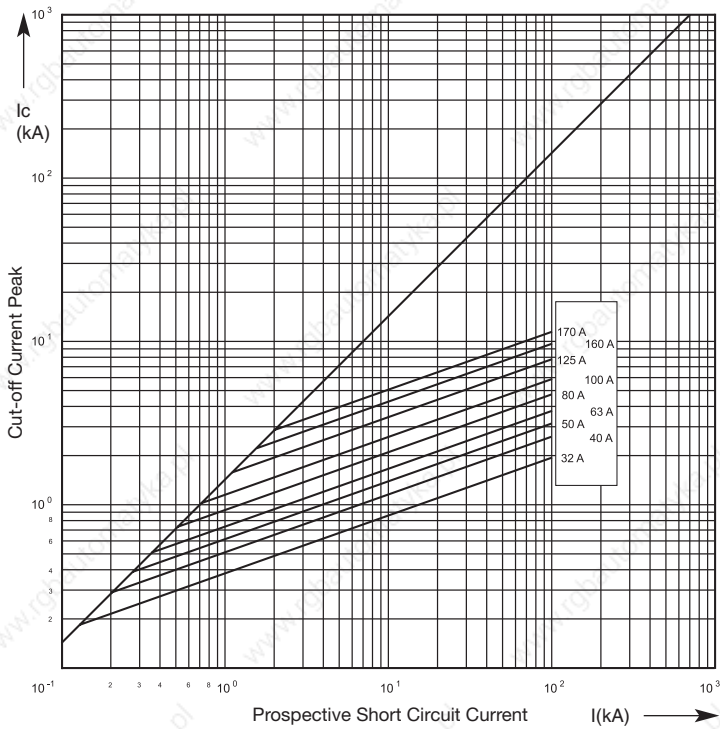

Time-Current Characteristics

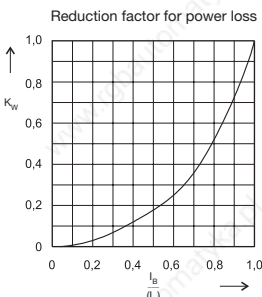
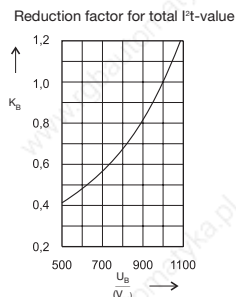
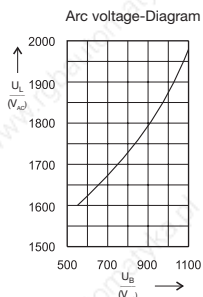
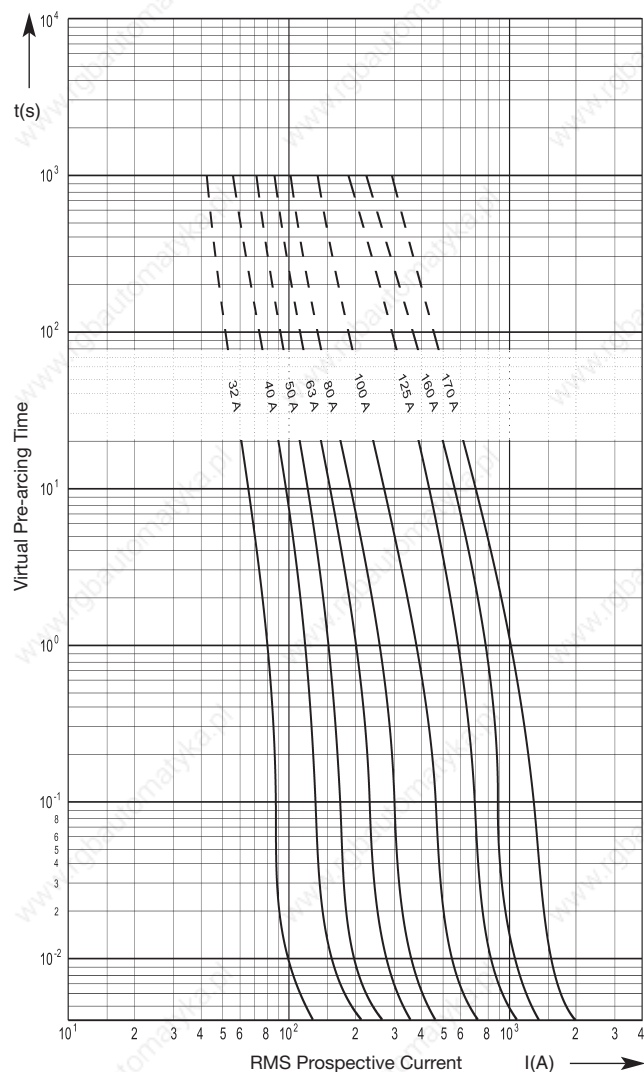

Size 27 x 60 mm	Rated Voltage DC 660 V	Class gR	Rated Breaking Capacity 50 kA
---------------------------	----------------------------------	--------------------	---

Rated Current [A]	Part No.	Power Loss [W]	Pre-arcing I ² t-value [A ² s]	Total I ² t-value @ 600 V [A ² s]
8	50 190 06.8	2.0	4	20
10	50 190 06.10	2.2	8	40
12	50 190 06.12	2.7	12	60
16	50 190 06.16	3.1	32	160
20	50 190 06.20	3.5	62	310
25	50 190 06.25	3.9	130	650
32	50 190 06.32	4.6	250	1 250
40	50 190 06.40	6.6	420	2 100
50	50 190 06.50	7.5	620	3 100
63	50 190 06.63	8.9	1 200	6 000
80	50 190 06.80	10.9	2 100	10 500
100	50 190 06.100	13.5	3 500	17 500
110	50 190 06.110	14.2	4 600	23 000

Time-Current Characteristics

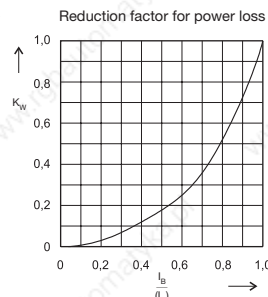
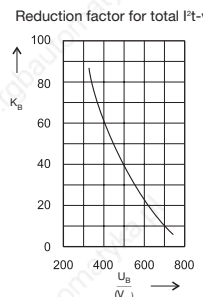
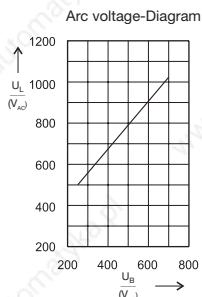
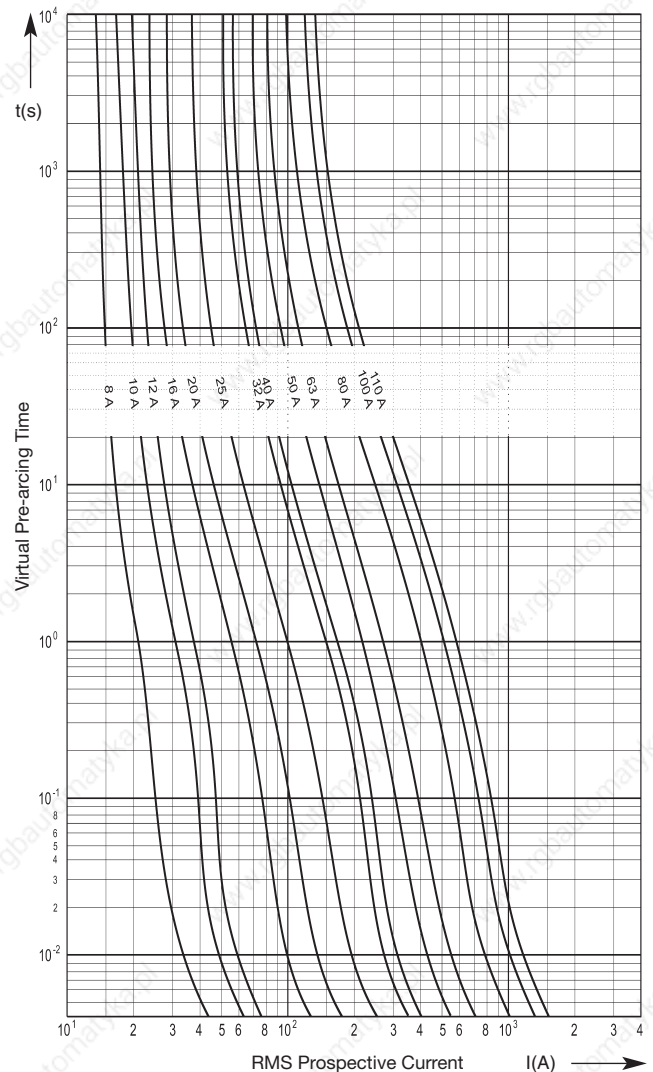

Fuse-Clip Screw Mountable

Power Acceptance
4 W
61 017 01.2
Size 10

A 0.50" (13 mm)
B 0.55" (14 mm)
C 0.70" (18 mm)
D 0.17" (4.2 mm)
E 0.20" (5 mm)

Power Acceptance
6 W
61 001 01.2
Size 14

A 0.63" (16 mm)
B 0.63" (16 mm)
C 0.90" (23 mm)
D 0.17" (4.2 mm)
E 0.26" (6.5 mm)

Power Acceptance
12 W
61 002 01.3
Size 22

A 0.75" (19 mm)
B 1.06" (27 mm)
C 1.50" (38 mm)
D 0.18" (4.5 mm)
E 0.16" (4 mm)
F 0.30" (8 mm)
G 0.30" (8 mm)

Power Acceptance
12 W
61 004 01.3
Size 27

A 1.06" (27 mm)
B 2.30" (58.4 mm)
C 4.55" (115.6 mm)

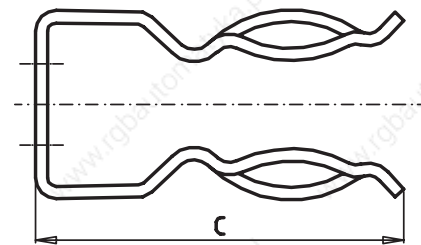
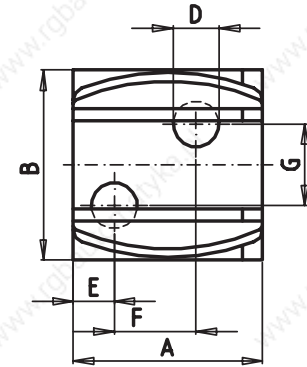

Clamping Plate

Part No.
63 017 01

A 0.40" (10 mm)
B 0.35" (9 mm)
C 0.08" (2 mm)
D 0.17" (4.2 mm)

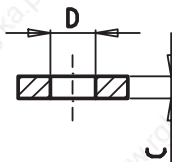
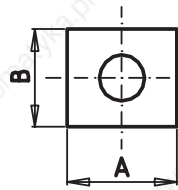

To be used with fuse clips 61 017 01.2
and 61 001 01.2

Part No.
63 002 01

A 0.73" (18.5 mm)
B 0.60" (15 mm)
C 0.12" (3 mm)
D M4
E 0.16" (4 mm)
F 0.30" (8 mm)
G 0.30" (8 mm)

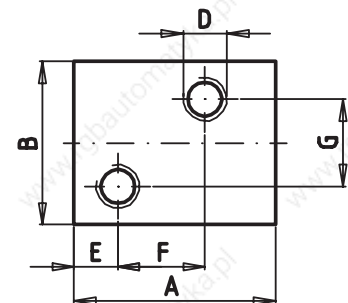

To be used with fuse clips 61 002 01.3

Fuse-Clip PCB mountable

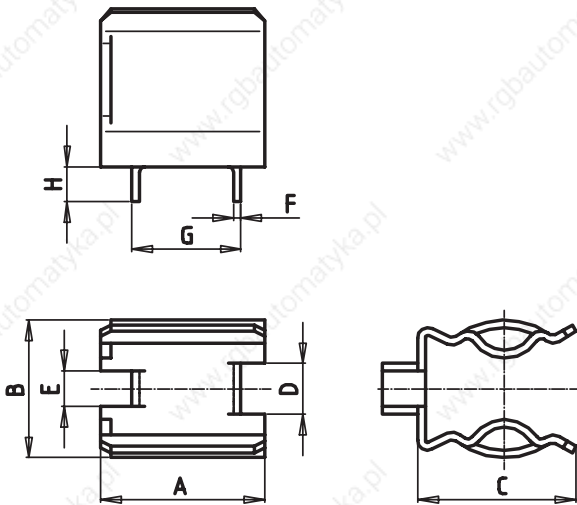

Power Acceptance
6 W
58 058 06
Size 14

A	0.63" (16 mm)
B	0.55" (14 mm)
C	0.60" (15.5 mm)
D	0.20" (5 mm)
E	0.14" (3.5 mm)
F	0.03" (0.75 mm)
G	0.42" (10.7 mm)
H	0.14" (3.5 mm)

Fuse-Clip PCB Mountable

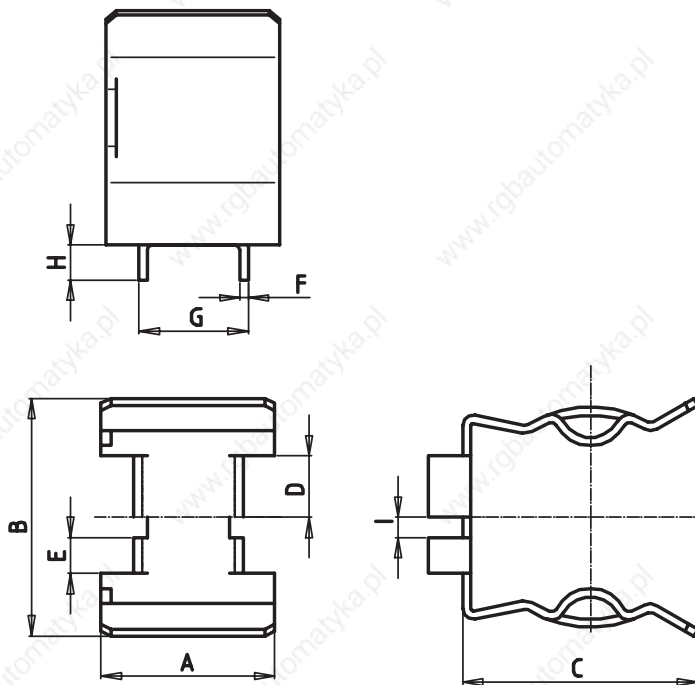

Power Acceptance
12 W
58 060 06
Size 22

A	0.67" (17 mm)
B	0.87" (22 mm)
C	0.90" (23 mm)
D	0.24" (6 mm)
E	0.14" (3.5 mm)
F	0.03" (0.75 mm)
G	0.42" (10.7 mm)
H	0.14" (3.5 mm)

ZS-Modul for Fuse-Links with Cylindrical Contact Caps

Isolated Fuse-Base

Size 10 x 38

Part No.	51 063 04.DC for 1000 V DC	
	51 063 04	51 063 04.L 1 pol.
	51 063 04.2	51 063 04.2L 2 pol.
	51 063 04.3	51 063 04.3L 3 pol.



L= Light Emitting Diode (LED) Indicator

Power Acceptance: **4 W**

A	3.07" (78 mm)	H	3.13" (79.5 mm)
B	0.70" (17.8 mm)	J	1.69" (43 mm)
C	1.40" (35.6 mm)	K	0.40" (10 mm)
D	2.10" (53.4 mm)	M	1.77" (45 mm)
E	2.80" (71.2 mm)	N	0.65" (16.5 mm)
F	2.20" (56 mm)	P	0.13" (3.2 mm)
G	2.40" (61 mm)	W	0.10" (2.5 mm)

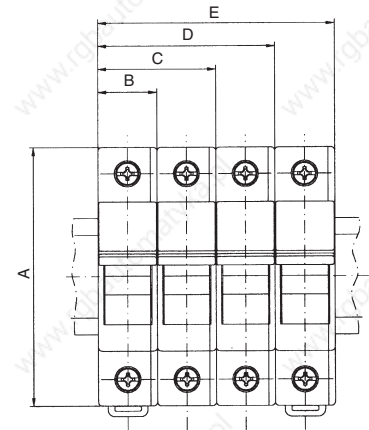
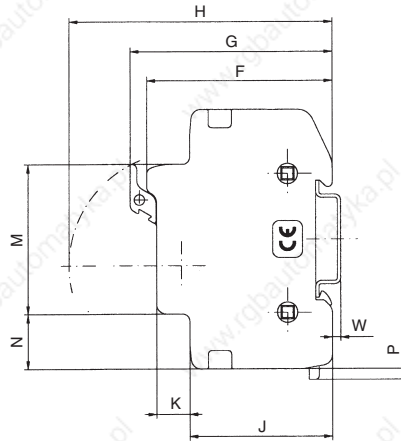

Size 14 x 51

Part No.	51 058 04	51 058 04.S	1 pol.
	51 058 04.2		2 pol.
	51 058 04.3	51 058 04.3S	3 pol.



S= Micro switch

Power Acceptance: **6 W**

A	4.04" (102.5 mm)	M	1.77" (45 mm)
B	1.04" (26.5 mm)	N	1.28" (32.5 mm)
C	2.10" (53 mm)	P	0.40" (10.5 mm)
D	3.13" (79.5 mm)	R	1.48" (37.5 mm)
E	4.17" (106 mm)	S	0.30" (8 mm)
F	2.66" (67.5 mm)	T	0.80" (20.5 mm)
G	3.00" (76 mm)	U Ø	0.33" (8.5 mm)
H	3.70" (94.2 mm)	W	0.1" (2.5 mm)
J	2.07" (52.5 mm)	X	3.17" (80.5 mm)
K	0.30" (8 mm)	Z Ø	0.17" (4.4 mm)

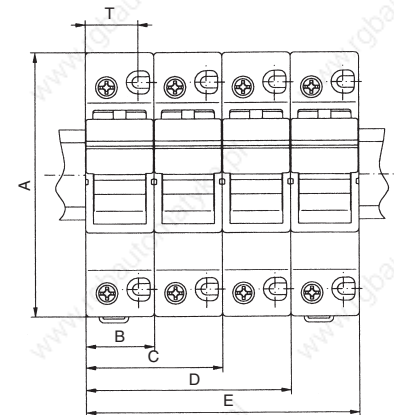
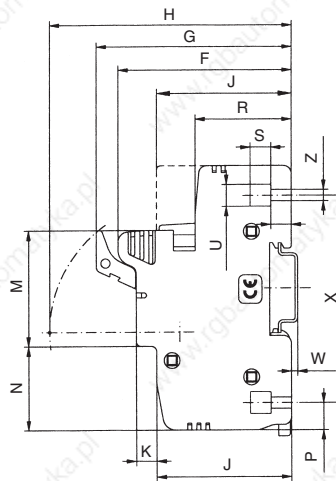

Size 22 x 58

Part No.	51 060 04	51 060 04.S	1 pol.
	51 060 04.2		2 pol.
	51 060 04.3	51 060 04.3S	3 pol.



S= Micro switch

Power Acceptance: **12 W**

A	5.50" (140 mm)	M	1.77" (45 mm)
B	1.40" (35.6 mm)	N	2.00" (50.5 mm)
C	2.80" (71.2 mm)	P	0.30" (7.5 mm)
D	4.20" (106.8 mm)	R	1.57" (40 mm)
E	5.60" (142.4 mm)	S	0.30" (8 mm)
F	2.97" (75.5 mm)	T	1.06" (27 mm)
G	3.44" (87.5 mm)	W	0.10" (2.5 mm)
H	4.35" (110.5 mm)	X	4.30" (109.5 mm)
J	2.10" (53 mm)	Z Ø	0.17" (4.4 mm)
K	0.63" (16 mm)		

