

EDB4900UE
00420150

Lenze

Operating Instructions

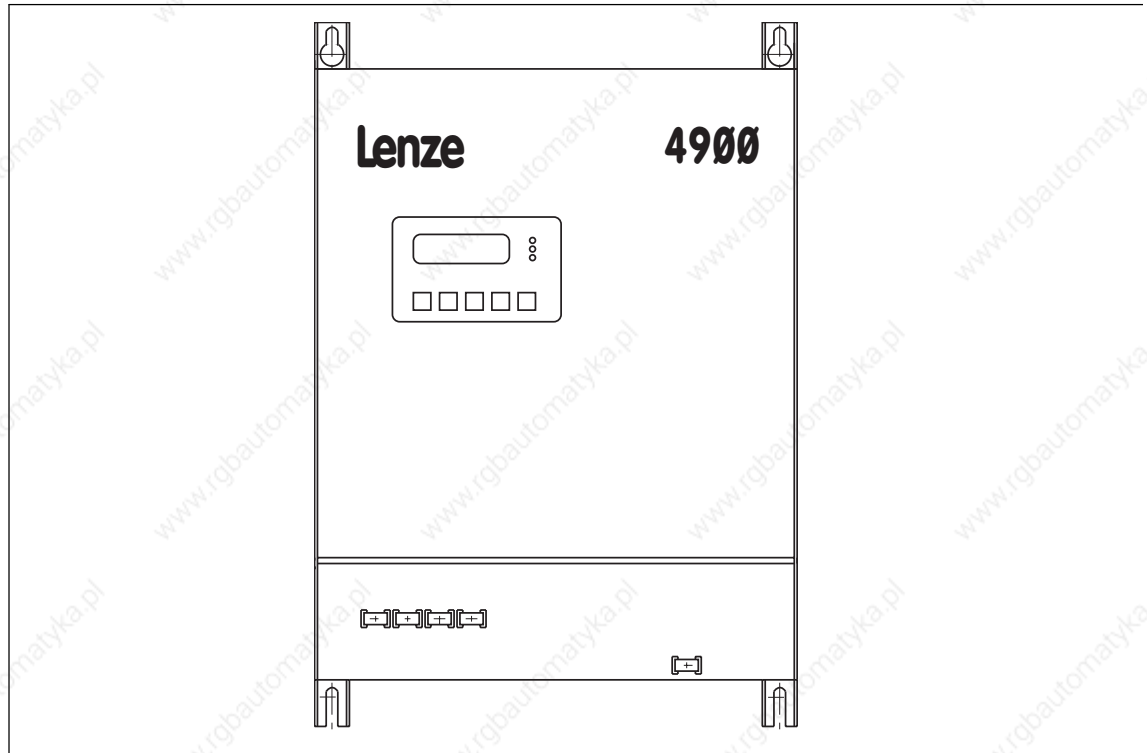

DC speed controller
4800 / 4900



These Operating Instructions are valid for 48XX/49XX controllers in the following versions

49XX-	E.	4x.	6x	4902 - 4913
48XX-	E.	4x.	6x	4808 - 4813
49XX-	E.	4x.	6x V011	4902 - 4907 (InterBus)
49XX-	E.	4x.	6x V013	4902 - 4907 (PROFIBUS)
49XX-	E.	4x.	6x V014	4902 - 4913 (500 V mains voltage)
48XX-	E.	4x.	6x V014	4808 - 4813 (500 V mains voltage)

Type	
Design: E = Enclosure IP20 IB = Module	
Hardware level and index	
Software level and index	
Variant	
Explanation	

		revised	
Edition of:	01.04.1998	03/2001	

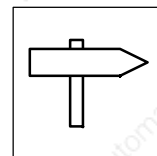

1	Preface and general information	1-1
1.1	About these Operating Instructions ...	1-1
1.1.1	Terminology used	1-1
1.2	Scope of delivery	1-1
1.3	48XX/49XX controller	1-2
1.3.1	Labelling	1-2
1.3.2	Application as directed	1-2
1.3.3	Legal regulations	1-3
1.4	EC Directives/Declaration of Conformity	1-4
1.4.1	What is the purpose of EC directives?	1-4
1.4.2	What does the CE mark imply?	1-4
1.4.3	EC Low-Voltage Directive	1-4
1.4.4	EC Directive Electromagnetic Compatibility	1-6
1.4.5	EC Machinery Directive	1-9
2	Safety information	2-1
2.1	Persons responsible for the safety	2-2
2.2	General safety information	2-3
2.3	Residual hazards	2-3
2.4	Layout of the safety information	2-4
3	Technical data	3-1
3.1	Features	3-1
3.2	General data / application conditions	3-3
3.3	Rated data	3-4
3.3.1	Mains voltage 400V	3-4
3.3.2	Mains voltage 500V (Variant V014)	3-6
3.4	Dimensions	3-8
3.4.1	Controller 4902 to 4X09	3-8
3.4.2	Controllers 4811 to 4813, 4911 to 4913	3-9

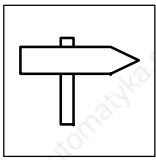

Contents

4	Installation	4-1
4.1	Mechanical installation	4-1
4.1.1	Important notes	4-1
4.2	Electrical installation	4-2
4.2.1	Protection of persons	4-2
4.2.2	Protection of the controller	4-3
4.2.3	Screening of the control cables	4-3
4.2.4	Earthing of the control electronics	4-4
4.2.5	Mains types and conditions	4-4
4.3	Connection	4-5
4.3.1	Power connection of standard controller	4-6
4.3.2	Separate supply of the field-current bridge at a high motor field voltage	4-9
4.3.3	Separate supply for the control electronics	4-11
4.3.4	Control connections	4-13
4.3.4.1	Connection of analog signals	4-14
4.3.4.2	Connection of digital signals	4-17
4.3.5	Feedback systems	4-21
4.3.6	Change of the direction of rotation in 2Q operation	4-23
4.3.7	Digital frequency selection and encoder emulation	4-24
4.3.8	Serial interface RS232/485	4-26
4.3.9	Fieldbus connection	4-27
4.4	Installation of a CE-typical drive system	4-29
4.4.1	General notes	4-29
4.4.2	Components of the CE-typical drive system	4-30
4.4.3	Measures required	4-30

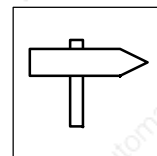

5	Commissioning	5-1
5.1	Initial switch-on	5-1
5.2	Commissioning of speed-controlled drives	5-2
5.2.1	Wiring recommendation for speed control with tacho	5-3
5.2.2	Wiring recommendation for speed control with resolver ..	5-4
5.2.3	Speed control with armature voltage feedback	5-5
5.3	Commissioning of torque-controlled drives	5-6
5.3.1	Wiring recommendation for torque control with speed limitation	5-7
5.4	Input of the motor data	5-8
5.5	Controller enable	5-9
5.6	Selection of direction of rotation and quick stop	5-10
5.7	Changing the internal control structure	5-12
5.8	Changing the terminal assignment	5-12
5.9	Application examples	5-15
5.9.1	Current ratio control	5-16
5.9.2	Dancer position control on an unwinder	5-18
5.9.3	Hoists	5-20
5.9.4	Synchronous speed ratio	5-22
5.9.5	Mains separation	5-25
5.9.5.1	Inching with mains separation	5-25
5.9.5.2	Mains switch-off logic	5-28
6	During operation	6-1

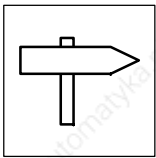

Contents

7	Configuration	7-1
7.1	Speed-controlled operation	7-1
7.1.1	Setpoint selection	7-1
7.1.1.1	Main setpoint	7-2
7.1.1.2	Additional setpoint	7-2
7.1.1.3	JOG setpoints	7-2
7.1.1.4	Master current	7-4
7.1.1.5	External torque reduction	7-4
7.1.1.6	Acceleration and deceleration times T_{ir} , T_{if}	7-6
7.1.1.7	Limitation of the speed setpoint	7-9
7.1.2	Actual value feedback	7-10
7.1.2.1	Armature voltage feedback	7-10
7.1.2.2	DC tacho feedback	7-11
7.1.2.3	Resolver feedback	7-13
7.1.2.4	Incremental encoder feedback	7-13
7.2	Parameter setting	7-14
7.2.1	Ways of parameter setting	7-14
7.2.2	Functions of the operation unit	7-15
7.2.3	Operating modes	7-16
7.2.4	Display functions	7-17
7.3	Code table	7-19
8	Troubleshooting and fault elimination	8-1
8.1	Troubleshooting	8-1
8.1.1	Display on the operating unit of the controller	8-1
8.1.2	Display via LECOM	8-2
8.2	Fault analysis with the history buffer	8-3
8.2.1	Structure of the history buffer	8-3
8.3	Fault messages	8-4
8.4	Reset of fault indications	8-6
8.5	Checking the drive system	8-7
8.5.1	Checking the motor	8-7
8.5.2	Checking the controller	8-8
9	Accessories	9-1
9.1	Fuses	9-2
9.1.1	Mains fuses	9-3
9.1.2	Armature fuses	9-4
9.1.3	Internal fuses	9-5
10	Signal-flow charts	10-1
11	Index	11-1



1 Preface and general information

1.1 About these Operating Instructions ...

- These Operating Instructions are intended for safety-relevant operations on and with the 48XX/49XX DC controllers. They contain safety information which must be observed.
- All persons who work on and with 48XX/49XX DC controllers must have the Operating Instructions available and observe all relevant notes and instructions.
- The Operating Instructions must always be in a complete and perfectly readable state.

1.1.1 Terminology used

Controller

In the following, the term "controller" is used for "48XX/49XX DC controllers".

Drive system

In the following text, the term "drive system" is used for drive systems with 48XX/49XX DC controllers and other Lenze drive components.

1.1.2 What is new / what has been changed ?

Material No.	Edition	Important	Contents
398658	12/97	1st edition	
420150	03/2001	replaces 398658	<ul style="list-style-type: none">• Chapter 3.3: Rated data• Chapter 4.3: Circuit diagrams• Chapter 4.4: Installation diagrams• Chapter 5.9.5.1: Circuit diagram• Chapter 7.3: Code table• Chapter 10: Signal-flow chart



Preface and general information

1.2 Scope of delivery

- The scope of delivery includes:
 - 1 48XX/49XX DC controller
 - 1 Operating Instructions
 - 1 Accessory kit with plug-in terminals
- After receipt of the delivery, check immediately whether the scope of delivery matches the accompanying papers. Lenze does not accept any liability for deficiencies claimed subsequently. Make a claim for
 - visible transport damage immediately to the forwarder.
 - visible deficiencies/incompleteness immediately to your Lenze representative.



1.3 48XX/49XX controller

1.3.1 Labelling

- Lenze 48XX/49XX controllers are unambiguously designated by the contents of the nameplate.
- CE mark:
 - Conformity with the Low-Voltage Directive
 - Conformity with the EMC Directive
- Manufacturer
 - Lenze GmbH & Co KG
 - Postfach 101352
 - D-31763 Hameln

1.3.2 Application as directed

48XX/49XX controllers

- must only be operated under the conditions prescribed in these Instructions.
- are components
 - for open-loop and closed-loop control of variable speed drives with separately excited DC motors.
 - to be installed into a machine.
 - used for assemblies together with other components to form a machine.
- should not be driven together with other DC motors, such as shunt motors or separately excited motors with a stabilizing series winding, before you have contacted Lenze.
- are electric units for the installation into control cabinets or similar enclosed operating housings.
- are not to be used as domestic appliances, but only for industrial purposes.

Drive systems with 48XX/49XX controllers

- comply with the EMC Directive, if they are installed according to the guidelines for CE-typical drive systems.
- can be used
 - on public and non-public mains.
 - in industrial premises.

The user is responsible for the compliance of his application with the EC directives.

Any other use shall be deemed inappropriate!



Preface and general information

1.3.3 Legal regulations

Liability

- The information, data and notes in these Operating Instructions met the state-of-the-art at the time of printing. Claims referring to drive systems which have already been supplied cannot be derived from the information, illustrations, and descriptions.
- The specifications, processes, and circuitry described in these Operating Instructions are for guidance only and must be adapted to your own specific application. Lenze does not take responsibility for the suitability of the process and circuit proposals.
- The indications given in these Operating Instructions describe the features of the product without warranting them.
- Lenze does not accept any liability for damage and operating interference caused by:
 - disregarding these Operating Instructions
 - unauthorized modifications to the controller
 - operating errors
 - improper working on and with the controller

Warranty

- Terms of warranty: see terms of sale and delivery of Lenze GmbH & Co KG.
- Warranty claims must be made immediately after detecting defects or faults.
- The warranty is void in all cases where liability claims cannot be made.

Disposal

The controller consists of different materials.

The following table lists which materials can be recycled and which must be disposed of.

Material	recycle	dispose
Metal	●	-
Plastic	●	-
Printed-board assemblies	-	●

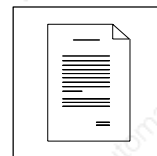

1.4 EC Directives/Declaration of Conformity

1.4.1 What is the purpose of EC directives?

EC directives are issued by the European Council and are intended for the determination of common technical requirements (harmonization) and certification procedures within the European Community. At the moment, there are 21 EC directives for product ranges. The directives are or will be converted to national laws of the member states. A certification issued by one member state is automatically valid without any further approval in all other member states.

The texts of the directive are restricted to the essential requirements. Technical details are or will be determined by European harmonized standards.

1.4.2 What does the CE mark imply?

After a verification, the conformity according to the EC directives is certified by affixing a CE mark. Within the EC there are no commercial barriers for a product with the CE mark.

Controllers on their own with the CE mark correspond exclusively to the Low Voltage Directive. For the compliance with the EMC Directive, only general recommendations have been issued so far. The CE conformity of the installed machine remains the responsibility of the user. For the installation of CE-typical drive systems with the basic version of 48XX/49XX controllers and the variants V011, V013 and V014, Lenze has already proved the conformity with the EMC Directive (see chapter 4.4).

1.4.3 EC Low-Voltage Directive

(73/23/EEC)

amended by: CE Mark Directive (93/68/EEC)

General

- The Low-Voltage Directive is effective for all electrical equipment for use with a rated voltage between 50 V and 1000 V AC and between 75 V and 1500 V DC, and under normal ambient conditions. The use, for instance, of electrical equipment in explosive atmospheres and electrical parts in passenger and goods lifts are excepted.
- The objective of the Low-Voltage Directive is to ensure that only electrical equipment which does not endanger the safety of persons or animals is placed on the market. It should also be designed to conserve material assets.

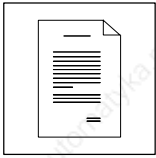

Preface and general information

EC Declaration of Conformity '96

for the purpose of the EC Low Voltage Directive (73/23/EEC)

amended by: CE Mark Directive (93/68/EEC)

48XX/49XX controllers were developed, designed, and manufactured in compliance with the EC Directive under the sole responsibility of

Lenze GmbH & Co KG, Postfach 10 13 52, D-31763 Hameln

Considered standards:

Standard	
DIN VDE 0160 5.88 + A1 / 4.89 + A2 / 10.88 prDIN EN 50178 Classification VDE 0160 / 11.94	Electronic equipment for use in electrical power installations
DIN VDE 0100	Standards for the erection of power installations
EN 60529	IP degrees of protection
IEC 249 / 1 10/86, IEC 249 / 2-15 / 12/89	Base material for printed circuits
IEC 326 / 1 10/90, EN 60097 / 9.93	Printed circuits, printed boards
DIN VDE 0110 /1-2 /1/89 /20/ 8/90	Creepage distances and clearances

Hameln, 01/10/1997

(i. V. Schäfer)
Product Manager

(i. A. Tolksdorf)
Commissioned for CE



1.4.4 EC Directive Electromagnetic Compatibility

(89/336/EEC)

amended by: First Amendment Directive (92/31/EEC)

CE Mark Directive (93/68/EEC)

General

- The EC Electromagnetic Compatibility Directive is effective for "devices" which may cause electromagnetic interference, or the operation of which may be impaired by such interference.
- The aim is to limit the generation of electromagnetic interference so that an operation is possible without interference to radio and telecommunication systems and other equipment. The devices must also show an appropriate resistance to electromagnetic interference, to ensure the application as directed.
- Controllers cannot be evaluated on their own in terms of EMC. Only after the integration of the controllers into a drive system, can this system be tested concerning the objectives of the EC EMC Directive and the compliance with the "Law about the Electromagnetic Compatibility of Devices".
- Lenze has verified the conformity of 48XX/49XX controllers integrated into certain defined drive systems. In the following, these systems are called "CE-typical drive systems" (see chapter 4.4).
- The following configurations can now be selected by the user:
 - The user himself can determine the system components and their integration into the drive system, and is then held responsible for the conformity of the drive.
 - The user can select the CE-typical drive systems for which the manufacturer has already proved the conformity.



Preface and general information

EC Declaration of Conformity '97 for the purpose of the EC Directive

on Electromagnetic compatibility (89/336/EEC)

amended by: First Amendment Directive (92/31/EEC)

CE Mark Directive (93/68/EEC)

48XX/49XX controllers cannot be driven in stand-alone operation for the purposes of the Regulation on Electromagnetic Compatibility (EMVG of 09 November, 1992 and the first Amendment of 08 August, 1995). The EMC can only be verified when the controller is integrated into a drive system.

Lenze GmbH & Co KG, Postfach 10 13 52, D-31763 Hameln

declares that the described "CE-typical drive systems" with the basic version of 48XX/49XX controller and the variants V011, V013 and V014 comply with the above EC Directive.

The conformity evaluation is based on the product standard for drive systems EN 61800-3.

EN 61800-3	EMC product standard including special test methods for electric drives
------------	---

Generic standards considered:

Generic standard	
EN 50081-2 /93	Generic standard for noise emission; part 2: Industrial premises The noise emission in industrial premises is not limited in EN 61800-3. These generic standards are used in addition to the requirements of the standard DIN IEC 22G.
EN 50082-2 3/94	Generic standard for noise immunity part 2: Industrial premises (The requirements of noise immunity for residential areas were not considered, since these are less strict.)

Generic standards considered for the test of noise emission:

Generic standard	Test	Limit value
EN 55011	7/92 Radio interferences, housing and mains Frequency range 0.15 - 1000MHz The noise emission in industrial premises is not limited in IEC 22G. These generic standards are used in addition to the requirements of IEC 22G.	Class A for use in industrial premises

Preface and general information



Generic standards considered for the test of noise emission:

Basic standard		Test	Limit value
EN 61000-4-2	3/95	Electrostatic discharge on housing and heatsink	Severity 3 6kV for contact, 8kV clearance
IEC 1000-4-3	2/95	Electromagnetic fields Frequency range 26-1000MHz	Severity 3 10V/m
ENV 50140	8/93	High-frequency field Frequency range 80-1000MHz, 80% amplitude modulated	Severity 3 10V/m
		Fixed frequency 900MHz with 200Hz, 100 % modulated	10V/m
EN 61000-4-4	3/95	Fast transients, burst on power terminals	Severity 3 2kV/5kHz
		Burst on bus and control cables	Severity 4 2kV/5kHz
EN 61000-4-5	10/94	Surge test Mains cable	Installation class 3

Hameln, 01/10/1997

(i. V. Schäfer)
Product Manager

(i. A. Tolksdorf)
Commissioned for CE



Preface and general information

1.4.5 EC Machinery Directive

(89/392/EEC)

amended by: First Amendment Directive (91/368/EEC)

Second Amendment Directive (93/44/EEC)

CE Mark Directive (93/68/EEC)

For the purpose of the Machinery Directive, "machinery" means an assembly of linked parts or components, at least one of which can move, with the appropriate actuators, control and power circuits, etc., joined together for a specific application, in particular for the processing, treatment, moving or packaging of a material.

EC Manufacturer's Declaration

for the purpose of the EC Machinery Directive (89/392/EEC)

amended by: First Amendment Directive (91/368/EEC)

Second Amendment Directive (93/44/EEC)

CE Mark Directive (93/68/EEC)

48XX/49XX controllers were developed, designed, and manufactured under the sole responsibility of

Lenze GmbH & Co KG, Postfach 10 13 52, D-31763 Hameln

Commissioning of the controllers is prohibited until it is proven that the machine in which they are to be installed corresponds to the EC Machinery Directive.

Hameln, 01/10/1997

(i. V. Schäfer)
Product Manager



2 Safety information



Safety and application notes for controllers

(to: Low-Voltage Directive 73/23/EEC)

1. General

During operation, drive controllers may have, according to their type of protection, live, bare, in some cases also movable or rotating parts as well as hot surfaces.

Non-authorized removal of the required cover, inappropriate use, incorrect installation or operation, creates the risk of severe injury to persons or damage to material assets.

Further information can be obtained from the documentation.

All operations concerning transport, installation, and commissioning as well as maintenance must be carried out by qualified, skilled personnel (IEC 364 and CENELEC HD 384 or DIN VDE 0100 and IEC report 664 or DIN VDE 0110 and national regulations for the prevention of accidents must be observed).

According to this basic safety information qualified skilled personnel are persons who are familiar with the erection, assembly, commissioning, and operation of the product and who have the qualifications necessary for their occupation.

2. Application as directed

Drive controllers are components which are designed for installation in electrical systems or machinery.

When installing in machines, commissioning of the drive controllers (i.e. the starting of operation as directed) is prohibited until it is proven that the machine corresponds to the regulations of the EC Directive 89/392/EEC (Machinery Directive); EN 60204 must be observed.

Commissioning (i.e. starting of operation as directed) is only allowed when there is compliance with the EMC Directive (89/336/EEC).

The drive controllers meet the requirements of the Low Voltage Directive 73/23/EEC. The harmonized standards of the prEN 50178/ DIN VDE 0160 series together with EN 60439-1/DIN VDE 0660 part 500 and EN 60146/DIN VDE 0558 are applicable to drive controllers.

The technical data and information on the connection conditions must be obtained from the nameplate and the documentation and must be observed in all cases.

3. Transport, storage

Notes on transport, storage and appropriate handling must be observed.

Climatic conditions must be observed according to prEN 50178.

4. Erection

The devices must be erected and cooled according to the regulations of the corresponding documentation.

The drive controllers must be protected from inappropriate loads. Particularly during transport and handling, components must not be bent and/or isolating distances must not be changed. Touching of electronic components and contacts must be avoided.

Drive controllers contain electrostatically sensitive components which can easily be damaged by inappropriate handling. Electrical components must not be damaged or destroyed mechanically (health risks are possible!).

5. Electrical connection

When working on live drive controllers, the valid national regulations for the prevention of accidents (e.g. VBG 4) must be observed.

The electrical installation must be carried out according to the appropriate regulations (e.g. cable cross-sections, fuses, PE connection). More detailed information is included in the documentation.

Notes concerning the installation in compliance with EMC - such as screening, grounding, arrangement of filters and laying of cables - are included in the documentation of the drive controllers. These notes must also be observed in all cases for drive controllers with the CE mark. The compliance with the required limit values demanded by the EMC legislation is the responsibility of the manufacturer of the system or machine.

6. Operation

Systems where drive controllers are installed must be equipped, if necessary, with additional monitoring and protective devices according to the valid safety regulations, e.g. law on technical tools, regulations for the prevention of accidents, etc. Modifications of the drive controllers by the operating software are allowed.

After disconnecting the drive controllers from the supply voltage, live parts of the controller and power connections must not be touched immediately, because of possibly charged capacitors. For this, observe the corresponding labels on the drive controllers.

During operation, all covers and doors must be closed.

7. Maintenance and servicing

The manufacturer's documentation must be observed.

The safety information must be preserved!

The product-specific safety and application notes in these Operating Instructions must also be observed!



Safety information

2.1 Persons responsible for the safety

Operator

- An operator is any natural or legal person who uses the drive system or on behalf of whom the drive system is used.
- The operator or his safety officer are obliged to ensure that
 - all relevant regulations, notes and laws are observed
 - only qualified personnel work on and with the drive system.
 - the personnel have the Operating Instructions available for all corresponding operations and
 - unqualified personnel are prohibited from working with and on the controller.

Qualified personnel

Qualified personnel are persons who - because of their education, experience, instruction, and knowledge about corresponding standards and regulations, rules for the prevention of accidents, and operating conditions - are authorized by the person responsible for the safety of the plant to perform the required actions and who are able to recognize and avoid potential hazards.
(see IEC 364, definition of qualified personnel)



2.2 General safety information

- These safety notes do not claim to be complete. In case of questions and problems please contact your Lenze representative.
- At the time of supply the drive system is state-of-the-art and ensures basically safe operation.
- The indications given in these Operating Instructions refer to the stated hardware and software versions of the controller.
- The controller is hazardous to persons, the controller itself and other property of the operator, if
 - unqualified personnel work on and with the drive system.
 - the controller is used inappropriately.
- The specifications, processes, and circuitry described in these Operating Instructions are for guidance only and must be adapted to your own specific application.
- Controllers must be designed so that they comply with their function and do not cause any hazards to persons, when correctly installed and in fault-free operation as directed. This also applies to the whole system.
- Take additional measures to limit consequences of malfunctions which may cause hazards to personnel or damage to properties:
 - further independent equipment which can take over the function of the controller
 - electrical or non-electrical protection (latching or mechanical blocking)
 - measures covering the complete system
- The drive system must only be operated in perfect condition.
- Retrofittings, modifications, or changes are generally prohibited. For some applications, Lenze authorizes the operation of retrofitted, modified or changed controllers. Please contact Lenze.

2.3 Residual hazards

Excessive speed

Drive systems may reach dangerously high speeds (e.g. caused by active loads like hoists):

- 48XX/49XX controllers do not offer any protection against these operating conditions. Use additional components for this.



Safety information

2.4 Layout of the safety information

- All safety information given in these Operating Instructions has the same layout:



Signal word

Note

- The icon characterizes the type of danger.
- The signal word characterizes the severity of danger.
- The note describes the danger and suggests how to avoid the danger.

Warning of danger for persons

Icons used		Signal words	
	Warning of hazardous electrical voltage	Danger!	Warns of impending danger . Consequences if disregarded: Death or very severe injuries.
		Warning!	Warns of potential, very hazardous situations . Possible consequences if disregarded: Death or very severe injuries.
	Warning of a general danger	Caution!	Warns of potential, hazardous situations . Possible consequences if disregarded: Light or minor injuries.

Warning of damage to material

Icons used		Signal words	
		Stop!	Warns of potential damage to material . Possible consequences if disregarded: Damage to the controller/drive system or its environment.

Other notes

Icons used		Signal words	
		Note!	Designates a general, useful tip. If you observe it, handling of the controller/drive system is made easier.

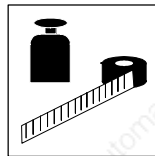

3 Technical data

3.1 Features

Controller and system features

- Control electronics and system software are the same for 48XX/49XX
- Digital speed feedback with resolver or incremental encoder
- Torque control with superimposed speed monitoring for winding drives
- Phase control for drift-free positioning
- Digital frequency coupling as setpoint bar or setpoint cascade for
 - phase synchronisation
 - speed-synchronous operation
 - synchronous speed ratio
- Increase of the max. armature voltage to 115 % $\cdot V_{\text{mains}}$ by changing from 4Q to 2Q operation (with 49XX)
- Speed accuracy better than 0.5‰ at 100% changing load with resolver feedback or incremental encoder
- Speed setting range 1:1000 at constant load with resolver feedback or incremental encoder
- Current setting range 1:300 by means of pulse current adaptation and bridge modulation
- Speed-dependent armature current limitation
- Adjustable max. armature current from 112,5 % to 180 % rated current (depending on the size)
- Freely connectable process controller, e.g. for dancer position control or tension control
- Integrated field current control for large speed setting range
- 4 customer-specific parameter sets can be saved and changed via digital input terminals

Operation

- On-line changes of control parameters
- Parameter setting and diagnosis via
 - keypad with two-line LCD in German, English and French
 - serial interface and PC
 - fieldbus module (as option): PROFIBUS, InterBus
- fault messages plain text

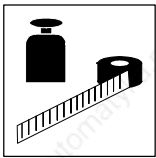

Technical Data

Speed feedback systems

- Resolver feedback with encoder emulation for superimposed systems (synchronizing systems, positioning controls, etc.)
- Incremental encoder feedback
- DC tacho feedback
- Armature voltage feedback

Inputs

- **Digital**
 - 8 isolated inputs (24 V level), 5 of them freely assignable
 - 1 serial interface RS 485 or RS 232 (1200 ... 9600 baud)
- **Analog**
 - 4 freely assignable inputs (13 bit resolution)
e.g. for main setpoint, additional setpoint, torque limitation, etc.

Outputs

- **Digital**
 - 8 isolated outputs (24 V level), 5 of them freely assignable
 - Another 7 free outputs can be evaluated via the LECOM interface
 - 1 relay output (50V; 0,5A), freely assignable
- **Analog**
 - 2 reference voltages ($\pm 10V$, 7mA)
 - 1 monitor output, with I_{act}
 - 2 monitor outputs, freely assignable (37 different signals with 11 bit resolution selectable)
 - 1 frequency output, freely assignable

Monitoring

- Monitoring functions of the system and controller components
- Controller protection ($I \cdot t$ function)
- Motor overload protection ($I^2 \cdot t$ function)
- Monitoring of frequency and mains voltage
- Self-synchronisation for mains frequencies from 50 to 60Hz
- Safe operation with CW or CCW direction of rotating field input
- Monitoring of the act.-value encoder feedback
- Display of the sources of controller inhibit via a code
- Classifiable monitoring (TRIP, message or warning)
- Monitoring of the cooling air stream with 4X08 to 4X13
- Monitoring of the semiconductor fuses with 4X11 to 4X13

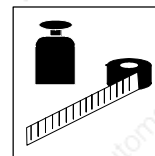

3.2 General data / application conditions

Field	Values																					
Type of protection	IP20 to DIN 40050, steel sheet housing																					
Permissible humidity	Relative humidity 90%, no condensation																					
Temperature ranges	<table border="0"> <tr> <td style="text-align: right;">Storage</td> <td>-25 °C...+ 55 °C</td> </tr> <tr> <td style="text-align: right;">Transport</td> <td>-25 °C...+ 70 °C</td> </tr> </table>	Storage	-25 °C...+ 55 °C	Transport	-25 °C...+ 70 °C																	
Storage	-25 °C...+ 55 °C																					
Transport	-25 °C...+ 70 °C																					
Influence of the installation height	<table border="0"> <tr> <td>$h \leq 1000\text{m}$</td> <td>: 100% rated armature current</td> </tr> <tr> <td>$h \leq 2000\text{m}$</td> <td>: 95% rated armature current</td> </tr> <tr> <td>$h \leq 3000\text{m}$</td> <td>: 90% rated armature current</td> </tr> <tr> <td>$h \leq 4000\text{m}$</td> <td>: 85% rated armature current</td> </tr> </table>	$h \leq 1000\text{m}$: 100% rated armature current	$h \leq 2000\text{m}$: 95% rated armature current	$h \leq 3000\text{m}$: 90% rated armature current	$h \leq 4000\text{m}$: 85% rated armature current													
$h \leq 1000\text{m}$: 100% rated armature current																					
$h \leq 2000\text{m}$: 95% rated armature current																					
$h \leq 3000\text{m}$: 90% rated armature current																					
$h \leq 4000\text{m}$: 85% rated armature current																					
Degree of pollution	VDE 0110, part 2, degree of pollution 2 Controllers must not be exposed to a corrosive or explosive atmo-sphere.																					
Noise emission	Requirements to EN 50081-2, IEC 22G Limit-value class A (EN 55011; industrial premises) with RFI filter																					
Noise immunity	<table border="0"> <tr> <td colspan="3">Limit values maintained with RFI filter.</td> </tr> <tr> <td colspan="3">Requirements to EN 50082-2, IEC 22G</td> </tr> <tr> <td><u>Requirements</u></td> <td><u>Standard</u></td> <td><u>Severity</u></td> </tr> <tr> <td>ESD</td> <td>EN 61000-4-2</td> <td>3, i.e. 8kV air discharge 6 kV contact discharge</td> </tr> <tr> <td>RF interference (enclosure)</td> <td>IEC 1000-4-3</td> <td>3, i.e. 10 V/m</td> </tr> <tr> <td>Burst</td> <td>EN 61000-4-4</td> <td>3/4, i.e. 2kV / 5kHz</td> </tr> <tr> <td>Surge</td> <td>EN 61000-4-5</td> <td>3, i.e. 1.2 / 50µs 1kV phase - phase 2kV phase - PE</td> </tr> </table>	Limit values maintained with RFI filter.			Requirements to EN 50082-2, IEC 22G			<u>Requirements</u>	<u>Standard</u>	<u>Severity</u>	ESD	EN 61000-4-2	3, i.e. 8kV air discharge 6 kV contact discharge	RF interference (enclosure)	IEC 1000-4-3	3, i.e. 10 V/m	Burst	EN 61000-4-4	3/4, i.e. 2kV / 5kHz	Surge	EN 61000-4-5	3, i.e. 1.2 / 50µs 1kV phase - phase 2kV phase - PE
Limit values maintained with RFI filter.																						
Requirements to EN 50082-2, IEC 22G																						
<u>Requirements</u>	<u>Standard</u>	<u>Severity</u>																				
ESD	EN 61000-4-2	3, i.e. 8kV air discharge 6 kV contact discharge																				
RF interference (enclosure)	IEC 1000-4-3	3, i.e. 10 V/m																				
Burst	EN 61000-4-4	3/4, i.e. 2kV / 5kHz																				
Surge	EN 61000-4-5	3, i.e. 1.2 / 50µs 1kV phase - phase 2kV phase - PE																				

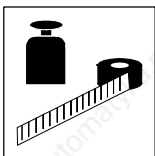

Technical Data

3.3 Rated data

3.3.1 Mains voltage 400V

- Controllers 4902 to 4907 (4Q controllers)

	Type	4902	4903	4904	4905	4906	4907
	Order No.	EVD 4902-E	EVD 4903-E	EVD 4904-E	EVD 4905-E	EVD 4906-E	EVD 4907-E
Output power ¹⁾	P _{el} [kW]	6.7	10.5	23.1	46.2	84	105
Mains voltage	V _{mains}	3 · 340...460 V~ ± 0%, 50...60Hz					
Armature voltage	V _A	420V if V _{mains} = 400V (1.05 · V _{mains})					
Rated armature current (continuous operation)	I _{Arated} [A]	16	25	55	110	200	250
Maximum current (short-time operation)	I _{Amax} [A]	29	45	90	150	240	300
Field voltage ²⁾	V _F	V _{Fmax} = 0.875 · V _{L1-L3}					
Max. field current, controlled	I _F [A]	3.5			10		
Power loss ³⁾	P _{loss} [W]	60	108	185	288	577	650
Ambient temperature in operation	T _{amb} [°C]	0...+ 45					
Weight approx.	[kg]	9,2	13,1	13,8	18	22	23

- Controllers 4908 to 4913 (4Q controllers)

	Type	4908	4909	4911	4912	4913	
	Order No.	EVD 4908-E	EVD 4909-E	EVD 4911-E	EVD 4912-E	EVD 4913	
Output power ¹⁾	P _{el} [kW]	139	210	294	420	504	
Mains voltage	V _{mains}	3 · 340 ... 460 V~ ± 0%, 50...60Hz					
Armature voltage	V _A	420 V if V _{mains} = 400V (1.05 · V _{mains})					
Rated armature current (continuous operation)	I _{Arated} [A]	330	500	700	1000	1200	
Maximum current (short-time operation)	I _{Amax} [A]	400	600	840	1200	1350	
Field voltage ²⁾	V _F	V _{Fmax} = 0,875 · V _{L1-L3}					
Max. field current, controlled	I _F [A]	15	30				
Power loss ³⁾	P _{loss} [W]	840	1220	2100	2850	3400	
Ambient temperature in operation	T _{amb} [°C]	0...+35 ⁴⁾					
Weight approx.	[kg]	28	28	60	60	60	

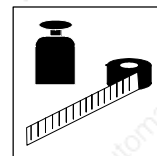

- Controllers 4808 to 4813 (2Q controllers)

	Type	4808	4809	4811	4812	4813
	Order No.	EVD 4808-E	EVD 4809-E	EVD 4811-E	EVD 4812-E	EVD 4813
Output power ¹⁾	P_{el} [kW]	152	230	322	460	552
Mains voltage	V_{mains}	3 · 340...460 V~ ± 0%, 50...60Hz				
Armature voltage	V_A	460 V if $V_{mains} = 400 \text{ V} (1.15 \cdot V_{mains})$				
Rated armature current (continuous operation)	I_{Arated} [A]	330	500	700	1000	1200
Maximum current (short-time operation)	I_{Amax} [A]	400	600	840	1200	1350
Field voltage ²⁾	V_F	$V_{Fmax} = 0.875 \cdot V_{L1-L3}$				
Max. field current, controlled	I_F [A]	15	30			
Power loss ³⁾	P_{loss} [W]	830	1220	2100	2850	3400
Ambient temperature in operation	T_{amb} [°C]	0...+35 ⁴⁾				
Weight approx.	[kg]	28	28	60	60	60

1) referred to a mains voltage of 3 · 400V~

2) The field is controlled as a current source, i.e. the field voltage depends on the field resistance.

3) at rated armature current

4) $T_u \leq 35^\circ\text{C}$: no power derating, $35^\circ\text{C} < T_{amb} \leq 45^\circ\text{C}$: power derating 1%/K

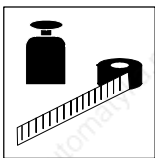

Technical Data

3.3.2 Mains voltage 500V (Variant V014)

- Controllers 4903 to 4907 (4Q controllers)

	Type	4903	4904	4905	4906	4907
	Order No.	EVD 4903-E-V014	EVD 4904-E-V014	EVD 4905-E-V014	EVD 4906-E-V014	EVD 4907-E-V014
Output power ¹⁾	P _{el} [kW]	13.1	28.8	57.7	105	131
Mains voltage	V _{mains}	3 · 410...550 V~ ±0%, 50...60 Hz				
Armature voltage	V _A	525 V if V _{mains} = 500V (1.05 · V _{mains})				
Rated armature current (continuous operation)	I _{Arated} [A]	25	55	110	200	250
Maximum current (short-time operation)	I _{Amax} [A]	45	90	150	240	300
Field voltage ²⁾	V _F	V _{Fmax} = 0.875 · V _{L1-L3}				
Max. field current, controlled	I _F [A]	3.5	10			
Power loss ³⁾	P _{loss}	108	185	288	577	650
Ambient temperature in operation	T _{amb} [°C]	0...+45				0...+35 ⁴⁾
Weight approx.	[kg]	13,1	13,8	18	22	23

- Controllers 4908 to 4913 (4Q controllers)

	Type	4908	4909	4911	4912	4913
	Order No.	EVD 4908-E-V014	EVD 4909-E-V014	EVD 4911-E-V014	EVD 4912-E-V014	EVD 4913-E-V014
Output power ¹⁾	P _{el} [kW]	173	262	367	525	630
Mains voltage	V _{mains}	3 · 410...550 V~ ± 0%, 50...60Hz				
Armature voltage	V _A	525 V if V _{mains} = 500 V (1.05 · V _{mains})				
Rated armature current (continuous operation)	I _{Arated} [A]	330	500	700	1000	1200
Maximum current (short-time operation)	I _{Amax} [A]	400	600	840	1200	1350
Field voltage ²⁾	V _F	V _{Fmax} = 0.875 · V _{L1-L3}				
Max. field current, controlled	I _F [A]	15	30			
Power loss ³⁾	P _{loss} [W]	840	1220	2100	2850	3400
Ambient temperature in operation	T _{amb} [°C]	0...+35 ⁴⁾				
Weight approx.	[kg]	28	28	60	60	60

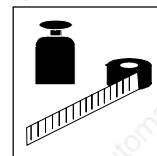

- Controllers 4808 to 4813 (4Q controllers)

	Type	4808	4809	4811	4812	4813
	Order No.	EVD 4808-E-V014	EVD 4809-E-V014	EVD 4811-E-V014	EVD 4812-E-V014	EVD 4813-E-V014
Output power ¹⁾	P_{el} [kW]	189	287	402	575	690
Mains voltage	V_{mains}	3 · 410...550 V~ ± 0%, 50...60Hz				
Armature voltage	V_A	575 V if $V_{mains} = 500 \text{ V} (1.15 \cdot V_{mains})$				
Rated armature current (continuous operation)	I_{Arated} [A]	330	500	700	1000	1200
Maximum current (short-time operation)	I_{Amax} [A]	400	600	840	1200	1350
Field voltage ²⁾	V_F	$V_{Fmax} = 0.875 \cdot V_{L1-L3}$				
Max. field current, controlled	I_F [A]	15	30			
Power loss ³⁾	P_{loss} [W]	830	1220	2100	2850	3400
Ambient temperature in operation	T_{amb} [°C]	0...+35 ⁴⁾				
Weight approx.	[kg]	28	28	60	60	60

1) referred to a mains voltage of 3 · 500V~

2) The field is controlled as a current source, i.e. the field voltage depends on the field resistance.

3) at rated armature current

4) $T_u \leq 35^\circ\text{C}$: no power derating, $35^\circ\text{C} < T_{amb} \leq 45^\circ\text{C}$: power derating 1%/K



Technical Data

3.4 Dimensions

3.4.1 Controller 4902 to 4X09

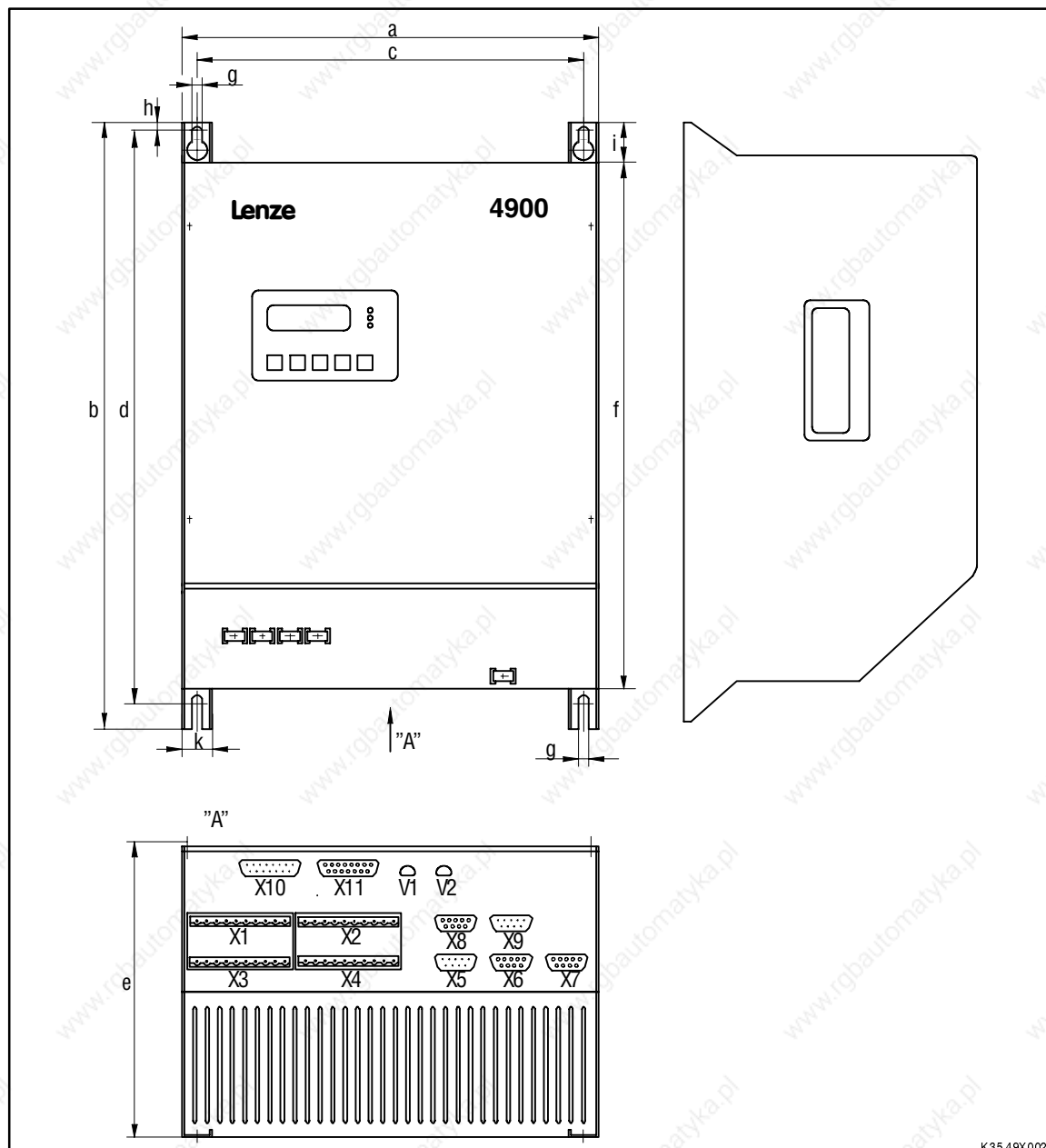
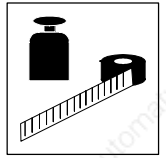

FIG 4-1 Dimensions of the controllers 4902 to 4907, 4X08 and 4X09

all dimensions in mm

Type	a	b	c	d	e	f	g	h	i	k	l
4902 / 4903 / 4904	269	415	242	395	222	360	6.5	8	30	26	175
4905 / 4906 / 4907	269	525	242	505	222	466	6.5	8	30	26	175
4808 / 4809 / 4908 / 4909	322	550	288	525	335	497	6.5	8	30	34	295



3.4.2 Controllers 4811 to 4813, 4911 to 4913

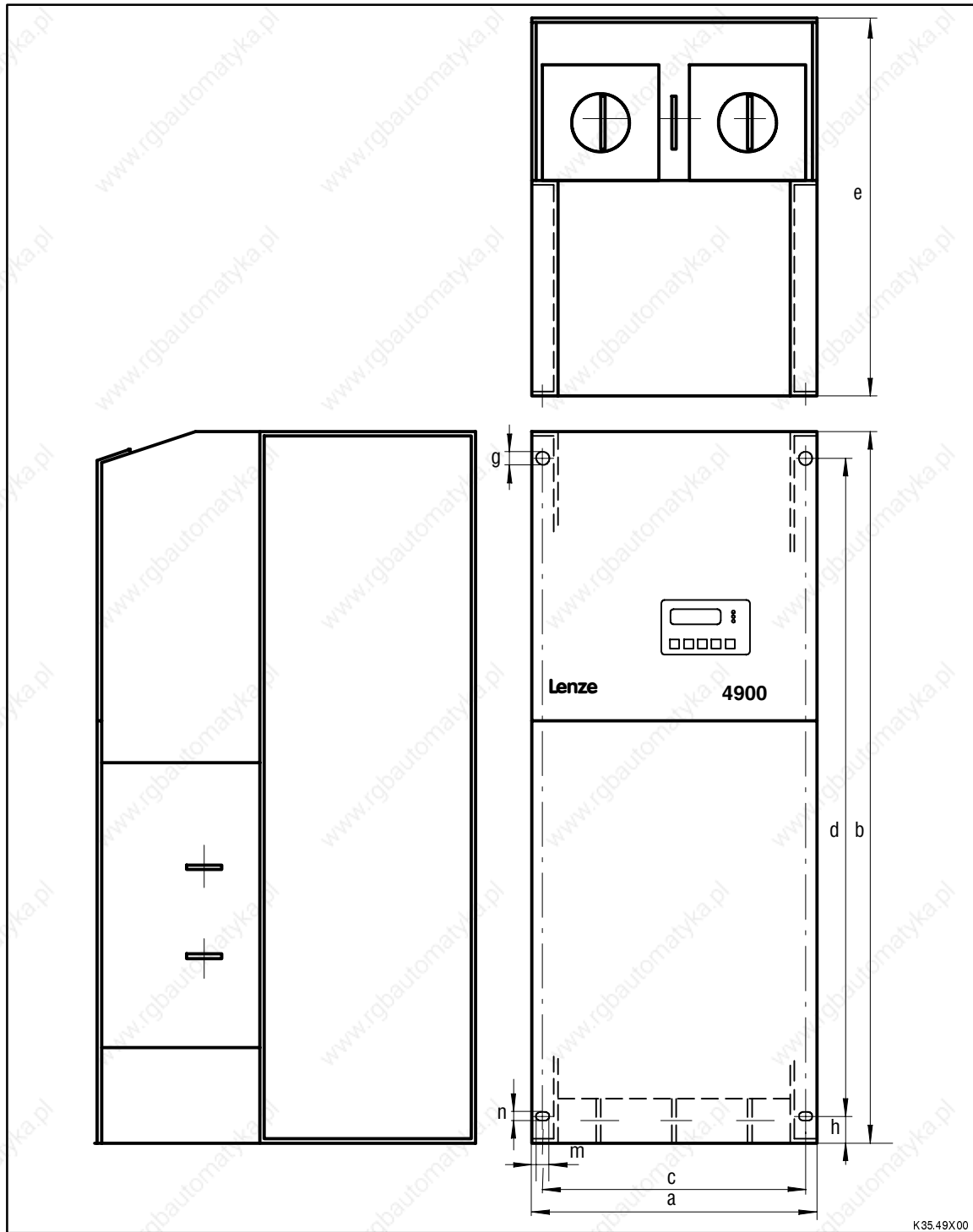
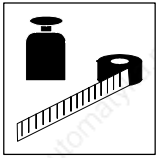

FIG 4-2 Dimensions of the controllers 4X11 to 4X13

all dimensions in mm

Type	a	b	c	d	e	g	h	m	n
4811 - 4813 / 4911 - 4913	322	800	292	740	390	9	30	15	9



Technical Data



4 Installation

4.1 Mechanical installation

4.1.1 Important notes

- Ensure free installation space above and below the controller:
 - 100 mm for 4902...4907
 - 150 mm for 4X08...4X13
- Ensure unimpeded ventilation of cooling air and outlet of exhaust air.
- If the cooling air contains pollutants (dust, fluff, grease, aggressive gases), which may impair the function of the controller:
 - Take suitable preventive measures, e.g. separate air duct, installation of filters, regular cleaning, etc.
- Do not exceed the ambient temperature permissible during operation:
 - 4902...4906: to 45 °C: without power derating
 - 4907, 4X08...4X13: to 35 °C: without power derating
35 °C to max. 45 °C: power derating 1% / K

Possible mounting positions

- Only vertical controller installation:
 - 4902 ... 4907, 4X08 and 4X09 with mains connections on top
 - 4X11 ... 4X13 with mains connections at bottom



Installation

4.2 Electrical installation

For information on the installation according to EMC, see chapter 4.4

4.2.1 Protection of persons

- Protection of persons and animals according to DIN VDE 0100 with current-operated protective devices:
The inverters are equipped with a mains rectifier. After a short-circuit to frame, a DC fault current may prevent the tripping of the current-operated protective device. Additional measures, such as protective multiple earthing or universal current sensitive current-operated e.l.c.b., should therefore be taken.
- When dimensioning the tripping current of the current-operated e.l.c.b. it must be observed that false tripping may occur under the following conditions:
 - In the event of capacitive leakage currents between the cable screens (especially with long screened motor cables).
 - If several controllers are connected to the mains at the same time.
 - If you use RFI filters.
- Comment on the application of universal-current sensitive current-operated e.l.c.b.:
The preliminary standard prEN50178 (previously VDE0160) on the application of universal-current sensitive current-operated e.l.c.b. has passed the German Committee K226.
The final decision about this standard will be made by CENELEC/CS (European Committee for Electrotechnical Standardization) in Brussels. For further information on the application of universal-current sensitive current-operated e.l.c.b., can be obtained from the supplier.
- Replace defective fuses with the prescribed type only when no voltage is applied. The fuses protect the controller from impermissible operating conditions. After tripping, the controller or the system should be checked for possible faults or errors before replacing the fuse.
- The controller can be safely disconnected from the mains via a contactor on the input side.

Electrical isolation

There is an electrical isolation (insulating distance) between power and control terminals:

- The reference potential GND of the control electronics is connected to PE via a bridge (bridge to X4; term. 90 →term. FE)
- The control electronics has a basic isolation (single insulating distance).
- The protection against contact, if the insulating distance is defective, can only be ensured by additional measures.

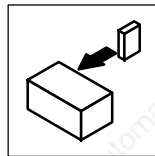

4.2.2 Protection of the controller



Stop!

The controllers contain electrostatically sensitive components: Prior to assembly and service operations, the personnel must be free of electrostatic charge, e.g. by touching the PE fixing screw or other grounded metal surfaces in the control cabinet.

- In the event of condensation, connect the controller to the mains voltage only after the visible humidity has evaporated.
- The controllers are designed for operation with a neutral earth mains voltage.
- For separate supply of the field controller:
 - Ensure correct phase connection of the terminals L1.1 and L3.1. The PEN conductor must never be connected!
- The power outputs of the controller for the armature circuit (A, B) and the field circuit (I, K) must only be disconnected when no voltage is applied.
- Use the prescribed semiconductor fuses to protect the thyristors in the power stage (see chapter 9.1).
- For speed control with incremental encoder:
 - Only use incremental encoders with pulse tracks shifted by 90°.
- For speed control with tacho:
 - Only use DC tacho generators.

4.2.3 Screening of the control cables

Wire the screening and the GND and PE connections very carefully to avoid interference. Interference in the control cables can interrupt operation, because it disturbs the controller program (fault message 'CCr').

- Screening of control cables.
 - Connect the screen of the control cables to the screen connections of the controller or via the isolated earthing bus in the control cabinet (e.g. PE terminals).
- Prevent breaks in the screening:
 - In the event of interruption, screening must be connected to protective buses (terminal strips, relays, fuses).
 - Low-resistance connection between buses (at least 10 mm²) and PE of the supply.
- Control cables must not be installed parallel to motor cables carrying interference.
 - If it is not possible to ensure an installation distance between control and motor cables, the motor cables should be screened.



Installation

4.2.4 Earthing of the control electronics

Single drives

- With factory setting, the reference potential GND of the control electronics is joined to PE. Additional earthing measures are not required.

Group drives

- Ensure that earthing the control electronics does not cause any damage to external controllers.
- Ensure to avoid ground loops when the ground is connected (GND):
 - Remove the bridge to X4 from terminal 90 to terminal FE.
 - All ground cables must be connected to externally isolated buses which are as close to the controllers as possible.
 - Make a low-resistance connection between the buses (at least 10 mm²) and PE of the supply.

4.2.5 Mains types and conditions

Please observe the restrictions for each mains type!

Mains	Operation of the controller	Notes
With grounded neutral	No restrictions	Observe controller ratings
With grounded phase	Operation is impossible.	
With isolated neutral (IT mains)	Operation with the recommended RFI filter is only possible if an isolating transformer is preconnected. The neutral of the secondary circuit must be earthed secondarily.	Contact Lenze. The RFI filter will be destroyed when directly connected to the IT mains and fault "earth fault".

Interaction with compensation equipment

For reactive-power compensation of mains with an inverter controller load, the compensation unit should be equipped with a choke, since the controller generates harmonic currents. These harmonic currents could excite oscillating circuits which consist of mains impedance and capacitor reactance. Capacitors, transformers, switching units, etc. could be destroyed by these reactance effects.

In this case, please contact the supplier of your compensation equipment.

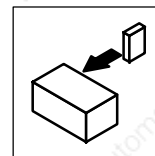

4.3 Connection

Connection between controller and motor

Lenze controller			Motor (to DIN 42017/VDE 0530 part 8)		
Function		Terminal	Terminal	Others	Motor type
Armature voltage	+	A	1B1	A1	DC motor uncompensated with commutating winding
	-	B	2B2	B2, A2	
Excitation voltage	+	I	F1	F5, (for higher connection voltages)	
	-	K	F2	F2	
Armature voltage	+	A	1C1	A1	DC motor compensated with commutating winding
	-	B	2C2	C2	
Excitation voltage	+	I	F1	F5, (for higher connection voltages)	
	-	K	F2	F2	
Armature voltage	+	A	A1		Permanent-magnet motor
	-	B	A2		
DC tachometer	+	3	2A1		
	-	4	2A2		
Temp. switch			S1, S2		
Thermal contact			T1, T2		

Screw-tightening torques

Type	4902	4903 - 4904	4905 - 4907	4X08 - 4X09	4X11 - 4X13
L1, L2, L3, A, B	0.5 ... 0.6 Nm	2.0 ... 2.4 Nm	37 Nm ¹⁾		64 Nm ¹⁾
A, B			37 Nm ¹⁾	15 ... 20 Nm	
L1.1, L3.1, I, K	0.5 ... 0.6 Nm			1.2 ... 1.5 Nm	
L1.2, L2.2, L3.2	0.5 ... 0.6 Nm				
L1.3, L2.3, L3.3, 86 - 89	-			0.5 ... 0.6 Nm	
Terminal strip X1 - X4	0.5 ... 0.6 Nm				

- 1) Rated tightening torque for the connection of terminal ends to busbars
(VDE 0220 part 1/11.71)
When continued as busbar see DIN 43673 part 1/02.82

The following circuit diagrams show the electrical wiring of the power connections.



Installation

4.3.1 Power connection

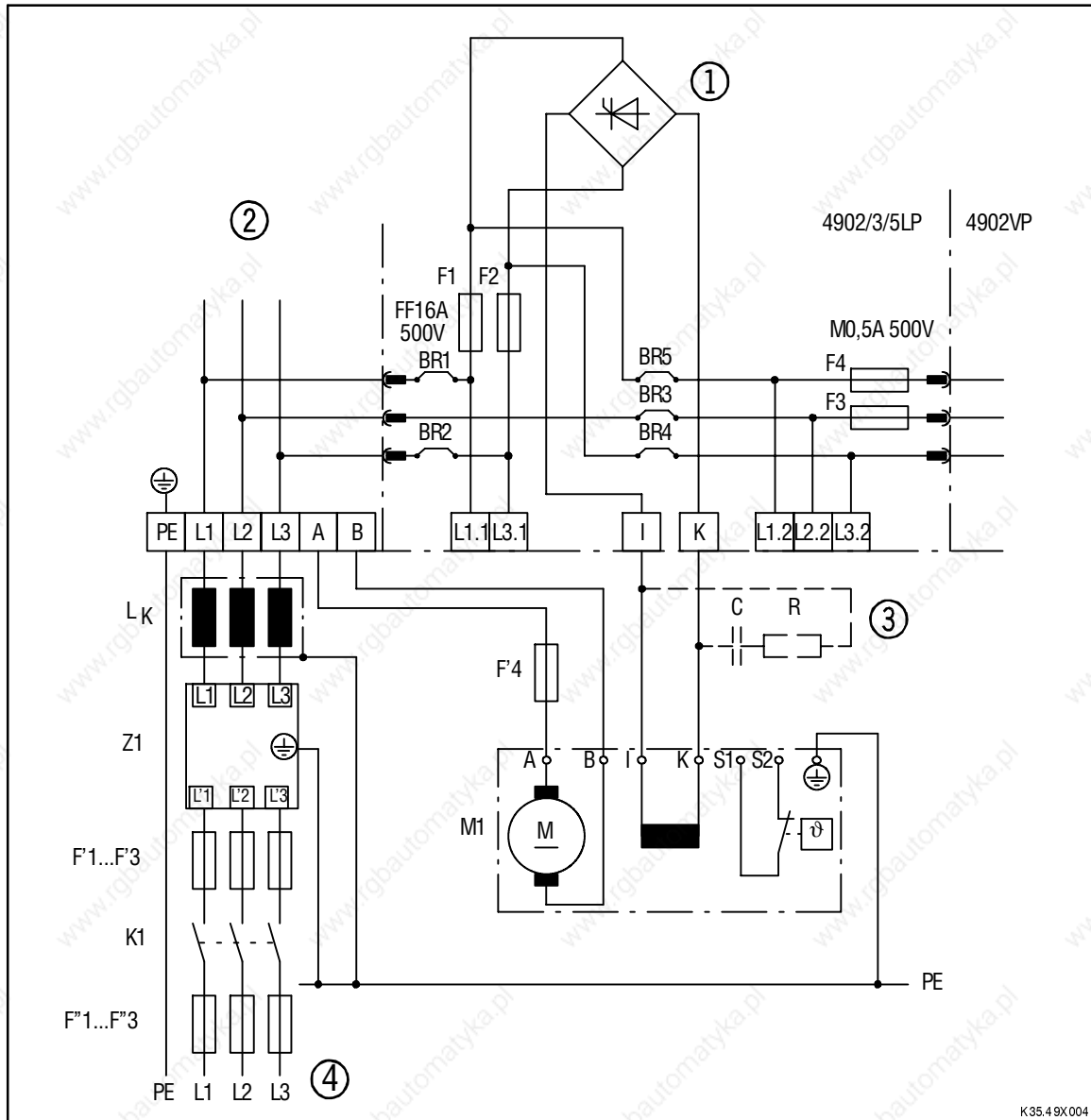

FIG 4-3 Power connection of controllers 4902 to 4907

- | | |
|----------------|---|
| K1 | Mains contactor |
| F1...F4 | Semiconductor fuses for controller protection |
| F'1...F'3 | Line protection fuses |
| L _k | Commutating choke (mains choke) |
| Z1 | RFI filter |
| BR1 - BR5 | 0Ω wire bridge |
| ① | Field controller |
| ② | Power stage |
| ③ | Auxiliary starting circuit |
| ④ | For the connection voltage see Rated Data |

With field voltages > 300V and field currents < 200mA an auxiliary starting circuit should be used.
Recommended dimensioning: R = 330 Ω/ 20 W; C = 0.22 μF/400V AC.

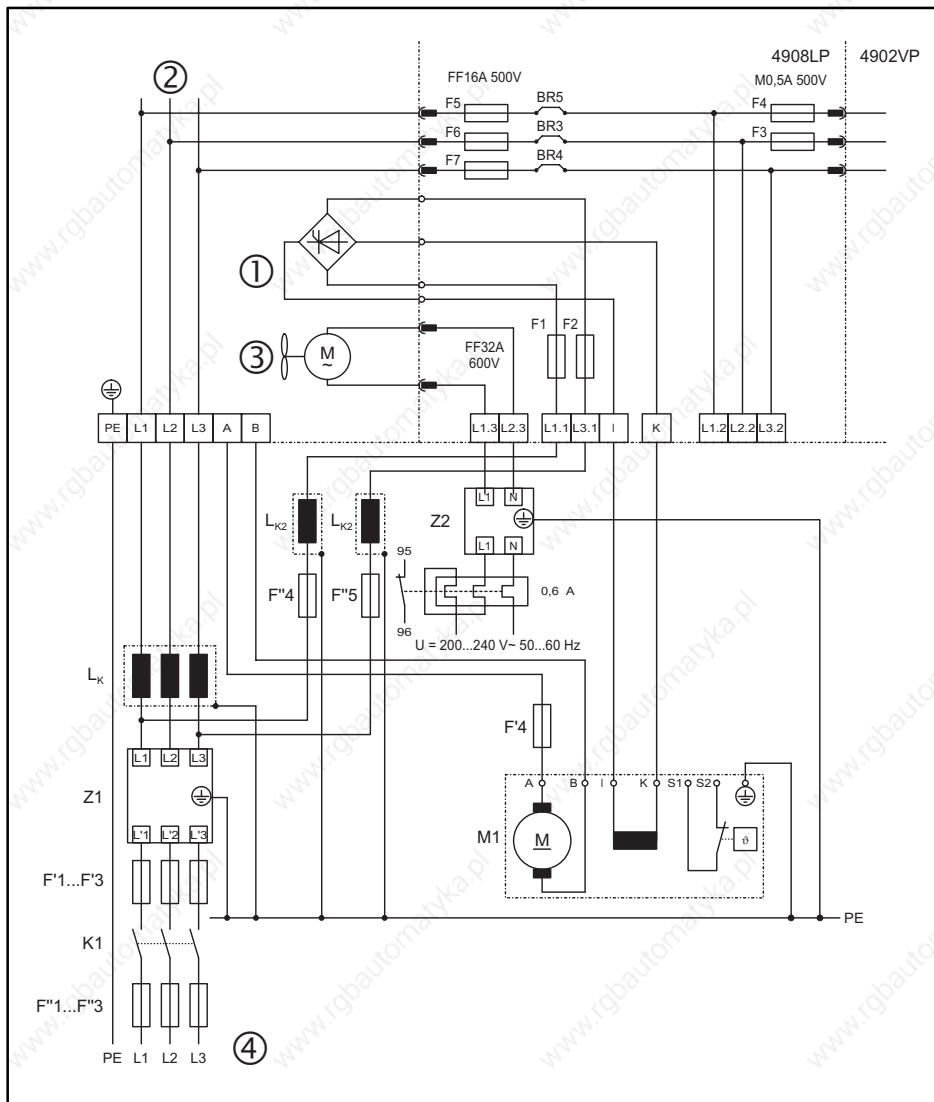
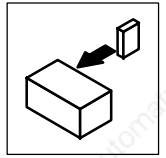
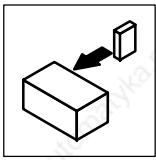

FIG 4-4 Power connection of controllers 4X08 to 4X09

- K1 Mains contactor
- F'1...F'4 Semiconductor fuses for the protection of controllers
- F"1...F"5 Line protection fuses
- L_k Commutating choke (mains choke)
- Z1 RFI filter
- Z2 RFI filter for separate ventilation
- BR3 - BR5 0Ω wire bridge
- ① Field controller
- ② Power stage
- ③ Fan
- ④ For the connection voltage see Rated Data



Installation

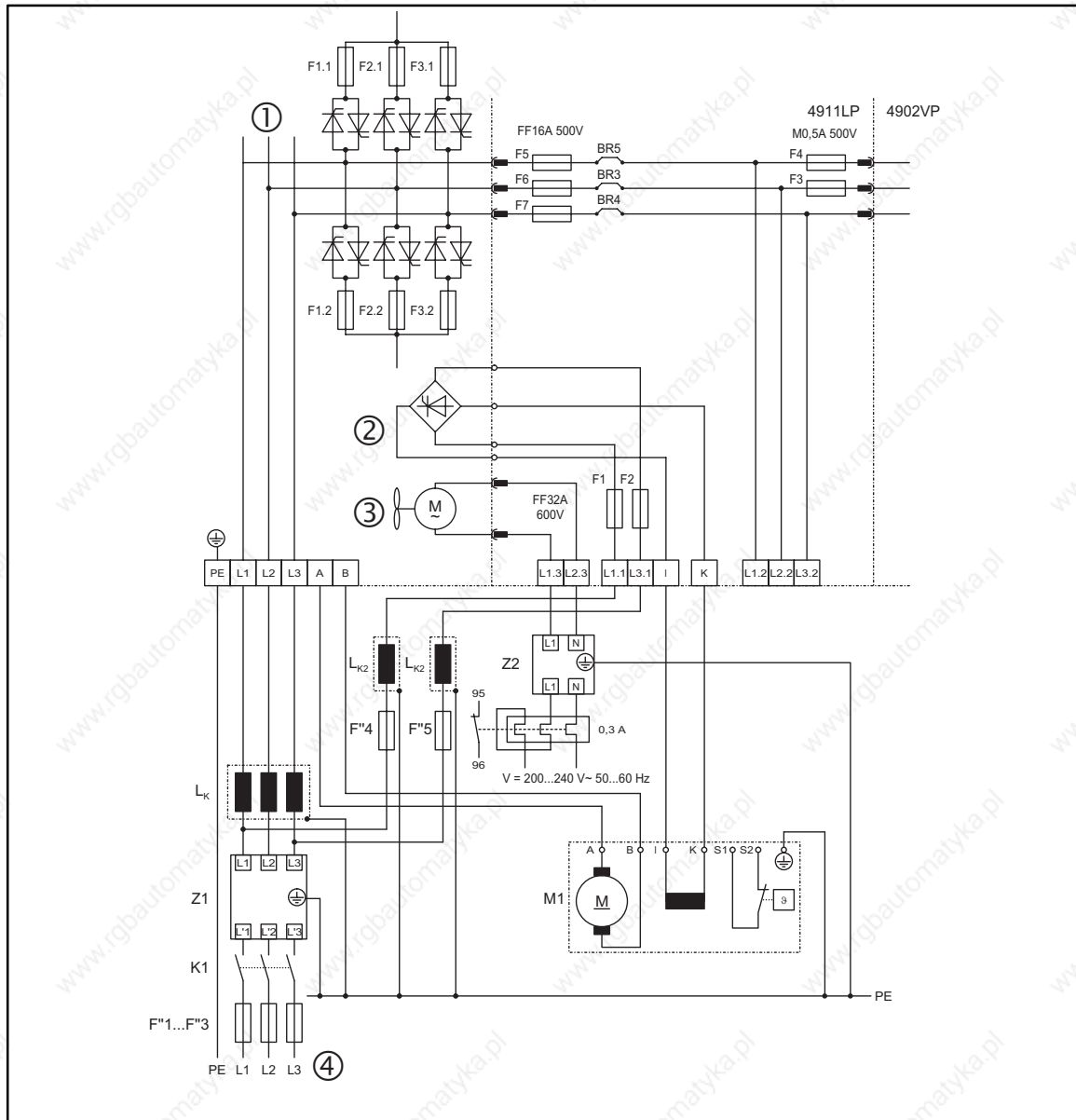

FIG 4-5 Power connection of controllers 4X11 to 4X13

- | | |
|----------------|---|
| K1 | Mains contactor |
| F1.1 ... F3.2 | Semiconductor fuses for controller protection |
| F'1...F'5 | Line protection fuses |
| L _k | Commutating choke (mains choke) |
| Z1 | RFI filter |
| Z2 | RFI filter for separate ventilation |
| BR3 - BR5 | 0Ω wire bridge |
| ① | Power stage |
| ② | Field controller |
| ③ | Fan |
| ④ | For the connection voltage see Rated Data |

It is not necessary to protect mains and armature cables by semiconductor fuses, because the thyristors are already protected by internal cell fuses.



4.3.2 Separate supply of the field-current bridge at a high motor field voltage



Stop!

Ensure correct phase connection of the separate field supply.

Incorrect connection leads to blown fuses.

The phase shift of the voltages from the power stage to the control electronics must be smaller than 2° (electrically).

To reduce the mains feedback, separate mains chokes are required for the field supply.

The fuses F"4 and F"5 are cable protection fuses. They must be matched to the cross section of the cables used and dimensioned for at least $I_{F_{rated}}$.

In weak mains supplier, field-current fluctuations may occur and thus the torque can be reduced. For rated field voltages $V_{F_{rated}} > 210V$, we recommend a separate supply for the field bridge.

The armature current control circuit and the field current control circuit are electrically decoupled by an external supply for the field controller with voltage pick-off before the mains choke.

Remove the wire bridges BR1 and BR2 of the controllers 4902 to 4907 (4902LP, 4903LP or 4905LP) when no voltage is applied. The bridges can be easily accessed:

1. Open the controller cover (4 mounting screws)
2. Unbolt the 2 mounting screws for the cover of the control electronics
3. Open the cover.

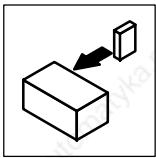

Installation

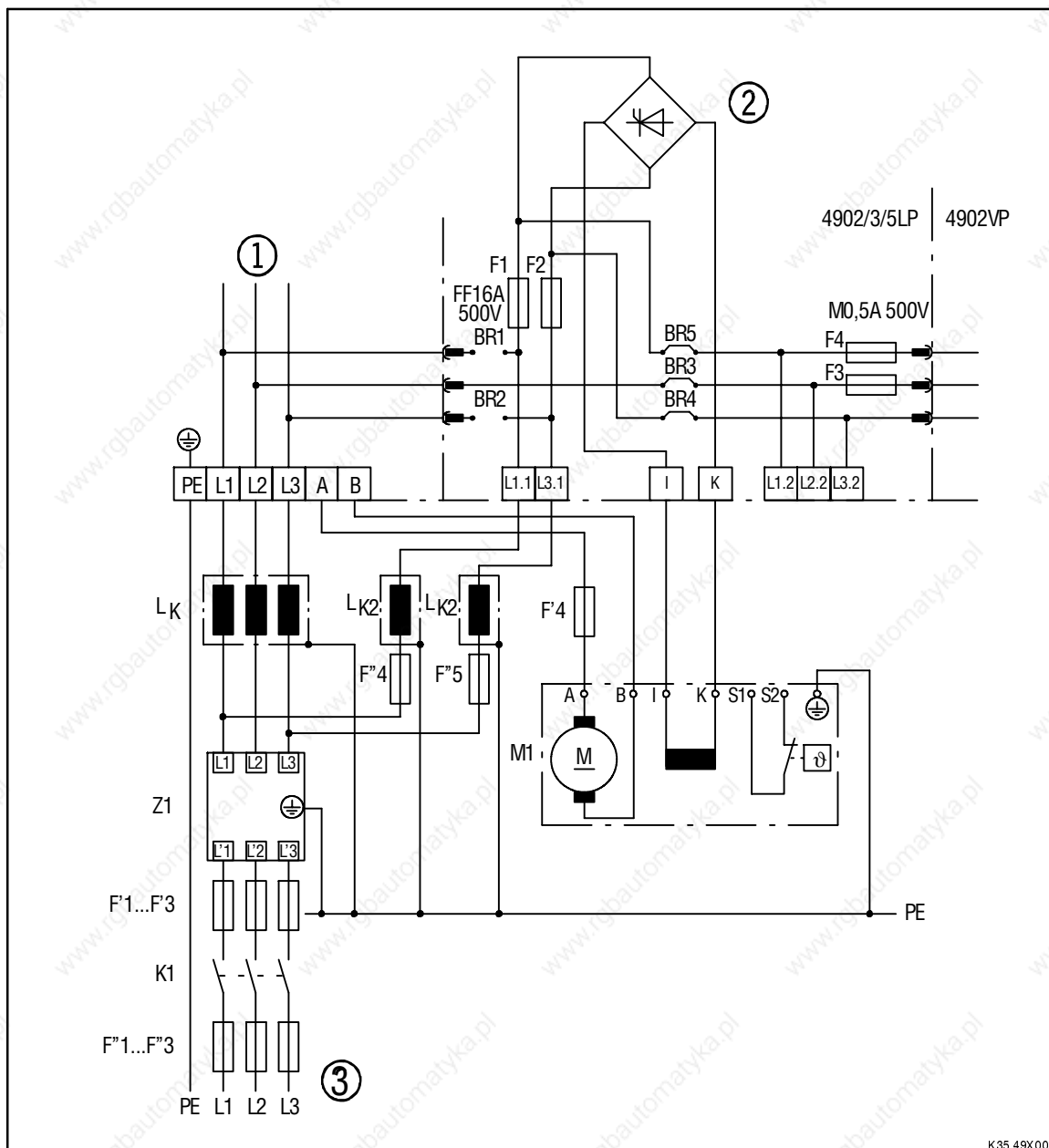

FIG 4-6 Power connection for controllers 4902 to 4907

K35.49X007

- | | |
|----------------|---|
| K1 | Mains contactor |
| F'1...F'4 | Semiconductor fuses for controller protection |
| F'1...F'5 | Line protection fuses |
| L _K | Commutating choke (mains choke) |
| Z1 | RFI filter |
| BR3 - BR5 | 0Ω wire bridge |
| ① | Power stage |
| ② | Field controller |
| ③ | For the connection voltage see Rated Data |



4.3.3 Separate supply for the control electronics



Stop!

Ensure correct phase connection of the separate mains supply. Incorrect connection leads to blown fuses.

- The phase shift of the voltages from the power stage to the control electronics must be smaller than 2° (electrically).
- The controller must be inhibited via the function "Controller enable" (Ctr. enable) before the contactor can be opened or closed. If the switching sequence is not observed, the fuses will blow or fault messages ACI or FCI will be indicated.
- The electronics remains supplied after K1 has been opened. The mains is completely separated via the main switch.



Installation

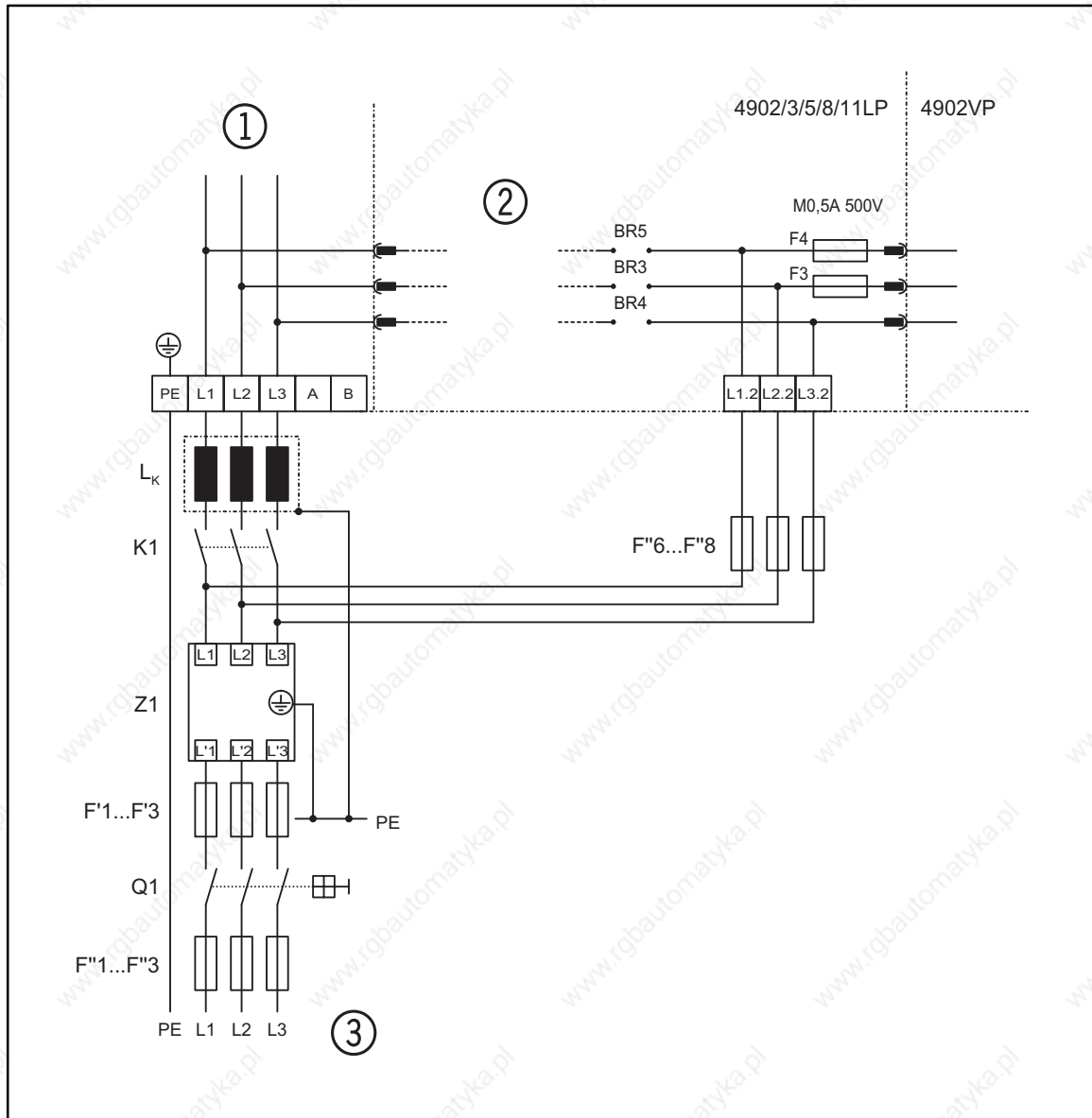
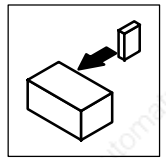

FIG 4-7 Power connection for controllers 4902 to 4907 and 4X08 to 4X13

- | | |
|----------------|---|
| K1 | Mains contactor |
| F'1...F'3 | Semiconductor fuses for controller protection |
| F''1...F''3 | Line protection fuses |
| F''6...F''8 | Cable protection fuses 4A |
| L _k | Commutating choke |
| Z1 | RFI filter |
| Q1 | Main switch |
| ① | Power stage |
| ② | Field controller |
| ③ | For the connection voltage see Rated Data |



4.3.4 Control connections

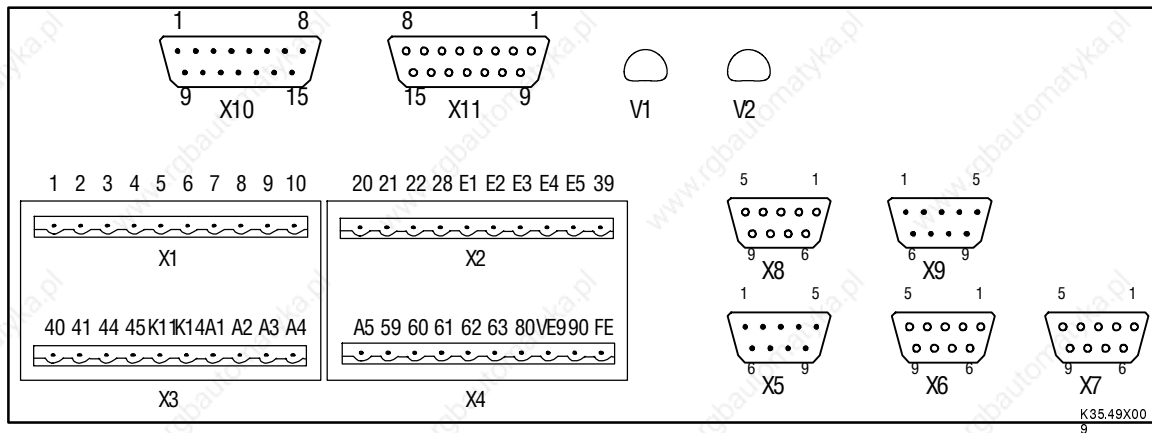

FIG 4-8 Control connections for the controller

X1 - X4	Control terminals
X5	Digital frequency/incremental encoder input (Dig_In_1)
X6	LECOM1 interface (RS 232 / 485)
X7	Resolver connection
X8	Digital frequency output
X9	Digital frequency/incremental encoder input (Dig_In_2)
X10, X11	Fieldbus connections (as option e.g. 2110 for InterBus)
V1, V2	Displays for fieldbus options (option)

Switch on the control module

Some function of inputs and outputs can be changed via the switches on the control module 4902MP. For settings ensure

- that no voltage is applied
- the cover is removed (4 mounting screws)

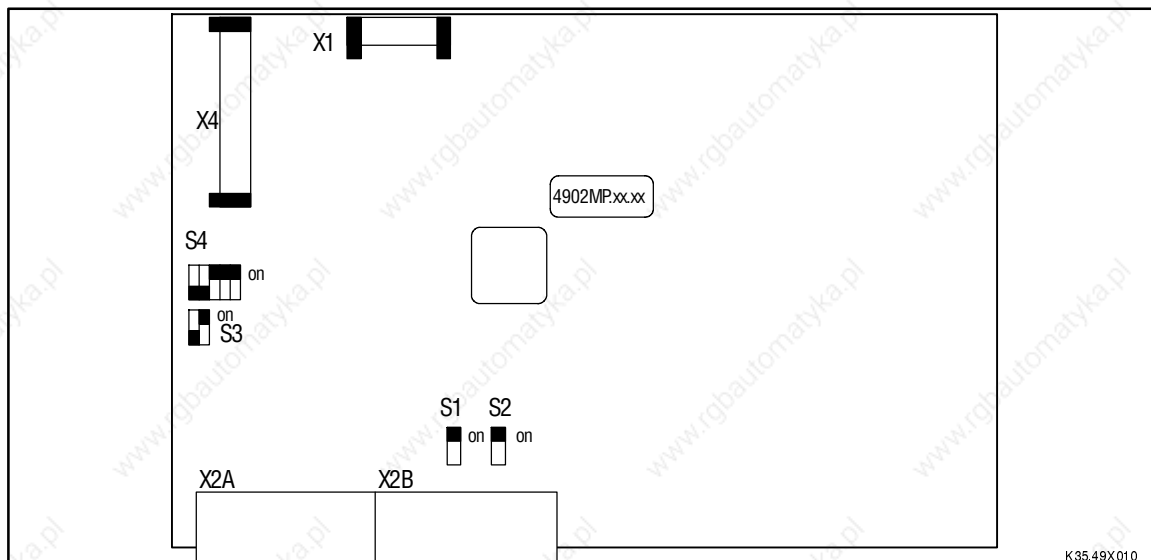

FIG 4-9 Positions of switches S1 to S4 on the control module



Installation

4.3.4.1 Connection of analog signals

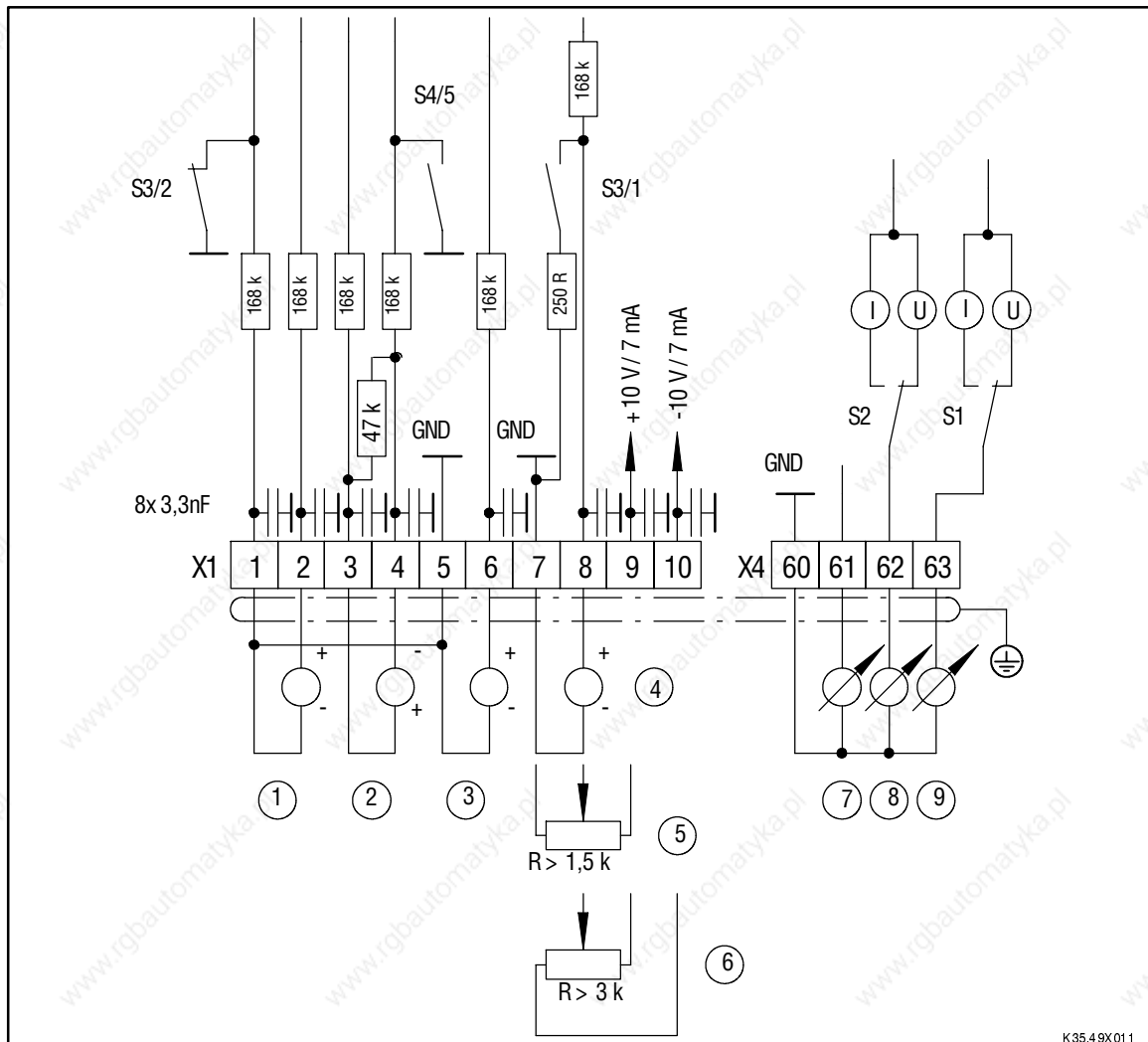
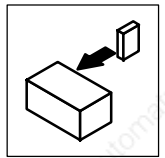

FIG 4-10 Analog inputs and outputs

1	External torque limitation	Setpoint 2	Analog input
2	Actual value signal with tacho feedback		
3	Additional setpoint	Setpoint 3	
4	Main setpoint as digital master voltage/current	Setpoint 1	
5	Main setpoint as unipolar setpoint		Monitor output
6	Main setpoint as bipolar setpoint		
7	Armature current I_{act}		
8	Current setpoint C063		
9	Actual speed value C051		

The analog signals are contacted via the terminal blocks X1 and X4. FIG 4-10 shows the function assignment according to factory setting.







Analog inputs

Terminal	Switch position	Use	Level	Resolution
1, 2	S3 ON OFF	Setpoint 2 with ground reference (factory setting)	-10V...+10V	12 bit + sign
	S3 ON OFF	Setpoint 2 differential input	-10V...+10V	12 bit + sign
3, 4	S4 ON OFF	Actual value	-10V...+10V	12 bit + sign
	S4 ON OFF	Actual value	-30V...+30V	12 bit + sign
	S4 ON OFF	Actual value	-60V...+60V	12 bit + sign
	S4 ON OFF	Actual value (factory setting)	-73V...+73V	12 bit + sign
	S4 ON OFF	Actual value	-90V...+90V	12 bit + sign
	S4 ON OFF	Actual value	-99V...+99V	12 bit + sign
	S4 ON OFF	Actual value	-120V...+120V	12 bit + sign
	S4 ON OFF	Actual value	-180V...+180V	12 bit + sign
	S4 ON OFF	Actual value with ground reference		12 bit + sign
	S4 ON OFF	Actual value differential input ¹⁾		12 bit + sign
6		Setpoint 3 with ground reference	-10V...+10V	12 bit + sign
7		Internal ground, GND		
8	S3 ON OFF	Setpoint 1, Master voltage (factory setting)	-10V...+10V	12 bit + sign
	S3 ON OFF	Setpoint 1, Master current	-20mA...+20mA -20 mA...-4 mA +4 mA...+20 mA	
9		Voltage supply for	+10V/7mA	
10		Setpoint selection via potentiometer	-10V/7mA	



Installation

Analog outputs (monitor outputs)

Terminal	Switch position	Use	Level	Resolution
60		Internal ground, GND		
61		Actual current value	-5 V...+5 V correspond to the rated current of the controller	
62	S2 	Monitor 1 Output voltage(factory setting)	-10V...10V	11 bit
	S2 	Monitor 1 Output current	-20mA...+20mA	11 bit
63	S1 	Monitor 2 Output voltage(factory setting)	-10V...+10V	11 bit
	S1 	Monitor 2 Output current	-20mA...+20mA	11 bit

- 1) For changing the factory setting of switch S4, jumper 5 to ON (actual value with ground reference), observe the following:
- Bridge terminals 4 and 5 externally.
 - Set DIP switch S4, jumper 1-4 (preselected actual value) to double tacho voltage.

The max. possible tacho voltage is 90 V!

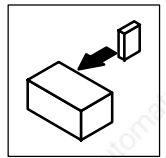

4.3.4.2 Connection of digital signals

- All digital inputs and outputs are PLC compatible and separated from the rest of the control module when operated with an external voltage supply (24 V).
- The diagrams show the function assignments according to the factory setting.
- For switching the signal cables, only relays with contacts for low-level switching should be used.
We recommend using relays with gold contacts.
- Voltage supply
 - external 24 V to terminals X2/39 and X4/59 or
 - internal 15 V to terminal X2/20



Stop!

- Maximum permissible load of the internal 15 V supply : 100 mA.
- For operation with internal voltage: Bridge terminals X2/39 and X3/40 externally.
- Digital inputs unused should be connected!

Inputs:

Input voltage	0...+30 V LOW level: HIGH level:	0...+5 V +13...+30 V
Input current:	24 V: 15 V:	8 mA per input 5 mA per input

Outputs:

Output current:	Max. 50 mA per output (external resistance min. 480Ω at 24V, e. g. relay, Order designation EK0005)
-----------------	---

The input and output signals are in average read, processed and updated every 4 msec on average.

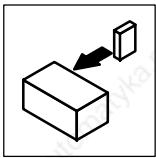

Installation

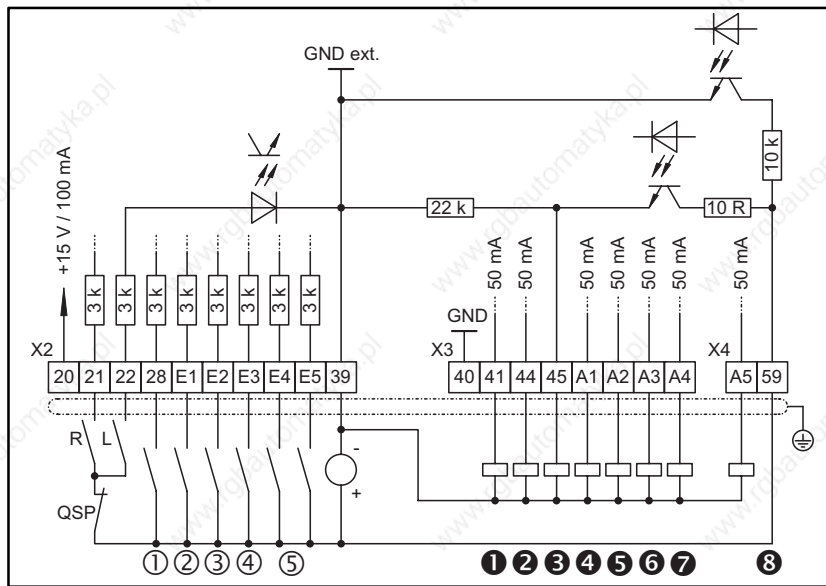

FIG 4-11 Digital inputs and outputs with external voltage supply (24 V)

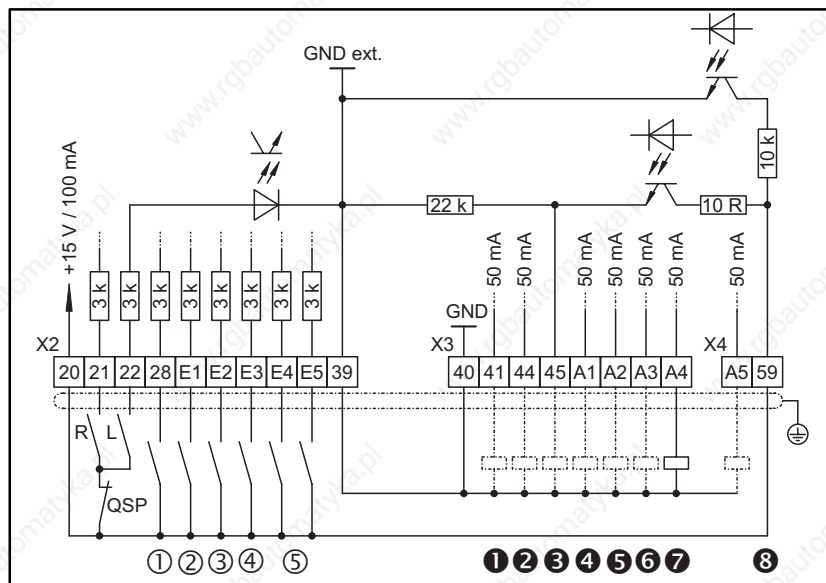
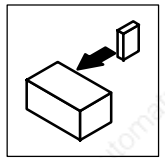

FIG 4-12 Digital inputs and outputs with internal voltage supply (15 V)



Digital inputs

Name	Terminal	Use (factory setting)	Level for activation	Programming see chapter
	20	Voltage supply 15V, 100mA		
CW	21	Removal of quick stop, CW rotation	HIGH	
CCW	22	Remove quick stop, CCW rotation	HIGH	
①	28	Controller enable - Ctrl. enable	HIGH	
②	E1	Freely assignable input (TRIP set)	HIGH	
③	E2	Freely assignable input (TRIP reset)	HIGH	
④	E3	Freely assignable input (Inhibit additional setpoint)	HIGH	
⑤	E4, E5	Freely assignable input (Enable JOG values, three JOG values)	HIGH	

Digital outputs

Name	Terminal	Use (factory setting)	Message		Programming see chapter
			1)	2)	
	39	Ground of the digital inputs and outputs, external GND			
	40	Internal ground, GND			
①	41	TRIP	HIGH	LOW	
②	44	Ready for operation - RDY	HIGH	HIGH	
③	45	Pulse inhibit - IMP	HIGH	LOW	
④	A1	Freely assignable output ($n_{act} < n_x$)	HIGH	LOW	
⑤	A2	Freely assignable output (n-controller = M_{max})	LOW	HIGH	
⑥	A3	Freely assignable output (Setpoint reached, $RFG_{output} = RFG_{input}$)	HIGH	HIGH	
⑦	A4	Freely assignable output ($n_{act} = 0$)	HIGH	LOW	
⑧	A5	Freely assignable output ($n_{act} = n_{set}$)	HIGH	HIGH	
	59	Supply input of the digital outputs: 24 V external or 15 V internal			

1) Message in stationary controller operation

2) Message, if the function is active



Installation

Relay output

	Terminal	Use (factory setting)
	K11, K14	Floating relay output, contact load capacity: 50V / 0.5A (TRIP)

Additional digital inputs and outputs with 4X08...4X13

The controllers 4X08...4X13 are equipped with additional control terminals to monitor the fuses. The following current flow charts show the factory setting of the internal wiring and give suggestions on how to include an external fuse monitoring.

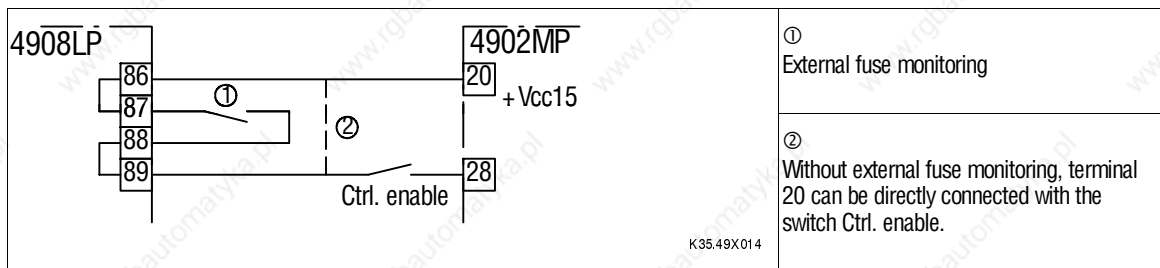

FIG 4-13 4808...4809 and 4908...4909

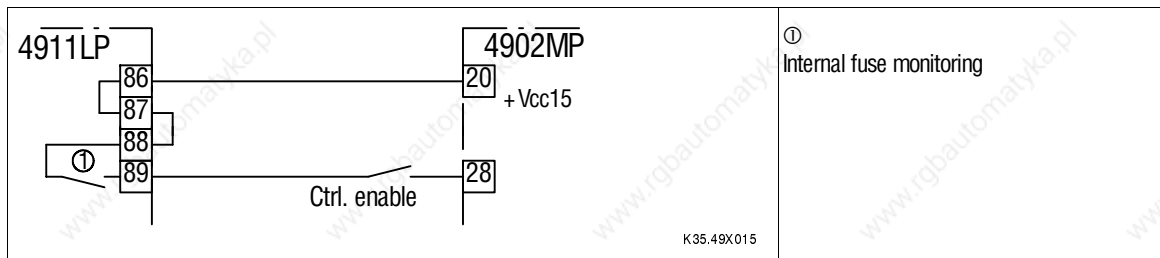

FIG 4-14 4811...4813 and 4911...4913

For monitoring, the terminals 86 and 89 should be connected in series with the controller enable contact Ctrl. enable.

- For internal voltage supply (15 V), bridge the following terminals:
 - X2/20 to 86
 - X2/28 to 89
- For external voltage supply (24 V):
 - Apply supply voltage to terminal 86.
 - Bridge terminals 28 and 89.



Danger! (especially for hoist applications)

Please observe when connecting the fuse monitoring:
No torque is generated when the controller is inhibited.

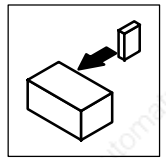

4.3.5 Feedback systems

Several feedback systems can be connected to the controller and configured:

- Armature voltage control
- DC tacho feedback
- Resolver feedback
- Encoder feedback
 - Incremental encoder TTL
 - Incremental encoder HTL

DC tacho feedback

Tacho signals are connected via term. 3/4 of terminal block X1. The controller processes rated tacho voltages of 10...180V (chapter 4.3.5.1).

Resolver feedback (X7)

- 2-pole resolver ($V = 10\text{ V}$, $f = 5\text{ kHz}$)
- Connection to a 9-pole Sub D socket X7
 - We recommend using the pre-assembled Lenze system cable.
- Resolver cable and resolver are monitored for wire breakage (fault message "Sd2")

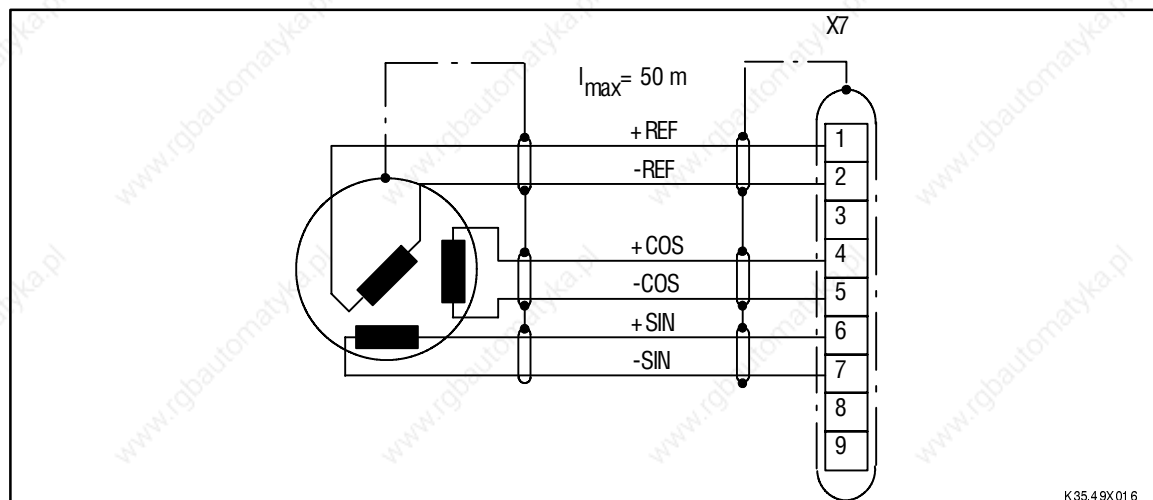
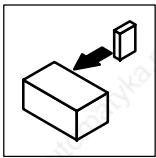

FIG 4-15 Resolver connection (9-pole Sub D socket)

Pin assignment of socket X7:

Pin	1	2	3	4	5	6	7	8	9
Signal	+ REF	-REF	GND	+COS	-COS	+SIN	-SIN	---	---
Cross section	0.5		0.14						



Installation

The resolver signal or encoder signal can be output for following drives at the digital frequency output X8.

- Connection as shown in the connection diagrams:
 - Use cables twisted and screened in pairs.
 - Connect both screen ends.
 - Use cable cross-sections indicated.
- The feedback system can be activated under C005.
- If resolvers are used which are not specified by Lenze are used, contact your Lenze representative.

Incremental encoder feedback

- Incremental encoders with two 5 V complementary signals electrically shifted by 90° (TTL encoders) or HTL encoders can be connected.
- Connection to a 9-pole Sub D socket X5 or X9, depending on the configuration of C005
 - Maximum input frequency: 420 kHz with TTL encoder
100 kHz with HTL encoder
 - Current consumption per channel: 6 mA
- With HTL signal:
 - If there is no inverse track available, the inputs \bar{A} and \bar{B} (with zero track also \bar{Z}) must be connected to the encoder supply potential.

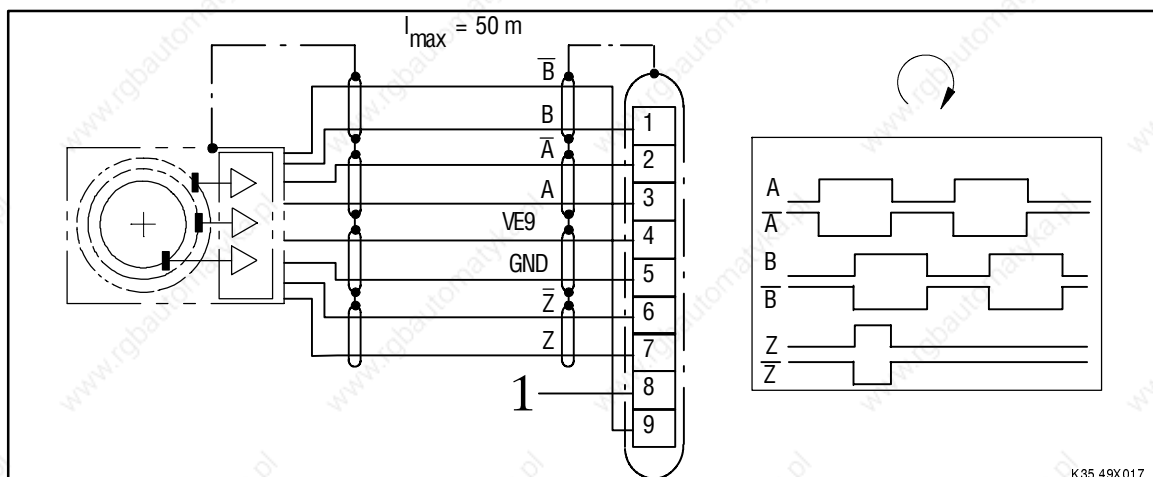
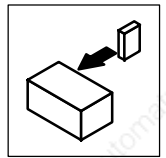

FIG 4-16 Incremental encoder connection (9-pole Sub D socket)



Pin assignment of socket X5/X9:

Pin	1	2	3	4	5	6	7	8	9
Signal	B	A	A	VE9	GND	Z	Z	LC	B

Pin 8, LC (1)

- For encoders without lamp control, assign +5 V...+30V. Otherwise, the controller will indicate fault "Sd3" or "Sd4".

Pin 4, VE9

- Is connected to the terminal of the external incremental encoder supply X4/VE9.

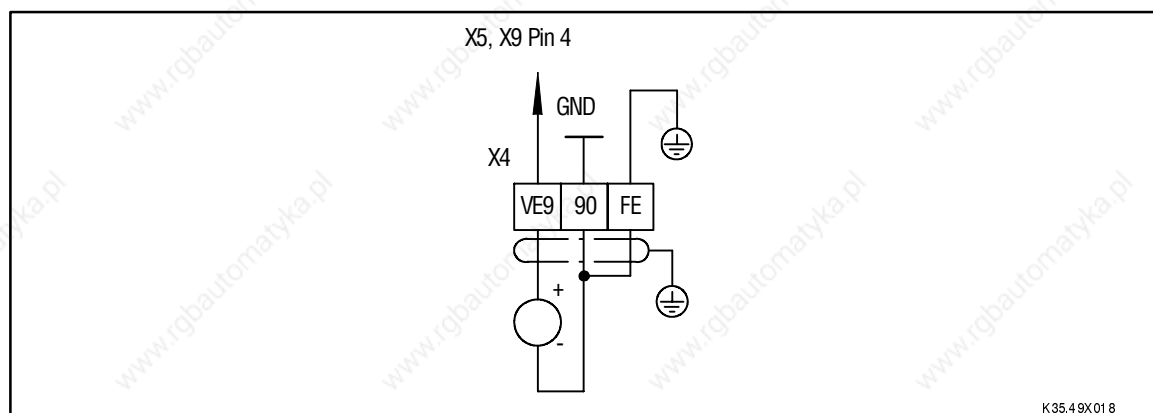

FIG 4-17 Connection of the incremental encoder supply

VE9	External supply for incremental encoder to X5/X9
90	Internal ground GND
FE	Functional earth

4.3.6 Change of the direction of rotation in 2Q operation

In 2Q operation (controller 48XX or C180 = -1-), only one thyristor bridge of the controller is active, i.e. the output terminal A can only carry positive voltage referred to terminal B, on the condition that no active loads occur.

The direction of rotation of the motor is determined by the connection of the armature cable to A and B and of the field cable to I and K. If the opposite direction of rotation is required, take the following steps (depending on the actual value feedback system):

Act. speed feedback system	Direction of rotation changed by:	Additional measures
Armature voltage	Exchange connection: • Terminals A and B or • Terminals I and K	None
Tacho		Connection tacho signal exchange term. 3 and 4
Resolver		Signal cable resolver exchange track + sin and -sin
Incremental encoder		Signal cable incremental encoder exchange tracks A and B and tracks \bar{A} and \bar{B}



Installation

4.3.7 Digital frequency selection and encoder emulation

Digital frequency input

- Possible digital frequency signals:
 - Incremental encoder with two 5 V complementary signals electrically shifted by 90° (TTL encoders) or HTL encoder
 - Encoder emulation of the host (master)
- Connection to a 9-pole Sub D socket X5 or X9, depending on the configuration of C005
 - max. input frequency: 420 kHz for TTL encoders
 100 kHz for HTL encoders
 - Current consumption per channel: 6 mA

Digital frequency selection via the digital frequency output of the master drive

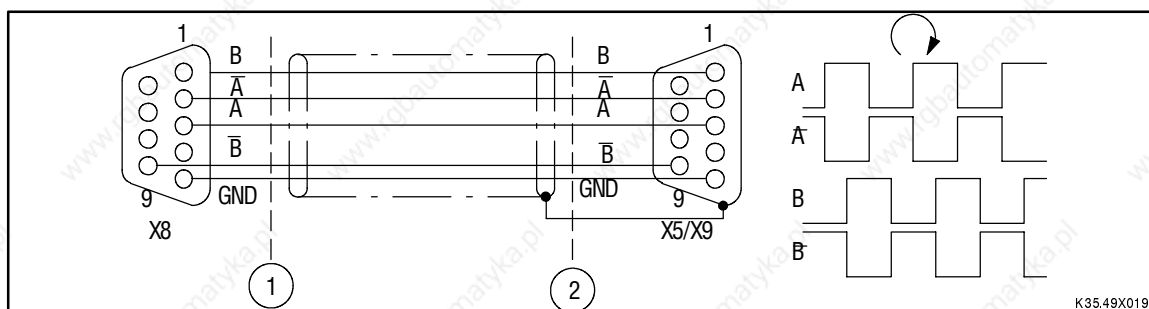

FIG 4-18 Digital frequency selection for the slave 2 via digital frequency output (master 1)

Pin assignment of socket X5/X9:

Pin	1	2	3	4	5	6	7	8	9
Signal	6.5	Ā	A	VE9	GND	Z	Z	LC	B

Pin 8, LC (lamp control of the encoder):

- With digital frequency coupling, pin 8 is deactivated in the factory setting (configuration C005= -5X-, -6X-, -7X-)

Pin 4, VE9

- Is connected to the terminal of the external incremental encoder supply X4/VE9.

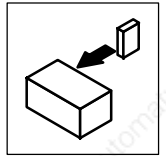

Digital frequency output / encoder emulation

The output signal of the Sub-D socket X8 can be used for the feedback of actual values for superimposed control circuits (synchronous running, digital frequency coupling or positioning control). Depending on the configuration under C005, it is assigned as a digital frequency output or as an output for the encoder emulation.

Features:

- Two 5V complementary signals (TTL signal), electrically shifted by 90°
- Current capacity 20mA per channel
- Current capacity at PIN 8 (+5V): max. 5mA

The output signal is internally derived from the resolver or incremental encoder signal.

	Resolver feedback	Incremental encoder feedback
Resolution	2048 increments per revolution	Constant of the incremental encoder
Signal type		

FIG 4-19 Signal of digital frequency or encoder output X8 assignment of plug X8

Pin assignment of socket X8:

Pin	1	2	3	4	5	6	7	8	9
Signal	B	A	A	NC	GND	Z	Z	+5V	B



Note!

If fault messages occur at the encoder monitoring during resolver feedback to superimposed systems:

- Exchange tracks A and B
- Use inverse tracks



Installation

4.3.8 Serial interface RS232/485



Danger!

The interface RS232C/RS485 is single basic isolated, i.e. an additional electrical isolation (double basic insulation) to VDE 0106, part 1, (protection against electric shock) and to VDE 0160 (reduction of interference) is required for host connection.

- LECOM-A: with 2 Lenze level converters 2101IB connected to the host or another RS 232C electrical isolation.
LECOM-B: with Lenze level converter 2101IB connected to the host
LECOM-LI: no additional electrical isolation required

Ensure electrical isolation of the voltage supply!

The controllers can communicate with the host (PLC or PC) via the serial interface LECOM1 or an operating keypad that works according to the LECOM protocol.

The LECOM1 interface (X6) processes the LECOM-A/B protocol. The LECOM-A/B protocol is based on the standard ISO 1745 and can be used with up to 90 controllers. It detects faults and avoids the transmission of faulty data.

Controllers to standard RS232C (LECOM-A) or RS485 (LECOM-B) can be connected to the LECOM1 interface. The interface can be used for parameter setting, monitoring, analysis and simple control tasks.

With the RS232C interface, it is possible to create point-to-point connections with a cable length of up to 15 m. Most PCs or other hosts are equipped with this interface.

For multiple drives and distances >15m, use the RS485 interface. With only 2 wires it is possible to connect up to 31 controllers and communicate over a cable length of max. 1,200 m.

Pin assignment of socket X6:

Pin	Name	Input/output	Explanation
1	+VCC15	Output	Supply voltage +15V / 50mA
2	RxD	Input	Receive data cable RS232C
3	TxD	Output	Transmit data cable RS232C
4	DTR	Output	Transmission control RS232C
5	GND		Controller reference potential
6	DSR	Input	(not used) RS232C
7	T/R (A)	Output/input	RS485
8	T/R (B)	Output/input	RS485
9	+VCC5	Output	Supply voltage +5V

The baud rate can be changed under C125 (1200/2400/4800/9600 baud).

Protocol: LECOM-A/B V2.0



4.3.9 Fieldbus connection



Note!

Special features of the controller variants V011 and V013:

1. The interface module 2110IB or 2130IB is integrated into the controller.
2. In the factory setting, the controllers are prepared for the separate mains supply of power stage and control electronics:
 - The bridges BR3, BR4, BR5 are not installed!

- Variant V011 with InterBus interface module

The interface module type 2110IB connects Lenze controllers with the fast serial communication system InterBus. The module enables the highly dynamic transfer of process data (e. g. setpoints and actual values) and access to all parameters of the controller according to the DRIVECOM profile.

The InterBus communication is based on a ring concept. All bus participants are required for communication. For applications which require a volt-free power stage, a separate mains supply must be provided to ensure communication (see chapter 4.3.3).

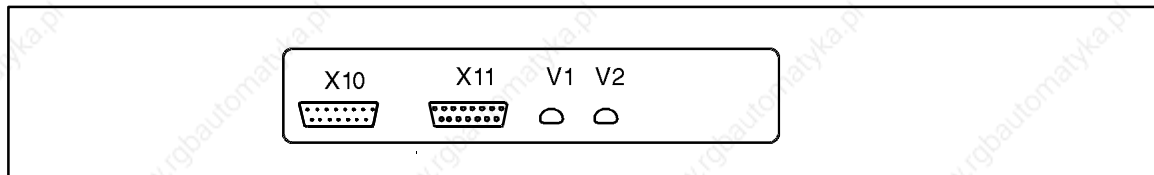
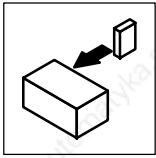

FIG 4-20 Front view 2110IB

X10	Input InterBus peripheral bus
X11	Output InterBus peripheral bus
V1	LED green, bus supply
V2	LED yellow, communication



Installation

- Variant V013 with PROFIBUS interface module

The interface module type 2130IB connects Lenze controllers to the fast serial communication system PROFIBUS. With PROFIBUS it is possible to parameterize and control a controller via a host.

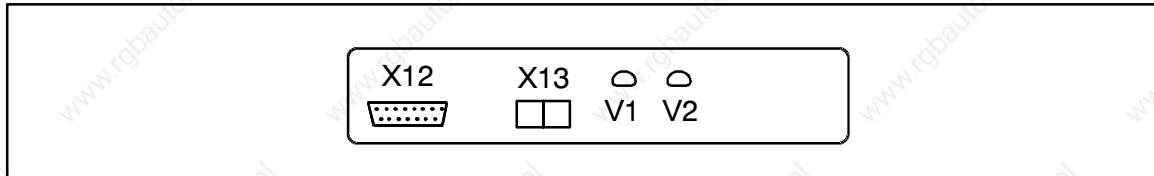
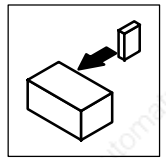

FIG 4-21 Front view 2130IB

Connection	Explanations	
X12	RS485 bus connection	9-pole SubD socket
X13-W30	Optical fibre receiver	(only 2130IB, V002)
X13-W31	Optical fibre sender	(only 2130IB, V002)
V1	2130IB supply	OFF: Module is not supplied. Controller is switched off or connection is interrupted(X4). ON: Module is supplied.
V2	Communication 2130IB	OFF: No supply or 2130IB and controller not yet initialised. ON: Module 2130IB and basic unit are initialised but the PROFIBUS-DP communication is still not working. FAST BLINKING (4x per second): PROFIBUS-DP communication with user data SLOW BLINKING (1x per second): PROFIBUS-DP communication initialised

If the interface module 2130IB is no longer supplied, the bus system will not stop working. However, the connected controller cannot be addressed by the host.

If necessary, the control stage of the controller should be supplied separately (see chapter 4.3.3).



4.4 Installation of a CE-typical drive system

4.4.1 General notes

- The electromagnetic compatibility of a machine depends on the type of installation and care taken. Please observe:
 - Assembly
 - Filters
 - Screening
 - Grounding
- For diverging installations, the conformity to the CE EMC Directive requires a check of the machine or system regarding the EMC limit values. E.g. with:
 - the use of unscreened cables
 - the use of group RFI filters instead of the assigned RFI filters
 - Operation without mains choke
 - Multi-motor drive systems

The user of the machine is responsible for compliance with the EMC Directive.

If you observe the following measures, you can assume that the machine will operate without any EMC problems caused by the drive system, and that compliance with the EMC Directive and the EMC law is achieved.

If devices which do not comply with the CE requirement concerning noise immunity EN 50082-2 are operated close to the controller, these devices may be interfered electromagnetically by the controllers.

Because of the earth-potential reference of the RFI filters, the CE-typical drive systems which are described are not suitable for the connection to IT-mains (mains without earth-reference potential).

For the use of 48XX/49XX drive systems in residential areas observe the following:

- Check that the radio interference suppression level at the supply to the site of operation complies with the standard (EN55022 class B).
- Check that the permissible level for radio interference (EN55022 class B) is not exceeded around the site of operation.



Installation

4.4.2 Components of the CE-typical drive system

System component	Specification
Controller	4800/4900 DC controllers
RFI filter	For data and filters see the Manual 4800/4900
Mains choke	For assignment and technical data see the Manual 4800/4900
Armature and field cable	Unscreened power cable Rated max. length: 50m
Control cables	Screened signal cable type LIYCY
Encoder cable for digital frequency	Lenze system cable or screened signal cable, twisted in pairs, tin plated E-CU braid with 75% optical overlay
Encoder cable for resolver	Lenze system cable type EMLR or screened signal cable, twisted in pairs, tin plated E-CU braid with 75% optical overlay
Motor	Separately excited DC motor Lenze series MGFQ, MGFR or similar
Accessories	InterBus module 2110IB Profibus module 2130IB

Controller, RFI filter and mains choke are mounted on the same assembly board inside a standard control cabinet.

4.4.3 Measures required

Control cabinet assembly board

- For HF grounding, only use mounting plates with an excellent conductive surface (e.g. zinc-coated surface).
- If you use mounting plates with badly conductive surfaces (e.g. painted, anodized, yellow passivated):
 - Remove the paint or coating from the contact surface of the mains filters, controllers, and screen connections, to provide a large and conductive connection.
- When using several mounting plates, connect them with a surface as large as possible (e.g. using copper bands).
- Connect the controller, RFI filter and mains choke to the grounded mounting plate with a surface as large as possible.

Power connection

- Avoid unnecessarily long cables
- Ensure the separation of motor cable and signal or mains cable.
- Ensure separation of unscreened and screened cables (distance > filter length)
- Ensure a distance as short as possible between the conductors (single-cores)
- Both ends of unused cores should be connected to ground/PE.

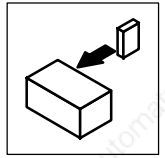

Signal cables

- Always screen digital and analog signal cables.
 - Always connect the signal cables over the shortest possible distance with the screen connections provided at the controller:
 - Connect both screen ends of digital signal cables.
- If potential differences are to be expected, lay an additional compensation cable.
- For long signal cables, provide additional screening points:
 - Connect the screen at the control cabinet input with a suitable clamp to the conductive mounting plate of the control cabinet.

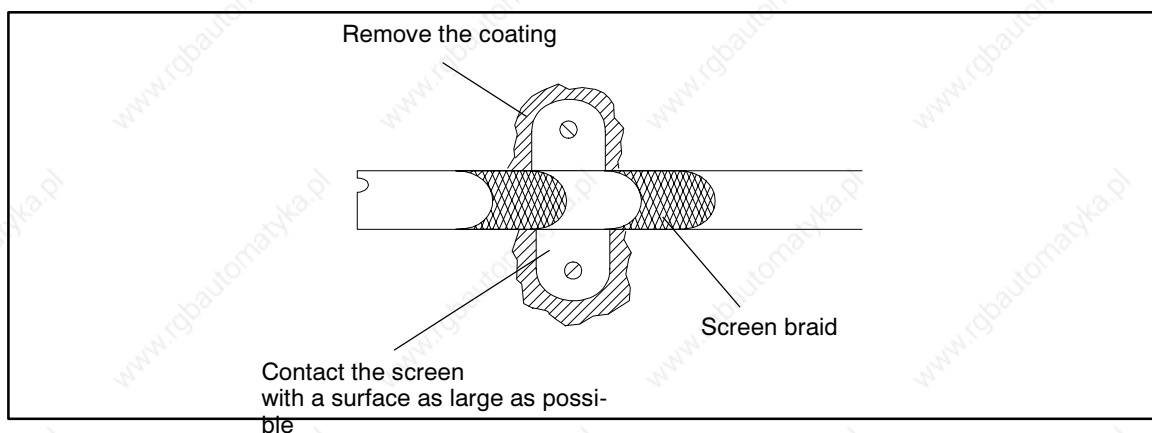

FIG 4-22 Additional screening connection on a mounting plate of the control cabinet

Filters

- Only use the mains filters and RFI filters which are designated for the controller:
 - RFI filters reduce impermissible high-frequency interference to a permissible value.
 - Mains chokes reduce low-frequency interference which depend on the motor cable and its length.

Screening

Wire the screening and the GND and PE connections very carefully, to avoid interference.

- All signal cables should be screened.
- Avoid a common terminal board for mains input and motor output.
- Route cable as close as possible to the reference potential. Free-hanging cables have the same effect as aerials.



Installation

Grounding

- Ensure a good equipotential bonding of all system parts (controller, RFI filter, mains choke, etc.) by cables to a central earthing bus (PE busbar). The prescribed minimum cross-sections must be observed in all cases.
- To comply with the EMC Directive, not the cross-section but the contact surface is decisive.
- Ensure that grounding of the control electronics does not cause any damage to external controllers.

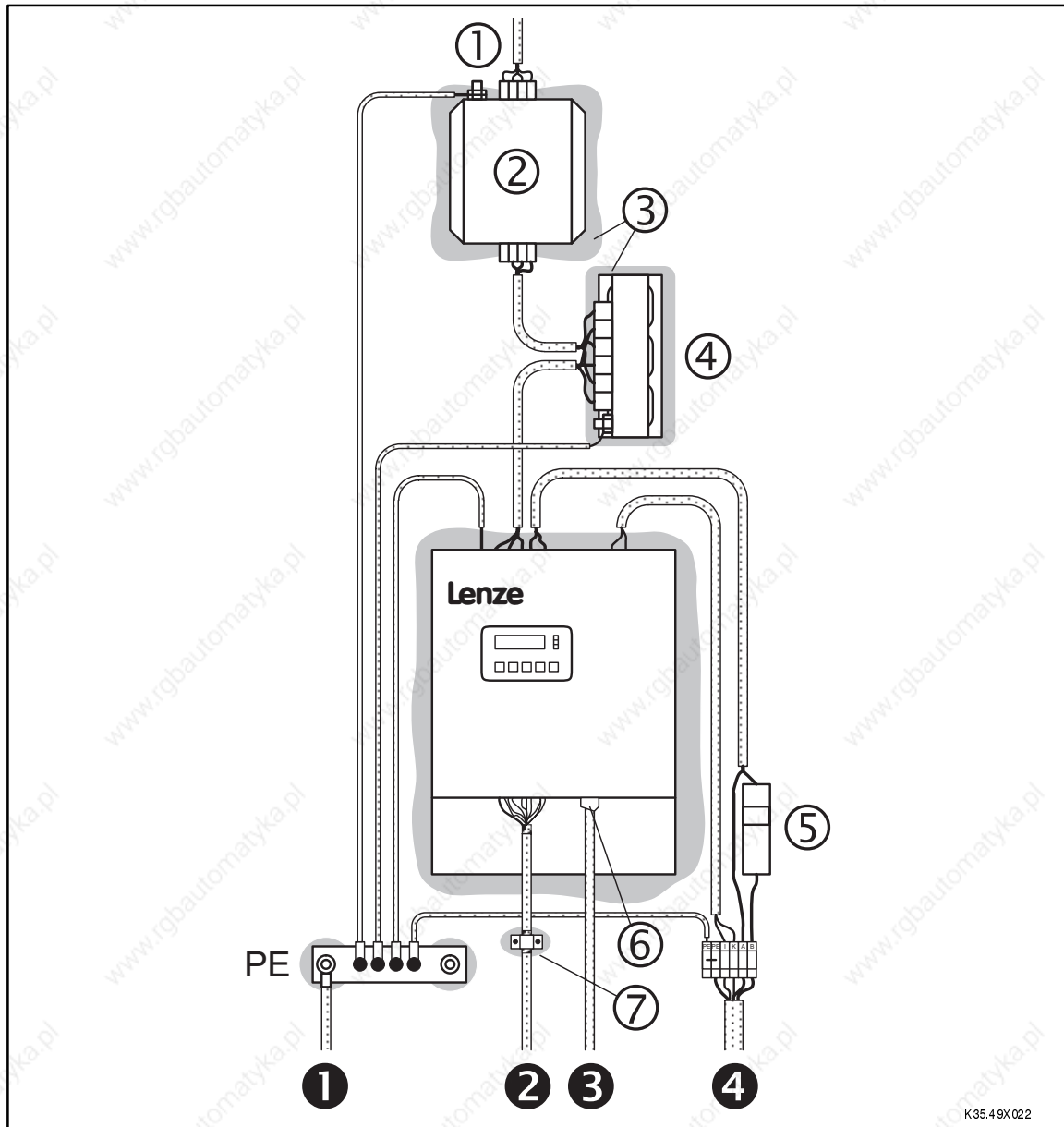

FIG 4-23 Part of the CE-typical drive system with 4902 ... 4907 on a mounting plate

- ① Connection mains fuse
- ② RFI filter
- ③ Uncoated, bare metal contact surfaces
- ④ Commutating choke
- ⑤ Armature fuse
- ⑥ Metal plug-in casing connected to screen or Lenze system cable
- ⑦ Uncoated surface for screen connection
- Ⓟ PE connection
- ② Screened signal cables
- ③ Screened cables for act. value encoder or setpoint encoder
- ④ Motor connection



Installation

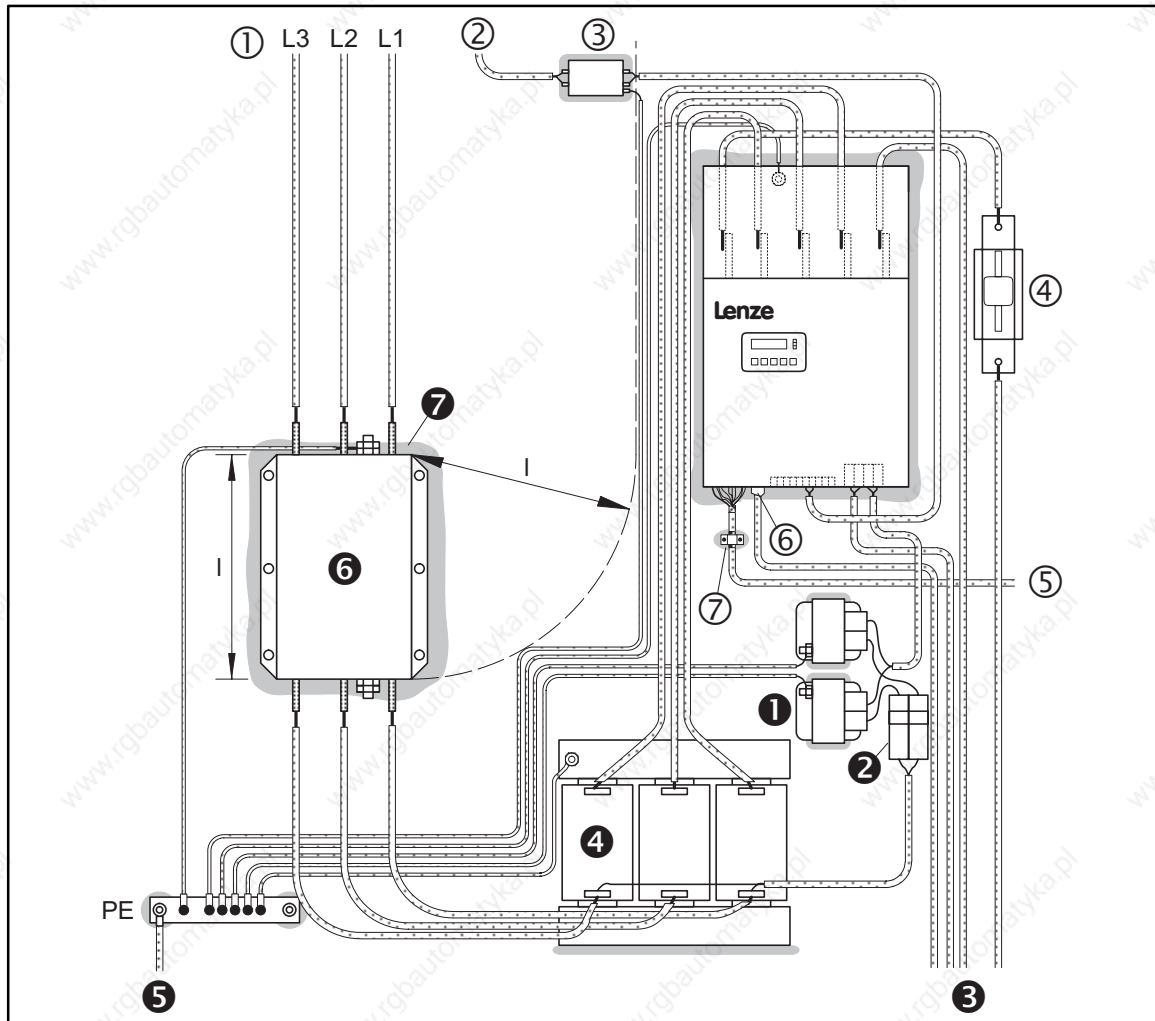

FIG 4-24 Part of the CE-typical drive system with 4X08/4X09 on a mounting plate

- ① Connection mains fuse
- ② Connection fan supply L1/N
- ③ RFI filter
- ④ Armature fuses
- ⑤ Screened signal cables
- ⑥ Metal plug-in casing connected to screen or Lenze system cable
- ⑦ Uncoated surface for screen connection
- ① Mains choke field supply
- ② Line protection fuses for field supply
- ③ Motor connection with screened cable for act. value encoder
- ④ Commutating choke
- ⑤ PE connection
- ⑥ RFI filter
- ⑦ Uncoated, bare metal contact surfaces

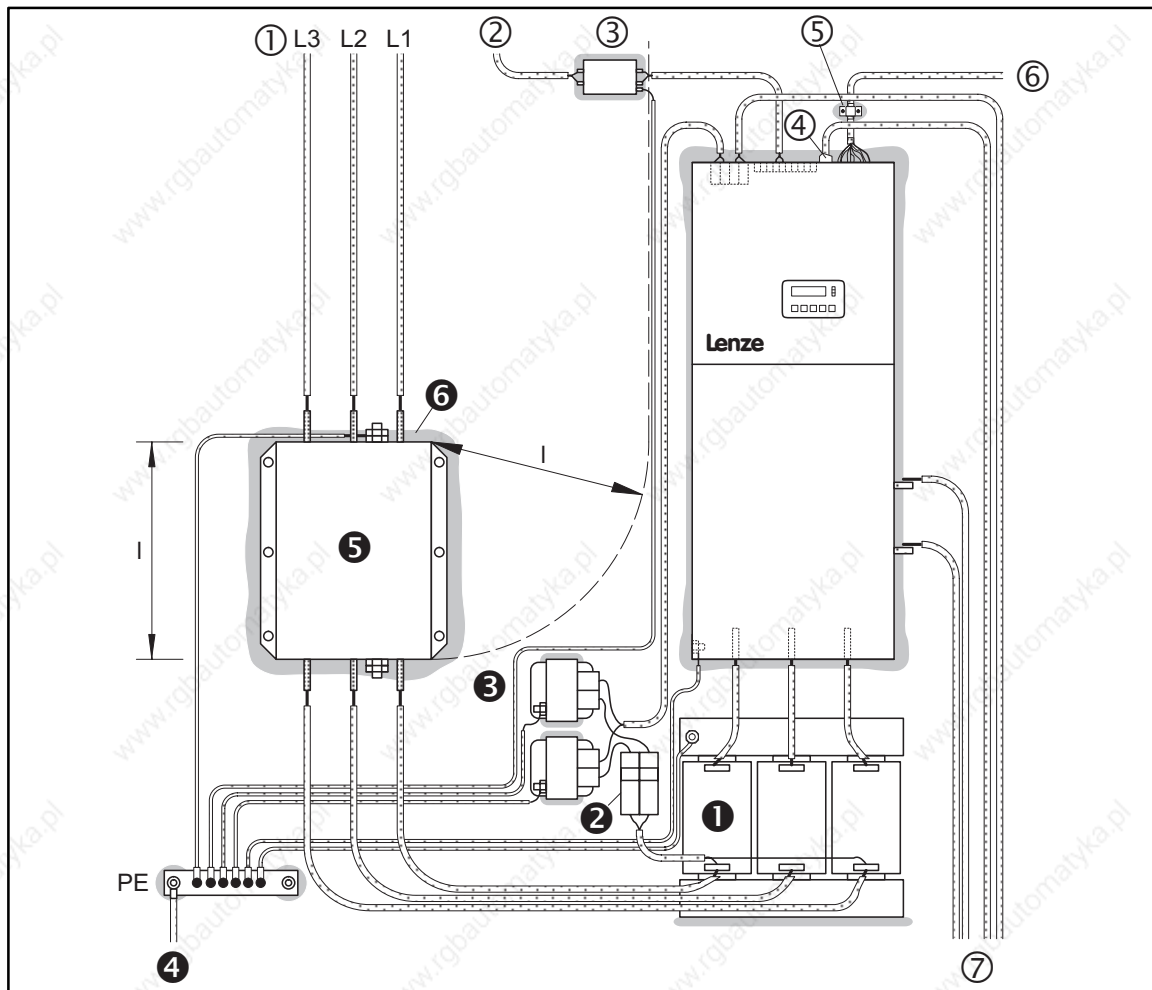
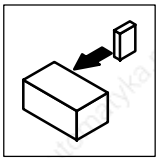
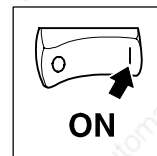

FIG 4-25 Part of the CE-typical drive system with 4X11 ... 4X13 on a mounting plate

- ① Connection mains fuse
- ② Connection fan supply L1/N
- ③ RFI filter
- ④ Uncoated surface for screen connection
- ⑤ Metal plug-in casing connected to screen or Lenze system cable
- ⑥ Screened signal cables
- ⑦ Motor connection with screened cable for act. value encoder
- ❶ Commutating choke
- ❷ Line protection fuses for field supply
- ❸ Mains choke field supply
- ❹ PE connection
- ❺ RFI filter
- ❻ Uncoated, bare metal contact surfaces



Installation



5 Commissioning

5.1 Initial switch-on



Stop!

Prior to initial switch-on of the controller, check the wiring for completeness, short-circuit, and earth fault:

- Power connection:
 - Supply via terminals L1, L2 and L3
 - Separate field supply (if available)
 - Field connection
 - Armature connection
 - Feedback system (resolver, incremental encoder, ...)
 - Control terminals:
 - Controller enable: Terminal X2/28 (reference potential: X2/39)
 - Selection of direction of rotation Terminal X2/21 or X2/22 (reference potential: X2/39)
 - Setpoint selection
 - with internal voltage supply: bridge between X2/39 and X3/40
 - **Maintain the switch-on sequence!**
-



Note!

- All controllers described have a factory setting. A DC shunt motor with tacho attached can be driven as a speed-controlled drive with tacho feedback without further settings after entering the rated field current (see nameplate). The motor must comply with the following:
 - $V_{\text{mains}} = 420\text{V}$
 - $n_{\text{rated}} = 3000 \text{ rpm}$
 - $V_{\text{Tacho}} = 20\text{V} / 1000 \text{ rpm}$
 - Simple adaptation to other machine data or special requirements: Use the following for commissioning:
 - Operating unit of the controller or
 - LEMOC2 (PC program by LENZE)
-

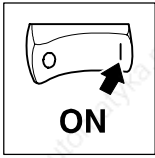

Commissioning

5.2 Commissioning of speed-controlled drives

Commissioning of the 48XX/49XX controller connected to DC shunt motors with

- Tacho attached
- Resolver
- Armature voltage feedback

Section	Commissioning of speed control with			see also
	Attached tacho	Resolver	Armature voltage feedback	
Switch-on sequence	1. X2/28 (Ctrl. enable must be opened (LOW)) 2. Connect the mains Approx. 0.5sec after mains connection the controller is ready for operation. The time t_1 depends on the initial response of the field current typical values: $t_1 = 300\text{ms} \dots 600\text{ms}$ $t_2 = t_1 + 20\text{ms}$ FIG: Signal flow after mains connection (see fig. on the right)			
Input of the motor data	3. Input of the motor nameplate data - C083 Rated field current - C084 Armature circuit time constant - C088 Rated motor current - C090 Rated motor voltage			Chapter 5.4
Input of the controller configuration and adaptation of the actual value detection	4. Set S4 before adapting the tacho voltage: • C025 = -2- (select adjustment of terminals 3, 4) • C029 (adjust actual speed values)	4. • C000 = -2- (extended code set) • C005 = -12- (n-control with resolver)	4. • C000 = -2- (extended code set) • C005 = -10- (n-control with armature voltage feedback) • C025 = -5- (armature voltage feedback) • C029 (adjust speed) If necessary, set the smallest speed error of the controller in loaded and unloaded state under C232 (I · R-compensation).	Chapter 7.1.2 ff.
Setting of the current limit	5. Max. motor current - C022 + I_{Amax} - C023 - I_{Amax}			
Adjustment of the max. speed	6. Select the reference for 100% setpoint - C011 Max. speed			
Selection of direction of rotation	7. CW rotation: X2/21 HIGH signal (+13...+30 V) CCW rotation: X2/22 HIGH signal (+13...+30 V)			Chapter 5.6
Setpoint selection	8. Apply a voltage higher than 0V (max. 10V) to X1/8. - Do not activate a JOG setpoint (LOW signal at X2/E4 and X2/E5)			
Check if LED 'RDY' is on.	9. If RDY-LED is dark and C067 is blinking, reset TRIP first			Chapter 8.1 ff.
Controller enable	10. X2/28 HIGH signal (+13...+30 V) - do not press STP The motor will now rotate in the selected direction of rotation and at the selected setpoint. If necessary, adapt the controller to your application.			Chapter 5.5
Additional settings	11. For operation with LECOM, additional settings are required.			
<ul style="list-style-type: none"> • Do not change the switch-off sequence! The controller must only be disconnected from the mains when it is inhibited or the motor is at standstill! 				

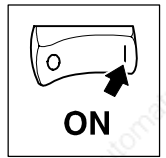

5.2.1 Wiring recommendation for speed control with tacho

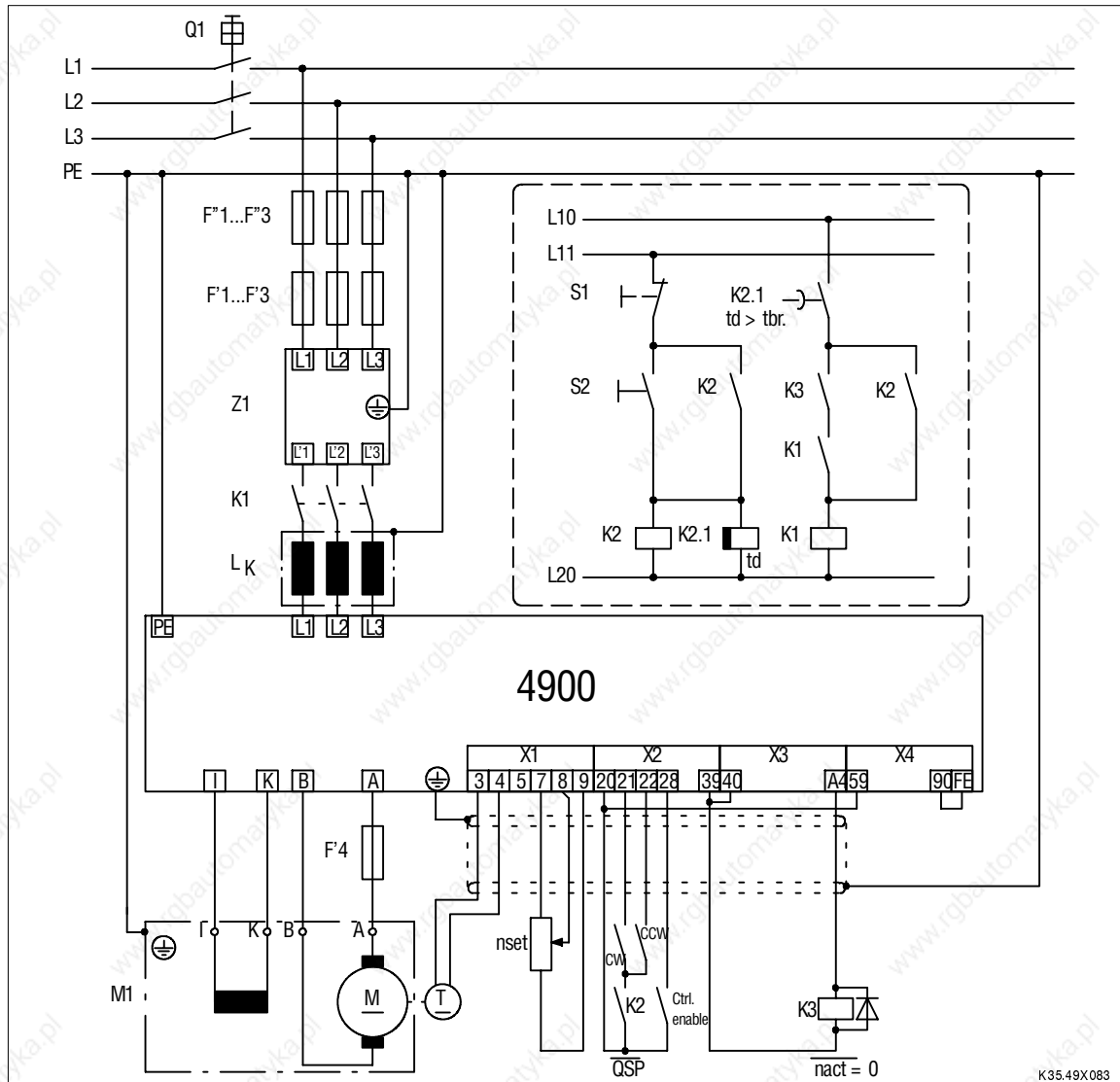

FIG 5-1 Flow chart section: Speed control with tacho

F'1...F'3	Cable protection fuse	L11	"Emergency stop" cable
F'1...F'3	Semiconductor fuse	LK	Mains choke
F'4	Armature fuse	M1	Motor
K1	Mains contactor	nset	Setpoint potentiometer
K2	QSP relay	CW	CW rotation
K2.1	Delay timer	Ctrl. enable	Controller enable
K3	Motor standstill	Q1	Main switch
CCW	CCW rotation	QSP	Quick stop function
L10	Direct lead from the control lead "ON"	Z1	RFI filter

With a tacho voltage to ground: bridge terminals X1/4 and X1/5 and configure the switch S4 on the control module for the operation with a tacho signal to ground (chpt. 4.3.4.1).



Commissioning

5.2.2 Wiring recommendation for speed control with resolver

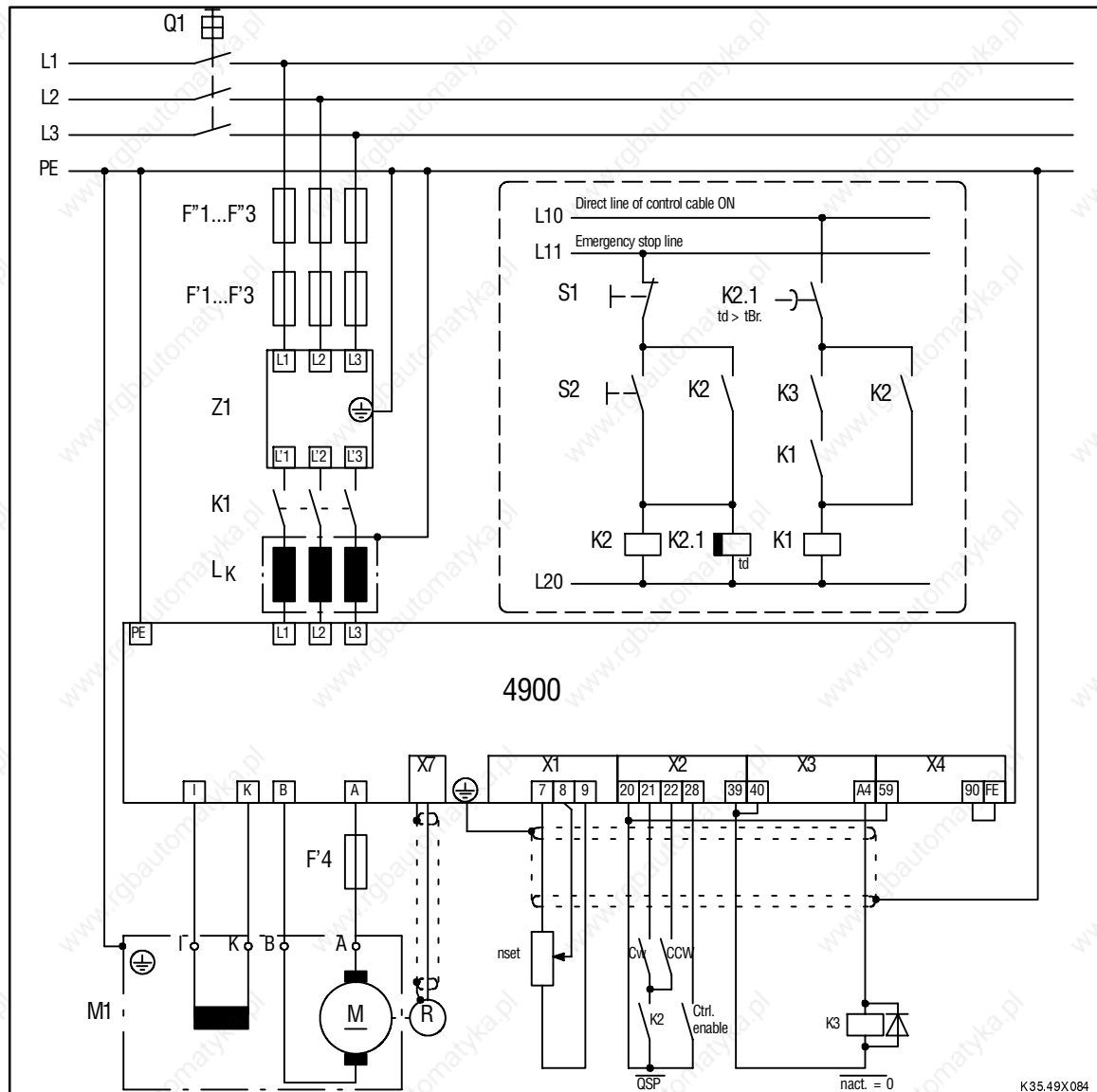
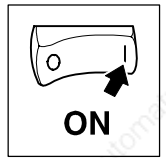

FIG 5-2 Connection diagram: Speed control with resolver

F'1...F'3	Cable protection fuse	L11	"Emergency stop" cable
F'1...F'3	Semiconductor fuse	LK	Mains choke
F'4	Armature fuse	M1	Motor
K1	Mains contactor	nset	Setpoint potentiometer
K2	QSP relay	CW	CW rotation
K2.1	Delay timer	Ctrl. enable	Controller enable
K3	Motor standstill	Q1	Main switch
CCW	CCW rotation	QSP	Quick stop function
L10	Direct cable from the control cable "ON"	Z1	RFI filter



5.2.3 Speed control with armature voltage feedback

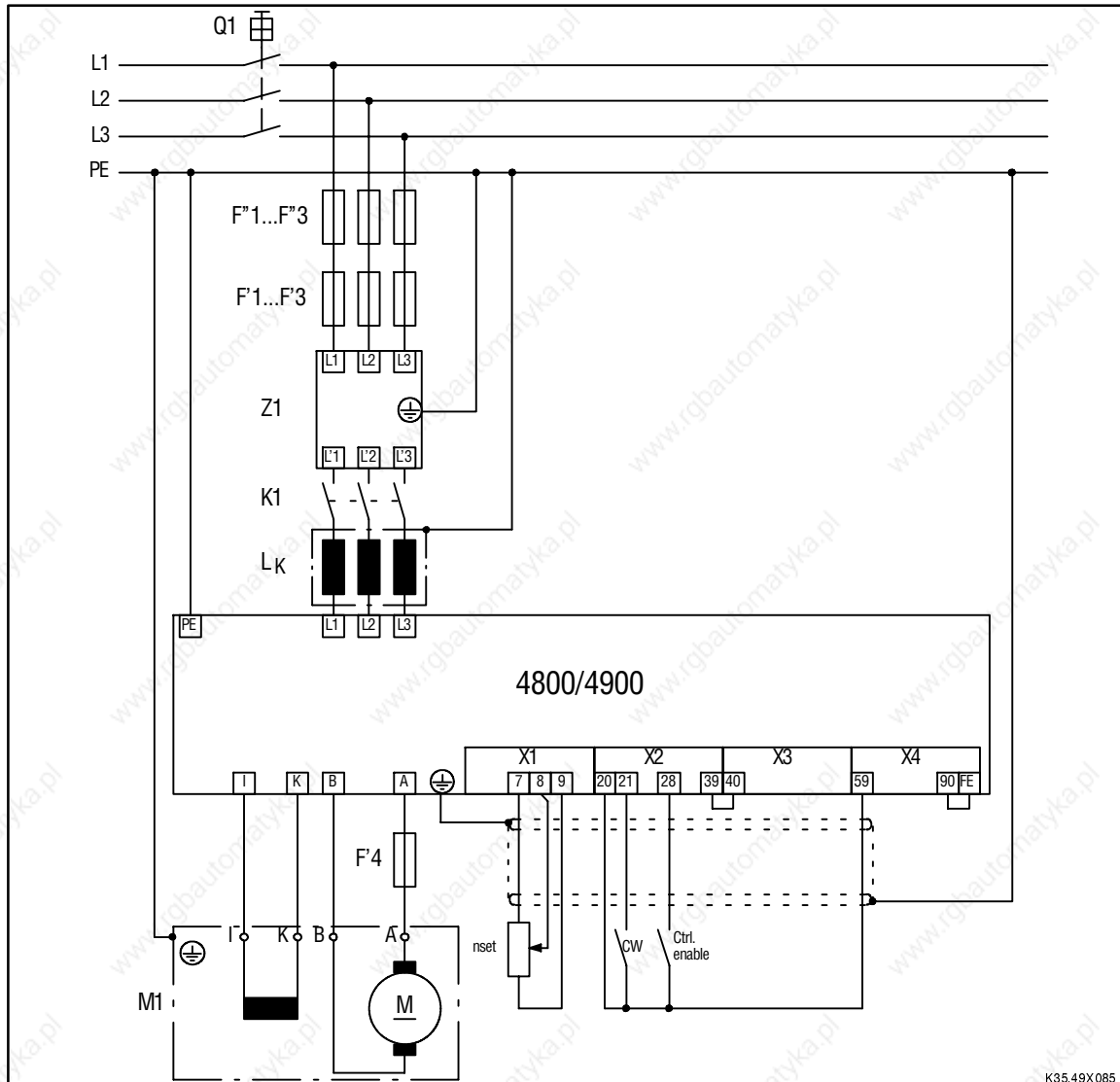

FIG 5-3 Connection diagram: Speed control with armature voltage feedback

F'1...F'3	Cable protection fuse	nset	Setpoint potentiometer
F'1...F'3	Semiconductor fuse	CW	CW rotation
F'4	Armature fuse	Ctrl. enable	Controller enable
K1	Mains contactor	Q1	Main switch
LK	Mains choke	Z1	RFI filter
M1	Motor		



Note!

With armature voltage feedback the control terminals remain potential-free. Mains disconnection only when no voltage is applied!

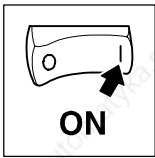

Commissioning

5.3 Commissioning of torque-controlled drives

Section	Commissioning according to writing proposed in chapter 5.3.1	see also
Switch-on sequence	<p>1. X2/28 (Ctrl. enable must be opened (LOW))</p> <p>2. Connect the mains Approx. 0.5sec after mains connection the controller is ready for operation. The time t_1 depends on the initial response of the field current</p> <p>typical values: $t_1 = 300\text{ms} \dots 600\text{ms}$ $t_2 = t_1 + 20\text{ms}$</p> <p>FIG: Signal flow after mains connection (see fig. on the right)</p>	
Input of the motor data	<p>3. Input of the motor nameplate data</p> <ul style="list-style-type: none"> - C083 Rated field current - C084 Armature circuit time constant - C088 Rated motor current - C090 Rated motor voltage 	Chapter 5.4
Enter controller configuration	<p>4. Configuration of torque control:</p> <ul style="list-style-type: none"> - C000 -2- extended code set - C005 -42- torque control with speed limitation 	Chapter. 7.1.2 ff.
Set the current limit	<p>5. Max. motor current</p> <ul style="list-style-type: none"> - C022 + I_{Amax} - C023 - I_{Amax} 	
Adjustment of the max. speed	<p>6. Select the reference for 100% setpoint</p> <ul style="list-style-type: none"> - C011 max. speed 	
Set the threshold	<p>7. Set threshold $n_{act} = 0$</p> <ul style="list-style-type: none"> - C019 xxx rpm 	
Setting of comparison speed	<p>8. Comparison speed $n_{act} < n_x$</p> <ul style="list-style-type: none"> - C016 xxx rpm 	
Adjust n-controller gain	<p>9. Adjust V_{pn} with high inertia load</p> <ul style="list-style-type: none"> - C070 Proportional gain of the n-controller 	
Additional settings	<p>10. For operation with LECOM, additional settings are required.</p>	
<p>• Do not change the switch-off sequence! The controller must only be disconnected from the mains when it is inhibited or the motor is at standstill!</p>		

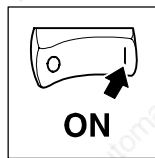

5.3.1 Wiring recommendation for torque control with speed limitation

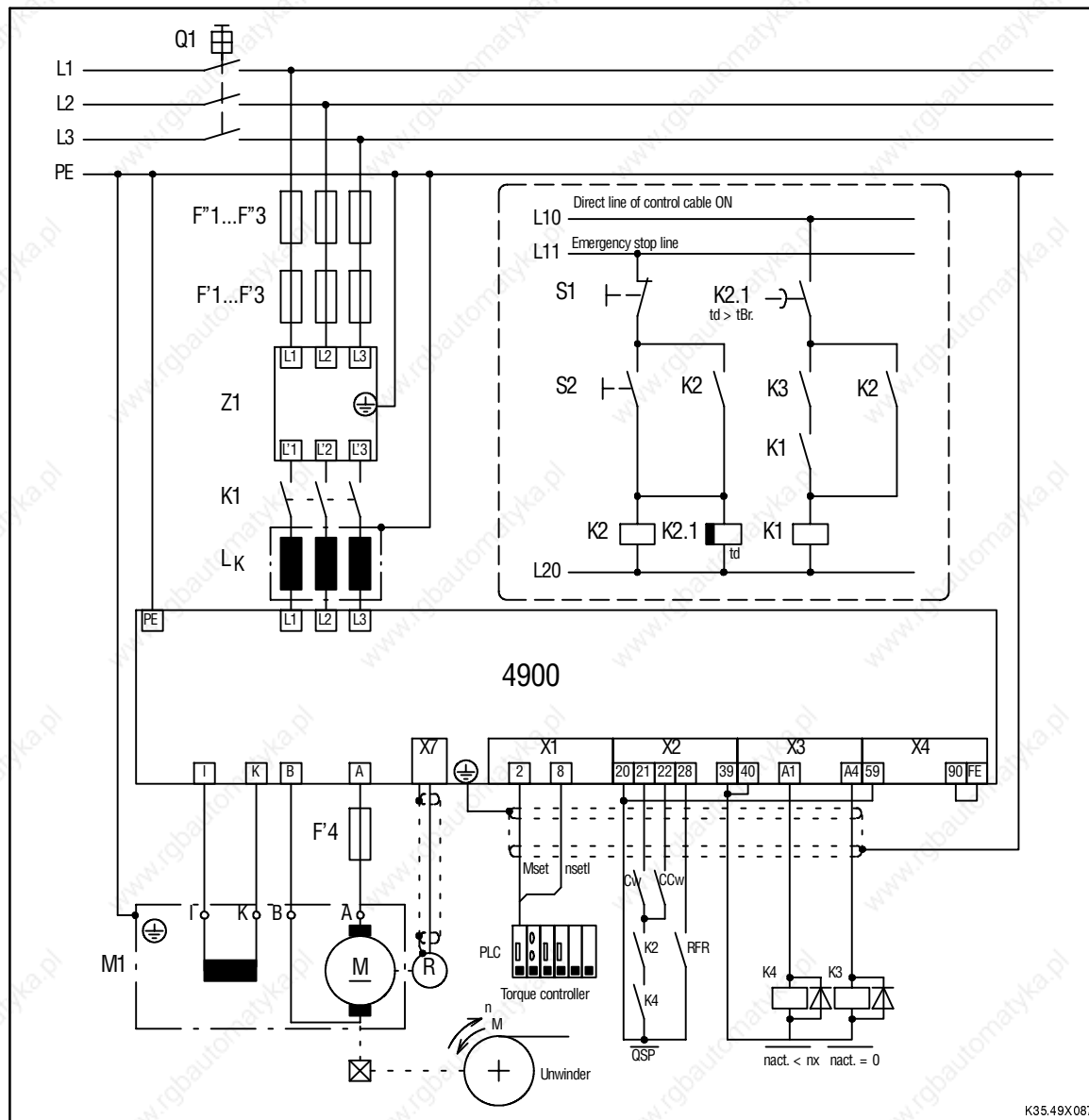
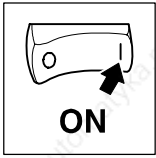

FIG 5-4 Connection diagram: Torque control with speed limitation

F"1...F"3	Cable protection fuse	L11	"Emergency stop" cable
F'1...F'3	Semiconductor fuse	LK	Mains choke
F'4	Armature fuse	M1	Motor
K1	Mains contactor	nset	Setpoint potentiometer
K2	QSP relay	CW	CW rotation
K2.1	Delay timer	Ctrl. enable	Controller enable
K3	Motor standstill	Q1	Main switch
CCW	CCW rotation	QSP	Quick stop function
L10	Direct cable from the control cable "ON"	Z1	RFI filter



Commissioning

5.4 Input of the motor data



Note

For internal calculations with field-weakening control, the exact input of the following data is required. They are indicated on the nameplate of the connected motor.

- C022, C023 Adjust maximum motor current I_{\max}
- C081 Rated motor power for the power display
- C087 Rated motor speed for the power display
- C083 Rated field current for the field controller
- C084 L/R armature time constant for uncompensated motors
- C088 Rated motor current for "I²t monitoring" (armature circuit)
- C090 Rated motor voltage for armature voltage limitation

Under C084 the controller can be adjusted to different armature time constants $T = L/R$. The values can be set between 0 ms and 30 ms.

Common armature time constants: (see motor catalog, section I)

- compensated machines 0 ms to 10 ms
- uncompensated machines 15 ms to 30 ms.

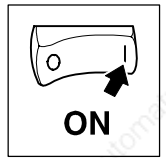

5.5 Controller enable

For controller enable, the following conditions must be fulfilled:

- Controller enable via terminal:
 - Independently of the operating mode, apply a voltage of $V = +13...+30\text{ V}$ to X2/28. (Reference potential: X2/39).
- Controller enable via LECOM interface
 - For the operating modes C001 = -3-, -5-, -6- and -7- (LECOM control), the controller must be additionally enabled via the LECOM interface.
- Stop function
 - The controller can be inhibited by pressing the STP key. The stop function can only be reset via the enable command SH + STP or mains switching.
- TRIP reset
 - If a monitoring system sets TRIP the controller will be inhibited immediately. The internal controller inhibit will be reset when resetting the fault (C067).

Since the controller inhibit can be caused by many different reasons, the origin of the controller inhibit is displayed under C183.

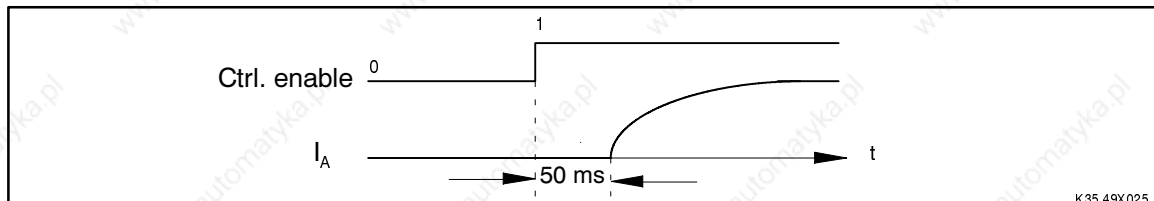
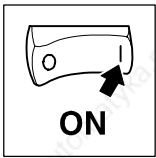

FIG 5-5 Signal flow when enabling the controller



Commissioning

5.6 Selection of direction of rotation and quick stop

Direction of rotation

The polarity of the output voltage V_A and thus the direction of rotation of the motor depends on the signs of the setpoint, the control of the digital inputs X2/21 and X2/22 and the polarity of the field voltage.

Quick stop (QSP)

Independently of the setpoint selection and because of the quick stop function, the controller can be stopped within a time selectable under C105.

- The quick stop function is active:
 - when the mains is switched on, if X2/21 = HIGH and X2/22 = HIGH
 - during operation with X2/21 = LOW and X2/22 = LOW
 The speed is reduced to zero within the deceleration time set under C105.
- Quick stop
 - sets the additional setpoint integrator to 0.
 - decelerates the drive to 0 according to the deceleration ramp set under C105.
 - is detected internally if no signal is applied to X2/21, X2/22 for more than approx. 6 ms.
- The drive starts running again
 - if a HIGH signal is applied to one of the inputs (also for keypad or interface operation).

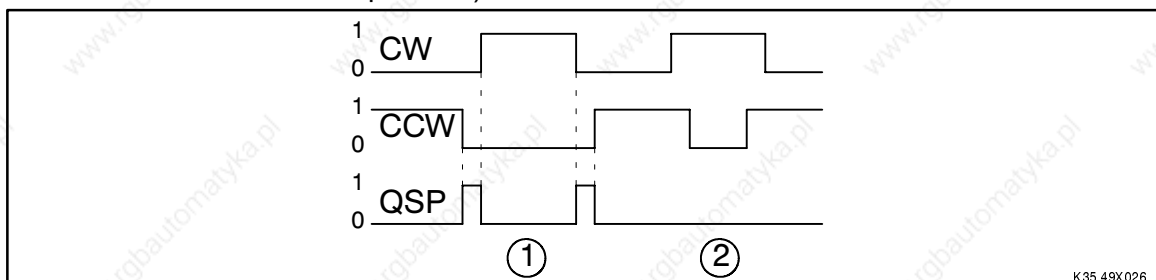

FIG 5-6 Selection of direction of rotation

- ① CW/CCW not overlapping
- ② CW/CCW overlapping

When the threshold $n_{act} = 0$ (C019) is reached, the integral action component of the speed controller will be switched off (only if C005 = -10-, -11-, -40-, -41-). With all other configurations, the I-component of the n-controller will only be switched off, if the angle controller is not active (C254 = 0). The drive cannot generate a torque when stopped by a brake.



With the configurations C005 = -X2- or -X3- and activated angle controller (C254 > 0), the drive will be decelerated to speed = 0 and angle-controlled (drift-free). The drive can thus generate its maximum torque (independently of the current limit C022, C023).

Code	Name	Possible settings			Info
		Lenze	Selection		
C105	Deceleration time for quick stop	0.00s	0 s 1 s 10 s 100 s	{0.01 s} 1 s {0.1s} 10s {1 s} 100 s {10 s} 990 s	Time referred to the speed change 0...n _{max}

- Configuration possibilities for the selection of the direction of rotation and quick stop

Operating mode	Setpoint to X1/8	X2/21	X2/22	C041	C042	Direction of rotation (View towards motor shaft)
Terminal control	positive	HIGH	LOW	-0-	-0-	right
	negative	LOW	HIGH	-1-	-0-	
C041 and C042 display the status of terminals X2/21 and X2/22	positive	LOW	HIGH	-1-	-0-	left
	negative	HIGH	LOW	-0-	-0-	
	pos. / neg.	HIGH	HIGH	-0- / -1-	-0-	unchanged
Keypad / LECOM C041 and C042 determine the direction of rotation or quick stop, in addition LOW signal X2/21 and X2/22 activates quick stop.	positive	HIGH/LOW	LOW/HIGH	-0-	-0-	right
	negative	HIGH/LOW	LOW/HIGH	-1-	-0-	
	positive	HIGH/LOW	LOW/HIGH	-1-	-0-	left
	negative	HIGH/LOW	LOW/HIGH	-0-	-0-	
	pos. / neg.	LOW	LOW	-0- / -1-	-1-	Quick stop active

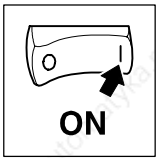

Commissioning

5.7 Changing the internal control structure

The internal control structure is adapted to the control task (e. g. speed control, torque control, angle control, ...) via code C005 (see chapter 7.3). The controller must however be inhibited first.



Stop!

It is possible that the terminal assignments change when the internal control structure is changed.

5.8 Changing the terminal assignment



Note!

A function, which is already assigned to an input, can only be assigned to another terminal if the input used before is assigned with a new function. If you reassign an input, the function assigned before will be overwritten.

Freely assignable digital inputs

Except for the functions "Enable JOG setpoints", "Enable additional acceleration and deceleration times", "Enable fix setpoints" and "Select parameter set", each function can only be assigned to one input.

It is possible to determine a priority for each input:

The function can either be switched via a terminal, or depending on the selected operating mode.

Changing the assignment

1. Select the input to be assigned under C112.
2. Select the function for the input under C113.
3. Determine the polarity under C114 (HIGH-active or LOW-active).
4. Determine the priority under C115.

Repeat steps 1. to 4. to assign all inputs.

5 freely assignable inputs are available at the terminals.

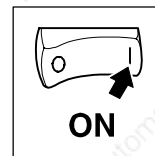

Freely assignable digital outputs

The controller provides 12 freely assignable digital outputs and a relay output.

The free digital outputs 1 to 5 are assigned to terminals X3/A1 to X3/A4 and X4/A5. The relay output is assigned to terminals X3/K11 and X3/K14. The polarity can be determined (HIGH-active, LOW-active) and the output can be delayed.

The free digital outputs 6 to 12 can only be evaluated via the LECOM interface. They are always HIGH-active.

Changing the assignment

1. Select the output to be assigned under C116.
2. Select the function for the output under C117.

Only for outputs A1 to A5 and relay output:

3. Determine the polarity under C118 (HIGH-active or LOW-active).
4. Determine the signal delay under C128.

Repeat steps 1. to 4. until all outputs are assigned.

Freely assignable "analog" inputs

The term "freely assignable analog inputs" comprises the analog (terminals) and digital (X5, X7 and X9) setpoint and actual value inputs.

If you change the configuration under C005, the assignment of the free analog inputs will be overwritten with the corresponding factory setting. If necessary, adapt the function assignment to the wiring.

It is possible to determine the priority for terminals X1/1, X1/2, X1/3, X1/4, X1/6, X1/8, X5, X7 and X9. Thanks to the priority function, the terminal can be switched independently of the the operating mode.

Changing the assignment

1. Select the input to be changed under C145.
2. Select the function for the input under C146.

Only for inputs X1/1, X1/2, X1/3, X1/4, X1/6, X1/8, X5, X7, X9:

3. Determine the priority under C147.

Repeat steps 1. to 3. until all inputs are assigned.

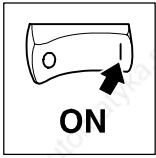

Commissioning

Freely assignable analog monitor outputs

Via the monitor outputs X4/62, X4/63 und X8, internal signals can be output as voltage signals, current signals or frequency signals (See chapter 4.3.4.1).

With C108 and C109 (C109 is not effective for the digital frequency output), the outputs can be adapted, for instance, to a measuring unit or a slave drive.

Changing the assignment

1. Select the output to be assigned under C110.
2. Select the function for the output under C111.
3. Set the offset under C109 (not for the digital frequency output).
4. Determine the gain under C108.

Repeat steps 1. to 4. until all outputs are assigned.

Special feature of the freely assignable digital frequency output

With the selection of a configuration under C005, the output X8 already has a basic assignment. The assignment can only be changed afterwards.

If the digital frequency output X8 is assigned to another signal than indicated in the basic assignment of the configuration (C005), then the output frequency can only be adapted via code C108.

With signal sources with a reference value of 100% (see C111, except: LF and resolver inputs) a signal of 100% at the output X8 with a gain factor of $C108 = 1.00$ corresponds to a frequency of 250 kHz.

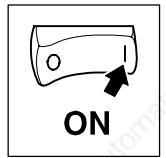

5.9 Application examples

The specifications, processes and circuitry described are for guidance only, and must be adapted to your own specific application.

- Current ratio control
- Dancer control on an unwinder
- Hoists
- Synchronous speed ratio
- Mains separation

The same applies to wiring recommendations used as commissioning examples in chapter 5:

- Speed control with
 - Tacho
 - Resolver
 - Armature voltage feedback
- Torque control with speed limitation

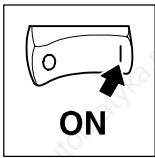

Commissioning

5.9.1 Current ratio control

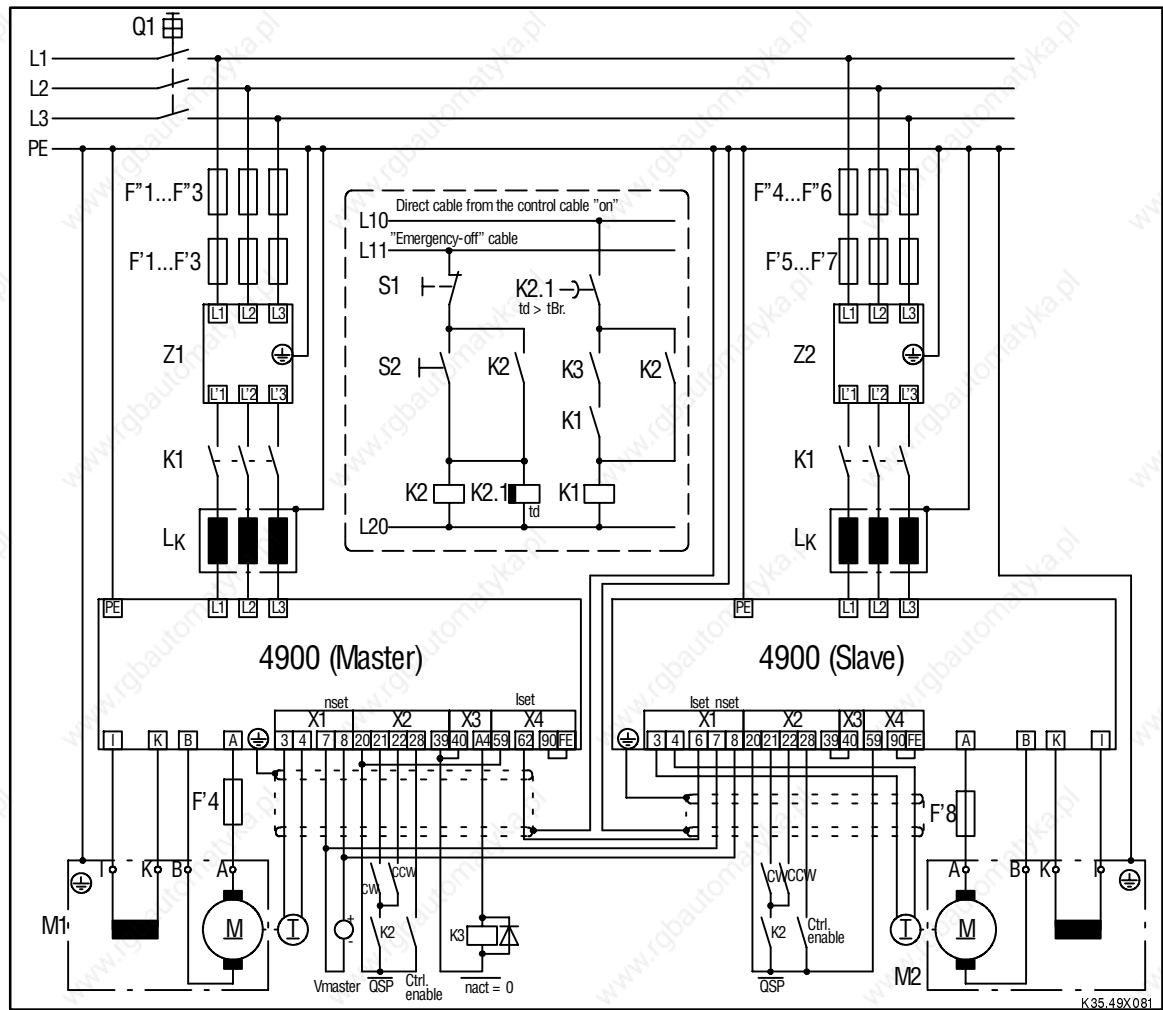

FIG 5-7 Connection diagram for current ratio control



Parameter setting

Code	Input	Description
Input according to nameplate data		
Master and slave		
C083	xxx A	Rated field current
C084	xxx ms	Armature circuit time constant
C088	xxx A	Rated motor current
C090	xxx V	Rated motor voltage
Input of the current limits		
Master and slave		
C022, C023	xxx A	Max. motor current
Enter controller configuration		
Master and slave		
C000	-2-	Extended code set
C005	-11-	Speed control with tacho feedback
Master		
C110	-1-	Input selection term. 62
C111	-25-	Monitor output 'M _{set} '
Adjustment of the speed controller		
Master and slave		
C011	xxxx rpm	Select max. speed
C025	-2-	Select adjustment terminals 3 and 4
C029		n _{act} adjust speed
Slave		
C071	9999 ms	T _{nn} , no I component
C025	-3-	Select adjustment terminal 6
C027		Select the ratio for the actual speed influence divided by V _{pn}
C070	V _{pn}	Adjust n-controller gain
Master and slave		
C054		Check current distribution between master and slave.
Application parameters		
Master		
C019	xxxx rpm	Set threshold n _{act} = 0
Save parameters		
Master and slave		
C003		Save parameter set



Commissioning

5.9.2 Dancer position control on an unwinder

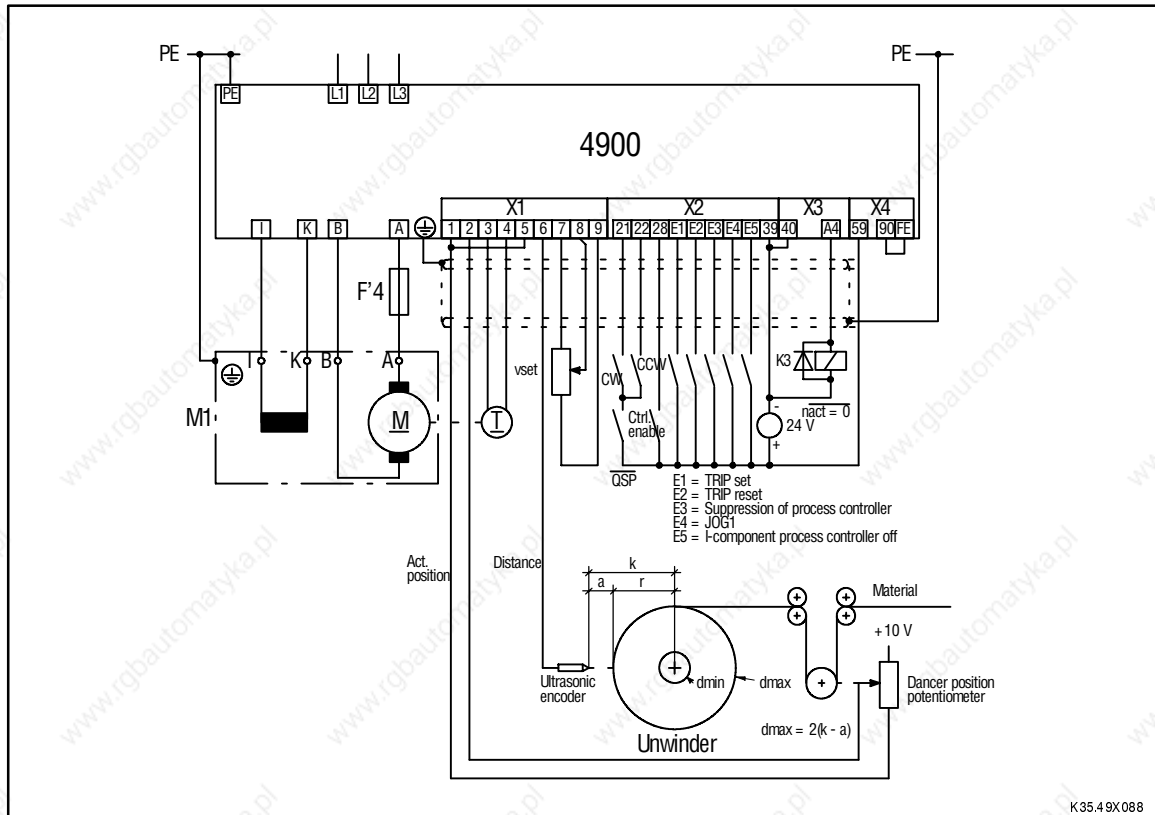

FIG 5-8 Signal flow chart for dancer position control on an unwinder

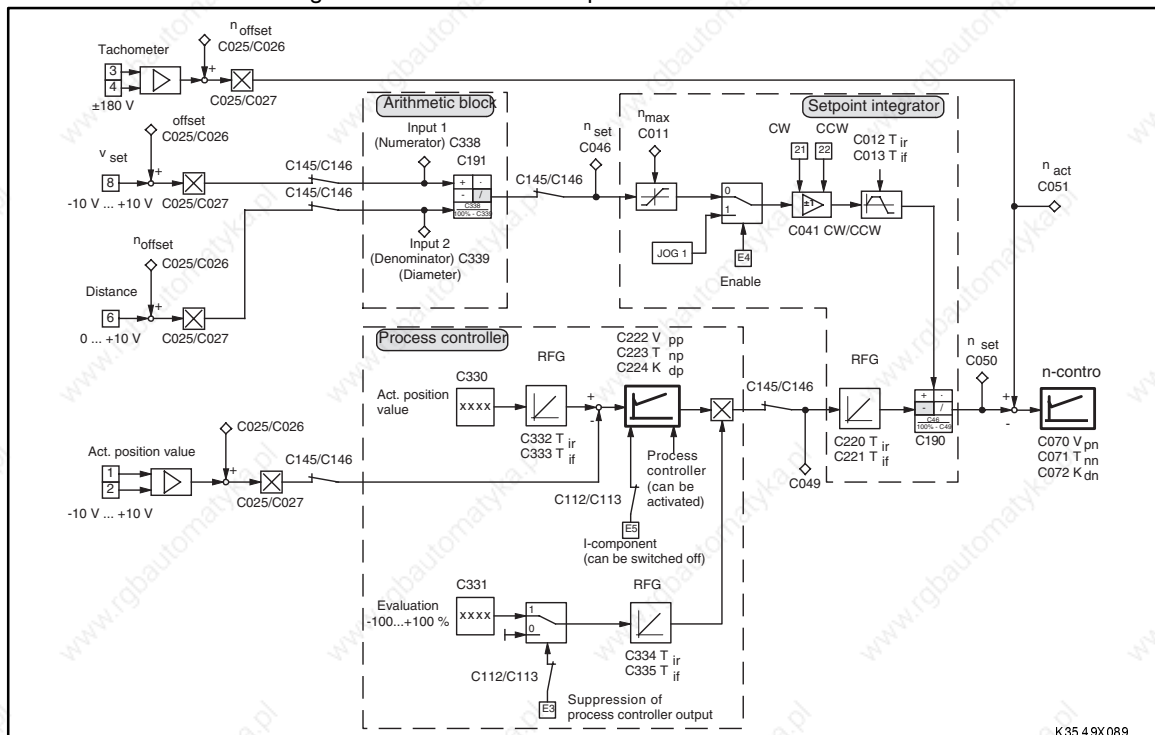

FIG 5-9 Example for a dancer position control on an unwinder



Parameter setting

Code	Input	Description
Input to nameplate data		
C083	xxx A	Rated field current
C084	xxx ms	Armature circuit time constant
C088	xxx A	Rated motor current
C090	xxx V	Rated motor voltage
Freely assignable analog inputs		
C145	-4-	Input selection term. 8
C146	-15-	Arithmetic block 2 input 1
C145	-3-	Input selection term. 6
C146	-16-	Arithmetic block 2 input 2
C145	-10-	Input selection arithmetic block output
C146	-1-	Main setpoint C046
C145	-9-	Input selection process controller output
C146	-3-	Additional setpoint C049
C145	-1-	Input selection term. 1,2
C146	-7-	Act. value process controller
Freely assignable digital inputs		
C112	-3-	Input selection E3
C113	-32-	Process controller rating
C112	-5-	Input selection E5
C113	-31-	Process controller I-component off
Arithmetic block		
C191	-4-	Output = input 1 / input 2
Calculate distance → diameter		
C025	-3-	Input selection terminal 6
C026		Offset for distance a = -xxx mV
C027	2.000	Rating for diameter
Adjustment of the speed controller		
C011	xxx rpm	Select max. speed
C025	-2-	Select adjustment terminals 3 and 4
C029	n_{act}	Adjust speed
Process controller		
C330	xxx %	Select position setpoint
C331	xxx %	Process controller output rating
Application parameters		
C022, C023	xxx A	Max. motor current
C019	xxx rpm	Set threshold $n_{act} = 0$
C070	V_{pn}	Adjust n-controller gain with high inertia load
C222	V_{pp}	Optimise process controller
Save parameters		
C003		Save parameter set



Commissioning

5.9.3 Hoists

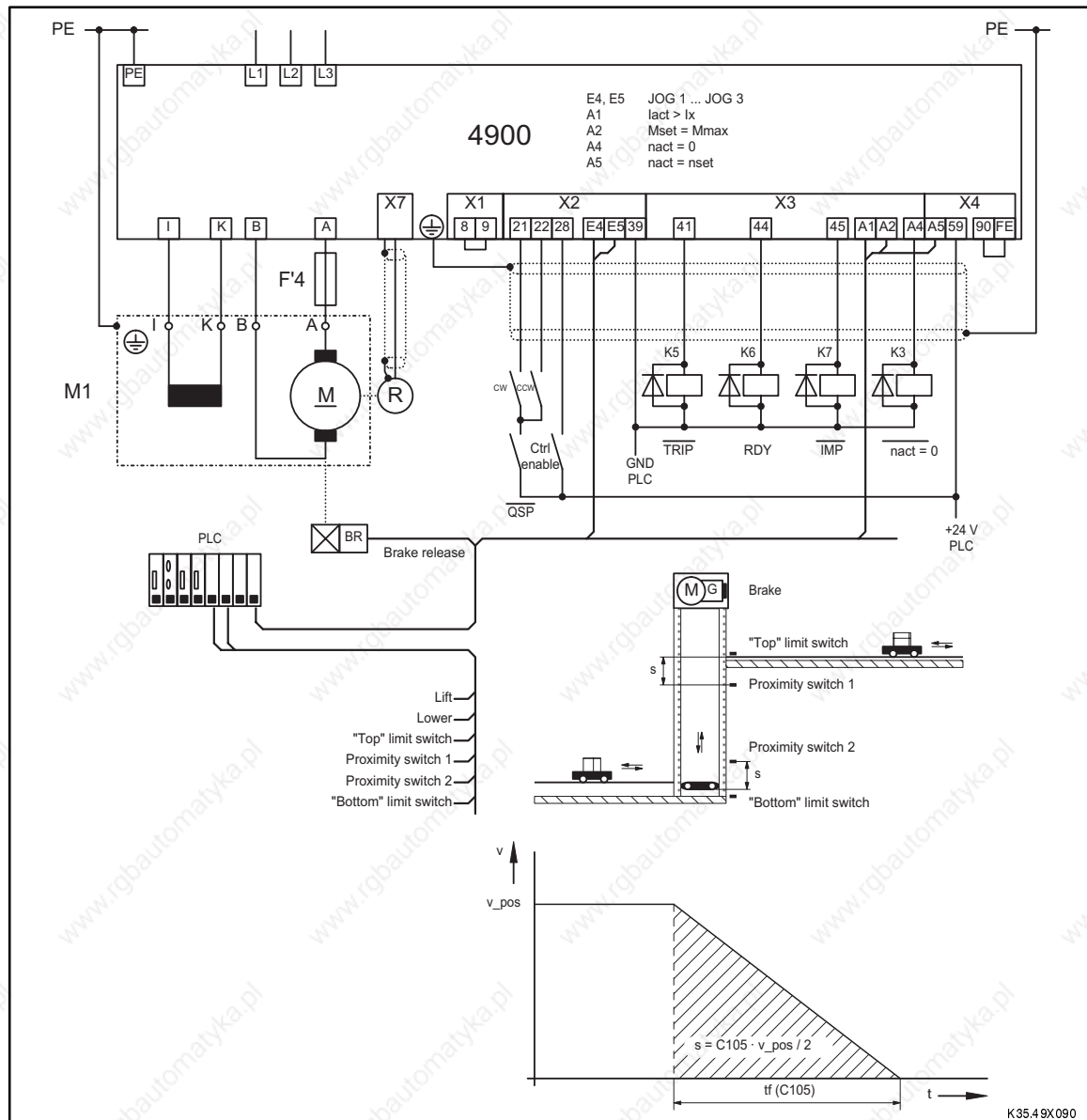
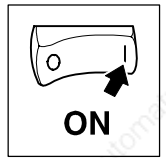

FIG 5-10 Connection diagram for hoists

The bridge between terminals 8 and 9 determines a setpoint of 100 % n_{max} if no JOG value is active.



Parameter setting

Code	Input	Description
Input to nameplate data		
C083	xxx A	Rated field current
C084	xxx ms	Armature circuit time constant
C088	xxx A	Rated motor current
C090	xxx V	Rated motor voltage
Input of the current limits		
C022, C023	xxx A	Max. motor current
Enter controller configuration		
C000	-2-	Extended code set
C005	-52-	Speed control with angle controller
Adjustment of the speed controller		
C070	V_{pn}	Adapt n-controller gain with high inertia load
Adjustment of the angle controller		
C254	V_{pw}	Adapt V_{pw} to the system, with $V_{pw} = 0$ the angle controller is not activated
Application parameters		
C011	xxx rpm	Select max. speed (corresponds to v_{max})
C019	xxx rpm	Set threshold $n_{act} = 0$
C240	xxx % n_{max}	Adjustment of the permissible speed deviation
C116	-5-	Input selection of the digital output A5
C128	xxx s	Time for which the drive can leave the set range without triggering a message
C255	xxxx inc	Contouring error limit
C105	xxx s	Deceleration time $t_f = 2 \cdot s / v_{pos}$
C116	-1-	Input selection of the digital output A1
C117	-15-	$I_{act} > I_x$
C244	xxx %	I_{max} (limit value for the starting torque against the brake)
C038	-1-	Input selection JOG 1
C039	xxx %	C011 (save speed for v_{pos} in JOG 1)
C038	-x-	Input selection JOG x
C039	xxx %	C011 (further velocities)
Save parameters		
C003		Save parameter set

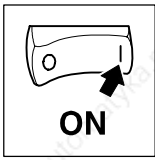

Commissioning

5.9.4 Synchronous speed ratio

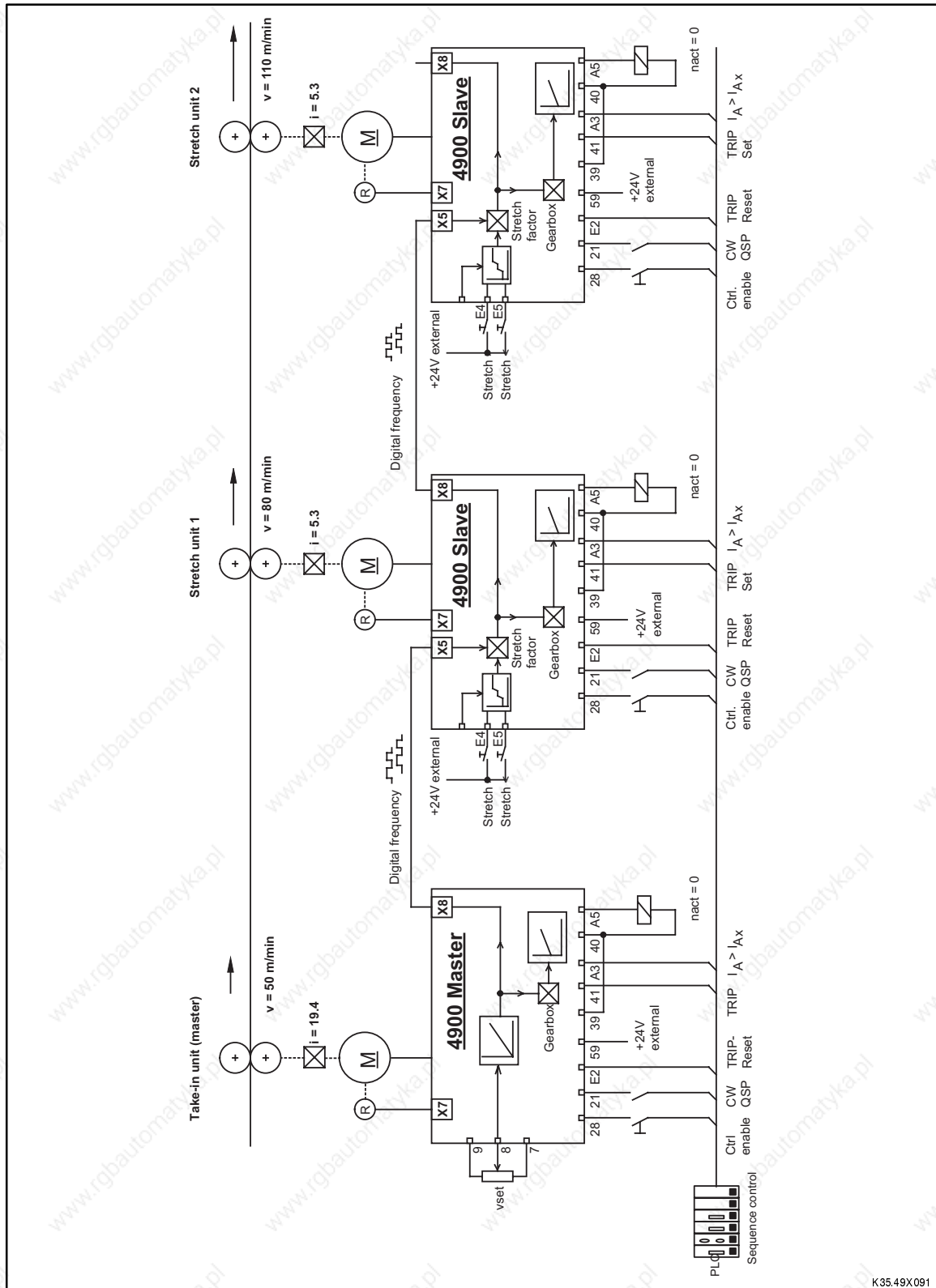
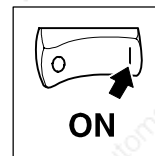
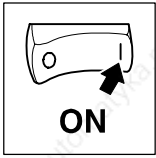

FIG 5-11 Connection diagram for synchronous speed ratio



Parameter setting

Code	Input	Description
Input according to nameplate data		
Master and slave		
C083	xxx A	Rated field current
C084	xxx ms	Armature circuit time constant
C088	xxx A	Rated motor current
C090	xxx V	Rated motor voltage
Input of the current limits		
Master and slave		
C022, C023	xxx A	Max. motor current
Enter controller configuration		
Master and slave		
C000	-2-	Extended code set
Master		
C005	-52-	Speed control with resolver
Slave		
C005	-72-	Setpoint cascade with resolver
Freely assignable digital inputs		
Slave		
C112	-4-	Input selection E4
C113	-17-	Motorpot down
C112	-5-	Input selection E5
C113	-18-	Motorpot
Freely assignable analog inputs		
Slave		
C145	- 8 -	Input selection motor potentiometer output
C146	-10-	Gain C027 of X5
Freely assignable digital outputs		
Master and slave		
C116	-5-	Input selection A5
C117	-15-	$I_A > I_{AX}$
Gearbox factor		
Master (FIG 5-11; $i = 19.4$)		
C032	xxx	Numerator = 1.9400
C033	xxx	Denominator = 0.1000
Slave (FIG 5-11; $i = 5.3$)		
C032	xxx	Numerator = 0.5300
C033	xxx	Denominator = 0.1000
Strain factor		
Slave		
C027	xxx	Numerator = 1.6 (stretching unit 1); numerator = 1.375 (stretching unit 2)
C028	xxx	Denominator = 1
Parameterization of the motor potentiometer		
Slave		
C260	100%	Upper limit of motor potentiometer
C261	-100%	Lower limit of motor potentiometer
C262	xxx s	Motor potentiometer acceleration time
C263	xxx s	Motor potentiometer deceleration time



Commissioning

Code	Input	Description
Adjustment of the speed controller		
Master and slave		
C011	xxx rpm	Select max. speed
Application parameters		
Master and slave		
C022, C023	xxx A	Max. motor current
C019	xxx rpm	Set threshold $n_{act} = 0$
C070	V_{pn}	Adjust n-controller gain with high inertia load
C244	xxx %	$I_A > I_{Ax}$
Save parameters		
Master and slave		
C003		Save parameter set



5.9.5 Mains separation

5.9.5.1 Inching with mains separation

In this application example the power stage is connected to or disconnected from the mains by means of the inching command (switch S4). Since the control electronics and the field supply are ready for operation when the mains switch is activated, the inching command only delays the signals of the mains contactor.

Preparation of the controller:

- Remove the wire bridges BR1, BR2, BR3, BR4, and BR5 of the controllers 4902...4907 (4902LP, 4903LP or 4905LP) when no voltage is applied.
- Remove the wire bridges BR3, BR4 and BR4 of the controllers 4X08...4X13 (4908LP or 4911LP) when no voltage is applied.

Proceed as follows to remove the bridges:

- Open the controller cover (4 mounting screws)
- Unbolt the 2 mounting screws for the cover of the control electronics
- Open the cover.



Stop!

- Ensure correct phase connection of the separate mains supply. Incorrect connection leads to blown fuses.
 - The phase shift of the voltages from the power stage to the control electronics must be smaller than 2°.
 - The controller must be inhibited via the function "Controller enable" (Ctr. enable) before the contactor can be opened or closed. If the switching sequence is not observed, fuses can blow or the fault message ACI can be displayed.
 - During inching with K1, the electronics remains live. The mains is completely separated via the main switch.
 - In this application, a voltage is permanently applied to the field. Activate standstill excitation (field heating)!
-



Commissioning

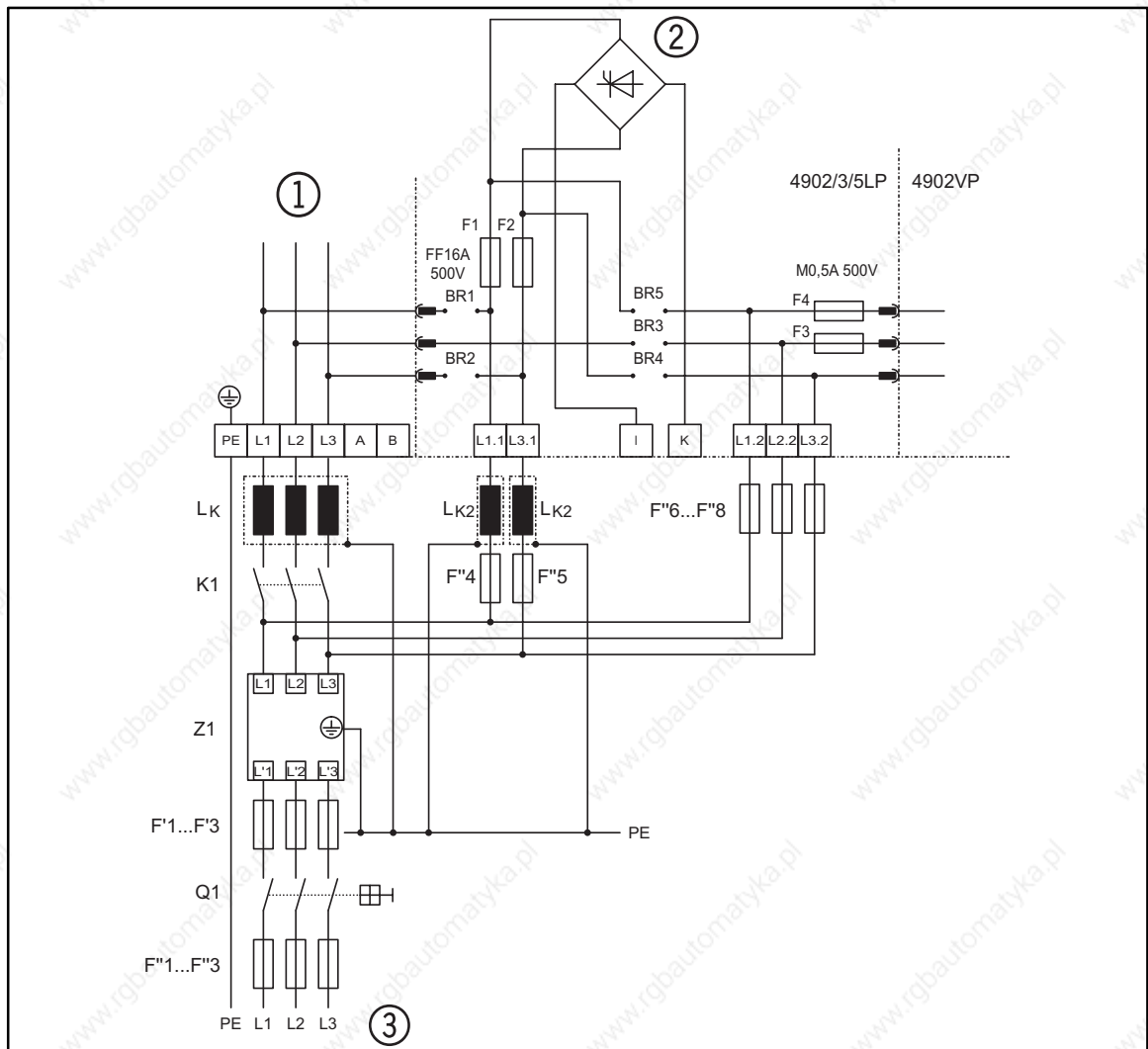
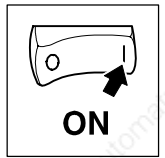

FIG 5-12 Power connection for inching with mains separation

Explanations

F'1...F'3	Semiconductor fuses
F''6...F''8	Cable protection fuses 4A
F''1...F''4	Cable protection fuses
Q1	Main switch
K1	Mains contactor
①	Power stage
②	Field controller
③	For the connection voltage see Rated Data



Contactor or relay circuit

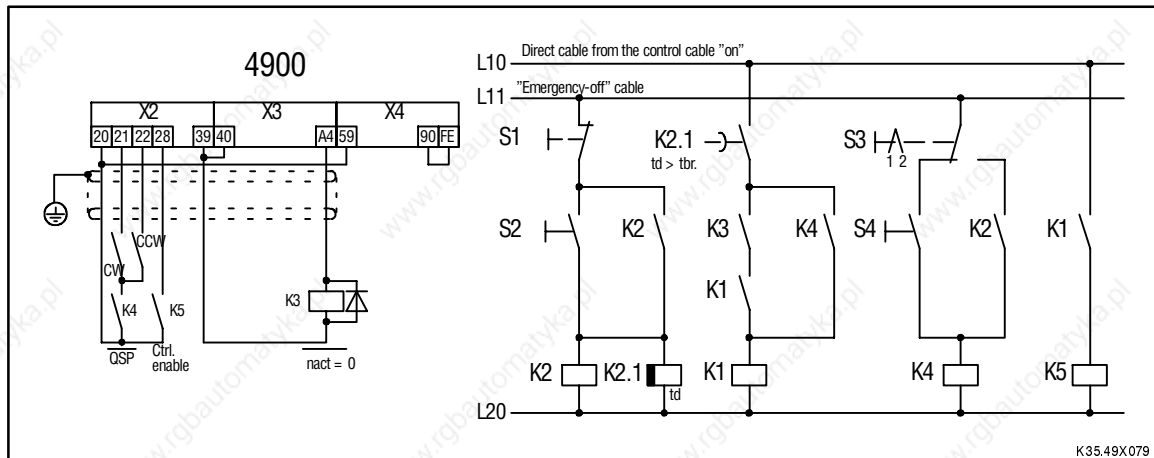

FIG 5-13 Connection of the signal electronics for inching via switch S4

K1	Mains contactor controller
K2.1	Safety relay for mains separation if standstill is not indicated
K4, K5	Relay with gold contacts
S1	Drive off
S2	Drive on
S3	1: Inching / 2: Remote
S4	Inching
L10	Direct cable from the control cable 'ON'
L11	'Emergency stop' cable



Commissioning

5.9.5.2 Mains switch-off logic



Stop!

The controller 48XX/49XX must only be disconnected from the mains when it is inhibited or the motor is in standstill. This also applies to the emergency stop function.

The function $|n_{act}| < C019$ can be used for the mains switch-off logic.

The digital output terminal A4 is used for the automatic mains switch-off. The terminal sets "low", if the actual speed value is smaller than the value indicated under C019. The threshold can be entered under C019 from 0 to 5000 rpm. For this application, the setting must not exceed $2\% n_N$.

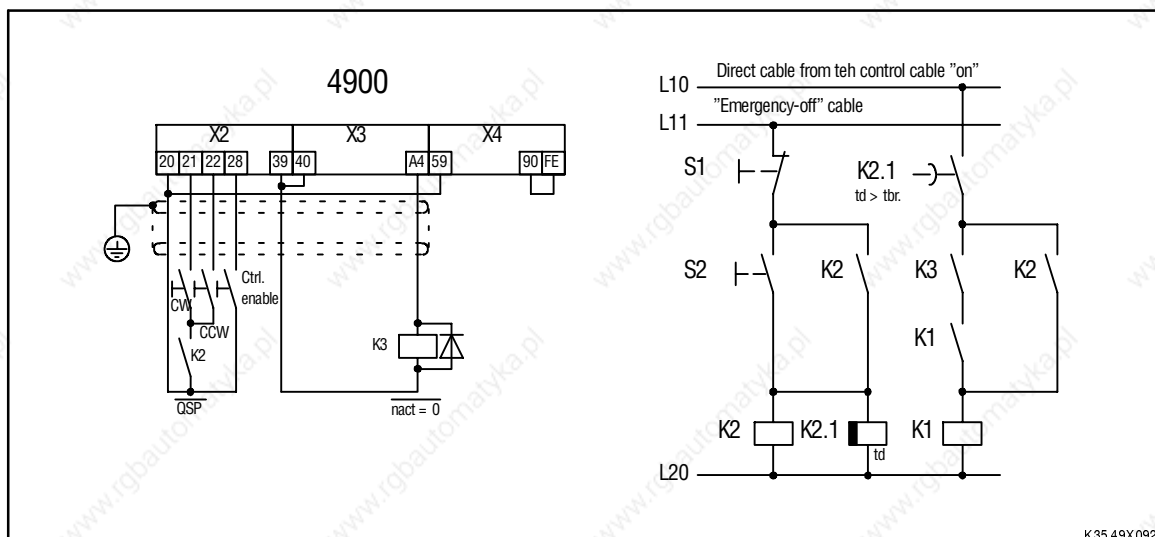
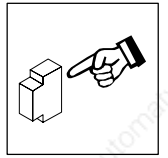
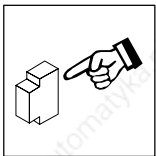

FIG 5-14 Example for the fastest possible switch-off in inverter operation



6 During operation

- Replace defective fuses with the prescribed type only when no voltage is applied.
- The overload protection of the motor ($I^2 \cdot t$) is not a full protection.
 - When switching the mains, the controller resets the calculated motor temperature. If the connected motor is already hot and is still overloaded, overheating cannot be excluded.
- The control mode 4Q (C180 = -0-) must not be set for controllers 48XX. If 4808 ... 4813 controllers are set to 4Q operation, fuses may blow.
- Note for hoist applications:
When the controller is inhibited, the drive does not generate a torque.



During operation

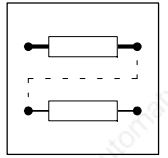

7 Configuration

7.1 Speed-controlled operation

The factory setting enables the immediate start of the drive in standard applications. To adapt the drive to special requirements, please read the following passages:

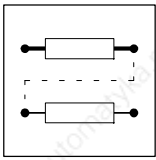

Configuration

7.1.1 Setpoint selection

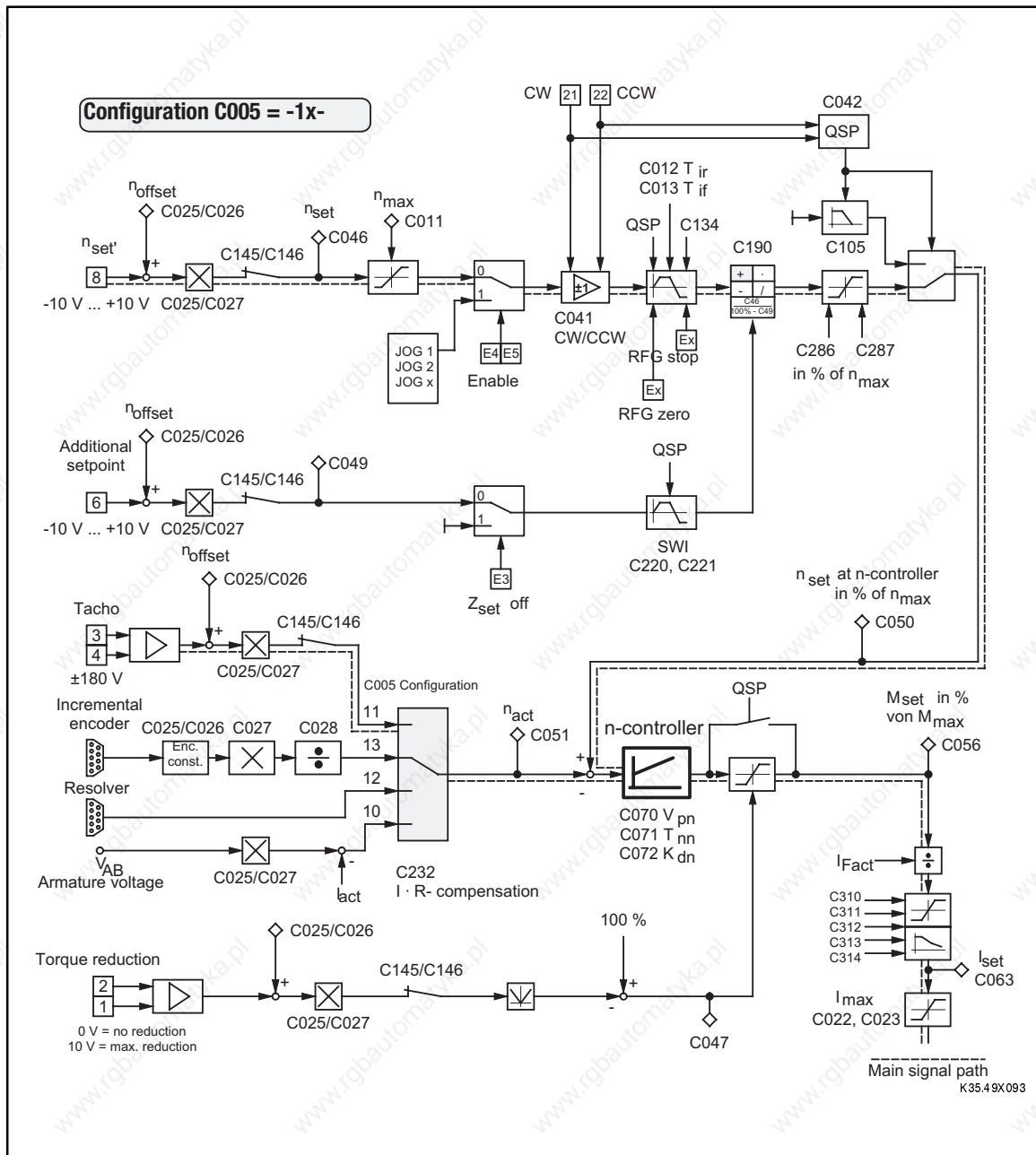

FIG 7-1 Signal flow chart of the setpoint processing for speed control with additional setpoint (C005 = -1X-) with factory setting



7.1.1.1 Main setpoint

The speed is determined through the setpoint n_{set} (C046) in relation to the adjustable value n_{max} (C011). The setpoint can be entered either via terminal X1/8 or as a digital frequency via X5 or X9, as well as via the keypad or the LECOM interface.

The operating mode set under C001 and the signal priority set under C145/C147 determine which input is active. The setpoint channel is selected first via the configuration. Under codes C145/C146, the signal sources can be reassigned.

Code	Name	Possible settings		Info
		Lenze	Selection	
C046	n_{set} speed		-100.0 % n_{max} {0.1 %} + 100.0 % n_{max}	Display only possible with analog signal source assignment (C001; C145/C146/C147). The parameter cannot be saved in the parameter set. If the signal source assignment is deactivated by "Load parameter set" or via C145/C146, the display value valid at that time will be kept.

7.1.1.2 Additional setpoint

Also with keypad or interface operation, an additional analog setpoint can be assigned to terminals X1/6 (or one of the other signal sources). The additional setpoint (C049 / setpoint 2) is internally connected to a ramp function generator before it is linked to the main setpoint in the "fixed" arithmetic block. The additional setpoint can be switched-off via X2/E3 (C280).

This function can be used, for instance, to deactivate a correction signal (dancer position, etc.) during set-up operation.

Code	Name	Possible settings		Info
		Lenze	Selection	
C049	Additional setpoint		-100.0 % n_{max} {0.1 %} + 100.0 % n_{max}	Display: additional setpoint
C220*	Acceleration time T_{ir} of the additional setpoint	0.00 s	0.00 s {0.01 s} 1 s 1 s {0.1 s} 10 s 10 s {1 s} 100 s 100 s {10 s} 990 s	
C221*	Deceleration time T_{if} of the additional setpoint	0.00 s	0.00 s {0.01 s} 1 s 1 s {0.1 s} 10 s 10 s {1 s} 100 s 100 s {10 s} 990 s	

7.1.1.3 JOG setpoints

If the main setpoint requires fixed settings, adjustable setpoints from the memory can be selected via JOG inputs. JOG setpoints replace the main setpoint. JOG setpoints are entered as relative values in % of n_{max} .



Configuration

Parameter setting of the JOG setpoints

The JOG setpoints are set in two steps:

- Select a JOG setpoint under C038.
- Enter the value for the selected JOG setpoint under C039.

Repeat these two steps for further JOG setpoints. A maximum of 15 JOG setpoints can be programmed.

Code	Name	Possible settings		
		Lenze	Selection	Info
C038.┐	Input selection: JOG setpoint	1	-1- Selection JOG1 -2- Selection JOG2 ... -15- Selection JOG15	Select JOG setpoint to be set under C039.
C039	JOG speed C038		-100 % n_{max} {0,1 %} +100.0 % n_{max} 100.0% JOG1 75.0% JOG2 50.0% JOG3 25.0% JOG4 0.0% JOG5 .. 0.0% JOG15	Enable JOG setpoints via the digital inputs or via C045.

Assignment of the digital inputs

The number of inputs to be assigned to the function "Enable JOG setpoint" depends on the number of JOG setpoints required.

Number of JOG setpoints required	Number of inputs required
1	at least 1
2...3	at least 2
4...7	at least 3
8...15	4

A maximum of four inputs can be assigned to this function. Please observe the notes given in chapter 5.8.

Enabling JOG setpoints with terminal control

To enable the JOG setpoints, the assigned digital inputs must be selected according to the table below.

	1. Input	2. Input	3. Input	4. Input
JOG 1	1	0	0	0
JOG 2	0	1	0	0
JOG 3	1	1	0	0
JOG 4	0	0	1	0
JOG 5	1	0	1	0
JOG 6	0	1	1	0
JOG 7	1	1	1	0
JOG 8	0	0	0	1
JOG 9	1	0	0	1
JOG 10	0	1	0	1

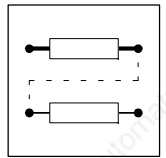

JOG 11	1	1	0	1
JOG 12	0	0	1	1
JOG 13	1	0	1	1
JOG 14	0	1	1	1
JOG 15	1	1	1	1

The input with the smallest number is the 1st input, the input with the next higher number is the 2nd input, etc. (e.g. E4 = 1. input, E5 = 2. input). C045 indicates the active setpoint.

Enabling JOG setpoints with control via keypad or LECOM interface

Activate the JOG setpoints under C045.

Code	Name	Possible settings		
		Lenze	Selection	Info
C045.1	JOG enable	0	-0- Main setpoint (C046) active -1- Setpoint JOG1 active ... -15- Setpoint JOG15 active	With terminal control, display only

7.1.1.4 Master current

Set the current setting range under C034 to enter the analog setpoint as master current via X1/8:

- For -20mA...+20mA: C034 = -0-
- For 4...20mA: C034 = -1- (only unipolar)

With the range 4...20mA, the error message "Sd5" is displayed if the current falls below 2mA.

Use the switch S3/1 on the control board 4902MP to change from master voltage to master current (current load 250Ω).

- Master voltage/potentiometer: S3/1 = OFF
(Factory setting)
- Master current: S3/1 = ON
(see chapter 4.3.4)

7.1.1.5 External torque reduction

By means of a potentiometer it is possible, for instance, to apply an external voltage to terminal 2, which has a direct effect on the I_{max} values set under C022 and C023.



Note!

A voltage of 0V applied to terminal X1/2 corresponds to I_{max} when C005 = -1X-, -5X-, -6X- or -72-.

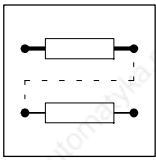

Configuration

The corresponding speed setpoint must be applied via terminal X1/8.

As an alternative to the setpoint potentiometer, it is also possible to have a linear effect on the current limitation via an external control voltage.

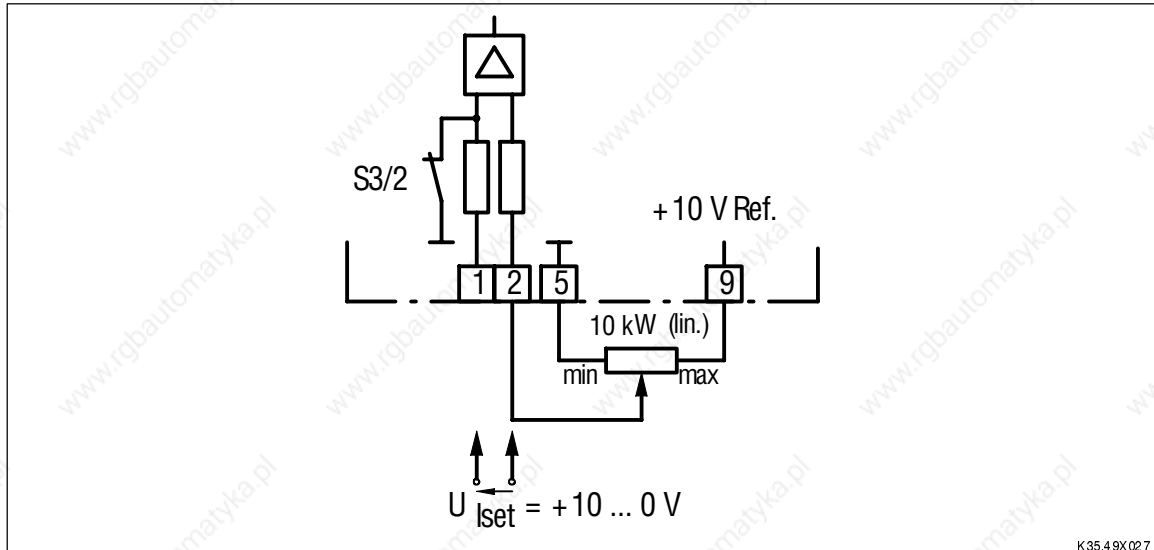

FIG 7-2 Connection diagram for external torque reduction via potentiometer or master voltage



Note!

To reduce the external wiring for standard applications without external torque control, the terminal input is inverted and a bias of 100% I_{max} is applied.

Function C047 = 100% - |Terminal (1,2)| can be changed to C047 = |Terminal (X5)| to select the torque limit (e.g. via digital frequency).

Code	Name	Possible settings		
		Lenze	Selection	Info
C282* ↓	Function C047	0	-0- Function C047 = 100% - [input source] -1- Function C047 = [input source]	

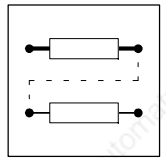

7.1.1.6 Acceleration and deceleration times T_{ir} , T_{if}

Each acceleration and deceleration time refers to a speed variation from 0 to n_{max} (C011). The times T_{ir} and T_{if} to be set can be calculated as follows:

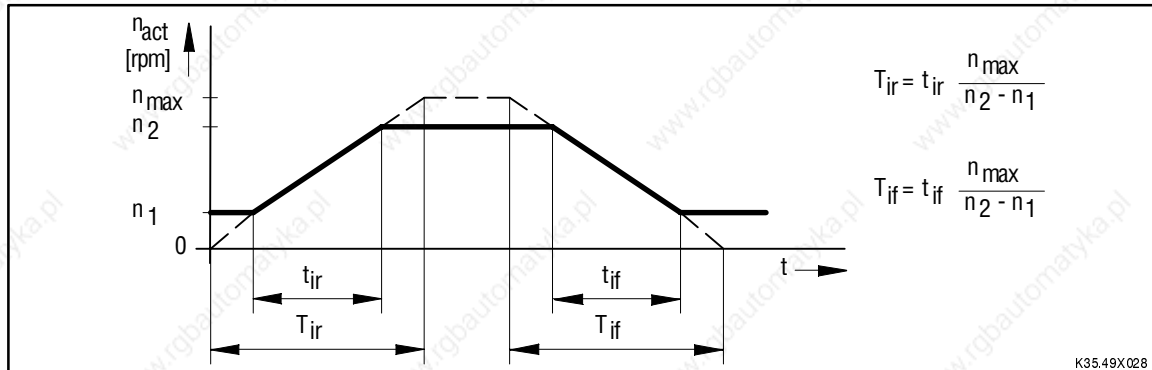

FIG 7-3 Calculation of the acceleration and deceleration times

In this case, t_{ir} and t_{if} correspond to the times required for changing from n_1 to n_2 and vice versa.

The calculated times T_{ir} and T_{if} are setting values for the controller.

- Acceleration and deceleration times C012 and C013

The ramp function generator of the main setpoint (n_{set} or JOG setpoint) is set via the times T_{ir} and T_{if} under C012 and C013.

- Additional acceleration and deceleration times

As an alternative to the acceleration and deceleration times under C012 and C013, additional T_{ir} and T_{if} times can be called up from the memory, for instance, to change the drive acceleration as from a certain speed.

Programming of additional acceleration and deceleration times

Set the additional T_i times in two steps. The selection made under C100 refers to value pairs of acceleration/deceleration times.

- Select an additional acceleration time / deceleration time under C100.
- Enter the acceleration time required under C101 and the deceleration time required under C103.

Repeat these two steps for additional T_i times if required.

A maximum of 15 additional acceleration and deceleration times can be programmed.

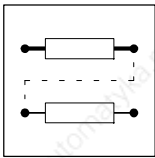

Configuration

Code	Name	Possible settings		
		Lenze	Selection	Info
C100* _↓	Selection: Additional acceleration/ deceleration time for main setpoint		-1- Acceleration time T_{ir1} /deceleration time T_{if1} -2- Acceleration time T_{ir2} /deceleration time T_{if2} ... -15- Acceleration time T_{ir15} /deceleration time T_{if15}	Extends T_{ir} (C012) and T_{if} (C013) by max. 15 additional value pairs. Changeable via C130: 1. Select additional times under C100. 2. Set C101 (T_{ir}) or C103 (T_{if}).
C101*	Acceleration time C100	0.00s	0 s {0.01 s} 1 s 1 s {0.1s} 10 s 10 s {1 s} 100 s 100 s {10 s} 990 s	Time referred to the speed change 0... n_{max}
C103*	Deceleration time C100	0.00s	0 s {0.01 s} 1 s 1 s {0.1s} 10 s 10 s {1 s} 100 s 100 s {10 s} 990 s	Time referred to the speed change 0... n_{max}

Assignment of the digital inputs

The number of inputs to be assigned to the function "Enable additional acceleration and deceleration times" depends on the number of additional T_i times.

Number of additional acceleration and deceleration times required	Number of inputs required
1	at least 1
2...3	at least 2
4...7	at least 3
8...15	4

A maximum of four inputs can be assigned to this function.
Please observe the notes given in chapter 5.8.

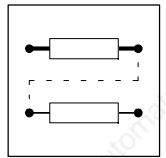

Enabling of additional acceleration and deceleration times

With terminal control, the inputs must be controlled according to the table below, to enable the additional acceleration and deceleration times. The T_i times can only be activated in pairs.

	1. Input	2. Input	3. Input	4. Input
T_{ir1}, T_{if1}	1	0	0	0
T_{ir2}, T_{if2}	0	1	0	0
T_{ir3}, T_{if3}	1	1	0	0
T_{ir4}, T_{if4}	0	0	1	0
T_{ir5}, T_{if5}	1	0	1	0
T_{ir6}, T_{if6}	0	1	1	0
T_{ir7}, T_{if7}	1	1	1	0
T_{ir8}, T_{if8}	0	0	0	1
T_{ir9}, T_{if9}	1	0	0	1
T_{ir10}, T_{if10}	0	1	0	1
T_{ir11}, T_{if11}	1	1	0	1
T_{ir12}, T_{if12}	0	0	1	1
T_{ir13}, T_{if13}	1	0	1	1
T_{ir14}, T_{if14}	0	1	1	1
T_{ir15}, T_{if15}	1	1	1	1

The input with the smallest number is the 1st input, the input with the next higher number is the 2nd input, etc. (e.g. E4 = 1. input, E5 = 2. input).

C130 displays the active T_i times.

With control via keypad or LECOM interfaces, C130 activates the T_i times in pairs.

Code	Name	Possible settings		
		Lenze	Selection	Info
C130* _↵	Enabling of additional T_i times	0	-0- T_{ir} (C012) / T_{if} (C013) active -1- T_{ir1} / T_{if1} active ... -15- T_{ir15} / T_{if15} active	If the T_i times are enabled via terminal, C130 is a display parameter only.

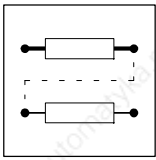

Configuration

7.1.1.7 Limiation of the speed setpoint

The main and additional setpoints are linked via the arithmetic block 1 and then limited via an adjustable limiting element (C286, C287). This function can be used if, depending on the process to be controlled, certain positive or negative values must not be exceeded.

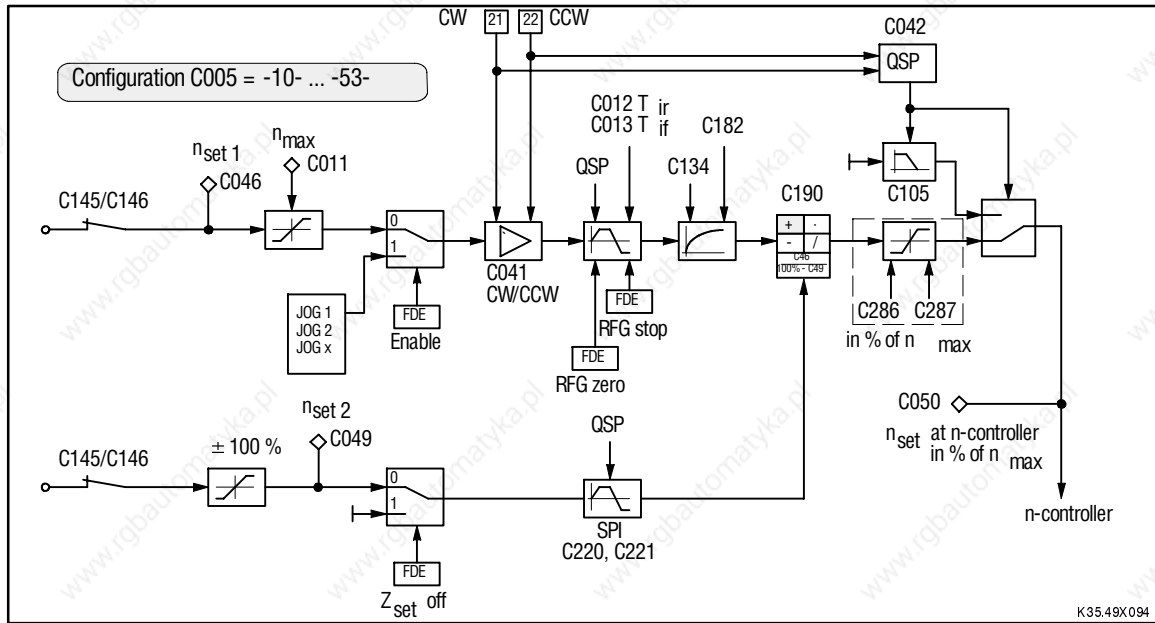
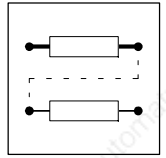

FIG 7-4 Signal flow chart for speed setpoint selection with limiting element

Code	Name	Possible settings		Info
		Lenze	Selection	
C286* _↓	Upper limit of the speed setpoint	180%	-100.0 % {0.1 %} +100.0 % -180 % {1 %} +180 %	Upper limit of the speed setpoint for C050 C286 must be higher than C287!
C287* _↓	Lower limit of the speed setpoint	-180%	-100.0 % {0.1 %} +100.0 % -180 % {1 %} +180 %	Lower limit of the speed setpoint for C050 C287 must be lower than C286!



7.1.2 Actual value feedback

7.1.2.1 Armature voltage feedback

For speed control with armature voltage feedback, the actual speed signal is generated by means of an internal armature voltage detection. Select via C005 = -10- or -40-. The value under C232 (0 ... 30% of C090 adjustable) compensates the speed error which is generated by the $I \cdot R$ component of the armature voltage.

Select the "I-R compensation" such that a minimum speed error between loading and unloading of the motor is achieved.



Stop!

- With this configuration, field weakening operation is not possible.
 - With this configuration, the armature circuit must be monitored externally since an "armature circuit break" (ACI) cannot be clearly detected internally.
-

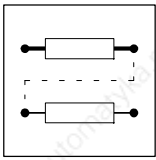

Configuration

7.1.2.2 DC tacho feedback

The terminals X1/3 and X1/4 are used for actual speed feedback. The tacho signal is conditioned by a differential amplifier.



Stop!

When adjusting the tacho voltage, ensure that the maximum tacho limit of 180V is not exceeded during field weakening operation.

Configurations possible under C005:

- 11- Speed control with tacho feedback (factory setting)
- 41- Torque control with speed limitation

For speed control with tacho feedback, the analog actual value encoder must be adjusted.

Adjustment of the tacho signal:

Offset and gain of analog inputs can be adjusted. It is thus possible to correct encoder or transmission errors. The adjustment refers to n_{\max} (C011).

n_{set} adjustment (main setpoint)

1. Inhibit controller via terminal X2/28.
2. Select max. setpoint at X1/8.
3. Select -4- under C025 ("Encoder selection").
4. Select C029 ("Automatic adjustment") and adjust the maximum setpoint to 100 % using ▲ or ▼.
(Adjustment of level tolerances in the setpoint channel)
5. Confirm adjustment with SH + PRG.
6. Set the speed setpoint to approx. 50%.

n_{act} adjustment



Stop!

The addition of the mains setpoint and the additional setpoint is limited to 180% of n_{\max} ! It is therefore possible to achieve a motor speed of $1.8 \cdot n_{\max}$ by adding the additional setpoint.

Observe max. motor speed and rated motor voltage!

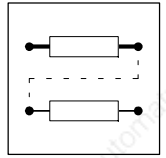

Note!

If the field terminals (I, K) or the actual value encoder (resolver, tacho) is reversed, TRIP will be indicated (see chapter 8.1). After checking and correcting the wiring, the controller can be commissioned again. After reaching a stable speed, the speed can be adjusted according to the requirements (for tacho feedback only).

1. Adjust the rated tacho voltage to the 4902MP board via DIP switches (see chapter 4.3.4).
2. Select -2- under C025 ("Encoder selection").
3. Select C029 ("Automatic adjustment").
4. Enable the controller (X2/28).
5. Machine accelerates to speed xxx.
6. Measure the speed using a hand tacho.
7. Enter the measured speed (C029) using the keypad.
8. Confirm with SH + PRG.
9. The value is accepted and the machine accelerates with the T_i time of the ramp function generator until the correct speed is reached.

Adjustment of the additional setpoint

Z_{set} is an additional speed setpoint to link a correction signal with the main setpoint in the arithmetic block (e.g. dancer position control, correction signal of a synchronisation system, correction signal via terminal for main setpoint selection via serial interface, etc.). For adjustment, select C025 = -3- and then program the required value under C027 or C029.

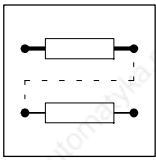

Configuration

7.1.2.3 Resolver feedback

With the following configurations of C005, a resolver can be used as a speed and angle feedback system. Connect the resolver via terminal X7. It is not necessary to adjust the resolver since the resolution is determined by the evaluation system. Configurations possible under C005 are:

- 12- Speed control
- 42- Torque control with speed limitation
- 52- Master with angle control
- 62- Digital frequency bus (setpoint bus) with angle control
- 72- Digital frequency cascade with angle control

7.1.2.4 Incremental encoder feedback

With the following configurations of C005, an incremental encoder can be used as a speed and angle feedback system. Connect the incremental encoder via X5 or X9. An encoder constant can be adjusted directly, by means of the standard binary pulses under C025 / C026. Encoder pulses which do not correspond to the standard can be adjusted via the evaluation factor under C027 and C028. Configurations possible under C005:

- 13- Speed control with actual value feedback via X9
- 43- Torque control with speed limitation
(Actual value feedback via X9)
- 53- Master with angle control (Actual value feedback via X5)
- 63- Digital frequency bus (setpoint bus) with angle control
(Actual value feedback via X5)

Resolution:	1. Encoder	8192 incr./rev.	= 0.45 rpm
	2. Encoder	4096 incr./rev.	= 0.91 rpm
	3. Encoder	2048 incr./rev.	= 1.82 rpm
	4. Encoder	1024 incr./rev.	= 3.64 rpm
	5. Encoder	512 incr./rev.	= 7.28 rpm
	6. Encoder	256 incr./rev.	= 14.56 rpm

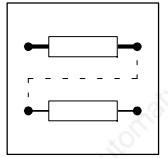

7.2 Parameter setting

- With the parameter setting of the controller you can adapt the drive to your application.
- The complete parameter set is organized in codes which are consecutively numbered and start with "C" (chapter 7.3).
- It is possible to save the parameter set for an application.
 - Four parameter sets are available, so that the controller can be easily switched from one application to another.
 - The parameter sets 1, 3 and 4 are factory-set when delivered. Parameter set 2 is set for an unwinder with diameter precontrol.

7.2.1 Ways of parameter setting

- It is possible to select a code, to change the parameters and transfer the changes to the controller, via
 - the operating unit of the controller
 - LECOM interfaces

These Operating Instructions only describe the change of parameters via the operating unit.

The description of parameter setting via LECOM interfaces or fieldbus systems can be obtained from the corresponding Operating Instructions.



Configuration

7.2.2 Functions of the operation unit

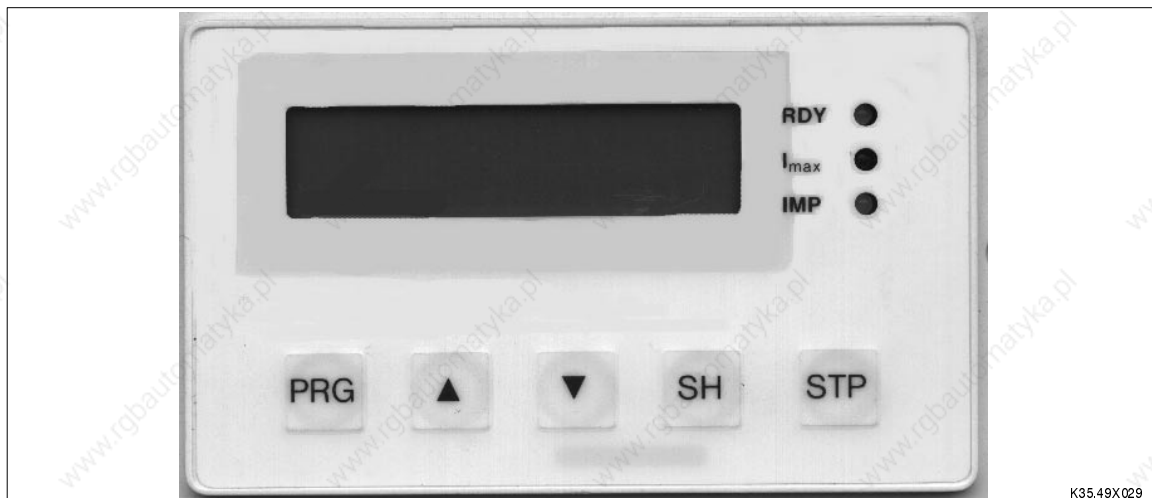

FIG 7-5 Front view: Operating unit with status display

LED	Colour	Function
RDY	green	Ready for operation not on in the event of TRIP
I _{max}	red	on, if the speed controller operates at current limit
IMP	yellow	Pulse inhibit on, if the controller is inhibited or message LU is displayed

Bedientaste	Key function
PRG	Change between code and parameter level
SH+ PRG	Accept change
▲	Increase displayed value
SH+ ▲	Increase displayed value fast
▼	Decrease displayed value
SH+ ▼	Decrease displayed value fast
STP	Inhibit controller
SH+ STP	Enable controller



Note!

- 'SH +'
 - Press and hold key SH.
 - Press second key indicated.
- Display
 - The position of the arrow "→" indicates the current operating level (code or parameter level).

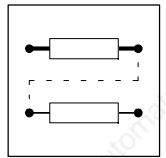

7.2.3 Operating modes

The controller can be adapted to your application in different ways:

- Terminals:** The terminals are to control the controller.
- Operating unit:** There are five keys and the plain text display on the operating unit for parameter setting and control of the controller.
- LECOM1:** LECOM1 is a protocol for control and parameter setting of the unit via a PC or other hosts. The signals are processed to the interface standards RS232C and RS485. The controller can be connected to a superimposed system via X6.
- LECOM2:** For very difficult requirements, the controller can be parameter- set and operated with LECOM 2 via fieldbus connection modules for standard bus systems (InterBus-S, PROFIBUS etc.).

Code	Name	Possible settings		Info																											
		Lenze	Selection																												
C001	Operating mode	0	<table border="0"> <tr> <td></td> <td>Control</td> <td>Parameter setting</td> </tr> <tr> <td>-0-</td> <td>Terminals</td> <td>Keypad</td> </tr> <tr> <td>-1-</td> <td>Keypad</td> <td>Keypad</td> </tr> <tr> <td>-2-</td> <td>Terminals</td> <td>LECOM1</td> </tr> <tr> <td>-3-</td> <td>LECOM1</td> <td>LECOM1</td> </tr> <tr> <td>-4-</td> <td>Terminals</td> <td>LECOM2 (*)</td> </tr> <tr> <td>-5-</td> <td>LECOM2 (*)</td> <td>LECOM2 (*)</td> </tr> <tr> <td>-6-</td> <td>LECOM2 (*)</td> <td>Keypad</td> </tr> <tr> <td>-7-</td> <td>LECOM2 (*)</td> <td>LECOM1</td> </tr> </table>		Control	Parameter setting	-0-	Terminals	Keypad	-1-	Keypad	Keypad	-2-	Terminals	LECOM1	-3-	LECOM1	LECOM1	-4-	Terminals	LECOM2 (*)	-5-	LECOM2 (*)	LECOM2 (*)	-6-	LECOM2 (*)	Keypad	-7-	LECOM2 (*)	LECOM1	<p>With C001 = -2-, -3-, -4-, -5-, -7-, TRIP must be reset (C043) via the interface or the terminal. With LECOM2, TRIP reset is also possible via the control word of the process data channel.</p> <p>(*) Fieldbus</p>
	Control	Parameter setting																													
-0-	Terminals	Keypad																													
-1-	Keypad	Keypad																													
-2-	Terminals	LECOM1																													
-3-	LECOM1	LECOM1																													
-4-	Terminals	LECOM2 (*)																													
-5-	LECOM2 (*)	LECOM2 (*)																													
-6-	LECOM2 (*)	Keypad																													
-7-	LECOM2 (*)	LECOM1																													



Note!

With control via keypad, LECOM1 and LECOM2, the terminal functions controller enable (X1/28), quick stop (X1/21 and X1/22) and the additional setpoint (X1/6) remain the same in the configurations C005 = -1X-, -4X-, -5X-.

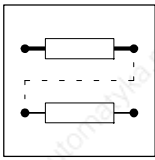

Configuration

7.2.4 Display functions

Code set

The factory setting is the display of the standard code set.

The extended code set is displayed when selecting C000 = -2-.

Code	Name	Possible settings			Info
		Lenze	Selection		
C000 _┘	Code set	1	-0- -1- -2- -9- -11-	(+PW) Standard code set read only (+PW) Standard code set (+PW) Extended code set For service only Code set automation module	Can only be changed via keypad! If a password is defined under C094, a change from -0- to -1- or -2- is only possible after entering this password (+PW): 1. Change C000, acknowledge with SH + PRG. 2. Password setting with ▲ or ▼. 3. Accept with SH + PRG.
C094* _┘	User password	0	0	{1} 999	0 = No password protection (see also C000)

Language

Code	Name	Possible settings			Info
		Lenze	Selection		
C098	Language	0	-0- -1- -2-	German English French	

Actual value displays

Code	Name	Possible settings			Info
		Lenze	Selection		
C051	n_{act} speed		-5000 rpm	{1 rpm} +5000 rpm	Display: actual speed
C052*	Motor voltage		0 V	{1 V} 600 V	Display: motor voltage V_A
C054	Motor current		0.0 A	{0.1 A} 100 A 100 A {1 A} 2000 A	Display: motor current I_A
C056	Torque setpoint		-100.0 % M_{max}	{0.1 %} +100.0 % M_{max}	Display: Torque setpoint Armature setting range: 100% M_{max} correspond to 100% I_{max} (C022, C023)
C060*	Rotor position		0...2047		Display: absolute rotor angle position, standardized to 2048 incr./rev. Incremental encoder feedback: display only after zero track pulse.
C061*	I-t load		0.0 %	{0.1 %} 105.0%	Display: "I-t load". Starting value when switching on the mains is always 100 % !
C185	P_{motor}		-500.0 kW	{0.1 kW} 500.0 kW	Display: actual motor power
C186	M_{motor}		-999 Nm	{1 Nm} 999 Nm	Display: actual motor torque
C187	I_{Fset}		0.00 A	{0.01 A} 50.0 A	Display: actual field current setpoint
C188	I_{Fact}		0.00 A	{0.01 A} 50.0 A	Display: actual field current value
C189	f_{mains}		0.0 Hz	{0.1 Hz} 100.0 Hz	Display: actual mains frequency

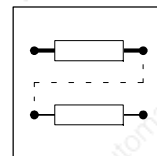

Switch-on display

After switching on the controller, C083 is displayed first (field current). To change the switch-on display, enter the required code number under C004.

Code	Name	Possible settings			Info
		Lenze	Selection		
C004	Switch-on display	83	0	{1} 999	Code No. for switch-on display: Can only be changed if C001= -0-, -1-, -6-

Identification

The controller type is indicated under C093.

Code C099 indicates the software version used.

Code	Name	Possible settings			Info
		Lenze	Selection		
C093*	Device identification		49XX		Display: controller type
C099*	Software versions		49 6.X		Display: Series and software version



Configuration

7.3 Code table

How to read the code table:

Column	Abbreviation	Meaning
Code	C013	Code C013 • The parameter value is accepted immediately (ONLINE).
	C009*	• Code of the extended code set
	C001┘	• The parameter value of the code will be accepted after pressing SH+ PRG.
	[C002]	• The parameter value of the code will be accepted after pressing SH+ PRG, but only if the controller is inhibited.
Name		Name of the code
Lenze		Factory setting of the code
Selection	1 {1 %} 99	Minimum value {smallest step/unit} maximum value
Info	-	Additional, important explanation of the code

Code	Name	Possible settings			Info
		Lenze	Selection		
C000┘	Code set	1	-0- -1- -2- -9- -11-	(+ PW) Standard code set read only (+ PW) Standard code set (+ PW) Extended code set For service only Code set for automation module	Can only be changed via keypad! If a password is defined under C094, a change from -0- to -1- or -2- is only possible after entering this password (+ PW); 1. Change C000, acknowledge with SH + PRG. 2. Password setting with ▲ or ▼. 3. Accept with SH + PRG.
[C001]	Operating mode	0	-0- -1- -2- -3- -4- -5- -6- -7-	Terminals Keypad Keypad Keypad Terminals LECOM1 LECOM1 LECOM1 Terminals LECOM2 (*) LECOM2 (*) LECOM2 (*) LECOM2 (*) Keypad LECOM2 (*) LECOM1	With C001 = -2-, -3-, -4-, -5-, -7-, TRIP must be reset (C043) via the interface or the terminal. With LECOM2, TRIP reset is also possible via the control word of the process data channel.
[C002]	Load parameter set	0	-0- -1- -2- -3- -4-	Factory setting Parameter set 1 Parameter set 2 Parameter set 3 Parameter set 4	Parameter set 1 is automatically loaded after mains connection. If another parameter set is selected via terminal, this parameter set will also be loaded.
C003┘	Save parameter set	1	-1- -2- -3- -4-	Parameter set 1 Parameter set 2 Parameter set 3 Parameter set 4	
C004┘	Switch-on display	83	0 {1} 999		Code No. for switch-on display: Can only be changed if C001= -0-, -1-, -6-

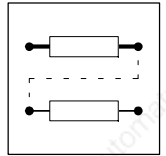

Code	Name	Possible settings		Info
		Lenze	Selection	
[C005*]	Configuration	11	<p>Speed control with additional setpoint</p> <p>-10- Armature voltage control n_{set}: analog at X1/8 n_{add}: analog at X1/6 M_{limit}: analog at X1/1, 1/2.</p> <p>-11- Act. value encoder: tacho at X1/3, X1/4 n_{set}: analog at X1/8 n_{add}: analog at X1/6 M_{limit}: analog at X1/1, X1/2</p> <p>-12- Act. value encoder: resolver at X7 n_{set}: analog at X1/8 n_{add}: analog at X1/6 M_{limit}: analog at X1/1, X1/2</p> <p>-13- Act. value encoder: increment. encoder at X9 n_{set}: analog at X1/8 n_{add}: analog at X1/6 M_{limit}: analog at X1/1, X1/2</p> <p>Torque control with speed limitation and additional setpoint</p> <p>-40- Armature voltage control n_{set}: analog at X1/8 n_{add}: analog at X1/6 M_{set}: analog at X1/1, 1/2.</p> <p>-41- Act. value encoder: tacho at X1/3, X1/4 n_{set}: analog at X1/8 n_{add}: analog at X1/6 M_{set}: analog at X1/1, 1/2.</p> <p>-42- Act. value encoder: resolver at X7 n_{set}: analog at X1/8 n_{add}: analog at X1/6 M_{set}: analog at X1/1, X1/2</p> <p>-43- Act. value encoder: increment. encoder at X9 n_{set}: analog at X1/8 n_{add}: analog at X1/6 M_{set}: analog at X1/1, X1/2</p> <p>Dig. freq. of master with additional setpoint</p> <p>-52- Act. value encoder: resolver at X7 n_{set}: analog at X1/8 n_{add}: analog at X1/6 M_{limit}: analog at X1/1, X1/2</p> <p>-53- Act. value encoder: increment. encoder at X5 n_{set}: analog at X1/8 n_{add}: analog at X1/6 M_{limit}: analog at X1/1, X1/2</p> <p>Digital frequency bus</p> <p>-62- Act. value encoder: resolver at X7 n_{set}: digital at X9 M_{limit}: analog at X1/1, X1/2</p> <p>-63- Act. value encoder: increment. encoder at X5 n_{set}: digital at X9 M_{limit}: analog at X1/1, X1/2</p> <p>Digital frequency cascade</p> <p>-72- Actual value encoder: resolver at X7 n_{set}: digital, X5 M_{limit}: analog at X1/1, X1/2</p>	<p>If C005 = -10- or -40-, field control override is not possible.</p> <p>A change of the configuration changes the control structure and the terminal assignment and activates important monitoring functions.</p> <p>Change monitoring functions: C119 / C120</p> <p>Change terminal signals: C145 / C146.</p>
C009*↵	Controller address	1	1 {1} 99	<p>Bus participant number for operation via interface: Parameter 10 reserved for broadcasting to groups of participants. Can only be changed with C001 = -0- and -1-.</p>

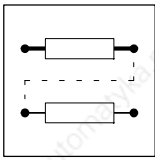

Configuration

Code	Name	Possible settings			Info
		Lenze	Selection		
C011	n_{max} speed	3000 rpm	250 rpm	{1 rpm} 5000 rpm	n_{max} is the reference for the analog and relative setpoint selection as well as for the acceleration and deceleration times. Parameter setting via interface: Inhibit the controller before substantial parameters changes.
C012	Acceleration time T_{if} for main setpoint	0.00s	0.00 s	{0.01 s} 1 s 1 s {0.1 s} 10 s 10 s {1 s} 100 s 100 s {10 s} 990 s	Time refers to 0... n_{max}
C013	Deceleration time T_{if} for main setpoint	0.00s	0.00 s	{0.01 s} 1 s 1 s {0.1 s} 10 s 10 s {1 s} 100 s 100 s {10 s} 990 s	Time refers to 0... n_{max}
C017*	Threshold $n_{act} \leq n_x$	-3000 rpm	-5000 rpm	{1 rpm} +5000 rpm	If the actual speed falls below the comparison speed n_x , the corresponding output will be activated.
C019*	Threshold $n_{act} = 0$	50 rpm	0 rpm	{1 rpm} 5000 rpm	If the actual speed falls below the threshold, the corresponding output will be activated.
C022	+ I_{max} limit	Rated controller current	Current limit of thyristor bridge 1 0 {0.1A} 100A 100A {1A} 1200A		Current limit depends on controller: 29A (4902) 45A (4903) 90A (4904) 150A (4905) 240A (4906) 300A (4907) 400A (4X08) 600A (4X09) 840A (4X11) 1200A (4X12) 1350A (4X13)
C023	- I_{max} limit		Current limit of thyristor bridge 2 0 {0.1A} 100A 100A {1A} 1200A		
C025-1	Input selection: Input adjustment	2	-1- -2- -3- -4- -5- -10 -11- -12- -13-	Terminals X1/1, X1/2 Terminals X1/3, X1/4 Terminal X1/6 Terminal X1/8 Armature voltage feedback Digital frequency input X5 Digital frequency input X9 Resolver X7 Encoder output X8	Select (under C025) the input which is to be adjusted with C026, C027, C028 or C029.

Configuration

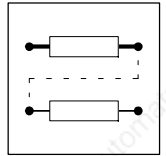

Code	Name	Possible settings		Info
		Lenze	Selection	
C026	Encoder constant for C025	0mV	C025 = -1-, -2-, -3-, -4-: Offset correction of the analog inputs -9999mV {1mV} +9999mV	The encoder constants are not overwritten the factory setting is loaded.
		0V	C025 = -5-: Offset correction of the armature voltage feedback -100V {1V} +100V	
		1	C025 = -10-, -11-: Encoder constant of the digital frequency inputs -0- 8192 increments / revolution -1- 4096 increments / revolution -2- 2048 increments / revolution -3- 1024 increments / revolution -4- 512 increments / revolution -5- 256 increments / revolution	
		3	C025 = -13-: Encoder constant of the encoder outputs with resolver feedback -1- 256 increments / revolution -2- 512 increments / revolution -3- 1024 increments / revolution -4- 2048 increments / revolution	
C027	Gain factor for C025	1.000	C025 = -1-, -2-, -3-, -4-: Gain factor of the analog inputs -2.500 {0.001} +2.500	If an analog signal source (C145/C146) is assigned, only the parameter will be displayed.
		1.000	C005 = -11-, -41-: Gain factor of the tachometer input X1/3, X1/4 0.010 {0.001} +9.999	
		1.010	C025 = -5-: Gain factor of the armature voltage feedback 0.100 {0.001} +9.999	
		0.1000	C025 = -10-, -11-: Gain factor of the digital frequency inputs -3.2767 {0.0001} +3.2767	
		1.000	C025 = -12-: Gain factor of the resolvers -32.767 {0.001} +32.767	
C028	Divisor for C025	0.1000	C025 = -10-, -11-: Divisor for the digital frequency inputs 0.0001 {0.0001} 3.2767	
C029	Automatic adjustment for C025			Applies to all configurations: If an automatic adjustment is not possible, the previous value will be maintained. --ok-- will not be displayed.
			C025 = -1-, -2-, -3-, -4-: Automatic adjustment for analog inputs -100% {0.1%} 100.0%	1. Inhibit controller. 2. Set the setpoint at the terminal selected 3. Enter the corresponding value. 4. C027 displays the calculated gain factor
			C025 = -2- and tachometer at X1/3, X1/4 or C025 = -5- and actual value from armature voltage feedback: n_{act} adjustment 0 rpm {1rpm} 5000rpm	Adjustment during operation: 1. Display of actual speed. 2. Measure real speed with hand tachometer. 3. Enter real speed. 4. Drive accelerates to this speed. 5. C027 displays the calculated gain factor.



Configuration

Code	Name	Possible settings		Info
		Lenze	Selection	
C029.┘	Automatic adjustment for C025		C025 = -10-, -11-: Adjustment of the digital frequency inputs X5, X9 -100.0% {0.1%} 100.0%	Automatic adjustment only possible, if X5 or X9 are not selected as actual speed inputs: 1. Display of actual output value. 2. Enter required output value. 3. C027 displays the calculated gain factor.
			C025 = -12-: Adjustment of the resolver -100.0% {0.1%} 100.0%	Automatic adjustment is only possible, if the resolver is not used as a speed feedback system: 1. Display of actual output value. 2. Enter required output value. 3. C027 displays the calculated gain factor.
C030.┘	Constant for the digital frequency output	1	-0- 8192 increments / revolution -1- 4096 increments / revolution -2- 2048 increments / revolution -3- 1024 increments / revolution -4- 512 increments / revolution -5- 256 increments / revolution	Number of increments per revolution for the digital frequency output
C032*	Ratio numerator	0.1000	-3.2767 {0.0001}3.2767	Ratio numerator for configurations with digital frequency If an analog signal source is assigned (C145/146), only the parameter will be displayed.
C033*	Ratio denominator	0.1000	0.0001 {0.0001}3.2767	Ratio denominator for configurations with digital frequency
C034*.┘	Master current	0	-0- $i_{\text{master}} = -20 \text{ mA} \dots +20 \text{ mA}$ -1- $ i_{\text{master}} = 4 \text{ mA} \dots 20 \text{ mA}$	For master current input, the switch S3/1 must be set to ON. C034 = -1-: If $i_{\text{master}} < 2 \text{ mA}$, the monitoring message Sd5 will be displayed.
C038.┘	Input selection: JOG setpoint	1	-1- Selection JOG1 -2- Selection JOG2 ... -15- Selection JOG15	Select JOG setpoint to be set under C039.
C039	JOG speed for C038		-100.0 % n_{max} {0.1 %} + 100.0 % n_{max} 100.0% JOG1 75.0% JOG2 50.0% JOG3 25.0% JOG4 0.0% JOG5 0.0% JOG15	Enable JOG setpoints via the digital inputs or via C045.
C040	Controller enable		-0- Controller inhibited -1- Controller enabled	Input only via LECOM1 or LECOM2. C183 indicates the source which has inhibited the controller.
C041.┘	CW/CCW direction of rotation		-0- Main setpoint not inverted -1- Main setpoint inverted	Input only with control via keypad or interface. Display only with terminal control.
C042.┘	Quick stop		-0- No quick stop (corresponds to X2/21 or X2/22 = HIGH) -1- Quick stop active (corresponds to X2/21 and X2/22 = LOW) Drives decelerates to standstill following the quick-stop ramp C105.	Input only with control via keypad or interface. Display only with terminal control.

Configuration



Code	Name	Possible settings		Info
		Lenze	Selection	
C043* ₁	TRIP reset		-0- Read: no fault Write: reset fault -1- Read: fault	Only selectable via the interfaces.
C045 ₁	JOG enable	0	-0- Main setpoint (C046) active -1- Setpoint JOG1 active ... -15- Setpoint JOG15 active	Display only with terminal control.
C046	n_{set} speed		-100.0 % n_{max} {0.1 %} + 100.0 % n_{max}	Display only possible with analog signal source assignment (C001; C145/C146/C147). The parameter cannot be saved in the parameter set. If the signal source assignment is deactivated by "Load parameter set" or via C145/C146, the display value valid at that time will be kept.
C047	Torque limit		-100.0 % M_{max} {0.1 %} + 100.0 % M_{max}	Display only possible with analog signal source assignment (C001; C145/C146/C147). The parameter cannot be saved in the parameter set. If the signal source assignment is deactivated by "Load parameter set" or via C145/C146, the display value valid at that time will be kept.
C049	Additional setpoint		-100.0 % n_{max} {0.1 %} + 100.0 % n_{max}	Display: additional setpoint
C050	n_{set} at controller		-180.0 % n_{max} {0.1 %} + 180.0 % n_{max}	Display: speed setpoint at the input of the speed controller
C051	n_{act} speed		-5000 rpm {1 rpm} + 5000 rpm	Display: actual speed
C052*	Motor voltage		0 V {1 V} 600 V	Display: motor voltage V_A
C054	Motor current		0.0 A {0.1 A} 100 A 100 A {1 A} 2000 A	Display: motor current
C056	Torque setpoint		-100.0 % M_{max} {0.1 %} + 100.0 % M_{max}	Display: Torque setpoint Armature setting range: 100% M_{max} correspond to 100% I_{max} (C022, C023)
C060*	Rotor position		0...2047	Display of the absolute angle position of the rotor, standardized to 2048 incr./rev. With incremental encoder feedback, display only after zero track pulse occurred.
C061*	I-t load		0,0 % {0.1 %} 105,0%	Display: "I-t load" Starting value when switching on the mains is always 100 % !
C063	I_{set} at controller		-100.0 % I_{max} {0.1 %} + 100.0 % I_{max}	Display: current setpoint at current controller input



Configuration

Code	Name	Possible settings		Info																																								
		Lenze	Selection																																									
C065	Fault indication: message		<table border="0"> <thead> <tr> <th>Display</th> <th>Meaning</th> </tr> </thead> <tbody> <tr> <td>---</td> <td>no message</td> </tr> <tr> <td>EEr</td> <td>external TRIP (from terminal)</td> </tr> <tr> <td>LF</td> <td>mains frequency fault $f_{\text{mains}} < 47\text{Hz}$</td> </tr> <tr> <td>LU</td> <td>Undervoltage</td> </tr> <tr> <td>LU1</td> <td>faulty phase, mains interruptions</td> </tr> <tr> <td>OF</td> <td>mains frequency fault $f_{\text{mains}} > 63\text{Hz}$</td> </tr> <tr> <td>P03</td> <td>following error (tolerance exceeded)</td> </tr> </tbody> </table>	Display	Meaning	---	no message	EEr	external TRIP (from terminal)	LF	mains frequency fault $f_{\text{mains}} < 47\text{Hz}$	LU	Undervoltage	LU1	faulty phase, mains interruptions	OF	mains frequency fault $f_{\text{mains}} > 63\text{Hz}$	P03	following error (tolerance exceeded)	<p>When a message occurs:</p> <ol style="list-style-type: none"> The display changes to C065. The message blinks until the fault is reset. Depending on the configuration of C119 / C120, the drive can inhibit itself while the message is displayed and restart when the fault has been reset. The message is entered into the history buffer of C065. The last 8 entries can be displayed by pressing \blacktriangledown and \blacktriangle. The message saved last is displayed first. The history buffer is cleared when switching on the mains. 																								
Display	Meaning																																											
---	no message																																											
EEr	external TRIP (from terminal)																																											
LF	mains frequency fault $f_{\text{mains}} < 47\text{Hz}$																																											
LU	Undervoltage																																											
LU1	faulty phase, mains interruptions																																											
OF	mains frequency fault $f_{\text{mains}} > 63\text{Hz}$																																											
P03	following error (tolerance exceeded)																																											
C066	Fault indication: Warning		<table border="0"> <thead> <tr> <th>Display</th> <th>Meaning</th> </tr> </thead> <tbody> <tr> <td>---</td> <td>no warning</td> </tr> <tr> <td>ACI</td> <td>armature circuit break</td> </tr> <tr> <td>CE0</td> <td>communication error (automation interface)</td> </tr> <tr> <td>CE9</td> <td>communication error (serial interface)</td> </tr> <tr> <td>dEr</td> <td>motor blocked or field break</td> </tr> <tr> <td>EEr</td> <td>external TRIP (from terminal)</td> </tr> <tr> <td>FCI</td> <td>interruption of the excitation circuit</td> </tr> <tr> <td>OC5</td> <td>I-t overload (controller protection)</td> </tr> <tr> <td>OC6</td> <td>I²-t overload (motor protection)</td> </tr> <tr> <td>OH</td> <td>overtemperature heat sink</td> </tr> <tr> <td>QUE</td> <td>mains overvoltage</td> </tr> <tr> <td>P03</td> <td>following error (tolerance exceeded)</td> </tr> <tr> <td>Sd1</td> <td>short circuit or interruption of tacho</td> </tr> <tr> <td>Sd2</td> <td>open circuit of resolver</td> </tr> <tr> <td>Sd3</td> <td>encoder fault at X5</td> </tr> <tr> <td>Sd4</td> <td>encoder fault at X9</td> </tr> <tr> <td>Sd5</td> <td>master current $< 2\text{mA}$ with C034 = -1-</td> </tr> <tr> <td>SP</td> <td>wrong signal source polarity</td> </tr> <tr> <td>U15</td> <td>$\pm 15\text{V}$ supply voltage is missing</td> </tr> </tbody> </table>	Display	Meaning	---	no warning	ACI	armature circuit break	CE0	communication error (automation interface)	CE9	communication error (serial interface)	dEr	motor blocked or field break	EEr	external TRIP (from terminal)	FCI	interruption of the excitation circuit	OC5	I-t overload (controller protection)	OC6	I ² -t overload (motor protection)	OH	overtemperature heat sink	QUE	mains overvoltage	P03	following error (tolerance exceeded)	Sd1	short circuit or interruption of tacho	Sd2	open circuit of resolver	Sd3	encoder fault at X5	Sd4	encoder fault at X9	Sd5	master current $< 2\text{mA}$ with C034 = -1-	SP	wrong signal source polarity	U15	$\pm 15\text{V}$ supply voltage is missing	<p>When a warning occurs:</p> <ol style="list-style-type: none"> The display changes to C066. The warning blinks until the fault is reset. The warning is entered into the history buffer of C066. <p>The last 8 entries can be displayed by pressing \blacktriangledown and \blacktriangle. The message saved last is displayed first. The history buffer isn't cleared when the mains is switched on.</p>
Display	Meaning																																											
---	no warning																																											
ACI	armature circuit break																																											
CE0	communication error (automation interface)																																											
CE9	communication error (serial interface)																																											
dEr	motor blocked or field break																																											
EEr	external TRIP (from terminal)																																											
FCI	interruption of the excitation circuit																																											
OC5	I-t overload (controller protection)																																											
OC6	I ² -t overload (motor protection)																																											
OH	overtemperature heat sink																																											
QUE	mains overvoltage																																											
P03	following error (tolerance exceeded)																																											
Sd1	short circuit or interruption of tacho																																											
Sd2	open circuit of resolver																																											
Sd3	encoder fault at X5																																											
Sd4	encoder fault at X9																																											
Sd5	master current $< 2\text{mA}$ with C034 = -1-																																											
SP	wrong signal source polarity																																											
U15	$\pm 15\text{V}$ supply voltage is missing																																											

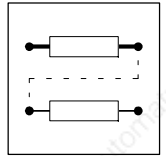

Code	Name	Possible settings		Info
		Lenze	Selection	
C067	Fault indication: TRIP	Display	Meaning	<p>When a TRIP occurs:</p> <ol style="list-style-type: none"> The display changes to C067. TRIP blinks until the fault and the memory are reset. Reset memory: with SH+ PRG or via the input TRIP-Reset, with LECOM via C043 or via the input TRIP-Reset TRIP is entered into the history buffer of C067. The last 8 entries can be displayed by pressing ▼ and ▲. The TRIP saved last is displayed first. The history buffer isn't cleared when the mains switched on. <p>After PR-TRIP, the code C180 must be reset to 2Q operation for controllers 48XX or for 2Q applications.</p>
			<p>--- no fault at present</p> <p>ACI armature circuit break</p> <p>CCr System fault</p> <p>CE0 communication error (automation interface)</p> <p>CE9 communication error (serial interface)</p> <p>dEr motor blocked or field break</p> <p>EEr external TRIP (from terminal)</p> <p>FCI break excitation circuit</p> <p>LF mains frequency fault $f_{\text{mains}} < 47\text{Hz}$</p> <p>LU Undervoltage</p> <p>LU1 faulty phase, mains break</p> <p>OC5 I-t overload (controller protection)</p> <p>OC6 I²-t overload (motor protection)</p> <p>OF mains frequency fault $f_{\text{mains}} > 63\text{Hz}$</p> <p>OH overtemperature heat sink</p> <p>OUE mains overvoltage</p> <p>P03 following error (tolerance exceeded)</p> <p>P13 angle overrun (angle difference cannot be compensated any longer)</p> <p>PER software error (please contact Lenze)</p> <p>PR all parameters reset (factory setting)</p> <p>PR1 parameter set 1 reset (factory setting)</p> <p>PR2 parameter set 2 reset (factory setting)</p> <p>PR3 parameter set 3 reset (factory setting)</p> <p>PR4 parameter set 4 reset (factory setting)</p> <p>Sd1 short circuit or interruption of tacho</p> <p>Sd2 open circuit of resolver</p> <p>Sd3 encoder fault at X5</p> <p>Sd4 encoder fault at X9</p> <p>Sd5 master current $< 2\text{ mA}$ with C034 = -1-</p> <p>SP wrong signal source polarity</p> <p>U15 $\pm 15\text{V}$ supply voltage is missing</p>	
C068	Operating state	Bit	Meaning	<p>16 bit status information</p> <p>Only readable via LECOM. The signals are described in the Lecom-A/B protocol.</p>
			<p>0-3 Operation error (bit-decoded)</p> <p>4-7 Communication error (bit-coded)</p> <p>8 Controller enable</p> <p>9 $n_{\text{act}} = 0$</p> <p>10 Setpoint inversion</p> <p>11 Pulse inhibit</p> <p>12 Quick stop</p> <p>13 I_{max} limit reached</p> <p>14 $n_{\text{act}} = n_{\text{set}}$</p> <p>15 TRIP fault message</p>	



Configuration

Code	Name	Possible settings			Info	
		Lenze	Selection	Bit		Meaning
C069	Controller state			0	Operation error	8 bit status information Only readable via LECOM. The signals are described in the LECOM-A/B protocol.
				1	Communication error	
				2	Operating mode was changed	
				3	Control via LECOM active	
				4	Control via terminals active	
				5	Controller reset (CCr fault)	
				6	not assigned	
				7	Controller enable	
C070	V_{pn} of the speed controller	8	1	{1}	1000	Gain adjustment of the speed controller: 1. With low motor speed, increase V_{pn} until the drive starts to oscillate (high frequency). 2. Reduce V_{pn} , until the drive runs smoothly.
[C071*]	T_{nn} of the speed controller	400 ms	20 ms	{10 ms}	2000 ms 9999 ms	Integral action time of the speed controller $T_{nn} = 9999$ ms: I-component switched-off (only when controller is inhibited)
C072*	K_{dn} of the speed controller	0	0· V_{pn}	{0.1}	5.0· V_{pn}	Differential component of the speed controller
C077*	V_{pl} of the field controller	1.0	0.1	{0.1}	5.0	Gain adjustment of the field controller
C078*	T_{nl} of the field controller	300 ms	70 ms	{10 ms}	2000 ms	Integral action time of the field controller
C079*	PT1 element Time constant for field controller attenuation	140 ms	30 ms	{10 ms}	9000 ms	The larger the time constant, the larger the decoupling between armature and field circuits.
C081*	Rated motor power	6.7 kW	0.0 kW 10kW	{0.1 kW}	10.0 kW 1000kW	See motor nameplate
C083.┘	Rated field current	0A	0 A	{0.01 A}	30.0 A	Rated current depends on the controller: 0A/0.1A ... 3.5A (4902, 4903) 0A/0.3A ... 10A (4904 - 4907) 0A/0.3A ... 15A (4X08) 0A/0.3A ... 30A (4X09 - 4X13) Data on the motor nameplate are setpoints for the field current. With very low field currents an auxiliary starting circuit should be provided.
C084*.┘	CW/CCW armature time constant	10 ms	0 ms	{5 ms}	30 ms	Adaption of the current controller to compensated and uncompensated motors 0 ms = adaption not active
C085*.┘	Thermal motor time constant	1.0min	1.0 min	{0.1 min}	100.0 min	Required for "I ² -t monitoring" (motor protection)
C087.┘	Rated motor speed	3000 rpm	300 rpm	{1 rpm}	5000 rpm	See motor nameplate

Configuration



Code	Name	Possible settings		Info
		Lenze	Selection	
C088	Rated motor current		0 A {0.1A} 100 A 100 A {1A} 3600 A	Rated current depends on the controller: 0..87A (4902) 0..135A (4903) 0..270A (4904) 0..450A (4905) 0..720A (4906) 0..900A (4907) 0..1200A (4X08) 0..1800A (4X09) 0..2520A (4X11) 0..3600A (4X12) 0..4050A (4X13) See motor nameplate
C090┘	Rated motor voltage	420 V	150 V {1 V} 650 V	See motor nameplate Observe max. permissible output voltage of the controller!
C093*┘	Controller identification		49XX	Display: controller type
C094*	User password	0	0 {1} 999	0 = No password protection (see also C000)
C098	Language	0	-0- German -1- English -2- French	
C099*	Software version		49 6.X	Display: Series and software version
C100*┘	Input selection: Additional acceleration and deceleration times for main setpoint		-1- Acceleration time T_{ir1} /deceleration time T_{if1} -2- Acceleration time T_{ir2} /deceleration time T_{if2} ... -15- Acceleration time T_{ir15} /deceleration time T_{if15}	Extends T_{ir} (C012) and T_{if} (C013) by max. 15 value pairs. Can be changed under C130: 1. Select additional times under C100. 2. Set under C101 (T_{ir}) or C103 (T_{if}).
C101*	Acceleration time for C100	0.00s	0 s {0.01 s} 1 s 1 s {0.1s} 10s 10 s {1 s} 100 s 100 s {10 s} 990 s	Time refers to speed change 0... n_{max}
C103*	Deceleration time for C100	0.00s	0 s {0.01 s} 1 s 1 s {0.1s} 10s 10 s {1 s} 100 s 100 s {10 s} 990 s	Time refers to speed change 0... n_{max}
C105	Deceleration time for quick stop	0.00s	0 s {0.01 s} 1 s 1 s {0.1s} 10s 10 s {1 s} 100 s 100 s {10 s} 990 s	Time refers to speed change 0... n_{max}
C108*	Gain for C110	1.00	-10.000 {0.001} +10.000	Gain for X4/62, X4/63, X8
C109*	Offset for C110	0mV	-10000mV {1mV} +10000mV	Offset for X4/62, X4/63 Loading of the factory settings does not overwrite C109. This code is only effective if the digital frequency output is selected under C110.
C110*┘	Input selection: Monitor output	1	-1- Analog output X4/62 (monitor 1) -2- Analog output X4/63 (monitor 2) -3- Digital frequency output X8	The monitor outputs are freely assignable with the signals under C111: 1. Select monitor output under C110. 2. Assign signals under C111. 3. If necessary, adjust under C108 and C109.

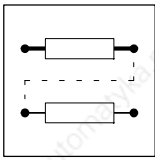

Configuration

Code	Name	Possible settings		Info																																																
		Lenze	Selection																																																	
[C111*]	Signal for C110		-0- No signal -1- Main setpoint (C046), reference: n_{max} -2- Input ramp function generator, reference: n_{max} -3- Output ramp function generator, reference: n_{max} -4- Additional setpoint (C049), reference: n_{max} -5- n_{set} at n-controller input (C050), reference: n_{max} -6- n_{act} (C051), reference: n_{max} (X4/63) -8- n_{act} (C382), reference: n_{max} (X8) -20- n-controller output, reference: M_{max} -21- M_{set} (C047), reference: M_{max} -22- I_{set} (C063), reference: I_{max} (C022, C023), (X4/62) -23- I_{act} (C054), reference: (see 'Info') -25- M_{set} (C056), reference: M_{max} -28- I-t load, reference: 100% -29- I ² -t load, reference: 100% -30- V_A (C052), reference: 1000 V -35- Mains frequency, reference: 30Hz = 0V, 70Hz = 10V -40- Fiel current setpoint, reference: max. controller field current I_{Fmax} -41- Actual field current, reference: I_{Fmax} -60- Output motor potentiometer, reference: 100% -61- Output process controller, reference: 100% -62- Output arithmetic block 2, reference: 100% -63- Digital frequency input X5, reference: 100% -64- Digital frequency input X9, reference: 100% -65- Resolver, reference: 100% -66- Digital / analog conversion 1 (C272), reference: 100% -67- Digital / analog conversion 2 (C273), reference: 100% -68- Motor power, reference: 5 V = P_{rated} -69- Motor torque, reference: 5 V = M_{rated} -70- Output dead band element, reference: 100% -71- Output DT1 element, reference: 100% -72- Output absolute value generator, reference: 100% -73- Output limiting element 1, reference: 100% -74- Output PT1 element, reference: 100% -75- Output arith.-block 3, reference: 100% -76- Output add.-block 1, reference: 100% -77- Output add.-block 2, reference: 100% -78- Output limiting element 2, reference: 100%	Armature setting range: 100 % M_{max} correspond to 100 % I_{max} (C022, C023) The actual armature current I_{act} (C054) is standardized, according to the controller: <table border="1"> <thead> <tr> <th>I_{act}</th> <th>X4/62,</th> <th>X8</th> <th>Type</th> </tr> </thead> <tbody> <tr> <td>16A</td> <td>4.4V</td> <td>110kHz</td> <td>4902</td> </tr> <tr> <td>25A</td> <td>4.7V</td> <td>118kHz</td> <td>4903</td> </tr> <tr> <td>55A</td> <td>4.8V</td> <td>120kHz</td> <td>4904</td> </tr> <tr> <td>110A</td> <td>4.9V</td> <td>122kHz</td> <td>4905</td> </tr> <tr> <td>200A</td> <td>6.4V</td> <td>159kHz</td> <td>4906</td> </tr> <tr> <td>250A</td> <td>4.4V</td> <td>110kHz</td> <td>4907</td> </tr> <tr> <td>330A</td> <td>5.2V</td> <td>129kHz</td> <td>4X08</td> </tr> <tr> <td>500A</td> <td>5.8V</td> <td>144kHz</td> <td>4X09</td> </tr> <tr> <td>700A</td> <td>5.8V</td> <td>144kHz</td> <td>4X11</td> </tr> <tr> <td>1000A</td> <td>5.8V</td> <td>146kHz</td> <td>4X12</td> </tr> <tr> <td>1200A</td> <td>7.0V</td> <td>175kHz</td> <td>4X13</td> </tr> </tbody> </table> With C111 = -5- the selection depends on the configuration set under C005. If C005 = -6X-, -72- the signal C111 = -5- outputs the corresponding input pulse current.	I_{act}	X4/62,	X8	Type	16A	4.4V	110kHz	4902	25A	4.7V	118kHz	4903	55A	4.8V	120kHz	4904	110A	4.9V	122kHz	4905	200A	6.4V	159kHz	4906	250A	4.4V	110kHz	4907	330A	5.2V	129kHz	4X08	500A	5.8V	144kHz	4X09	700A	5.8V	144kHz	4X11	1000A	5.8V	146kHz	4X12	1200A	7.0V	175kHz	4X13
I_{act}	X4/62,	X8	Type																																																	
16A	4.4V	110kHz	4902																																																	
25A	4.7V	118kHz	4903																																																	
55A	4.8V	120kHz	4904																																																	
110A	4.9V	122kHz	4905																																																	
200A	6.4V	159kHz	4906																																																	
250A	4.4V	110kHz	4907																																																	
330A	5.2V	129kHz	4X08																																																	
500A	5.8V	144kHz	4X09																																																	
700A	5.8V	144kHz	4X11																																																	
1000A	5.8V	146kHz	4X12																																																	
1200A	7.0V	175kHz	4X13																																																	

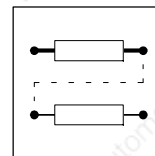

Code	Name	Possible settings		Info
		Lenze	Selection	
C112* ₁	Input selection: Freely assignable digital input	1	-1- digital input X2/E1 -2- digital input X2/E2 ... -5- digital input X2/E5	The digital inputs E1..E5 are freely assignable with the functions under C113. Each function can only be assigned to one input. Exceptions: <ul style="list-style-type: none"> • C113 = -20- : max. 2 dig. inputs • C113 = -1-, -2-, -40-: max. 4 dig. inputs (binary coded selection of max. 1, 3, 7 or 15 additional T_i times or setpoints). Assignment of functions: 1. Select input under C112. 2. Assign function under C113. 3. Determine polarity under C114. 4. Determine priority under C115.
[C113*]	Function for C112		-0- No function -1- Enable additional T _i times -2- Enable JOG setpoint (X4/E4, E5) -3- TRIP reset (X2/E2) -4- TRIP set (X2/E1) -6- Switch-off additional setpoint (X4/E3) -7- Switch-off I-component of the n-controller -9- Ramp function generator stop -10- Ramp function generator zero -16- Motor potentiometer deactivated -17- Motor potentiometer down -18- Motor potentiometer up -20- Select parameter set -21- Load parameter set -30- Deactivate process controller -31- Switch-off I-component of the process controller -32- Set the process controller to 0 -40- Enable fixed setpoint	
[C114*]	Polarity for C112	0	-0- Input HIGH active -1- Input LOW active	
[C115*]	Priority for C112		-0- Terminal function not active, if terminal control is switched-off under C001. (X2/E4, E5) -1- Terminal function remains active, if terminal control is switched-off under C001. (X2/E1, E2, E3)	
C116* ₁	Input selection: Freely assignable digital output	1	-1- FDO 1 -2- FDO 2 ... -12- FDO 12 -13- Relay output X3/K11, X3/K14	The digital outputs FDO1..FDO12 and the relay output X3/K11, X3/K14 are freely assignable with the functions under C117. Multiple assignment is possible. The outputs FDO1...FDO5 are assigned to the terminals X3/A1...X3/A5. FDO6...FDO12 can only be accessed via LECOM. Assignment of functions: 1. Select output under C116. 2. Assign function under C117. Only for FDO1...FDO5, relay output: 3. Determine polarity under C118. 4. Determine signal delay under C128.



Configuration

Code	Name	Possible settings		Info
		Lenze	Selection	
[C117*]	Function for C116		-0- No function -1- $n_{act} \leq n_x$ C017 (FDO1) -2- Controller enabled (FDO10) -3- n-controller output = M_{max} (FDO2) -4- Ready for operation (RDY) (FDO11) -5- Pulse inhibit (IMP) (FDO12) -6- TRIP (relay) -7- Warning (FDO6) -8- Message (FDO7) -9- Ramp function generator on = off (FDO3) -10- $n_{act} = n_{set}$ (FDO5) -11- $n_{act} = 0$ (FDO4) -12- $I_A = 0$ (FDO8) -13- I_A & $n_{act} = 0$ (FDO9) -14- $\leq C046$ or $\leq C049$ $> n_x$ (threshold C243) -15- $ I_A > I_x$ (threshold C244) -16- $I_F > I_x$ (threshold C245) -17- $ n_{act} > n_x$ (threshold C242) -18- Brake control -19- Comparator 1 -20- Comparator 2	
[C118]	Polarity for C116		-0- Output is HIGH active (FDO2, 3, 5) -1- Output is LOW active (FDO1, 4, relay)	
C119* _L	Selection of monitoring function		-15- OC5 -16- OC6 -22- OUE -31- LU1 -32- LU -41- LF -42- OF -50- OH -61- CE0 -70- U15 -80- SP -81- Sd1 -82- Sd2 -83- Sd3 -84- Sd4 -85- Sd5 -91- EEr -93- dEr -94- AC1 -96- FC1 -153- P03 -163- P13 -69- CE9	I - t overload (controller protection) I ² - t overload (motor protection) Mains overvoltage Phase fault Mains undervoltage Mains underfrequency $f_{mains} < 47Hz$ Mains overfrequency $f_{mains} > 63Hz$ Overtemperature heat sink Communication error (automation interface) ± 15V failure Wrong signal source polarity Tacho short-circuit/interruption Open circuit of resolver Encoder fault at X5 Encoder fault at X9 Defective setpoint encoder Ext. TRIP terminal Motor blocked Interruption of armature circuit Interruption of field circuit Following error Phase overflow Communication error (serial interface)
[C120*]	Change of monitoring function		-0- TRIP -1- Warning -2- Message with pulse inhibit -3- Message without pulse inhibit -4- Switched-off	The important monitoring functions are set according to the change of configuration under C005.

Configuration

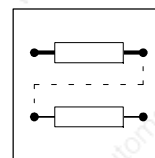

Code	Name	Possible settings			Info
		Lenze	Selection		
C123	Current threshold for blocking protection for C124	0.95 I_{rated}	0 A 100 A	{0.1A} 100 A {1 A} 3600 A	Rated current depends on the controller: 0 ... 87A (4902) 0 ... 135A (4903) 0 ... 270A (4904) 0 ... 450A (4905) 0 ... 720A (4906) 0 ... 900A (4907) 0 ... 1200A (4X08) 0 ... 1800A (4X09) 0 ... 2520A (4X11) 0 ... 3600A (4X12) 0 ... 4050A (4X13) See motor nameplate
C124*	Blocking time	60 s	1 s	{1 s} 100 s	Motor standstill time until TRIP is set
C125*↕	Change of baud rate for interface	0	-0- -1- -2- -3-	9600 baud 4800 baud 2400 baud 1200 baud	
C126*	Delay (Monitoring ser. interface)	3000 s	0.2 s 10 s 100 s	{0.1 s} 10 s {1 s} 100 s {10 s} 3600 s	
C128*	Delay for C116	0.000 s	0.000 s	{0.001 s} 240.000 s	Signal delay times for FDO 1...5 and relay output.
C130*	Enable additional T_i times	0	-0- -1- ... -15-	T_{ir} (C012) / T_{if} (C013) active T_{ir1} / T_{if1} active T_{ir15} / T_{if15} active	If the T_i times are enabled via terminal, C130 is for display only.
C131*↕	Ramp function generator STOP	0	-0- -1-	Enable ramp function generator Stop ramp function generator	If ramp function generator STOP (main setpoint) is enabled via terminal, C131 is for display only.
C132*↕	Ramp function generator input = 0	0	-0- -1-	Enable mains setpoint at RFG input Ramp function generator input = 0	
[C134*]	Ramp function generator characteristic	0	-0- -1-	linear characteristic S-shaped characteristic	
C136*	FDI state		Bit 0 ... 3 4	Free digital input FDI 1 FDI 4 FDI 5	Only readable via LECOM. C136 indicates the states of the digital inputs as a decimal or binary value. The change of polarity under C114 is considered in C136.



Configuration

Code	Name	Possible settings		Info
		Lenze	Selection	
C145* ₁	Input selection: Analog signal	1	-1- Input terminals X1/1, X1/2 -2- Input terminals X1/3, X1/4 -3- Input terminal X1/6 -4- Input terminal X1/8 -5- Digital frequency input X5 -6- Digital frequency input X9 -7- Resolver -8- Motor potentiometer output -9- Output process controller -10- Output arithmetic block 2 output 1 -11- Fixed setpoint output -12- Output arithmetic block 2 output 2 -13- Output dead band element output 1 -14- Output dead band element output 2 -15- Output DT1 element output 1 -16- Output DT1 element output 2 -17- Output absolute value generator output 1 -18- Output absolute value generator output 2 -19- Output limiting element 1 output 1 -20- Output limiting element 1 output 2 -21- Output PT1 element output 1 -22- Output PT1 element output 2 -23- Output arithmetic block 3 output 1 -24- Output arithmetic block 3 output 2 -25- Output addition block 1 output 1 -26- Output addition block 1 output 2 -27- Output addition block 2 output 1 -28- Output addition block 2 output 2 -29- n_{act} from C382 -30- n_{set} from C050 -31- Deviation at n-controller (xw) -32- Deviation at process controller (xw) -33- Ramp function generator output -34- n-controller output -35- Square-wave generator -36- Deviation at angle controller -37- RFG output of process controller setpoint conditioning -38- RFG output of process controller evaluation -39- AIF process controller setpoint -40- Output limiting element 2 output 1 -41- Output limiting element 2 output 2 -42- Output comparator 1 -43- Output comparator 2	<p>The functions set under C146 can be assigned to the input sources under C145. Double assignment is not possible. The function selected last is always assigned to the input.</p> <p>C145 = -1-, -2-, -3-, -4-, -5-, -6-: Determine the priority for these inputs under C147.</p> <p>If C005 (configuration) is changed: The freely selected assignments are overwritten with a configuration-dependent basic assignment. If necessary, reassign functions.</p>

Configuration

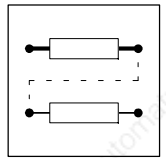

Code	Name	Possible settings		Info
		Lenze	Selection	
[C146*]	Function for C145		-0- No function -1- Main setpoint of C046 -2- Input for torque selection -3- Additional setpoint of C049 -4- V_{pn} of the speed controller -5- Field current setpoint -6- Process controller: setpoint (C330) -7- Process controller: actual value -8- Process controller: evaluation (C331) -9- Process controller: ext. V_p setting -10- C027 of X5 -11- C027 of X9 -12- Gearbox factor (C032) -13- Angle trimming of C256 -14- Speed trimming of C257 -15- Arithmetic block 2 - input 1 (C338) -16- Arithmetic block 2 - input 2 (C339) -17- Fixed setpoint block input -18- Analog / digital conversion 1 (C270) -19- Analog / digital conversion 2 (C271) -20- Dead band element input (C622) -21- DT1 element input (C652) -22- Absolute value generator input (C660) -23- Limiting element input (C632) -24- PT1 element input (C641) -25- Arithmetic block 3 - input 1 (C601) -26- Arithmetic block 3 - input 2 (C602) -27- Addition block 1 - input 1 (C610) -28- Addition block 1 - input 2 (C611) -29- Addition block 1 - input 3 (C612) -30- Addition block 2 - input 1 (C614) -31- Addition block 2 - input 2 (C615) -32- Addition block 2 - input 3 (C616) -33- Additional torque setpoint 1 (C148) -34- Additional torque setpoint 2 (C149) -35- FAI input of the S&H module -36- AIF process controller: act. value -37- Limiting element 2 input (C637) -38- Comparator 1 input 1 (C580) -39- Comparator 1 input 2 (C581) -40- Comparator 2 input 1 (C590) -41- Comparator 2 input 2 (C591) -42- Input for ext. excitation characteristic -43- n_{act} of C051 (for tacho feedback) -44- n_{act} of C051 (for resolver or incremental encoder feedback) -46- Digital frequency setpoint	<p>C146 = -4- V_{pn} of the n-controller corresponds to 0% at the input V_{p2} under C320 and $\pm 100\%$ at the input V_{pn} under C070.</p> <p>C146 = -5- field current setpoint correspond to $\pm 100\%$ at the input of the rated current under C083. The minimum adjustable value is determined under C231.</p> <p>C146 = -43-, -44-, -46- are for display only (according to the configuration). They cannot be assigned.</p>
[C147*]	Priority for C145		-0- Terminal function not active, if terminal control is switched-off under C001. -1- Terminal function remains active, if terminal control is switched-off under C001.	



Configuration

Code	Name	Possible settings			Info
		Lenze	Selection		
C148	Additional torque value 1	0	-100.0 % M_{max} {0.1%} -200 % M_{max} {1%}	+ 100.0 % M_{max} + 200 % M_{max}	Display only possible with analog signal source assignment (C001; C145/C146/C147). If the analog signal source is not assigned, different values can be saved in the parameter sets. If the signal source assignment is deactivated via C145/C146, the display value valid a that time will be kept. Armature range: 100% M_{max} correspond to 100% I_{max} (C022, C023).
C149	Additional torque value 2	0	-100.0 % M_{max} {0.1%} -200 % M_{max} {1%}	+ 100.0 % M_{max} + 200 % M_{max}	Display only possible with analog signal source assignment (C001; C145/C146/C147). If the analog signal source is not assigned, different values can be saved in the parameter sets. If the signal source assignment is deactivated via C145/C146, the display value valid a that time will be kept. Armature range: 100% M_{max} correspond to 100% I_{max} (C022, C023).
C151*	FDO Status		Bit 0 ... 11 12	Free digital output FDO 1 FDO 12 Relay output	C151 indicates the states of the digital outputs as decimal or binary values. The polarity reversal under C118 is not considered.
[C180*]	4Q/2Q operation		-0- -1-	4Q operation (49XX) 2Q operation (48XX)	Important for controller type 48XX: Controllers must only be operated with C180 = -1-! Fault PR sets C180 = -0-. It is absolutely necessary to set C180 = -1- before commissioning.
C182*	T_r time of the S-shape ramp function generators	20.0 s	0.01 s 1s 10s	{0.01s} 1 s {0.1s} 10s {1s} 50s	T_r time for the S-shape ramp function generator of the main setpoint
C183	Origin of controller inhibit		Display Terminal or term. Keypad or kp LECOM1 or L1 Aut.int. (AIF) oth. src. or o.s.	Origin of ctrl inhibit Terminal Keypad (STP key) LECOM1 interface Automation / fieldbus interface (module, InterBus, PROFIBUS, ...) Other source Release: TRIP or message Information: C065, C067	Display: Source which has inhibited the controller
C185	Motor power		-500.0 kW -999 Nm	{0.1 kW} 500.0 kW {1 Nm} 999 Nm	Display: actual motor power
C186	Motor torque		-500.0 kW -999 Nm	{0.1 kW} 500.0 kW {1 Nm} 999 Nm	Display: actual motor torque
C187	Field current setpoint		0.00 A	{0.01 A} 50.0 A	Display: actual field current setpoint
C188	Actual field current		0.00 A	{0.01 A} 50.0 A	Display: actual field current value
C189	Mains frequency		0.0 Hz	{0.1 Hz} 100.0 Hz	Display: actual mains frequency

Configuration



Code	Name	Possible settings		Info
		Lenze	Selection	
C190* _↓	Arithmetic block 1	1	-0- Output = C046 -1- Output = C046 + C049 -2- Output = C046 - C049 -3- Output = C046 · C049 -4- Output = C046 / C049 -5- Output = C046 / (100% - C049)	
C191* _↓	Arithmetic block 2	1	-0- Output = C338 -1- Output = C338 + C339 -2- Output = C338 - C339 -3- Output = C338 · C339 -4- Output = C338 / C339 -5- Output = C338 / (100% - C339)	
C192* _↓	Input selection: Fixed setpoint	1	-1- Selection fixed setpoint 1 -2- Selection fixed setpoint 2 ... -15- Selection fixed setpoint 15	It is possible to set up to 15 setpoints with freely selectable references: 1. Select fixed setpoint under C192. 2. Assign value under C193. 3. Enable via the digital inputs or C194.
C193*	Setpoint for C192		-100.0 % {0.1 %} +100.0 % 100.0% Fixed setpoint 1 75.0% Fixed setpoint 2 50.0% Fixed setpoint 3 25.0% Fixed setpoint 4 0.0% Fixed setpoint 5 ... 0.0% Fixed setpoint 15	
C194* _↓	Enable fixed setpoint	0	-0- Free input is active -1- Fixed setpoint 1 is active ... -15- Fixed setpoint 15 is active	
C195*	Delay between 'engage brake' and controller inhibit	9999 s	0.00s {0.01 s} 1s 1s {0.1s} 10s 10s {1s} 250s 9999 s	Delay between signal 'engage brake' and automatic controller inhibit 9999 s: Unlimited delay, controller will not be inhibited.
C196*	Delay between 'setpoint integrator free' and quick stop	0.00s	0.00 s {0.01 s} 1 s 1s {0.1s} 10s 10s {1s} 100s 100s {10s} 250s	Delay between reset of the quick stop function and enable of the main setpoint integrator
[C197*]	Sign of the torque selection	0	-0- Sign is determined by the torque setpoint -1- positive sign -2- negative sign	Sign of the torque selection between reset of QSP and enable of the setpoint integrators
[C198*]	Enable actual speed filter	0	-0- Filter not active -1- Filter active	
C199*	Time constant act. speed filter	10ms	8ms {1ms} 100ms	
C200*	Software identification		String format: "33S4902M_61000"	Display of the software version only via interface.
C220*	Acceleration time T _{ir} of the additional setpoint	0.00 s	0.00 s {0.01 s} 1 s 1 s {0.1 s} 10 s 10 s {1 s} 100 s 100 s {10 s} 990 s	

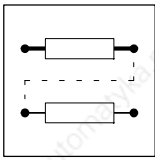

Configuration

Code	Name	Possible settings				Info
		Lenze	Selection			
C221*	Deceleration time T_{ff} of the additional setpoint	0.00 s	0.00 s	{0.01 s} 1 s		
			1 s	{0.1 s} 10 s		
			10 s	{1 s} 100 s		
			100 s	{10 s} 990 s		
C222*	V_p process controller	1	0.1	{0.1} 10		Gain of the process controller
			10	{1.0} 500		
[C223*]	T_n process controller	400 ms	20 ms	{1 ms} 20000 ms		$T_n = 9999$ ms: I-component switched-off (only when controller is inhibited)
				9999 ms		
C224*	K_d process controller	0.0	$0.0 \cdot V_{pn}$	{ $0.1 \cdot V_{pn}$ } $5.0 \cdot V_{pn}$		Differential component of the process controller
[C230*]	Control mode for the override field control	0	-0-	Limitation of the armature voltage		Field weakening must be permitted under C231.
			-1-	Control of the armature voltage		
C231*	Min. field current	100%	10 % I_{Frated}	{1% I_{Frated} } 100% I_{Frated}		Reference: I_{Frated} (C083), observe min. value under C083!
C232*	I-R compensation	0.0%	0.0 % V_{rated}	{0.1% V_{rated} } + 30 % V_{rated}		Reference: V_{rated} (C090)
C233*	V_p - V_{ab} controller	1.0	0.1	{0.1} 10		Gain of the V_{ab} controller
			10	{1.0} 50		
[C234*]	T_n - V_{ab} controller	400 ms	20 ms	{10 ms} 2000 ms		$T_n = 9999$ ms: I-component switched-off (only when controller is inhibited)
				9999 ms		
[C235*]	Excitation characteristic	0	-0-	internal excitation characteristic active		With C253= -1-, the control process is based on operation with rated excitation
			-1-	internal excitation characteristic not active		
[C237*]	Synchronisation mode	0	-0-	dyn. IMP, 20 ms correction		
			-1-	no dyn. IMP, 20 ms correction		
			-2-	dyn. IMP, 400 ms correction		
			-3-	no dyn. IMP, 400 ms correction		
C240*	Window $n_{act} = n_{set}$	1%	0 % n_{max}	{0.1% n_{max} } + 100% n_{max}		Threshold for $n_{act} = n_{set}$, reference: n_{max}
C241	Window RFG on = RFG off	1%	0 % n_{max}	{0.1% n_{max} } + 100% n_{max}		Threshold ramp function generator input = ramp function generator output, reference: n_{max}
C242*	Threshold $ n_{act} \geq n_x$	1000 rpm	100 rpm	{1 rpm} 5000rpm		
C243*	Threshold $n_{set} > n_x$	1%	0 % n_{max}	{0.1 % n_{max} } + 100 % n_{max}		Threshold for $\leq C046$ or $\leq C049$ > n_x , reference: n_{max}
C244*	Threshold $\leq I > I_x$	10%	0 % I_{Amax}	{0.1% I_{Amax} } + 100 % I_{Amax}		$\leq I > I_x$ Reference, rated controller current (armature)
C245*	Threshold $I_f > I_x$	10%	0 % I_{Fmax}	{0.1% I_{Fmax} } + 100% I_{Fmax}		$I_f > I_x$, Reference, rated controller current (field)
C249* \perp	LECOM1 code bank	1	0	{1} 7		Fixed address offset: LECOM1 interface (protocol LECOM A/B) can address codes > 255.
C252*	Angle offset	0 inc	-245760000 inc	{1 inc} 245760000 inc		Fixed angle offset with digital frequency configurations (C005 = -5X-, -6X-, -72-) Format for LECOM: 0.022 (LECOM) correspond to 220 incr.
C253*	Angle offset	0 inc	-8190 inc	{1} 8190 inc		Speed-dependent angle offset Format for LECOM: 0.022 (LECOM) correspond to 220 incr.
C254*	V_p angle controller	0.33	0.00	{0.01} 1.00		Gain of the angle controller

Configuration

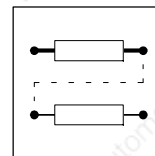

Code	Name	Possible settings			Info
		Lenze	Selection		
C255*	Following error limit	220 inc	10 inc	{1 inc} 536750000 inc	Only active if C254 > 0! Format for LECOM: 0.022 (LECOM) correspond to 220 incr.
C256*	Angle trimming	0 inc	-32768 inc	{1 inc} 32767 inc	Angle offset with digital frequency configurations (C005 = -5X-, -6X- and -72-) Format for LECOM: 0.022 (LECOM) correspond to 220 incr. If an analog signal source (C145/C146) is assigned, the parameter will be displayed only.
C257*	Speed trimming	0 rpm	-5000 rpm	{1} +5000 rpm	Fixed speed offset with digital frequency configurations (C005 = -5X-, -6X- and -72-). If an analog signal source (C145/C146) is assigned, the parameter will be displayed only.
C260*	Upper motor potentiometer limit	100%	-100.0 %	{0.1 %} +100.0 %	C260 must be higher than C261!
C261*	Lower motor potentiometer limit	0 %	-100.0 %	{0.1%} +100.0 %	C261 must be smaller than C260!
C262*	Motor pot. acceleration time	10 s	1 s	{1 s} 5000 s	C262 is activated if the motor potentiometer terminal is set to "UP" Reference: Change of 0...±100%
C263*	Motor pot. deceleration time	10 s	1 s	{1 s} 5000 s	C263 is activated if the motor potentiometer terminal is set to "DOWN" Reference: Change of 0...±100%
C264*↵	Motor potentiometer deactivation function	0	-0-	No function, motor potentiometer is not changed. -1- Down to 0%, motor potentiometer output runs with the corresponding acceleration or deceleration time to 0%. -2- Down to lowest limit, motor potentiometer output runs with the corresponding acceleration or deceleration time to the value under C261. -3- Jump to 0%, motor potentiometer output immediately changes to 0%. -4- Jump to the lowest level, motor potentiometer immediately changes to the value indicated under C261. -5- Up to the highest level, motor potentiometer output runs with the corresponding acceleration or deceleration to the value indicated under C260.	Function which is executed when deactivating the motor potentiometer (terminal DEACTIVE is set).
C265*↵	Initialisation function Sample & Hold	0	-0-	Acceptance of the saved value S&H output accepts the value which was set before switching the mains. -1- Lower limit, S&H output accepts the value of C261.	Function which is executed when switching on the mains.
C266*	Motor pot.: Operation via keypad		100.0 %	{0.1 %} +100.0 %	Under C266, the motor potentiometer can also be operated with ▲ and ▼. Display: Output value of the motor potentiometer in % and exact value of control program.
C267*↵	Sample and Hold function	0	-0-	S&H for motor potentiometer output -1- S&H for FAI signal	
C270*	Analog/digital conversion 1		-16384	{1} 16384	Display: Value assigned and digitized via C145 / C146 Output only via interfaces



Configuration

Code	Name	Possible settings			Info
		Lenze	Selection		
C271*	Analog/ digital conversion 2		-16384 {1} 16384		Display: Value assigned and digitized via C145 / C146 Output only via interfaces
C272*	Digital/ analog conversion 1		-16384 {1} 16384		Input: Value for the conversion into an analog signal is to be entered via the monitor outputs X4/62, X4/63 or digital frequency output X8. Input only via interfaces.
C273*	Digital/ analog conversion 2		-16384 {1} 16384		Input: Value for the conversion into an analog signal is to be entered via the monitor outputs X4/62, X4/63 or digital frequency output X8. Input only via interfaces.
C280* <input type="checkbox"/>	Additional setpoint on/off	0	-0- Additional setpoint is on -1- Additional setpoint is off		
C282* <input type="checkbox"/>	Function for C047	0	-0- Function C047 = 100% - [input source] -1- Function C047 = [input source]		
C285*	Limitation of rate of rise	40	1 {1} 1000		Limitation of rate of rise at the armature current controller input. Time: $-I_{Amax} t_0 + I_{Amax} = C285 \cdot t_{15}^{electr.}$
C286*	Upper limit of the speed setpoint	180%	-100.0 % {0.1 %} +100.0 % -180 % {1 %} +180 %		Upper limit of the speed setpoint for C050 C286 must be higher than C287!
C287*	Lower limit of the speed setpoint	-180%	-100.0 % {0.1 %} +100.0 % -180 % {1 %} +180 %		Upper limit of the speed setpoint for C050 C287 must be smaller than C286!
C310*	Speed dependent current limitation Limit value 1	100%	0.0 % {0.1 %} +100.0 %		Valid for speed under C313 C310 must be higher than C311!
C311*	Speed dependent current limitation Limit value 2	100%	0.0 % {0.1 %} +100.0 %		Valid for speed under C314 C311 must be smaller than C310!
C312*	n_0 Speed dependent current limitation	3000 rpm	0 rpm {1 rpm} 5000 rpm		Act. speed threshold (current limitation), condition: $n_1 > n_0$
C313*	n_1 Speed dependent current limitation	4000 rpm	0 rpm {1 rpm} 5000 rpm		Act. speed threshold for limit value 1 condition: $n_2 > n_1 > n_0$
C314*	n_2 Speed dependent current limitation	5000 rpm	0 rpm {1 rpm} 5000 rpm		Act. speed threshold for limit value 2 condition: $n_2 > n_1 > n_0$
C316*	Reduced field current	20 %	0 % I_{Frated} {1 % I_{Frated} } 100 % I_{Frated}		Reference: I_{Frated} (C083) With 0%, the pulses of the field controller are inhibited.
C317*	Time delay for the reduced field current	60 s	0.0 s {0.1 s} 10 s 10 s {1 s} 100 s 100 s {10 s} 3600 s		Time which is required to activate the reduced field current after inhibiting the controller.

Configuration



Code	Name	Possible settings			Info
		Lenze	Selection		
C318* _↓	Activate field current reduction	0	-0- -1-	Field current reduction function is off Field current reduction function is on	
C319*	Actual V_p of the n- controller		1	{1} 1000	Display: Actual gain factor of the n-controller (important for n-controller adaption)
C320*	V_{p2} of the n-controller adaption	8	1	{1} 1000	Second gain factor for speed controller adaption
C321*	V_{p3} of the n-controller adaption	8	1	{1} 1000	Third gain factor for speed controller adaption
C322*	n_1 of the n-controller adaption	3000 rpm	0 rpm	{1 rpm} 5000 rpm	Speed setpoint threshold of speed controller adaption, condition: $n_1 > n_0$
C323*	n_0 of the n-controller adaption	50 rpm	0 rpm	{1 rpm} 5000 rpm	Speed setpoint threshold of speed controller adaption, condition: $n_1 > n_0$
C324* _↓	n-controller adaption on/off	0	-0- -1-	n-controller adaption is off n-controller adaption is on	
C325*	V_{p2} of the process controller adaption	1	0.1 10	{0.1} 10 {1} 500	Second gain factor for process controller adaption
C326*	V_{p3} of the process controller adaption	1	0.1 10	{0.1} 10 {1} 500	Third gain factor for process controller adaption
C327*	set2 of the process controller adaption	100 %	0.0 %	{0.1 %} 100.0 %	Setpoint speed threshold of the process controller adaption, condition: set2 > set1
C328*	set1 of the process controller adaption	0%	0.0 %	{0.1 %} 100.0 %	Setpoint speed threshold of the process controller adaption, condition: set2 > set1
C329* _↓	Process controller adaption on/off	0	-0- -1-	Process controller adaption is off Process controller adaption is on	
C330*	Setpoint of the process controller	0%	-100.0 %	{0.1 %} 100.0 %	Display only possible with analog signal source assignment (C001; C145/C146/C147). If the analog signal source is not assigned, different values can be saved in the parameter sets. If the signal source assignment is deactivated via C145/C146, the display value valid a that time will be kept.
C331*	Evaluation of the process ctrl. output	100 %	-100.0 %	{0.1%} 100.0 %	Display only possible with analog signal source assignment (C001; C145/C146/C147). If the analog signal source is not assigned, different values can be saved in the parameter sets. If the signal source assignment is deactivated via C145/C146, the display value valid a that time will be kept.



Configuration

Code	Name	Possible settings		Info
		Lenze	Selection	
C332*	Acceleration time T_{ir} of the process controller setpoint	0.00 s	0.00 s {0.01 s} 1.00 s 1.0 s {0.1 s} 10.0 s 10 s {1 s} 100 s 100 s {10 s} 990 s	
C333*	Deceleration time T_{if} of the process ctrl. setpoint	0.00 s	0.00 s {0.01 s} 1.00 s 1.0 s {0.1 s} 10.0 s 10 s {1 s} 100 s 100 s {10 s} 990 s	
C334*	Acceleration time T_{ir} of the process ctrl. evaluation	0.00 s	0.00 s {0.01 s} 1.00 s 1.0 s {0.1 s} 10.0 s 10 s {1 s} 100 s 100 s {10 s} 990 s	
C335*	Deceleration time T_{if} of the process ctrl. evaluation	0.00 s	0.00 s {0.01 s} 1.00 s 1.0 s {0.1 s} 10.0 s 10 s {1 s} 100 s 100 s {10 s} 990 s	
C336*	Actual V_p of the process controller		0.1 {0.1} 500.0	Display: Actual gain factor of the process controller (important for process controller adaption)
C338*	Input 1, arithmetic block 2	0%	-100.0 % {0.1 %} 100.0 % -200 % {1 %} +200 %	Display only possible with analog signal source assignment (C001; C145/C146/C147). If the analog signal source is not assigned, different values can be saved in the parameter sets. If the signal source assignment is deactivated via C145/C146, the display value valid a that time will be kept.
C339*	Input 2, arithmetic block 2	0%	-100.0 % {0.1 %} 100.0 % -200 % {1 %} +200 %	Display only possible with analog signal source assignment (C001; C145/C146/C147). If the analog signal source is not assigned, different values can be saved in the parameter sets. If the signal source assignment is deactivated via C145/C146, the display value valid a that time will be kept.
C370* <input type="checkbox"/>	Enable automation interface		-0- No communication via automation interface -1- Communication via automation interface enabled	
C380*	n_{set} speed		-16384 {1} 16384	High precision main setpoint selection: 16384 \equiv 100% under C046 Input only via interface.
C381*	n_{set} at n-controller		-32767 {1} 32767	High precision setpoint display: Input of the speed controller, 16384 \equiv 100% under C050. Input only via interface.
C382*	Actual speed		-32767 {1} 32767	High precision display: Act. speed value 16384 \equiv n_{max} under C011. Input only via interface.
C387*	Torque limit		-16384 {1} 16384	High precision torque setpoint selection: 16384 \equiv 100% under C047. Input only via interface.
C388*	Torque setpoint		-16384 {1} 16384	High precision torque setpoint display: 16384 \equiv 100% under C056. Input only via interface.



Code	Name	Possible settings		Info
		Lenze	Selection	
C391*	Actual angle		0 {1} 65535	High precision display of the actual angle if resolver or incremental encoder operate as feedback system: 16384 = 360° = 1 revolution. Input only via interface.
C392*	Field current setpoint		0 {1} 16384	High precision display of the field current setpoint: 16384 = I _{FN} under C083. Input only via interface.
C393*	Additional setpoint		-16384 {1} 16384	High precision additional setpoint display: 16384 = 100% under C049. Input only via interface.
C580*	Input 1, comparator 1	0 %	-100.0 % {0.1 %} +100.0 % -200 % {1 %} +200 %	Display only possible with analog signal source assignment (C001; C145/C146/C147). If the analog signal source is not assigned, different values can be saved in the parameter sets. If the signal source assignment is deactivated via C145/C146, the display value valid a that time will be kept.
C581*	Input 2, limit value for comparator 1	0 %	-100.0 % {0.1 %} +100.0 % -200 % {1 %} +200 %	Display only possible with analog signal source assignment (C001; C145/C146/C147). If the analog signal source is not assigned, different values can be saved in the parameter sets. If the signal source assignment is deactivated via C145/C146, the display value valid a that time will be kept.
C582*	Hysteresis for lower threshold comparator 1	0 %	0.0 % {0.1 %} +100.0 %	Lower threshold = C581 - C582, reference: C581
C583*	Memory function comparator 1		-0- Memory function not active when resetting the output, the value falls below the lower threshold (C581 - C582) -1- Memory function active The output remains set after initial switching on.	
C584* ↙	Reset function comparator 1		-0- Reset function not active -1- Reset function active	The activation resets the output.
C590*	Input 1, comparator 2	0 %	-100.0 % {0.1 %} +100.0 % -200 % {1 %} +200 %	Display only possible with analog signal source assignment (C001; C145/C146/C147). If the analog signal source is not assigned, different values can be saved in the parameter sets. If the signal source assignment is deactivated via C145/C146, the display value valid a that time will be kept.

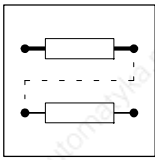

Configuration

Code	Name	Possible settings		Info
		Lenze	Selection	
C591*	Input 2, limit value for comparator 2	0 %	-100.0 % {0.1 %} +100.0 % -200 % {1 %} +200 %	Display only possible with analog signal source assignment (C001; C145/C146/C147). If the analog signal source is not assigned, different values can be saved in the parameter sets. If the signal source assignment is deactivated via C145/C146, the display value valid a that time will be kept.
C592*	Hysteresis for lower threshold comparator 2	0 %	0.0 % {0.1 %} +100.0 %	Lower threshold = C591 - C592, reference: C591
C593*┘	Memory function comparator 2		-0- Memory function not active when resetting the output, the value falls below the lower threshold (C591 - C592) -1- Memory function active The output remains set after initial switching on.	
C594*┘	Reset function comparator 2		-0- Reset function not active -1- Reset function active	The activation resets the output.
C600*┘	Arithmetic block 3	1	-0- Output = C601 -1- Output = C601 + C602 -2- Output = C601 - C602 -3- Output = C601 · C602 -4- Output = C601 / C602 -5- Output = C601 / (100% - C602)	
C601*	Input 1, arithmetic block 3	0%	-100.0 % {0.1 %} 100.0 % -200 % {1 %} +200 %	Display only possible with analog signal source assignment (C001; C145/C146/C147). If the analog signal source is not assigned, different values can be saved in the parameter sets. If the signal source assignment is deactivated via C145/C146, the display value valid a that time will be kept.
C602*	Input 2, arithmetic block 3	0%	-100.0 % {0.1 %} 100.0 % -200 % {1%} +200 %	Display only possible with analog signal source assignment (C001; C145/C146/C147). If the analog signal source is not assigned, different values can be saved in the parameter sets. If the signal source assignment is deactivated via C145/C146, the display value valid a that time will be kept.
C610*	Input 1, addition block 1	0%	-100.0 % {0.1 %} 100.0 % -200 % {1 %} +200 %	Display only possible with analog signal source assignment (C001; C145/C146/C147). If the analog signal source is not assigned, different values can be saved in the parameter sets. If the signal source assignment is deactivated via C145/C146, the display value valid a that time will be kept.

Configuration



Code	Name	Possible settings				Info
		Lenze	Selection			
C611*	Input 2, addition block 1	0%	-100.0 % -200 %	{0.1 %} {1 %}	100.0 % +200 %	Display only possible with analog signal source assignment (C001; C145/C146/C147). If the analog signal source is not assigned, different values can be saved in the parameter sets. If the signal source assignment is deactivated via C145/C146, the display value valid a that time will be kept.
C612*	Input 3, addition block 1	0%	-100.0 % -200 %	{0.1 %} {1 %}	100.0 % +200 %	Display only possible with analog signal source assignment (C001; C145/C146/C147). If the analog signal source is not assigned, different values can be saved in the parameter sets. If the signal source assignment is deactivated via C145/C146, the display value valid a that time will be kept.
C614*	Input 1, addition block 2	0%	-100.0 % -200 %	{0.1 %} {1 %}	100.0 % +200 %	Display only possible with analog signal source assignment (C001; C145/C146/C147). If the analog signal source is not assigned, different values can be saved in the parameter sets. If the signal source assignment is deactivated via C145/C146, the display value valid a that time will be kept.
C615*	Input 2, addition block 2	0%	-100.0 % -200 %	{0.1 %} {1 %}	100.0 % +200 %	Display only possible with analog signal source assignment (C001; C145/C146/C147). If the analog signal source is not assigned, different values can be saved in the parameter sets. If the signal source assignment is deactivated via C145/C146, the display value valid a that time will be kept.
C616*	Input 3, addition block 2	0%	-100.0 % -200 %	{0.1 %} {1 %}	100.0 % +200 %	Display only possible with analog signal source assignment (C001; C145/C146/C147). If the analog signal source is not assigned, different values can be saved in the parameter sets. If the signal source assignment is deactivated via C145/C146, the display value valid a that time will be kept.
C620*	Gain dead band element	1.00	-10.00	{0.01}	+10.00	
C621*	Dead band, dead band element	1.0 %	0.0 %	{0.1 %}	100.0 %	
C622*	Input, dead band element	0%	-100.0 % -200 %	{0.1 %} {1 %}	100.0 % +200 %	Display parameter only
C630*	Limiting element 1 upper limit	100 %	-100.0 % -200 %	{0.1 %} {1 %}	100.0 % +200 %	C630 must be higher than C631!
C631*	Limiting element 1 lower limit	-100 %	-100.0 % -200 %	{0.1 %} {1 %}	100.0 % +200 %	C631 must be lower than C630!



Configuration

Code	Name	Possible settings			Info	
		Lenze	Selection			
C632*	Input, limiting element 1	0 %	-100.0 % -200 %	{0.1 %} {1 %}	100.0 % +200 %	Display parameter only
C635*	Limiting element 2 upper limit	100 %	-100.0 % -200 %	{0.1 %} {1 %}	100.0 % +200 %	C635 must be higher than C636!
C636*	Limiting element 2 lower limit	-100 %	-100.0 % -200 %	{0.1 %} {1 %}	100.0 % +200 %	C636 must be lower than C635!
C637*	Input, limiting element 2	0 %	-100.0 % -200 %	{0.1 %} {1 %}	100.0 % +200 %	Display parameter only
C640*	PT1 element Time constant	20ms	0.01 s 1 s 10 s	{0.01 s} {0.1 s} {1 s}	1 s 10 s 50 s	
C641*	Input, PT1 element	0 %	-100.0 % -200 %	{0.1 %} {1 %}	100.0 % +200 %	Display parameter only
C650*	Gain DT1 element	1.00	-10.00	{0.01}	+10.00	
C651*	DT1 element Time constant	1.0 s	0.01 s 1.0 s	{0.01 s} {0.1 s}	1.00 s 5.0 s	
C652*	Input, DT1 element	0 %	-100.0 % -200 %	{0.1 %} {1 %}	100.0 % +200 %	Display parameter only
C653*	Input sensitivity, DT1 element		-1- -2- -3- -4- -5- -6- -7-	15 bit evaluation 14 bit evaluation 13 bit evaluation 12 bit evaluation 11 bit evaluation 10 bit evaluation 9 bit evaluation		
C660*	Input, absolute value generator	0 %	-100.0 % -200 %	{0.1 %} {1 %}	100.0 % +200 %	Display parameter only
C670*	Square generator upper limit	0 %	-100.0 %	{0.1 %}	+100.0 %	C670 must be higher than C671!
C671*	Square generator lower limit	0 %	-100.0 %	{0.1 %}	+100.0 %	C671 must be smaller than C670!
C672*	Switch-over time of the square generator	0.1 s	0.1 s 10 s 100 s	{0.1 s} {1 s} {10 s}	10.0 s 100 s 3000 s	



8 Troubleshooting and fault elimination



Warning!

During troubleshooting, the drive should always be disconnected from the mains supply for safety reasons.

The controller is equipped with several functions to protect it from impermissible operating conditions. If one of the protection functions is activated, the controller sets Pulse Inhibit (IMP) or TRIP, warning or message and/or resets the signal "Ready for operation (RDY) - depending on the monitoring selected.

- Faults during operation are immediately displayed or indicated through a status information (chapter 8.1).
- The fault can be analysed with the history buffer (chapter 8.2) and the list in chapter 8.3.
- The list in chapter 8.3 indicates how to eliminate the fault.

8.1 Troubleshooting

8.1.1 Display on the operating unit of the controller

The LEDs RDY and IMP show the controller status.

FAIL = ■ : TRIP or message or warning is active

FAIL	RDY	IMP	Check
<input type="checkbox"/>	<input checked="" type="checkbox"/>	<input type="checkbox"/>	Controller enabled; no fault
<input checked="" type="checkbox"/>	<input type="checkbox"/>	<input checked="" type="checkbox"/>	C065, C066, C067
<input type="checkbox"/>	<input type="checkbox"/>	<input checked="" type="checkbox"/>	C183, C067
<input type="checkbox"/>	<input checked="" type="checkbox"/>	<input checked="" type="checkbox"/>	C183
<input checked="" type="checkbox"/>	<input checked="" type="checkbox"/>	<input type="checkbox"/>	C065, C066
<input checked="" type="checkbox"/>	<input checked="" type="checkbox"/>	<input checked="" type="checkbox"/>	C065, C066, C067, C183

■ : on

□ : off



Troubleshooting and fault elimination

RDY

In general, the RDY message will be reset if the machine cannot generate a torque when running with the command "Controller enable" or if the mains supply for the control electronics is switched-off (mains switch-off detection).

RDY is off when

- TRIP is displayed
- the communication with the automation module could not be established after mains connection (only with C370 = -1-)
- the field current could not be built up after mains connection.

RDY will be reset for a short period of time when

- a new parameter set is loaded via terminal control
- a short-term mains fault (3-phases) occurs (> 25ms).

I_{\max}

I_{\max} is on when

- the speed controller operates at its limit.

IMP

IMP is on when

- the switch Ctrl. enable is opened or another source of the controller inhibit is active (check C183)
- a mains undervoltage or mains overvoltage is applied.

IMP is on sporadically when

- short-term mains faults occur (e.g. with weak mains)

During IMP, the ignition pulses in the armature circuit are inhibited.

The codes C065, C066 and C067 display the controller status in plain text.

8.1.2 Display via LECOM

The bits of the status word under C069 indicate the controller status.



8.2 Fault analysis with the history buffer

With the history buffer, faults can be traced. The fault messages are stored in the history buffer in the order of their occurrence.

8.2.1 Structure of the history buffer

- The history buffer has eight memory locations, which can be retrieved
 - under C065, C066 and C067 at the operating unit
 - via the LECOM interface under codes C161 to C168 for TRIP messages.
- The first memory location is written only after the elimination or acknowledgement of the active fault. The eighth from last fault is eliminated in the history buffer and can no longer be read.
- The memory locations 1-8 contain information about the last to eighth from last fault.

Code	C0168
C063	Active message
C066	Active warning
C067	Active TRIP
C161	Memory location 1
C162	Memory location 2
C163	Memory location 3
C164	Memory location 4
C165	Memory location 5
C166	Memory location 6
C167	Memory location 7
C168	Memory location 8



Troubleshooting and fault elimination

8.3 Fault messages



Note!

If the fault message is interrogated by a fieldbus, the fault message is represented not by an abbreviation but a LECOM no. read from C167.

Display		Cause	Remedy
---	No fault	-	-
ACI	Armature circuit interrupted	Defective fuse in the armature circuit or cable interruption	Check armature fuse or remove cable interruption
CCr	System fault	Strong interference on control cables Ground or earth loops in the wiring	Screen control cables Check PE wiring (see chapter 4.4 "Installation of a CE-typical drive system")
CE0	Communication fault (automation interface)	Interference during transmission of control commands via the automation interface	Check wiring
CE9	Communication fault (serial interface)	Faulty messages from the serial interface.	Check wiring
dEr	Motor blocked	High standstill torque or motor mechanically blocked.	Remove motor blockage or increase blocking time under C124 or blocking current under C123.
EEr	External fault (TRIP-Set)	A digital input assigned to the TRIP-Set function has been activated	Check external encoder. Check polarity to activate TRIP set under C118.
FCI	Field circuit interrupted	Defective field fuses F1 and F2 or interrupted field circuit.	Replace field fuses when no voltage is applied or remove cable interruption.
LF	Mains underfrequency	Mains frequency < 47Hz	Check mains frequency, controller must only be driven within a frequency range from 47 to 63 Hz.
LU	Undervoltage	Mains voltage < 340 V or 410 V (Variant 500 V mains voltage) Mains synchronisation has not detected any voltage zero for more than 25 ms.	Increase electronics supply separately with a connected transformer or use a controller with a lower mains connection voltage.
LU1	Phase failure	Failure of the mains voltage or mains interruption	Check mains voltage and remove mains interruption Adapt mains synchronisation to mains conditions under C237.
OC5	Controller overload	Frequent or excessive acceleration with overcurrent Permanent overload with $I_A > 1.05 I_{Arated}$	Check drive dimensioning
OC6	Motor is thermally overloaded	Motor is thermally overloaded by, for instance, - impermissibly high continuous currents - frequent and excessive acceleration processes	Check drive dimensioning
OF	Mains overfrequency	Mains frequency > 63Hz	Check mains frequency Controller must only be driven within a frequency range from 47 to 63 Hz.
OH	Heat sink temperature is higher than the value set in the controller	Ambient temperature $T_{amb} > 45\text{ °C}$ or 35 °C Heat sink very dirty Incorrect mounting position	Allow controller to cool and ensure better ventilation Check ambient temperature in the control cabinet Clean heat sink Change mounting position

Troubleshooting and fault elimination



Display		Cause	Remedy
OUE	Mains overvoltage	Mains voltage > 460V or 550V (500V variant)	Reduce mains voltage with a preconnected transformer or use a controller with a higher mains connection voltage.
P03	Following error	Angle difference between set and actual position is larger than the following error limit set under C255 Drive cannot follow the digital frequency (I_{max} limit)	Extend following limit with C255 Switch-off monitoring if required (C119/C120) Enable drive (Ctrl. enable) Check drive dimensioning
P13	Angle overflow	Angle controller limit reached Drive cannot follow the digital frequency (I_{max} limit)	Enable drive Check drive dimensioning
PER	Program interference	A fault in the program sequence was detected	Send controller with data (on diskette) to Lenze
PR	Parameter reset	After switching on, a change in the software version has been detected. Automatic loading of factory setting.	Set the required parameters and save settings under C003.
PR1 ... PR4	Parameter set error	Fault when reading a parameter set CAUTION: The factory setting is loaded automatically	Set the required parameters and save settings under C003.
Sd1	Tacho fault	Short circuit or interruption of tacho cable	Check tacho cables for short-circuit or interruption and remove fault
Sd2	Resolver fault	Resolver cable interrupted	Check resolver cable for open circuit Check resolver Acknowledge fault by mains switching
Sd3	Encoder fault at Dig_In 1	Incremental encoder or digital frequency cable interrupted at X5 Input X5 PIN 8 not assigned	Check cable for open circuit Assign input X5 PIN 8 with encoder potential or switch off monitoring (C119 / C120)
Sd4	Encoder fault at Dig_In 2	Incremental encoder or digital frequency cable interrupted at X9 Input X9 PIN 8 not assigned	Assign input X9 PIN 8 with encoder potential or switch off monitoring (C119 / C120)
Sd5	Master current interrupted	Interruption of the master current selection, $I_{master} < 2\text{mA}$ with master current selection 4...20mA, C034 = -0- = -1-	Remove interruption of the set-value cable or select master selection 0...20 mA under C034 = -0- = -1-
SP	Wrong signal source polarity	Tacho, resolver or fieldbus connection are interchanged	Change tacho, resolver or fieldbus connection
U15	$\pm 15\text{V}$ supply interfered	Overload / short-circuit terminal 20 $\pm 15\text{ V}$ supply defective	Check load at terminal 20 Return controller



Troubleshooting and fault elimination

8.4 Reset of fault indications

TRIP

After eliminating the fault, pulse inhibit will only be reset after the acknowledgement of TRIP.

TRIP acknowledgement:

- Change to the parameter level of C067 and acknowledge with SH+PRG
- LECOM: C043 = 0
- Terminal X2/E2 (reset trip)
- Control word AIF
- Mains switching



Note!

If a TRIP source is still active, TRIP cannot be reset.

Message

After eliminating the fault, the pulse inhibit will be reset automatically.



8.5 Checking the drive system



Note!

The measurements should be made with a digital voltmeter. The stated measuring values are rated values. In the event of deviations, a defect has occurred.

8.5.1 Checking the motor



Warning!

- The measurements described must only be carried out by specialists.
- Disconnect the motor from the mains.
- Tests should only be carried out when no voltage is applied!

Measurement	Measuring point	Measured value
Armature resistance	A → B at the controller	$R_A < 10 \Omega$
Insulation resistance of the armature	A → earth potential	$R \rightarrow \infty$
	B → earth potential	
Field resistance	I → K	$R_f < 1k\Omega$
Insulation resistance of the field	I → earth potential	$R \rightarrow \infty$
	K → earth potential	



Troubleshooting and fault elimination

8.5.2 Checking the controller

Checking the power stage



Warning!

- The measurements described must only be carried out by specialists.
- Disconnect the controller from the mains.
- Tests should only be carried out when no voltage is applied!

Measurement	Measuring point	Measuring value
Semiconductor fuse • at the mains input • armature fuse		$R \approx 0 \Omega$ $R \approx 0 \Omega$
Internal fuses		$R \approx 0 \Omega$
Thyristors	Disconnect armature cables: A → B at the controller B → A at the controller	$R \rightarrow \infty$ $R \rightarrow \infty$
Field controller	Disconnect field cables: I+, K- I-, K+ (free-wheeling diode)	$R \rightarrow \infty$ $R > 200k\Omega$ (diode $\approx 0.5V$)

Checking the control board 4902MP

Checking the voltage supply:

- Wire up the controller completely
- Set controller inhibit (X2/28 open)
- Switch on the mains

Notes	Measuring point	Measured value
+Vcc 15 V	X2/20 → X3/40	+14.25 V...+15.75 V
+Vref 10 V	X1/9 → X3/40	+9.79 V...+10.21 V
-Vref 10 V	X1/10 → X3/40	-9.79 V... -10.21 V

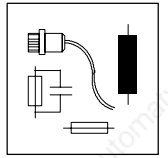

9 Accessories

For the controllers, Lenze offers the following accessories (to be ordered separately):

- Mains chokes
- RFI filters
- Fuses
- Fuse holders
- System cable for resolver / incremental encoder
- System cable for digital frequency coupling.

A PC can be connected to the controller via the fieldbus module LECOM A/B (RS232, RS485 or fibre optics). The parameter setting of the controller is very easy using LEMOC 2.

PC program LEMOC2

The program runs under DOS and is supplied with drivers for LECOM A/B (RS232, RS485 or fibre optics).

Functions of the program:

- Well-structured parameter setting and diagnosis
- Easy backup

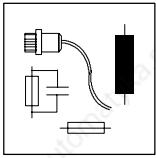

Accessories

9.1 Fuses



Note!

The fuses protect the controller from impermissible operating conditions. After a protection function has been activated, the controller or system must be checked for faults before replacing the fuse.

Because of possible damage to the semiconductor fuses, which have not blown, replace the complete set (phase and armature fuses).

Ensure to use the same fuse type of the same manufacturer as used before.

To protect the semiconductors (thyristors) from short-circuit, use very quick-acting fuses. The characteristics of fuse and semiconductor must be adapted to each other.

- The tables TAB 1 and TAB 3 list the max. permissible fuse sizes, which protect the semiconductors in the event of short-circuit, for all controller sizes.

The protection characteristics of the fuses are guaranteed even if the controller is operated with max. armature current (1.2 to 1.8 times rated current of the controller).

The fuses are recommended for standard controllers as well as for variants with “500V mains voltage”.

- For applications which do not require the max. permissible armature current, check whether it is possible to use smaller rated fuse currents. The tables TAB 2 and TAB 4 list the assignment of the fuses to the controller sizes (mains voltage 340 ... 460 V \pm 0%) on condition that the max. armature current (C022, C023) does not exceed the rated armature current of the controller.

With fuses other than recommended, check the switch-off characteristic and whether the actual load cycle does not lead to early ageing of the fuse.

For further information, please contact Lenze or the fuse supplier.

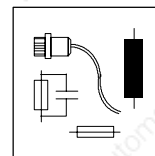

9.1.1 Mains fuses



Stop!

An additional cable protection is required when using fuses of the operating class aR (partial characteristic) as phase fuses.

If the fuses of the operating class gR also protect the cable, the cable cross-sections must be dimensioned according to the fuse. Otherwise, provide a separate cable protection!

Type	Max. perm. size of the phase fuse (F'1, F'2, F'3) Mains voltage ≤ 550V +0%			Fuse holder
	Fuse type	Operating class	Order designation	Order designation
4902	FF 32 A (22 x 58)	gR	EFSFF0320AYI	EFH30006
4903	FF 40 A (22 x 58)	gR	EFSFF0400AYI	EFH30006
4904	FF 80 A (22 x 58)	gR	EFSFF0800AYI	EFH30006
4905	FF 200 A (01.110)	aR	EFSFF2000AYR	EFH10003
4906	FF 250 A (01.110)	aR	EFSFF2500AYR	EFH10003
4907	FF 350 A (01.110)	aR	EFSFF3500AYR	EFH10003
4X08	FF 450 A (01.110)	aR	EFSFF4500AXP	EFH10003
4X09	FF 700 A (02.110)	aR	EFSFF7000AYR	EFH10003

TAB 1 Assignment of max. mains fuse size to the controller

Type	Recommended phase fuse size (F'1, F'2, F'3) when $I_{Amax} = I_{Arated}$ of the controller Mains voltage ≤ 460V +0%			Fuse holder
	Fuse type	Operating class	Order designation	Order designation
4902	FF 20 A (14 x 51)	aR	EFSFF0200AYH	EFH10002
4903	FF 32 A (14 x 51)	aR	EFSFF0320AYH	EFH10002
4904	FF 63 A (22 x 58)	aR	EFSFF0630AYI	EFH30006
4905	FF 125 A (00.80)	aR	EFSFF1250AXL	EFZ0003
4906	FF 200 A (00.80)	aR	EFSFF2000AXL	EFZ0003
4907	FF 315 A (00.80)	aR	EFSFF3150AXL	EFZ0003
4X08	FF 400 A (01.110)	aR	EFSFF4000AXR	EFH10003
4X09	FF 550 A (01.110)	aR	EFSFF5500AXP	EFH10003

TAB 2 Assignment of mains fuses to the controller when $I_{Amax} = I_{Arated}$ and a mains voltage of ≤ 460V +0%

The controllers 4X11 to 4X13 are equipped with cell fuses (F1.1/F1.2, F2.1/F2.2, F3.1/F3.2). Fuseholders are not necessary.

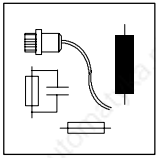

Accessories

9.1.2 Armature fuses

Armature fuses protect the thyristors of the controller from feedback of the motor in generator mode.

When using AC fuses as armature fuses, the max. operating voltage of the semi-conductor fuse is restricted, because of the time constant L/R of the armature circuit.

Therefore, the rated fuse voltage of the following fuse type is considerable higher than the voltage of the phase fuses recommended.

Type	Max. perm. fuse size for the armature circuit (F'4) Mains voltage $\leq 550V + 0\%$			Fuse holder
	Fuse type	Operating class	Order designation	Order designation
4902	FF 40 A (27 x 60)	①	EFSCC0400AYJ	EFH30005
4903	FF 50 A (27 x 60)	①	EFSCC0500AYJ	EFH30005
4904	FF 100 A (27 x 60)	①	EFSCC1000AYJ	EFH30005
4905	FF 250 A (01.110)	aR	EFSFF2500AZR	EFH10003
4906	FF 315 A (01.110)	aR	EFSFF3150AZR	EFH10003
4907	FF 400 A (02.110)	aR	EFSFF4000AZR	EFH10003
4X08	FF 550 A (03.110)	aR	EFSFF5500AZR	EFH10003
4X09	FF 800 A (03.110)	aR	EFSFF8000AZR	EFH10003

TAB 3 Assignment of max. armature fuse size to the controller

① DC fuse

Type	Recommended armature fuse size (F'4) when $I_{Amax} = I_{Arated}$ of the controller Mains voltage $\leq 460V + 0\%$			Fuse holder
	Fuse type	Operating class	Order designation	Order designation
4902	FF 20 A (14 x 51)	aR	EFSFF0200AYH	EFH10002
4903	FF 32 A (14 x 51)	aR	EFSFF0320AYH	EFH10002
4904	FF 80 A (22 x 58)	aR	EFSFF0800AYI	EFH30006
4905	FF 125 A (00.80)	aR	EFSFF1250AXL	EFZ0003
4906	FF 200 A (00.80)	aR	EFSFF2000AXL	EFZ0003
4907	FF 315 A (00.80)	aR	EFSFF3150AXL	EFZ0003
4X08	FF 500 A (02.110)	aR	EFSFF5000AZR	EFH10003
4X09	FF 700 A (02.110)	aR	EFSFF7000AXP	EFH10003

TAB 4 Assignment of armature fuses to the controller when $I_{Amax} = I_{AN}$ and at a mains voltage of $\leq 460V + 0\%$

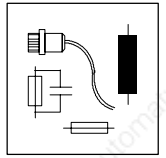

9.1.3 Internal fuses

Except for the cell fuses, all fuses are on the board 4902/3/5 LP or 4X08/11 LP.

	Type	Rated data			Order designation
		Fuse type	V [V]	Dimensions [mm]	
Field fuses F1, F2	4902 ... 4907	FF 16 A	500	6.3 x 32	EFSFF0160AWB
	4X08 ... 4X13	FF 32 A	600	14 x 51	EFSFF0320AYH
Electronics fuses F3, F4		M0.5 A	500	5 x 30	EFSM-0005AWA
Overvoltage protection F5, F6, F7		FF16 A	500	6.3 x 32	EFSFF0160AWB
Cell fuses F1.1/F1.2 F2.1/F2.2 F3.1/F3.2	4X11	500 A	1000	01.80	EFSFF5000AZ
	4X12	800 A	1000	02.80	EFSFF8000AZ
	4X13	900 A	1000	03.80	EFSFF9000AZ

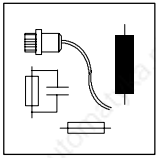

Accessories

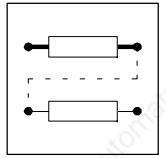

10 Signal-flow charts

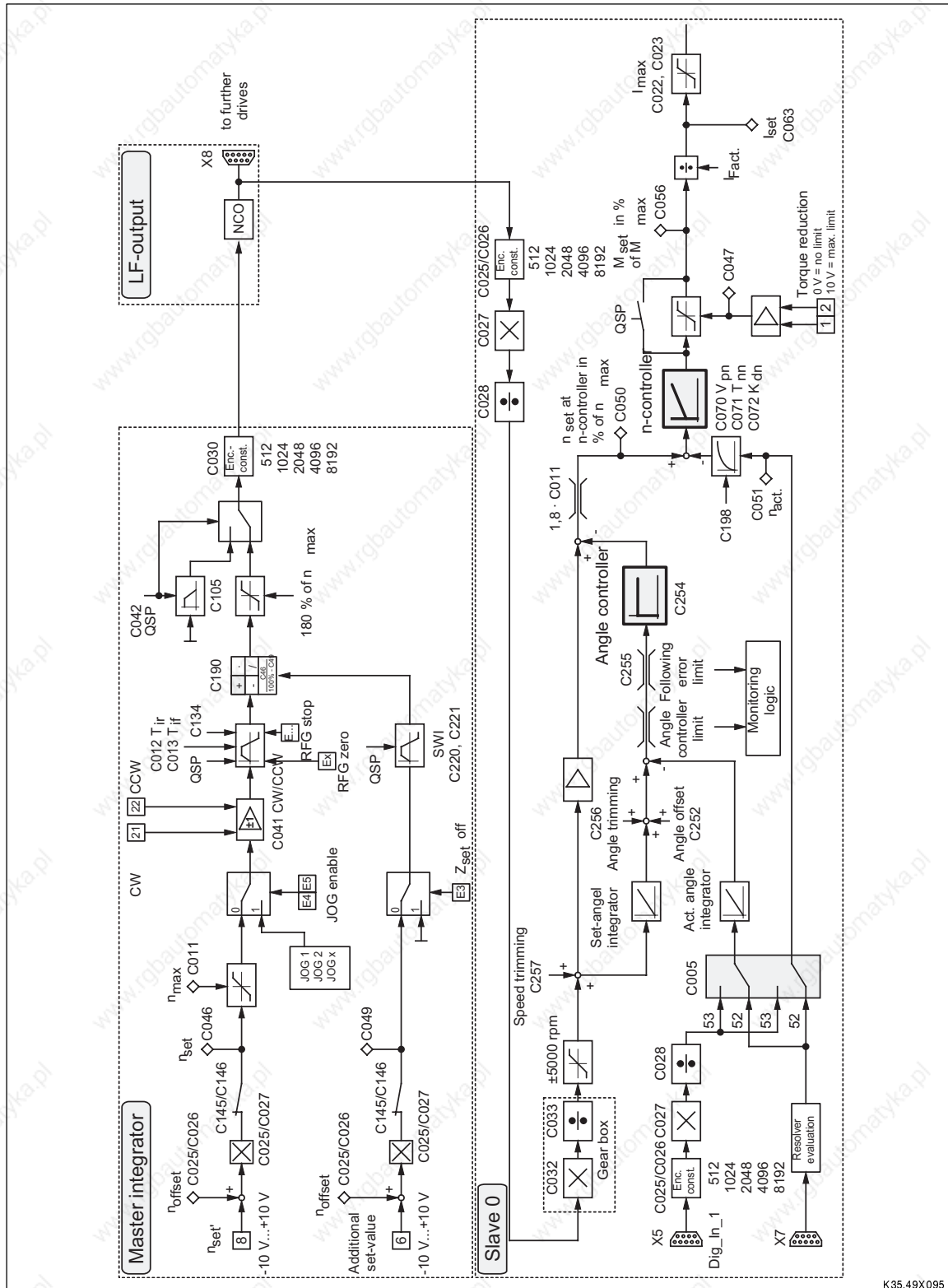

FIG 10-1 Signal-flow chart Masterconfiguration C005 = -5X-

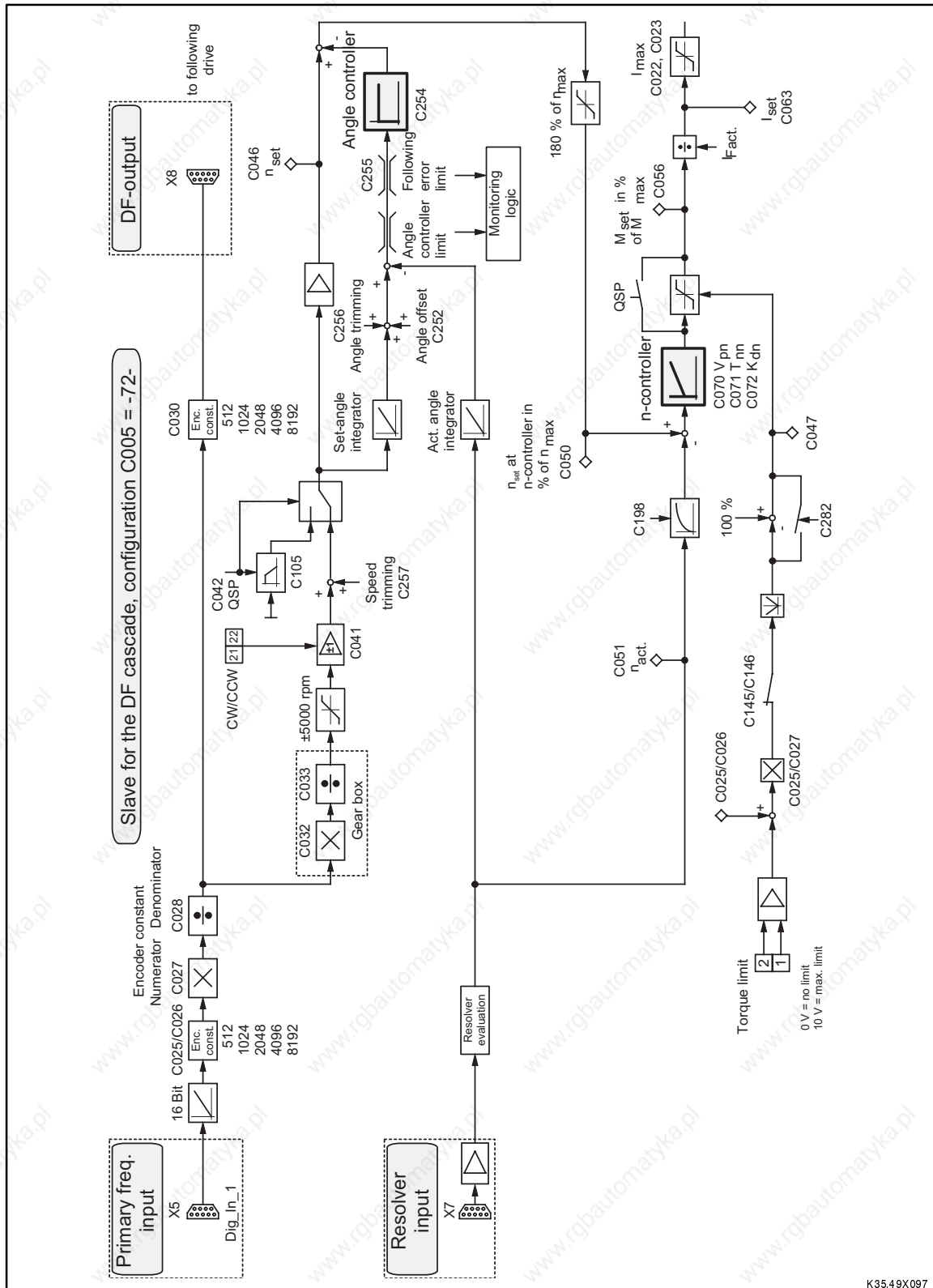
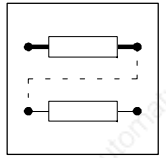
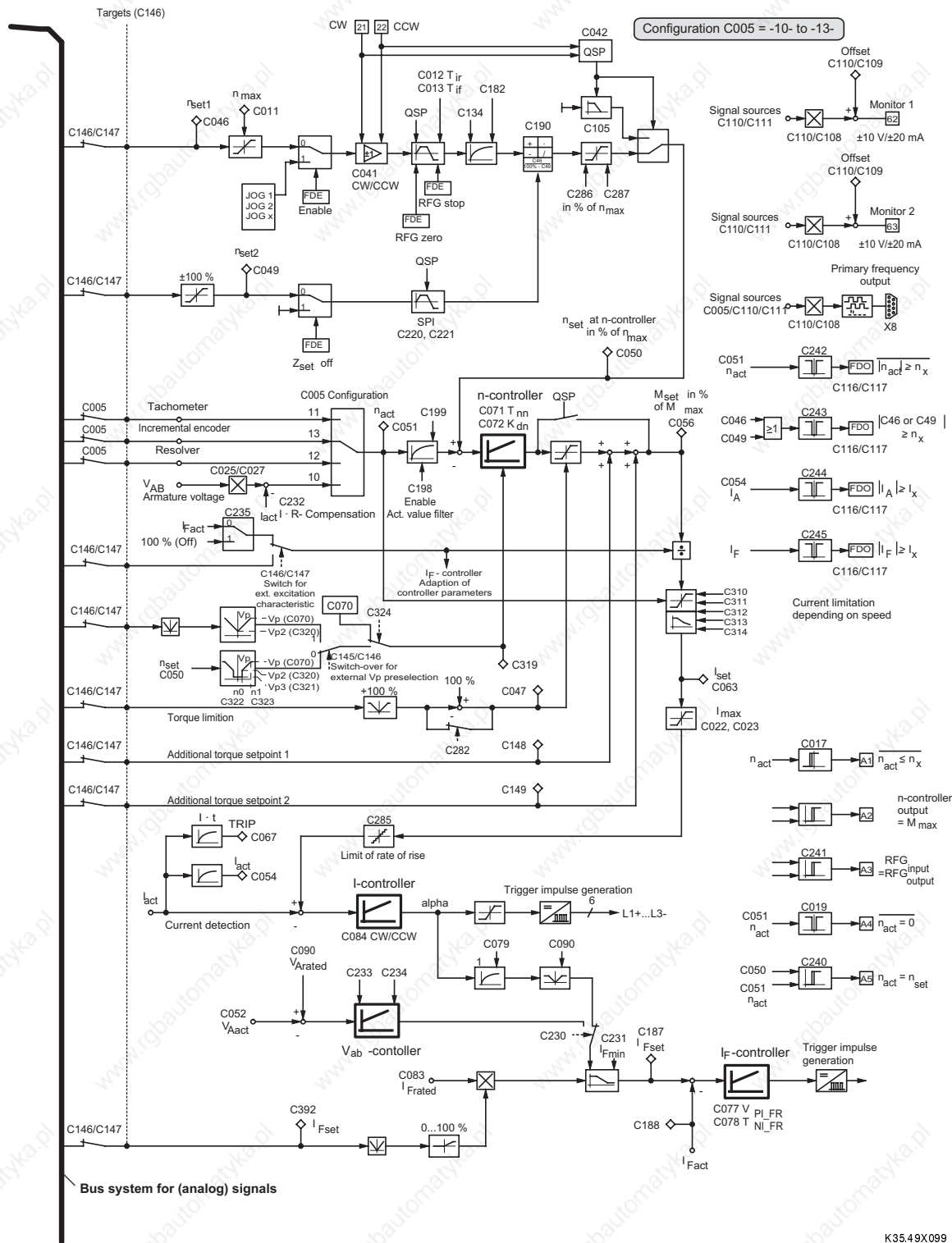
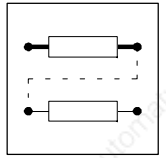

FIG 10-3 Signal-flow chart Configuration C005 = -72- (DF cascade)

Signal-flow charts



K35.49X099

FIG 10-4 Signal-flow chart Configuration C005 = -1X- (speed control)

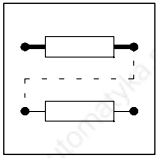

Signal-flow charts

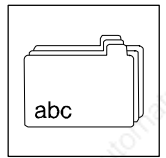

11 Index

2Q operation, Change of the direction of rotation, 4-23

A

Accessories, Fuses, 9-2

Act. value, Adjustment of tacho voltage, 4-15

Actual value

Armature current, 4-16

Displays, 7-18

Feedbacks, 7-11

Tacho voltage adjustment, 7-12

Additional setpoint, 5-10, 7-3, 7-13

Ambient temperature, Operation, 3-1

Analog inputs and outputs, 4-14

Application as directed, 1-3

Application conditions, 3-3

Armature current, Actual-value display, 4-16

Armature fuse, 9-4

Assembly space, 3-1

Auxiliary starting circuit, Field controller, 4-6

B

Baud rate, 4-26

Brake control, 5-10

C

Cable protection fuses, 5-26, 9-3

CE conformity, 1-5

CE typical drive system, IT mains, 4-4

CE-typical drive system, 4-29

Components, 4-30

Filters, 4-31

Grounding, 4-32

Installation, 4-29

Screening, 4-31

Signal cables, 4-31

Code, Code table, 7-20

Code set

Changeable, 7-18, 7-20

Display, 7-18

Commissioning, 5-1

Compensation unit, 4-4

Condensation, 3-3

Configuration

Armature voltage feedback, 7-11

Change, 5-12

Incremental encoder feedback, 7-14

Resolver, 7-14

Tacho feedback, 7-12

Connection

Incremental encoder, 4-22

Resolver, 4-21

Control board, Switch for configuration, 7-5

Control cables, Screening, 4-3

Control module

Layout of the connections, 4-13

Switch for configuration, 4-13, 4-15

Controller enable, 5-9

D

DC tacho, 7-12

Deceleration ramp, Quick stop, 5-10

Declaration of conformity, Low-Voltage, 1-6

Declaration of conformity, Electromagnetic compatibility, 1-8

Digital frequency

Output frequency, 5-14

Selection, 4-24

Digital inputs and outputs, 4-17

Digital frequency, Output, 4-25

Dimensions, Controller, 3-8

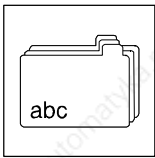

Table of keywords

Direction of rotation, 5-10

Display functions, 7-18

E

Earthing, 4-4

Group drives, 4-4

Mass loops, 4-4

EC Directive

Electromagnetic compatibility, 1-7
Considered standards, 1-8

Low-Voltage, 1-5

Machinery, 1-10

Electrical isolation, 4-2, 4-26

Mass loops, 4-4

Encoder emulation, 4-25

F

Fault

Cause, 8-4

History buffer, 8-3

Remedy, 8-4

Fault indication, Reset, 8-6

Fault message, 8-4

Features, Controller, 3-1

Field controller, Separate supply, 4-9

Fieldbus connection

InterBus, 4-27

PROFIBUS, 4-28

Fuse, 9-2

Internal, 9-5

G

Gain

Adaption, 7-41

Analog inputs, 7-23

Angle controller, 7-38

Field controller, 7-28

Process controller, 7-38

Gases, 3-3

Gearbox, Limitation of rate of rise, 7-40

Ground, Earth loops, 8-4

Grounding, 4-32

RFI filter, 4-29

H

History buffer, 8-3

Hoist, 4-20

Hoists, Overspeeds, 2-3

I

Identification, 7-19

IMP, 7-16, 8-2

Incremental encoder

Connection, 4-22

Monitoring, 4-23

Parameter setting, 7-14

Supply, 4-23

Inputs

Analog, 4-15

Digital, 4-19

Freely assignable, analog, 5-13

Freely assignable, digital, 5-12

Installation

CE-typical drive system, 4-29

Connection, 4-5

electrical, 4-2

Installation height, 3-3

mechanical, 3-1

Integral action time, Field controller, 7-28

InterBus, Interface module, 4-27

IT mains, 4-4

J

JOG

Enable, 7-4, 7-5

Setpoints, 7-3

L

Labelling, 1-1, 1-3

Language, 7-18

LECOM-A/B, 4-26

Networking, 4-26

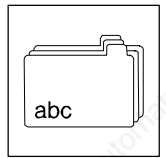

LECOM1, 4-26
Level converter, 4-26
Liability, 1-4
Limitation, Speed setpoint, 7-10, 7-12

M

Main setpoint, JOG setpoints, 7-3
Mains
 Conditions, 4-4
 Types, 4-4
Mains fuses, 9-3
Mains setpoint, 7-3
 Adjustment, 7-12
 Ramp function generator, 7-7
Mains voltage, 3-4, 8-4
 400 V, 3-4
 500 V, 3-6
Manufacturer's Declaration, Machinery, 1-10
Master current, 4-15
Master voltage, 4-15
Message
 Fault, 8-4
 LED state display, 7-16
Monitor
 Changeover current/voltage, 4-16
 Outputs, 4-16
Motor
 Armature time constants, 5-8
 Checking, 8-7
 Connection, 4-5
 Motor data input, 5-8

N

Noise immunity, 3-3

O

Operating unit, 7-16, 7-19
 Operating modes, 7-17
Operation
 ready for (terminal 44), 4-19

Speed controlled, 7-1
State, 7-27
with host connection, 4-26

Operator's safety, 4-2

Outputs

Analog, 4-16
Digital, 4-19
Freely assignable, analog, 5-14
Freely assignable, digital, 5-13
Fuse monitoring, 4-20
Relay, 4-20

Overtemperature, 7-27

P

Parameter setting, 7-15

Peripherals

Interface module 2110IB, 4-27
Interface module 2130IB, 4-28
Level converter 2101IB, 4-26

Power connection, Standard controller, 4-6

Power derating, 3-1

Pulse inhibit, Message, 8-2

Q

QSP, 5-10

Qualified personnel, 2-2

Quick stop, 4-19, 5-10

Code set, 7-24

Possible configuration, 5-11

R

Ramp function generator, 7-3

Additional setpoint, 7-3

Main setpoint, 7-3, 7-7

Ramp times, 7-7

Rated data, 3-4

Armature voltage, 3-4

Ratio, 7-24

RDY, 7-16

RDY, 8-2

Ready for operation, Message, 8-2

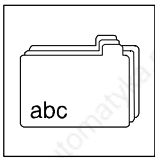
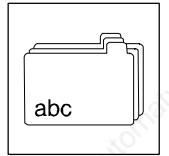

Table of keywords

- Relative humidity, 3-3
- Relay output, 4-20
- Reset, Fault indication, 8-6
- Residual hazards, 2-3
- Resolver, 4-21, 7-14
 - Encoder emulation, 4-25
- Rotor position, 7-25
- RS232/485, 4-26
- S**
- Safety information
 - General, 2-3
 - Icons, 2-4
- Scope of delivery, 1-1
- Screening
 - Control and signal cable, 4-3, 4-31
 - Power connections, 4-30
- Setpoint
 - Additional setpoint, 7-3
 - JOG, 7-3
 - Limitation, 7-10, 7-12
 - Main setpoint, 7-3
 - Master current, 7-5
 - Selection, 7-2
- Setting range, Current, 3-1
- Signal flow chart, Speed setpoint selection, 7-2, 7-10
- Signal-flow charts, 10-1
- Signals
 - Analog connection, 4-14
 - Connection of digital, 4-17
- Single drives, 4-4
- Software version, 7-29
- Speed
 - Accuracy, 3-1
 - Automatic adjustment, 7-12
 - Setpoint limitation, 7-10
 - Setting range, 3-1
- Speed control
 - With additional setpoint, 7-2
 - With armature voltage feedback, 7-11
 - With incremental encoder, 7-14
 - With resolver feedback, 7-14
 - With tacho feedback, 7-12
- Speed field, With armature voltage feedback, 7-11
- Sprache, 3-1
- Standard, 2-1
 - considered, 1-6, 1-8
 - IEC 364, 2-1, 2-2
 - Degree of pollution, 3-3
 - DIN 40050, 3-3
 - DIN 42017/VDE 0530 part 8, 4-5
 - DIN 43673, 4-5
 - DIN VDE 0100, 1-6, 2-1
 - DIN VDE 0110, 1-6, 2-1, 3-3
 - DIN VDE 0110 VBG 4, 2-1
 - DIN VDE 0160, 1-6, 2-1
 - DIN VDE 0530/8, 4-5
 - DIN VDE 0558, 2-1
 - DIN VDE 0660 part 500, 2-1
 - EN 50081-2, 1-8, 3-3
 - EN 50082-2, 1-8
 - EN 55011, 1-8, 3-3
 - EN 60097, 1-6
 - EN 60146, 2-1
 - EN 60439-1, 2-1
 - EN 60529, 1-6
 - EN 61000-4-2, 1-9, 3-3
 - EN 61000-4-4, 1-9, 3-3
 - EN 61000-4-5, 1-9, 3-3
 - ENV 50140, 1-9
 - IEC 1000-4-3, 1-9, 3-3
 - IEC 22G, 3-3
 - IEC 249, 1-6
 - IEC 326, 1-6
 - prEN 50178, 1-6
 - prEN 50178, 2-1
 - VDE0220, 4-5
- Supply
 - Separate, control electronics, 4-11
 - Separate, field-current bridge, 4-9
- Switch-on display, 7-19
- System fault, 8-4



T

Tacho

Feedback, 7-12

Rated voltages, 4-21

Technical data, 3-1

Dimensions, 3-8

Electrical data, 3-4

general data/application conditions, 3-3

Temperature

Heat sink, 8-4

Storage and transport, 3-3

Terminals

Changing the signal assignment, 5-12

Control connections, 4-13

Type of operation, 7-17

Torque, Reduction, 7-5

Trip

Controller inhibit, 5-9

LED state display, 7-16

Reset, 8-6

Troubleshooting, 8-1

Cause, 8-4

V

Variant design

V011 InterBus, 4-27

V013 PROFIBUS, 4-28

Variants, V014 500V mains voltage, 3-6

W

Warranty, 1-4

Waste disposal, 1-4

Z

Zero track, 7-25