

# Liquid Level Switch

## *liquiphant M FTL 50, 51, 50 H, 51H*

**Level limit switch for all liquids**  
**Suitable for use in hazardous areas, chemicals,**  
**food and pharmaceuticals**



Liquiphant M FTL 51  
with Aluminum  
Housing  
and Extension Tube,  
ANSI Flange Mounted  
(Explosion Proof)



Liquiphant M FTL 50  
with Polyester  
Housing  
and 3/4" NPT  
Threaded  
Connection



Liquiphant M FTL 50 H with  
SS Housing and Tri-clamp®

### Features and Benefits

- Large selection of process connections: universal use
- Installs in threaded openings as small as 3/4" or in flanges as small as 1"
- Wide variety of electronics, e.g. DPDT relay, 4 to 20 mA switch, NAMUR, PFM signal output, transistor: the right connection for every process control system
- No calibration: quick, low-cost start-up
- No mechanical moving parts: no maintenance, no wear, economical long operating life
- Monitoring of fork for damage: guaranteed operation

### Applications

The Liquiphant M is a level limit switch for use in all liquids

- With temperatures between -40° and + 300°F (-40° to + 150°C)
- Pressures up to 930 psig (64 bar)
- Viscosity up to 10,000 cP
- Density from 0.5 SGU

The function is not affected by flow, turbulence, bubbles, foam, vibration, bulk solids content or build-up. The Liquiphant M is thus the ideal replacement for float switches, gap switches, capacitance and other technologies.

### Versatile Selection

- FTL 50: compact design, ideal for mounting in pipes
- FTL 51: extension tube for up to 115 inches maximum (3 m)
- FTL 50 H, FTL 51 H: with polished fork and easy to clean process connections and housings for food and pharmaceutical applications

High corrosion-resistant Alloy C4 is available for the fork and process connections for applications in very aggressive liquids.

The Liquiphant M includes versions for use in hazardous areas, including intrinsically safe and explosion-proof.

# Endress + Hauser

The Power of Know How



## Function and system design

### Function

The introduction of the Liquiphant M, a new generation frequency shift tuning fork, brings greater application flexibility and reliability to level switch users. Level switches are used in almost every processing and manufacturing facility around the world. Various mechanical devices (such as floats and displacers) are used in such applications as spillage prevention, dry pump indication, and batch level measurement. These types of level switches require high maintenance and process shutdowns due to sticky, viscous fluids, gas bubbles or turbulence. The Liquiphant M is not affected by turbulence, bubbles, foam, vibration, build-up, high viscosity, or bulk solids build-up. The Liquiphant M uses frequency shift technology for limit detection. The forks vibrate at their resonant frequency. This frequency changes when covered or uncovered by the liquid material, causing a change in the frequency which activates a limit switch.

The Liquiphant M provides continuous self-monitoring. The frequency shift of the tuning fork is monitored, an alarm state is indicated if there is fork corrosion or damage. Loss of power and piezo drive failure are also alarmed.

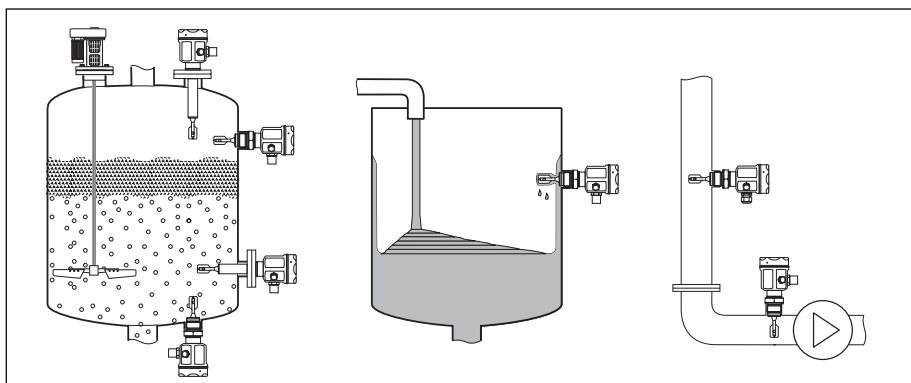

### Application

The Liquiphant M can be mounted at any orientation and in pipe lines. In applications where room allows, the unit can be extended into the vessel (up to 115") with an extension tube.

Minimum or maximum limit detection in pipes or tanks containing all types of liquids is possible with the Liquiphant M, including hazardous areas, food and pharmaceuticals. The increasing requirements for overflow or spill detection of chemicals, wastes, and many commodity fluids are ideal applications for the Liquiphant M. The high reliability and low maintenance provides safety for owners of storage tanks, chemical tanks, and petroleum product storage; on land, tank cars and barges.

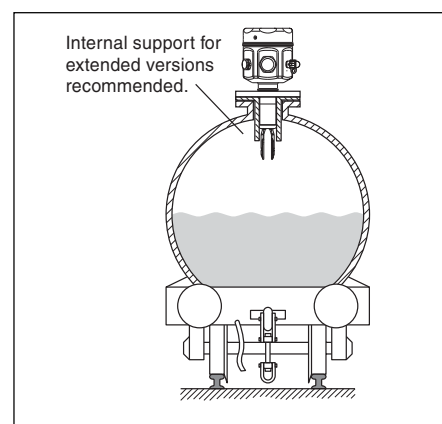

Rail car overflow protection

**System**

A complete system consists of an electronic insert, housing, process connection and sensor.

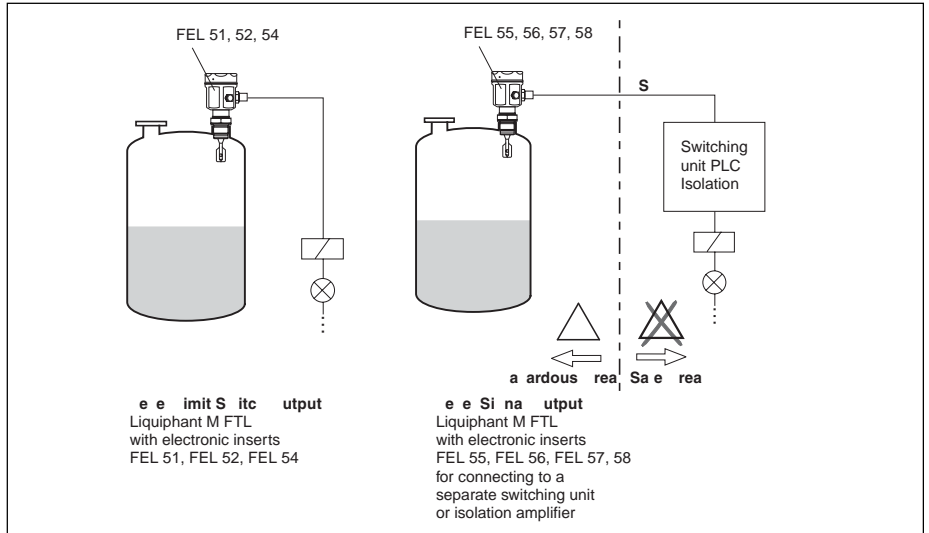

**Modular Design**

Depending on the application, the Liquiphant M is available in various electronic and mechanical versions to fulfill industrial requirements.

**P u in e lectronic inserts to mount in t e ousin**

FEL 51: Two-wire AC connection  
FEL 52: Three-wire DC connection, PNP  
FEL 54: Universal power (AC / DC), DPDT relay  
FEL 55: Output 8 / 16 mA for remote switching unit  
FEL 56: Output 0.35 to 1.0 / 2.1 to 6.5 mA for remote switching unit (NAMUR)  
FEL 57: Output 50 / 150 Hz, PFM, for remote switching unit (Nivotester)  
FEL 58: Output 2.1 to 3.5 / 0.6 to 1.0 mA for remote switching unit (NAMUR)

**ousin s**

Polyester      304 SS Sanitary      Aluminum (also for hazardous)

**Spacers**

Temperature spacers      2nd line of defense, pressure-tight bushing

**Process Connections**

3/4" or 1" NPT ANSI B 1.20.1      1" Flush mount for weld adapter (EE2)      1-1/2" / 2" Tri-clamp or 2" Varivent      ANSI B16.5 RF flanges from 1"

**Sensors**

Compact, 1.5" (240 grit polished available)      Extended tube, maximum 115" (240 grit polished available)

NOTE: for coated sensors in aggressive chemical applications, refer to Liquiphant M FTL 51 C, document T1 347F/24/ae.

## Process Connection Selection

Construction	Connection	Code	Version	Standard	Maximum Pressure/ Temperature	Notes
Threaded	3/4" NPT	GM2 GM5		ANSI B 1.20.1	930 psi 300°F	
	1" NPT	GF2 GF5		ANSI B 1.20.1	930 psi 300°F	
Flange	1" up to 4" Class 150 up to Class 600, raised face	A x x (see order codes)		ANSI B 16.5	300°F See rated pressure of flange	Seal according to design, installed on site
Tri-clamp®	1-1/2" 2"	TC2 TE2		ISO 2852	145 psi 248°F	Clamp ring and front seal installed on site
Flush-mounted for 1" weld adapter	1"	EE2		E+H Part number 52001047 (page 15)	580 psi 212°F or 360 psi 300°F	Fork can be positioned, refer to accessories
Varivent®	≥ 2-1/2"	WE2			145 psi 248°F	Clamp ring and O-ring, installed on site

## Electronic insert function

### Electronic inserts for level limit switches

- FEL 51: two-wire AC version, switch the load directly into the power supply circuit via the thyristor
- FEL 52: three-wire DC version, switch the load via the transistor (PNP) and separate connection (preferably used with PLC controller)
- FEL 54: universal AC / DC version with DPDT relay, switch the loads via two dry (potential-free) relay contacts

### Electronic inserts for level sensors

- FEL 55: two-wire loop-powered for separate switching unit for connecting to a PLC, signal transmission 16 / 8 mA (high to low current) along two-wire cabling
- FEL 56: two-wire for separate switching unit, signal transmission 0.6 to 1.0 / 2.1 to 2.8 mA (low to high current) to EN 50227 (NAMUR) along two-wire cabling
- FEL 58: two-wire for separate switching unit, signal transmission 2.1 to 3.5 / 0.6 to 1.0 mA (high to low current) to EN 50227 (NAMUR) along two-wire cabling. Checking of connecting cable and other devices by pressing a push button on the electronic insert.
- FEL 57: two-wire for separate switching unit, PFM signal transmission, current pulses superimposed on the power supply along the two-wire cabling. Testing at the switching unit without changing levels.

### Galvanic isolation

FEL 51, 52:	Between sensor and power supply
FEL 54:	Between sensor, power supply and load
FEL 55, 56, 57, and 58:	Refer to remote switching unit connected

### Connecting cables

Electronic insert wiring terminals, maximum 14 AWG (2.5 mm<sup>2</sup>), stranded in cable sleeve according to DIN 46228.

Ground connection in housing, maximum 14 AWG (2.5 mm<sup>2</sup>)

External housing ground for plant grounding system, maximum 11 AWG (4 mm<sup>2</sup>)

## Electronic insert operation and setup

### Display and operation elements

FEL 51, 52, 54 and 55: 2 switches for fail-safe mode and density change, green LED to indicate power on, red LED to indicate switching status (flashes when sensor is damaged by corrosion or when the electronics are defective)

FEL 56: 2 switches for fail-safe mode and density change, green LED flashes to indicate power on, red LED indicates switching status (flashes when sensor is damaged by corrosion or when the electronics are defective)

FEL 57: 2 switches for density change and cyclical checking, green LED indicates power is on, yellow LED indicates forks are covered (flashes when sensor is damaged by corrosion or when the electronics are defective)

FEL 58: 2 switches for fail-safe mode and density change, green LED flashes rapidly to indicate power on, flashes slowly on damage by corrosion on sensor or when the electronics are defective, yellow LED indicates relay status. Test push button breaks sensor circuit (refer to page 9).

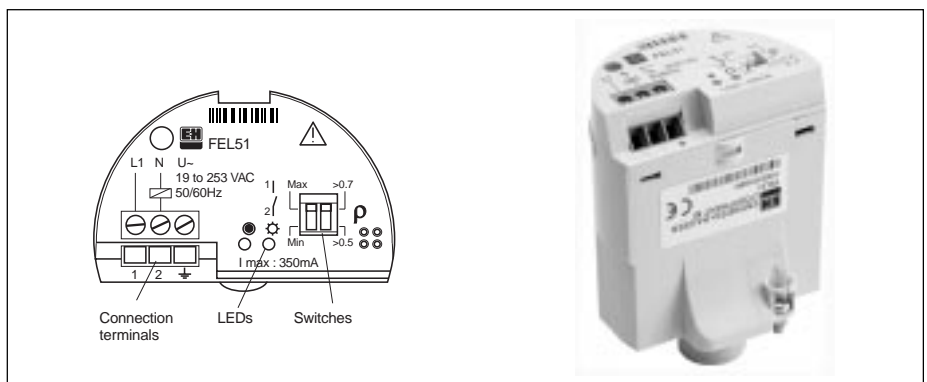

## Output

<b>Output signal</b>	Dependent on electronic insert specified, refer to pages 7 thru 11
<b>Failsafe mode</b>	Switch status for minimum / maximum residual current safety on electronic insert (with FEL 57 connected to remote switching unit FTL 325 P only). Maximum fail-safe: the output switches to the power failure mode when fork is covered (for use with overspill protection, etc.) Minimum fail-safe: the output switches to the power failure mode when fork is uncovered (for use with dry pump protection, etc.)
<b>Response time</b>	Approximately 0.5 seconds when forks are covered, approximately 1.0 seconds when forks are uncovered
<b>Power up response</b>	When switching power on, the output assumes the alarm signal mode. After a maximum 2 seconds, it assumes the correct switch status (exception, FEL 57).

## Performance characteristics

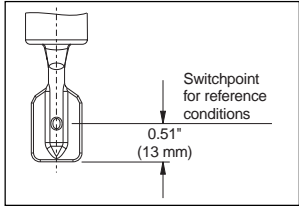
<b>Reference conditions</b>	Ambient temperature, 73°F (23°C) Product temperature 73°F (23°C). Product density, 1 SGU (water) Viscosity, 1cP Pressure, 0 psig Sensor mounted vertically from top Density selector switch > 0.7 SGU.	
<b>Measured error</b>	Specified by mounting position, ± 0.04" maximum (1 mm)	
<b>Repeatability</b>	0.004" (0.1 mm)	
<b>Hysteresis</b>	Approximately 0.08" (2 mm)	
<b>Effects of product temperature</b>	Maximum +0.05" to -0.11" (-40° to +300°F); maximum +1.4 mm to -2.8 mm (-40° to +150°C)	
<b>Effects of density</b>	Maximum 0.19" to -0.14" (4.8 to -3.5 mm) at 0.5 SGU to 1.5 SGU	
<b>Effects of pressure</b>	Maximum 0" to -0.09" at 0 to 870 psig; 0 to -2.5 mm (0 to 60 bar gage)	

## Wiring and Output Function

### FEL 51 two-wire AC

\* The terminal voltage at the electronic insert must not be below 19 V. Note the voltage drop across the electronic insert in the conducting state (max. 19 V), the residual current in the blocked state (max. 3.8 mA) and, when using low voltages, the voltage drop across the load.

The load can be an indicator light or remote relay. When switch is in the "OFF" state, a trickle current flows (up to 3.8 mA), not enough to light an indicator light or actuate a relay. When the switch is in the "ON" state, current flow increases to a level that can pull in a remote relay or light a filament bulb.

- NOTE: Unit must be connected in series with a load.
- Input power, 19 to 253 VAC, current consumption, 3.8 mA
  - Minimum voltage drop across the load at the electronic insert is 19 V \*.
  - When a relay cannot de-energize with a residual current below 3.8 mA, a resistor should be connected in parallel to the relay.
  - Signal on alarm, < 3.8 mA on power failure or damaged sensor
  - Diagnostic warning, the red LED flashes when sensor is damaged by corrosion, or when self-diagnostics detect electronics are defective.
  - Connectable load: load is switched directly into the power supply circuit via thyristor.
- Transient current (40 ms), max. 1.5 A, max. 375 VA at 253 VAC or max. 36 VA at 24 VAC (not short-circuit protected).
- Continuous max. 89 VA at 253 VAC, max. 8.4 VA at 24 V. Min. 2.5 VA at 253 V (10 mA), min. 0.5 VA at 24 V (20 mA)

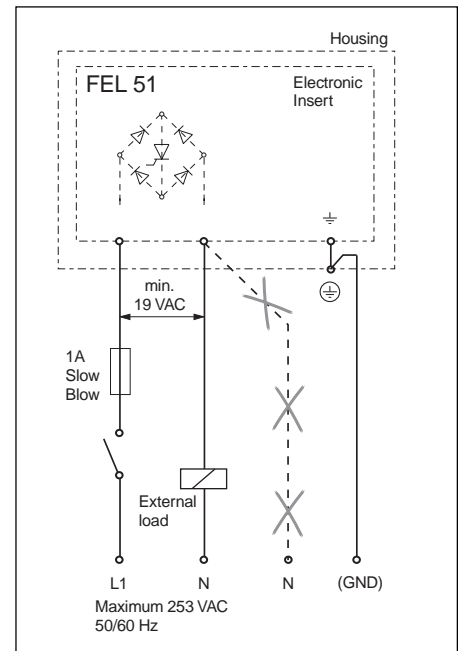

Replacement module PN: 5002304

$I_L$  = load current (closed)  
 < 3.8 mA = residual current  
 ☀ = lit  
 ● = unlit

Fail-safe mode	Level	Output signal	LEDs	
			green	red
Max.		1 — $I_L$ —> 2	☀	●
		1 — < 3.8 mA —> 2	☀	☀
Min.		1 — $I_L$ —> 2	☀	●
		1 — < 3.8 mA —> 2	☀	☀

**FEL 52 Three-wire DC**



NOTE: Preferably used with programmable logic controller (PLC)

- Input power, 10 to 55 VDC. Maximum ripple 1.7 V, 0 to 400 Hz.; max. current consumption, 15 mA; max. power consumption, 0.83 W. Reverse polarity protected.
- Positive signal at the switching output of the electronics (PNP)
- Signal on alarm, < 100mA on power failure or damaged sensor.
- Diagnostic warning, the red LED flashes when sensor is damaged by corrosion, or when self-diagnostics detect electronics are defective.
- Connectable load: load is switched via transistor and separate PNP connection.

Transient (1 s) maximum 1A, maximum 55 VDC (overload and short-circuit protected).







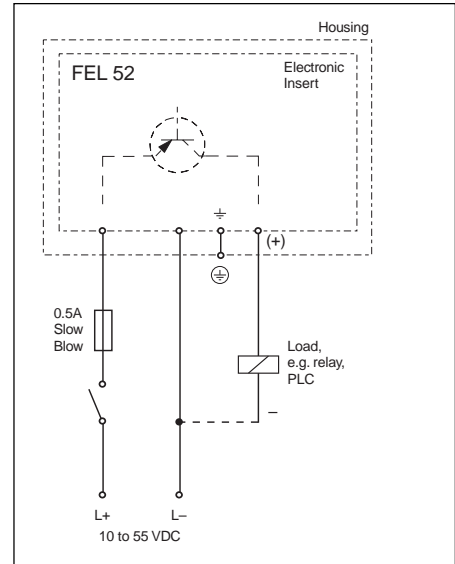





Continuous maximum 350 mA, max. 0.5 mF at 55 V, 1.0 mF at 24 V.

Residual voltage < 3 V with closed transistor; residual voltage < 100 mA with open transistor.

$I_L$  = load current (closed)  
 < 100  $\mu$ A = residual current  
 = lit  
 = unlit



Replacement module PN: 5002305

Fail-safe mode	Level	Output signal	LEDs green	LEDs red
Max.		$L+ \xrightarrow{I_L} 3$		
		$1 < 100 \mu A \rightarrow 3$		
Min.		$L+ \xrightarrow{I_L} 3$		
		$1 < 100 \mu A \rightarrow 3$		

**FEL 54 Universal AC / DC Power with DPDT relay**

Note the differences in input voltages for VAC and VDC.

- Input power, 19 to 253 VAC or 19 to 55 VDC. Max. power consumption, 1.3 W, reverse polarity protected.
- Both relays switch simultaneously.
- Signal on alarm on power failure or damaged sensor, relays de-energize.
- Diagnostic warning, the red LED flashes when sensor is damaged by corrosion, or when self-diagnostics detect electronics are defective.
- Connectable load: load is switched via DPDT relay contacts.





$I \sim$  max. 6 A,  $U \sim$  max. 253 V;

$P \sim$  max. 1500 VA,  $\cos j > 0.1$ ;

$P \sim$  max. 750 VA,  $\cos j > 0.7$  (P.F.);







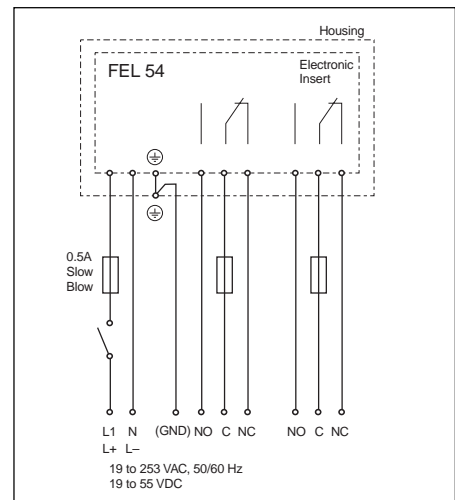





$I \sim$  max. 6 A to 30 V,  $I \sim$  max. 0.2 A to 125 V

NOTE: When connecting a low-voltage circuit with reliable isolation according to DIN/VDE 0160, the following applies: Total of voltages of relay output and power supply, maximum 300 V.

 = relay energized  
 = relay de-energized  
 = lit  
 = unlit



Replacement module PN: 5002306

Fail-safe mode	Level	Output signal	LEDs green	LEDs red
Max.		$3 \ 4 \ 5 \ 6 \ 7 \ 8$		
		$3 \ 4 \ 5 \ 6 \ 7 \ 8$		
Min.		$3 \ 4 \ 5 \ 6 \ 7 \ 8$		
		$3 \ 4 \ 5 \ 6 \ 7 \ 8$		

When connecting an instrument with high inductance, provide a spark arrester to protect the relay contacts. A fine-wire fuse (depending on load connected) protects the relays from short-circuiting.



**FEL 55 Two-wire for Separate Switching Unit**

For connecting to programmable logic controllers (PLC).

Output signal jumps from high to low current when limit reached (H-L edge).

- Input power, 11 to 36 VDC.
- Signal on alarm, < 3.6 mA on power failure or damaged sensor.
- Diagnostic warning, the red LED flashes when sensor is damaged by corrosion, or when self-diagnostics detect electronics are defective.
- Connectable load:

$$\text{Load } R = \frac{U - 11 \text{ V}}{16.8 \text{ mA}}$$

U = 11 to 36 VDC

~ 16 mA = 16 mA ± 5%

~ 8 mA = 8 mA ± 6%

☀ = lit

● = unlit

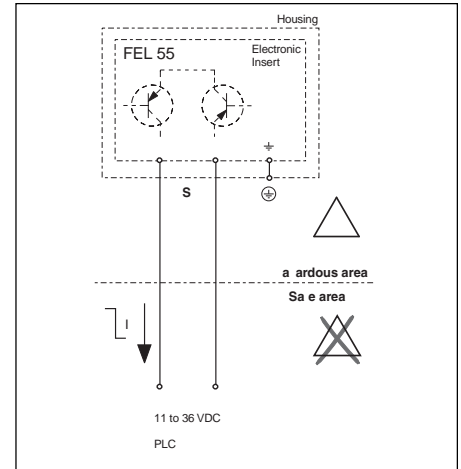

Replacement module PN: 5002307

Fail-safe mode	Level	Output signal	LEDs green	red
Max.		+ 2 - 16 mA → 1	☀	●
		+ 2 - 8 mA → 1	☀	☀
Min.		+ 2 - 16 mA → 1	☀	●
		+ 2 - 8 mA → 1	☀	☀

**FEL 56 Two-wire for Separate Switching Unit**

For connecting to isolating amplifiers according to NAMUR (EN 50227), e.g. FTL 325 N or FTL 375 N from Endress+Hauser.

Output signal jumps from low to high current when limit reached (L-H edge).

When connecting to a multiplexer, adjust clock time to 2 seconds minimum.

- Input power, Isolating Amplifier
- Signal on alarm, > 2.1 mA on power failure or damaged sensor.
- Diagnostic warning, the red LED flashes when sensor is damaged by corrosion, or when self-diagnostics detect electronics are defective.
- Connectable load: Refer to technical data of isolating amplifier connection according to EN 50227 (NAMUR).

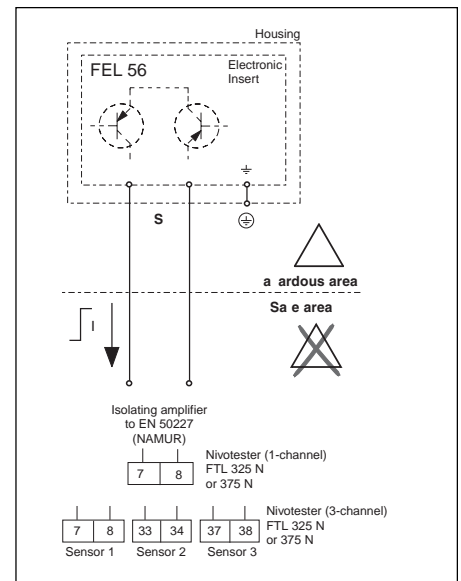

Replacement module PN: 5002308

☀ = lit  
 ☀ = flashing  
 ● = unlit

Fail-safe mode	Level	Output signal	LEDs green	red
Max.		+ 0.35 to 1.0 mA → 1	☀	●
		+ 2.1 to 6.5 mA → 1	☀	☀
Min.		+ 0.35 to 1.0 mA → 1	☀	●
		+ 2.1 to 6.5 mA → 1	☀	☀

**FEL 58 two-wire for remote switching unit with test push button**

For connecting to isolating amplifiers according to NAMUR (EN 50227), e.g. FTL 325 N or FTL 375 N from Endress+Hauser.

Output signal jumps from high to low current when limit reached (H-L edge).

The FEL 58 includes a test push button on the electronic insert. Pressing the button breaks the connection to the isolating amplifier.

**N T** The test function can be used for hazardous locations as long as there is no explosive atmosphere near the electronics housing.

When connecting to a multiplexer, adjust clock time to 2 seconds minimum.

- Input power, Isolating Amplifier
- Signal on alarm, < 1.0 mA on power failure or damaged sensor.
- Diagnostic warning, the yellow LED flashes when sensor is damaged by corrosion, or when self-diagnostics detect electronics are defective.
- Connectable load: refer to technical data of isolating amplifier connection according to EN 50227 (NAMUR).
- Connectable to isolating amplifiers which have special safety circuits (I > 3.0 mA).

- ☀ = lit
- ⚡ = flashes
- = unlit

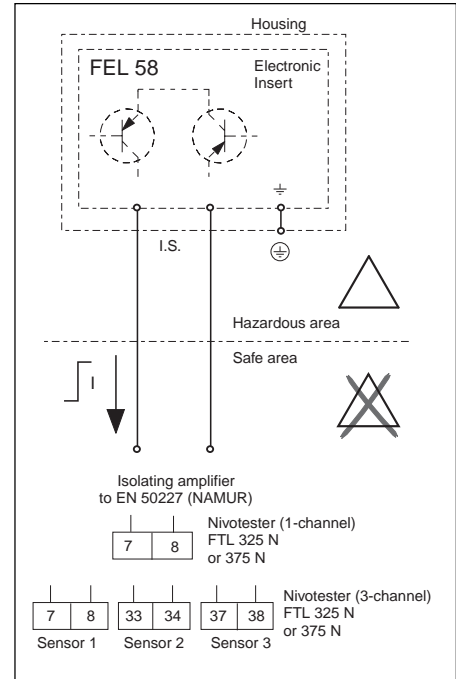

Fail-safe mode	Level	Output signal	LEDs	
			green	yellow
Max.		+ 2.1 to 3.5 mA 2 → 1	☀	☀
		+ 0.6 to 1.0 mA 2 → 1	☀	●
Min.		+ 2.1 to 3.5 mA 2 → 1	☀	☀
		+ 0.6 to 1.0 mA 2 → 1	☀	●

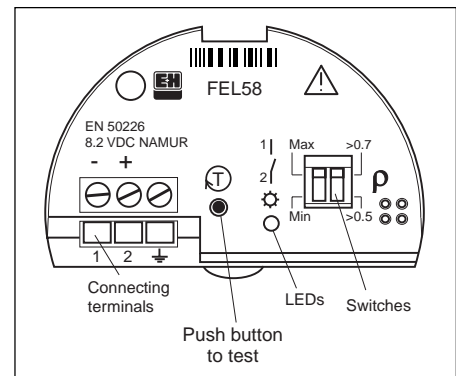

**FEL 57 Two-wire for Separate Switching Unit**

For connecting to switching units Nivotester FTL 320, FTL 325 P or FTL 375 P (also with cyclical checking), from Endress+Hauser.

- Input power provided by switching unit.
- Output signal (PFM \*) jumps from high to low frequency when sensor is covered.

\* Pulse Frequency Modulation (PFM)

- Switching between min. / max. fail-safe is set in Nivotester.
- Signal on alarm, 0 Hz on power failure or damaged sensor.
- Diagnostic warning, the yellow LED flashes when sensor is damaged by corrosion, or when self-diagnostics detect electronics are defective.
- Connectable load: Relay contacts provided in Nivotester or Commutec S units, refer to appropriate technical data of unit.

Additional Function, "Cyclical Checking" After interruption of the power supply, a clock is activated which checks the sensor and electronics without any change in level. Approved for overspill protection (according to WHG, Germany).

Switch on electronic insert:

Standard (STD): for weak corrosive liquids, simulation approximately 12 seconds

Fork free - covered - free

Extended (EXT): for highly corrosive liquids, simulation approximately 40 seconds

Fork free - covered - corroded - free

This check is activated and monitored by the external switching unit.

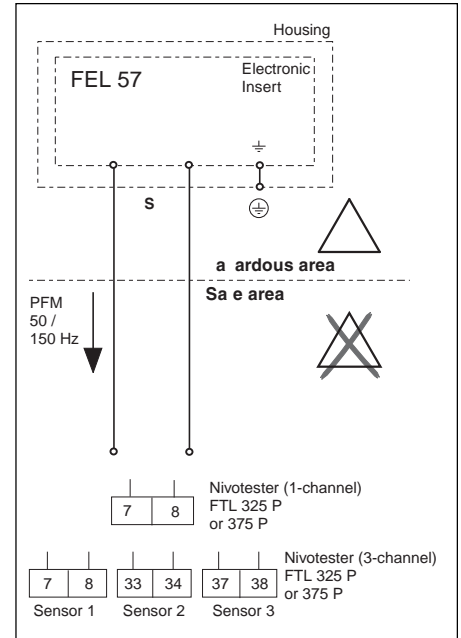

Replacement module PN: 5002309

Fail-safe mode *	Level	Output signal (PFM)	LEDs green	LEDs yellow
		150 Hz		
		50 Hz		

\* Signal on alarm, refer to chart below

= lit  
 = unlit

NOTE: For information regarding the Liquiphant M in safety related systems to IEC 61508 and ANSI/ISA S84.01, refer to SD 128F/00/en on Safety Integrity Level (SIL).

Fail-safe mode set at switching unit	Setting at FEL 57	Fork	Switching status of relay in switching unit on = energized    off = de-energized
			<p>Test start (power off)      End of test start (power on)</p>
Max.	STD	free	on   off   ~ 5 s off   ~ 2 s on   ~ 2 s off   on
Max.	EXT	free	on   off   ~ 5 s off   ~ 2 s on   ~ 35 s off   //   on
Max.	STD	covered	off   off   off
Max.	EXT	covered	off   off   off
Min.	STD	free	off   ~ 3 s on *   ~ 5 s off   ~ 3 s on   off
Min.	EXT	free	off   ~ 3 s on *   ~ 7 s off   ~ 30 s on //   off
Min.	STD	covered	on   ~ 3 s on *   ~ 5 s off   on
Min.	EXT	covered	on   ~ 3 s on *   ~ 5 s off   ~ 35 s on //   ~ 3 s off   on

\* De-energized on power supply failure

**N T** Please note the switching response and function of the unit when installed, especially when replacing a Liquiphant with an EL 17 Z or FEL 37 electronic insert with a Liquiphant M/S with the FEL 57 insert.

## Operating conditions (installation)

### Mounting

Switchpoints on the sensor depend on the mounting position, with reference to water (density 1 SGU at 73°F, 0 psi). Because the Liquiphant M requires no calibration, the switchpoint is determined by the position of the tuning fork.

**N T** The switchpoints of the Liquiphant M are at different positions compared to those of the previous compact Liquiphant II versions (FTL 360, FTL 365, FDL 30, and FDL 35).

**N T** When used in extremely light liquids (liquefied gas), set the density switch to > 0.5.

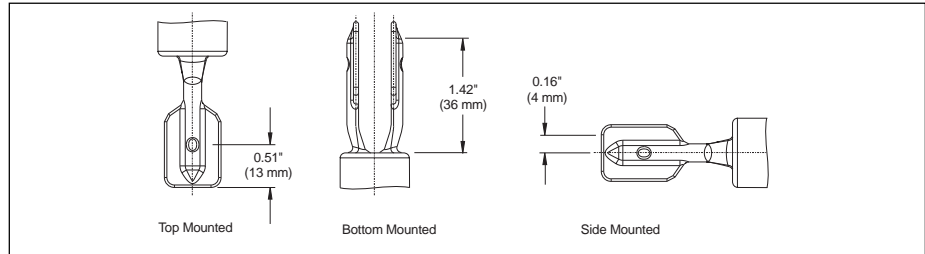

### High Viscosity Liquids

Examples of mounting with regard to the viscosity of the liquid and the amount of build-up are shown in the following illustrations. The optimum mounting, even with high viscosities is vertical, from the vessel top or horizontal (flush mounted from the side).

**N T** Horizontal mounting, position the forks so that the narrow edge of the tines are vertical. This ensures that the liquid can run off easily.

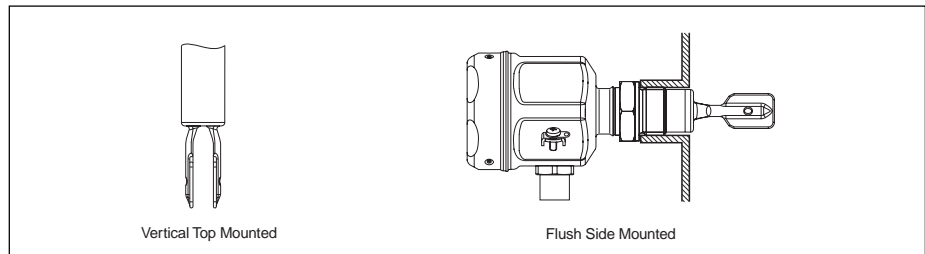

### Low Viscosity Liquids

Mounting positions for low viscosity liquids (up to 2000 cP) are shown below. The Liquiphant M can be nozzle mounted with flange or mounted into a threaded nozzle.

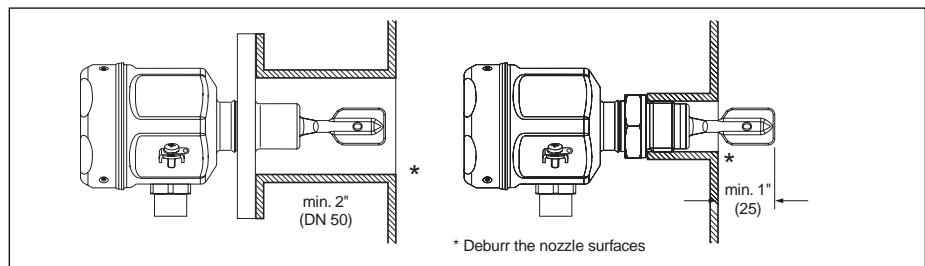

### Mounting, vessel wall build-up

When there is build-up on the vessel wall, mount the Liquiphant M with sufficient distance between the wall and the fork assembly.

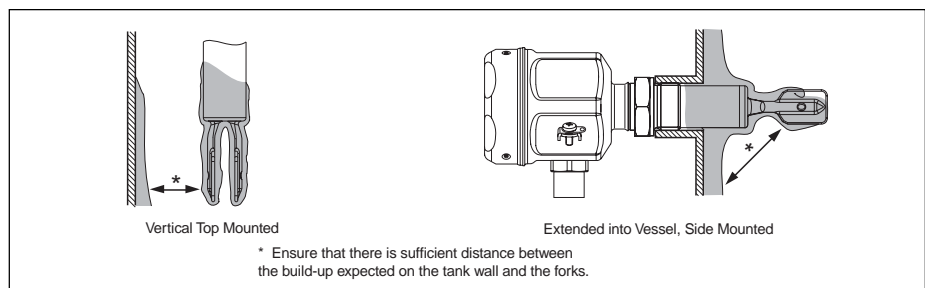

**Pipe Mounting**

The Liquiphant M can be mounted into pipe lines 2" and larger nominal diameters. Installation into a 1" pipe line is possible using a 1" tee (1" x 3/4" reducer fitting).

**N T** Ensure narrow edge of forks is parallel with pipe walls to avoid blockage of the flowing material.

To maintain optimum performance, the liquid should have flow velocities up to 16 ft/s (5 m/s) with a viscosity of 1 cP and a density of 1 SGU.

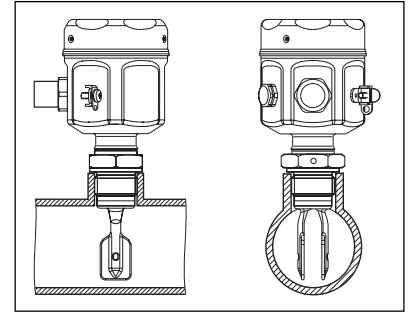

Empty pipe detection

**Flush Tank Mounting**

The Liquiphant M can be flush mounted for high or low level indication using the weld adapter (part number 52001047) and the EE2 connector option (from standard order code for the 50/51 H)

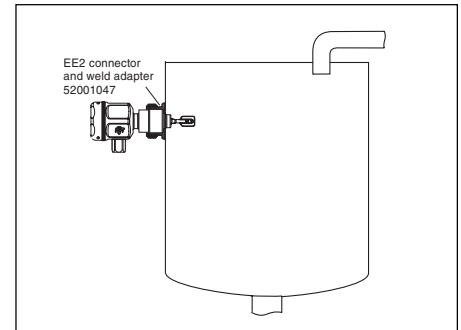

**Mounting Position with Extension Tubes**

Ensure there is adequate space between outside walls or ceilings and the vessel mounting point if ordering the Liquiphant M with an extension tube.

The FTL 51 and FTL 51 H with short extensions (up to 20 inches) can be mounted at any orientation. The Liquiphant M FTL 51 and FTL 51 H with an extension tube over 20 inches (up to 115") must be mounted vertically.

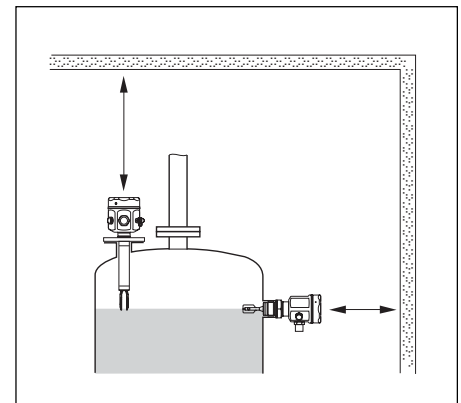

**Extension Tubes**

The sensor length "L" for the FTL 51 and FTL 51 H is dependent on the process connection.

**N T** The switchpoints of the Liquiphant M are at different positions compared to the previous versions of Liquiphant II. A standard extended version of the Liquiphant M (FTL 51 and FTL 51 H) with 1" NPT connection can be ordered with the same switchpoint as the compact versions for Liquiphant II (FTL 360, FTL 365, FDL 30 and FDL 35). This special extended length (order code for Length L - DB, DE or DD), provides the same switchpoint when mounted vertical, as the Liquiphant II.  
L = 4.7" (118 mm)

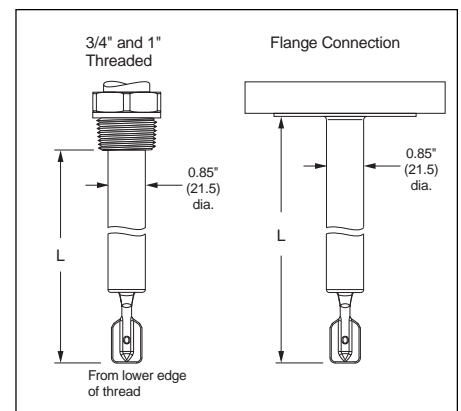

All other extended versions:  
L = 6" to 115", specified in increments of 0.1".

**Temperature spacer / pressure tight feed through****Temperature spacer**

Temperature spacer provides sealed insulation of the vessel and normal ambient temperatures for the housing by extending the electronics (5.5") from the process connection.

**Pressure tight feed through**

Second line of defense protects the electronics housing from vessel pressures up to 580 psi (40 bar) should the sensor become damaged. The feed through also provides sealed insulation of the vessel and normal ambient temperatures for the electronics housing.

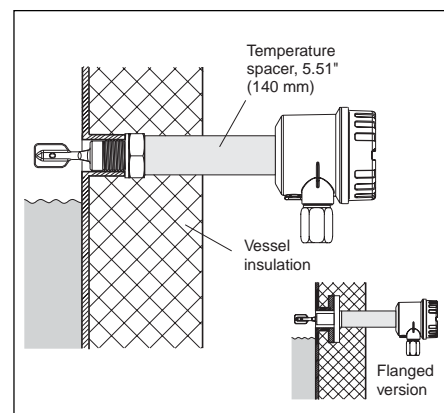
**Operating conditions (environment)****Ambient conditions**

Permissible ambient temperature  $T_1$  at the housing is dependent on the product temperature  $T_2$  inside the vessel.

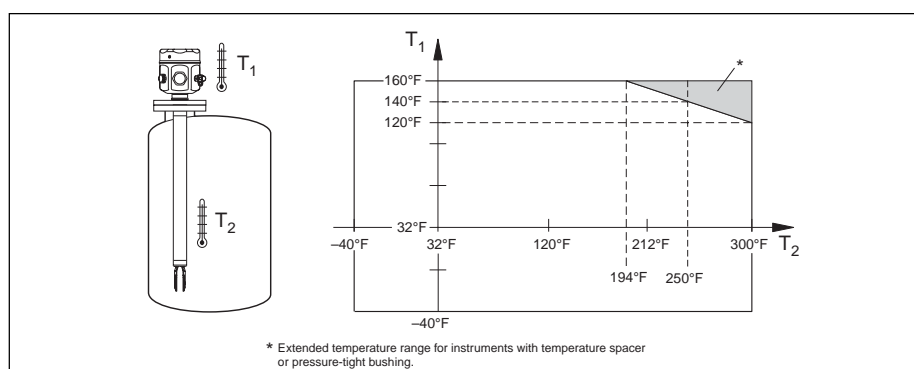
**Ambient temperature Limits**

-60° to +160°F (-50° to +70°C)

Storage Temperature: -60° to +180°F (-50° to +80°C)

**Climatic class**

Climatic protection to IEC 68, Part 2-38, Fig. 2a

**Vibration resistance**

IEC 68, Part 2-6 (10 to 55 Hz, 0.15 mm, 100 cycles)

**Electromagnetic compatibility**

Interference immunity; EN 61326-1 (industrial use) EN 50082-2 (1995)

Interference emission; EN 61326-1, EN 50081-1

**Process Temperature Range**

-40° to + 300°F (-40° to +150°C), for exceptions, refer to process connections.

**Product Pressure Range**

-14.5 psig to 930 psig (-1bar gage to 64 bar gage)

**Product State**

Liquid

**Density**

Minimum 0.5 SGU

**Viscosity**

Maximum 10,000 cP

**Bulk Solids Content**

Maximum 0.2" diameter (5 mm dia.)

**Thermal Shock**

Maximum 250°F/s (120°C/s)

**Process Pressure Limits**

Burst pressure of diaphragm 2900 psi (200 bar)

## Certificates and approvals

### General Certificates

For Liquiphant M FTL 50 H, FTL 51 H; EHEDG certification (from TNO, Netherlands), Report No. V99.394  
 3-A Certificate (USA), Authorization No. 459

### CE Mark

By attaching the CE Mark, Endress+Hauser confirms that the instrument fulfills all the requirements of the relevant EC directives.

### Approvals

Based on various certificates, permissible combinations of housings and electronic inserts are given in the following table. Please consult factory for other approvals.

Electronic Insert	Housing	Approval
FEL 55, 56, 57, 58	Plastic, SS, Aluminum (with NPT entry)	FM approved IS, Class I, II, III; Div. 1, Grp. A-G FM approved DIP Class II, III; Div. 1, Grp. E-G
FEL 51, 52, 54 55, 56, 57, 58	Plastic, SS, Aluminum (with NPT entry) (except for FEL 54 with E4 housing)	FM approved NI, Class I, Div. 2, Grp. A-D FM approved S, Class II, III; Div. 2, Grp. F-G
FEL 51, 52, 54 55, 56, 57, 58	Aluminum only (with NPT entry)	FM approved XP Class I, II, III; Div. 1, Grp. A-D FM approved DIP Class II, III; Div. 1, Grp. E-G
FEL 55, 56, 57, 58	SS, Aluminum (with NPT entry)	CSA approved IS, Class I, Grp. A-D; Cl. II, Grp. E-G; Cl. III
FEL 51, 52, 54 55, 56, 57, 58	Aluminum (with NPT entry)	CSA approved XP, Class I, Grp. A-D; Cl. II, Grp. E-G; Cl. III CSA approved NI, Class 1, Div. 2, Grp. A-D; Cl. II, Div. 2, Grp. E-G; Cl. III

## Dimensions and mounting details

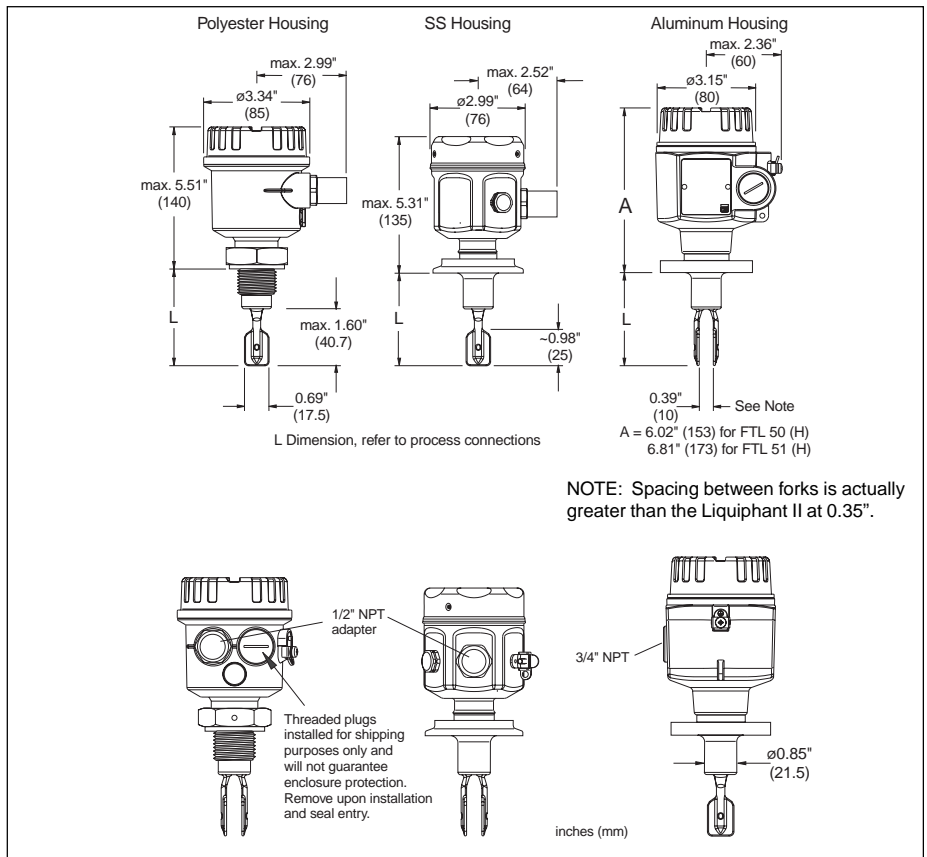

## Ordering Information

### FTL 50 compact version

	Basic Weight													
Liquiphant M, Compact <div style="display: inline-block; vertical-align: middle; margin-left: 20px;">             FTL 50 -              <table style="display: inline-table; border-collapse: collapse;"> <tr> <td style="border: 1px solid black; width: 15px; height: 15px; text-align: center;">1</td> <td style="border: 1px solid black; width: 15px; height: 15px; text-align: center;">2</td> <td style="border: 1px solid black; width: 15px; height: 15px; text-align: center;">3</td> <td style="border: 1px solid black; width: 15px; height: 15px; text-align: center;">4</td> <td style="border: 1px solid black; width: 15px; height: 15px; text-align: center;">5</td> <td style="border: 1px solid black; width: 15px; height: 15px; text-align: center;">6</td> </tr> <tr> <td style="border: 1px solid black; width: 15px; height: 15px;"></td> <td style="border: 1px solid black; width: 15px; height: 15px;"></td> <td style="border: 1px solid black; width: 15px; height: 15px;"></td> <td style="border: 1px solid black; width: 15px; height: 15px;"></td> <td style="border: 1px solid black; width: 15px; height: 15px;"></td> <td style="border: 1px solid black; width: 15px; height: 15px;"></td> </tr> </table> </div>	1	2	3	4	5	6							1.3 lb (0.6 kg)	
1	2	3	4	5	6									
<b>1 Certificate</b>														
A	General purpose, without any special certificates													
P	FM approved, IS, CL I, II, III; Div. 1, Grp. A-G (inserts 55, 56, 57, 58 only) FM approved DIP, CL II, III; Div. 1, Grp. E-G													
Q	FM approved, XP, CL I, II, III; Div. 1, Grp. A-D (Aluminum housing only) FM approved DIP, CL II, III; Div. 1, Grp. E-G													
R	FM approved, NI, CL I, Div. 2, Grp. A-D FM approved, special protection, CI II, III, Div. 2, Grp. F-G													
U	CSA, general purpose													
S	CSA IS, CL. I, Grp. A-D; Class II, Grp. E-G; CL III (inserts 55, 56, 57, 58 only)													
T	CSA XP, CL. I, Grp. A-D; Class II, Grp. E-G, CL III NI, CL. I, Div. 2, Grp. A-D; Class II, Div. 2, Grp. E-G; CL. III (Aluminum housing only)													
<b>2 Process Connection / Material</b>														
GM2	3/4" NPT threaded connection / 316L SS													
GM5	3/4" NPT threaded connection / Alloy C 4													
GW2	G1 BSP, 316L SS mounting for weld-in adapter													
GN2	1" NPT threaded connection / 316L SS	0.4 lb (0.2 kg)												
GN5	1" NPT threaded connection / Alloy C 4	0.4 lb (0.2 kg)												
A82	1" Class 150 ANSI flange, RF / 316L SS	2.2 lb (1.0 kg)												
AA2	1-1/4" Class 150 ANSI flange, RF / 316L SS	2.6 lb (1.2 kg)												
AC2	1-1/2" Class 150 ANSI flange, RF / 316L SS	3.3 lb (1.5 kg)												
AE2	2" Class 150 ANSI flange, RF / 316L SS	5.3 lb (2.4 kg)												
AE5	2" Class 150 ANSI flange, RF / 316L SS with Alloy C 4 plating	5.3 lb (2.4 kg)												
AL2	3" Class 150 ANSI flange, RF / 316L SS	10.8 lb (4.9 kg)												
AP2	4" Class 150 ANSI flange, RF / 316L SS	15.4 lb (7.0 kg)												
TC2	1-1/2" Tri-clamp® / 316L SS													
TE2	2" Tri-clamp® / 316L SS	0.2 lb (0.1 kg)												
<b>3 Length, temperature separator, 2nd line of defense</b>														
AA	Compact unit, 2.6" (66 mm)													
IA	2.6" plus temperature separator (5.5")	1.3 lb (0.6 kg)												
QA	2.6" plus 2nd line of defense (5.5")	1.5 lb (0.7 kg)												
<b>4 Electronic Insert</b>														
1	FEL 51, two-wire AC, 19 to 253 VAC													
2	FEL 52, three-wire DC, 10 to 55 VDC, PNP transistor output													
4	FEL 54, universal AC and DC, 19 to 253 VAC or 19 to 55 VDC, with DPDT relay													
5	FEL 55, two-wire DC, 11 to 36 VDC, 8 / 16 mA output, I.S.													
6	FEL 56, two-wire according to NAMUR (EN 500227), I.S.													
7	FEL 57, PFM signal transmission on two-wire cable, I.S.													
8	FEL 58, two-wire according to NAMUR (EN 50227), I.S. with test push button													
<b>5 Housing / Cable entry</b>														
E4	Polyester housing, NEMA 4X, 1/2" NPT conduit adapter													
E5	Aluminum housing, NEMA 4X, 3/4" NPT	0.8 lb (0.4 kg)												
E6	304 SS housing, NEMA 4X, 1/2" NPT conduit adapter	0.2 lb (0.1 kg)												
<b>6 Additional options</b>														
A	Additional options not selected													
C	3.1.B material certificate													



## FTL 51 extended version

		Basic Weight
Liquiphant M, Extended	FTL 51 - <input type="checkbox"/> <input type="checkbox"/> <input type="checkbox"/> <input type="checkbox"/> <input type="checkbox"/> <input type="checkbox"/>	1.3 lb (0.6 kg)
<b>1 Certificate</b>		
A	General purpose, without any special certificates	
P	FM approved, IS, CL I, II, III; Div. 1, Grp. A-G (inserts 55, 56, 57, 58 only) FM approved DIP, CL II, III; Div. 1, Grp. E-G	
Q	FM approved, XP, CL I, II, III; Div. 1, Grp. A-D (Aluminum housing only) FM approved DIP, CL II, III; Div. 1, Grp. E-G	
R	FM approved, NI, CL I, Div. 2, Grp. A-D FM approved, special protection, CI II, III, Div. 2, Grp F-G	
U	CSA, general purpose	
S	CSA IS, CL. I, Grp. A-D; Class II, Grp. E-G; CL III (inserts 55, 56, 57, 58 only)	
T	CSA XP, CL. I, Grp. A-D; Class II, Grp. E-G, CL III NI, CL. I, Div. 2, Grp. A-D; Class II, Div. 2, Grp. E-G; CL. III (Aluminum housing only)	
<b>2 Process Connection / Material</b>		<b>Additional Weight</b>
GM2	3/4" NPT threaded connection / 316L SS	
GM5	3/4" NPT threaded connection / Alloy C 4	
GN2	1" NPT threaded connection / 316L SS	0.4 lb (0.2 kg)
GN5	1" NPT threaded connection / Alloy C 4	0.4 lb (0.2 kg)
A82	1" Class 150 ANSI flange, RF / 316L SS	2.2 lb (1.0 kg)
AA2	1-1/4" Class 150 ANSI flange, RF / 316L SS	2.6 lb (1.2 kg)
AB2	1-1/4" Class 300 ANSI flange, RF / 316L SS (FTL 51 only)	4.4 lb (2.0 kg)
AC2	1-1/2" Class 150 ANSI flange, RF / 316L SS	3.3 lb (1.5 kg)
AD2	1-1/2" Class 300 ANSI flange, RF / 316L SS (FTL 51 only)	5.9 lb (2.7 kg)
AE2	2" Class 150 ANSI flange, RF / 316L SS	5.3 lb (2.4 kg)
AE5	2" Class 150 ANSI flange, RF / 316L SS with Alloy C 4 plating	5.3 lb (2.4 kg)
AF2	2" Class 300 ANSI flange, RF / 316 L SS (FTL 51 only)	7.0 lb (3.2 kg)
AG2	2" Class 600 ANSI flange, RF / 316L SS (FTL 51 only)	9.2 lb (4.2 kg)
AJ2	2-1/2" Class 300 ANSI flange, RF / 316L SS (FTL 51 only)	10.5 lb (4.8 kg)
AL2	3" Class 150 ANSI flange, RF / 316L SS	10.8 lb (4.9 kg)
AM2	3" Class 300 ANSI flange, RF / 316L SS (FTL 51 only)	14.9 lb (6.8 kg)
AP2	4" Class 150 ANSI flange, RF / 316L SS	15.4 lb (7.0 kg)
AQ2	4" Class 300 ANSI flange, RF / 316L SS (FTL 51 only)	25.3 lb (11.5 kg)
AR2	4" Class 600 ANSI flange, RF / 316L SS (FTL 51 only)	38.1 lb (17.3 kg)
TC2	1-1/2" Tri-clamp® / 316L SS	
TE2	2" Tri-clamp® / 316L SS	0.2 lb (0.1 kg)
<b>3 Length "L", temperature spacer, 2nd line of defense</b>		
Specify extension lengths in inches		
CB	Length in inches (6" to 115"), 316L SS	5 lb / 100"
CE	Length in inches (6" to 115"), Alloy C 4	5 lb / 100"
DB	Length type II, 4.7" (118 mm), 316L SS *	0.2 lb (0.1 kg)
DE	Length type II, 4.7" (118 mm), Alloy C 4 *	0.2 lb (0.1 kg)
KB	Temperature separator, 316L SS, length in inches (6" to 115")	5 lb / 100" (2.3 kg/100")
KE	Temperature separator, Alloy C 4, length in inches (6" to 115")	5 lb / 100" (2.3 kg/100")
LB	Length type II, temperature separator, 316L SS *	0.2 lb (0.1 kg)
LE	Length type II, Alloy C4, temperature separator *	0.2 lb (0.1 kg)
SB	2nd line of defense, length in inches (6" to 115"), 316L SS	5 lb / 100" (2.3 kg/100")
SE	2nd line of defense, length in inches (6" to 115"), Alloy C 4	5 lb / 100" (2.3 kg/100")
TB	2nd line of defense, length type II, 316L SS *	0.2 lb (0.1 kg)
TE	2nd line of defense, length type II, Alloy C 4 *	0.2 lb (0.1 kg)
* Length type II, for replacing Liquiphant II (FTL 360, FTL 365, FDL 30 or FDL35)		
When replacing Liquiphant II with a Liquiphant M FTL 51, the switchpoint is the same when mounted vertically.		
<b>4 Electronic Insert</b>		
1	FEL 51, two-wire AC, 19 to 253 VAC	
2	FEL 52, three-wire DC, 10 to 55 VDC, PNP transistor output	
4	FEL 54, universal AC and DC, 19 to 253 VAC or 19 to 55 VDC, with DPDT relay	
5	FEL 55, two-wire DC, 11 to 36 VDC, 8 / 16 mA output, I.S.	
6	FEL 56, two-wire according to NAMUR (EN 500227), I.S.	
7	FEL 57, PFM signal transmission on two-wire cable, I.S.	
8	FEL 58, two-wire according to NAMUR (EN 500227), I.S. with test push button	
<b>5 Housing / Cable entry</b>		
E4	Polyester housing, NEMA 4X, 1/2" NPT conduit adapter	
E5	Aluminum housing, NEMA 4X, 3/4" NPT	0.8 lb (0.4 kg)
E6	304 SS housing, NEMA 4X, 1/2" NPT conduit adapter	0.2 lb (0.1 kg)
<b>6 Additional options</b>		
A	Additional options not selected	
C	3.1.B material certificate	

**FTL 50 H compact version**

Liquiphant M, Compact	FTL 50 H -	1	2	3	4	5	6	Basic Weight
		<input type="checkbox"/>	<input type="checkbox"/>	<input type="checkbox"/>	<input type="checkbox"/>	<input type="checkbox"/>	<input type="checkbox"/>	1.5 lb (0.7 kg)
1 Certificate								
A	General purpose, without any special certificates							
P	FM approved, IS, CL I, II, III; Div. 1, Grp. A-G (inserts 55, 56, 57, 58 only)							
	FM approved DIP, CL II, III; Div. 1, Grp. E-G							
Q	FM approved, XP, CL I, II, III; Div. 1, Grp. A-D (Aluminum housing only)							
	FM approved DIP, CL II, III; Div. 1, Grp. E-G							
R	FM approved, NI, CL I, Div. 2, Grp. A-D							
	FM approved, special protection, CI II, III, Div. 2, Grp F-G							
U	CSA, general purpose							
S	CSA IS, CL. I, Grp. A-D; Class II, Grp. E-G; CL III (inserts 55, 56, 57 only)							
T	CSA XP, CL. I, Grp. A-D; Class II, Grp. E-G, CL III							
	NI, CL. I, Div. 2, Grp. A-D; Class II, Div. 2, Grp. E-G; CL. III (Aluminum housing only)							
2 Process Connection / Material								
TC2	1-1/2" Tri-clamp® / 316L SS (same size as 1" Tri-clamp)							
TE2	2" Tri-clamp® / 316L SS							
EE2	Flush-mounted for 1" welded adapter / 316L SS							
WE2	Varivent® / 316L SS							
3 Length, temperature separator, 2nd line of defense								
AD	Compact, Ra < 0.5 µm, > 240 grit, 3-A sanitary							
ID	Temperature spacer, Ra < 0.5 µm, > 240 grit, 3-A sanitary							
QD	2nd line of defense, Ra < 0.5 µm, > 240 grit, 3-A sanitary							
4 Electronic Insert								
1	FEL 51, two-wire AC, 19 to 253 VAC							
2	FEL 52, three-wire DC, 10 to 55 VDC, PNP transistor output							
4	FEL 54, universal AC and DC, 19 to 253 VAC or 19 to 55 VDC, with DPDT relay							
5	FEL 55, two-wire DC, 11 to 36 VDC, 8 / 16 mA output, I.S.							
6	FEL 56, two-wire according to NAMUR (EN 500227), I.S.							
7	FEL 57, PFM signal transmission on two-wire cable, I.S.							
8	FEL 58, two-wire according to NAMUR (EN 50227), I.S. with test push button							
5 Housing / Cable entry								
E4	Polyester housing, NEMA 4X, 1/2" NPT conduit adapter							
E5	Aluminum housing, NEMA 4X, 3/4" NPT							
E6	304 SS housing, NEMA 4X, 1/2" NPT conduit adapter							
6 Additional options								
A	Additional options not selected							
C	3.1.B material certificate							
								Additional Weight
								0.2 lb (0.1 kg)
								0.6 lb (0.3 kg)
								1.1 lb (0.5 kg)
								0.8 lb (0.4 kg)
								0.2 lb (0.1 kg)

**FTL 51 H, extended version**

Liquiphant M, Extended	FTL 51 H -	<input type="checkbox"/>	<input type="checkbox"/>	<input type="checkbox"/>	<input type="checkbox"/>	<input type="checkbox"/>	<input type="checkbox"/>	Basic Weight 1.5 lb (0.7 kg)	
<b>1 Certificate</b>									
A	General purpose, without any special certificates								
P	FM approved, IS, CL I, II, III; Div. 1, Grp. A-G (inserts 55, 56, 57, 58 only) FM approved DIP, CL II, III; Div. 1, Grp. E-G								
Q	FM approved, XP, CL I, II, III; Div. 1, Grp. A-D (Aluminum housing only) FM approved DIP, CL II, III; Div. 1, Grp. E-G								
R	FM approved, NI, CL I, Div. 2, Grp. A-D FM approved, special protection, CL II, III, Div. 2, Grp. F-G								
U	CSA, general purpose								
S	CSA IS, CL. I, Grp. A-D; Class II, Grp. E-G; CL III (inserts 55, 56, 57, 58 only)								
T	CSA XP, CL. I, Grp. A-D; Class II, Grp. E-G, CL III NI, CL. I, Div. 2, Grp. A-D; Class II, Div. 2, Grp. E-G; CL. III (Aluminum housing only)								
<b>2 Process Connection / Material</b>									
TC2	1-1/2" Tri-clamp® / 316L SS (same size as 1" Tri-clamp)								
TE2	2" Tri-clamp® / 316L SS								0.2 lb (0.1 kg)
EE2	Flush-mounted for 1" welded adapter / 316L SS								0.6 lb (0.3 kg)
WE2	Varivent® / 316L SS								1.1 lb (0.5 kg)
<b>3 Length "L", temperature spacer, 2nd line of defense</b>									
DD	Specify extension lengths in inches. Material of extension pipe, 316L SS 4.7" (118 mm), Ra < 0.5 µm, > 240 grit, 3-A sanitary *								0.2 lb (0.1 kg)
CD	Length (6" to 115"), Ra < 0.5 µm, > 240 grit, 3-A sanitary								5 lb / 100" (2.3 kg/100")
KD	Temperature spacer, length (6" to 115"), Ra < 0.5 µm, > 240 grit, 3-A sanitary								5 lb / 100" (2.3 kg/100")
LD	Length type II, temperature spacer, Ra < 0.5 µm, > 240 grit, 3-A sanitary *								
SD	2nd line of defense, length in inches (6" to 115"), Ra < 0.5 µm, > 240 grit, 3-A sanitary								5 lb / 100" (2.3 kg/100")
TD	2nd line of defense, Length type II, Ra < 0.5 µm, > 240 grit, 3-A sanitary *								
* Length type II, for replacing Liquiphant II (FTL 360, FTL 365, FDL 30 or FDL35)									
When replacing Liquiphant II with a Liquiphant M FTL 51, the switchpoint is the same when mounted vertically.									
<b>4 Electronic Insert</b>									
1	FEL 51, two-wire AC, 19 to 253 VAC								
2	FEL 52, three-wire DC, 10 to 55 VDC, PNP transistor output								
4	FEL 54, universal AC and DC, 19 to 253 VAC or 19 to 55 VDC, with DPDT relay								
5	FEL 55, two-wire DC, 11 to 36 VDC, 8 / 16 mA output, I.S.								
6	FEL 56, two-wire according to NAMUR (EN 500227), I.S.								
7	FEL 57, PFM signal transmission on two-wire cable, I.S.								
8	FEL 58, two-wire according to NAMUR (EN 500227), I.S. with test push button								
<b>5 Housing / Cable entry</b>									
E4	Polyester housing, NEMA 4X, 1/2" NPT conduit adapter								
E5	Aluminum housing, NEMA 4X, 3/4" NPT								0.8 lb (0.4 kg)
E6	304 SS housing, NEMA 4X, 1/2" NPT conduit adapter								0.2 lb (0.1 kg)
<b>6 Additional options</b>									
A	Additional options not selected								
C	3.1.B material certificate								

**Supplemental documentation**

<input type="checkbox"/>	Isolating amplifier FTL 325 P Technical Information 1 or 3 channel switching units for Top Hat Rail mounting for Liquiphant M with electronic insert FEL 57	TI 350F/24/ae
<input type="checkbox"/>	Isolating amplifier FTL 325 N Technical Information 1 or 3 channel switching units for Top Hat Rail mounting for Liquiphant M with electronic insert FEL 56, FEL 58	TI 353F/24/ae
<input type="checkbox"/>	Nivotester FTL 375 P racksyst plug-in card Technical Information; 1, 2 or 3 channel switching unit for Liquiphant M / S with electronic insert FEL 57	TI 360F/00/en
<input type="checkbox"/>	Nivotester FTL 375 N racksyst plug-in card Technical Information; 1, 2 or 3 channel switching unit for connection to Liquiphant M / S with electronic insert FEL 56, FEL 58	TI 361F/00/en
<input type="checkbox"/>	Liquiphant M 51C measuring sensor for level limit detection with corrosion-resistant coating for corrosive liquids	TI 347F/24/ae
<input type="checkbox"/>	Liquiphant S FTL 70/71 measuring sensor for level detection in high temperature liquids up to 536°F (280°C)	TI 354F/24/ae
<input type="checkbox"/>	Liquiphant M 50 / 51 Operating Instructions	KA 143F/00/a6
<input type="checkbox"/>	Liquiphant M 50 H / 51 H Operating Instructions	KA 144F/00/a6

# Accessories

## Welded Adapter

For flush-mounting a Liquiphant M  
FTL 50 H with process connection code  
EE2. Sensor can be positioned.  
Material: 316L SS  
Silicone seal is on Liquiphant  
Weight: 0.3 lb (0.15 kg)  
Order number: 52001047

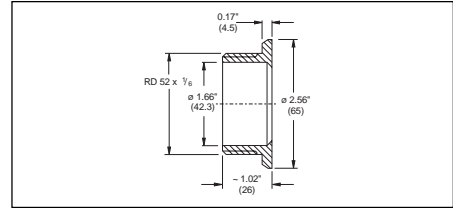

## Transparent Cover

For polyester housing  
Material: PA 12 (clear polyester)  
Weight: 0.09 lb (0.04 kg)  
Order number: 943461-0001

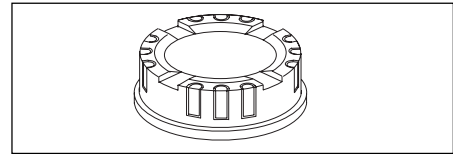

## Cover with Viewing Window

For stainless steel housing  
Cover Material: 304 SS  
Window Material: Glass  
Weight: 0.3 lb (0.16 kg)  
Order number: 943301-1000  
Cover with polycarbonate window  
Order number: 52001403

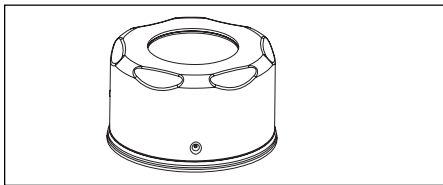

**N T** FM approvals no longer apply  
when using accessory covers.

## Sliding Sleeves

For unpressurized operation (0 psi;  
maximum temperature, 300°F)  
Material: 316L SS  
1" NPT, order number: 52003979  
1-1/2" NPT, order number: 52003981

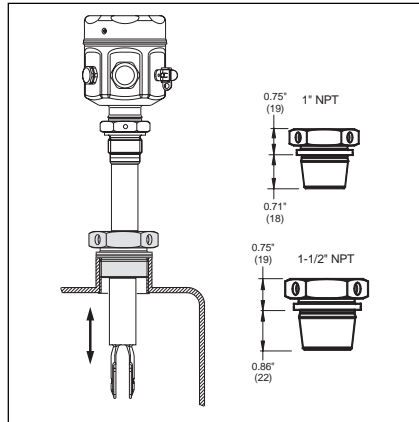

Sliding sleeve, no pressure

For high pressure (maximum 580 psi;  
maximum temperature, 300°F)

Material: 316L SS or alloy C4  
1" NPT, 316L SS, order number: 52003667  
1" NPT, alloy C4, order number: 52003668  
1-1/2" NPT, 316L SS, order number: 52003669  
1-1/2" NPT, alloy C4, order number: 52003670

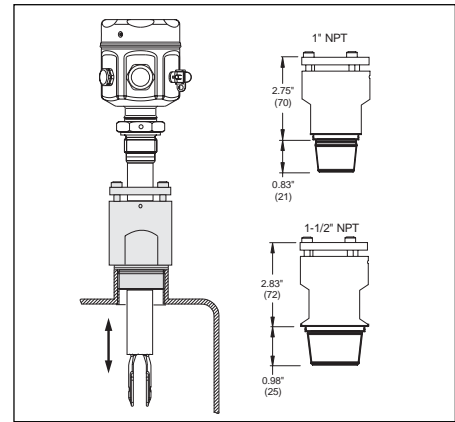

Sliding sleeve, high pressure

For application and selection assistance,  
in the U.S. call 888-ENDRESS

For total support of your installed base, 24 hours  
a day, in the U.S. call 800-642-8737

Visit us on our web site, [www.us.endress.com](http://www.us.endress.com)

### United States

Endress+Hauser, Inc.  
2350 Endress Place  
Greenwood, IN 46143  
Phone: (317) 535-7138  
888-ENDRESS  
FAX: (317) 535-8498

### Canada

Endress+Hauser  
Canada Ltd.  
1440 Graham's Lane  
Unit 1, Burlington  
ON, L7S 1W3  
Mexico  
Phone: (905) 681-9292  
800-668-3199  
FAX: (905) 681-9444

### Mexico

Endress+Hauser  
Paseo del Pedregal No. 610  
Col. Jardines del Pedregal  
01900, Mexico D.F.  
Mexico  
Phone: (525) 568-2405  
FAX: (525) 568-7459

Endress+Hauser  
The Power of Know How

