

IV 251

Signal Converter

SSI → Analogue and SSI → Serial



- Suitable for operation with all sensors and encoders using SSI interface
- Scalable analogue outputs +/- 10 volts, 0-20 mA and 4-20 mA proportional to the sensor signal
- Serial RS232 and RS485 interface for serial readout of the encoder data
- Easy to set up by Teach function or by PC
- Linearisation facilities by freely programmable input-output curves
- Additional facilities as bit-blanking, round-loop-operation etc.
- 18–30 volts DC power supply, auxiliary voltage output 5 V DC for sensor supply

Operating Instructions



Safety Instructions

- This manual is an essential part of the unit and contains important hints about function, correct handling and commissioning. Non-observance can result in damage to the unit or the machine or even in injury to persons using the equipment!
- The unit must only be installed, connected and activated by a qualified electrician
- It is a must to observe all general and also all country-specific and application-specific safety standards
- When this unit is used with applications where failure or maloperation could cause damage to a machine or hazard to the operating staff, it is indispensable to meet effective precautions in order to avoid such consequences
- Regarding installation, wiring, environmental conditions, screening of cables and earthing, you must follow the general standards of industrial automation industry
- - Errors and omissions excepted –

Notice of Compatibility:

The IV251 converter described in this manual is a follow-up model of the obsolete WD251 converter. It provides an extended range of functions with use of a few more parameters, but is otherwise practically 100% compatible to WD251 units for use with **SSI absolute encoders**. For applications using **incremental encoders**, please refer to our converter type **ZU252**.

Version:	Description:
IV25101a/af/kk/hk/Feb.08	Version A5-motrona
IV25102a/kk/nw/Sept. 13	Added Printermode

Table of Contents

1.	Introduction	4
2.	Terminal Assignments and Connections.....	5
2.1.	Encoder connections with Master operation.....	5
2.2.	Encoder connections with Slave operation.....	6
2.3.	Analogue outputs	6
2.4.	Serial interface.....	7
3.	DIL switch settings	8
4.	Commissioning	9
4.1.	Self Test:	9
4.2.	SSI signal test:	9
4.3.	Scaling of the analogue output with use of the Teach function:.....	9
4.4.	The Set Input:	10
5.	Serial Readout of the Actual Encoder Position	11
6.	PC setup using the operator software OS32.....	12
7.	Parameter Settings	13
7.1.	Display Settings:	13
7.2.	General Settings:.....	13
7.3.	SSI Specific Settings:.....	16
7.4.	SSI Error Settings:.....	19
7.5.	Linearisation Settings in %:.....	19
7.6.	Set-up Settings:.....	19
7.7.	Parameters for RS 232 / RS 485 Settings	20
8.	Free Programmable Linearization	23
9.	Testing Functions.....	25
10.	Dimensions and Specifications	26
11.	Parameter-List	27

1. Introduction

IV251 is a small and low-cost, but highly performing converter for industrial applications, where the information of a sensor or encoder with SSI interface needs to be converted to an analogue signal or to a serial RS232/485 data format.

The unit has been designed as a compact module with 12 screw terminals and a 9-position SUB-D connector (female). The housing is suitable for standard DIN rail mounting.

Applicable encoders and sensors:

Single-turn or multi-turn absolute encoders and all similar sensors using a standard SSI interface (6 to 25 bits of resolution with binary or Gray code). The unit can operate in either master mode (clock signal generated by the IV251 unit), or in slave mode (clock signal generated by a remote device)

Remark to the encoder resolution:

The unit provides settings for the standard resolutions of 13 bits, 21 bits and 25 bits. In general, for sensors with other resolutions you can use the next higher setting (i.e. set the unit to 21 bits with a sensor of 16 bits).

Depending on brand and specification of the encoder, in some cases it may be necessary to blank out the surplus bits by using the bit blanking function described later. In general however, the unit should work perfectly also without special bit blanking.

2. Terminal Assignments and Connections

The subsequent diagram shows the assignment of the screw terminals.

We recommend to connect the Minus wire of the power supply to earth potential. GND terminals 4, 6 and 12 are connected internally. Depending on input voltage and load of the auxiliary voltage output, the total power consumption of the unit is about 200 mA.

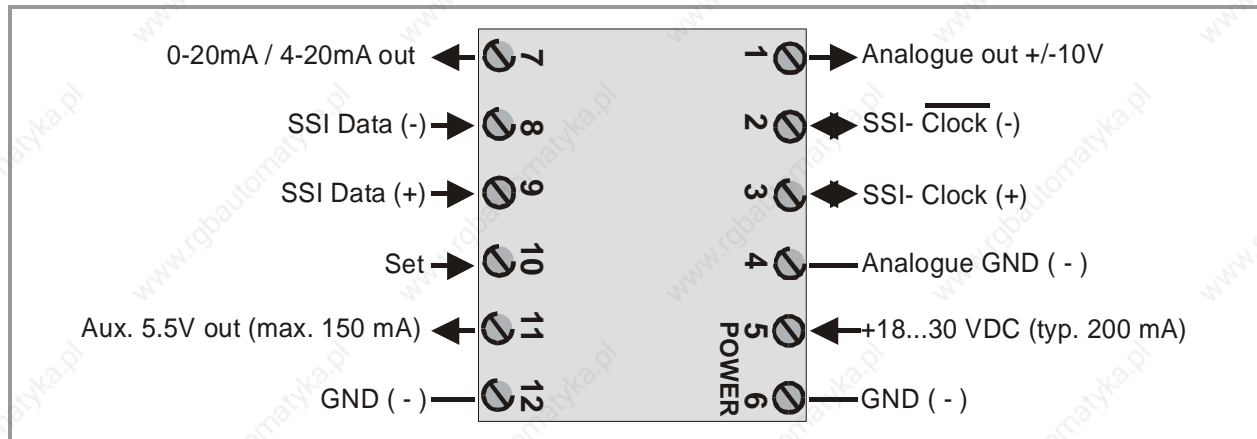

2.1. Encoder connections with Master operation

We recommend to connect the screen to the Minus wire of the encoder supply voltage on both sides.

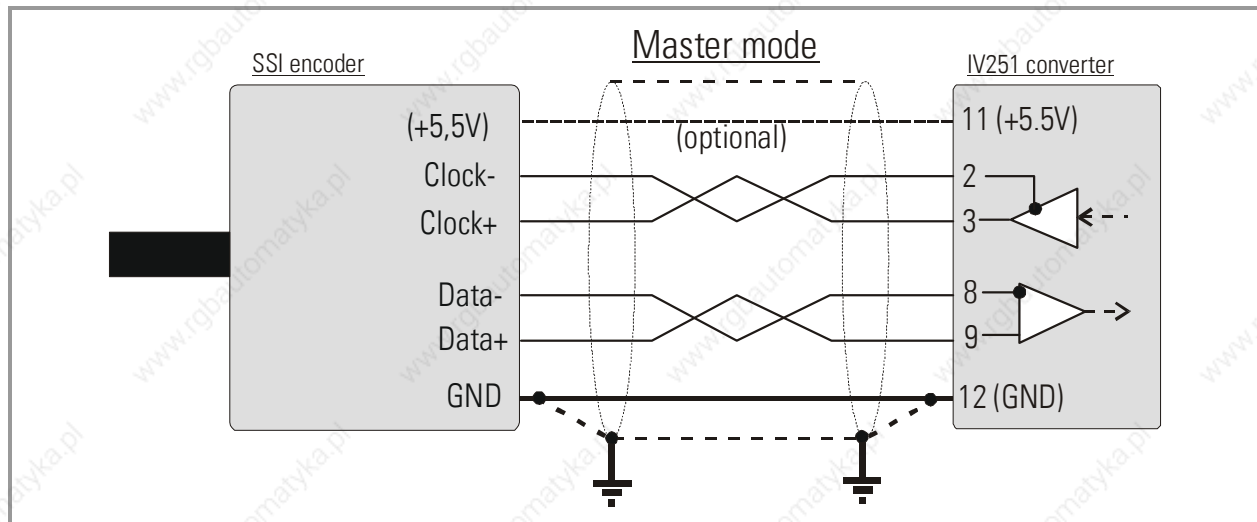

2.2. Encoder connections with Slave operation

With this mode, the IV251 converter operates in parallel to another unit, acting as a „listener“ to the existing data communication.

Quite according to need, the common potential of the master can be connected to terminal 12 (GND), or remain open for fully differential operation.

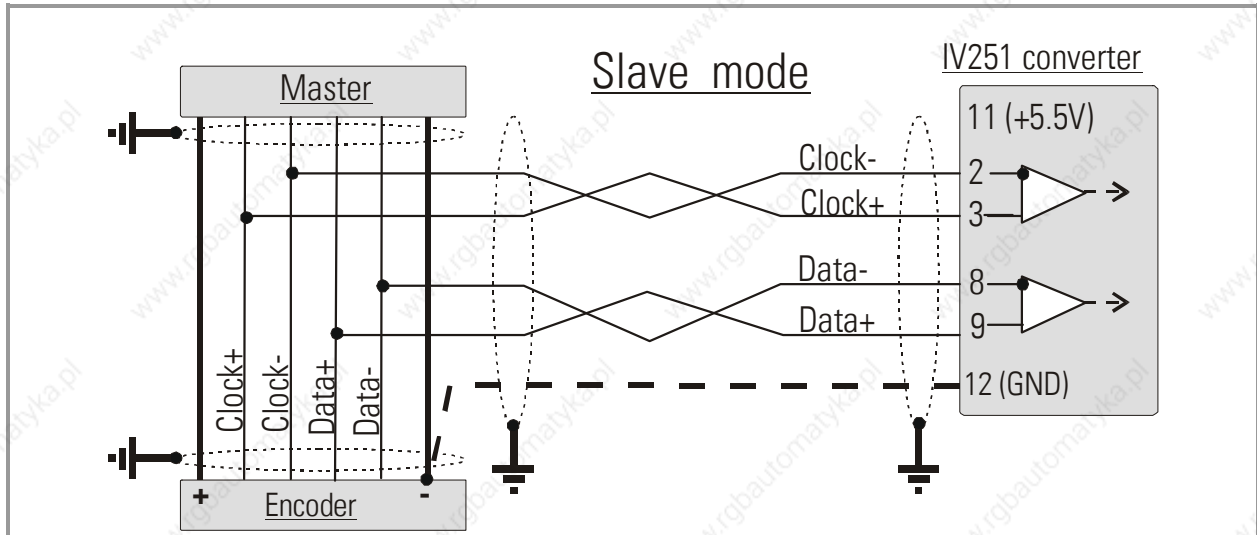

2.3. Analogue outputs

The unit provides one +/-10V voltage output and one 0-20 mA / 4-20 mA current output at a resolution of 14 Bits (i.e. the voltage output operates in steps of 1.25 mV).

The nominal load of the voltage output is 2 mA; the current output accepts loads between 0 and 270 Ohms.

There is a separate analogue ground terminal, which internally is connected to the GND potential of the power supply

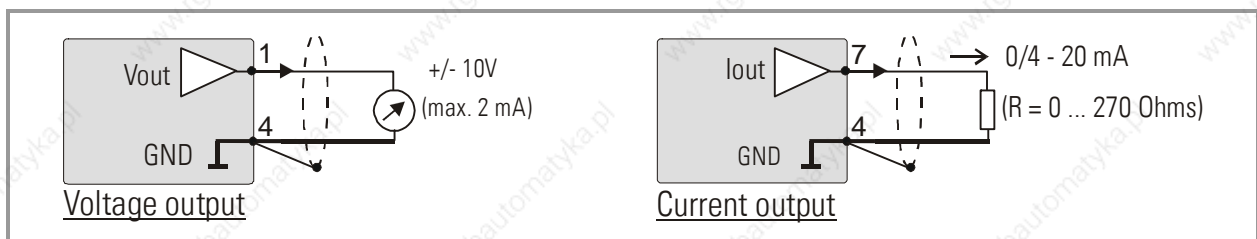

2.4. Serial interface

The unit provides a RS232 interface and a RS485 interface, however only one of the two can be used at a time. Serial communication allows to read out the encoder position and to set parameters and variables by PC, according to need.

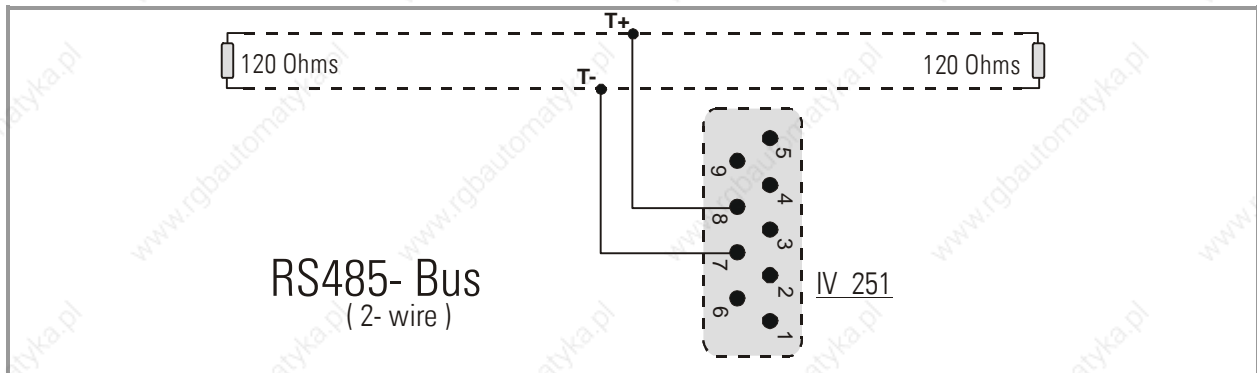
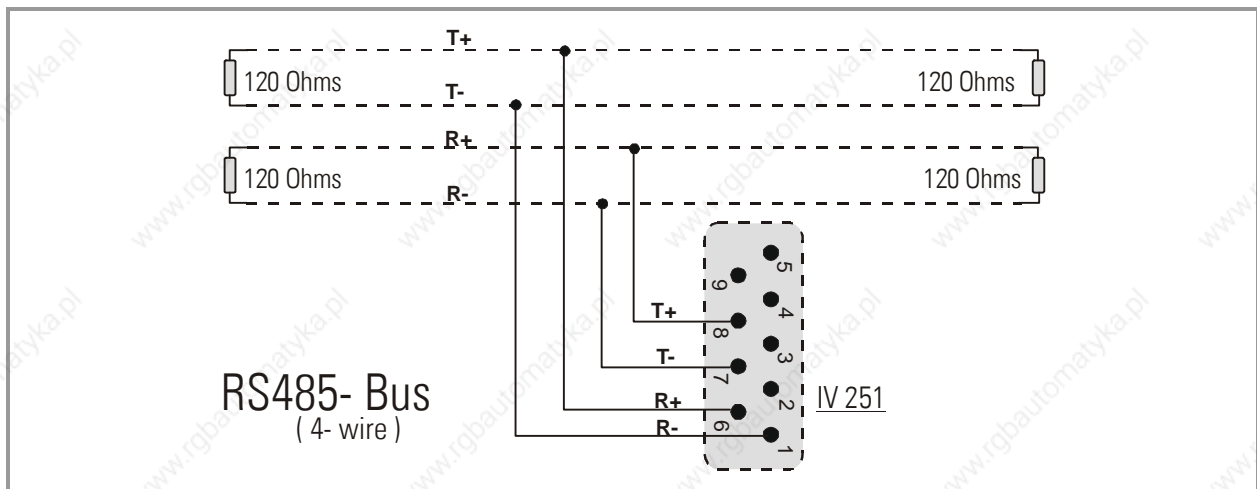
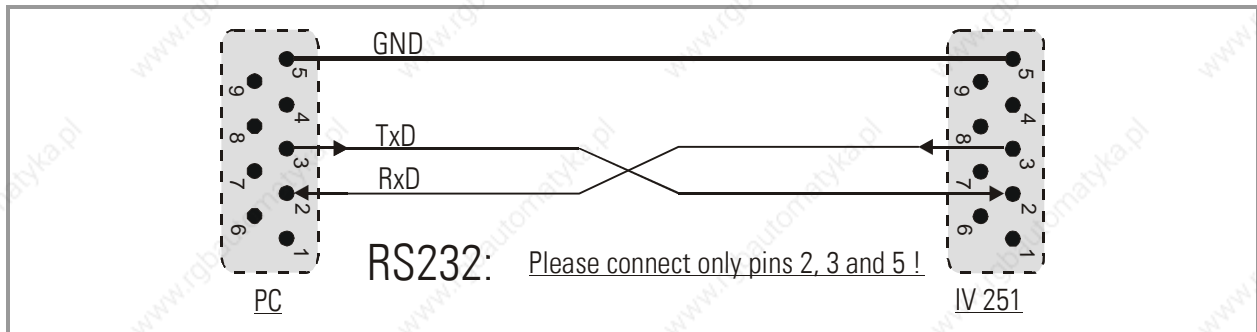
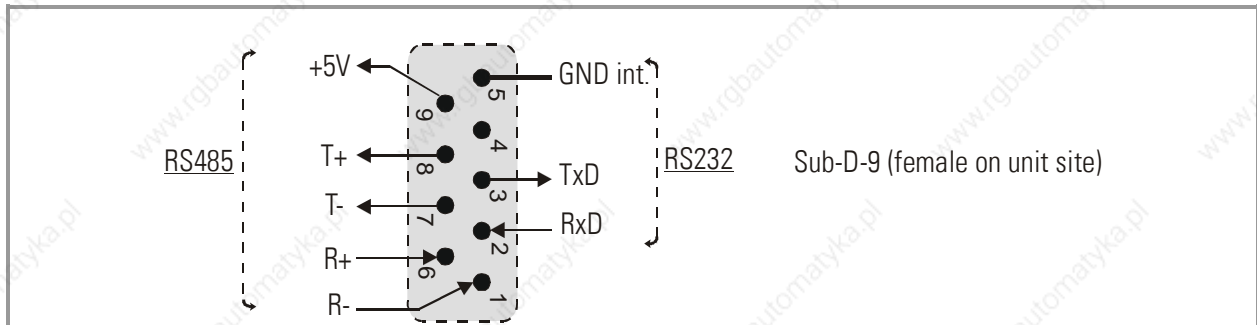

3. DIL switch settings

The DIL switch located on the top site of the unit provides customer-specific settings of desired operation modes.

Position	Setting	OFF	ON
1	Set Default:	Unit loads default settings with every power-up cycle	No loading of default settings upon power-up.
2	Analogue Update Mode	Update of analogue output in a fixed preset time pattern	Update of analogue output after every SSI telegram
3	SSI- Test:	Normal LED operation, Teach function enabled	Verifies correct status of clock and data lines, Teach function disabled
4	SSI Code	Gray Code	Binary Code
5	SSI Resolution:	3 OFF, 4 OFF : not valid 3 ON, 4 OFF : 25 Bit 3 OFF, 4 ON : 21 Bit 3 ON, 4 ON : 13 Bit	
6	SSI Mode:	Slave Mode	Master Mode
7	Serial Port:	RS 232- Format	RS 485- Format
8			

The switch settings shown above are suitable for Master operation of a 25 bit SSI encoder with Gray coded output. The analogue output operates with equidistant update time and the serial link is set to RS232 communication.



- Changes of the switch settings will become active only after the next power-up cycle!
- After setup and commissioning, please set DIL switch position 6 to ON. If set to OFF, any inadvertently touch of the „Teach“ button would overwrite your previous scaling input!

4. Commissioning

With basic applications, you can use the Teach procedure for commissioning of the unit. Extended functions need a PC for setup and are described later.

4.1. Self Test:

Set all DIL switches according to your application and connect encoder and power supply to the unit. Set switch position No. 6 to ON first (test mode) and power the unit up. The green LED (power) and the yellow LED (status) must light both. After a successful self-test, the yellow LED must switch off again (approx. 1 sec.)

4.2. SSI signal test:

Push the Teach button one time now. This will verify the SSI Data lines. The yellow LED must switch on. Where it remains off, you need to cross the input lines "Data+" (9) and "Data-" (8).

The second actuation of the Teach button will test the SSI Clock lines in the same manner.

Again, the LED must be lit, otherwise you need to cross the lines "Clock+" (3) and "Clock-" (2).*)

The third actuation of the Teach button will switch the LED off and conclude the test cycle.

Where you find your status LED lit after the first and the second actuation of the button, your wiring of the encoder is o.k. Please power the unit down and set DIL position 6 to OFF for Teach operation. With use of a PC and the OS32 operator software, you can check the status also from the indicator boxes „Status SSI clock“ and „Status SSI data“ (red = status o.k.)

4.3. Scaling of the analogue output with use of the Teach function:

Power the unit up again, with DIL position 6 set to OFF. Press the Teach button one time.

The status LED will blink in a slow sequence now while the unit waits for the zero position. Move your encoder to where you like zero output and press the button again.

This stores your zero definition and the LED will blink in a fast sequence now while the unit waits for the full scale position. Move your encoder to where you desire full scale output and press the button once more.

This stores your full scale definition and the LED will switch off. Your analogue output is now set to the desired operating range, as selected by the output mode setting.

*) Testing the clock lines is primarily useful with Slave operation. Though the test works also in Master mode, the result says only that the internal generation of the clock works fine. However, with Master mode, this test cannot indicate faulty clock drivers or bad wiring of the clock lines.



- Your full scale position is allowed to be higher or lower than the zero position
- More scaling facilities and linearization functions are available with PC setup
- Teach min" always refers to the initial output value defined by „Output mode“, i.e. 0 volts or 0 mA or 4 mA
- When, after setting of the full scale position, the status LED does not switch off, this indicates an overflow error where the mechanical zero position of your encoder lies between your two teach settings. In this case you need to change the zero position of the encoder (mechanically or by corresponding programming of the encoder). With PC setup, the converter itself provides also an electronic suppression of the overflow jump
- The only way to reset an overflow error state is to cycle the power supply
- The LED overflow check may fail with encoders providing a resolution lower than 13 bits

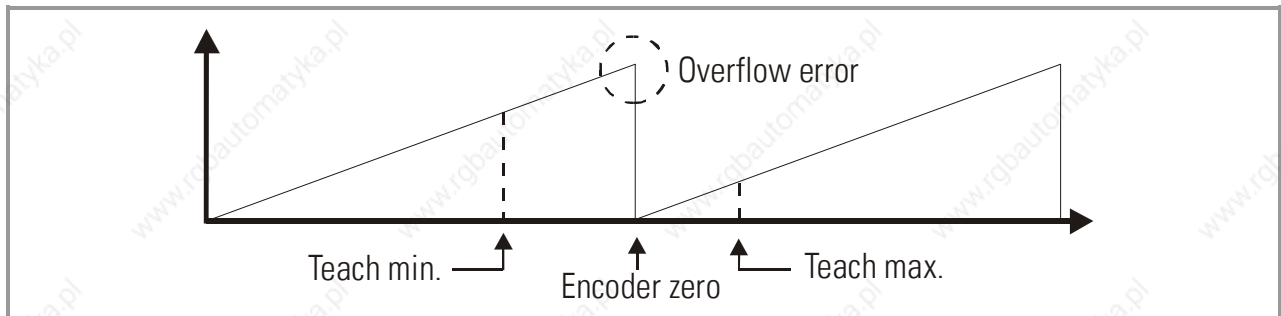

4.4. The Set Input:

With a HIGH signal on the Set input (terminal 10), the unit temporarily substitutes the SSI encoder data by a set value as entered to the "SSI Set Value" register, and the analogue output as well as the serial readout will follow correspondingly. This means, independent of the actual mechanical position of the encoder, the unit internally uses the register data instead of the encoder SSI data. It turns back to normal encoder reading as soon as the Set signal goes LOW again.

This function can be very useful for testing and commissioning purpose.

The Set input uses PNP / HTL characteristics (LOW = open or 0 – 3 V, HIGH = 10 – 30 V)

5. Serial Readout of the Actual Encoder Position

You can read out the actual SSI position of the encoder at any time from the serial link. For setting of communication parameters, a PC is required.

IV251 uses the DRIVECOM communication standard according to ISO 1745.

Details about this protocol can be found in our file [Serpro1a.doc](#) which is available for download on the *motrona* homepage.

The serial access code for the actual encoder position is „ :8 „
(ASCII characters, colon and 8)

6. PC setup using the operator software OS32

You can apply the full set of functions when using a PC and our operator software OS32 for setup of the unit. You can download this software and full instructions, free of charge, from our homepage

www.motrona.de

- Connect your PC to the converter, using a serial RS232 cable like shown in section 2.4 of this manual. Make sure, the cable only connects pins 2, 3 and 5.
- Run the OS3.x software and you will find the following screen:

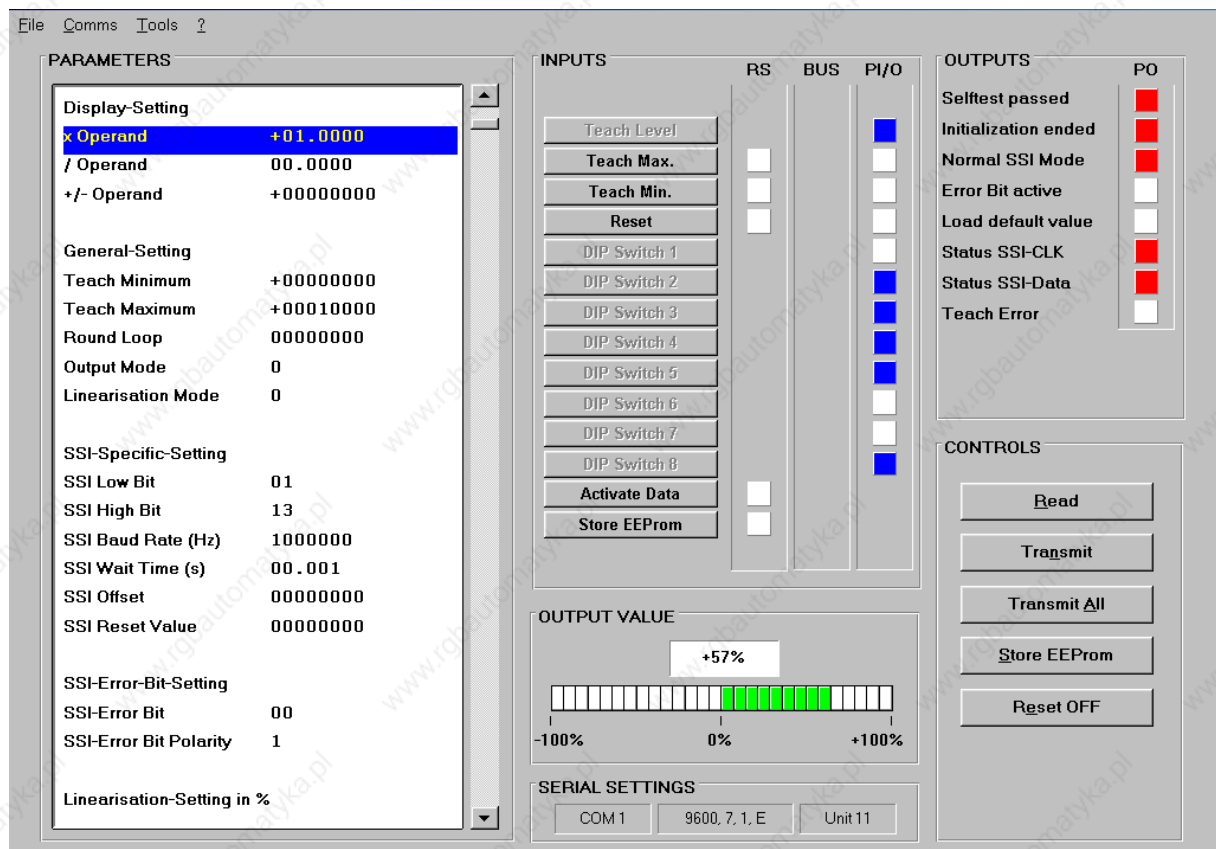

- In case your text and color fields remain empty and the headline says „OFFLINE“, you must verify your serial settings. To do this, select „Comms“ from the menu bar. Ex factory, all *motrona* units use the following serial standard settings:

Unit No. 11, Baud rate 9600, 1 start/ 7 data/ parity even/ 1 stop bit

- If the serial settings of the unit should be unknown, you can run the „SCAN“ function from the „TOOLS“ menu to find out.

7. Parameter Settings

7.1. Display Settings:

X Operand, / Operand, +/-Operand:

These operands serve for conversion of the position information transmitted by the encoder into other engineering units like millimeters or inches etc. This conversion only refers to the numeric readout value by serial link, but does not affect the scaling of the analogue output.

With the settings

$$\begin{array}{l} \underline{x \text{ Operand}} = 1.0000 \\ \underline{/ \text{ Operand}} = 1.0000 \text{ and} \\ \underline{+/- \text{ Operand}} = 0.0000 \end{array}$$

the serial readout value equals to the encoder value.

$$\text{Serial Readout} = \left[\text{SSI encoder data} \times \frac{x\text{Operand}}{/ \text{Operand}} \right] + \underline{+/- \text{Operand}}$$

7.2. General Settings:

Teach Minimum, Teach Maximum:

These two settings define the range of the encoder where the analogue output should move between minimum and maximum output. At any time you can use the Teach button of the unit or the soft keys on the screen to set these registers*), but you are free to enter your settings directly by keyboard, without using the Teach function.

Round Loop:

In general, this setting should be 00000. Any other settings will substitute the real encoder position by a repeating cycle count.

Example: when we set this register to 2048, the internal position register will only move in a range between 0 and 2047. When we underpass zero with reverse direction, again 2047 will appear. When we exceed 2047 with forward direction, we restart at 0 again.

The zero position of the round-loop counter can be set by register "SSI-Offset" which allows settings between 0 and the Round-Loop value. Register "Direction" allows to set the counting direction of the round loop counter (0 = up, 1 = down).

Within this new definition of a round-loop range, you are free to set the zero and full scale thresholds of your analogue output again by means of Teach-Min. and Teach-Max. parameters.

*) Click to Teach-Min (on) and again (off), then click to Teach-Max (on) and again (off).

To activate your Teach results, click to "Activate Data", to read out and see your Teach results on the screen, click the "Read" key.

All settings will be finally stored to the unit after clicking the "Store EEprom" key.

The following drawings explain the coherence between original encoder data, Round-Loop setting, SSI-Offset and Direction register.

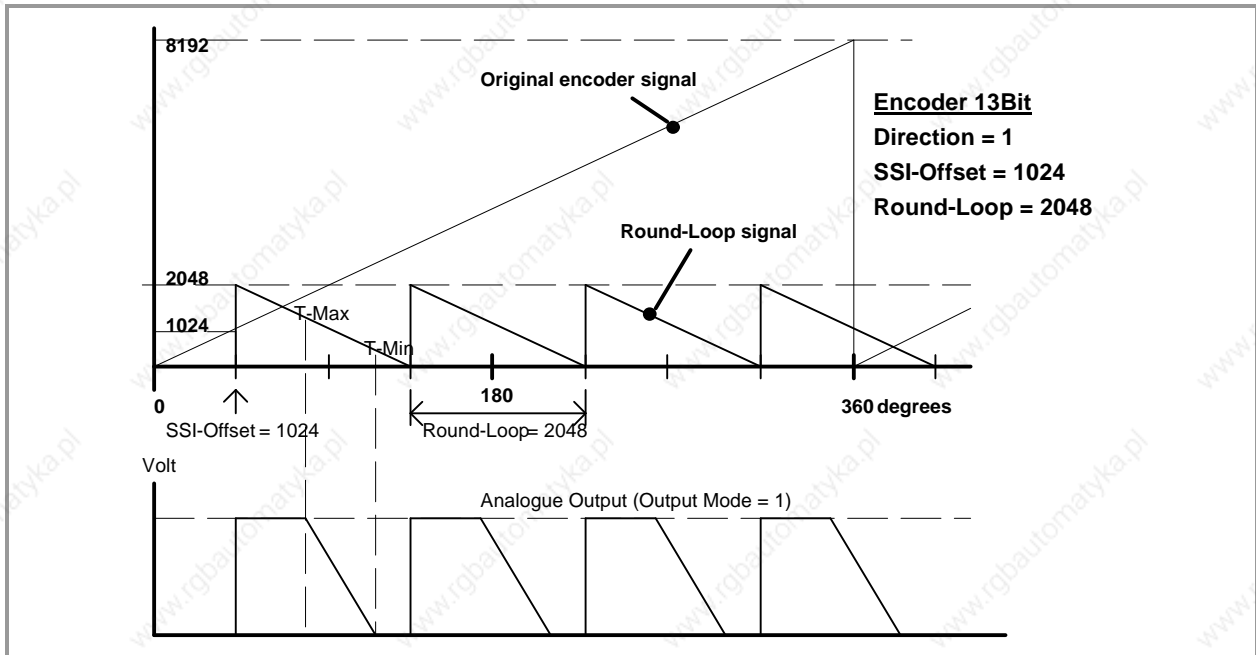
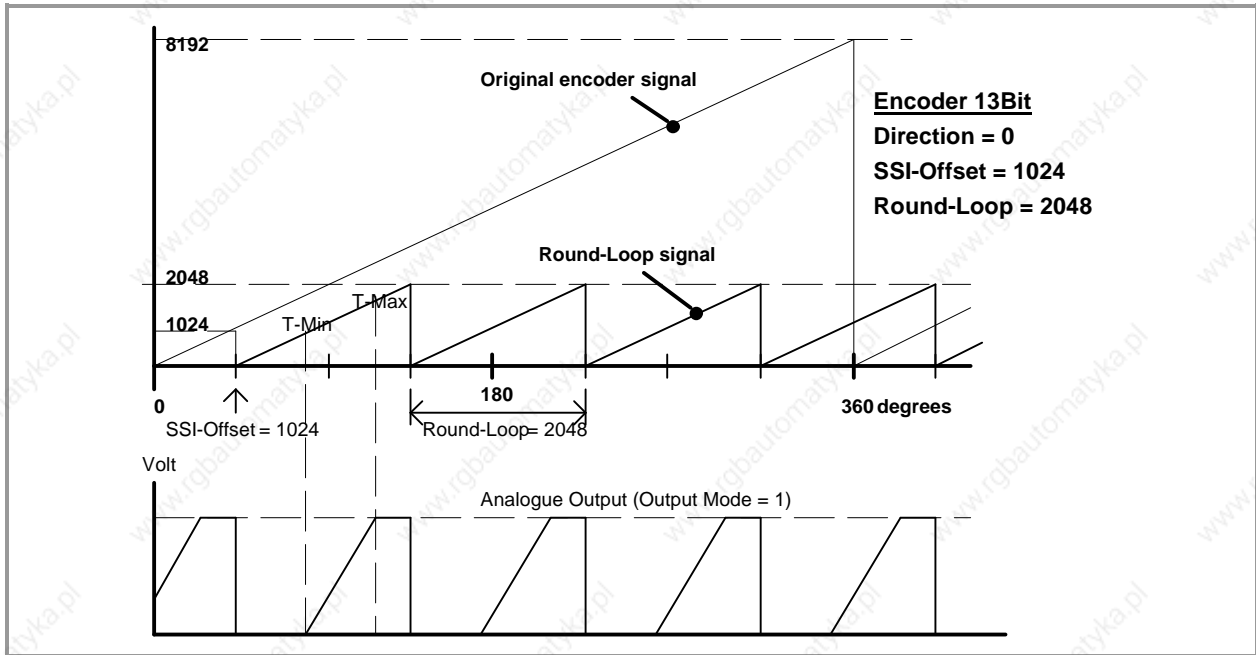

The Round-Loop function is also suitable to suppress the encoder overflow, when the mechanical zero position of your encoder lies between your Teach-Min and Teach-Max values and you do not like to change the mechanical situation. As shown in the subsequent picture, you need to set the Round-Loop register to the full encoder resolution and then shift the zero transition by setting the SSI Offset correspondingly.



- Every change of the Round-Loop setting requires new entry of Teach-Min, Teach-Max and Offset values
- With use of the Round-Loop function it is also possible to change the counting direction of the encoder, by setting the Direction bit correspondingly
- After any action concerning the round-loop and direction settings, new entry of Teach-Min, Teach-Max and Offset becomes necessary.

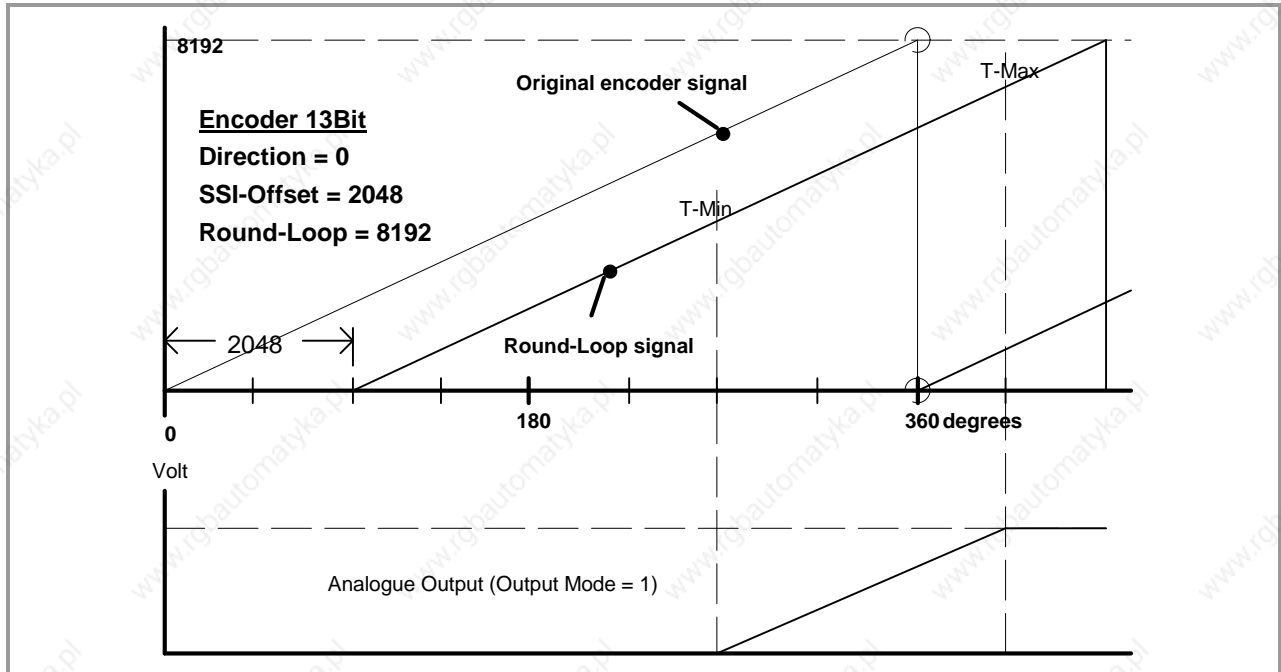

Output Mode:

Selects the output format of the analogue outputs like shown:

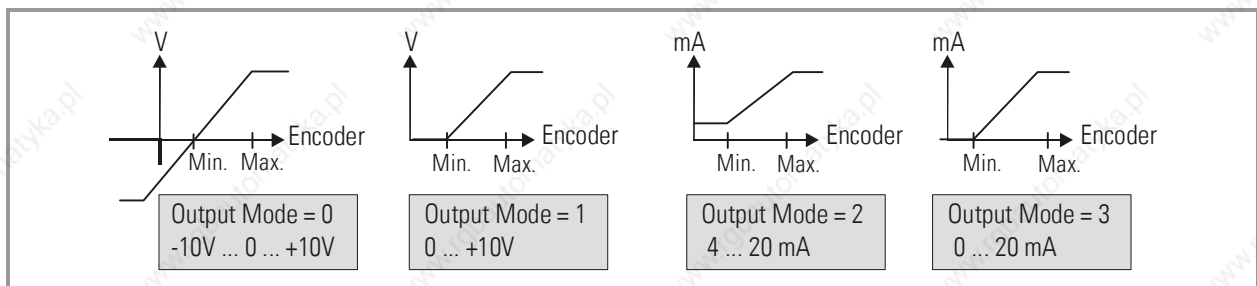

Linearisation Mode:

Sets the mode of linearization

- 0: Linearisation off, registers P1 to P16 do not affect the output characteristics.
 - 1: Linearisation in a range of 0 – 100%
 - 2: Linearisation over full range –100% to +100%
- (See examples under the section „Linearisation“)

7.3. SSI Specific Settings:

SSI Low Bit:

Defines the lowest bit (LSB) for evaluation, when the bit blanking function is used.
Must be set to "01" for evaluation of the full encoder range.

SSI High Bit:

Defines the highest bit (MSB) for evaluation, when the bit blanking function is used.
Must be set to the total number of encoder bits for evaluation of the full encoder range.

The following example uses a 13 bit encoder where High Bit is set to 12 and Low Bit is set to 03, resulting in evaluation of bits 03 to 12 only and blanking out positions 01, 02 and 13.

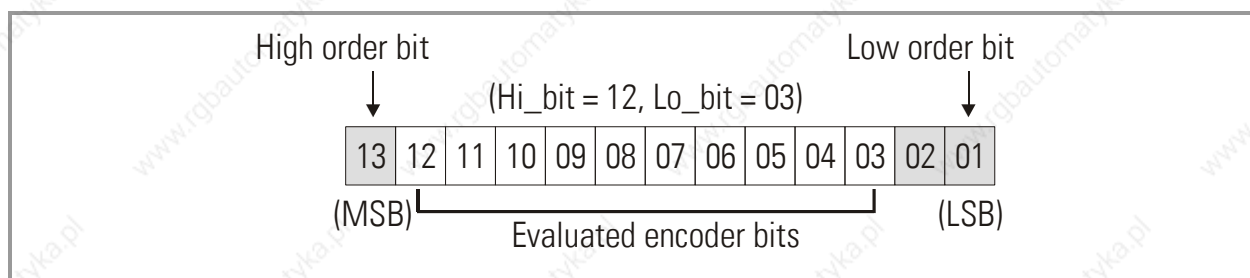

Hint for the use of the bit blanking function:

Bit blanking results in a different evaluation of the encoder information, and you should be fully aware of what happens with the resolution and the number of registered turns when you use this function.

The subsequent example uses a 13-bit single-turn encoder to explain two different results when blanking out one bit:

- Without blanking, a 13 bit encoder would provide a 0 – 8191 information with a 0 - 360° turn of the encoder shaft.
This would assume a setting of "High Bit = 13" and "Low Bit = 01".

It is easy to understand that there are two different ways how to use only 12 of the 13 bits available:

- When we set High Bit to 12 while Low Bit remains 01, we have blanked the high order bit. The result corresponds to an encoder providing information 0 – 4095 while we turn from 0 - 180°, and again the same 0 – 4095 information while we continue from 180° to 360°. The resolution remains unchanged with respect of the number of steps per revolution.
- We can also leave High Bit to 13 and set Low Bit to 02 instead. This means we blank the low order bit now. As a result, within one turn of 0 - 360°, we receive the encoder information 0 – 4095 one time only, but the total number of steps per revolution has been halved.

SSI Baud Rate:

Sets the communication speed of the SSI interface with SSI encoders.

Setting range: 100 Hz to 1MHz.

You are free to set any desired frequency between 0.1 kHz and 1000.0 kHz. For technical reasons however, in the upper frequency range with Master operation, the unit will only generate one of the following frequencies accurately:

1 000,0 kHz	888,0 kHz	800,0 kHz	727,0 kHz	666,0 kHz
615,0 kHz	571,0 kHz	533,0 kHz	500,0 kHz	470,0 kHz
444,0 kHz	421,0 kHz	400,0 kHz	380,0 kHz	363,0 kHz
347,0 kHz	333,0 kHz	320,0 kHz	307,0 kHz	296,0 kHz
285,0 kHz	275,0 kHz	266,0 kHz	258,0 kHz	250,0 kHz

With Master operation, other settings will result in generation of the next upper or lower value according to above list. With all settings < 250.0 kHz the error between set rate and generated rate becomes negligible.

It is mandatory to set the Baud rate also with Slave operation. In this case, however, the setting serves only to determine the pause time for correct synchronization (pause is detected after 4 clock cycles). The unit automatically synchronizes with every remote clock signal within the specified Baud rate range.

SSI Wait Time:

This register sets the waiting time between two SSI telegrams in a range from 0.001 to 99.999 sec. In normal operation, due to processor cycle times, the real time may vary by 512 μ sec. with respect to the preset time: The fastest sequence possible is 1.3 μ sec with a setting of 0.000.

With Slave operation mode, the distance of the SSI protocols depends on the remote Master and the SSI Wait Time specifies the distance of evaluation data strings. Setting to 100 msec results in evaluation of one telegram only every 100 msec, even though the Master may have transmitted many telegrams more.

Especially with applications of closed-loop control loops, it may be of advantage to have equidistant updating of the analogue output (DIL switch 7 = OFF). This is possible with Master mode only, and the Wait Time setting (must be >0) directly corresponds to the time pattern of updates.

The subsequent drawing explains the timing with use of equidistant update mode with a SSI Wait Time setting of 3 msec.

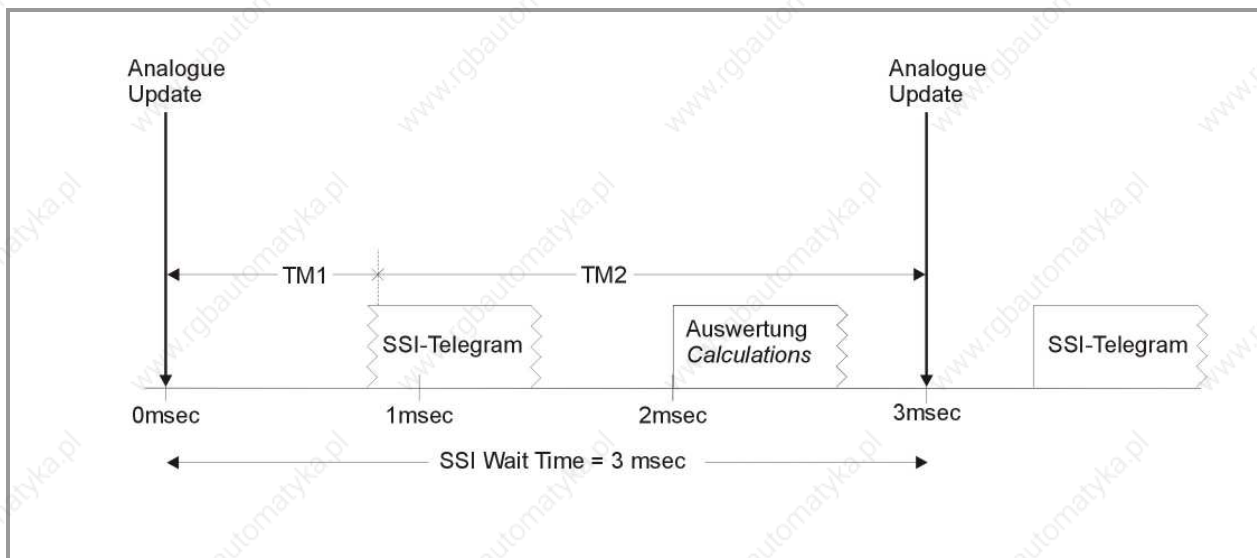

- The shortest possible time for equidistant updating is 1.3 msec, due to internal processing times (SSI Wait Time set to 0.001)
- The time marks TM1 and TM2 shown in above diagram can be displayed with the Monitor function of the PC operator software. It is easy to understand that the sum of both times must be equal to the Wait Time setting; otherwise you must increase the Baud rate or choose a longer update cycle. (The serial access codes are :3 for TM1 and :5 for TM2)
- In critical cases you can reduce the internal processing times of the unit, by omitting the conversion of serial RS232 encoder data. For this, just set parameter "/Operand" to 00000

SSI Offset:

Defines the electrical zero position of the encoder with respect to the mechanical zero position. When the Round-Loop function is not active (Round-Loop = 0), the SSI Offset is subtracted from the SSI position reading, which can also cause negative results. When the Round-Loop is active, SSI Offset displaces the mechanical zero position, but always with only positive results.

SSI Set Value:

Applying a remote Set signal to the Set input (terminal 10) results in a temporary substitution of the SSI position value by the SSI Set Value entered here. This function allows easy testing and simulation of fixed analogue output values while commissioning.

7.4. SSI Error Settings:

SSI Error Bit:

Defines the position of the error bit, if available with the encoder you use. Errors indicated by the encoder can be read out via serial code ;9 (semicolon nine, error indication = 2000hex). In case of an error, on your PC screen, the "Error Bit active" box will appear red and the front LED will blink at a 1:4 On/Off ratio.

- 00: no error bit available
- 13: bit 13 represents the error bit
- 25: bit 25 represents the error bit etc.

SSI Error Bit Polarity:

Defines the polarity of the Error Bit

- 0: Bit is LOW in case of error
- 1: Bit is HIGH in case of error

7.5. Linearisation Settings in %:

P01 (x), P01 (y) etc:

Linearisation registers as shown in section 8.

7.6. Set-up Settings:

Analogue Offset:

This register can adjust the analogue zero output in a range of approx. +/- 100mV (respectively +/- 200 μ A), if necessary.

Analogue Gain:

Sets the maximum output swing of the analogue output.

Setting of 1000 results in a 10 volts respectively 20 milliamps output swing.

Direction:

This parameter changes the internal direction of counting (0 or 1), provided the unit operates in the Round Loop mode.

Any changes of the Round Loop or Direction registers require a new Teach procedure.

7.7. Parameters for RS 232 / RS 485 Settings

Parameter	Description																																												
Unit Number :	<p>It is necessary to attach a specific address to each unit, since up to 32 units can be connected to the same bus with RS485 systems. You can choose any address number between 11 and 99.</p> <p>Factory setting = 11</p> <p>The address must <u>not</u> contain a "0" because these numbers are reserved for collective addressing.</p>																																												
Serial Baud Rate:	<table border="1"> <thead> <tr> <th>Setting</th> <th>Baud-Rate</th> </tr> </thead> <tbody> <tr> <td>0*</td> <td>9600</td> </tr> <tr> <td>1</td> <td>4800</td> </tr> <tr> <td>2</td> <td>2400</td> </tr> <tr> <td>3</td> <td>1200</td> </tr> <tr> <td>4</td> <td>600</td> </tr> <tr> <td>5</td> <td>19 200</td> </tr> <tr> <td>6</td> <td>38 400</td> </tr> </tbody> </table> <p>* = Factory setting</p>	Setting	Baud-Rate	0*	9600	1	4800	2	2400	3	1200	4	600	5	19 200	6	38 400																												
Setting	Baud-Rate																																												
0*	9600																																												
1	4800																																												
2	2400																																												
3	1200																																												
4	600																																												
5	19 200																																												
6	38 400																																												
Serial Format:	<table border="1"> <thead> <tr> <th>Setting</th> <th>Data bits</th> <th>Parity</th> <th>Stop bits</th> </tr> </thead> <tbody> <tr> <td>0</td> <td>7</td> <td>even</td> <td>1</td> </tr> <tr> <td>1</td> <td>7</td> <td>even</td> <td>2</td> </tr> <tr> <td>2</td> <td>7</td> <td>odd</td> <td>1</td> </tr> <tr> <td>3</td> <td>7</td> <td>odd</td> <td>2</td> </tr> <tr> <td>4</td> <td>7</td> <td>none</td> <td>1</td> </tr> <tr> <td>5</td> <td>7</td> <td>none</td> <td>2</td> </tr> <tr> <td>6</td> <td>8</td> <td>even</td> <td>1</td> </tr> <tr> <td>7</td> <td>8</td> <td>odd</td> <td>1</td> </tr> <tr> <td>8</td> <td>8</td> <td>none</td> <td>1</td> </tr> <tr> <td>9</td> <td>8</td> <td>none</td> <td>2</td> </tr> </tbody> </table> <p>* = Factory setting</p>	Setting	Data bits	Parity	Stop bits	0	7	even	1	1	7	even	2	2	7	odd	1	3	7	odd	2	4	7	none	1	5	7	none	2	6	8	even	1	7	8	odd	1	8	8	none	1	9	8	none	2
Setting	Data bits	Parity	Stop bits																																										
0	7	even	1																																										
1	7	even	2																																										
2	7	odd	1																																										
3	7	odd	2																																										
4	7	none	1																																										
5	7	none	2																																										
6	8	even	1																																										
7	8	odd	1																																										
8	8	none	1																																										
9	8	none	2																																										
Serial Protocol:	<p>Determines the sequence of characters sent, when you use the serial output for cyclic data transmission under timer control (xxxxxx is the measuring value transmitted). The length of the transmitted value is dependent on its current value.</p> <p>Both print formats are shown in the following table:</p> <table border="1"> <thead> <tr> <th></th> <th colspan="10">Unit No.</th> </tr> </thead> <tbody> <tr> <td>Serial Protocol = 0*:</td> <td>1</td> <td>1</td> <td>+/-</td> <td>X</td> <td>X</td> <td>X</td> <td>X</td> <td>X</td> <td>X</td> <td>LF</td> <td>CR</td> </tr> <tr> <td>Serial Protocol = 1 :</td> <td></td> <td></td> <td>+/-</td> <td>X</td> <td>X</td> <td>X</td> <td>X</td> <td>X</td> <td>X</td> <td>LF</td> <td>CR</td> </tr> </tbody> </table> <p>* = Factory setting</p>		Unit No.										Serial Protocol = 0*:	1	1	+/-	X	X	X	X	X	X	LF	CR	Serial Protocol = 1 :			+/-	X	X	X	X	X	X	LF	CR									
	Unit No.																																												
Serial Protocol = 0*:	1	1	+/-	X	X	X	X	X	X	LF	CR																																		
Serial Protocol = 1 :			+/-	X	X	X	X	X	X	LF	CR																																		

Parameter	Description										
Serial Timer:	This register determines the cycle time in seconds for cyclic transmission when the Printer Mode is switched on. Range 0.001 to 99.999 seconds. With setting "0" all cyclic transmission is switched off and the unit will only send data upon request (PC mode *).										
Serial Value:	Sets the code of the register of which the content should be sent with cyclic transmission. Setting range 00** – 09 (corresponds to register codes :0 to :9) and 10 - 19 (corresponds to register codes ;0 to ;9). For clarification of register codes see the following figure. The most important register codes are: <table border="1" data-bbox="427 757 986 981" style="margin: 10px auto;"> <thead> <tr> <th>Register</th> <th>ASCII</th> </tr> </thead> <tbody> <tr> <td>Analog Voltage</td> <td>:1</td> </tr> <tr> <td>Calculation (Display)</td> <td>:8</td> </tr> <tr> <td>SSI Value</td> <td>:9</td> </tr> <tr> <td>SSI Value (HW)</td> <td>;0</td> </tr> </tbody> </table> <div data-bbox="443 1025 1417 1926" style="text-align: center;"> <pre> graph TD subgraph IV251_Overview [IV251 Overview] HW1[Hardware] --> SSI_HW[SSI Value (HW) (Code ;,0)] SSI_HW --> Eval_HW[Evaluation of the Hardware Value] Eval_HW --> SSI_Val[SSI-Value (Code ;,9)] SSI_Val --> Eval_SSI[Evaluation of the SSI Value] Eval_SSI --> Analog_V[Analog Voltage (Code ;,1)] Analog_V --> HW2[Hardware] end SSI_Format[- SSI Format (13,21,25 bit)] --> HW1 Bin_Gray[- Bin/Gray Code - Bit Blanking - SSI Error Bit] --> Eval_HW Calc_Display[- Calculate Display Value - Round_Loop - ... - Calculate Analog Value] --> Eval_SSI Eval_SSI --> Display_Val[Display-Value (Code ;,8)] subgraph Legend Comments[Comments] Hardware[Hardware] Parameter[Parameter] Functionality[Functionality] end </pre> </div> <p data-bbox="427 1966 622 1998">** = Factory Setting</p>	Register	ASCII	Analog Voltage	:1	Calculation (Display)	:8	SSI Value	:9	SSI Value (HW)	;0
Register	ASCII										
Analog Voltage	:1										
Calculation (Display)	:8										
SSI Value	:9										
SSI Value (HW)	;0										



*) The serial port of the unit can operate in either "PC-Mode" or in "Printer Mode".

With "PC-Mode", the unit receives a request string and responds with a corresponding data string. For details of the protocol see separate description "SERPRO".

With "Printer Mode" the unit sends data without any request and under Timer control as described subsequently.

As soon as the unit receives a character, it automatically switches over to PC Mode and operates according to protocol. When for a period of 20 sec. no character has been received, the unit switches automatically back to "Printer Mode" and starts cyclic data transmission again.

8. Free Programmable Linearization

This programmable feature allows the user to convert a linear motion to a non-linear analogue output and vice-versa. There are 16 programmable interpolation points available, which can be set in any desired distance over the full conversion range. Between two points, the unit uses linear interpolation. Therefore it is advisable to use more points in a range with strong curves and only a few points where the curvature is less.

To specify your desired linearization curve, you must first set the „Linearisation Mode“ register to either 1 or 2.

Use registers **P1(x)** to **P16(x)** to specify the coordinates on the x-axis. These are the analogue output values that the unit normally would generate according to the actual encoder position. These settings must be in % of full scale.

Now enter the attached values to registers **P1(y)** to **P16(y)**. These are the values that the analogue output will generate instead of the x- values.

As an example, the value of P2(y) will substitute the encoder value P2(x) etc.



- x-registers must use continuously increasing settings, i.e. P1(x) must have the lowest setting and P16(x) must have the highest setting
- All entries use a percentage format of xx.xxx% full scale. Setting 0.000% means zero output and setting 100.000% means full scale output.
- With Linearisation Mode set to 1, it is a must to set P1(x) to 0% and P16(x) to 100%. Linearization is defined in the positive range only and the negative range will be a mirror image of the positive range with reference to zero
- With Linearisation Mode set to 2, it is a must to set P1(x) to -100% and P16(x) to +100%. This enables the user to set curves which are not symmetric to the zero position.

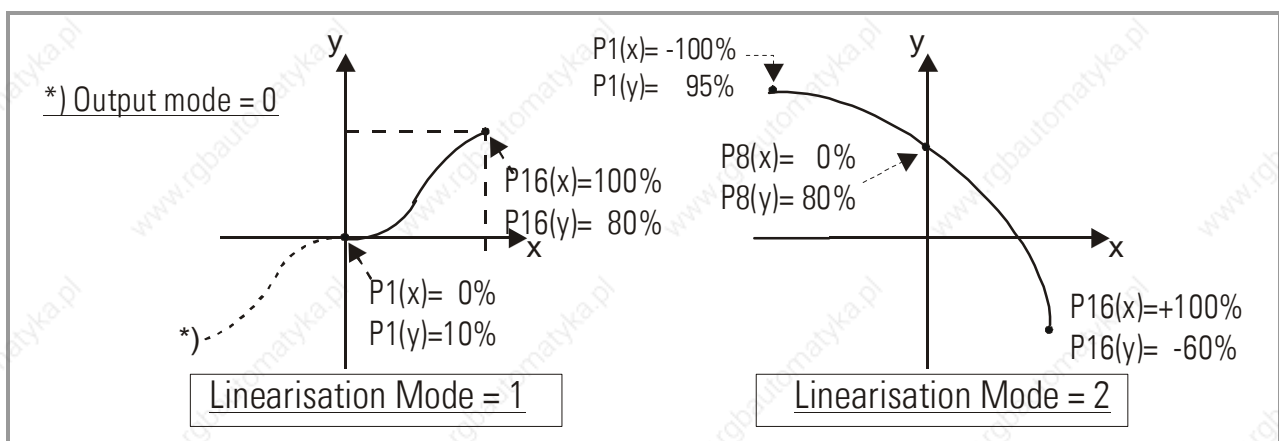

You can visualize your curve on the PC screen or by means of an external oscilloscope. For this, select TOOLS, then TEST and there „Analogue Voltage Function“. The unit will now simulate a repeating motion of the encoder over the full range and generate the analogue signal accordingly. When you use the Scope function of the operator software, you must set the serial code „ :1 „ to record the analogue output.

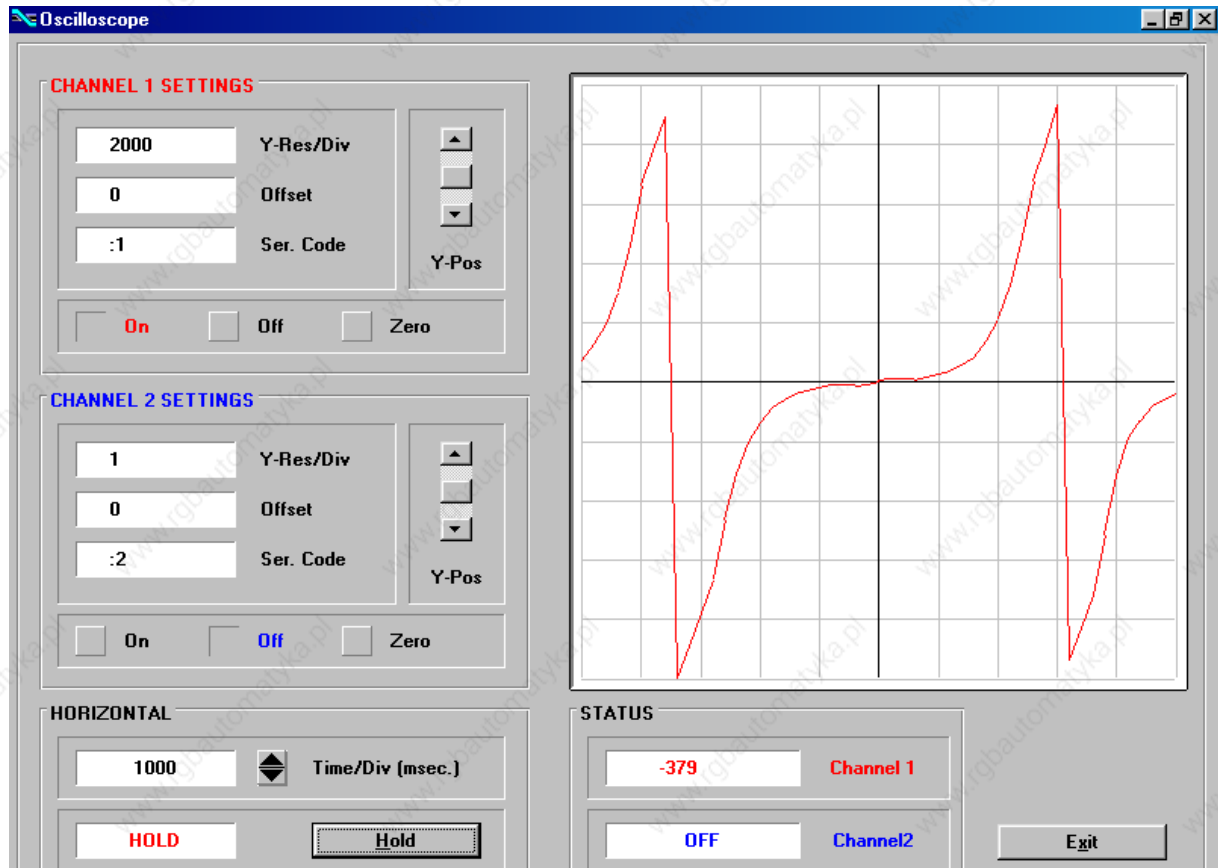

9. Testing Functions

When you select TEST from the TOOLS menu, you are able to verify the following data, by clicking to the corresponding field:

- Actual encoder position
- DIL switch settings
- Internal supply voltages
- Analogue output state

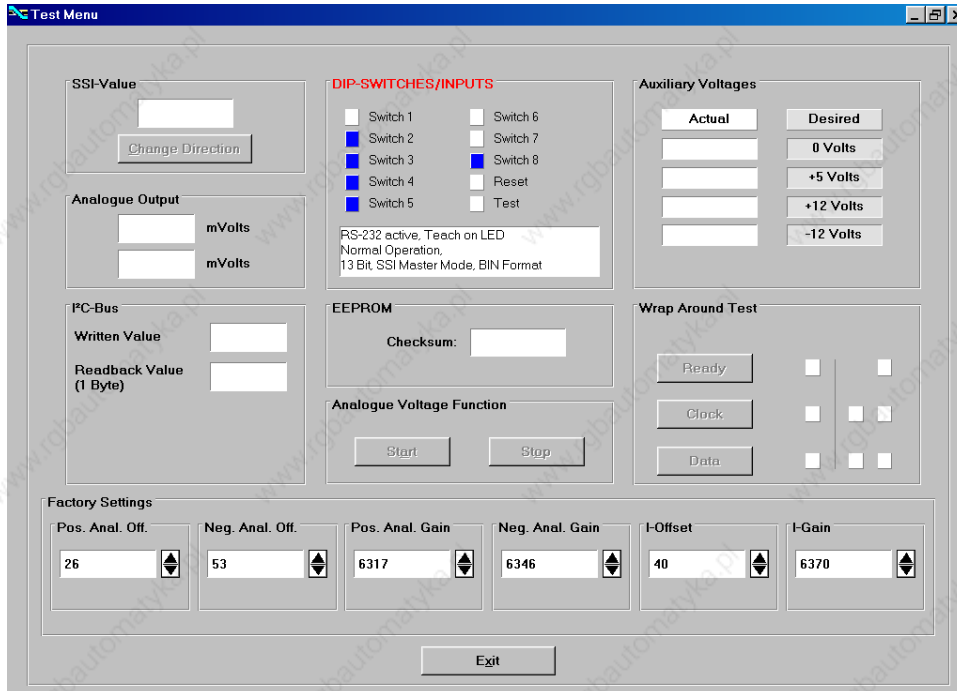

Furthermore, the following registers can be recorded by using the monitor function:

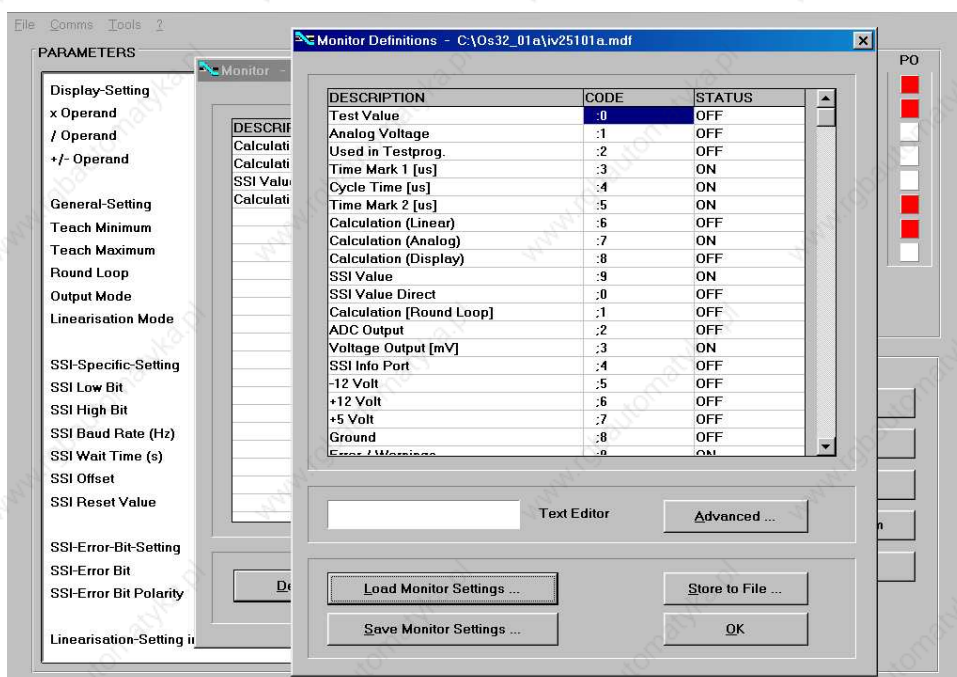

10. Dimensions and Specifications

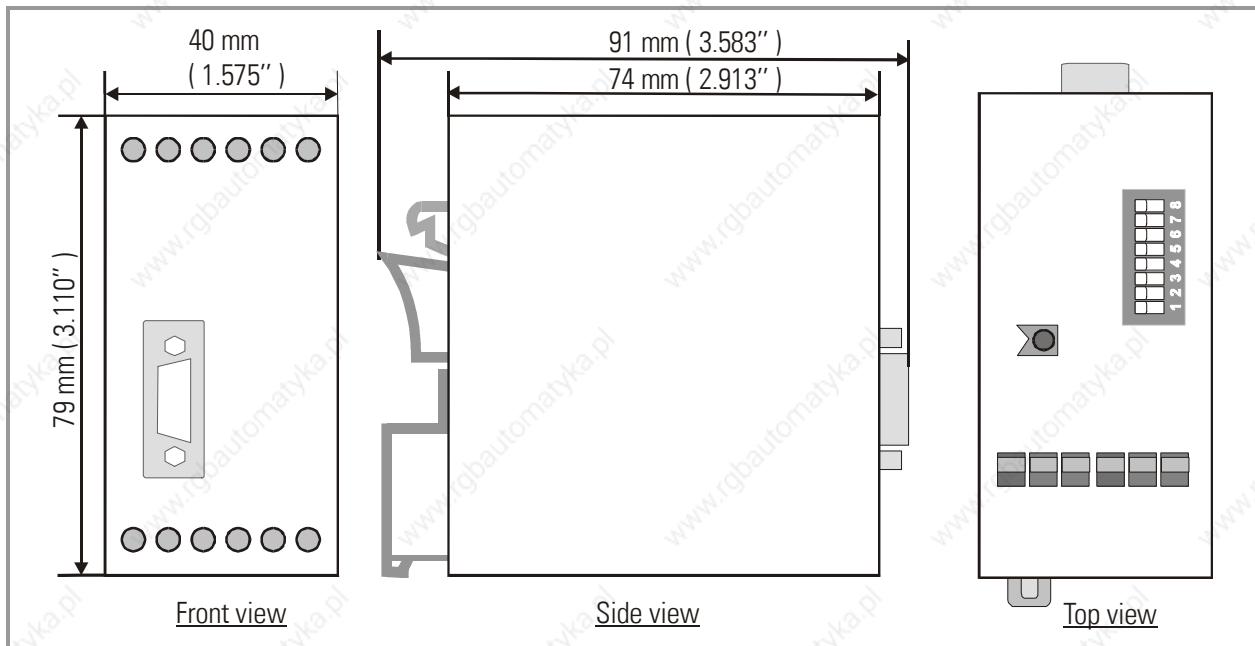

Power Supply	:	18...30 VDC
Power consumption	:	about 170 mA at 18V (+5.5V not connected) about 120 mA at 30V
Inputs (SSI)	:	TTL differential, RS-422 standard (1.0 MHz)
SSI Format	:	13, 21 or 25 Bit (Master / Slave / Gray / Bin)
SSI break time	:	min. 4 clock cycles
Set Input (HTL)	:	High > 10V , Low < 3V (Ri = 5k) Active High; minimum pulse duration 10 msec.
Encoder supply	:	+5.5V +/- 5% (max. Load: 150 mA)
Analogue outputs	:	+/- 10V (> 5 kOhm), 0-20 mA / 4-20 mA (<270 Ohms)
Resolution	:	14 Bits
Stabilization time	:	2 msec.
Accuracy	:	+/- 0.1%
Temperature-Range	:	Operation: 0° ... +45°C (+32 ... +113°F) Storage: -25° ... +70°C (-13 ... +158 °F)
Weight	:	approx. 190 g
Conformity and Standards	:	EMC 2004/108/EC: EN 61000-6-2 EN 61000-6-3

11. Parameter-List

Parameter	Min. value	Max. value	Default	Positions	Char.	Serial Code
X Operand	-10.0000	+10.0000	1.0000	+/- 6	4	00
/ Operand	0	10.0000	1.0000	6	4	01
+/- Operand	-99999999	99999999	0	+/- 8	0	02
Teach Minimum	-99999999	+99999999	0	+/- 8	0	03
Teach Maximum	-99999999	+99999999	10000	+/- 8	0	04
Round Loop	0	99999999	0	8	0	05
Output Mode	0	3	0	1	0	06
Linearisation Mode	0	2	0	1	0	07
SSI Low Bit	0	25	1	2	0	08
SSI High Bit	1	25	25	2	0	09
SSI Baud rate	100	1000000	100000	7	0	10
SSI Wait Time	0	10.000	0	5	3	11
SSI Offset	0	99999999	0	8	0	12
SSI Reset Value	0	99999999	0	8	0	13
SSI Error Bit	0	25	0	2	0	14
SSI Error Bit Polarity	0	1	0	1	0	15
P1(x)	-100.000	+100.000	100000	+/- 6	3	A0
P1(y).....	-100.000	+100.000	100000	+/- 6	3	A1
P16(x)	-100.000	+100.000	100000	+/- 6	3	D0
P16(y)	-100.000	+100.000	100000	+/- 6	3	D1
Direction	0	1	0	1	0	46
Analog Offset	-99	+99	0	+/-2	0	47
Analog Gain	0	10000	1000	5	0	48
Unit Number	0	99	11	2	0	90
Serial Baud Rate	0	6	0	1	0	91
Serial Format	0	9	0	1	0	92
Serial Protocol	0	1	0	1	0	30
Serial Timer	0	99.999	0	5	3	31
Serial Value	0	19	0	2	0	32
Reserve	0	10000	0	5	0	33