

1 Form A Solid-State Relay

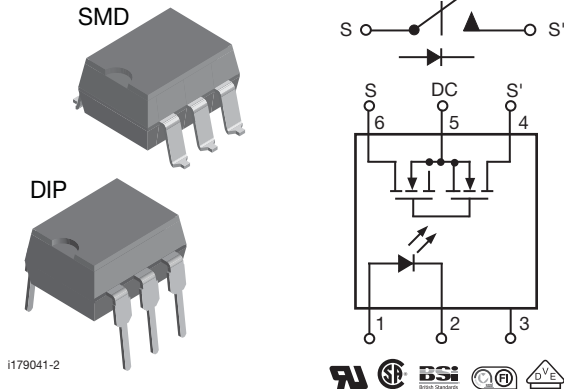

i179041-2

DESCRIPTION

The LH1546 is robust, ideal for telecom and ground fault applications. It is a SPST normally open switch (1 form A) that replaces electromechanical relays in many applications. It is constructed using a GaAlAs LED for actuation control and an integrated monolithic die for the switch output. The die, fabricated in a high-voltage dielectrically isolated technology, is comprised of a photodiode array, switch control circuitry and MOSFET switches. In addition, it employs current-limiting circuitry which meets lightning surge testing as per ANSI/TIA-968-B and other regulatory voltage surge requirements when overvoltage protection is provided.

FEATURES

- Current limit protection
- Isolation test voltage 5300 V_{RMS}
- Typical R_{ON} 28 Ω
- Load voltage 350 V
- Load current 120 mA
- High surge capability
- Clean bounce free switching
- Low power consumption
- SMD lead available on tape and reel
- Equivalent to CP Clare LCA110
- Compliant to RoHS Directive 2002/95/EC and in accordance to WEEE 2002/96/EC

RoHS
COMPLIANT

APPLICATIONS

- General telecom switching
- Instrumentation
- Industrial controls

Note

- See "solid-state relays" (application note 56)

AGENCY APPROVALS

UL1577: file no. E52744 system code H, double protection

CSA: certification no. 093751

DIN EN: 60747-5-2 (VDE 0884)/60747-5-5 (pending), available with option 1

BSI: certification no. 7979/7980

FIMKO: 25419

ORDERING INFORMATION												
L	H	1	5	4	6	#	#	#	T	R	 DIP 7.62 mm	 SMD > 0.1 mm
PART NUMBER						ELECTR. VARIATION		PACKAGE CONFIG.		TAPE AND REEL		
PACKAGE						UL, CSA, BSI, FIMKO						
SMD-6, tubes						LH1546AAB						
SMD-6, tape and reel						LH1546AABTR						
DIP-6, tubes						LH1546AT						



ABSOLUTE MAXIMUM RATINGS ($T_{amb} = 25\text{ }^{\circ}\text{C}$, unless otherwise specified)				
PARAMETER	TEST CONDITION	SYMBOL	VALUE	UNIT
INPUT				
LED continuous forward current		I_F	50	mA
LED reverse voltage	$I_R \leq 10\text{ }\mu\text{A}$	V_R	8	V
OUTPUT				
DC or peak AC load voltage	$I_L \leq 50\text{ }\mu\text{A}$	V_L	350	V
Continuous DC load current at 25 °C, bidirectional		I_L	120	mA
Continuous DC load current at 25 °C, unidirectional		I_L	200	mA
SSR				
Ambient temperature range		T_{amb}	- 40 to + 85	°C
Storage temperature range		T_{stg}	- 40 to + 150	°C
Soldering temperature ⁽¹⁾	$t = 10\text{ s max.}$	T_{sld}	260	°C
Isolation test voltage	for 1 s	V_{ISO}	5300	V_{RMS}
Isolation resistance	$V_{IO} = 500\text{ V, } T_{amb} = 25\text{ }^{\circ}\text{C}$	R_{IO}	$\geq 10^{12}$	Ω
	$V_{IO} = 500\text{ V, } T_{amb} = 100\text{ }^{\circ}\text{C}$	R_{IO}	$\geq 10^{11}$	Ω
SSR output power dissipation (continuous)		P_{diss}	550	mW

Notes

- Stresses in excess of the absolute maximum ratings can cause permanent damage to the device. Functional operation of the device is not implied at these or any other conditions in excess of those given in the operational sections of this document. Exposure to absolute maximum ratings for extended periods of the time can adversely affect reliability.

⁽¹⁾ Refer to reflow profile for soldering conditions for surface mounted devices (SMD). Refer to wave profile for soldering conditions for through hole devices (DIP).

ELECTRICAL CHARACTERISTICS ($T_{amb} = 25\text{ }^{\circ}\text{C}$, unless otherwise specified)						
PARAMETER	TEST CONDITION	SYMBOL	MIN.	TYP.	MAX.	UNIT
INPUT						
LED forward current, switch turn-on	$I_L = 100\text{ mA, } t = 10\text{ ms}$	I_{Fon}		1.1	2	mA
LED forward current, switch turn-off	$V_L = \pm 350\text{ V}$	I_{Foff}	0.2	1		mA
LED forward voltage	$I_F = 10\text{ mA}$	V_F	1.15	1.26	1.45	V
OUTPUT						
On-resistance, AC/DC: pin 4 (\pm) to 6 (\pm)	$I_F = 5\text{ mA, } I_L = 50\text{ mA}$	R_{ON}		28	35	Ω
On-resistance, DC: pin 4, 6 (+) to 5 (-)	$I_F = 5\text{ mA, } I_L = 50\text{ mA}$	R_{ON}		7	10	Ω
Off-resistance	$I_F = 0\text{ mA, } V_L = \pm 100\text{ V}$	R_{OFF}	0.5	300		G Ω
Current limit AC ⁽¹⁾ : pin 4 (\pm) to 6 (\pm)	$I_F = 5\text{ mA, } t = 5\text{ ms, } V_L = 6\text{ V}$	I_{LMT}	170	210	250	mA
Off-state leakage current	$I_F = 0\text{ mA, } V_L = \pm 100\text{ V}$	I_O		0.35	200	nA
	$I_F = 0\text{ mA, } V_L = \pm 350\text{ V}$	I_O		0.096	1	μA
Output capacitance pin 4 to 6	$I_F = 0\text{ mA, } V_L = 1\text{ V}$	C_O		18		pF
	$I_F = 0\text{ mA, } V_L = 50\text{ V}$	C_O		6.7		pF
Switch offset	$I_F = 5\text{ mA}$	V_{OS}		0.3		μV
TRANSFER						
Capacitance (input to output)	$V_{ISO} = 1\text{ V}$	C_{IO}		0.67		pF

Notes

- Minimum and maximum values are testing requirements. Typical values are characteristics of the device and are the result of engineering evaluations. Typical values are for information only and are not part of the testing requirements.

⁽¹⁾ No DC mode current limit available.

SWITCHING CHARACTERISTICS ($T_{amb} = 25\text{ }^{\circ}\text{C}$, unless otherwise specified)						
PARAMETER	TEST CONDITION	SYMBOL	MIN.	TYP.	MAX.	UNIT
Turn-on time	$I_F = 5\text{ mA, } I_L = 50\text{ mA}$	t_{on}		1.14	3	ms
Turn-off time	$I_F = 5\text{ mA, } I_L = 50\text{ mA}$	t_{off}		0.71	3	ms



SAFETY AND INSULATION RATINGS				
PARAMETER	TEST CONDITION	SYMBOL	VALUE	UNIT
Climatic classification	IEC 68 part 1		40/85/21	
Pollution degree	DIN VDE 0109		2	
Tracking resistance (comparative tracking index)	Insulation group IIIa	CTI	175	
Highest allowable overvoltage	Transient overvoltage	V_{IOTM}	8000	V_{peak}
Max. working insulation voltage	Recurring peak voltage	V_{IORM}	890	V_{peak}
Insulation resistance at 25 °C	$V_{IO} = 500 V$	R_{IS}	$\geq 10^{12}$	Ω
Insulation resistance at T_S		R_{IS}	$\geq 10^9$	Ω
Insulation resistance at 100 °C		R_{IS}	$\geq 10^{11}$	Ω
Partial discharge test voltage	Methode a, $V_{pd} = V_{IORM} \times 1.875$	V_{pd}	1669	V_{peak}
Safety limiting values - maximum values allowed in the event of a failure	Case temperature	T_{SI}	175	°C
	Input current	I_{SI}	300	mA
	Output power	P_{SO}	700	mW
Minimum external air gap (clearance)	Measured from input terminals to output terminals, shortest distance through air		≥ 7	mm
Minimum external tracking (creepage)	Measured from input terminals to output terminals, shortest distance path along body		≥ 7	mm

TYPICAL CHARACTERISTICS ($T_{amb} = 25\text{ °C}$, unless otherwise specified)

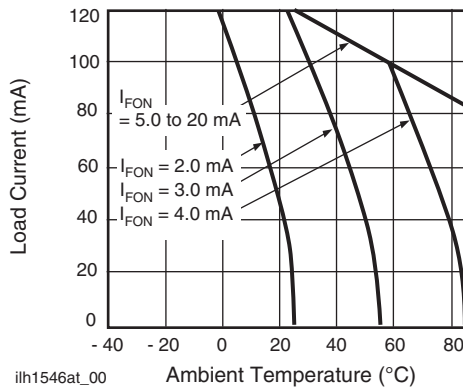

Fig. 1 - Recommended Operating Conditions

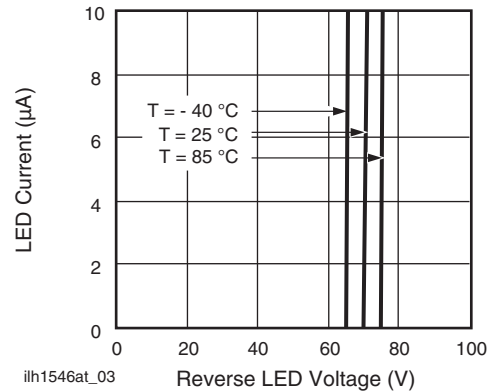

Fig. 3 - LED Reverse Current vs. LED Reverse Voltage

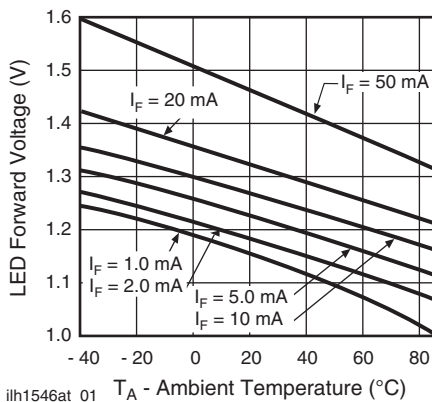

Fig. 2 - LED Voltage vs. Temperature

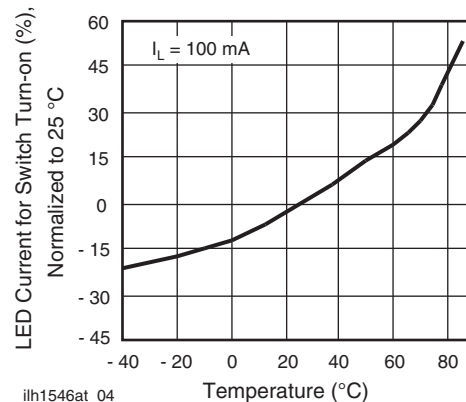
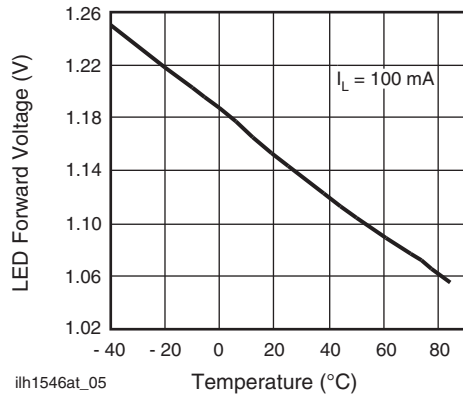
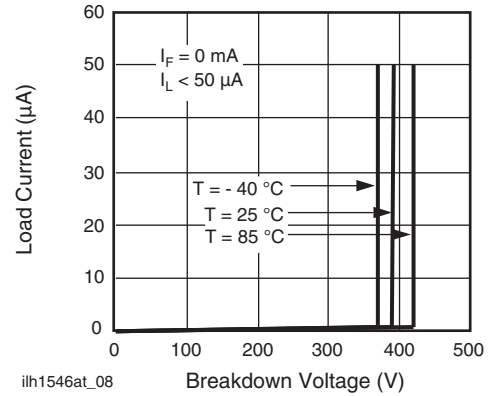

Fig. 4 - LED Current for Switch Turn-on vs. Temperature



ilh1546at_05

Fig. 5 - LED Dropout Voltage vs. Temperature



ilh1546at_08

Fig. 8 - Switch Breakdown Voltage vs. Load Current

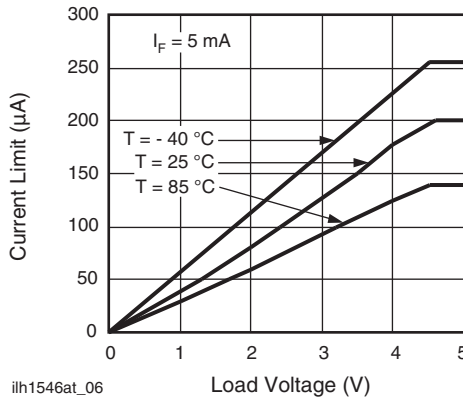

ilh1546at_06

Fig. 6 - Load Current vs. Load Voltage

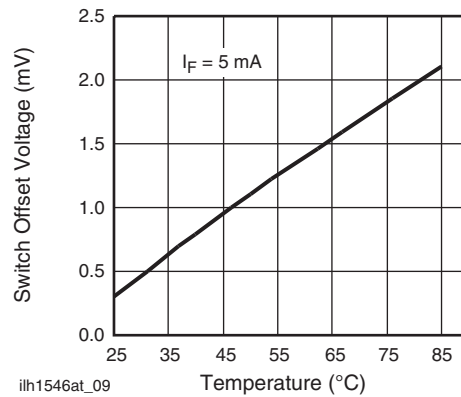

ilh1546at_09

Fig. 9 - Switch Offset Voltage vs. LED Current

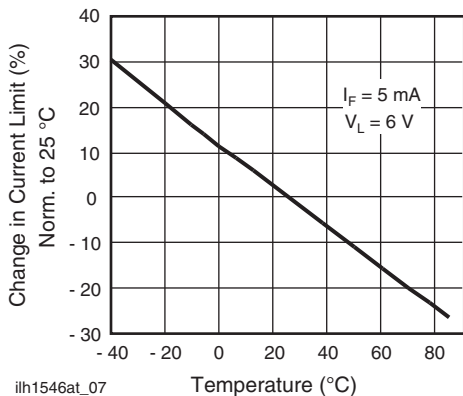

ilh1546at_07

Fig. 7 - Current Limit vs. Temperature

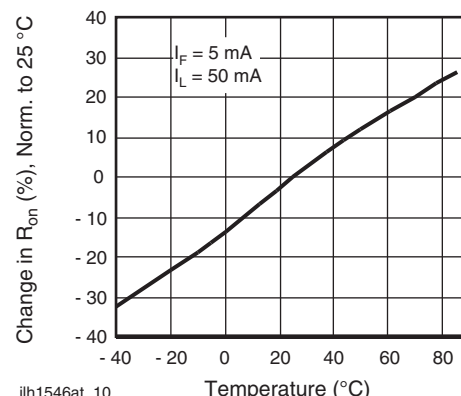

ilh1546at_10

Fig. 10 - On-resistance vs. Temperature

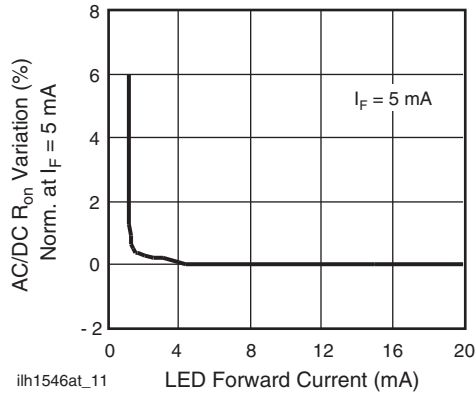

Fig. 11 - Variation in On-resistance vs. LED Current

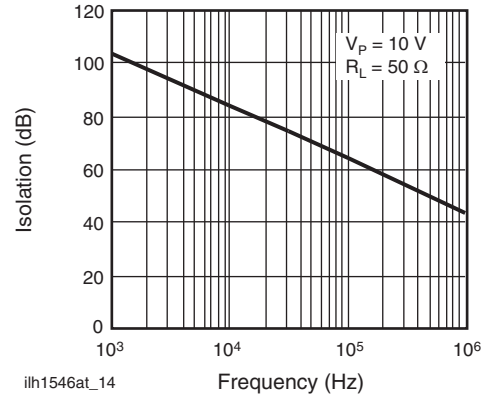

Fig. 14 - Output Isolation

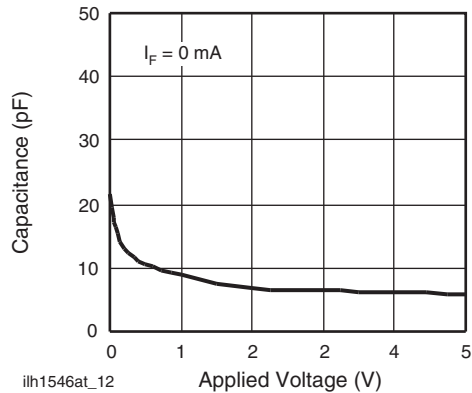

Fig. 12 - Switch Capacitance vs. Applied Voltage

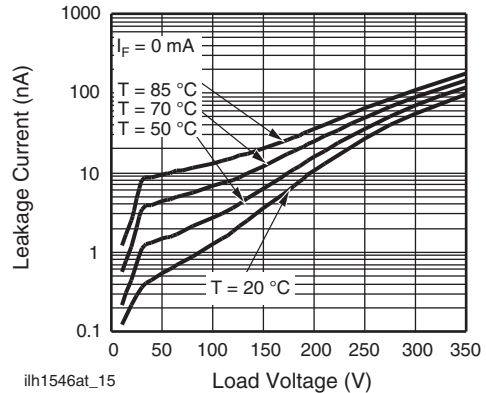

Fig. 15 - Leakage Current vs. Applied Voltage at Elevated Temperatures

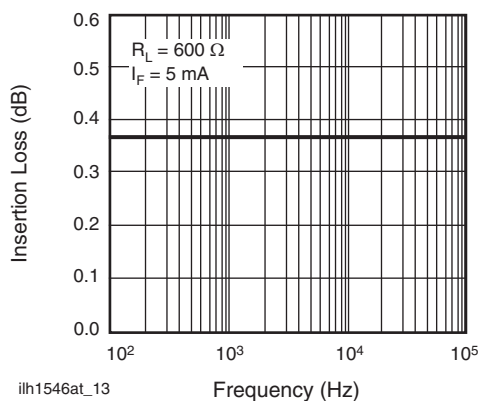

Fig. 13 - Insertion Loss vs. Frequency

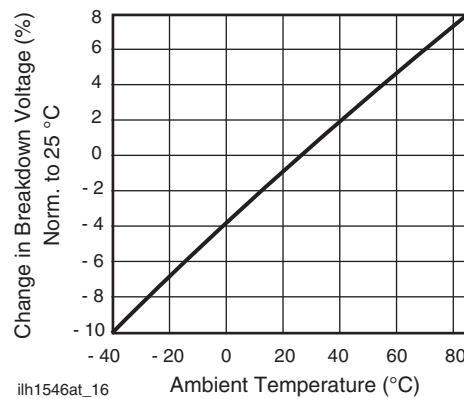
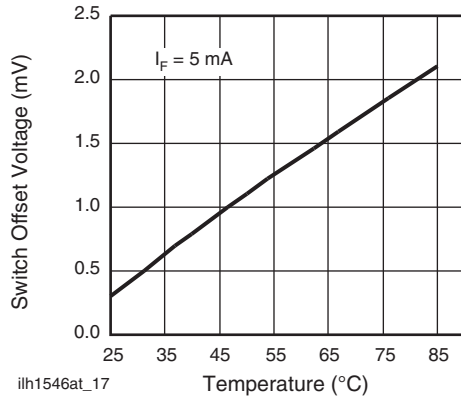
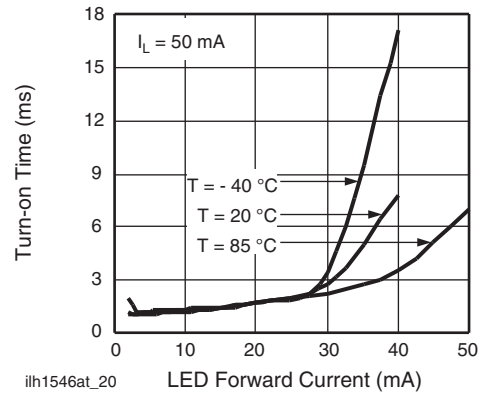

Fig. 16 - Switch Breakdown Voltage vs. Temperature



ilh1546at_17

Fig. 17 - Switch Offset Voltage vs. Temperature



ilh1546at_20

Fig. 20 - Turn-on Time vs. LED Current

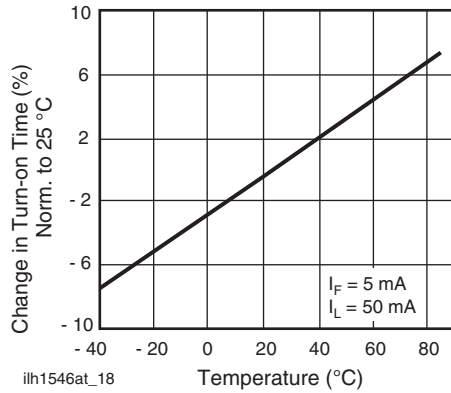

ilh1546at_18

Fig. 18 - Turn-on Time vs. Temperature

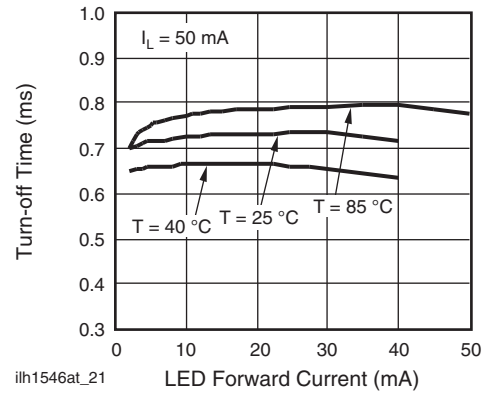

ilh1546at_21

Fig. 21 - Turn-off Time vs. LED Current

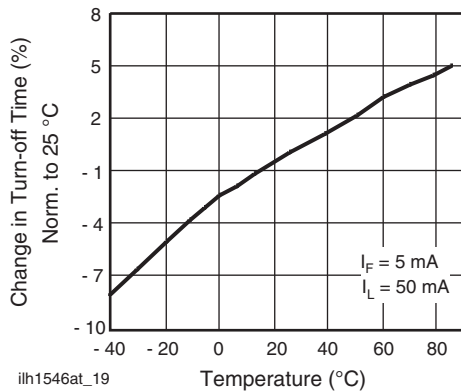

ilh1546at_19

Fig. 19 - Turn-off Time vs. Temperature



PACKAGE DIMENSIONS in millimeters

DIP

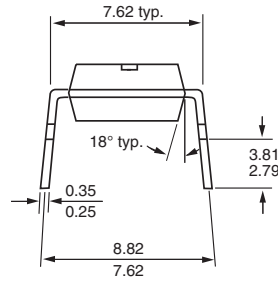
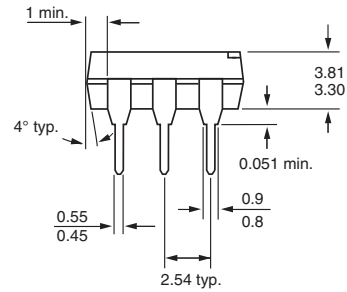
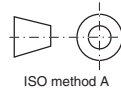
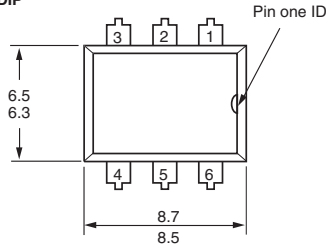

i178001

SMD

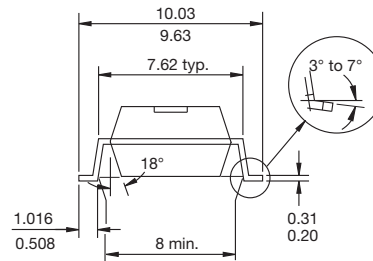
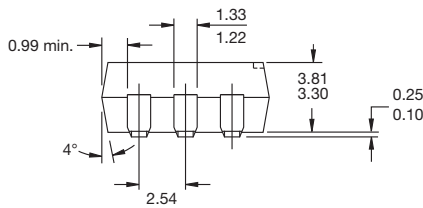
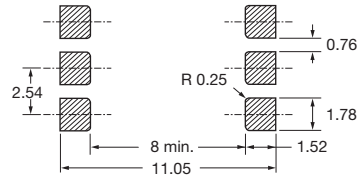
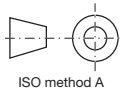
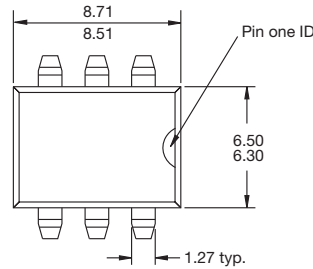

i178002

PACKAGE MARKING

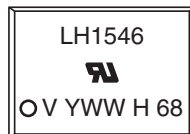

Note

- Tape and reel suffix (TR) is no part of the package marking.



Disclaimer

ALL PRODUCT, PRODUCT SPECIFICATIONS AND DATA ARE SUBJECT TO CHANGE WITHOUT NOTICE TO IMPROVE RELIABILITY, FUNCTION OR DESIGN OR OTHERWISE.

Vishay Intertechnology, Inc., its affiliates, agents, and employees, and all persons acting on its or their behalf (collectively, "Vishay"), disclaim any and all liability for any errors, inaccuracies or incompleteness contained in any datasheet or in any other disclosure relating to any product.

Vishay makes no warranty, representation or guarantee regarding the suitability of the products for any particular purpose or the continuing production of any product. To the maximum extent permitted by applicable law, Vishay disclaims (i) any and all liability arising out of the application or use of any product, (ii) any and all liability, including without limitation special, consequential or incidental damages, and (iii) any and all implied warranties, including warranties of fitness for particular purpose, non-infringement and merchantability.

Statements regarding the suitability of products for certain types of applications are based on Vishay's knowledge of typical requirements that are often placed on Vishay products in generic applications. Such statements are not binding statements about the suitability of products for a particular application. It is the customer's responsibility to validate that a particular product with the properties described in the product specification is suitable for use in a particular application. Parameters provided in datasheets and / or specifications may vary in different applications and performance may vary over time. All operating parameters, including typical parameters, must be validated for each customer application by the customer's technical experts. Product specifications do not expand or otherwise modify Vishay's terms and conditions of purchase, including but not limited to the warranty expressed therein.

Except as expressly indicated in writing, Vishay products are not designed for use in medical, life-saving, or life-sustaining applications or for any other application in which the failure of the Vishay product could result in personal injury or death. Customers using or selling Vishay products not expressly indicated for use in such applications do so at their own risk. Please contact authorized Vishay personnel to obtain written terms and conditions regarding products designed for such applications.

No license, express or implied, by estoppel or otherwise, to any intellectual property rights is granted by this document or by any conduct of Vishay. Product names and markings noted herein may be trademarks of their respective owners.

Mouser Electronics

Authorized Distributor

Click to View Pricing, Inventory, Delivery & Lifecycle Information:

Vishay:

[LH1546AABTR](#) [LH1546AAB](#) [LH1546AT](#)