

## Operating Instructions Edition 05/2006



**Industrial PC**  
Box PC 627

# simatic

# SIEMENS



# SIEMENS

## SIMATIC

### Industrial PC SIMATIC Box PC 627

#### Operating Instructions

<u>Introduction</u>	<b>1</b>
<u>Safety Information</u>	<b>2</b>
<u>Description</u>	<b>3</b>
<u>Application Planning</u>	<b>4</b>
<u>Installation</u>	<b>5</b>
<u>Connecting</u>	<b>6</b>
<u>Commissioning</u>	<b>7</b>
<u>Integration</u>	<b>8</b>
<u>Functions</u>	<b>9</b>
<u>Expansions and configuration</u>	<b>10</b>
<u>Maintenance and service</u>	<b>11</b>
<u>Alarm, Error and System Messages</u>	<b>12</b>
<u>Troubleshooting</u>	<b>13</b>
<u>Technical Data</u>	<b>14</b>
<u>Dimensional Drawings</u>	<b>15</b>
<u>Detailed descriptions</u>	<b>16</b>
<u>Appendix</u>	<b>A</b>
<u>ESD Guidelines</u>	<b>B</b>
<u>Abbreviations</u>	<b>C</b>

## Safety Guidelines

This manual contains notices you have to observe in order to ensure your personal safety, as well as to prevent damage to property. The notices referring to your personal safety are highlighted in the manual by a safety alert symbol, notices referring only to property damage have no safety alert symbol. These notices shown below are graded according to the degree of danger.



---

### Danger

indicates that death or severe personal injury **will** result if proper precautions are not taken.

---



---

### Warning

indicates that death or severe personal injury **may** result if proper precautions are not taken.

---



---

### Caution

with a safety alert symbol, indicates that minor personal injury can result if proper precautions are not taken.

---

---

### Caution

without a safety alert symbol, indicates that property damage can result if proper precautions are not taken.

---

---

### Notice

indicates that an unintended result or situation can occur if the corresponding information is not taken into account.

---

If more than one degree of danger is present, the warning notice representing the highest degree of danger will be used. A notice warning of injury to persons with a safety alert symbol may also include a warning relating to property damage.

## Qualified Personnel

The device/system may only be set up and used in conjunction with this documentation. Commissioning and operation of a device/system may only be performed by **qualified personnel**. Within the context of the safety notes in this documentation qualified persons are defined as persons who are authorized to commission, ground and label devices, systems and circuits in accordance with established safety practices and standards.

## Prescribed Usage

Note the following:



---

### Warning

This device may only be used for the applications described in the catalog or the technical description and only in connection with devices or components from other manufacturers which have been approved or recommended by Siemens. Correct, reliable operation of the product requires proper transport, storage, positioning and assembly as well as careful operation and maintenance.

---

## Trademarks

All names identified by ® are registered trademarks of the Siemens AG. The remaining trademarks in this publication may be trademarks whose use by third parties for their own purposes could violate the rights of the owner.

## Disclaimer of Liability

We have reviewed the contents of this publication to ensure consistency with the hardware and software described. Since variance cannot be precluded entirely, we cannot guarantee full consistency. However, the information in this publication is reviewed regularly and any necessary corrections are included in subsequent editions.

# Table of contents

<b>1</b>	<b>Introduction</b> .....	<b>1-1</b>
1.1	Preface.....	1-1
1.2	Guideline to the operating instructions .....	1-2
<b>2</b>	<b>Safety Information</b> .....	<b>2-1</b>
2.1	General safety instructions .....	2-1
<b>3</b>	<b>Description</b> .....	<b>3-1</b>
3.1	Overview .....	3-1
3.2	Areas of application .....	3-2
3.3	Benefits .....	3-2
3.4	Function .....	3-3
3.5	Features .....	3-3
3.6	Windows XP Embedded .....	3-5
3.7	Design .....	3-6
3.7.1	External structure .....	3-6
3.7.2	Operator Controls .....	3-8
3.7.3	Connection elements .....	3-9
<b>4</b>	<b>Application Planning</b> .....	<b>4-1</b>
4.1	Transport.....	4-1
4.2	Unpacking and checking the delivery unit .....	4-1
4.3	Device identification data .....	4-2
4.4	Ambient and environmental conditions.....	4-3
4.5	Permitted mounting positions.....	4-4
<b>5</b>	<b>Installation</b> .....	<b>5-1</b>
5.1	Installation of the device with mounting brackets .....	5-1
5.2	Installation of the device with the vertical mounting kit.....	5-2
<b>6</b>	<b>Connecting</b> .....	<b>6-1</b>
6.1	Connecting peripherals .....	6-1
6.2	Connecting the 120 V / 230 V Ac power supply .....	6-2
6.3	Connecting the (24 V) DC power supply .....	6-4
6.4	Connecting the equipotential bonding circuit.....	6-5

<b>7</b>	<b>Commissioning</b> .....	<b>7-1</b>
7.1	Requirements for commissioning.....	7-1
7.2	Basic commissioning - initial startup.....	7-1
7.3	Windows XP Security Center.....	7-2
7.4	Switching off the device.....	7-2
7.5	Notes on operation.....	7-3
7.5.1	DVD ROM/CD RW.....	7-3
7.5.2	2HDD/RAID system (optional).....	7-3
7.5.2.1	2 HDD system.....	7-4
7.5.2.2	RAID system.....	7-4
<b>8</b>	<b>Integration</b> .....	<b>8-1</b>
<b>9</b>	<b>Functions</b> .....	<b>9-1</b>
9.1	Overview.....	9-1
9.2	Temperature monitoring.....	9-1
9.3	Watchdog (WD).....	9-2
9.4	Fan monitoring.....	9-2
9.5	Safecard on Motherboard (SOM).....	9-3
9.6	Status display.....	9-4
<b>10</b>	<b>Expansions and configuration</b> .....	<b>10-1</b>
10.1	Opening the Device.....	10-1
10.2	Memory expansion.....	10-3
10.2.1	Removing/Installing Memory Module.....	10-3
10.3	Installing PCI expansion cards.....	10-6
10.3.1	Notes on the modules.....	10-6
10.3.2	Installing / removing expansion modules.....	10-6
10.4	Installing disk drives.....	10-8
10.4.1	Options of installing disk drives.....	10-8
10.4.2	Installing/removing a drive bay module.....	10-10
10.4.3	Installing and removing DVD-ROM/CD-RW drives.....	10-11
10.4.4	Installing / removing hard disks.....	10-12
10.5	Installing/removing a Compact Flash card.....	10-14
<b>11</b>	<b>Maintenance and service</b> .....	<b>11-1</b>
11.1	Removing and installing hardware components.....	11-1
11.1.1	Repairs.....	11-1
11.1.2	Replacing the Backup Battery.....	11-2
11.1.3	Removing/Installing the Power Supply.....	11-5
11.1.4	Installing / removing the bus board.....	11-7
11.1.5	Installing / removing the motherboard.....	11-8
11.1.6	Installing / removing the equipment fan.....	11-10
11.1.7	Installing / removing the power supply fan.....	11-12
11.1.8	Installing / removing the processor.....	11-14
11.2	Reinstalling the Operating System.....	11-17
11.2.1	Windows XP Embedded.....	11-17
11.2.1.1	General installation procedure.....	11-17
11.2.1.2	Restoring the software to factory state using the Restore CD.....	11-17

11.2.2	Windows XP Professional / Windows 2000 MUI .....	11-19
11.2.2.1	General installation procedure .....	11-19
11.2.2.2	Restoring the Software to Factory State Using the Restore DVD .....	11-19
11.2.2.3	Setting up the operating system via the Recovery CD .....	11-21
11.3	Partitioning the hard disk .....	11-25
11.3.1	Setting up the partitions under Windows XP Embedded .....	11-25
11.3.2	Setting up partitions under Windows XP Professional / Windows 2000 MUI .....	11-25
11.4	Install drivers and software .....	11-26
11.4.1	Driver installation under Windows XP Embedded .....	11-26
11.5	Install RAID Controller Software .....	11-27
11.6	Install burner / DVD software .....	11-27
11.6.1	Installing burner/DVD software .....	11-27
11.7	Installing updates .....	11-27
11.7.1	Updating the operating system .....	11-27
11.7.2	Installing or updating application programs and drivers .....	11-28
11.8	Data backup .....	11-28
11.8.1	Creating an image .....	11-28
<b>12</b>	<b>Alarm, Error and System Messages .....</b>	<b>12-1</b>
12.1	Boot error messages .....	12-1
12.2	BIOS POST codes .....	12-3
<b>13</b>	<b>Troubleshooting .....</b>	<b>13-1</b>
13.1	General problems .....	13-1
13.2	Problems when Using Modules of Third-party Manufacturers .....	13-2
13.3	Display a temperature fault by means of the SOM application .....	13-3
<b>14</b>	<b>Technical Data .....</b>	<b>14-1</b>
14.1	General Specifications .....	14-1
14.2	Power requirements of the components .....	14-4
14.3	AC voltage supply .....	14-5
14.4	DC power supply .....	14-6
<b>15</b>	<b>Dimensional Drawings .....</b>	<b>15-1</b>
15.1	Dimensional Drawing of the Device .....	15-1
15.2	Dimensional drawings for the installation of expansion modules .....	15-4
<b>16</b>	<b>Detailed descriptions .....</b>	<b>16-1</b>
16.1	Motherboard .....	16-1
16.1.1	Structure and functions of the motherboard .....	16-1
16.1.2	Technical features of the motherboard .....	16-2
16.1.3	Position of the ports on the motherboard .....	16-3
16.1.4	External ports .....	16-4
16.1.5	Front ports .....	16-10
16.1.6	Internal interfaces .....	16-14
16.2	Bus board .....	16-17
16.2.1	Layout and principle of operation .....	16-17
16.2.2	Interrupt assignment (PCI-IRQ) .....	16-18
16.2.3	Exclusive PCI hardware interrupt .....	16-18

## Table of contents

---

16.2.4	PCI slot pin assignment .....	16-19
16.2.5	Pin assignment 12V power supply connection for WinAC module .....	16-20
16.3	System resources .....	16-21
16.3.1	Currently allocated system resources .....	16-21
16.3.2	System resources used by the BIOS/DOS .....	16-21
16.3.2.1	I/O address allocation .....	16-21
16.3.2.2	Interrupt Assignments .....	16-23
16.3.2.3	Memory address assignments .....	16-24
16.4	BIOS Setup .....	16-25
16.4.1	Overview .....	16-25
16.4.2	Starting BIOS Setup .....	16-25
16.4.3	BIOS Setup menus .....	16-26
16.4.4	Main menu .....	16-27
16.4.5	Advanced Menu .....	16-38
16.4.6	Security menu .....	16-42
16.4.7	Boot menu .....	16-44
16.4.8	Version menu .....	16-45
16.4.9	Exit Menu .....	16-46
16.4.10	Default BIOS Setup entries .....	16-47
<b>A</b>	<b>Appendix</b> .....	<b>A-1</b>
A.1	Guidelines and declarations .....	A-1
A.2	Certificates and approvals .....	A-2
A.3	Service and support .....	A-4
<b>B</b>	<b>ESD Guidelines</b> .....	<b>B-1</b>
B.1	ESD Guidelines .....	B-1
<b>C</b>	<b>Abbreviations</b> .....	<b>C-1</b>
C.1	Abbreviations .....	C-1
	<b>Glossary</b> .....	<b>Glossary-1</b>
	<b>Index</b> .....	<b>Index-1</b>



# Introduction

## 1.1 Preface

### Purpose of this document

These operating instructions contain all the information you need for commissioning and using the SIMATIC Box PC 627.

It is intended both for programming and testing personnel who commission the device and connect it with other units (automation systems, additional programming devices), as well as for service and maintenance personnel who install add-ons or carry out fault/error analyses.

### Scope of validity of this document

This documentation applies for all variations of the SIMATIC Box PC 627 and describes the delivery status as of May 2006.

### Its place in the information landscape

The operating instructions are available on the supplied "Documentation and Drivers" CD.

For further instructions on how to handle the software, please refer to the corresponding manuals.

### Conventions

The abbreviation Box PC or device is also used within this documentation for the product name SIMATIC Box PC 627.

### History

Currently released versions of these operating instructions:

Edition	Comment
03/2005	First Edition
11/2005	<ul style="list-style-type: none"><li>• Eliminating the Error</li><li>• Book mounting description</li></ul>
05/2006	<ul style="list-style-type: none"><li>• Error correction</li><li>• Windows XP Embedded</li></ul>

## 1.2 Guideline to the operating instructions

Contents format	Contents
Contents	Organization of the documentation, including the index of pages and chapters
Introduction	Purpose, layout and description of the important topics.
Safety information	Refers to all the valid safety-related aspects which are derived from statutory regulations and should be adhered to when installing, commissioning and operating the product/system.
Description	Fields of application, the features and the structure of the product/system
Application Planning	Aspects of storage, transport, environmental and EMC conditions to be considered in the preparatory stage
Installation	Product installation options and installation instructions
Connecting	Options of connecting the product and connection instructions
Commissioning	Commissioning the product/system.
Integration	Options of integrating the product into existing or planned system environments/networks
Functions	Monitoring and display functions
Expansions / Configuration	Procedure for expansion devices (memory, modules, drives)
Maintenance and service	Replacement of hardware components, restoring and setup of the operating system, installation of drivers and software
Troubleshooting	Problems, cause, remedy
Technical Data	General specifications in compliance with relevant standards and current/voltage values
Dimensional drawings	Dimensions of the device and of modules
Detailed descriptions	Structure, function and features of the vital components, allocation of system resources and use of the BIOS Setup
Appendix	Guidelines and certifications, service and support, notes on retrofitting
ESD Guidelines	General ESD guidelines.

# Safety Information

## 2.1 General safety instructions



---

**Caution**

Please observe the safety instructions on the back of the cover sheet of this documentation. You should not expand your device unless you have read the relevant safety instructions.

---

This device is compliant with the relevant safety measures to IEC, EN, VDE, UL, and CSA. If you have questions about the validity of the installation in the planned environment, please contact your service representative.

### Repairs

Only authorized personnel are permitted to repair the device.



---

**Warning**

Unauthorized opening and improper repairs can cause considerable damage to property or danger for the user.

---

### System expansions

Only install system expansion devices designed for this device. The installation of other expansions can damage the system and violate the radio-interference suppression regulations. Contact your technical support team or where you purchased your PC to find out which system expansion devices may safely be installed.

---

**Caution**

If you install or exchange system expansions and damage your device, the warranty becomes void.

---

2.1 General safety instructions

**Battery**

This device is equipped with a Lithium battery. Batteries may only be replaced by qualified personnel.



**Caution**

There is the risk of an explosion if the battery is not replaced as directed. Replace only with the same type or with an equivalent type recommended by the manufacturer. Dispose of used batteries in accordance with local regulations.



**Warning**

Risk of explosion and release of harmful substances!

Therefore, do not throw Lithium batteries into an open fire, do not solder or open the cell body, do not short-circuit or reverse polarity, do not heat up above 100° C, dispose of in accordance with regulations and protect against direct exposure to sunlight, moisture and condensation.

**ESD guidelines**

Modules containing electrostatic sensitive devices (ESDs) can be identified by the following label:



Strictly follow the guidelines mentioned below when handling modules which are sensitive to ESD:

- Always discharge your body's static electricity before handling modules which are sensitive to ESD (for example, by touching a grounded object).
- All devices and tools must be free of static charge.
- Always pull the mains connector and disconnect the battery before you install or remove modules which are sensitive to ESD.
- Handle modules fitted with ESDs by their edges only.
- Do not touch any wiring posts or conductors on modules containing ESDs.

## Description

### 3.1 Overview

The SIMATIC Box PC 627 is especially suited for industrial PC applications and delivers high processor performance in compact space:

- Compact design
- Expandable (2 PCI slots)
- High performance
- Rugged



SIMATIC Box PC 627

## 3.2 Areas of application

The SIMATIC Box PC 627 provides engineers building machines, plants and switch cabinets with a high performance, expandable PC platform for industrial application on the plant floor:

- Measurement, controlling and regulation of process and machine data, for example, for redundant process control systems and transport systems in production facilities
- Operating and visualization tasks with separate display / monitor solutions, for example, large-scale displays in automotive production
- Data logging and processing, for example, production data logging, distributed process control

The SIMATIC Box PC 627 has CE certification for use in the industrial sector as well as in residential and commercial areas, and small businesses. In addition to industrial applications, it can also be used in building services automation or in facilities open to the public.

## 3.3 Benefits

### Minimization of downtime through increased system availability

- Efficient self-diagnostics (SIMATIC PC DiagMonitor  $\geq$  V 2.1, optionally available)
- Solutions for data security (preventative data backups, Image Creator, optionally available)
- Service-friendly design (modifications, servicing)
- Additional hardware and software options (secondary hard disk or RAID1 configuration)

### Cost reductions through high investment security

- High product continuity through long-term secure functionality in hardware and software (support for Legacy interfaces)
- Secure replacement availability of the components (5 years)

### Reduced costs through high industrial functionality

- High industrial capability through extremely robust design, even against strong vibration and impact loads, and with high ambient temperatures (ventilation design)
- Totally Integrated Automation (TIA) components including integrated PROFIBUS/MPI interface (optional) and Ethernet interface, system-tested SIMATIC software package
- Sufficient flexibility and expandability (2 free slots) in the most compact space

### Cost minimization through time savings

- Configured, turn-key systems
- Preinstalled operating systems for fast commissioning
- Integrated interfaces for communication on the field or process control level

### 3.4 Function

- Integrated configurable monitoring functions (program execution (watchdog) for internal housing temperature, processor temperatures, disk drive temperatures and RPM of the two fans)
- Enhanced diagnostics / messaging via Ethernet, e-mail, SMS, and for direct input in SIMATIC software applications via OPC (optional via SIMATIC PC DiagMonitor  $\geq$  V 2.1):
  - Runtime meter
  - Hard disk status
  - System status (heartbeat)
  - Automatic logging of all messages by means of log file
  - Options for central monitoring of networked SIMATIC PCs
- RAID1 for automatic data mirroring on two hard disks

### 3.5 Features

Basic data	
Design	Panel mounting device, box
Processor	<ul style="list-style-type: none"> <li>• Celeron M 370 1.5 GHz, 400 MHz Front Side Bus (FSB), 1024 KB Second Level Cache or</li> <li>• Pentium M 730 / 760 1.6 or 2 GHz, 533 MHz Front Side Bus (FSB), 2048 KB Second Level Cache</li> </ul>
RAM	<ul style="list-style-type: none"> <li>• 128 MB SDRAM (DDR2)</li> <li>• Expandable up to 2 GB SDRAM (DDR2)</li> </ul>
Slots for add-ons	1x PCI 265 mm long 1x PCI 175 mm long
Graphic	<ul style="list-style-type: none"> <li>• Graphic memory 8 to 132 MB SDRAM (set in system BIOS), some using dynamic sharing of system RAM</li> <li>• VGA: 1600 x 1200 / 32-bit color depth / 85 Hz</li> <li>• DVI-I: 1600 x 1200 / 32-bit color depth / 60 Hz</li> </ul>
Power supply	<ul style="list-style-type: none"> <li>• 120 V / 230 V AC, 360 VA; varying voltage</li> <li>• 24 V, 265 VA DC</li> </ul> Both with bridging of transient loss of voltage according to NAMUR: max. 20 ms at 0.85 nominal voltage
Drives and storage media	
Hard disk drives	<ul style="list-style-type: none"> <li>• <math>\geq</math> 40 GB Serial ATA; 3.5" or</li> <li>• 1x 3.5" 80 GB hard disk or</li> <li>• 2x 2.5" 60 GB hard disk or RAID1 system</li> </ul>
DVD drive	<ul style="list-style-type: none"> <li>• DVD ROM or</li> <li>• DVD ROM/CD RW</li> </ul>
Flash drive	Slot for Compact Flash Card

Basic data	
<b>Interfaces</b>	
Ethernet	2x 10/100 Mbps (RJ45)
PROFIBUS / MPI	12 Mbps (isolated potential, compatible to CP 5611), optional
USB	External: 4x USB 2.0 high current (max. 2 can be simultaneously operated as high current) Internal: 1x USB 2.0 high current, 1x USB 2.0 low current Front panel ports: 1x USB 1.1, 1x USB 2.0, both high current
COM	Serial V.24 interface
Monitor	1x DVI-I (VGA monitors can be connected with supplied DVI/VGA adapter)

Optional accessories	
Book mounting bracket	For space optimizing installation in switch cabinet

Optional expansions	
SIMATIC PC DiagMonitor software ≥ V 2.2	Software tool for monitoring local and remote SIMATIC PCs: <ul style="list-style-type: none"> <li>• Watchdog</li> <li>• Temperature</li> <li>• Fan speed</li> <li>• Hard disk monitoring (SMART)</li> <li>• System / Ethernet monitoring (Heart Beat)</li> </ul> Communication: <ul style="list-style-type: none"> <li>• Ethernet interface (SNMP protocol)</li> <li>• OPC for integration in SIMATIC software</li> <li>• Client server architecture</li> <li>• Layout of log files</li> </ul>
SIMATIC PC Image Creator software	Software tool for saving data locally
PCI Multi-I/O module	Provides one parallel and one serial interface

Software	
Operating systems	<ul style="list-style-type: none"> <li>• Without</li> <li>• Preinstalled / supplied on restore CD/DVD:               <ul style="list-style-type: none"> <li>– Windows 2000 Professional SP4 MUI*</li> <li>– Windows XP Professional SP2 MUI*</li> <li>– Windows XP embedded SP2 English</li> </ul> </li> </ul> *MUI: Multi language User Interface; 5 languages (German, English, French, Spanish, Italian)



## 3.6 Windows XP Embedded

The overview shows the most important device functions under Windows XP Embedded:

Function	Compact Flash card version
Enhanced Write Filter (EWF)	In the RAM
Safecard on Motherboard (SOM)	Available
Pagefile	Not available
System Restore Core	Available
MUI	Not available
Administrator Account	Available
User Account	Available
Explorer Shell	Available
Internet Explorer (IE) 6.0	Available
Internet Information Server (IIS)	Available
Terminal Services	Available
Bluetooth	Available
Wireless Network Support	Available
Windows Firewall	Available
Windows Security Center	Available
MSN Explorer	Not available
Outlook Express	Available
Administrative Tools	Available
SMS Advanced Client	Not available
Remote Desktop	Available
Remote Assistance	Available
.NET Framework 1.1	Not available
ASP.NET 1.1	Not available
Windows .NET Messenger	Not available
Codepages/User Locale/Keyboard	Selection available
Disk Management Services	Available
Windows Installer Service	Available
Class Installer	Available
CoDevice Installer	Available
Windows Movie Maker	Not available
Media Player 9.0	Available
Windows Media Player Tour	Not available
DirectX	V9.0b
Accessories	Available
Help files for all components	Not available
Games	Not available
Fonts	120
Windows XP Tour	Not available

### 3.7 Design

#### 3.7.1 External structure

Front view		
	(1)	2 slots for expansion modules
	(2)	Cover for Compact Flash Card slot
	(3)	Front interfaces
	(4)	Power supply fan
	(5)	On / Off switch
	(6)	IEC connector for AC power supply or connection for 24 V DC

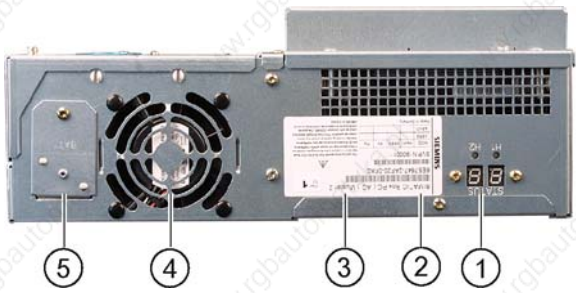
Rear view		
	(1)	Status display: Two part 7 segment display and two LEDs for POST code (optional)
	(2)	Steel cover plate for the operator panel interfaces
	(3)	Rating plate
	(4)	Equipment fan
	(5)	Battery compartment

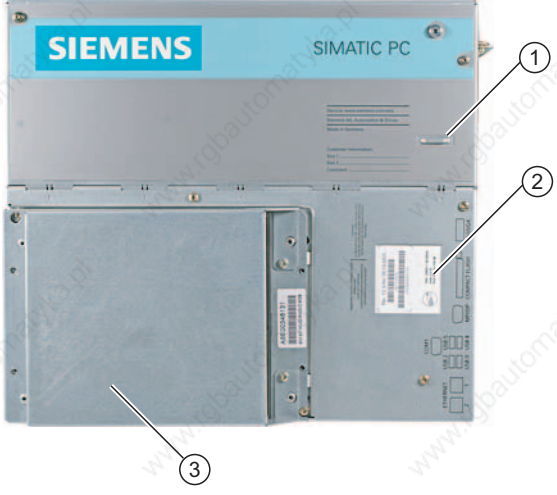
Side view (drive side)	
	(1) Mounting for WinAC backup battery (please use the supplied battery mount without cover for WinAC module)
	(2) Input data of the power supply
	(3) Drive mount module for hard disks and DVD ROM / CD-RW

Bottom	
	(1) Equipotential Bonding

### 3.7.2 Operator Controls

#### On / Off switch

On / Off switch	Description
	<p>The On / Off switch does not disconnect the device from mains. When the switch is in 0 position (Off), the device is still connected to the auxiliary voltage.</p>



#### Warning

The On / Off switch does not disconnect the device from mains.

### 3.7.3 Connection elements

#### Interfaces

Arrangement of the ports on the front of the device		
Pos	Description	Description
(1)	DVI/VGA	DVI/VGA connection for CRT or LCD monitor with DVI interface, VGA via DVI/VGA adapter
(2)	Compact Flash Card	Slot for Compact Flash Card
(3)	PROFIBUS/MPI/DP	MPI interface (RS485, electrically isolated), 9-pin Cannon socket
(4)	COM	Serial V.24 interface
(5)	USB 2.0	4 ports for USB devices (only 2 ports can be simultaneously used as high current)
(6)	ETHERNET	2x RJ 45 Ethernet connection for 10/100 Mbps

Interfaces for connecting operator panels / displays

Arrangement of the ports	
	(1) Retaining screw for the steel cover plate that covers the interfaces described below.
	(2) I/O interface for connecting front panel components
	(3) USB 2.0 for front
	(4) LVDS display interface for TFT displays up to 1024 x 768 pixels
	(5) Access to 2nd LVDS display interface for TFT displays up to 1280 x 1024

AC power supply

Position of the IEC power connector	Description
	IEC power connector for the AC power supply to the device. The maximum permitted power range is 120 V AC to 240 V AC.

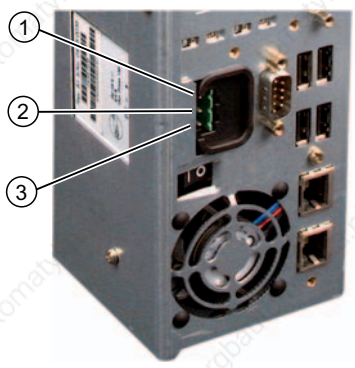

## DC power supply

Location of the DC power connector	Description						
 The image shows the rear panel of a SIMATIC Box PC 627. A DC power connector is located on the left side of the panel. Three callouts are present: (1) points to the positive (+) terminal, (2) points to the negative (-) terminal, and (3) points to the PI (Pulse In) terminal. Other connectors like RS-485 and Ethernet are visible to the right of the power connector.	DC power connector for DC power supply of the device <table border="1" data-bbox="802 443 1479 808"><tr><td>(1)</td><td>+</td></tr><tr><td>(2)</td><td>-</td></tr><tr><td>(3)</td><td>PI</td></tr></table>	(1)	+	(2)	-	(3)	PI
(1)	+						
(2)	-						
(3)	PI						





## Application Planning

### 4.1 Transport

Despite the device's rugged design, its internal components are sensitive to severe vibrations or shock. You must therefore protect the PC from severe mechanical stress when transporting it.

You should always use the **original packaging** for shipping and transporting the device.

---

#### Caution

##### Risk of damage to the device!

When transporting the PC in cold weather, it may be submitted to extreme variations in temperature. In this situation, ensure that no moisture (condensation) develops on or inside the device.

If condensation develops, wait at least 12 hours before switching on the device.

---

### 4.2 Unpacking and checking the delivery unit

#### Unpacking the device

Note the following points when you unpack the unit

- It is advisable not to dispose of the original packing material. Keep it in case you have to transport the unit again.
- Please keep the documentation in a safe place. It is required for initial commissioning and is part of the device.
- Check the delivery unit for any visible transport damage.
- Verify that the shipment contains the complete unit and your separately ordered accessories. Please inform your local dealer of any disagreements or transport damages.

### 4.3 Device identification data

The device can be identified uniquely with the help of these numbers in case of repairs or theft.

Enter the following data in the table below:

- Serial number: The serial number is found on the rating plate.

#### Rating plate

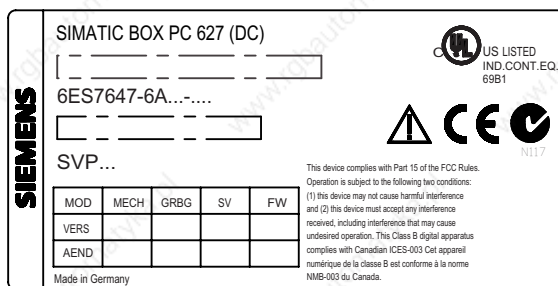

Figure 4-1 Rating plate

- Order number of the device
- Ethernet address: The Ethernet address of the device can be viewed in the BIOS Setup (F2) under Main > Hardware Options > Ethernet Address.
- Microsoft Windows "Product Key" from the "Certificate of Authenticity" (COA). The COA label is bonded to the device. The Product Key is always required to reinstall the operating system.

#### COA label

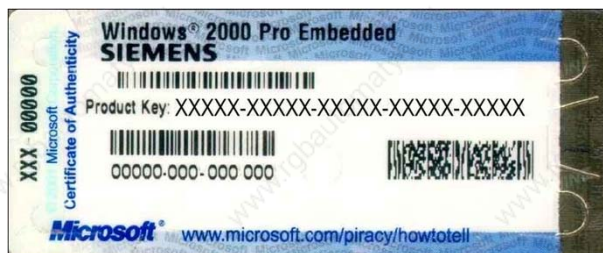

Figure 4-2 COA label

Serial number	S VP ...
Order no.	6ES ...
Microsoft Windows Product Key	
Ethernet address	

## 4.4 Ambient and environmental conditions

When you plan your project, you should make allowances for:

- The climatic and mechanical environmental conditions specified in the specifications given in your operating manual.
- At least 100 mm space should be left free around the ventilation slots, in order that the PC receives sufficient ventilation.
- Do not cover the vent slots of the device.
- The device together with its AC power supply fulfils the requirements for fire protected enclosures according to EN 60950-1. Therefore it can be installed without any additional fire protective covering.
- The device with DC power supply does not conform to EN 60950-1 in the area of its power supply connection; therefore the mounting must meet the requirements of a fire enclosure.
- Always observe the mounting positions permitted for this device.



---

### Warning

If the systems are installed in a non-permissible fitting position, the approvals pertaining to UL 60950-1, UL 508 and EN60950-1 are no longer valid!

---

## 4.5 Permitted mounting positions

Fitting positions of the PC according to UL60950-1/UL508/EN60950-1/CSA22.2 No. 60950-1

An inclination of  $\pm 20^\circ$  is permitted for all approved mounting positions.

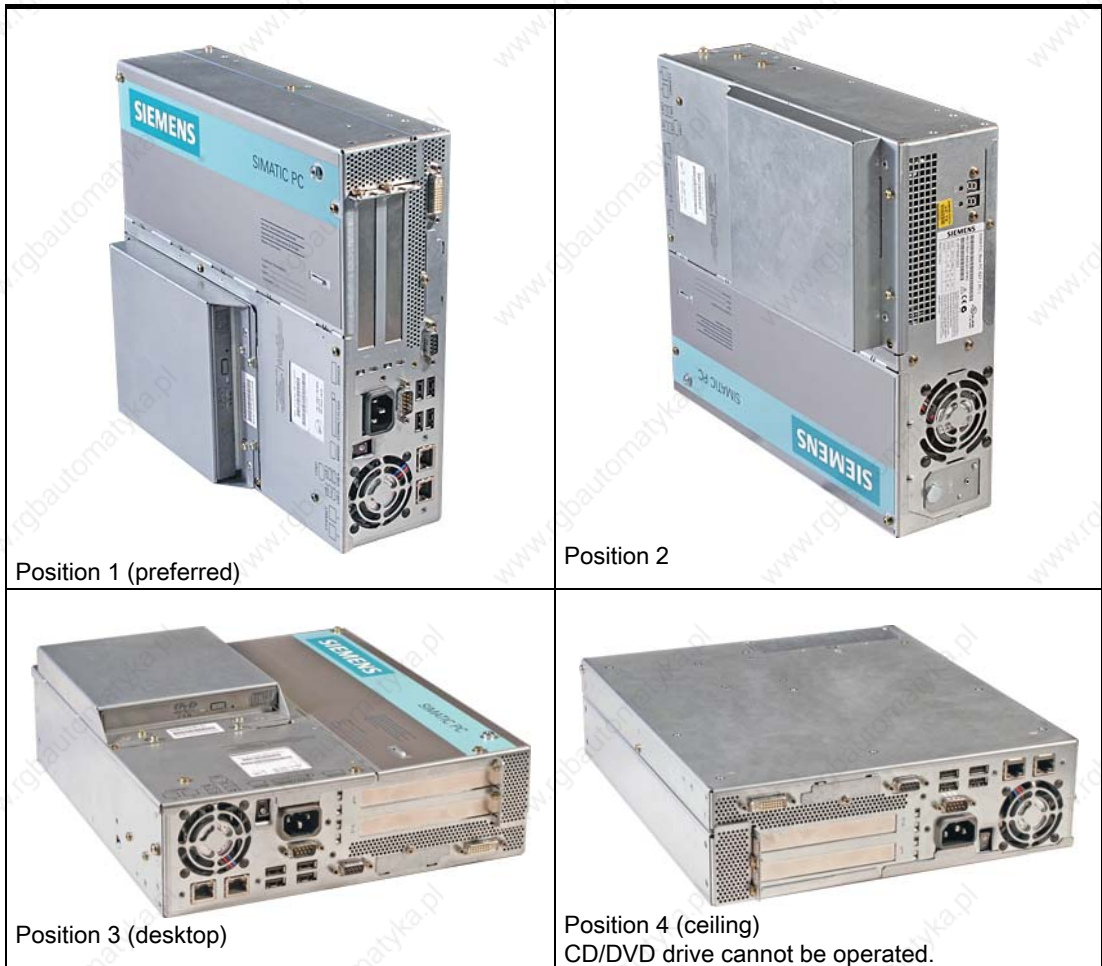

**Additional permissible PC mounting positions according to UL508/CSA 22.2 No. 142**

An inclination of  $\pm 15^\circ$  is allowed in this mounting position. An external fire protection casing is required.



**Note**

CD/DVD and floppy drives cannot be operated in this position. The CD drawer opens upward or downward which can lead to mechanical damages in the drawer mechanism.





# Installation

# 5

The device is particularly suitable for installation in consoles, switch cabinets and switchboards.



## Warning

### Function test while installing the device in machines or execute systems

Following the results of a risk analysis, additional protection equipment on the machine or the system is necessary to avoid endangering persons. With this, especially the programming, configuration and wiring of the inserted I/O modules have to be executed, in accordance with the necessary risk analysis identified safety performance (SIL, PL or Cat.). The intended use of the device has to be secured.

The proper use of the device has to be verified with a function test on the system. This test can detect programming, configuration and wiring errors. The test results have to be documented and if necessary inserted into the relevant inputs.

## 5.1 Installation of the device with mounting brackets

### Screw-mounting the brackets

Two brackets are included, depending on the device version. You can attach these to the PC housing using six M3 x 6 mm screws.

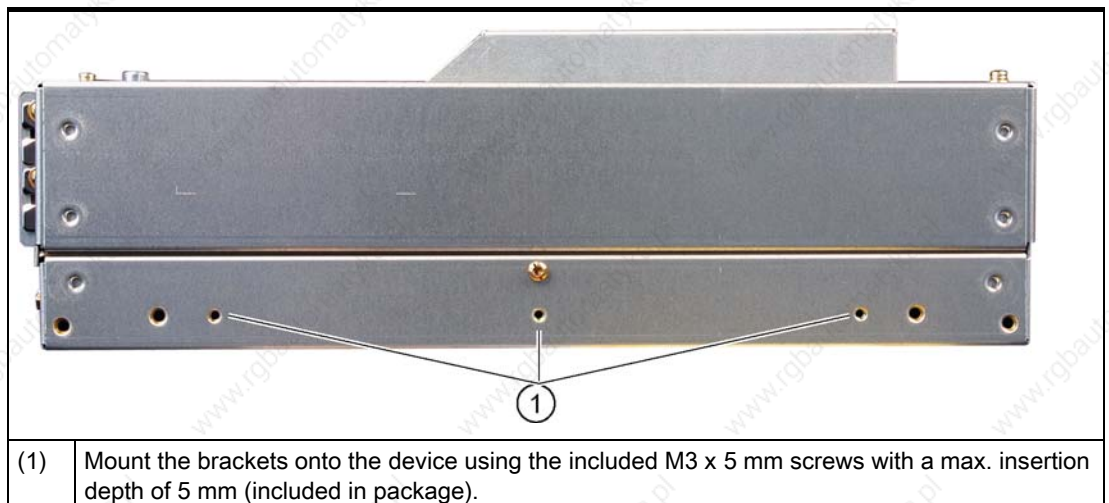

5.2 Installation of the device with the vertical mounting kit

Instructions for ceiling or wall mounting

Mounting examples		
Material	Hole diameter	Mounting
Concrete	8 mm diameter, 60 mm depth	Dowel: 8 mm, 50 mm screws 4 mm, 50 mm
Plasterboard (min. 13 mm thick)	14 mm diameter	Tilting dowel diameter 4 mm min. length 50 mm
Metal (min. 2 mm thick)	5 mm diameter	Metal screws diameter 4 mm min. length 15 mm



**Warning**

Ensure that the wall or ceiling is capable of carrying at least four times the total weight of the device (including the brackets and expansion modules). The total weight is approx. 7 kg.

5.2 Installation of the device with the vertical mounting kit

With the available optional vertical mounting kit you have the possibility to implement a place saving installation.



## Mounting the vertical mounting plate onto the device

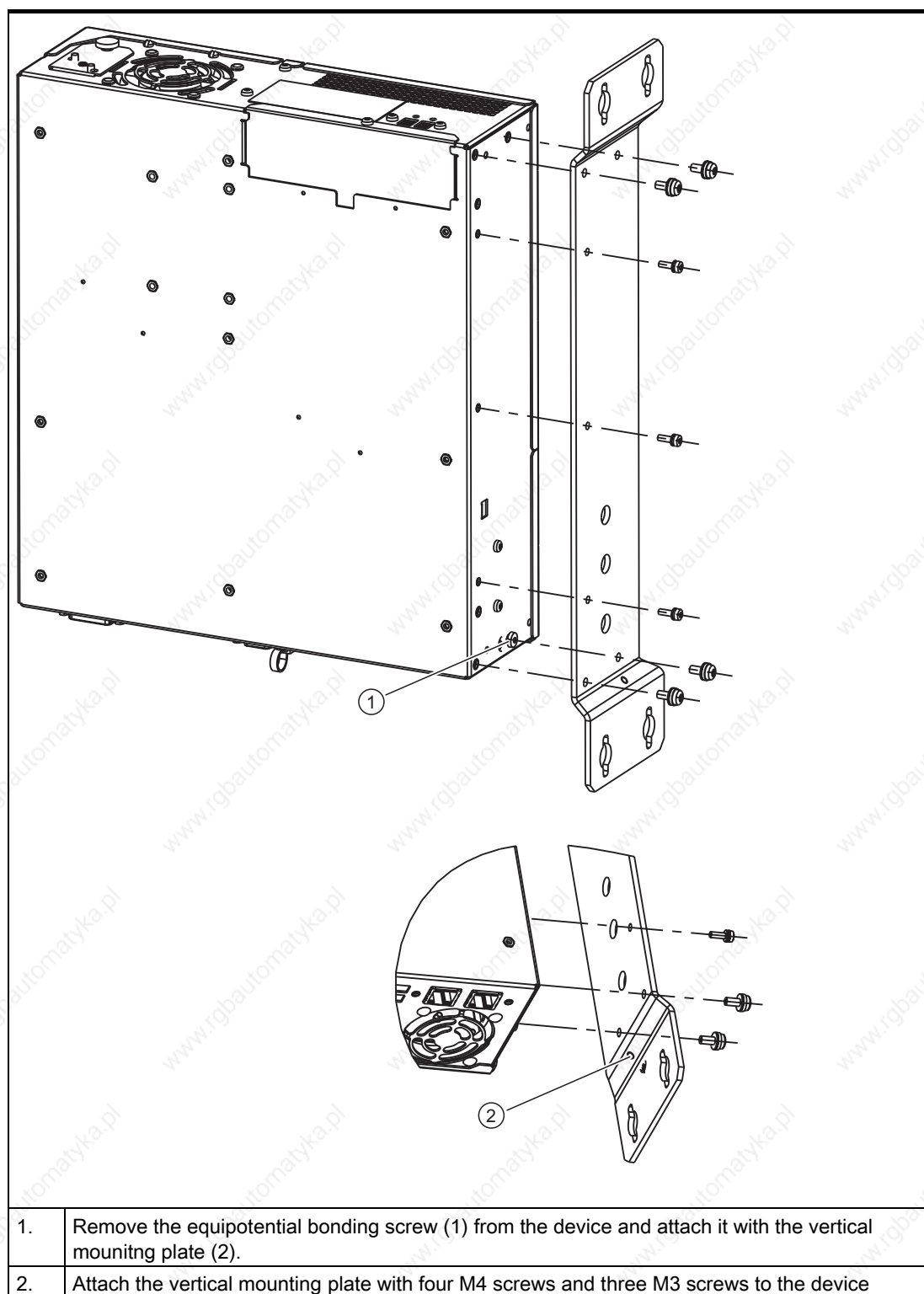

## *Installation*

---

### *5.2 Installation of the device with the vertical mounting kit*

---

#### **Note**

Please note the information on the permissible mounting position in the section "Permissible Mounting Positions"

---

## Connecting

### 6.1 Connecting peripherals

#### Note before connecting

---

**Notice**

Connect only I/O modules approved for industrial applications to EN 61000-6-2:2001.

---

---

**Note**

Hot-plug I/O modules (USB) may be connected while the PC is in operation.

---

---

**Caution**

I/O devices not capable of hot-plugging may only be connected after the device has been disconnected from the power supply.

---

---

**Caution**

Strictly adhere to the specifications for I/O modules.

---

## 6.2 Connecting the 120 V / 230 V Ac power supply

### To be noted before you connect the device

---

**Note**

The varying voltage power supply module is designed for operation on 120/230/240 V AC networks. The setting of the voltage range takes place automatically.

---

---

**Caution**

Do not connect or disconnect power and data cables during thunderstorms.

---

---

**Caution**

The device is designed for operation on grounded power supply networks (TN systems to VDE 0100, Part 300, or IEC 60364-3).

It is not designed for operation on ungrounded or impedance-grounded power networks (IT networks).

---

---

**Caution**

The permitted nominal voltage of the device must conform with local mains voltage.

---

---

**Caution**

The mains connector must be disconnected to fully isolate the device from mains. Ensure easy access to this area.

A master mains disconnect switch must be installed if the device is mounted in a switch cabinet.

Always ensure free and easy access to the power inlet on the device or that the safety power outlet of the building installation is freely accessible and located close to the device.

---

---

**Note**

The power supply contains an active PFC (Power Factor Correction) circuit to conform to the EMC guidelines.

Uninterruptible AC power systems (UPS) must supply a sinusoidal output voltage in the normal and buffered mode when used with SIMATIC PCs with an active PFC.

UPS characteristics are described and classified in the standards EN 50091-3 and IEC 62040-3. Devices with sinusoidal output voltage in the normal and buffered mode are identified with the classification "VFI-SS-...." or "VI-SS-....".

---

## Localized information

### Outside of the USA and Canada, operation on a 230 V power supply:

This device is equipped with a safety-tested power cord which may only be connected to ground contact power outlet. If you choose not to use this cable, you must use a flexible cable of the following type: Min 18 AWG conductor cross-section and 15-A / 250-V shockproof connector. The cable set must be compliant with the safety regulations and stipulated IDs of the country where the system is to be installed.

### For the USA and Canada:

For the United States and Canada, a CSA or UL-listed power cord must be used.

The connector must be compliant with NEMA 5-15.

### 120 V AC power supply

To be used is a flexible power cord approved to UL and with CSA label, and which has the following features: Type SJT with three leads, min. 18 AWG conductor cross-section, max. 4.5 m in length and parallel ground contact connector 15 A, min. 125 V.

### 240 V supply voltage

Use a flexible power cord with UL approval and with CSA label, and with the following features: Type SJT with three leads, min. 18 AWG conductor cross-section, max. 4.5 m long and tandem ground contact connector 15 A, min. 250 V.

## Connection

How to connect the device to the 120 V AC / 230 V AC power supply	
1.	Make sure that the ON / OFF switch is in "0" position (Off) when you plug in the power cord in order to avoid unintentional startup of the device.
2.	Connect the IEC connector
3.	Connecting the power cord to the power socket



### 6.3 Connecting the (24 V) DC power supply

#### Note before connecting



#### Warning

Only connect the device to 24 V DC power supply systems which meet the requirements of a safe extra-low voltage (SELV); in addition, a protective conductor must be connected. The conductors must withstand the short-circuit current of the 24 V DC power source, so that a short-circuit will not damage the cable. Only connect cables with a minimum cross-section of 1.3 mm<sup>2</sup> (AWG16) and a maximum cross-section of 3.3 mm<sup>2</sup> (AWG12).

#### Notice

The 24V DC power source must be adapted to the input data of the device (see specifications).

#### Connecting

Steps for connecting the device to the 24 V DC power supply	
1.	Ensure that the ON/OFF switch is in the '0' (OFF) position to prevent unintentional startup of the device when connecting it to the 24 V power supply.
2.	Switch off the 24 V DC power source.
3.	Insert the DC power plug. (1) 24 V DC (2) ground (3) protective conductor

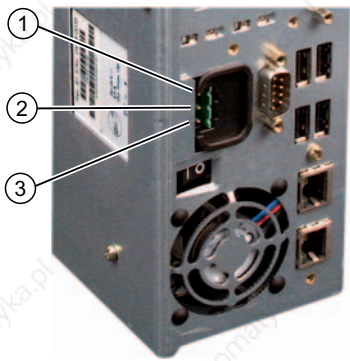

## 6.4 Connecting the equipotential bonding circuit

A low-impedance earth connection ensures that interference signals generated by external power supply cables, signal cables or cables to the I/O modules are safely discharged to earth.

### Equipotential bonding terminal

The equipotential bonding terminal on the device (large surface, large-area contact) must be connected with the central grounding busbar of the cabinet or plant in which the PC is to be installed. The minimum conductor cross-section may not be less than 5 mm<sup>2</sup>.



*Connecting*

*6.4 Connecting the equipotential bonding circuit*

---



## Commissioning

### 7.1 Requirements for commissioning

- Connect the peripherals, such as the keyboard, mouse, monitor and the power supply, before putting the device into operation.
- The operating system of your device is preinstalled on the hard disk.

---

**Caution****Risk of damage to the device!**

Make sufficient allowances for the device to acquire room temperature before you put it into use. If condensation develops, wait at least 12 hours before switching on the device.

---

### 7.2 Basic commissioning - initial startup

The PC operating system is automatically set up the **first** time you switch on the device.  
Procedure:

1. Set the ON / Off switch to I position (On). The PC performs a POST. During the self-test, this message appears:

Press <F2> to enter SETUP or <ESC> to display the boot menu
---

2. Wait until this message is cleared, then follow the instructions on the screen.
3. Type in the Product Key as required. You find this key on the "Certificate of Authentication", in the "Product Key" line.

---

**Notice**

The PC may not be switched off when you run setup.

**Do not** change the default BIOS settings, otherwise the operating system setup may become corrupted.

---

4. Automatic restart

After you have entered all necessary information, and after the operating system setup is completed, the PC is automatically restarted and displays the user interface of the relevant operating system.

From now on, after you switch on the PC, the user interface of the operating system is automatically opened when the startup routine is completed.

## 7.3 Windows XP Security Center

### Warning from the Windows Security Center

A warning from the Windows Security Center appears the first time you switch on your device. The Security Center checks the status of the device in regard to the three important security aspects listed below. If a problem is detected (an outdated antivirus program, for example), the Security Center issues a warning and makes recommendations on how you can better protect the device.

- **Firewall:** The Windows Firewall adds protection to the device by blocking network or Internet access to the device by unauthorized users. Windows checks if the device is protected by a software firewall.  
The firewall is enabled by default in the factory state.
- **Antivirus software:** Antivirus programs add protection to the device by searching for and eliminating viruses and other security threats. Windows checks if a full-range, up-to-date antivirus program is running on the device.  
No antivirus software is installed in the factory state.
- **Automatic updates:** Using the Automatic Update feature allows Windows to regularly search for the latest critical updates for the device and to install them automatically.  
This feature is disabled in the factory state.

Configure the Security Center according to your requirements.

## 7.4 Switching off the device

### Switching off the device

---

#### Note

On a Windows platform, you should always shut down the PC by selecting the command **Start > Shut Down**.

---

Set the ON / Off switch to 0 position (off.) Disconnect the mains connector to isolate the device from mains.

## 7.5 Notes on operation

### 7.5.1 DVD ROM/CD RW

The DVD-ROM/CD-RW drive is an optional feature. Recording methods supported by the disk drive: Disc at once, Track at once, Session at once, Packet writing, whereby Disc at once and Track at once are recommended due to their compatibility to other optical drives. DVD-ROM, CD-ROM, CD-R and Video CDs can be read.

#### Burner/DVD player software

To utilize the full functionality of our DVD-ROM/CD-RW drive, you need to install additional software (burning or DVD player software). This software is included on the CD supplied with the device. Insert the CD in the drive, run setup and follow the instructions on the screen.

#### Information on burning CD-Rs/CD-RWs

---

##### Caution

##### Data may be corrupted when burning CD-R or CD-RW!

Burning is permissible only in an undisturbed environment, i.e. shock and vibration stress must be avoided. Because of heavy fluctuation in the quality of CD-Rs, data may be corrupted in a burning session, even if no error message is initially displayed. The written data can only be verified by comparing these with the source. To be on the safe side, data should be verified after every burning session. When backing up an image, the data should be restored to the hard disk and the system should be rebooted from the hard disk.

---

### 7.5.2 2HDD/RAID system (optional)

The two hard disks are configured as follows in the factory state of the computer:

Hard disk 0	Hard disk 1
Partition C: System, NTFS, 10 GB	Not configured
Partition D: System, NTFS, remaining capacity	

You can use the two hard disks as a 2 HDD system or as a RAID system.

### 7.5.2.1 2 HDD system

Two 2.5" hard disks are installed in the device depending on the device features. The two hard disks are connected to the SATA ports 0 and 2. The hard disk on SATA port 2 is not configured. This gives you the option of backing up your data to this hard disk. For information on hard disk capacities, refer to your order documentation.

#### Booting from the slave hard disk

The system boots by default from the hard disk on SATA port 0. You can also configure the system to boot from the disk on SATA port 2.

In order to allow booting from the second hard disk, you need to configure it as the primary boot device. Make the following settings in your BIOS Setup:

Select Boot > Hard Drive > <Drive name> e.g. FUJITSU MHT2060BH - SATA2, then press the "+" key to move it up in the boot order.

---

#### Notice

The drive letters for the partitions on both drives are assigned by the operating system used. You can change these in the Control Panel as required.

---

### 7.5.2.2 RAID system

#### RAID 0 system

A RAID 0 system (Stripe) enables you to increase the read/write speed of your hard disk system. This configuration reduces the reliability of the drive system, however. RAID 0 is therefore not recommended and is omitted from the installation instructions.

#### RAID 1 system

A RAID 1 system (mirroring) enables you to increase the data security of your hard disk system. It involves copying (mirroring) the data to a second hard disk.

Each hard disk is operated on a separate SATA channel. The system can continue to operate even when a problem is detected on one of the hard disks. The data backed up on the RAID1 network is retained. This data would be lost on a single drive or without RAID1. RAID1 therefore increases the availability of the system.

## Configuring a RAID1 system

### Requirements:

Two identical SATA hard disks; the primary hard disk contains the operating system and data (boot drive), the second is empty.

The default pre-installed operating systems Windows XP or 2000 already include the required drivers and the RAID software (Intel Matrix Storage Manager).

If the primary hard disk does not have an operating system installed, follow the instructions provided by the section "Restoring the Factory State of the Software Using the Restore DVD".

### Setup:

1. Change the following setting in the BIOS Setup:  
Menu Advanced > SATA Configuration > RAID support = Enabled
2. Restart the device (**Steps 2. and 3. are not required as of BIOS version V 05.01.05**).
3. Also change this setting:  
Menu Boot > Set SCSI/RAID to desired position

---

### Notice

Do not change the setting in the RAID option ROM. The configuration of the RAID systems is made entirely in the supplied program, "Intel Application Accelerator".

---

4. Restart the system.
5. Install the "Intel Matrix Storage Console" application and run it.
6. Select from View > Advanced Mode and then in Actions, select the Option "Create RAID Volume from Existing Hard Drive".

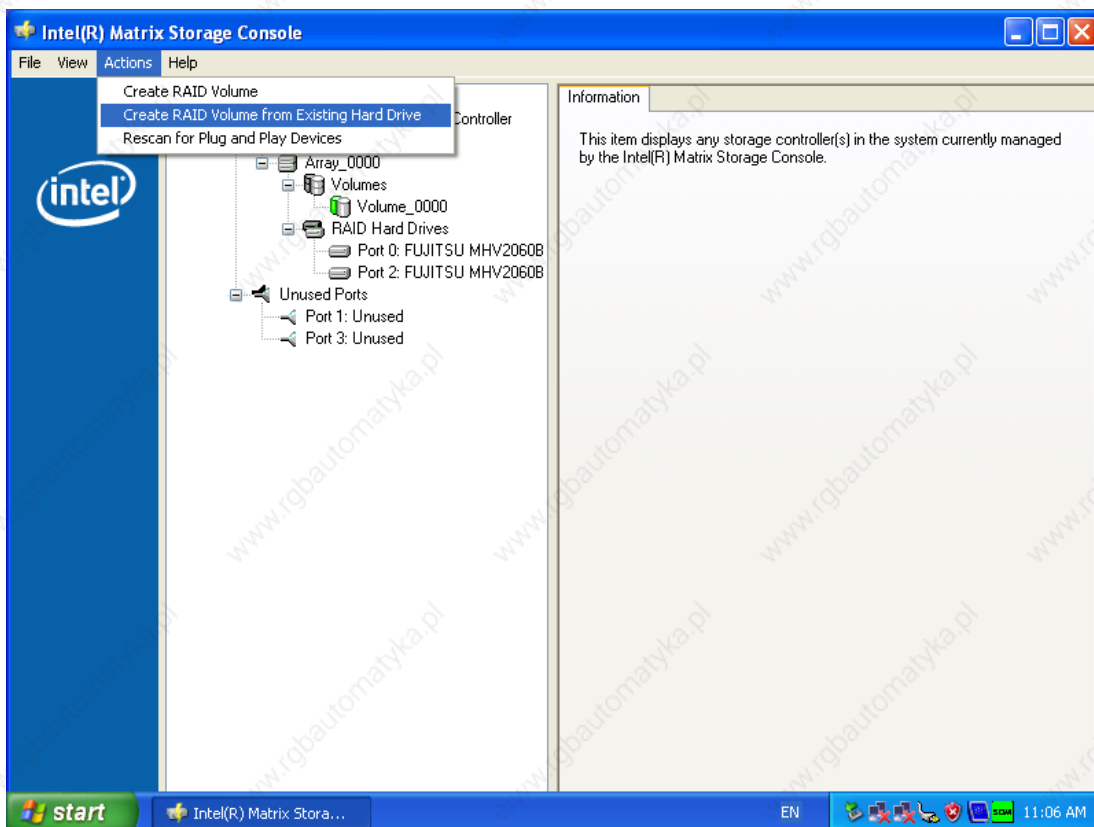

7. In the subsequent dialog, select RAID 1 (Mirroring) and enter a name for this configuration.



- Now select the hard disk to be used in the RAID 1 system. This is usually the hard disk containing the operating system (default: Port 0). This hard disk is used as the source and its data will later be mirrored to the partner drive.



- Now select the partner drive where the data should be mirrored. This is usually an empty hard disk (default: Port 2).



- Select "Finish" and the RAID system is created.

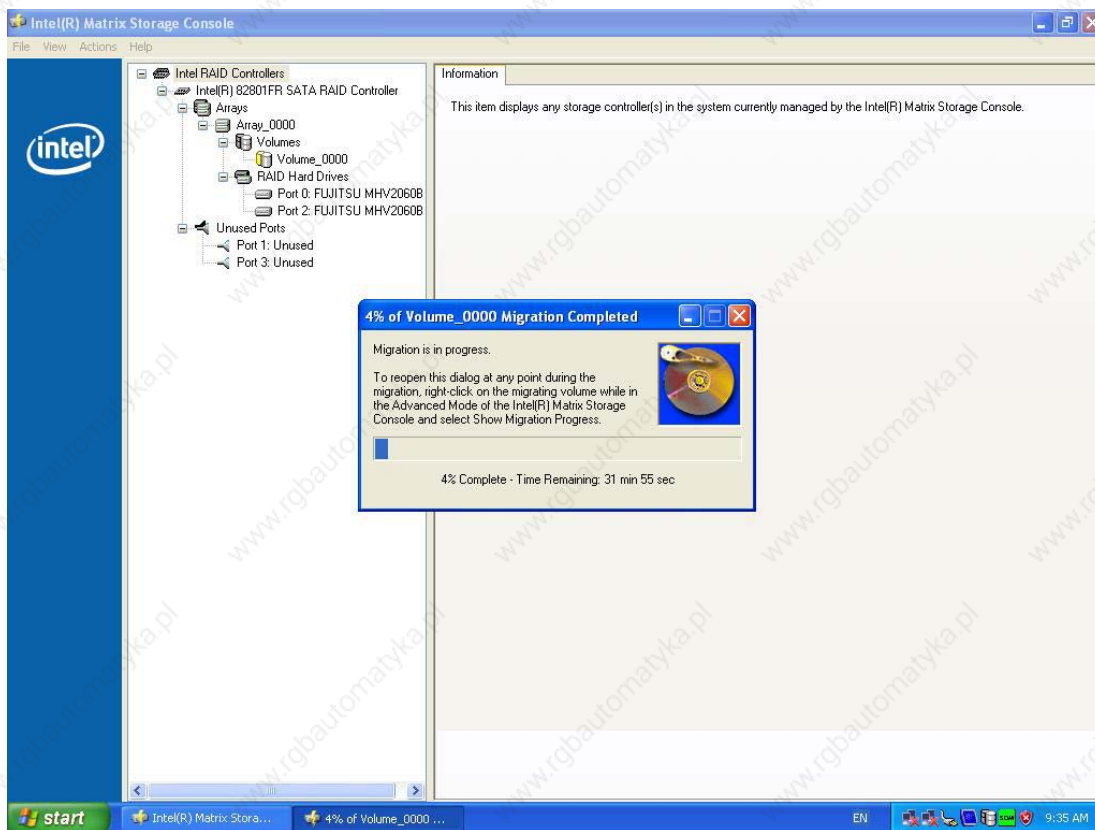

The data on the hard disk specified as the source drive will now be copied to the partner drive. The time required to copy the data (migration) depends on the capacity of the hard disk and may take approximately 45-90 minutes. The device can continue to operate during the copy process although at a reduced speed. The data mirroring first goes into effect when the copying process is successfully completed. The device will then be operating in the specified RAID 1 mode and the data will be saved on both hard disks.

---

**Note**

Information about the operation of the RAID system can be found in the RAID user manual on the supplied SIMATIC PC Documentation and Drivers CD.

---

**Notice**

The security functions of the RAID system take effect without starting the RAID software. The RAID status is always indicated in the Windows status bar.

In the event of an error, a hard disk can be duplicated by means of the RAID Controller BIOS or on the operating system level. It may take up to several hours to synchronize a new disk in the background, depending on the size of the hard disk and on the system load.

The redundant system state RAID 1 is reached again only after synchronization is completed.

---



### Comments about faults

Should a drive fail, the "Intel Matrix Storage Console" application will output a message.

This message is recorded in the log file of this program and in the event display of the Windows operating system.

---

#### Notice

##### Input delay

Depending on the load on the processor and the hard disk activity at the time, the system may become briefly overloaded when a disk fails due to the synchronization process.

In extreme cases, input from the keyboard and touchscreen may be delayed for a brief period.

---

#### Notice

##### BIOS messages during startup

At the first restart / cold start following a hard disk failure or installation of a new hard disk (servicing), the RAID BIOS reports that the RAID functionality is no longer available and offers the appropriate operator options.

---

#### Notice

The "SIMATIC PC DiagMonitor" diagnostics and alarm software also provides information about the RAID status. This software only needs to be installed once - logons are not required. The "SIMATIC DiagMonitor" diagnostics and alarm software is available as an accessory under the order number, 6ES7648-6CA02-0YX0.

### Notes for RAID configuration with installed SIMATIC PC DiagMonitor software

When creating a RAID-system where SIMATIC PC DiagMonitor software is being used, the Intel Matrix Storage Console may abort the process with the following error message:

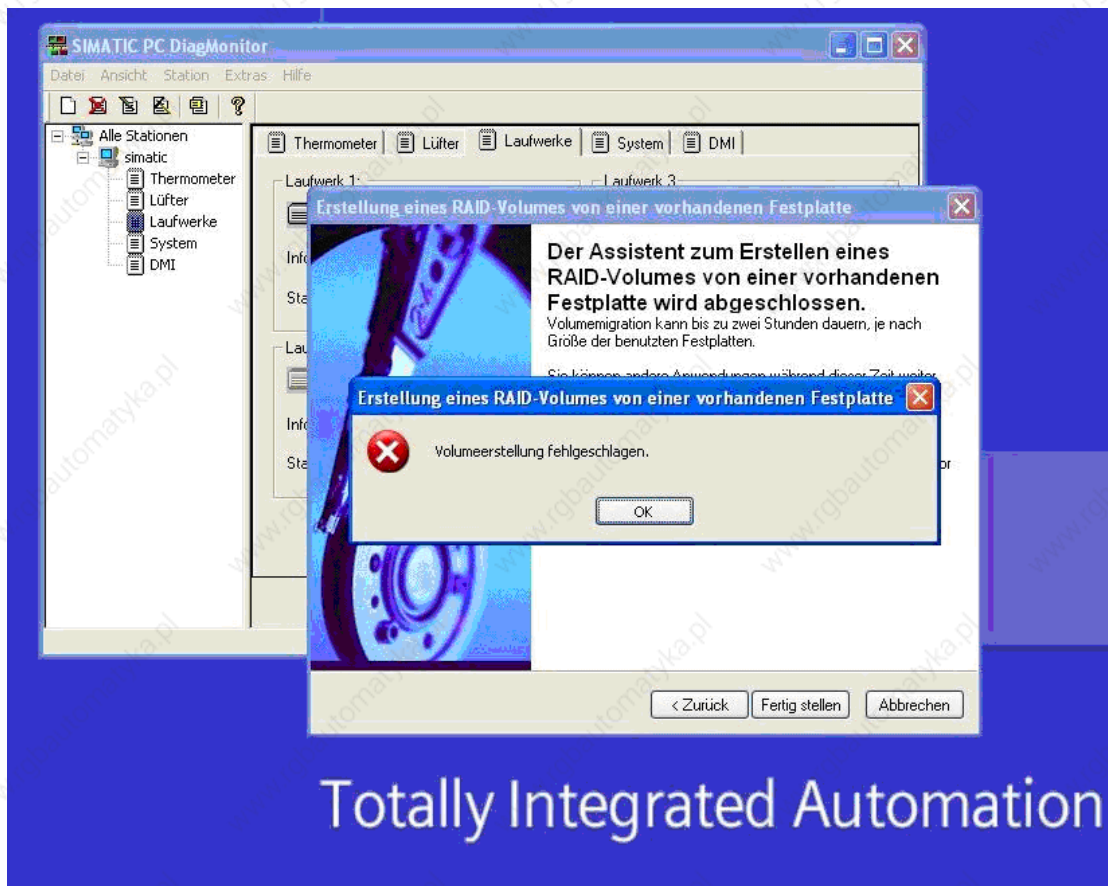

**Solution:**

Before performing a RAID commissioning, the SIMATIC PC DiagMonitor should be deactivated. Subsequently, it can be reactivated.

**Measures:**

**If the DiagMonitor Management Station is in operation on your device:**

- Close all applications, also the Management Station.
- Afterwards, stop the DiagMonitor SNMP Agent (SOL-Agent). In order to do so, select **Start > Run** and enter `cmd` in the field.
- Afterwards, enter `Net stop snmp` and confirm with the Enter key.

**If your device is remotely monitored with SIMATIC PC DiagMonitor:**

In this case you need **only** stop the DiagMonitor SNMP Agent (SOL-Agent).

- In order to do so, select **Start > Run** and enter `cmd` in the field.
- Afterwards, enter `Net stop snmp` and confirm with the Enter key.

**Notice**

Should the above procedure not be adhered to, a successful RAID configuration cannot be guaranteed.

## Integration

The following options are available for the integration of the device in existing or planned system environments/networks:

### Ethernet

The integrated Ethernet port (10/100 Mbps) can be used for communication and for data exchange with automation devices such as SIMATIC S7.

To this purpose you require the software package "SOFTNET S7".

### PROFIBUS / MPI

The optional potentially isolated Profibus interface (12 Mbps) can be used to interconnect distributed field devices or to carry out coupling to the SIMATIC S7.

To couple the device to an S7 PLC, you need the software package "SOFTNET for PROFIBUS".

### Further information

For further information, refer to the catalog and to the online ordering system of Siemens A&D.

Internet address: <http://www.mall.automation.siemens.com>



## Functions

### 9.1 Overview

The following individual functions are implemented:

- Temperature monitoring and over/under temperature indication
- Watchdog
- Fan monitoring

Messages can be output from the monitoring modules to the applications.

The SOM software (Safecard On Motherboard) and DiagMonitor software on CD (optional) are available for this.

The DiagMonitor software CD contains the monitoring software, the software for the stations to be monitored, and a library for creating user-specific applications.

The description of the driver and SOM program are available on the CD "Documentation and Drivers" under **Drivers & Updates\<device>\...**

### 9.2 Temperature monitoring

#### Temperature monitoring

The temperature is recorded by means of three thermocouples. One thermocouple monitors the processor temperature, another the temperature in the area near the power supply, and a third the air intake temperature next to the DVI interface.

When the temperature is out of the range of one of the three set temperature thresholds, the following error reactions are triggered:

Reaction	Option
Device and CPU fans accelerate to maximum speed.	None
SOM or DiagMonitor- software is activated	None

The temperature error is retained until the temperatures have fallen below the thresholds and are reset by one of the following measures:

- Error acknowledgement in the SOM program (manually by means of the broom icon)
- Restart of the device.

## 9.3 Watchdog (WD)

### Function

The watchdog monitors the program execution and reports a program crash to the user by means of various reactions.

The watchdog is idle when the PC is switched on or after a HW-RESET (cold restart), i.e., no reaction of the WD is triggered.

### WD reactions

If the WD is not triggered again within the set time (by driver or SOM program), the following reactions are initiated:

Reaction	Option
WD acknowledgement	None
Trigger a PC reset	Configurable
SOM or DiagMonitor- software is activated	None

### WD monitoring times TWD

The TWD are adjustable in increments of one second in a range from 3 to 255 seconds.

#### Note

If the watchdog time is changed after the watchdog was enabled (i.e., while the watchdog is running), the watchdog is retriggered!

## 9.4 Fan monitoring

The function monitors operation of the enclosure and power supply fans. When a fan fails, the following reactions are triggered:

Response	Option
SOM or DiagMonitor software is activated	None

The temperature error is retained until the cause of the fan failure has been rectified and the error is reset in one of the following ways:

- Acknowledgement of the error message by means of the SOM program
- Restart of the device

## 9.5 Safecard on Motherboard (SOM)

This application is used to monitor PC hardware (temperature, watchdog and fans) and to display the current measured values. A GUI is used to configure the application and also to activate the temperature monitoring watchdog function and fan monitoring function.

Your device is equipped with three temperature sensors, which are automatically detected by the application.

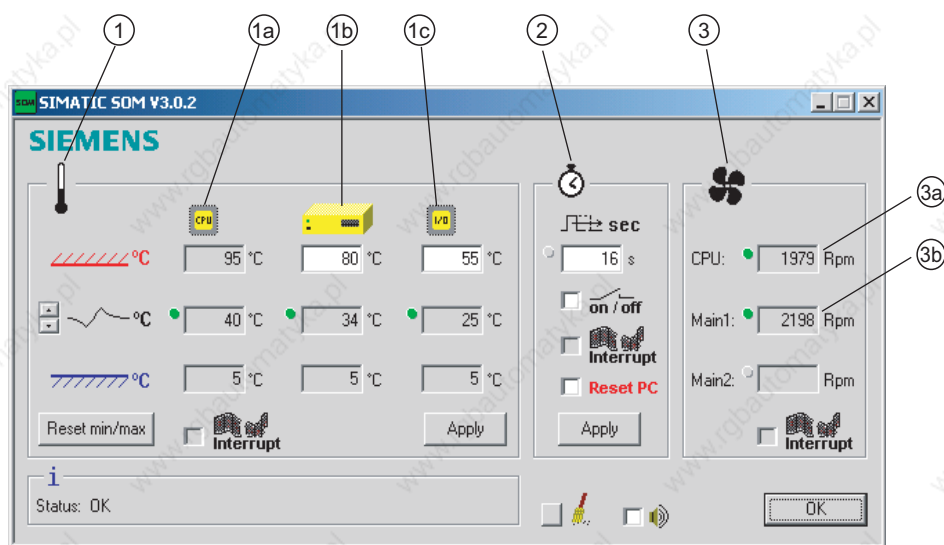

Figure 9-1 Safecard On Motherboard with three temperature sensors

(1)	Temperature range	Here the current temperature and limit values are shown. You can toggle the temperature display mode to indicate either the current temperature, or the min./max. values measured since the start of the application.
		(1a) Internal processor temperature
		(1b) Device temperature beneath the power supply: upper threshold can be set from 30°C to 80°C
		(1c) Cooling air temperature surrounding the DVI connector: - depending on device 3°C to 5°C higher than the ambient temperature - upper threshold can be set from 25°C to 55°C
(2)	Watchdog range	Here, you can configure the watchdog function in your monitoring application. You can specify the watchdog time, activate a PC reset and activate / deactivate the watchdog.
(3)	Fan area	You can read the current fan speed in this area.
		(3a) Fan speed in the area close to the processor
		(3b) Fan speed on the power supply

The description of the driver and SOM program are available on the CD "Documentation and Drivers" under **Drivers & Updates\<device>\...**

From the CD, run **Install.bat** and follow the instructions on your screen.

## 9.6 Status display

The status display consists of two 7-segment displays with two dual-color LEDs.

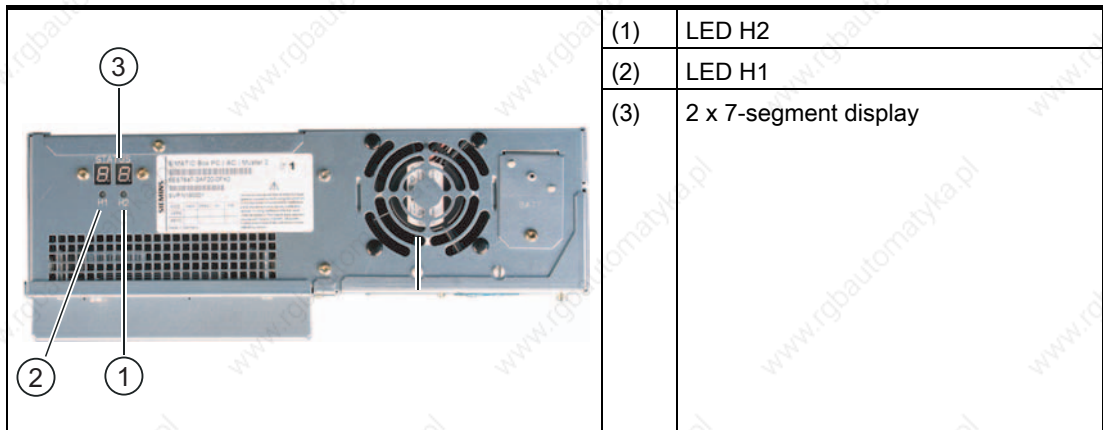

### Function of the 7-segment displays

The POST codes of the respective test step are displayed during the startup of the BIOS. The POST code of the most recently started test step is displayed should an error occur. Code 00 is displayed when the startup is completed without error.

Application codes can also be displayed if required.

### Function of the LED H1, H2

During the BIOS startup, the two LEDs light up in two colors (red and green) in order to test their operation. The two LEDs switch off when the startup is completed without errors.

Applications can trigger the two LEDs if required.

#### Note

You will find the documentation for the SIMATIC LED-status monitor on the Documentation & Drivers CD under Documentation > SIMATIC Box PC 627.



## Expansions and configuration

### 10.1 Opening the Device

---

**Caution**

Work on the open device may only be carried out by authorized and qualified personnel. Within the warranty time, you are only allowed to install expansions for memory and expansion card modules.

---



---

**Caution**

**The device contains electronic components which may be destroyed by electrostatic charge.**

You therefore need to take precautionary measures before you open the device. Refer to the (ESD) directives for handling components which are sensitive to electrostatic charge.

---

**Tools**

All mechanical installation tasks on the device can be carried out with Torx T6, T10 and T25 screwdrivers.

**Preparation**

Disconnect the device from mains.

10.1 Opening the Device

Open the device up

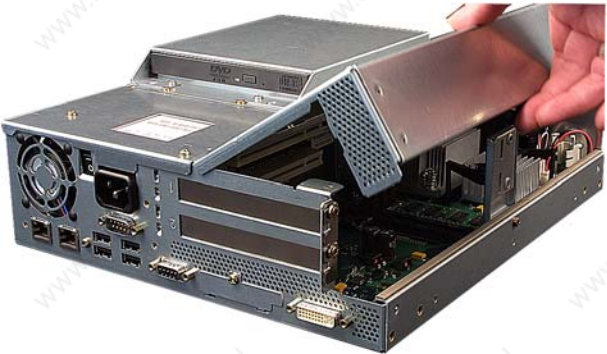
Steps for opening the device	
1 Unscrew 2 screws (1).	
2 Swing the cover up and remove it.	

## 10.2 Memory expansion

### 10.2.1 Removing/Installing Memory Module

#### Memory expansion options

The motherboard is equipped with 2 slots for memory modules. For 184-pin DDR2 RAM chips, unbuffered, no ECC. This allows you to expand the memory capacity of your PC to a maximum of 2 GB. One or two modules can be installed.

Combination	Slot X1	Slot X2	Maximum expansion
1	256/512 MB /1 GB		1 GB
2	256/512 MB /1 GB	256/512 MB /1 GB	2 GB

---

#### Note

The modules can be installed in any slot.

---

#### Preparation

Disconnect the device from mains and unplug all cables.

---

#### Caution

The electronic components on the PCBS are highly sensitive to electrostatic discharge. It is therefore vital to take precautionary measures when handling these components. Refer to the directives for handling electrostatic sensitive components.

---

### Installing a memory module

How to install a memory module	
1	Open the device
2	Note where the (polarized) cutout is on the pin side of the RAM chip before inserting it
3	Push the module carefully into the slot until the interlocks engage
4	Close the device.

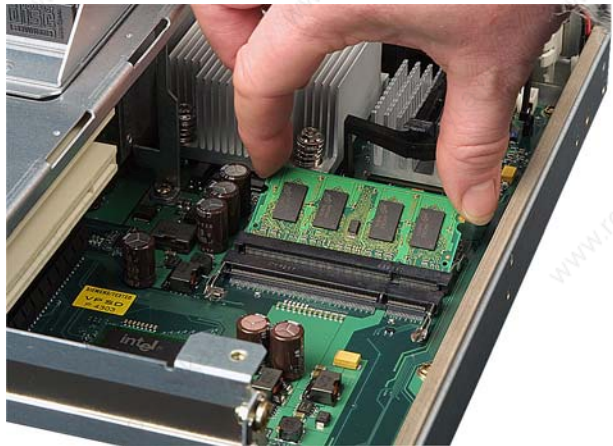

## Removing a memory module

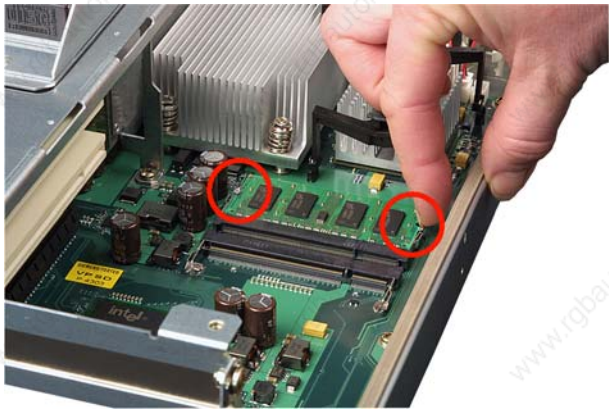
How to remove a memory module	
1	Open the device
2	Open the left and right interlocks
	
3	Pull the memory module out of the slot
4	Close the device.

## Display of the current memory configuration

A new memory module is automatically detected. The allocation of the "base memory and extended memory" is automatically displayed when you switch on the device.

## 10.3 Installing PCI expansion cards

### 10.3.1 Notes on the modules

The device is designed for use with modules conforming to PCI specifications V 2.2. PCI modules with 5 V and 3.3 V supply voltage can be operated. The permitted dimensions of the modules are found in the dimensional drawings section.

### 10.3.2 Installing / removing expansion modules

#### Preparation

Disconnect the device from mains.

#### Installing expansion modules

How to install an expansion module (PCI):	
1	Open the device.
2	1 Remove the fastening screws (1) and lift out the module bracket (2).
3	Remove the relevant steel slot cover (5).
4	Insert the expansion module (4) into the relevant slot. Pay attention to the guide rail (6) when using long PCI modules.
5	Install the module bracket and insert the slider (3).
6	Screw down the steel slot cover (5) for the expansion module.
7	Close the device.

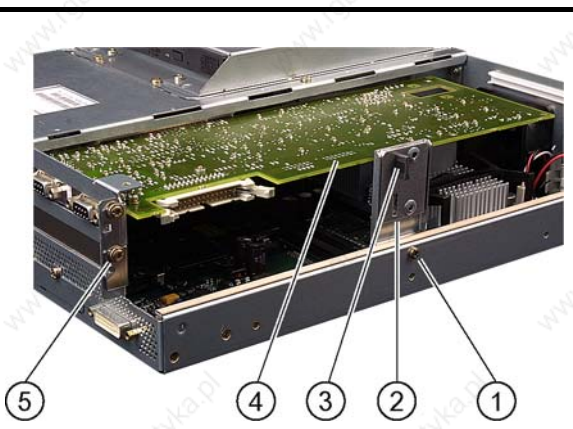



## Inserting the slider

To insert the slider:

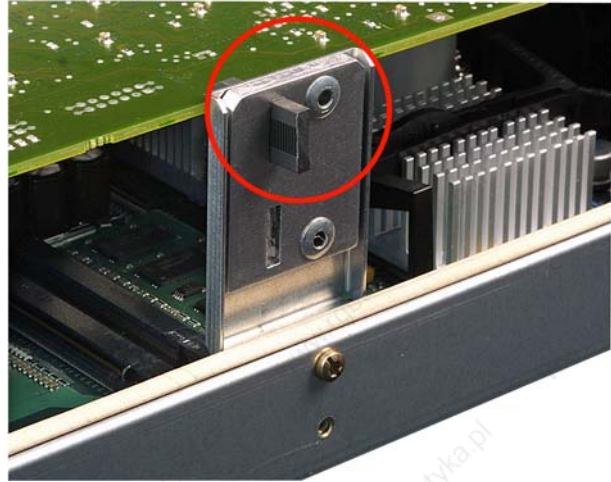
How to install a slider	
1	<p>Push the slider through the guide slot until it is seated firmly on the module. Insert the module into the slot.</p> 

### Caution

No pressure should be applied to the module! Therefore, do not apply excessive force to the slider when you push it onto the module.

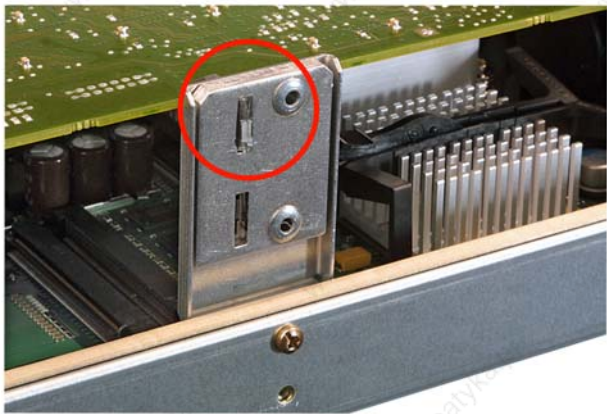
2	<p>Cut off the rest of the slider: Use a knife to notch the slider at the upper edge of the bracket and then break this section off. Cut off the residual element using a side cutter.</p> 
---	---

## Notes on the Allocation of Resources

The two slots for the PCI cards each have an exclusive interrupt. Information on the assignment of PCI IRQs to the PCI slots is found in the "Advanced Menu" or "Bus Board" section.

## 10.4 Installing disk drives

### 10.4.1 Options of installing disk drives

#### Drive bay module for hard disks and DVD-ROM/CD-RW drives

DVD-ROM/CD-RW drive bay	Pos	Description
	(1)	DVD-ROM/CD-RW drive bay
	(2)	Mounting slot for DVD-ROM or DVD-ROM/CD-RW drive

One 3.5" hard disk	Pos	Description
	(1)	Hard disk drive bay for one 3.5" drive
	(2)	Mounting slot for a 3.5" hard disk drive bay



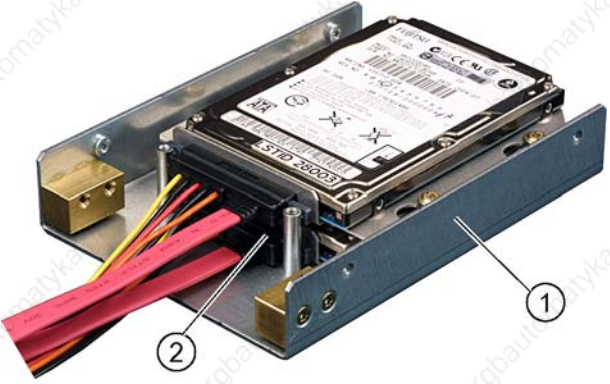

Two 2.5" hard disks	Pos	Description
	(1)	Hard disk drive bay for two 2.5" hard disks
	(2)	Two mounting slots for 2.5" hard disks

### 10.4.2 Installing/removing a drive bay module

#### Preparations

Disconnect the device from mains and unplug all cables.

#### Removing a drive bay for hard disks / DVD/CD-RW

Steps for removing the drive bay		
1	Unscrew 4 screws (1).	
2	Lift out the drive bay module for hard disks and DVD / CD-RW drives and set it down on the device.	

### 10.4.3 Installing and removing DVD-ROM/CD-RW drives

#### Removing a DVD-ROM/CD-RW

How to remove the DVD-ROM/CD-RW drive	
1	Remove the drive bay module.
2	Remove the 2 screws (1) on the DVD-ROM/CD-RW drive bay
3	Remove the 3 fastening screws (2) of the drive
4	Remove the 2 screws (3) of the adapter board
5	Pull out the adapter board
6	Lift out the drive

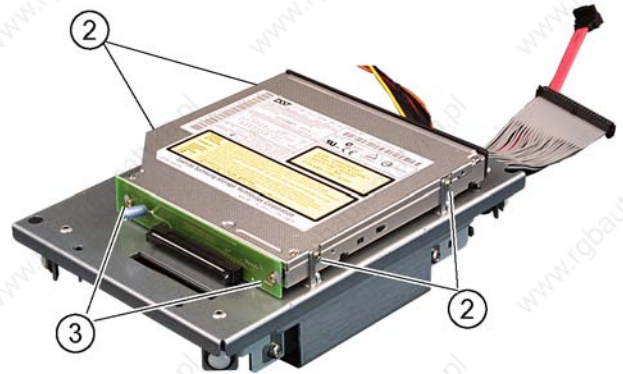

#### Required tools

You need a Torx 6 screwdriver to remove the the DVD-ROM/CD-RW drive.

### 10.4.4 Installing / removing hard disks

#### Removing 2.5" drives

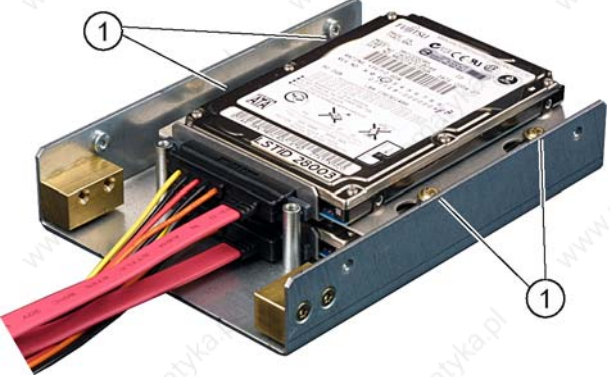
How to remove 2.5" drives	
1	Remove the drive bay module.
2	Unscrew the four screws of the drive (1)
	
3	Remove the drive and the steel mounting bracket from the bay
4	Disconnect the cable and the power supply adapter from the drive

## Removing 3.5" drives

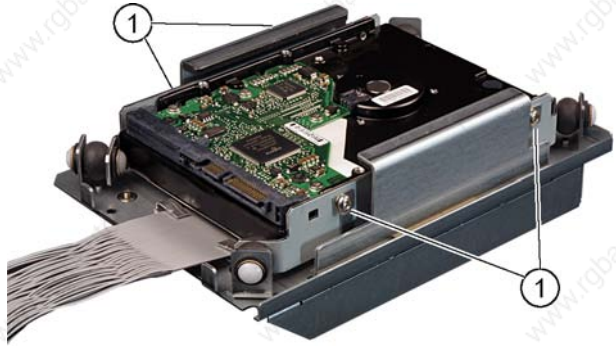
How to remove 3.5" drives	
1	Remove the drive bay module.
2	Disconnect the power supply and the data cable from the drive
3	Remove the 4 screws (1) of the drive
	
4	Take the drive out of the bay

### Note

Note that special screws with inch threads (6-32 x 3/16" St G3E) are used!



## 10.5 Installing/removing a Compact Flash card

### Memory expansion options

The device features a card reader slot for Compact Flash cards (types I / II). We recommend Compact Flash cards for industrial application (industrial grade cards from the company SANDISK, for example). These have distinguished themselves with especially good data security, a long life and excellent data transmissions rates.

---

#### Notice

This slot is not hot-plug capable. The Compact Flash card must be installed before the PC is switched on and should only be removed when the device is switched off.

---

### Preparation

Disconnect the PC from mains.



---

#### Caution

The electronic components on the PCBS are highly sensitive to electrostatic discharge. It is therefore vital to take precautionary measures when handling these components. Refer to the directives for handling electrostatic sensitive components.

---

### Opening the board slot

Steps for opening the board slot	
1	Remove the screw



Steps for opening the board slot	
2	Slide the cover of the board slot in the direction of the DVI connector and lift it up
	

### Installing a Compact Flash card

Steps for installing a Compact Flash card	
1	Open the board slot.
2	Insert the Compact Flash card in the slot with the connector facing in until it locks into place
	

10.5 Installing/removing a Compact Flash card

**Note**

The Compact Flash slot is coded against reversed insertion. Insert the Compact Flash card so that its label side is facing the front panel of the PC.



**Caution**

If the Compact Flash card meets resistance, flip it over. Never insert the Compact Flash card with force.

<b>3</b>	Close the board slot again.
----------	-----------------------------

**Removing a Compact Flash card**

<b>Steps for removing a Compact Flash card</b>	
<b>1</b>	Opening the board slot
<b>2</b>	Press the eject button, for example with the cover of the board slot, and remove the Compact Flash card
<b>3</b>	Close the board slot again





## Maintenance and service

### 11.1 Removing and installing hardware components

#### 11.1.1 Repairs

##### Carrying out repairs

Only authorized personnel are permitted to repair the device.



---

##### Warning

Unauthorized opening and improper repairs on the device may result in substantial damage to equipment or endanger the user.

---

- Before you open the device, first switch it off and then disconnect the power plug.
- Install only system expansion devices designed for this computer. If you install other expansion devices, you may damage the system or violate the safety requirements and regulations on RF suppression. Contact your technical support team or your sales outlet to find out which system upgrades are suitable for installation.

If you install or exchange system expansions and damage your device, the warranty becomes void.

---

##### Notice

Note the ESD instructions.

---

##### Limitation of Liability

All technical specifications and licenses apply only to expansions approved by SIEMENS.

No liability can be accepted for impairment of functions caused by the use of devices and components of other manufacturers.

## 11.1 Removing and installing hardware components

### Tools

You can perform all installation tasks on the device using Torx T6, Torx T10 and Torx T20 screwdrivers and a Philips screwdriver.

### 11.1.2 Replacing the Backup Battery

---

#### Note

Batteries are wearing parts and should be replaced every five years in order to ensure proper functioning of the PC.

---

#### To be noted before you replace the battery

---

#### Caution

Risk of damage!

The lithium battery may only be replaced with an identical battery or with a type recommended by the manufacturer (Order No.: A5E00331143).

---



---

#### Warning

Risk of explosion and release of harmful substances!

For this reason, do not burn lithium batteries, do not solder on the cell body, do not open, do not short circuit, do not reverse polarity, do not heat above 100°C, dispose of correctly, and protect against direct sunlight, dampness and dew.

---

### Disposal

---

#### Caution

Batteries must be disposed of in accordance with local regulations.

---

## Preparation

### Note

For the BIOS setting "Profile: Standard" the configuration data of the device is deleted when the battery is replaced.

For the BIOS setting "Profile: User" the configuration data of the device is retained; only the date and time has to be reconfigured.

1. Note down the current settings of the BIOS Setup.  
A list in which you can note down this information is found in the BIOS manual.
2. Disconnect the device from mains and unplug all cables.

### Notice

The battery can also be exchanged when the device is operating. However, we recommend switching off the device, beforehand.

## Replacing the battery

Follow the steps outlined below:

Steps for replacing the battery	
1	Open the battery compartment.

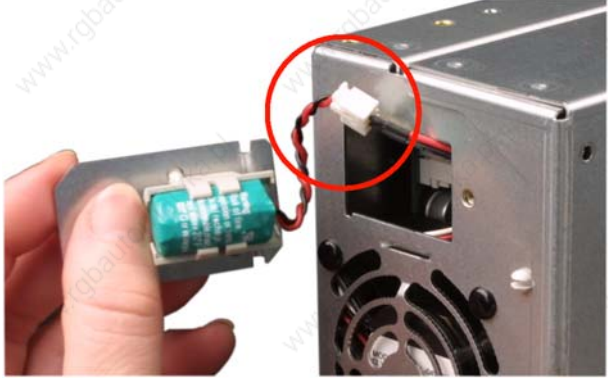

11.1 Removing and installing hardware components

Steps for replacing the battery	
<p>2 Remove the battery holder.</p>	
<p>3 Unplug the cable.</p>	
<p>4 Remove the old battery from the holder.</p>	
<p>5 Place a new battery in the holder and reconnect the battery plug.</p>	
<p>6 Close the battery compartment.</p>	

Reconfiguring the BIOS setup

When the battery is changed, the device's configuration data are deleted and you will need to reconfigure these in the BIOS setup.

### 11.1.3 Removing/Installing the Power Supply



#### Warning

Only qualified personnel is authorized to exchange the power supply module.

#### Preparations

1. Disconnect the device from mains and unplug all cables.
2. Open the device.

#### Removing the power supply module

How to remove the power supply module	
1	Remove the hard disk, DVD-ROM/CD-RW drive bay module.
2	Unscrew 5 screws (1) and remove the power supply module cover.

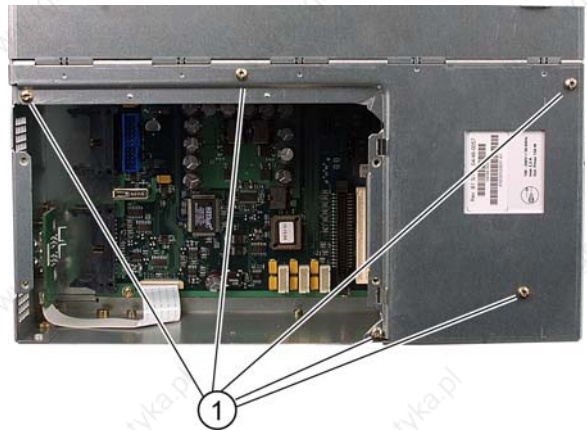

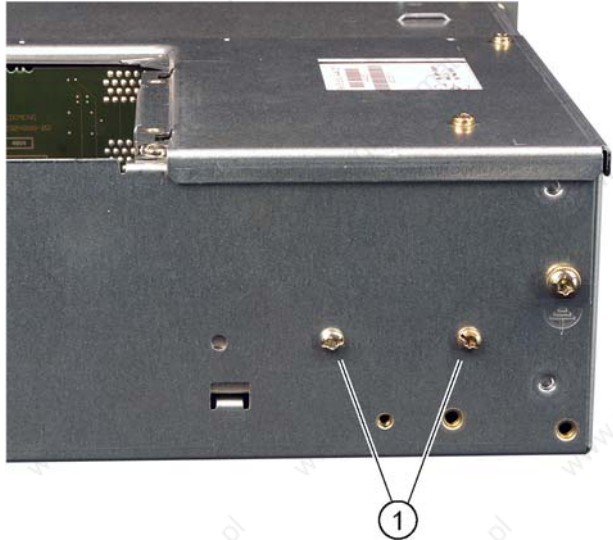
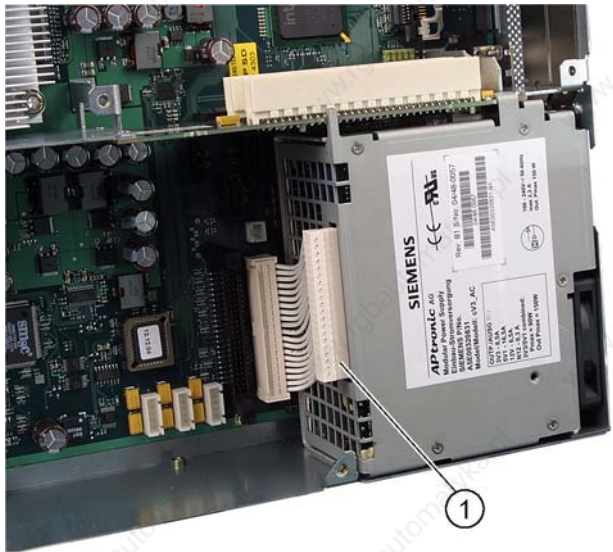

11.1 Removing and installing hardware components

How to remove the power supply module		
3	Remove the 2 fastening screws (1) (Torx T10).	
4	Pull out the plug (1) from the power supply module.	
6	Lift out the power supply module.	

### 11.1.4 Installing / removing the bus board

#### Preparation

1. Disconnect the device from mains and unplug all cables.
2. Open the device.

#### Removing the bus board

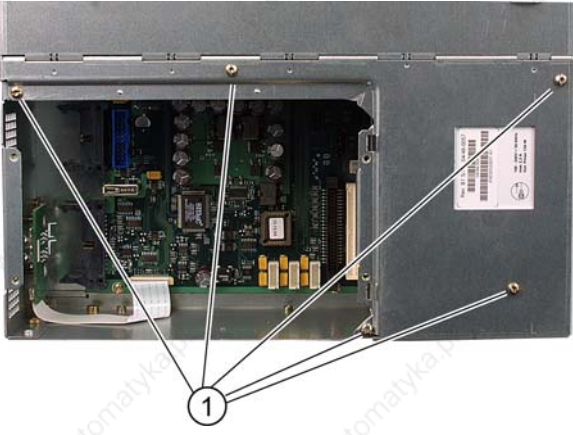
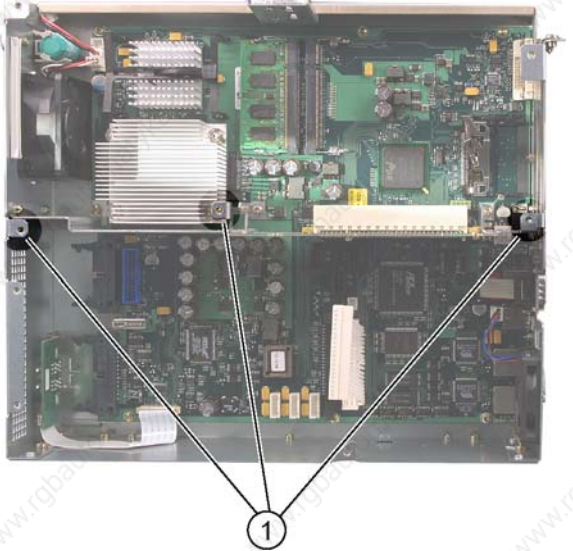
How to remove the bus board		
1	Remove all modules from their slots.	
2	Remove the drive bay module for hard disks and DVD-ROM/CD-RW.	
3	Remove the power supply cover: Unscrew 5 screws (1).	
4	Remove the power supply module.	
5	Remove the 3 screws (1) on the bus board.	

11.1 Removing and installing hardware components

How to remove the bus board		
6	Remove the 2 screws on the housing.	
7	Remove the bus board from the motherboard.	

11.1.5 Installing / removing the motherboard

Preparation

1. Disconnect the device from mains and unplug all cables.
2. Open the device.

Removing the motherboard

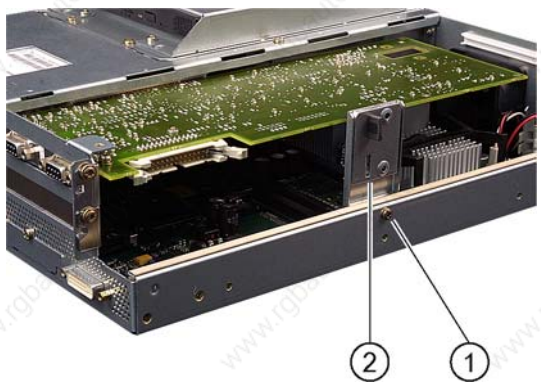
How to remove the motherboard		
1	Remove the hard disk, DVD-ROM/CD-RW drive bay module.	
2	Remove the module bracket (2). To do so, remove 1 screw (1).	
3	Remove the power supply cover.	
4	Remove the bus board.	
5	Remove the power supply module.	
6	Disconnect all cables from the motherboard, noting down their positions while doing so.	



**How to remove the motherboard**

7 Remove the 6 screws (1) and the processor fan: Unscrew 4 screws (2).

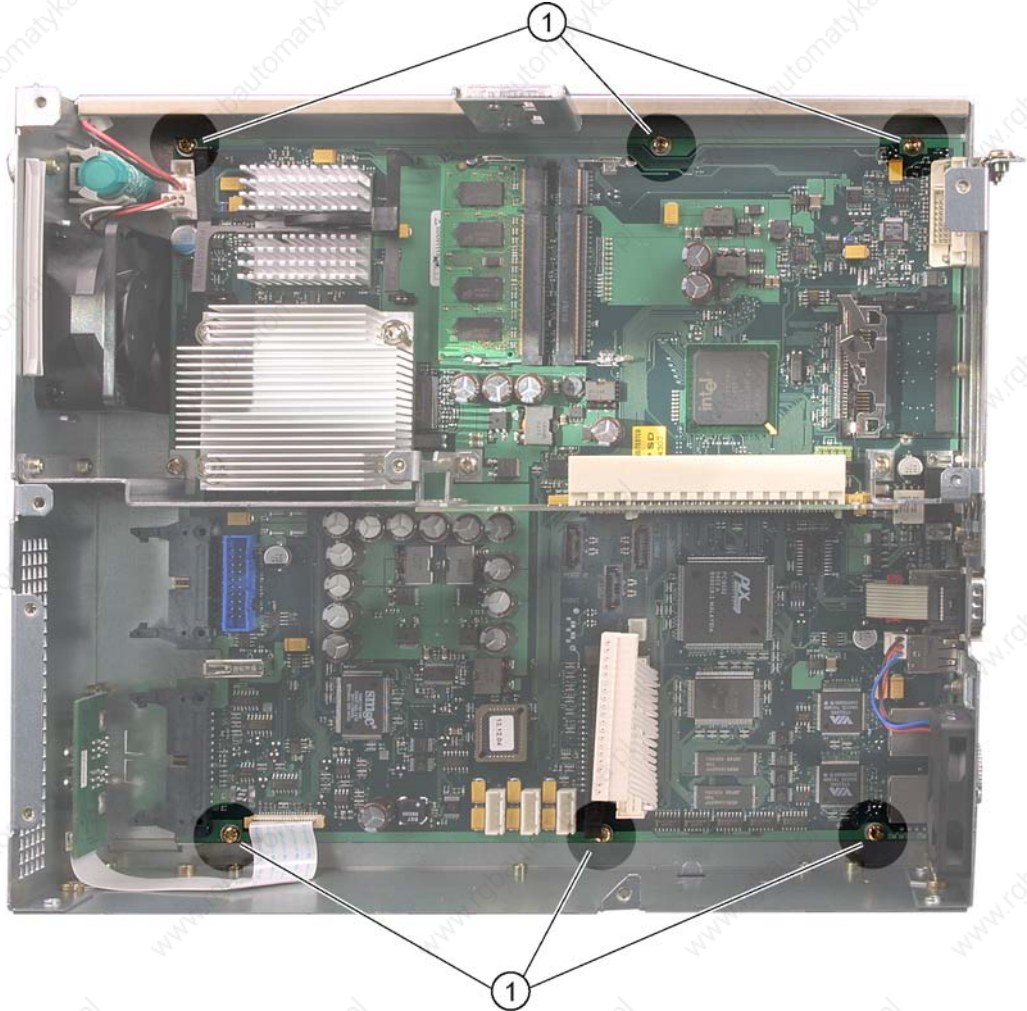

8 Remove the 4 hexagonal bolts on the interfaces.



9 Lift out the motherboard.

11.1 Removing and installing hardware components

11.1.6 Installing / removing the equipment fan

Preparations

1. Disconnect the device from mains.
2. Open the device

Removing the fan

How to remove the fan	
1	Unplug the fan connector from the motherboard
2	Remove the 4 plastic rivets on the housing
3	Lift out the fan from the housing.

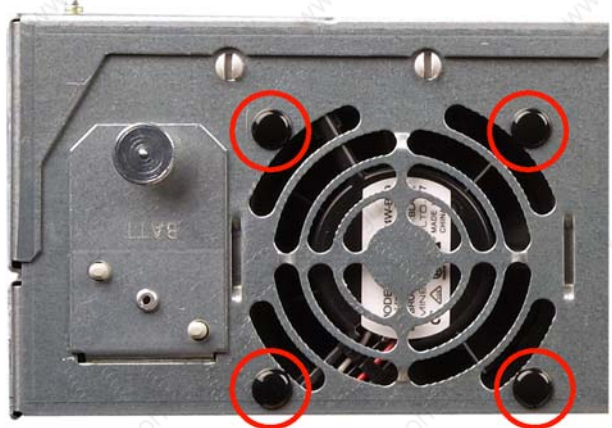
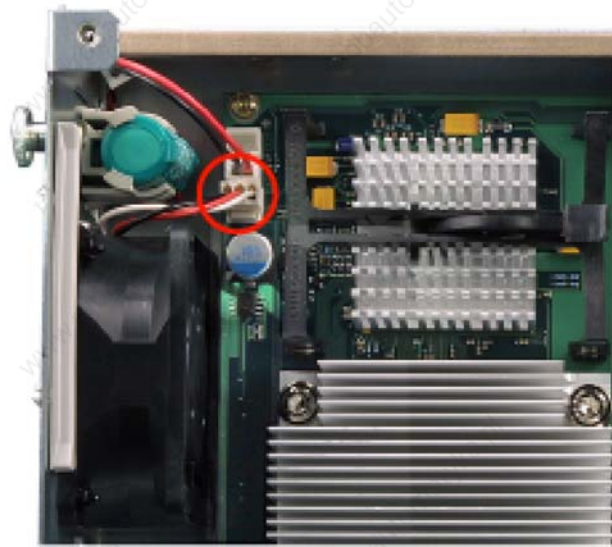

## Installing the fan

### Notice

Always install a fan of the same type!

#### Fan mounting position

The figure shows the correct fan mounting position.

Pay attention to the direction of the arrow on the fan enclosure!

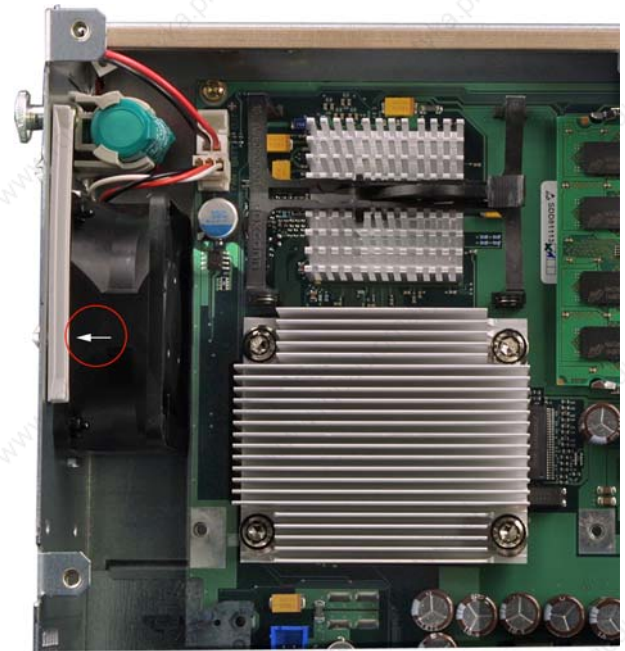



### 11.1.7 Installing / removing the power supply fan

#### Preparations

1. Disconnect the device from mains.
2. Open the device
3. Removing the power supply module

#### Removing the fan

How to remove the fan	
1	Unplug the power supply connector.
2	Remove the 4 plastic rivets on the housing.
3	Lift out the fan from the housing.

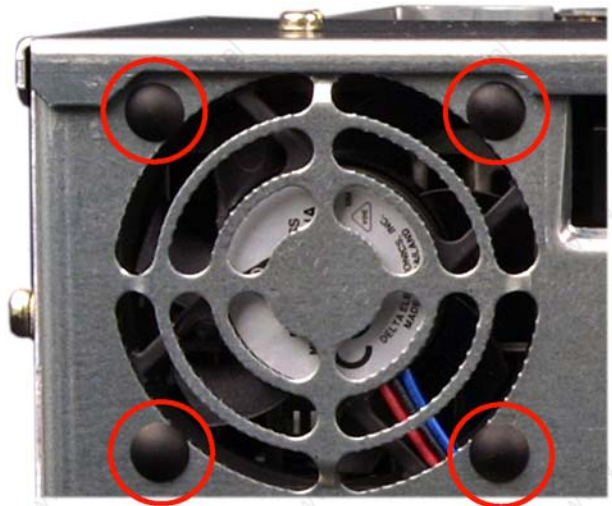
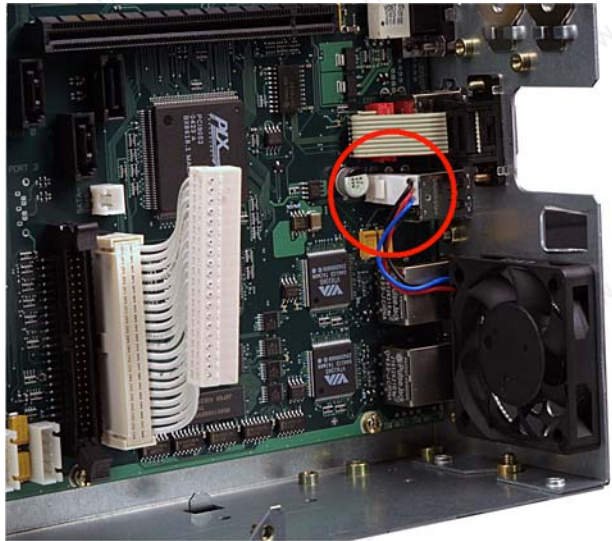

## Installing the fan

### Notice

Always install a fan of the same type!

#### Fan mounting position

The diagram shows the correct mounting position of the fan (1). Pay attention to the direction of the arrow on the fan enclosure!

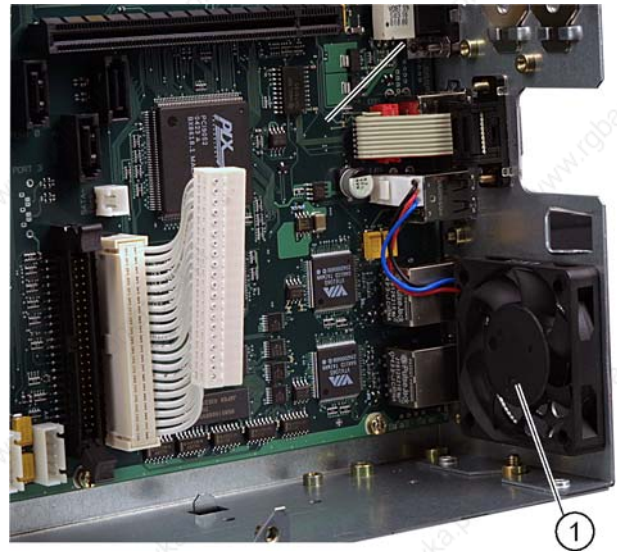

### 11.1.8 Installing / removing the processor

#### Caution

The processor replacement may only be carried out by authorized qualified personnel.

#### Preparation

1. Unplug the device from mains.
2. Open the device.

#### Removing the processor

How to remove the processor	
1	Remove the 4 screws holding the processor heat sink and remove the heat sink

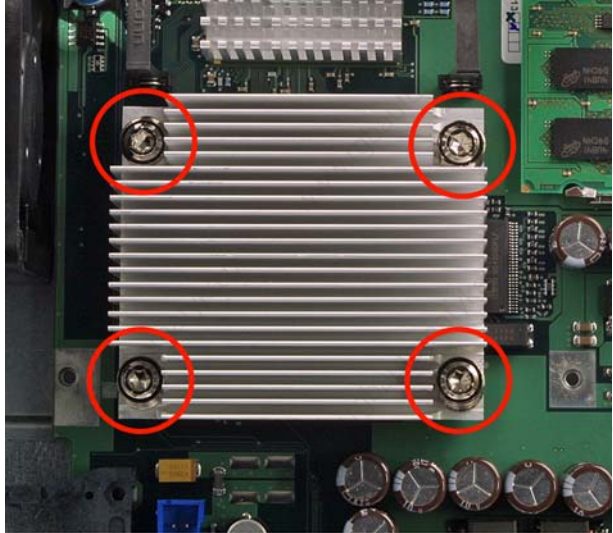

**How to remove the processor**

2 Opening the processor latch

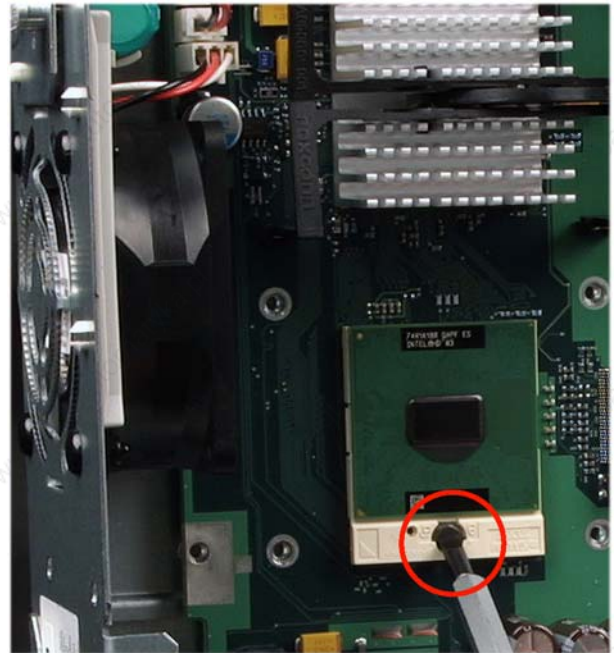

3 Removing the processor

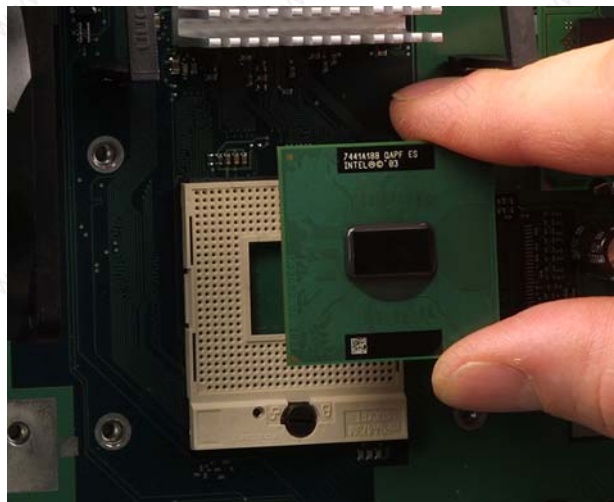



Installing the processor

How to install the processor	
1	Inserting the processor

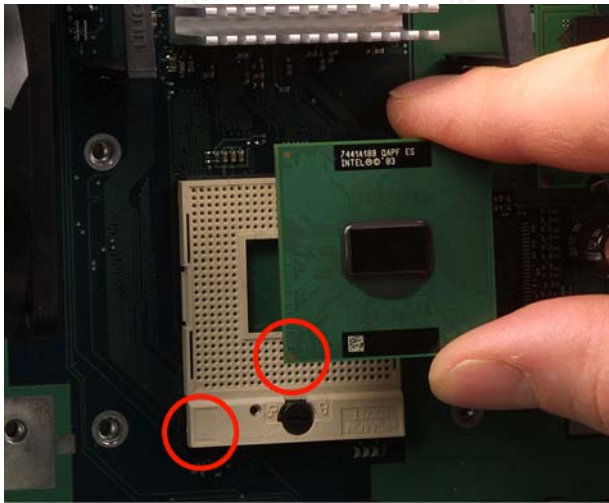

Notice

When you insert the processor, make sure the notches of the processor and of the socket match up.

2	Close the processor latch
3	Apply some heat-conductive paste to the processor



Caution

The processor may overheat when the system is in operation!

The heat-conductive paste must be applied evenly as a thin film!

4	Fasten the processor heat sink with the 4 screws. To do so, insert the screws diagonally and tighten them evenly, working diagonally in order to avoid tilting of the fan unit. Tighten the screws down to the mechanical stop.
---	---

Required tools

You need a Torx 20 screw driver for removing the processor.



## 11.2 Reinstalling the Operating System

### 11.2.1 Windows XP Embedded

#### 11.2.1.1 General installation procedure

If your software becomes corrupt for any reason, you can reinstall it from the Restore CD. The Restore CD contains a image file for the hard disk or CF card with the original software (operating system with installed hardware drivers) and forms part of the scope of delivery of the device.

---

#### Note

You require a USB keyboard in order to reinstall the operating system.

---

#### 11.2.1.2 Restoring the software to factory state using the Restore CD

You can reinstall the original factory software using the Restore CD (forms part of the scope of delivery). The CD contains the necessary images and tools for transferring the factory software to the hard disk or CF card of your PC. The following options are available for restoring software:

- You can restore the entire hard disk with drive C: (system) and drive D:
- or only drive C:. This allows you to retain any user data on drive D.
- Restore the entire CF card.

---

#### Caution

With the option "Restore system partition only", all data on drive C: (System) will be deleted. All data, user settings and all authorizations or license keys on drive C: will be lost in the process! All data on drive C: of your hard disk drive will be deleted. Setup formats the hard disk partition and reinstalls the original factory software.

When you select the "Restore entire hard disk" option, ALL the data, user settings and authorizations or license keys will be lost on the hard disk.

---

### Restoring the factory state

To restore the factory state, proceed as follows:

1. If the device does not have an optical drive, connect a USB CD-ROM drive to the device.
2. Insert the Restore CD in the drive and reboot the device. When the BIOS message appears, press

<F2> to enter SETUP or <ESC> to display the boot menu
---

the F2 key.

## 11.2 Reinstalling the Operating System

3. Select the Boot menu and move the entry "CD-ROM Drive" to the first position.
4. End the BIOS setup with the "Exit Saving Changes" entry.
5. Now follow the instructions on the screen.

---

### Caution

All existing **data, programs, user settings** and **authorizations or license keys** will be deleted from the hard disk and therefore lost.

---

For information on the functions, refer to the README.TXT file on the Restore CD.

---

### Note

The "Legacy USB Support" option has to be set to "Enabled" in the Advanced menu of the BIOS so that the device can address a USB CD-ROM drive.

---

## 11.2.2 Windows XP Professional / Windows 2000 MUI

### 11.2.2.1 General installation procedure

If your software becomes corrupt for any reason, you have two possibilities:

- **Restoring the factory state of the software by means of the Restore DVD**  
The Restore DVD contains an image of the original supplied software (operating system with installed drivers) and is included in the Windows XP Professional variant.
- **Setting up the operating system with the Recovery CD**  
The recovery CD contains the tools required to set up the hard drive as well as the Windows XP Professional operating system. After the required data have been copied to the hard disk, you can run Windows XP professional Setup to install the operating system. The Recovery CD can be obtained from the Customer Support.

---

#### Note

You require a USB keyboard in order to reinstall the operating system.

---

### 11.2.2.2 Restoring the Software to Factory State Using the Restore DVD

You can reinstall the original factory software (included in the Windows XP Professional supply variant) using the Restore DVD. The DVD contains the necessary images and tools for transferring the factory software to the hard disk of your PC. The following options are available for restoring software:

- You can restore the entire hard disk with drive C: (system) and drive D:
- or only drive C:.. This allows you to retain any user data on drive D.

---

#### Caution

With the option "Restore system partition only", all data on drive C: (System) will be deleted. All data, user settings and all authorizations or license keys on drive C: will be lost in the process! All data on drive C: of your hard disk drive will be deleted. Setup formats the hard disk partition and reinstalls the original factory software.

When you select the "Restore entire hard disk" option, ALL the data, user settings and authorizations or license keys will be lost on the hard disk.

---

## 11.2 Reinstalling the Operating System

---

### Restoring the factory state

To restore the factory state, proceed as follows:

1. If the device does not have an optical drive, connect a USB DVD-ROM drive to the device.
2. Insert the Restore DVD in the drive and reboot the device. When the BIOS message appears, press

<F2> to enter SETUP or <ESC> to display the boot menu
---

the F2 key.

3. Select the Boot menu and move the entry "CD-ROM Drive" to the first position.
4. End the BIOS setup with the "Exit Saving Changes" entry.
5. Now follow the instructions on the screen.

---

#### Caution

All existing **data, programs, user settings** and **authorizations or license keys** will be deleted from the hard disk and therefore lost.

---

For information on the functions, refer to the README.TXT file on the Restore DVD.

---

#### Note

The "Legacy USB Support" option has to be set to "Enabled" in the Advanced menu of the BIOS so that the device can address a USB DVD-ROM drive.

---

### Setting up the language selection for Windows XP Professional

The Multilanguage User Interface (MUI) allows you to set up the Windows XP Professional menus and dialogs for additional languages.

Default language of your Windows XP MUI installation is English and a US keyboard layout. You can change the language in the Control Panel. Select:

<b>Start &gt; Control Panel &gt; Regional and Language Options</b> Languages, tab <b>Language used in menus and dialogs</b> field.
--

For the <b>Regional and Language Options</b> set the default as <b>non-Unicode programs</b> under <b>Advanced</b> in addition to the language for menus and dialogs.
--

### Setting up the language selection for Windows 2000 MUI

The **Multilanguage User Interface (MUI)** allows you to set up the Windows 2000 menus and dialogs for additional languages.

To set the required languages for the Windows 2000 menus, dialogs and keyboard layout, select:

**Start > Settings > Control Panel > Regional Options > General tab, Setting for the current user field and Language settings for the system field and the Keyboard layout field in the Input Locales tab.**

The default language setting of your Windows 2000 installation is English and a US keyboard layout. To change to another language and keyboard layout, open the Control Panel and select:

**Start > Settings > Control Panel > Regional Options > General tab, Setting for current user field and Language settings for the system field and the Input language field in the Input Locales tab.**

In addition to the menu and dialog language settings, you also need to set the default language by selecting **Set Default...** from the **Regional Options** dialog box.

#### 11.2.2.3 Setting up the operating system via the Recovery CD

Use the Recovery CD to install Windows to meet your special requirements. The operating system used is Windows Preinstall Environment (WinPE). You will also need the supplied Documentation and Drivers CD.

#### Booting with the CD Recovery

1. Insert the Recovery CD in your drive and reboot the device. When the BIOS message "Press <F2> to enter Setup or <ESC> to show Boot Menu" appears, press the ESC key. After initialization, a "Boot Menu" is displayed.
2. Follow the on-screen instructions until the "Siemens SIMATIC Recovery" window appears.

#### Partition setup

After you have installed a new hard disk, or if partitions are faulty, or when you wish to change the partitioning on your hard disk, you need to create or reconfigure partitions on the hard disk

---

#### Caution

When you delete or create partitions or logical DOS partitions, you lose all data on the hard disk. All partitions on the hard disk will be deleted.

---

11.2 Reinstalling the Operating System

With Windows XP operating systems, the factory state features two partitions with an NTFS file system on the hard disk. To restore the partitions to factory state, proceed as follows:

1. Boot from the Recovery CD and then follow the screen instructions until the Recovery functions window is displayed.
2. Start the DiskPart program in the "Siemens SIMATIC Recovery" window and enter the following commands in the displayed command interface:

list disk	Displays all available hard disks.
select disk 0	Selects the disk where you wish to change the configuration. 0 selects the first hard disk.
list partition	Displays all partitions on the selected hard disk.
clean	Completely wipes the selected hard disk. All information stored there is lost.
create partition primary size=n	Creates a primary partition with the n MB on the selected hard disk. Factory state values: n = 10000 for Windows 2000 or XP
select partition 1	Select the primary partition
active	Activates the selected partition
exit	Closes DiskPart.

Additional DiskPart functions:

Help	Shows all available DiskPart commands. When a command is supplemented with other parameters, the command is described with additional information. Example: create partition help
------	--

**Note**

Once you have change the configuration of your hard disk with DiskPart, you will need to reboot the PC for the changes to go into effect.

Boot again from the Recovery CD to format the partitions.

**Format primary partition**

1. Boot from the Recovery CD to format the partitions. Follow the screen instructions until the Recovery functions window is displayed.
2. Select "Start command prompt" in the Recovery functions window. In the command interface that opens, enter the following command:  
`format DL:/FS:File System`  
 DL = Drive letter of the partition to be formatted. Valid values: C, D, E, F etc.  
 File system = Specifies the type of file system. Valid values: FAT, FAT32, NTFS.

NTFS is the factory setting for all Windows operating systems.

Example for a master hard disk on the IDE bus

`format C:/FS:NTFS`

`format /?` Shows all parameters of the command.

### Installation of the operating system.

The recovery CD contains encrypted data that can only be transferred to this system.

1. Boot from the Recovery CD and then follow the screen instructions until the Recovery functions window is displayed.
2. Select "Recovery Windows ..." in the "Siemens SIMATIC Recovery" window.
3. Follow the instructions on the screen.

---

#### Note

Note that there has to be the following available space on the drive after transfer of the selected recovery data:  
500 MB for Windows 2000  
1500 MB for Windows XP

---

4. Select "Start command prompt" in the Recovery functions window.
5. Enter the following command in the displayed command prompt interface:  
Drive:  
cd \I386  
Winnt32.bat  
Drive: Drive letter of the folder containing the I386 directory.
6. The preparation of the Windows installation is displayed.
7. When this is completed, close the command prompt with the `exit` command.
8. Close the Siemens SIMATIC Recovery window with the "Finish" button.
9. The Windows installation is completed following an automatic restart of the system.
10. Follow the instructions on the screen.

---

#### Note

If you want to use Windows XP as a professional you should have the following manual (not included in the scope of delivery) available:  
Microsoft Windows XP Professional, the technical reference" (MSPress Nr 934).

this manual contains special information for administrators involved in installing, managing and integrating Windows in networks or multi-user environments.

---



### Setting up the language selection for Windows XP Professional

The **Multilanguage User Interface (MUI)** allows you to set up the Windows XP Professional menus and dialogs for additional languages.

To install the MUI, start

"MUI-german"

or "MUI Windows XP" in root folder of your Recovery CD to run MUISETUP.EXE. Follow the instructions on the screen to install the required languages.

Default language of your Windows XP MUI installation is English and a US keyboard layout. You can change the language in the Control Panel. Select:

**Start > Control Panel > Regional and Language Options**  
**Languages**, tab **Language used in menus and dialogs** field.

For the **Regional and Language Options** set the default as **non-Unicode programs** under **Advanced** in addition to the language for menus and dialogs.

### Setting up the language selection for Windows 2000

The **Multilanguage User Interface (MUI)** allows you to set up the Windows 2000 menus and dialogs for additional languages.

To install the MUI, start the Recovery CD in directory

CD\_LW:\SOURCE\MUI

Program MUISETUP.EXE. Follow the on-screen instructions, in order to install the required languages.

To set the required languages for the Windows 2000 menus, dialogs and keyboard layout, select:

**Start > Settings > Control Panel > Regional Options > General** tab, **Setting for the current user** field and **Language settings for the system** field and the **Keyboard layout** field in the **Input Locales** tab.

The default language setting of your Windows 2000 installation is English and a US keyboard layout. To change to another language and keyboard layout, open the Control Panel and select:

**Start > Settings > Control Panel > Regional Options > General** tab, **Setting for current user** field and **Language settings for the system** field and the **Input language** field in the **Input Locales** tab.

In addition to the menu and dialog language settings, you also need to set the default language by selecting **Set Default...** from the **Regional Options** dialog box.

## 11.3 Partitioning the hard disk

### 11.3.1 Setting up the partitions under Windows XP Embedded

After you have installed a new hard disk, or if partitions are faulty, or when you wish to change the partitioning on your hard disk, you need to create or reconfigure partitions on the hard disk

#### Partitioning the Compact Flash card

The factory state of the Compact Flash card includes the following partitions:

Partition	Name	Size of the card		File system
		512 Mbytes	1 Gbytes	
1. Partition	system	455 Mbytes	867 Mbytes	NTFS (compressed)
2. Partition	DATA	Rest *	Rest *	NTFS (compressed)

\* Due to partitioning/formatting, the actual Compact Flash capacity does not correspond to the memory size specified on the Compact Flash.

In order to revert to the original factory state partitions, we recommend using the software tool **SIMATIC PC/PG Image Creator**. Detailed information about using this tool is available in the manufacturer documentation.

### 11.3.2 Setting up partitions under Windows XP Professional / Windows 2000 MUI

After you have installed a new hard disk, or if partitions are faulty, or when you wish to change the partitioning on your hard disk, you need to create or reconfigure partitions on the hard disk

#### Partitioning the hard disk

The factory state of the hard disk with Windows XP Professional includes the following partitions:

Partition	Name	Size	File system
1. Partition	system	15 GB	NTFS (not compressed)
2. Partition	DATA	Rest	NTFS (not compressed)

In order to revert to the original factory state partitions, we recommend using the software tool **SIMATIC PC/PG Image Creator**. Detailed information about using this tool is available in the manufacturer documentation.

## 11.4 Install drivers and software

---

### Notice

Before you install new drivers or updates for multilingual operating systems, (MUI versions), the regional settings for menus and dialogs and the default language must be reset to US English.

---

Install the drivers and software from the included "Documentation and Drivers". Procedure:

1. Place the CD in the CD ROM drive.
2. Run *START*.
3. Select *Drivers & Updates* in the tab.
4. Select the operating system in *Drivers & Updates*.
5. Install the desired driver.

---

### Notice

For new Windows 2000 / XP installations, the chipset driver must be installed before you install any other drivers.

---

### 11.4.1 Driver installation under Windows XP Embedded

The driver installation under Windows XP Embedded is conducted in the same way as under XP Professional. Pay attention to the installation instructions of the driver manufacturer.

When drivers are being installed under Windows XP Embedded, you may see a message that the Windows XP Installation CD or SP2 CD is required.

In this case, insert the Restore DVD. The required files are in the \Drivers\_XPE folder.

## 11.5 Install RAID Controller Software

The procedure for installing the software can be found in the RAID user manual on the supplied "Documentation and Drivers" CD.

### Note concerning Windows 2000 Professional / XP Professional

You need to select the Intel 82801FR SATA RAID Controller from the provided list when installing Windows 2000 Professional /XP Professional for the first time.

## 11.6 Install burner / DVD software

### 11.6.1 Installing burner/DVD software

The supplied CD provides information about installation of the burner/DVD software.

## 11.7 Installing updates

### 11.7.1 Updating the operating system

#### Windows XP Embedded

An update of the operating systems is only possible with a new version of the Restore CD. Please contact customer support for more information about its availability.

#### Windows XP Professional

Monthly updates for the Windows XP Professional operating system are available on the Internet under <http://www.microsoft.de>

---

#### Notice

Before you install new drivers or operating system updates at Windows XP Professional MUI versions, the regional settings for menus and dialogs and the default language have to be reset to US English.

---

#### Other operating systems

Please contact the corresponding manufacturer.

## 11.7.2 Installing or updating application programs and drivers

In order to install software from a CD and/or floppy disc under Windows XP Embedded / Windows XP Professional, the corresponding drive must be installed or connected.

Drivers for USB floppy disk and CD-ROM drives are included in Windows XP Embedded/Windows XP Professional and do not have to be installed from other sources.

For information about installation of SIMATIC software packages, refer to the respective manufacturer documentation.

For updates of drivers and application programs from third-party manufacturers, contact the respective manufacturer.

---

### Notice

Before you install new drivers or operating system updates at Windows XP Professional MUI versions, the regional settings for menus and dialogs and the default language have to be reset to US English.

---

## 11.8 Data backup

### 11.8.1 Creating an image

#### Data backup under Windows XP Embedded/Windows XP Professional

To back up data under Windows XP Embedded / Windows XP Professional, we recommend the software tool **SIMATIC PC/PG Image Creator**. This tool enables you to easily back up and restore the full content of Compact Flash cards or hard disks as well as individual partitions (images).

The software can be ordered from the Siemens A&D online ordering system. For detailed information about SIMATIC PC/PG Image Creator, please refer to the corresponding product documentation.

## Alarm, Error and System Messages

### 12.1 Boot error messages

During startup (the boot process), the BIOS first performs a **Power On Self Test (POST)** and checks whether certain functional units of the PC are operating error-free. When an error occurs within this phase, the BIOS outputs a tone sequence (beep code) based on the current test result. The boot sequence is interrupted immediately if fatal errors occur.

If the POST does not return an error, the BIOS initializes and tests further functional units. In this startup phase, the graphics controller is initialized and any error messages are output to the screen.

The following lists the error messages from the system BIOS. For information on error messages output by the operating system or programs, refer to the corresponding manuals.

#### On-screen error messages

On-screen error message	Meaning / suggestions
Address conflict	Plug and Play problem. Contact your technical support team.
Combination not supported	Plug and Play problem. Contact your technical support team.
IO device IRQ conflict	Plug and Play problem. Contact your technical support team.
Invalid System Configuration Data	Plug and Play Problem <ul style="list-style-type: none"> <li>Set the RESET CONFIGURATION DATA option in the "Advanced" menu of Setup.</li> <li>Contact your technical support team.</li> </ul>
Allocation Error for ...	Plug and Play problem <ul style="list-style-type: none"> <li>Please undo the last hardware change.</li> <li>Contact your technical support team.</li> </ul>
System battery is dead. Replace and run SETUP	The battery on the CPU module is defective or dead. Contact your technical support team.
System CMOS checksum bad Run SETUP	Call up SETUP, adjust settings and save. If this message appears during each startup, contact your technical support team.
Failure Fixed Disk	Error accessing the hard drive. Check the SETUP settings. Contact your technical support team.
Keyboard error	Check whether the keyboard is properly connected.
Key seizure	Check whether a key on the keyboard has seized.

## Alarm, Error and System Messages

### 12.1 Boot error messages

On-screen error message	Meaning / suggestions
System RAM Failed at offset:	Memory error. Contact your technical support team.
Shadow RAM Failed at offset:	Memory error. Contact your technical support team.
Extended RAM Failed at offset:	Memory error. Contact your technical support team.
Failing Bits:	Memory error. Contact your technical support team.
Operating system not found	Possible causes: <ul style="list-style-type: none"><li>• No operating system present</li><li>• Wrong drive addressed (disk in drive A/B)</li><li>• Incorrect active boot partition</li><li>• Wrong boot drive settings in SETUP</li><li>• Hard disk is not connected / defective</li></ul>
Previous boot incomplete Default configuration used	Abort of the previous BOOT procedure, for example, due to a power failure. Adjust the settings in SETUP.
System cache error Cache disabled	Error in the CPU's cache module. Contact your technical support team.
Monitor type does not match CMOS Run SETUP	The monitor does not match the SETUP entries. Adapt the SETUP entries to the monitor.
System time-out	Hardware error. Contact your technical support team.
Real-time clock error	Clock chip error. Contact your technical support team.
Keyboard controller error	Keyboard error. Contact your technical support team.



## 12.2 BIOS POST codes

The following section lists the POST codes relevant to users in the sequence in which they occur: Contact Customer Support for all other POST codes.

Display (hex)	Meaning	Description	Remedy
16H	TP_CHECKSUM	BIOS checksum test	Service event
28H	TP_SIZE_RAM	Determine DRAM size	Replace memory modules
2AH	TP_ZERO_BASE	Set base RAM 64KB to 0	Replace memory modules
2CH	TP_ADDR_TEST	Check address busses	Replace memory modules
2EH	TP_BASERAML	BaseRam Low	Replace memory modules
30H	TP_BASERAMH	BaseRam High	Replace memory modules
38H	TP_SYS_SHADOW	BIOS is copied to DRAM	Replace memory modules
3AH	TP_CACHE_AUTO	Determine CPU cache	Exchange CPU
22H	TP_8742-TEST	Test keyboard controller	Check if keyboard is connected or defective
3CH	TP_ADV_CS_CONFIG	Configure the advanced chipset	Test by switching off the hardware components in Setup
49H	TP_PCI_INIT	Initialize the PCI interface	Test by switching off the hardware components in Setup or removing installed expansion modules from the bus module
55H	TP_USB_INIT	Activation of the USB hardware	Removal of USB devices
4AH	TP_VIDEO	Initialize the video interface	
5CH	TP_MEMORY_TEST	Test of the system memory	Replace memory modules
60H	TP_EXT_MEMORY	Test of the complete memory	Replace memory modules
62H	TP_EXT_ADDR	Test of the address busses	Replace memory modules
90H	TP_FDISK	Initialization and test of the hard disk hardware	Disconnect hard disk, replace if necessary
95H	TP_CD	Initialization and test of the CD hardware	Disconnect CD ROM, replace if necessary
98H	TP_ROM_SCAN	Search for BIOS expansions	Test by switching off the hardware components in Setup or removing installed expansion modules from the bus module
BCH	TP_PARITY	Test of the memory modules	Replace memory modules
00H		BIOS Power On Self Test completed. Loading operating system	

### Special codes

The following Beep codes are available in addition to the listed POST codes:

- **3 x short** INSERT key is pressed on system start:  
If an external graphics card on the bus board is not detected, you can try to activate it by pressing the INSERT key.  
The "INSERT" key activates special enumerations for activating a PCI VGA card.
- **1 x long 8 x short** Error on reading the MPI system information:  
Please contact Customer Support
- **4 x short** MPI firmware has been updated:  
This can occur once following a BIOS update.
- **2x short** Error in checksum test of the BIOS:  
This can occur following a battery replacement or when the battery is empty.

## Troubleshooting

### 13.1 General problems

This chapter provides you with tips on how to localize and troubleshoot frequently occurring problems.

Problem	Possible causes	To correct or avoid error
The device is not operational	There is no power supply to the device.	<ul style="list-style-type: none"> <li>• Check the power supply, the network cable and the power plug.</li> <li>• Check if the On/Off switch is in the correct position.</li> </ul>
	Device is being operated outside the specified ambient. conditions	<ul style="list-style-type: none"> <li>• Check the ambient conditions.</li> <li>• After transport in cold weather, wait approximately 12 hours before switching on the device.</li> </ul>
The external monitor remains dark.	The monitor is switched off.	Switch on the monitor.
	The monitor is in "power save" mode.	Press any key on the keyboard.
	The brightness button has been set to dark.	Increase the screen brightness. For detailed information, refer to the monitor operating instructions.
	The power cord or the monitor cable is not connected.	<ul style="list-style-type: none"> <li>• Check whether the power cord has been properly connected to the monitor and to the system unit or to the grounded shockproof outlet.</li> <li>• Check whether the monitor cable has been properly connected to the system unit and to the monitor.</li> </ul> <p>If the monitor screen still remains dark after you have performed these checks, please contact your technical support team.</p>
The mouse pointer does not appear on the screen.	The mouse driver is not loaded.	1. Check whether the mouse driver is properly installed and present when you start the application program.
	The mouse is not connected.	<p>Check whether the mouse lead is connected to the system unit. If you are using an adapter or extension for the mouse lead, check the connectors.</p> <p>Should the mouse cursor still not be visible on-screen after completing these checks and measures, contact technical support.</p>
Wrong time and/or date on the PC.		<ol style="list-style-type: none"> <li>1. Press &lt;F2&gt; within the boot sequence to open the BIOS Setup.</li> <li>2. Set the time and date in the setup menu.</li> </ol>
Although the BIOS setting is OK, the time and data are still wrong.	The backup battery is dead.	In this case, please contact your technical support team.

13.2 Problems when Using Modules of Third-party Manufacturers

Problem	Possible causes	To correct or avoid error
USB device not responding.	The USB ports are disabled in your BIOS.	Use a different USB port or enable the port.
	USB 2.0 device connected but USB 2.0 is disabled.	Enable USB 2.0.
	Operating system does not support the USB port.	Enable USB Legacy Support for the mouse and keyboard. For all other devices you need USB drivers for the specific operating system.
DVD: The front loader does not open.	The device is switched off or the open/close button is disabled by a software application.	Emergency removal of the data medium: <ol style="list-style-type: none"> <li>1. Switching off the device</li> <li>2. Insert a pointed object, a pin for example, or an opened paper clip into the emergency extraction opening of the drive. Apply slight pressure to the contact until the front loader opens.</li> <li>3. Pull the loader further out.</li> </ol>

## 13.2 Problems when Using Modules of Third-party Manufacturers

Problem	Possible causes	To correct or avoid error
The PC crashes during startup	<ul style="list-style-type: none"> <li>• I/O addresses are assigned twice.</li> <li>• Hardware interrupts and/or DMA channels are assigned twice.</li> <li>• Signal frequencies or signal levels are incorrect.</li> <li>• Connector assignments deviate.</li> <li>• "Reset Configuration" in BIOS SETUP has not been carried out.</li> </ul>	Check your computer configuration: <ul style="list-style-type: none"> <li>• If the computer configuration corresponds with factory state, please contact your technical support team.</li> <li>• If the computer configuration has changed, restore the original factory settings. Remove all third-party modules, then restart the PC. If the error no longer occurs, the third-party module was the cause of the fault. Replace this module with a Siemens module or contact the module supplier.</li> <li>• Force a "Reset Configuration" using the BIOS setup.</li> </ul> If the PC still crashes, contact your technical support team.
	<ul style="list-style-type: none"> <li>• If the performance of the external 24 V power supply is insufficient</li> </ul>	<ul style="list-style-type: none"> <li>• use a larger power supply.</li> </ul>

## 13.3 Display a temperature fault by means of the SOM application

### Cause

Temperature errors do not occur during the normal approved use of the device. Should the "TEMP" LED indicate a temperature fault by changing from green to red, please check:

- Are the fan apertures covered?
- If the fan has failed (check speed display in the SOM)?
- Is the ambient temperature higher than the allowed value (see technical data)?
- Is the total output of the power supply within the specified limit?
- Are the heatsinks inside the PC covered with dust?

### Remedy

The temperature fault is stored until the temperature drops back below the temperature threshold and you acknowledge the error message in the SOM application.

- Click on the button with the "small broom" icon.  
When the error message has been acknowledged, the "TEMP" LED goes out and the SOM application switches to the title page and the "SOM" symbol on the status bar changes from red to green.
- Restart the PC, if you have not installed the SOM application.



## Technical Data

### 14.1 General Specifications

<b>General technical data</b>	
Order numbers	6ES7647-6Axxx-xxxx
Dimensions	Without DVD/CD-RW: 297x267x80 (WxHxD in mm) With DVD/CD-RW: 297x267x100
Weight	approx. 7 kg
Supply voltage (AC)	Nominal 100 - 240 V AC (-15% / +10%) (autorange)
Supply voltage (DC)	Nominal 24 V DC (-15% / + 20%), SELV
Input current AC	Steady-state current up to 2.3 A (on start-up, up to 50A for 1 ms)
Input current DC	Continuous current to 9 A (to 14 A for 30 ms at startup)
Line voltage frequency	50 - 60 Hz (47 to 63 Hz)
Transient current interruption according to Namur	min.20 ms (at 93 to 264 V) (max. 10 events per hour; min. recovery time 1 s)
max. power consumption AC and DC	190 W / 210 W
max. current output	+5 V / 16.5 A * (18.5 W peak) +3.3 V / 8.5 A * * total of 90 W permitted +12 V / 6.5 A (8 A peak) -12 V / 0.3 A The total sum of all voltages is max. 150 W.
Noise emission	< 55 dB(A) according to DIN 45635-1
Degree of protection	IP 20
<b>Safety</b>	
Protection class	Protection class I to IEC 61140
Safety regulations	AC: EN 60950-1; UL60950-1; CAN/CSA C22.2 No 60950-1-03 DC: EN 61131-2; UL508; CSA C22.2 No 142
<b>Electromagnetic compatibility (EMC)</b>	
Emitted interference	EN 55022 Class B, EN 61000-3-2 Class D EN 61000-3-3; FCC Class A
Noise immunity: Mains borne disturbance variables on supply lines	± 2 kV, (according to IEC 61000-4-4; Burst) ± 1 kV; (according to IEC 61000-4-5; Surge symm) ± 2 kV; (according to IEC 61000-4-5; Surge asymm)
Noise immunity on signal lines	± 1 kV;(according to IEC 61000-4-4; Burst; Length < 5 m) ± 2 kV; (according to IEC 61000-4-4; Burst; Length > 5 m) ± 2 kV; (according to IEC 61000-4-5; Surge; Length > 30m)



14.1 General Specifications

<b>General technical data</b>	
Immunity to discharges of static electricity	± 6 kV contact discharge (according to IEC 61000-4-2) ± 8 kV air discharge (according to IEC 61000-4-2)
Immunity to RF interference	10 V/m 80–1000 MHz, 80% AM (according to IEC 61000-4-3) 10 V/m 900 MHz u. 1.89 GHz, 50% ED (according to IEC 61000-4-3) 10 V 9 KHz-80MHz (according to IEC 61000-4-6)
Magnetic field	30 A/m, 50 Hz (to IEC 61000-4-8)
<b>Climatic conditions</b>	
Temperature - Operation *1  - Storage/transport - Gradient	Tested according to IEC 60068-2-1, IEC 60068-2-2, IEC 60068-2-14  + 5° C to + 45° C + 5° C to + 50° C (with a total sum of max. 20 W for the slots) + 5° C to + 55° C (with a total sum of max. 10 W for the slot)  – 20° C to +60° C  max. 10° C/h in operation, 20° C/h storage, no condensation
Relative humidity -Operation -Storage/transport	tested to IEC 60068-2-78, IEC 60068-2-30 5% to 80% at 25° C (no condensation) 5% to 95 % at 25° C (no condensation)
<b>Mech. ambient conditions</b>	
Vibration - in operation *2, *3 - storage/transport	tested to DIN IEC 60068-2-6 10 to 58 Hz: 0,075 mm, 58 to 500 Hz: 9.8 m/s <sup>2</sup> 5 to 9 Hz: 3.5 mm, 9 to 500 Hz: 9,8 m/s <sup>2</sup>
Shock resistance - in operation *3 - storage / transport	Tested to IEC 60068-2-27, IEC 60068-2-29 50 m/s <sup>2</sup> , 30 ms, 250 m/s <sup>2</sup> , 6 ms
<b>Special features</b>	
Quality assurance	to ISO 9001
<b>Motherboard</b>	
Processor	Celeron 1.5 GHz, 400 MHz Front Side Bus, 1024 KB second level cache Pentium M 1.6 / 2 GHz, 533 MHz Front Side Bus, 2048 KB second level cache
Internal processor cache	
Front Side Bus	
RAM	2 sockets maximum 2GB SDRAM DDR2 533 MHz See order documentation for expansion memory
Free expansion slots	1x PCI 265 mm long 1x PCI 175 mm long
Max. admissible power consumption per PCI slot	5 V/ 2 A or 3.3 V/ 2A, 12 V/ 0.3 A, -12 V/ 0.05 A The accumulated power consumption (all slots) may not exceed 30 W

<b>General technical data</b>	
<b>Disk drives</b>	
Hard disk	3.5" / 2.5" Serial ATA, See order documentation for hard disk capacity - 1.5 Gbit/s data transmission rate - supports NCQ (Native Command Queuing; SATA II property)
CD-ROM, DVD-ROM/CD-RW *2	ATA 33, See order documentation for features
<b>Graphic</b>	
Graphic controller	Intel
Graphic memory	Graphics memory 8 to 132 MB SDRAM, some using dynamic sharing of system RAM
Resolutions/frequencies/colors	VGA: 1600x1200 / 32-bit color depth / 85 Hz DVI-I: 1600 x 1200 / 32-bit color depth / 60 Hz LCD: 1280 x 1024 / 18-bit
<b>Interfaces</b>	
DVI	Port for external CRT / LCD monitor
USB	External: 4x USB 2.0 on the port side (max. 2 can be simultaneously operated as high current) Internal: 2x USB 2.0 (1x high current, 1x low current) Front panel ports: 1x USB 2.0 high current 1x USB 1.1 high current
PROFIBUS / MPI interface *4 - Transmission speed  - Operating mode  - Physical interface - Memory address space - Interrupts	9-pin Cannon socket 9.6 Kbps to 12 Mbps, software-selectable potential isolation: - Data lines A,B - Control lines RTS AS, RTS_PG - 5V supply voltage (max. 90 mA) Ground connection: - DP12 connector cable shield  RS485, potential isolated *5 Automatically configured Automatically configured
Ethernet	2x Ethernet port (RJ45), 10/100 Mbit, VIA MAC. VT6106S
COM1	Serial port 1 9-pin Cannon socket
Compact Flash	Slot for Compact Flash Card
<b>Status displays on the device</b>	
	DVD/CD access (to CD drive if installed) Status LED for post codes (below the 7 segment displays)

\*1 Restrictions for DVD-ROM/CD-RW: Burner operation only allowed under ambient conditions +5° C to +40°C

\*2 Restriction for DVD-ROM and DVD-ROM/CD-RW drives:  
10 to 58 Hz: 0.019 mm / 58 to 500 Hz: 2.5 m/s<sup>2</sup>  
Burner can only be operated in an undisturbed environment

14.2 Power requirements of the components

\*<sup>3</sup> restriction for installation with leaf mounting kit  
 Vibration: 10-58 Hz: 0.0375 mm / 58-500 Hz: 4.9 m/s<sup>2</sup>  
 shock resistance: 25 m/s<sup>2</sup>, 30 ms

\*<sup>4</sup> Optional product feature

\*<sup>5</sup>Electrically isolated within the safety extra-low voltage circuit (SELV)

## 14.2 Power requirements of the components

### Basic device

Components	Voltage			
	+5 V	+3.3 V	+12 V	-12 V
Motherboard	1.8 A	2.1 A	0.01 A	0.02 A
Pentium M or Celeron M processor	5 A			
Hard diskdrive; 1x 3.5" or Hard disk-drive; 2x 2.5" <sup>1)</sup>	0.6 A		0.8 A	
DVD-ROM- or DVD-ROM/CD-RW drive <sup>1)</sup>	0.8 A			
Equipment fan			0,4 A	
Power supply fan			0,15 A	
<b>Total (base device)</b>	<b>8.2 A</b>	<b>2.1 A</b>	<b>1.36 A</b>	<b>0.02 A</b>
PCI slots (total)	4 A	<sup>2)</sup>	0.6 A	0.20 A
Front panel port	1.1 A	0.1 A	4.2 A	
<b>Single lines of current (max. permissible)</b>	<b>16.5 A <sup>3)</sup></b>	<b>8.5 A <sup>3)</sup></b>	<b>6,5 A</b>	<b>0.3 A</b>

<b>Total power (max. permissible)</b>	150 W
---------------------------------------	-------

<sup>1)</sup> Depends on the selected device configuration

<sup>2)</sup> The PCI slots can be operated both 5 V and on 3.3 V at the same power loss.

<sup>3)</sup> The max. permitted accumulated power of the +5 V and + 3.3 V is 90 W.

## 14.3 AC voltage supply

### Technical data

Degree of protection	IP20 (in installed state)
Protection class	VDE 0106

#### Note

The power supply contains an active PFC (Power Factor Correction) circuit to conform to the EMC guidelines.

Uninterruptible AC power systems (UPS) must supply a sinusoidal output voltage in the normal and buffered mode when used with SIMATIC PCs with an active PFC.

UPS characteristics are described and classified in the standards EN 50091-3 and IEC 62040-3. Devices with sinusoidal output voltage in the normal and buffered mode are identified with the classification "VFI-SS-...." or "VI-SS-....".

### Output voltages

Voltage	Max. current
+ 12 V	6,5 A peak 8 A
- 12 V	0,3 A
+ 5 V	16.5 A <sup>1)</sup> Peak 18.5 A
+ 3.3 V	8.5 A <sup>1)</sup>

<sup>1)</sup> The max. permitted accumulated power of the +5 V and + 3.3 V is 90 W.

### Power Good Signal of the AC power supply

Power-Good-Signal:

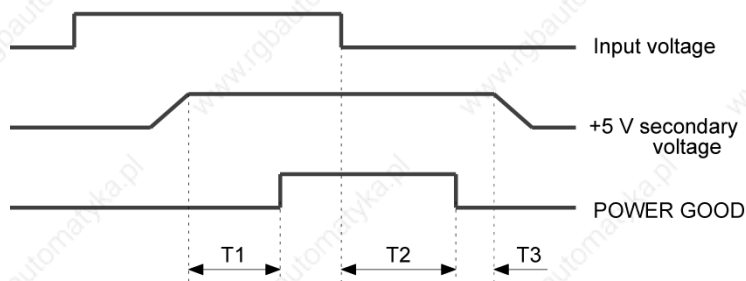

T1:	preset time	100 ... 500 ms
T2:	hold-up time	20 ms minimum
T3:	save time	1 ms minimum

## 14.4 DC power supply

### Technical data

Degree of protection	IP20 (in installed state)
Protection class	VDE 0106

### Output voltages

Voltage	Max. current
+ 12 V	6,5 A peak 8 A
- 12 V	0,3 A
+ 5 V	16.5 A <sup>1)</sup> Peak 18.5 A
+ 3.3 V	8.5 A <sup>1)</sup>

<sup>1)</sup> The max. permitted accumulated power of the +5 V and + 3.3 V is 90 W.

### Power Good Signal of the DC power supply

Power-Good-Signal:

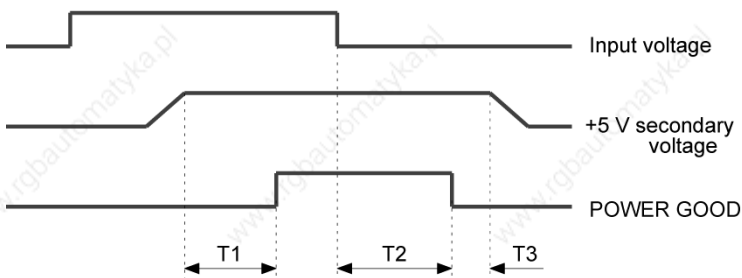

T1:	preset time	100 ... 500 ms
T2:	hold-up time	not specified
T3:	save time	1 ms minimum

## Dimensional Drawings

### 15.1 Dimensional Drawing of the Device

All dimensions are in millimeters

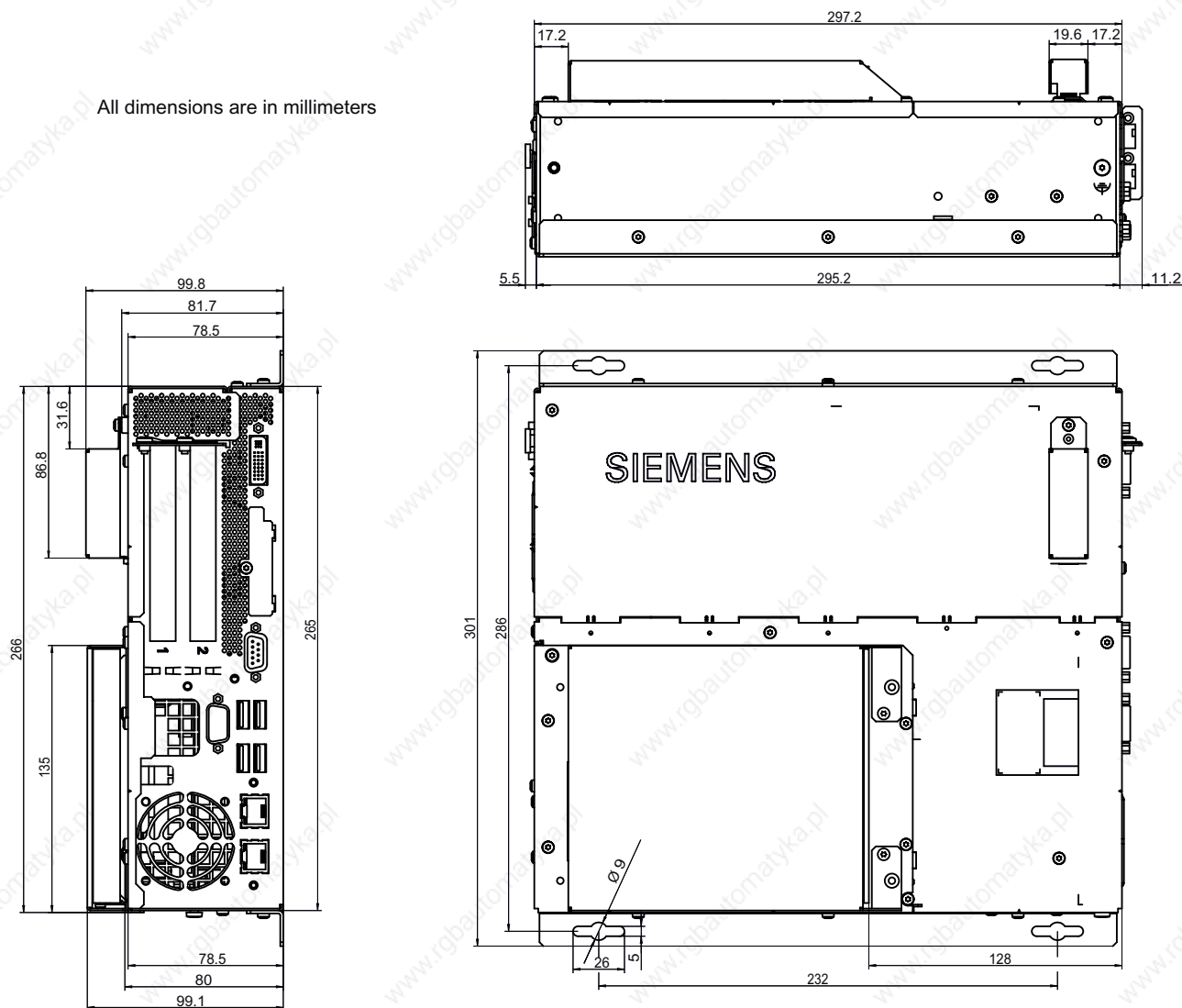

Figure 15-1 Dimensional drawing for mounting with angle bracket

Dimensional Drawings

15.1 Dimensional Drawing of the Device

- 1) M3 - 6.5 deep
- 2) M4 - 6.5 deep
- 3) M4 - 6.5 deep (only available on this side)

All dimensions are in millimeters

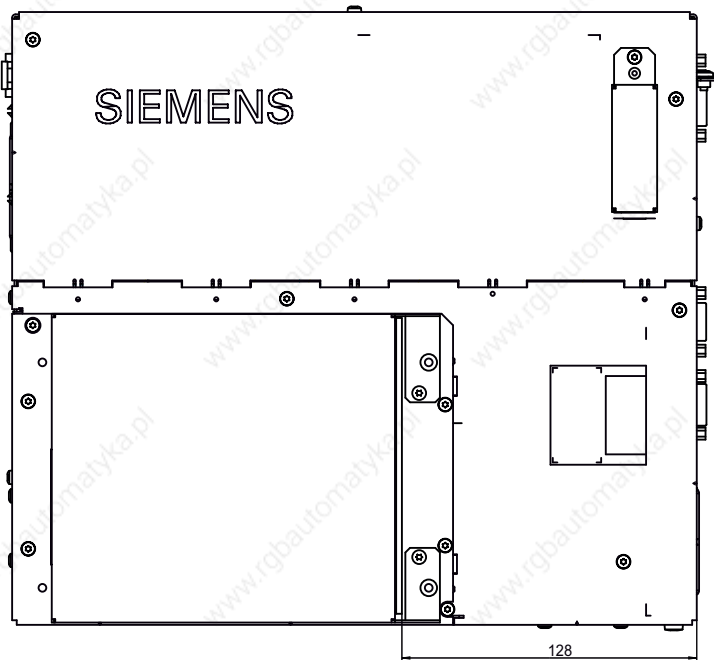
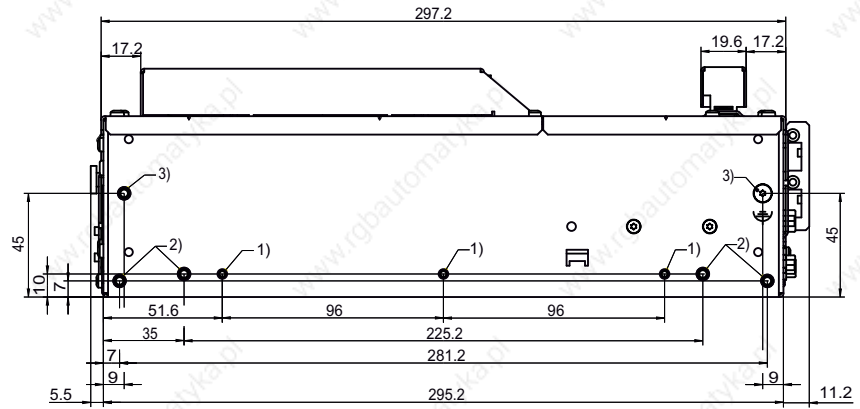
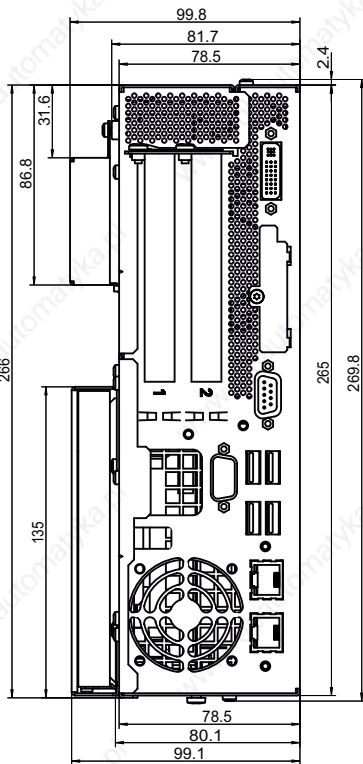

Figure 15-2 Dimensional drawing for mounting without angle bracket

**Notice**

When mounting devices with optical drives or WinAC backup batteries change the fitting depth.



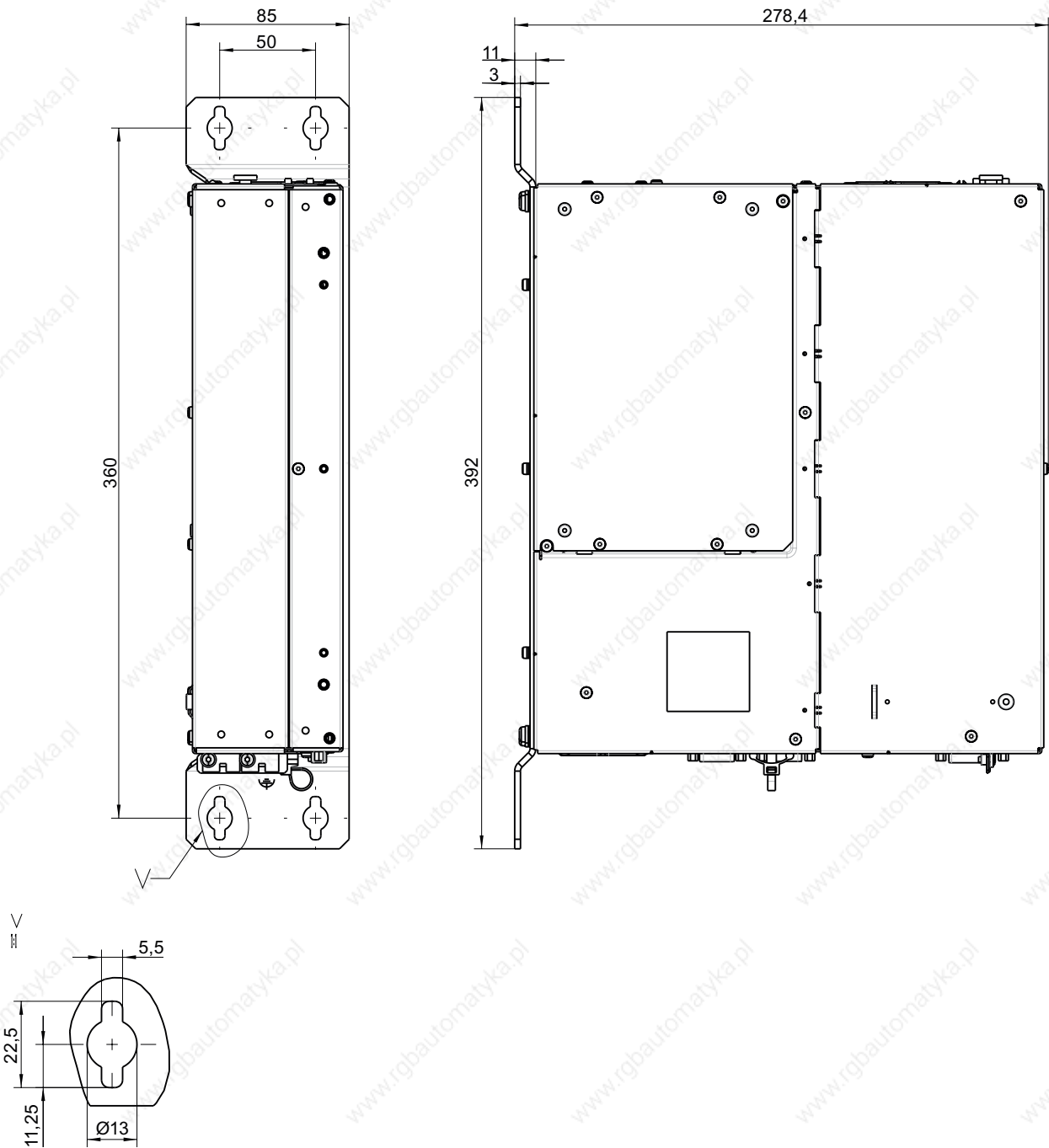

Figure 15-3 Dimensional drawing for mounting with the vertical mounting kit

## 15.2 Dimensional drawings for the installation of expansion modules

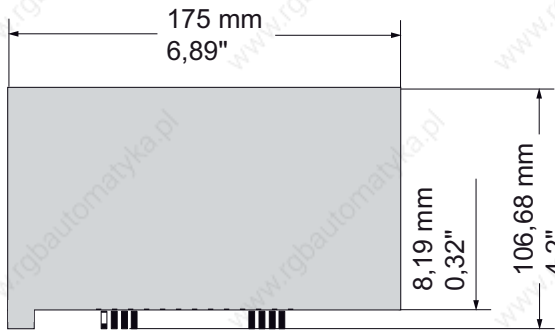

Figure 15-4 Short PCI modules (5V)

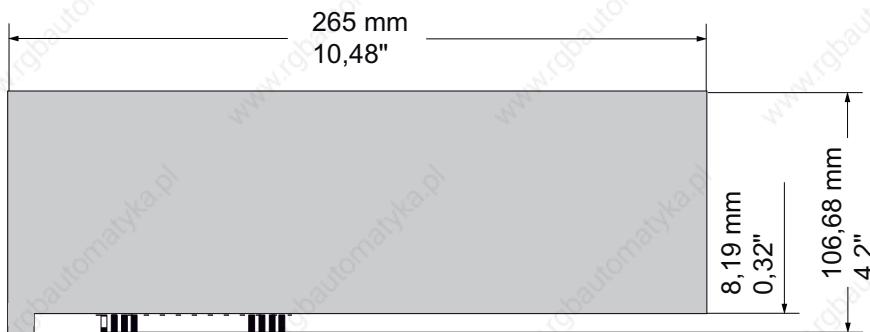

Figure 15-5 Maximum size of PCI module

## Detailed descriptions

### 16.1 Motherboard

#### 16.1.1 Structure and functions of the motherboard

The essential components of the motherboard are the processor and the chip set, two slots for memory modules, internal and external interfaces and the Flash BIOS.

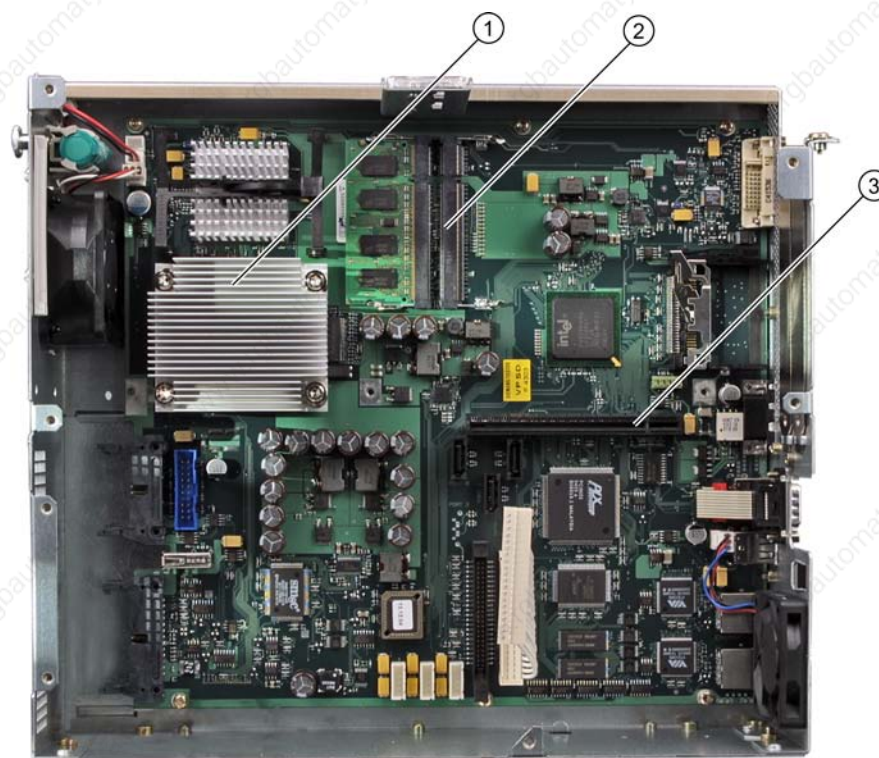

(1)	Processor heat sink
(2)	Two memory module slots
(3)	Slot for the bus board

## 16.1.2 Technical features of the motherboard

Component / interface	Description	Characteristics
Chip set	Single chip set	Mobile Intel 915 GM
BIOS	Update by means of software	Phoenix BIOS <ul style="list-style-type: none"> <li>V05.01.xx (with Profibus)</li> </ul>
CPU	Intel © Pentium M / Intel © Celeron M	Upgradable <ul style="list-style-type: none"> <li>Multimedia support</li> <li>On-board L2 cache with 2048/1024 KB</li> </ul>
Memory	2 DIMM module slots, max. 1 GB/DIMM	<ul style="list-style-type: none"> <li>64-bit data bus width</li> <li>3.3 V</li> <li>SDRAM DDR2</li> <li>Up to 1024 Mbit chip size on the module</li> <li>400/533 MHz bus clock <sup>3</sup></li> <li>256 MB to 2 GB/DIMM variable</li> </ul>
Figure	integrated in chip set	<ul style="list-style-type: none"> <li>Mobile Intel 915GM/GMS, 910GML Express Chipset Family</li> <li>VGA: 1600x1200/32-bit color depth/85 Hz</li> <li>DVI-I: 1600x1200/32-bit color depth/85 Hz</li> <li>LCD: 1280x1024/18 bit colors</li> <li>Graphics memory: 8-128 Mbytes, assigned in system memory, 8 Mbytes are reserved.</li> </ul> <p>For system memory 128 MBytes: Additional dynamic assignment of up to 32 MBytes; for system memory 256 Mbytes-2Gbytes: additional dynamic assignment up to 128 MBytes</p>
Hard disk	2 channels, Serial ATA	Serial ATA 1.5 Mbps
RAID	On-board Serial ATA	<ul style="list-style-type: none"> <li>Intel 82801 FR SATA RAID controller</li> <li>RAID 0, 1, 0+1</li> </ul>
DVD-ROM <sup>4</sup> DVD-ROM/CD-RW <sup>4</sup>	Master on parallel ATA interface or connection, Serial ATA	- UDMA-capable, ATA33
PROFIBUS/MPI	Communication port SIMATIC S7	<ul style="list-style-type: none"> <li>Potential isolated <sup>1</sup> CP 5611 compatible</li> <li>12 Mbaud</li> </ul>
USB	Universal Serial Bus	<ul style="list-style-type: none"> <li>External: 4x USB 2.0 on the port side (max. 2 can be simultaneously operated as high current)</li> <li>Internal: 2x USB 2.0 (1x high current, 1x low current)</li> <li>Front panel ports: 1x USB 2.0 high current</li> </ul>
Ethernet	2x 10BaseT/100Base-TX	-10/100 Mbps, potentially isolated <sup>1</sup>

<sup>1</sup> Electrically isolated within the safety extra-low voltage circuit (SELV)

<sup>2</sup> Optional product feature

<sup>3</sup> Depends on the CPU type

<sup>4</sup> Depends on the selected device configuration

### 16.1.3 Position of the ports on the motherboard

#### Interfaces

The motherboard of the device features the following interfaces:

- Interfaces for the connection of external devices
- Interfaces for internal connections (drives, bus boards etc.)

The figure below shows the location of the internal and external interfaces on the motherboard.

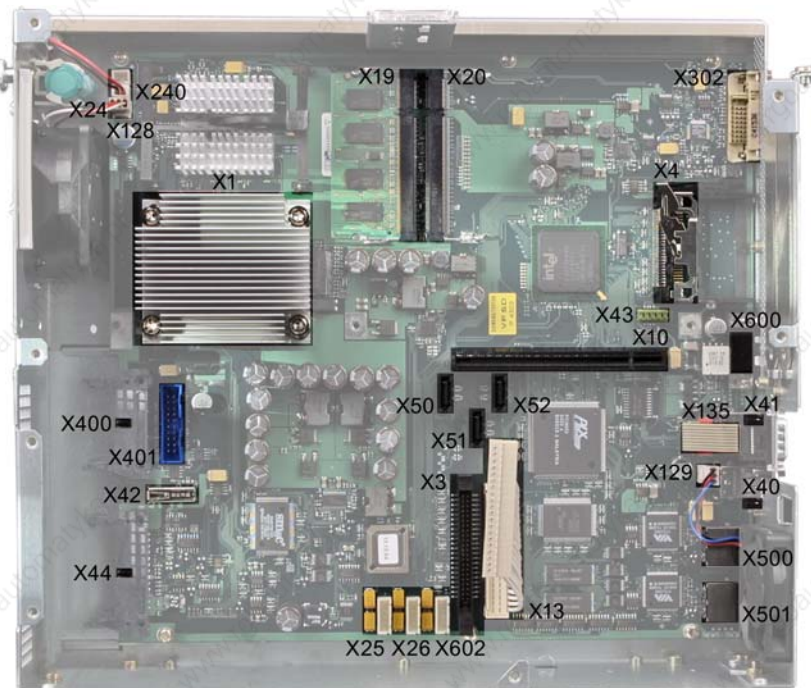

### 16.1.4 External ports

Interface	Position	Connector	Description
USB 2.0	external	X40 X41	X40 lower USB channel 0, X40 upper USB channel 2 X41 lower USB channel 4, X41 upper USB channel 5
PROFIBUS / MPI	external	X600	9-pin, standard socket, potentially isolated port
Ethernet	external	X500 X501	X500 first RJ45 port X501 second RJ45 port
DVI-I	external	X302	26-pin socket
Compact Flash	external	X4	50-pin CF socket, types I / II
COM1	external	X135	Serial interface

#### USB ports, X40, X41

The Universal Serial Bus port has the following pinout:

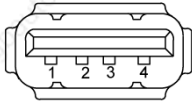
USB port			
			
Pin No.	Abbreviation	Meaning	Input /Output
1	VCC	+ 5 V (fused)	Output
2	- Data	Data channel	Input /Output
3	+ Data	Data channel	Input /Output
4	GND	Ground	-

The connectors are of type A.

All ports are designed as high current USB (500 mA), you can only use a maximum of 2 simultaneously as high current, however.

## PROFIBUS / MPI interface, X600

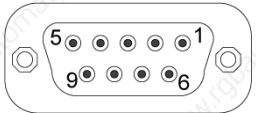
PROFIBUS/MPI interface <sup>1)</sup>			
			
PinNo.	Abbreviation	Meaning	Input /Output
1	–	Not assigned	–
2	–	Unassigned	–
3	LTG_B	Signal line B of MPI module	Input/output
4	RTS_AS	RTSAS, control signal for received data stream. The signal is "1" active when the directly connected PLC is sending.	Input
5	M5EXT	M5EXT return line (GND) of the 5 V power supply. The current load caused by an external consumer connected between P5EXT and M5EXT must not exceed the maximum of 90 mA.	Output
6	P5 EXT	P5EXT power supply (+5 V) of the 5 V power supply. The current load caused by an external consumer connected between P5EXT and M5EXT must not exceed the maximum of 90 mA.	Output
7	–	not assigned	–
8	LTG_A	Signal line A of MPI module	Input/output
9	RTS_PG	RTS output signal of the MPI module. The control signal is "1" when the PG is sending.	Output
Shield		on connector casing	

<sup>1)</sup> Optional product feature

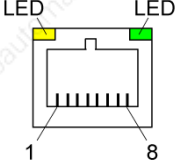

Ethernet RJ45 connection, X500, X501

Ethernet RJ45 connection			
			
PinNo.	Abbreviation	Meaning	Input /Output
1	TD+	Transmitted data	Output
2	TD-	Transmitted data	Output
3	RD+	Received data	Input
4, 5 <sup>1</sup>	SYMR	Internal 75-Ohm terminating resistor	–
6	RD-	Received data	Input
7, 8 <sup>1</sup>	SYMT	Internal 75-Ohm terminating resistor	–
S		Shield	–
	LED green	Off: 10 Mbps Lit: 100 Mbps	–
	LED yellow	Lit: Active connection (e.g. to a hub) Flashing: Activity	–

<sup>1</sup> is not necessary for data transfer

## DVI-I port, X302

DVI-I port			
PinNo.	Abbreviation	Meaning	Input /Output
S	GND	Ground	–
S1	GND	Ground	–
C1	R	Red	Output
C2	G	Green	Output
C3	B	Blue	Output
C4	HSYNC	Horizontal synchronizing pulse	Output
C5	GND	Ground	–
CSA	GND	Ground	–
1	TX2N	TDMS data 2-	Output
2	TX2P	TDMS data 2+	Output
3	GND	Ground	–
4	NC	not assigned	–
5	NC	not assigned	–
6	DDC CLK	DDC clock	Input /Output
7	DDC CLK	DDC data	Input /Output
8	VSYNC	Vertical synchronizing pulse	Output
9	TX1N	TDMS data 1-	Output
10	TX1P	TDMS data 1+	Output
11	GND	Ground	–
12	NC	not assigned	–
13	NC	not assigned	–
14	+5 V	+5 V	Output
15	GND	Ground	–
16	MONDET	Hotplug detect	Input
17	TX0N	TDMS data 0-	Output
18	TX0P	TDMS data 0+	Output
19	GND	Ground	–
20	NC	not assigned	–
21	NC	not assigned	–
22	GND	Ground	–
23	TXCP	TDMS clock +	Output
24	TXCN	TDMS clock -	Output

Compact Flash Card, X4

Compact Flash card port		
Pin No.	Abbreviation	Meaning
41	RESET#	Reset (output)
7	CS0#	Chip select 0(output)
32	CS1#	Chip select 1(output)
34	IORD#	I/O read (output)
35	IOWR#	I/O write (output)
20, 19, 18,	A0-A2	Address bit 0-2 (output)
17, 16, 15, 14, 12, 11, 10, 8	A3-A10	Address bit 3-10 (output) to ground
21, 22, 23, 2, 3, 4, 5, 6, 47, 48, 49, 27, 28, 29, 30, 31	D0-D15	Data bits 0-15 (in/out)
37	INTRQ	Interrupt request (input)
9	OE# /ATA SEL#	Enables True IDE mode
24	IOCS16#	I/O-chip select 16 (input)
39	CSEL#	Cable select (output)
42	IORDY	I/O ready (input)
46	PDIAG#	Passed diagnostic
45	DASP#	Drive active/slave present (not connected)
26, 25	CD1#, CD2#	Card detect (not connected)
33, 40	VS1#, VS2#	Voltage sense (not connected)
43	DMARQ	DMA request (input)
44	DMACK#	DMA acknowledge (output)
36	WE#	Write enable
1, 50	GND	Ground
13, 38	VCC	+ 3.3V power

**Serial port COM1, X135**

The COM1 serial port has the following pin assignment:

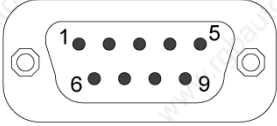
Serial interface COM1			
			
PinNo.	Abbreviation	Meaning	Input /Output
1	DCD (M5)	Receiving signal level carrier	Input
2	RxD (D2)	Received data	Input
3	TxD (D1)	Transmitted data	Output
4	DTR (S1)	Data terminal ready	Output
5	GND (E2)	Functional ground (reference potential)	–
6	DSR (M1)	Ready for operation	Input
7	RTS (S2)	Request to send	Output
8	CTS (M2)	Clear to send	Input
9	RI (M3)	Incoming call	Input

## 16.1.5 Front ports

### Overview

Ports	Position	Connector	Description
Display (LVDS)	Internal	X400	Connection of LCD displays with LVDS interface (channel 1)
Display (LVDS)	Internal	X401	Connection of LCD displays with LVDS interface (channel 2)
I/O front	Internal	X44	Ports for front I/O front, including USB channel 1
USB	Internal	X42	Internal USB 2.0 interface (USB channel 3)

### Display interfaces

TFT displays with an LVDS interface can be connected to this interface. You can connect 18-bit displays with a resolution up to 1024x768 pixels on X400 only (single-channel LVDS), and of 1280 x 1024 pixels on X400 and X401 (dual-channel LVDS). On the X401 there is also +12VF as supply voltage for the backlight inverter (max. 4.2A) for 19" / Dual Channel LVDS displays. The permitted display clock rate is 20MHz to 66MHz. The display is selected automatically based on the code of the display select inputs.

The display supply voltages (3.3V and 5V) are switched via the graphics controller according to the requirements of the connected displays. The maximum cable length is 50 cm at a transmission rate of 455 MHz. Special cable properties are required for the differential cable pairs specified by the LVDS specification.

### Display interface (1st LVDS channel), X400

Pin-No.	Short description	Meaning	Input/Output
1	P5V_D_fused	+5V (fused) display VCC	Output
2	P5V_D_fused	+5V (fused) display VCC	Output
3	RXIN0-	LVDS output signal bit 0 (-)	Output
4	RXIN0+	LVDS output signal bit 0 (+)	Output
5	P3V3_D_fused	+3.3V (fused) display VCC	Output
6	P3V3_D_fused	+3.3V (fused) display VCC	Output
7	RXIN1-	LVDS output signal bit 1 (-)	Output
8	RXIN1+	LVDS output signal bit 1 (+)	Output
9	GND	Ground	-
10	GND	Ground	-
11	RXIN2-	LVDS output signal bit 2 (-)	Output
12	RXIN2+	LVDS output signal bit 2 (+)	Output
13	GND	Ground	-
14	GND	Ground	-
15	RXCLKIN-	LVDS clock signal (-)	Output

Pin-No.	Short description	Meaning	Input/Output
16	RXCLKIN+	LVDS clock signal (+)	Output
17	GND	Ground	-
18	GND	Ground	-
19	NC	Not assigned	-
20	NC	Not assigned	-

### Display interface (2nd LVDS channel), X401

Pin-No.	Short description	Meaning	Input/Output
1	GND	Ground	-
2	GND	Ground	-
3	RXIN10-	LVDS input signal bit 0 (-)	Output
4	RXIN10+	LVDS input signal bit 0 (+)	Output
5	GND	Ground	Output
6	GND	Ground	Output
7	RXIN11-	LVDS input signal bit 1 (-)	Output
8	RXIN11+	LVDS input signal bit 1 (+)	Output
9	GND	Ground	-
10	GND	Ground	-
11	RXIN12-	LVDS input signal bit 2 (-)	Output
12	RXIN12+	LVDS input signal bit 2 (+)	Output
13	GND	Ground	-
14	GND	Ground	-
15	RXCLKIN1-	LVDS clock signal (-)	Output
16	RXCLKIN1+	LVDS clock signal (+)	Output
17	GND	Ground	-
18	P12VF	+12V fused	Output
19	P12VF	+12V fused	Output
20	P12VF	+12V fused	Output

**Assignment of the display to the display select pins**

One of the 15 available displays is configured automatically via the display select inputs. The display select inputs are connected to pull-up resistors, i.e. if these inputs are not interconnected, they are high level. In order to create a low level input, the input must be connected with GND.

Pin-No.	LCD_SEL3	LCD_SEL2	LCD_SEL1	LCD_SEL0	Display type
0	low	low	low	low	reserved
1	low	low	low	high	1280x1024 (SXGA), TFT, 2 x 18Bit, LVDS-channel 1 and 2
2	low	low	high	low	DVI LCD 640 x 480
3	low	low	high	high	DVI LCD 800 x 600
4	low	high	low	low	640 x 480 (VGA), TFT, 18 Bit, LVDS-channel 1
5	low	high	low	high	reserved
6	low	high	high	low	1024 x 768 (XGA), TFT, 18 Bit, LVDS-channel 1
7	low	high	high	high	800 x 600 (SVGA), TFT, 18 Bit, LVDS-channel 1
8	high	low	low	low	reserved
9	high	low	low	high	reserved
10	high	low	high	low	reserved
11	high	low	high	high	reserved
12	high	high	low	low	1024 x 768 (XGA), TFT, 2 x 18-bit, LVDS channel 1 and 2
13	high	high	low	high	DVI LCD 1024 x 768
14	high	high	high	low	DVI LCD 1280 x 1024
15	high	high	high	high	No LVDS display or DVI LCD with automatic DDC ID



**I/O Front Interface for Operator Panels, X44**

This interface carries all signals required for connecting operator panels in addition to the display interface. The maximum cable length is 50 cm at a USB data rate of 12 Mbit/s.

Pin-No.	Short description	Meaning	Input/Output
1	GND	Ground	-
2	P12V	Inverter voltage supply	Output
3	BL_ON	Backlight on (5 V = On)	Output
4	P5V_fused	+5 V (fused)	Output
5	GND	Ground	-
6	P3V3_fused	+3.3 V VCC (fused)	Output
7	Reserved	reserved	-
8	Reserved	reserved	-
9	Reserved	reserved	-
10	Reserved	reserved	-
11	P5V_fused	+5 V (fused)	Output
12	USB_D1M	USB data channel 1	Input/Output
13	USB_D1P	USB data+, channel 1	Input/Output
14	GND	Ground	-
15	LCD_SEL0	Display Type-Select Signal 0	Input
16	LCD_SEL1	Display Type-Select Signal 1	Input
17	LCD_SEL2	Display Type-Select Signal 2	Input
18	LCD_SEL3	Display Type-Select Signal 3	Input
19	RESET_N	Reset signal (active low)	Input
20	reserved	reserved	-
21	HD_LED	HD LED, anode with 1 kW in series on the motherboard	Output
22	DP_LED	MPI/DP LED, anode via 1 KOHms in series on the motherboard	Output
23	Ethernet_LED	Ethernet LED, anode with 1 kW in series on the motherboard	Output
24	TEMP_ERR	Temperature error LED, anode with 1 kW in series on the motherboard	Output
25	RUN_R	Watchdog error LED, anode with 1 kW in series on the motherboard	Output
26	RUN_G	Watchdog OK LED, anode with 1 kW in series on the motherboard	Output

## Pin Assignment of the USB 2.0 interface, X42

Pin-No.	Short description	Meaning	Input/Output
1	VCC	+ 5 V, fused	Output
2	USB5	USB5_M	Input/Output
3	USB5	USB5_P	Input/Output
4	GND	Ground	-
S1	S	Shield	-
S2	S1	Shield	-

**Note**

For detailed information on the pin assignments of the interfaces, please contact Customer Support or the Repair Center.

## 16.1.6 Internal interfaces

## Pin assignment of the internal ports

Interface	Position	Connector	Description
Memory	Internal	X19, X20	2 DIMM sockets, 64-bit
Processor	Internal	X1	Socket for FCPGA processor
Bus expansion	Internal	X10	Socket for bus expansion, assigned PCI bus signals
Power supply	Internal	X13	20-pin connector plug for power supply
Hard disk drive Serial ATA	Internal	X50, X51	Serial ATA, max. 2 drives operable
Optical drive Serial ATA	Internal	X52	Serial ATA, max. 1 drive operable
Connection for PS serial ATA	Internal	X25, X26, X602	Power supply for serial ATA
Optical drive Parallel ATA	Internal	X3	44-pin, 2mm male connector
Connection for PS fan	Internal	X129	Power supply for CPU fan, 3-pin male connector
Connection for equipment fan	Internal	X128	Power supply for equipment fan, 3-pin male connector
Backup battery	Internal	X24	Power supply for backup battery, 2-pin male connector
Tap for backup battery	Internal	X240	Voltage tap ( = 3V) of the backup battery, 2-pin, male connector
USB interface	Internal	X43	USB channel 6 and 7

## Connection for optical drive, X3

Pin No.	Abbreviation	Meaning	Input /Output
1	Reserved	Reserved	-
2	Reserved	Reserved	-
3	Reserved	Reserved	-
4	GND	Ground	-
5	Reset	Reset signal	Input /Output
6	D8	Data signal D8	Input /Output
7	D7	Data signal D7	Input /Output
8	D9	Data signal D9	Input /Output
9	D6	Data signal D6	Input /Output
10	D10	Data signal D10	Input /Output
11	D5	Data signal D5	Input /Output
12	D11	Data signal D11	Input /Output
13	D4	Data signal D4	Input /Output
14	D12	Data signal D12	Input /Output
15	D3	Data signal D3	Input /Output
16	D13	Data signal D13	Input /Output
17	D2	Data signal D2	Input /Output
18	D14	Data signal D14	Input /Output
19	D1	Data signal D1	Input /Output
20	D15	Data signal D15	Input /Output
21	D0	Data signal D0	Input /Output
22	DREQ	DMA request	Input
23	GND	Ground	-
24	IOR_N	Read signal	Output
25	IOW_N	Write signal	Output
26	GND	Ground	-
27	IORDY	Ready signal	Input
28	DACK_N	DMA acknowledgment	Output
29	IRQ15	Interrupt signal	Input
30	AD_1	Address 1	Output
31	AD_0	Address 0	Output
32	AD_2	Address 2	Output
33	CS_N	Chip select signal	Output
34	HDACT_N	Activity	Input
35	CS1_N	Chip select 1	-
36	CSEL	Chip select signal	-
37	GND	Ground	-
38	P5V	+5 V voltage supply	Output
39	P5V	+5 V voltage supply	Output
40	P5V	+5 V voltage supply	Output
41	P5V	+5 V voltage supply	Output

**Pin assignment of the equipment fan, X128**

Pin No.	Abbreviation	Meaning	Input /Output
1	GND	Ground	-
2	+12 V	Switched power supply	Output
3	CPU FAN_CLK	Clock signal	Input

**Pin assignment of the supply for the power supply fan, X129**

Pin No.	Abbreviation	Meaning	Input /Output
1	GND	Ground	-
2	+12 V	Switched power supply	Output
3	PG1 FAN_CLK	Clock signal	Input

**Connection for backup battery, X24 (BATT)**

A battery for buffering the CMOS RAM is connected to this connector. This is a 3 V Lithium battery with a capacity of 750 mAh.

Pin No.	Abbreviation	Meaning	Input /Output
1	+	Plus pole	Input
2	-	Minus pole	-

**Tap of the backup battery, X240 (OUT)**

This connection is intended for expansion modules with on-board CMOS-RAM. The voltage of the backup battery can be tapped here to backup the CMOS RAM data of the expansion module.

Pin No.	Abbreviation	Meaning	Input /Output
1	+	Plus pole	Output
2	-	Minus pole	-

**Notice**

No battery should be connected to this connection.

**Pin assignment of the supply for the serial ATA drives X25, X26, X602**

Pin No.	Abbreviation	Meaning	Input /Output
1	+12 V	Power supply	Output
2	GND	Ground	-
3	GND	Ground	-
4	+5 V	Power supply	Output
5	+3.3 V	Power supply	Output

### Pin assignment of the internal USB interface connector, X43

Pin No.	Abbreviation	Meaning	Input /Output
1	VCC 3.3V	+3.3V, fused	Output
2	VCC 5V	+ 5 V, fused	Output
3	USB3	USB3_M	Input /Output
4	USB5	USB5_M	Input /Output
5	USB3	USB3_P	Input /Output
6	USB5	USB5_P	Input /Output
7	GND	Ground	–
8	GND	Ground	–
9	GND	Ground	–
10	GND	Ground	–

## 16.2 Bus board

### 16.2.1 Layout and principle of operation

The bus board is designed as a link between the motherboard and the expansion modules. It is fastened with two screws.

The bus board has two PCI slots (1x short, 1x long). It can host expansion modules conforming to PCI specification (Rev. 2.2) for 5 V and 3.3 V modules. All PCI slots are master-capable. The expansion modules are supplied with power via the bus board to motherboard connection.

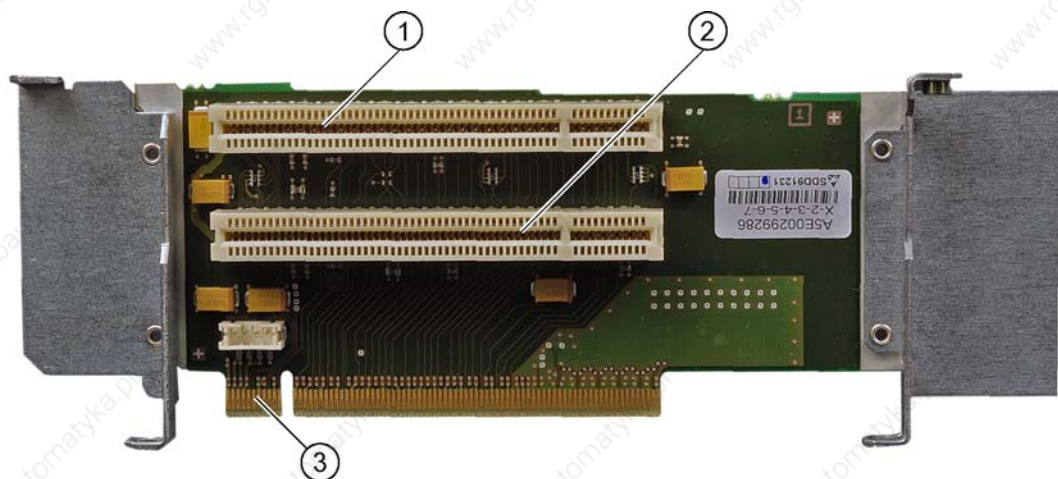

(1)	Slot 1
(2)	Slot 2
(3)	12V power supply connection for WinAC module

### 16.2.2 Interrupt assignment (PCI-IRQ)

Box PC 627	PCI devices interrupt assignment (PCI-IRQ)
INT – A	Graphics, USB A (channel 0+1), USB B (channel 2+ 3)
INT – B	Slot 1
INT – C	Slot 2
INT – D	Serial ATA
INT – E	Ethernet 1
INT – F	MPI/DP
INT – G	Ethernet 2, USB C (channel 4+5), USB D (channel 6 + 7)
INT - H	USB 2.0

### 16.2.3 Exclusive PCI hardware interrupt

Applications demanding a high-performance interrupt require a high-speed hardware interrupt reaction. The PCI hardware interrupt should be used only by one resource in order to ensure high-speed reaction of the hardware.

To enable this, the Ethernet 1, PROFIBUS/MPI interfaces and the two slots each have an exclusive interrupt.

	IRQ assignments for Windows XP Professional /2000 Professional operating systems (APIC mode)	IRQ assignments for DOS-based operating systems (PIC mode)
Ethernet 1	20	10
Profibus/MPI	21	7
Slot 1	17	5
Slot 2	18	3

## 16.2.4 PCI slot pin assignment

	5V System Environment	
	Side B	Side A
1	-12V	TRST#
2	TCK	+12V
3	Ground	TMS
4	TDO	TDI
5	+5V	+5V
6	+5V	INTA#
7	INTB#	INTC#
8	INTD#	+5V
9	PRSNT1#	Reserved
10	Reserved	+5V (I/O)
11	PRSNT2#	Reserved
12	Ground	Ground
13	Ground	Ground
14	Reserved	Reserved
15	Ground	RST#
16	CLK	+5V (I/O)
17	Ground	GNT#
18	REQ#	Ground
19	+5V (I/O)	Reserved
20	AD[31]	AD[30]
21	AD[29]	+3.3V
22	Ground	AD[28]
23	AD[27]	AD[26]
24	AD[25]	Ground
25	+3.3V	AD[24]
26	C/BE[3]#	IDSEL
27	AD[23]	+3.3V
28	Ground	AD[22]
29	AD[21]	AD[20]
30	AD[19]	Ground
31	+3.3V	AD[18]
32	AD[17]	AD[16]
33	C/BE[2]#	+3.3V
34	Ground	FRAME#
35	IRDY#	Ground
36	+3.3V	TRDY#
37	DEVSEL#	Ground
38	Ground	STOP#



	5V System Environment	
	Side B	Side A
39	LOCK#	+3.3V
40	PERR#	SDONE
41	+3.3V	SBO#
42	SERR#	Ground
43	+3.3V	PAR
44	C/BE[1]#	AD[15]
45	AD[14]	+3.3V
46	Ground	AD[13]
47	AD[12]	AD[11]
48	AD[10]	Ground
49	Ground	AD[09]
50	CONNECTOR KEY	
51	CONNECTOR KEY	
52	AD[08]	C/BE[0]#
53	AD[07]	+3.3V
54	+3.3V	AD[06]
55	AD[05]	AD[04]
56	AD[03]	Ground
57	Ground	AD[02]
58	AD[01]	AD[00]
59	+5V (I/O)	+5V (I/O)
60	ACK64#	REQ64#
61	+5V	+5V
62	+5V	+5V

### 16.2.5 Pin assignment 12V power supply connection for WinAC module

Pin	Short description	Meaning	Input /Output
1	+12V <sup>1</sup>	12V voltage	Output
2	GND	Ground	-
3	GND	Ground	-
4	+5V <sup>1</sup>	5V voltage	Output

1) max. permissible current: 1 A; with this power demand the total power demand for the PCI slots are not allowed to be exceeded.

## 16.3 System resources

### 16.3.1 Currently allocated system resources

All system resources (hardware address, memory configuration, IRQ, DMA channel) are assigned dynamically by the Windows OS, depending on the hardware configuration, drivers and connected peripheral devices. You can view the current configuration of system resources or possible conflicts with the following operating systems:

Windows 2000/XP	<b>Start &gt; Run</b> : in the <b>Run</b> dialog, enter <i>msinfo32</i> and confirm with <b>OK</b> .
-----------------	--

### 16.3.2 System resources used by the BIOS/DOS

The following table describes the system resources for the factory state of the device.

#### 16.3.2.1 I/O address allocation

I/O address (hex)		Description of the basic function	Possible alternative function
from	to		
0000	0CF7	DMA controller	
0020	0021	Programmable interrupt controller	
0024	0025	Programmable interrupt controller	
0028	0029	Programmable interrupt controller	
002C	002D	Programmable interrupt controller	
002E	002F	Basic unit resources	
0030	0031	Programmable interrupt controller	
0034	0035	Programmable interrupt controller	
0038	0039	Programmable interrupt controller	
003C	003D	Programmable interrupt controller	
0040	0043	System timer	
004E	004F	Basic unit resources	
0050	0053	System timer	
0060	0060	Keyboard controller	
0061	0061	Basic unit resources	
0063	0063	Basic unit resources	
0064	0064	Keyboard controller	
0065	0065	Basic unit resources	
0067	0067	Basic unit resources	
0070	0070	Basic unit resources	
0070	0070	System CMOS/real-time clock	
0080	0080	Basic unit resources	
0081	0091	DMA controller	

Detailed descriptions

16.3 System resources

I/O address (hex)		Description of the basic function	Possible alternative function
0092	0092	Basic unit resources	
0093	009F	DMA controller	
00A0	00A1	Programmable interrupt controller	
00A4	00A5	Programmable interrupt controller	
00A8	00A9	Programmable interrupt controller	
00AC	00AD	Programmable interrupt controller	
00B0	00B1	Programmable interrupt controller	
00B2	00B3	Basic unit resources	
00B4	00B5	Programmable interrupt controller	
00B8	00B9	Programmable interrupt controller	
00BC	00BD	Programmable interrupt controller	
00C0	00DF	DMA controller	
00F0	00F0	Numeric data processor	
01F0	01F7	Primary IDE channel	
0274	0277	ISA PNP Read Data Port	
0279	0279	ISA PNP Read Data Port	
03B0	03BB	Mobile Intel® 915GM/GMS, 910GML Express Chipset Family	
03C0	03DF	Mobile Intel® 915GM/GMS, 910GML Express Chipset Family	
03E0	03E7	Unused	
03F6	03F6	Primary IDE channel	
03F7	03F7	Standard floppy disk controller	
03F8	03FF	COM1	
04D0	04D1	Programmable interrupt controller	
0680	06FF	Motherboard resources	
0800	080F	Motherboard resources	
0A79	0A79	ISA PNP Read Data Port	
0D00	FFFF	PCI bus	
1000	107F	Motherboard resources	
1180	11BF	Motherboard resources	
1640	164F	Motherboard resources	
1800	1807	Mobile Intel® 915GM/GMS, 910GML Express Chipset Family	
1810	181F	Intel® 82801FB/FBM Ultra ATA Storage Controllers - 266F	
1820	183F	Intel® 82801FB/FBM USB Universal Host Controller - 2658	
1840	185F	Intel® 82801FB/FBM USB Universal Host Controller - 2659	
1860	187F	Intel® 82801FB/FBM USB Universal Host Controller - 265A	
1880	189F	Intel® 82801FB/FBM USB Universal Host Controller - 265B	
18B0	18BF	Intel® 82801FB Ultra ATA Storage Controllers - 2652	
18C4	18C7	Intel® 82801FB Ultra ATA Storage Controllers - 2652	
18C8	18CF	Intel® 82801FB Ultra ATA Storage Controllers - 2652	
18D0	18D7	Intel® 82801FB Ultra ATA Storage Controllers - 2652	
0018	18FF	Intel® 82801FB/FBM SMBus Controller - 266A	
2000	20FF	VIA Rhine III Fast Ethernet Adapter	
2400	24FF	VIA Rhine III Fast Ethernet Adapter #2	

### 16.3.2.2 Interrupt Assignments

Interrupt	Description	Comment
IRQ0	System timer	fixed
IRQ1	Keyboard	fixed
IRQ4	Serial port COM1	2)
IRQ8	Real-time clock (RTC)	fixed
IRQ9	Microsoft ACPI-Compliant System	1)
IRQ13	Numeric processor	fixed
IRQ14	1. IDE channel (primary)	2)
IRQ16	Mobile Intel 915GM/GMS, 910GML Express Chipset Family	1)
IRQ16	Intel® 82801FB/FBM USB Universal Host Controller - 2658	1)
IRQ 16	Intel® 82801FB/FBM USB Universal Host Controller -2659	1)
IRQ 19	Intel® 82801FB Ultra ATA Storage Controllers - 2652	1)
IRQ 20	VIA Rhine III Fast Ethernet Adapter	2)
IRQ 22	Intel® 82801FB/FBM Universal Host Controller - 265A	1)
IRQ 22	Intel® 82801FB/FBM Universal Host Controller -265B	1)
IRQ 22	VIA Rhine III Fast Ethernet Adapter #2	2)
IRQ 23	Intel® 82801FB/FBM USB2 Enhanced Host Controller - 265C	1)

PCI Interrupt Lines	PCI devices interrupt assignment (PCI IRQ)
INT – A	Graphics, USB A (channel 0+1), USB B (channel 2+ 3)
INT – B	Slot 1
INT – C	Slot 2
INT – D	Serial ATA
INT – E	Ethernet 1
INT – F	MPI/DP
INT – G	Ethernet 2, USB C (channel 4+5), USB D (channel 6 + 7)
INT - H	USB 2.0

1) The on-board PCI devices require PCI interrupt channels. These interrupt channels are sharable and plug and play compatible. This means several devices can share the same interrupt. Interrupts are assigned automatically (exception: see section, Exclusive PCI Hardware Interrupt).

2) These functions can be disabled in the Setup This releases allocated resources.

16.3.2.3 Memory address assignments

PCI VGA modules can be operated with an expansion ROM of a size up to 48 K.

Address		Description of the basic function	Possible alternative function
from	to		
000A 0000	000B FFFF	PCI bus	
000A 0000	000B FFFF	Mobile Intel® 915GM/GMS,910GML Express Chipset Family	
000D 0000	000D 3FFF	PCI bus	
000D 4000	000D 7FFF	PCI bus	
000D 8000	000D BFFF	PCI bus	
B000 0000	B003 FFFF	Mobile Intel® 915GM/GMS,910GML Express Chipset Family	
B004 0000	B004 03FF	Intel® 82801FB/FBM USB2 Enhanced Host Controller 265C	
B004 0400	B004 07FF	Intel® 82801FB Ultra ATA Storage Controllers	
B008 0000	B00F FFFF	Mobile Intel® 915GM/GMS,910GML Express Chipset Family	
B010 0000	B010 00FF	VIA Rhine III Fast Ethernet Adapter	
B010 0400	B010 04FF	VIA Rhine III Fast Ethernet Adapter #2	
C000 0000	CFFF FFFF	Mobile Intel® 915GM/GMS,910GML Express Chipset Family	
DFF8 0000	DFFF FFFF	Mobile Intel® 915GM/GMS,910GML Express Chipset Family	
E000 0000	FFFF FFFF	Motherboard resources	
F000 0000	F000 3FFF	Motherboard resources	
F000 8000	F000 BFFF	Motherboard resources	
F000 4000	F000 4FFF	Motherboard resources	
F000 5000	F000 5FFF	Motherboard resources	
F000 8000	F000 BFFF	Motherboard resources	
FF80 0000	FFFF FFFF	Intel® 82802 Firmware Hub Device	

## 16.4 BIOS Setup

### 16.4.1 Overview

#### BIOS Setup program

The BIOS SETUP program is stored in the ROM BIOS. Information about the system configuration is stored in the battery-backed RAM of the device.

You can use SETUP to set the hardware configuration (for example, the hard disk type) and define the system properties. You can also use SETUP to set the time-of-day and date.

#### Changing the device configuration

Your Rack PC device configuration is preset for working with the software supplied with the unit. You should only change the preset values if you have modified your Rack PC in any way, or if a fault occurs when the unit is powered up.

### 16.4.2 Starting BIOS Setup

#### Starting BIOS Setup

1. Start the setup program as follows:
2. Reset the device (warm or cold restart).

In the figures shown, the default settings differ based on the device versions. With the default settings on the Box PC, **for example**, the following screen appears after booting:

```
Phoenix BIOS 4.0 Release 6.0 A5E000xxxx-ES0x
Copyright 1985-2002 Phoenix Technologies Ltd.All Rights Reserved.
Siemens SIMATIC Box PC 627 Vxx.xx.xx
CPU = Intel® Pentium®M CPU X.XX GHz (X.XX depending on the processor)
640K System RAM Passed
127MB Extended RAM Passed
Press <F2> to enter SETUP or <ESC> to display the boot menu
```

On completion of the POST, the BIOS gives you the opportunity of starting the SETUP program. The following message appears on the screen:

```
Press < F2 > to enter SETUP or <ESC> to show boot menu
```

3. Press the F2 key as long as the BIOS prompt appears on the screen.

### 16.4.3 BIOS Setup menus

The various menus and submenus are listed on the next pages. You can obtain information on the selected SETUP item from the "item-specific help" part of the respective menu.

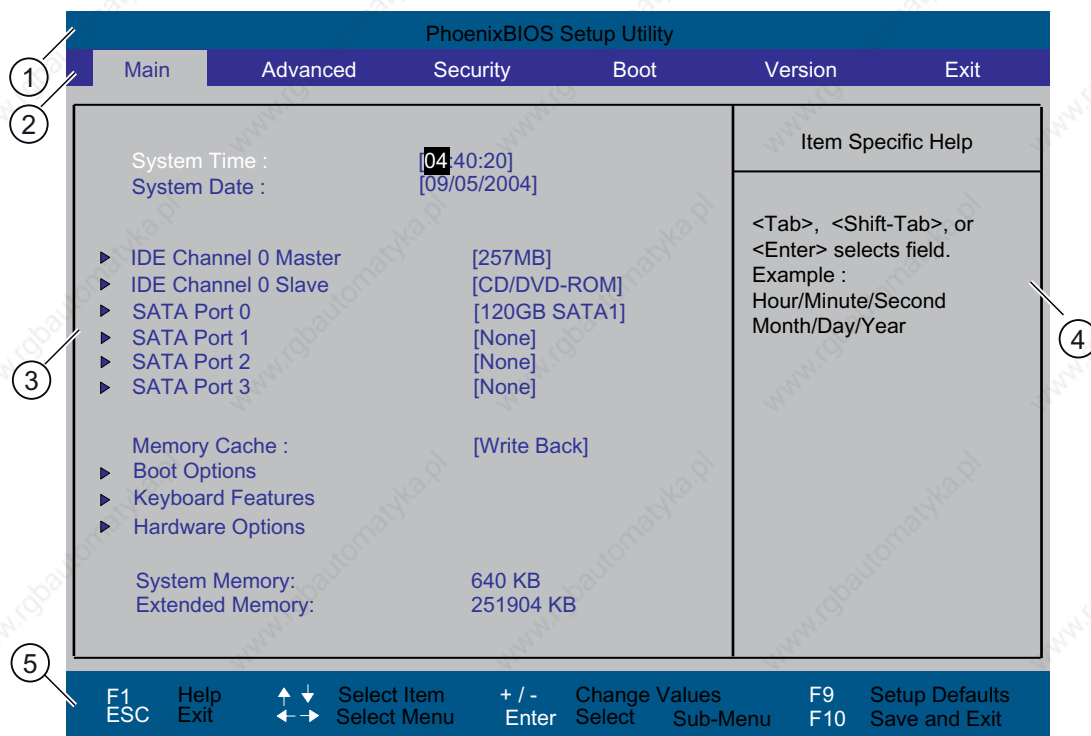

Figure 16-1 SETUP main menu (example)

(1) Header	(4) Help view
(2) Menu line	(5) Input line
(3) Selectable submenu	

#### Menu layout

The screen is divided into four sections. In the top part (2), you can select the menu forms [Main], [Advanced], [Security], [Boot], [Version], [Exit]. In the left of the center section (3) you can select various settings or submenus. Brief help texts appear on the right (4) for the currently selected menu entry. The bottom section contains information for operator input.

The figures below represent examples of specific device configurations. The screen content changes based on the supplied equipment configuration.

Yellow stars to the left of the interface designation (for example, Internal COM 1) indicate a resource conflict between the interfaces managed by the BIOS. In this case you should select the default settings (F9) or eliminate the conflict.

You can move between the menu forms using the cursor keys [←] left and [→] right.



Menu	Meaning
Main	System functions are set here
Advanced	An extended system configuration can be set here
Security	Security functions are set here, for example, a password.
Boot	This is where the boot priority is specified.
Version	Information about the programming device (for example, release status) can be found here.
Exit	Used for terminating and saving.

### 16.4.4 Main menu

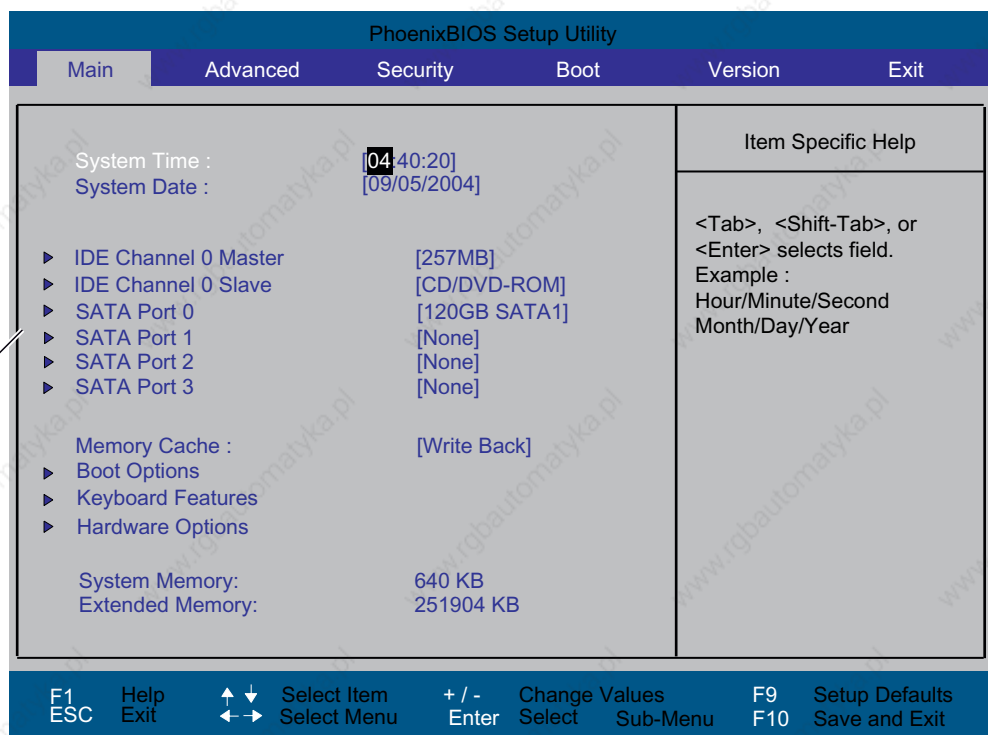

Figure 16-2 SETUP Main menu (example)

(1) Selectable submenu

### Settings in the main menu

In the main menu, you can move up and down to select the following system configuration boxes by means of the [↑] up and [↓] down cursor keys:

Field	Meaning
System Time	For viewing and setting the current time
System Date	For viewing and setting the current date
Memory Cache	Used for setting the cache options
by submenus	
IDE Channel 0 Master	Type of installed disk drives
IDE Channel 0 Slave	Type of installed disk drives
SATA Port 0	Type of installed disk drives
SATA Port 1	Type of installed disk drives
SATA Port 2	Type of installed disk drives
SATA Port 3	Type of installed disk drives
Boot Options	Used for setting the boot options
Keyboard Features	Used for setting of keyboard interface (for instance, NUM-LOCK, typematic rate)
Hardware Options	Used for setting the hardware options

### System time and date

System Time and System Date indicate the current values. Once you have selected the appropriate option, you can use the [+] and [-] keys to modify the time setting

Hour: Minute: Second
----------------------

and for the date

Month/Day/Year
----------------

You can move between the entries in the date and time fields (for example, from hour to minute) using the tab key.

## IDE Channel 0 Master, IDE Channel 0 Slave

The system jumps to the following submenu when you select this type of menu field:

PhoenixBIOS Setup Utility	
Main	
IDE Channel 0 Master [257MB]	Item Specific Help
Type: [User]	User = you enter parameters of hard-disk drive installed at this connection. Auto = autotypes hard-disk drive installed here. CD/DVD-ROM = CD/DVD-ROM drive is installed here. ATAPI Removable = removable disk drive is installed here.
CHS Format	
Cylinders: [ 980]	
Heads: [ 16]	
Sectors: [32]	
Maximum Capacity: 257MB	
LBA Format	
Total Sectors: 501760	
Maximum Capacity: 257MB	
Multi-Sector-Transfers: [Disabled]	
LBA Mode Control: [Enabled]	
Transfer Mode: [FPIO 4 / DMA 2]	
Ultra DMA Mode: [Disabled]	
F1 Help    ↑ ↓ Select Item    + / - Change Values    F9 Setup Defaults ESC Exit    ← → Select Menu    Enter Select ► Sub-Menu    F10 Save and Exit	

Figure 16-3 IDE Channel 0 Master (example)

Type	[User]	Select "User" if you want to define the hard disk drive. You also need to configure the other options, for example, Cylinder, Heads, Sectors/Track, or other properties of the hard disk drive.
	[Auto]	The parameters that you can select here are usually stored on the respective IDE drive. The 'Auto' setting in the 'Type' field means that these values are automatically read from the drive and written to memory.  If Type is selected for a drive that cannot be detected, a time-out is triggered within approximately 1 minute and the entries remain unchanged. You should always check that the interfaces for which you select 'Auto' are in fact connected to drives.
	[CD/DVD-ROM]	CD/DVD-ROM is connected
	ATAPI Removable	This is where removable data media is connected
	None	Select "None" if you have not connected a disk drive. This setting reduces the system waiting time.
Multi Sector-Transfer		The number of sectors transmitted per interrupt are transferred in the option "Multi-Sector Transfers." The value depends on the drive and should be set only to "Auto" in the "Type" field.
	Disabled	2,4,8,16 sectors

16.4 BIOS Setup

LBA Mode Control	“Enabled” in the option “LBA Mode Control” (enabled, disabled) means that hard disk capacities greater than 528 MB are supported. The value depends on the drive and should be set only to "Auto" in the "Type" field.
Transfer Mode or Ultra DMA Mode	The settings in these fields define the interface data transfer rate. The value depends on the drive and should be set only to "Auto" in the "Type" field. You exit the submenu using the ESC key.

SATA Port 0, SATA Port 1, SATA Port 2, SATA Port 3

The system jumps to the following submenu when you select this type of menu field:

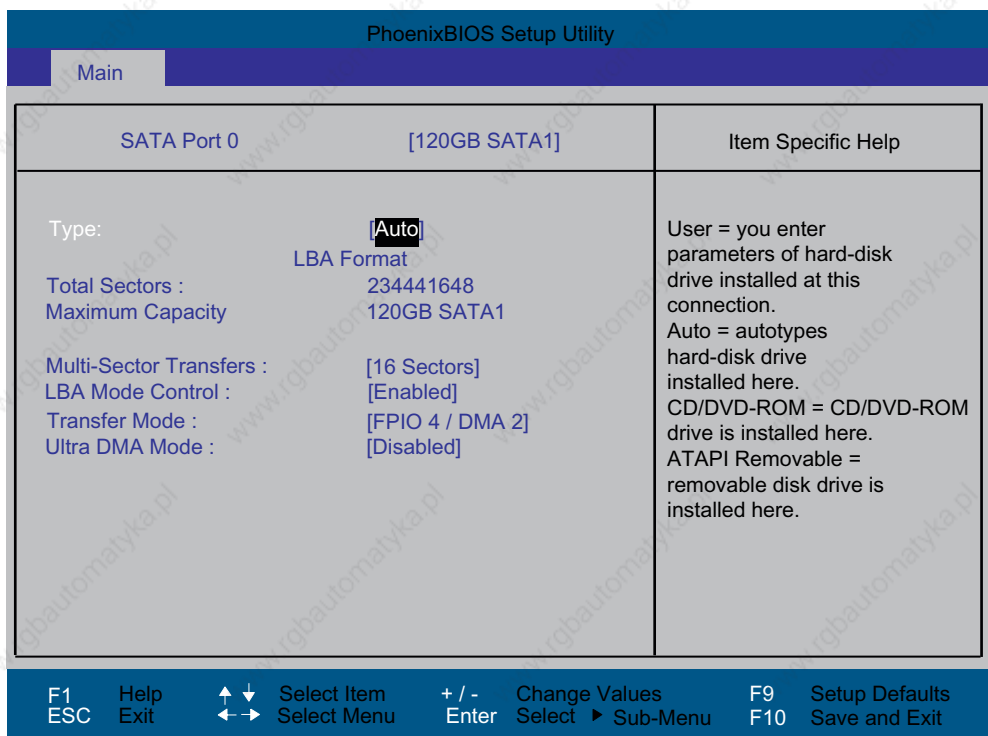

Figure 16-4 SATA Port 0 (example)

Type	[User]	Select "User" if you want to define the hard disk drive. You also need to configure the other options, for example, Cylinder, Heads, Sectors/Track, or other properties of the hard disk drive.
	[Auto]	The parameters that you can select here are usually stored on the respective IDE drive. The 'Auto' setting in the 'Type' field means that these values are automatically read from the drive and written to memory.  If Type is selected for a drive that cannot be detected, a time-out is triggered within approximately 1 minute and the entries remain unchanged. You should always check that the interfaces for which you select 'Auto' are in fact connected to drives.
	[CD/DVD-ROM]	CD/DVD-ROM is connected
	[ATAPI Removable]	This is where removable data media is connected
	[None]	Select "None" if you have not connected a disk drive. This setting reduces the system waiting time.
Multi Sector-Transfer	The number of sectors transmitted per interrupt are transferred in the option "Multi-Sector Transfers." The value depends on the drive and should be set only to "Auto" in the "Type" field.	
	Disabled	2,4,8,16 sectors
LBA Mode Control	"Enabled" in the option "LBA Mode Control" (enabled, disabled) means that hard disk capacities greater than 528 MB are supported. The value depends on the drive and should be set only to "Auto" in the "Type" field.	
Transfer Mode or Ultra DMA Mode	The settings in these fields define the interface data transfer rate. The value depends on the drive and should be set only to "Auto" in the "Type" field. You exit the submenu using the ESC key.	

**The "Memory Cache" field**

The following context menu appears when you select the option "Memory cache" in the main menu:

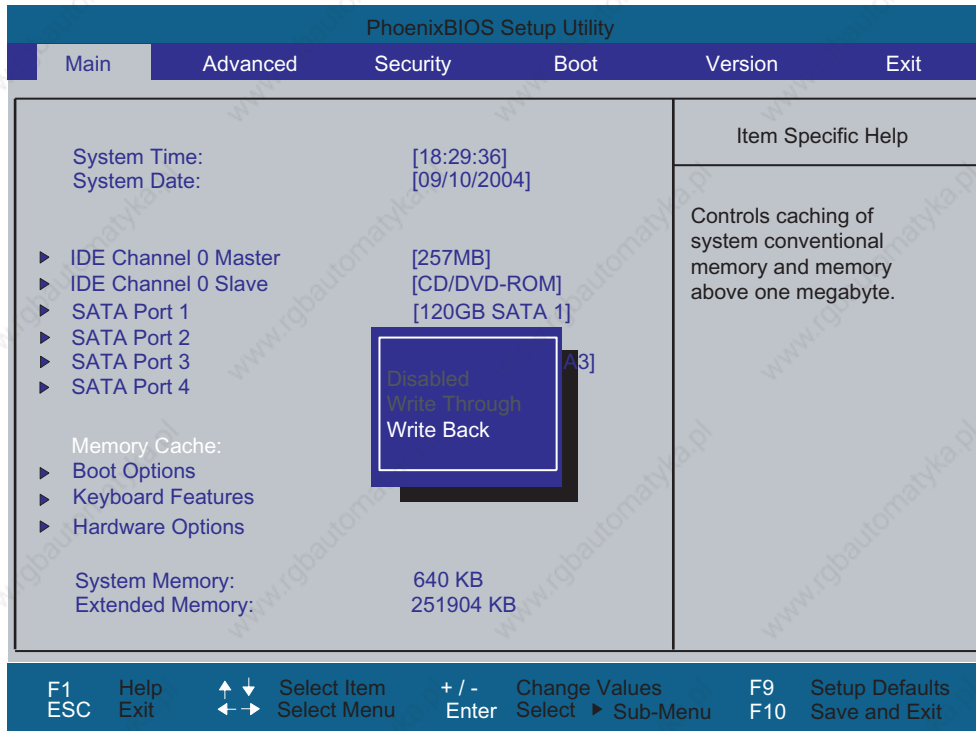

Figure 16-5 "Memory Cache" field

The cache is a high-speed memory buffer between the CPU and memory (DRAM). Repeated memory access operations are executed in the faster cache, and not in the main memory, provided the feature is enabled. In some cases it may be necessary to disable the cache for certain types of hardware and software because intentional program runtimes or delay times may be prevented by the fast cache.

[Disabled]	Cache is disabled
[Write Through]	Write access is not concluded until the entry has been made in main memory
[Write Back]	Write access is concluded immediately, the entry in main memory takes place in the background (default)

**"Boot Options" field**

The following context menu appears when you select "Boot Options" in the main menu:

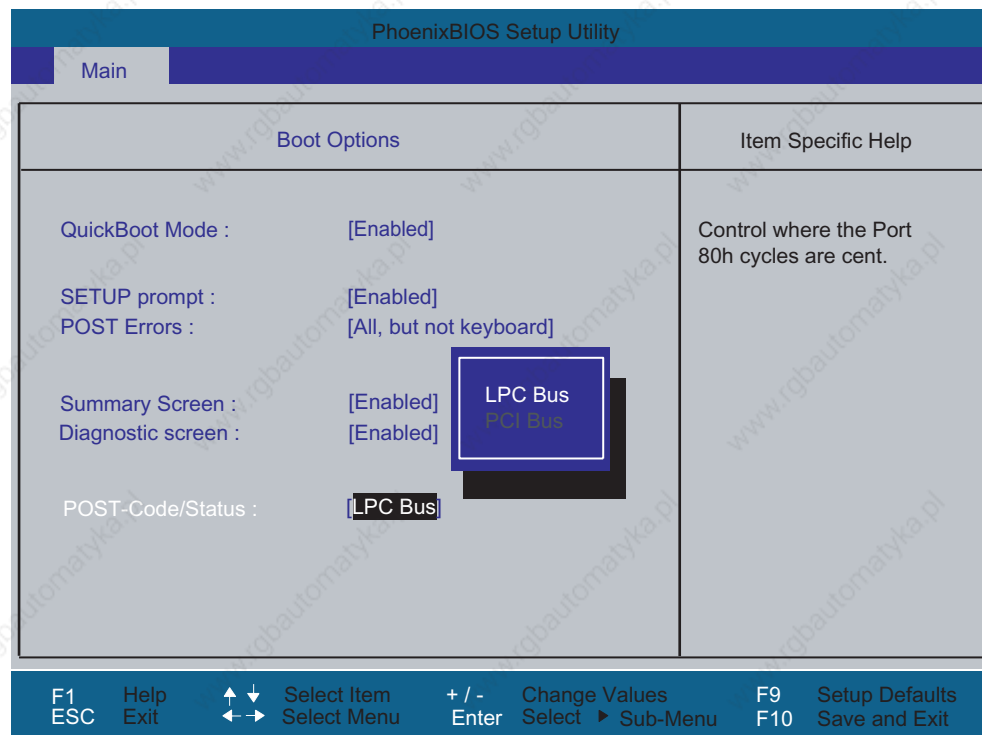

Figure 16-6 "Boot Options" field

Quick Boot Mode	Some hardware tests are skipped to speed up the boot sequence.	
SETUP prompt	During the system load phase, the message "Press <F2> to enter Setup or <Esc> to show boot menu" is output on the bottom of the screen.	
POST Errors	The boot sequence is stopped if an error is detected; you must press F1 to acknowledge.	
	[Disabled]	No error confirmation is required, for example, when no keyboard is connected.
	[All, but not keyboard]	Show all errors except for keyboard errors.
Summary screen	The most important system parameters are displayed when the system run-up phase completes.	
Diagnostic screen	Shows the diagnostics messages on the monitor during booting.	
Post Code/Status	Specifies where the POST codes are saved.	

'Enabled' means that the feature is active. 'Disabled' means that the feature is inactive.



Example of a summary screen:

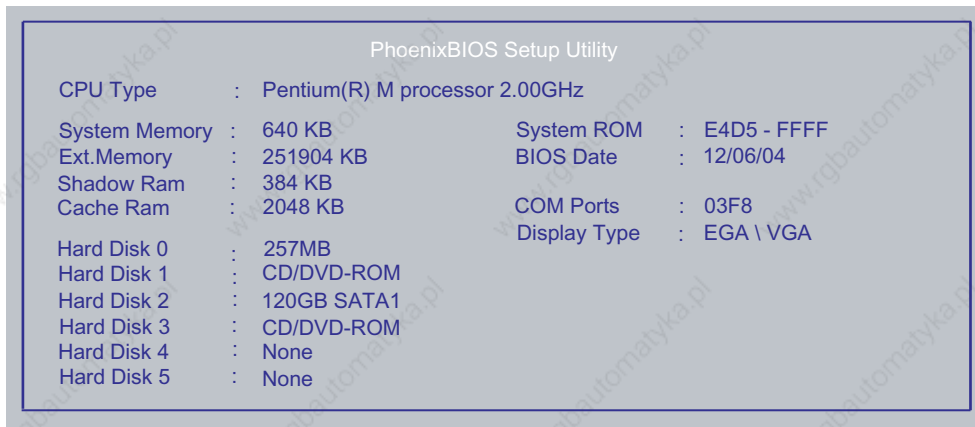

Figure 16-7 Summary screen (example)

The Summary screen appears when the system run-up phase completes.

**"Keyboard Features" field**

The following submenu appears when you select the option "Keyboard Features" in the main menu:

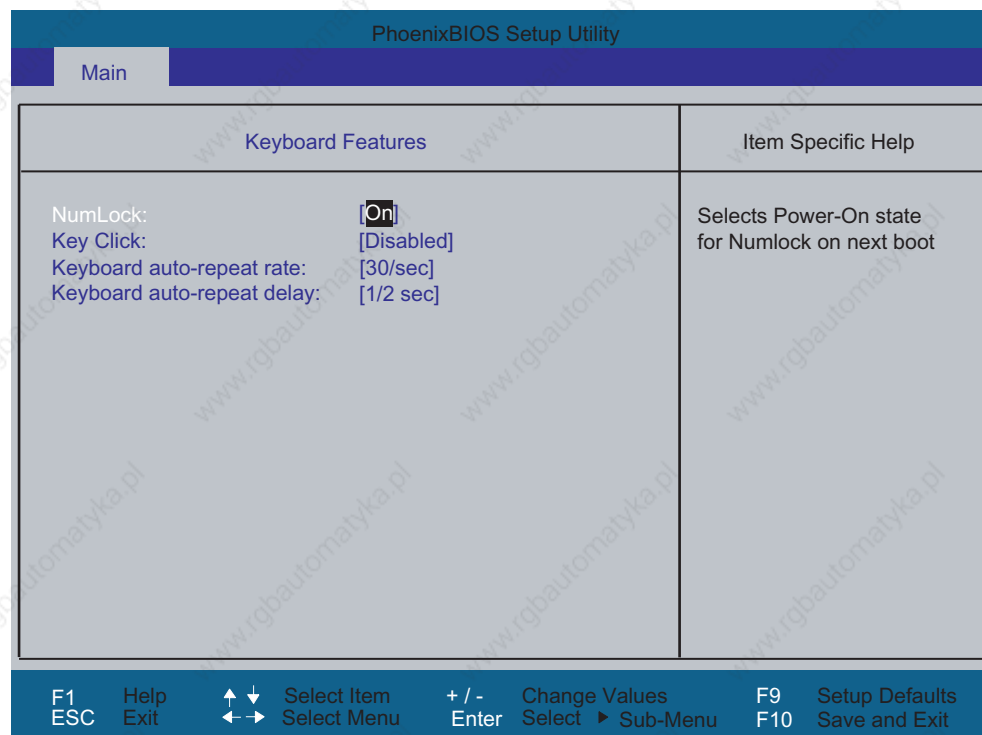

Figure 16-8 "Keyboard Features" submenu (example)

Numlock	Switches Numlock on or off following power on. If "Auto" is set, this will be remembered the next time the device is switched on.
Key Click	A keystroke can be heard
Keyboard auto-repeat rate	Increase in automatic key repeat rate
Keyboard auto-repeat delay	On-delay of automatic keyboard repeat

**"Hardware Options" field**

The following submenu, for example, appears when you select "Hardware Options" in the main menu:

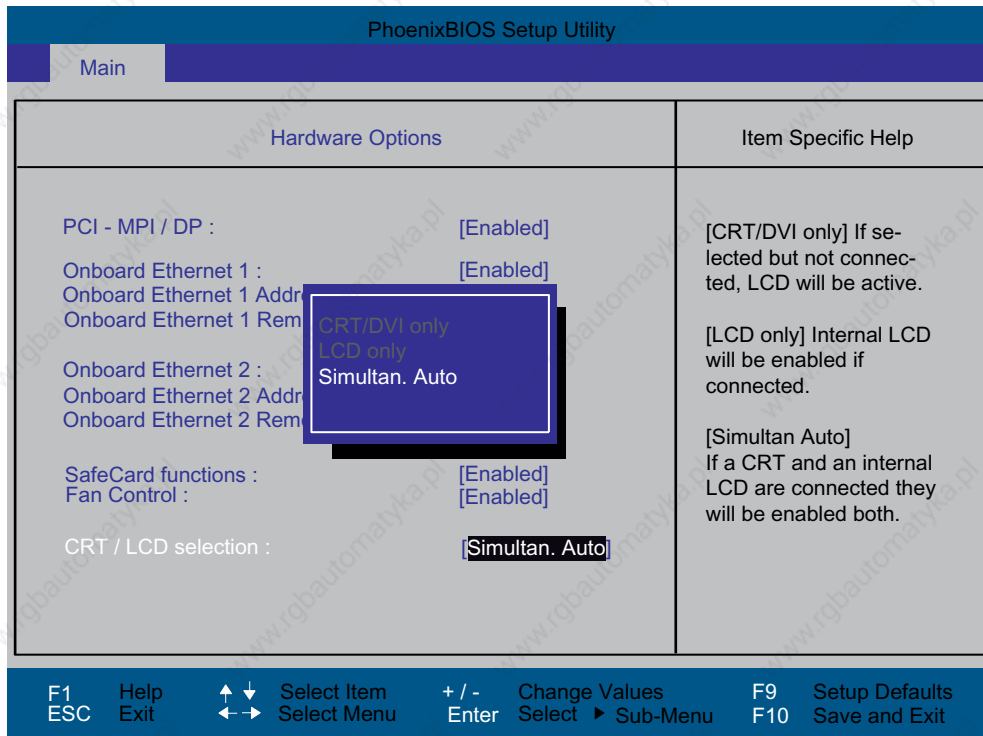

Figure 16-9 "Hardware Options" submenu (example)

The parameters of the interfaces present on the motherboard are set here.

Entry	Meaning	
PCI-MPI/DP <sup>1)</sup>	[Enabled]	Enables the CP5611-compatible MPI/DP interface. The resources are managed by the BIOS PCI Plug and Play mechanism.
	[Disabled]	The CP5611 compatible MPI/DP interface is disabled.
On-board Ethernet	[Enabled]	The Ethernet port on the motherboard is enabled.
	[Disabled]	The Ethernet port on the motherboard is disabled.
On-board Ethernet Address	Shows the individual Ethernet address.	
On-board Ethernet Remote Boot <sup>1)</sup>	[Enabled]	Booting via a connected LAN is possible. The respective boot source is displayed as Intel® Boot-Agent in the boot sequence menu.
	[Disabled]	Booting via LAN is not possible.
SafeCard functions	[Enabled]	On-board monitoring functions are enabled.
	[Disabled]	No monitoring functions.
	The relevant driver and the application must be started for operation of the monitoring functions.	

Entry	Meaning	
Fan Control	[Enabled]	The fan speed is controlled based on the temperature.
	[Disabled]	The fan always runs at full speed.
CRT / LCD selection	[CRT only]	A CRT monitor is addressed, or a DVI LCD monitor, if it is connected to the DVI ports when the system boots up.
	[LCD only]	The internal LVDS interface or the digital DVI interface is enabled, if a valid display ID was read during the boot sequence; if not, the procedure as for 'CRT only' applies.
	[Simultan. Auto]	The two interfaces, CRT and LVDS, are activated when a CRT monitor is connected with valid display detection. The external monitor is only enabled for operation if it is connected and detected at the start of the boot sequence. Data are not output to an external monitor which is not connected until after the boot sequence.
	DVI LCD and LVDS displays cannot be operated in parallel; LVDS takes priority over DVI!	

<sup>1)</sup> Optional product feature

---

#### Note

The second Ethernet interface support is OS dependent. For DOS based applications (e.g. Image Creator) please use the first Ethernet interface.

---

### 16.4.5 Advanced Menu

#### Menu layout

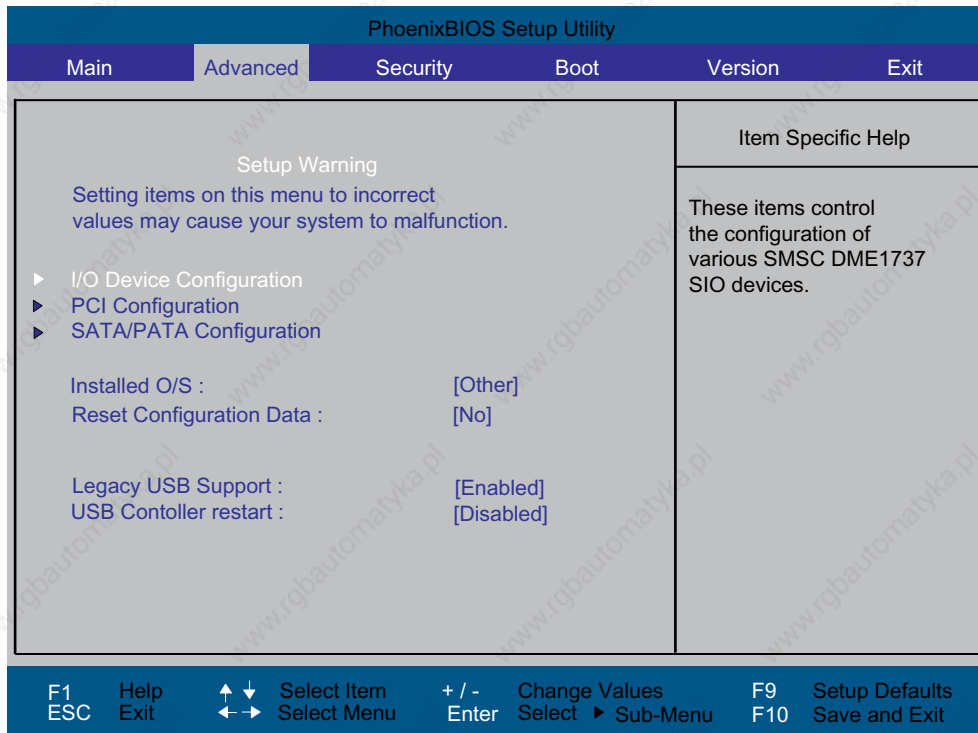

Figure 16-10 Advanced menu

#### Settings in the Advanced Menu

Installed O/S	Plug&Play means that all modules are automatically detected and installed, providing they support the Plug&Play functionality.	
	[Other]	BIOS handles the entire Plug&Play capability, default setting.
	[WinXP/2000]	The operating system handles the Plug&Play functions.
Reset Configuration Data	[Yes]	All installations under Plug&Play are deleted and the configuration is retriggered the next time the system boots. The entry is then reset to [No]. System components that do not support Plug&Play have to be entered manually.
	[No]	The Plug&Play system components are initialized after the next system start.
Legacy USB support	[Disabled]	Disables Legacy Universal Serial Bus support
	[Enabled]	Enables Legacy Universal Serial Bus support The USB Boot function must be enabled to allow booting from a USB device, or if the system is to be operated without USB support with a USB keyboard or mouse.
USB controller restart	[Enabled]	The USB controller restart function has to be activated before you can install an operating system or if you experience problems with a user interface (Human Interface Device).

**“I/O Device Configuration” submenu**

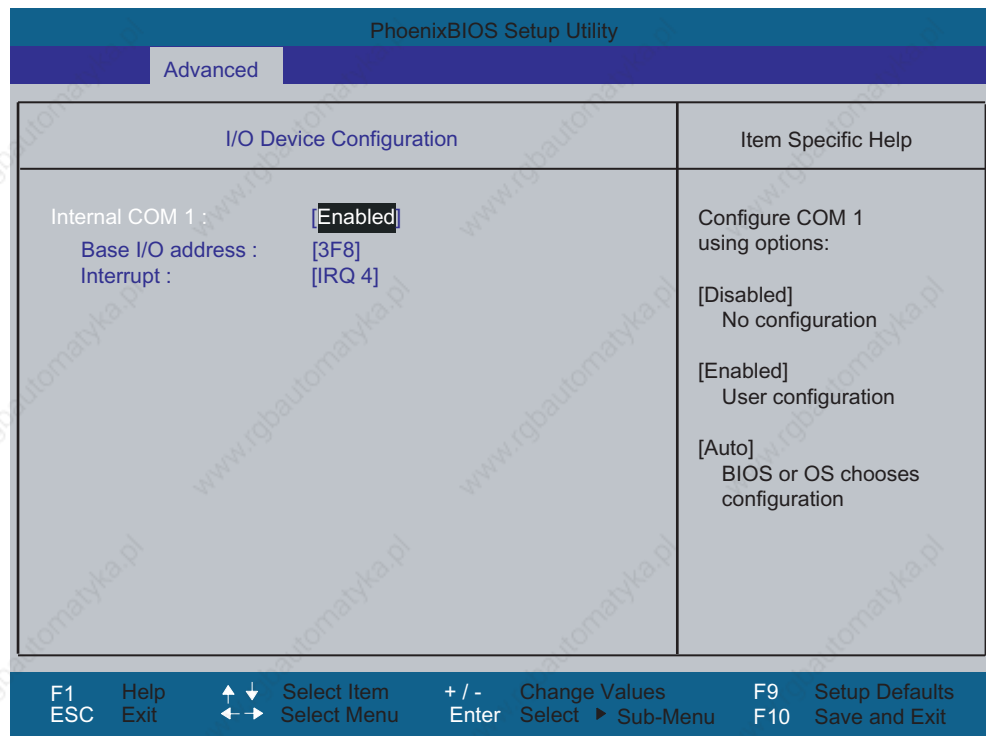

Figure 16-11 COM/LPT configuration submenu

The resources used by an interface are released when you disable the interface in question.

The I/O addresses and interrupts are pre-assigned; it is advisable not to change these default assignments.

"PCI Configuration" submenu

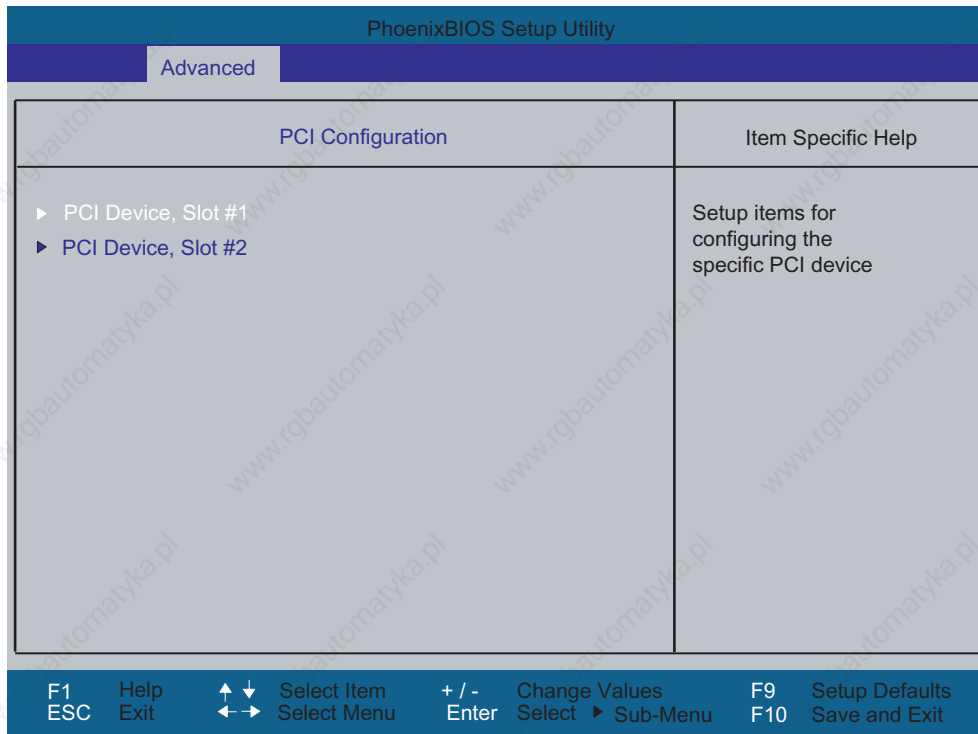

Figure 16-12 PCI Configuration submenu (example)



**"PCI Devices" field**

If the PCI devices field is selected, the following submenu appears:

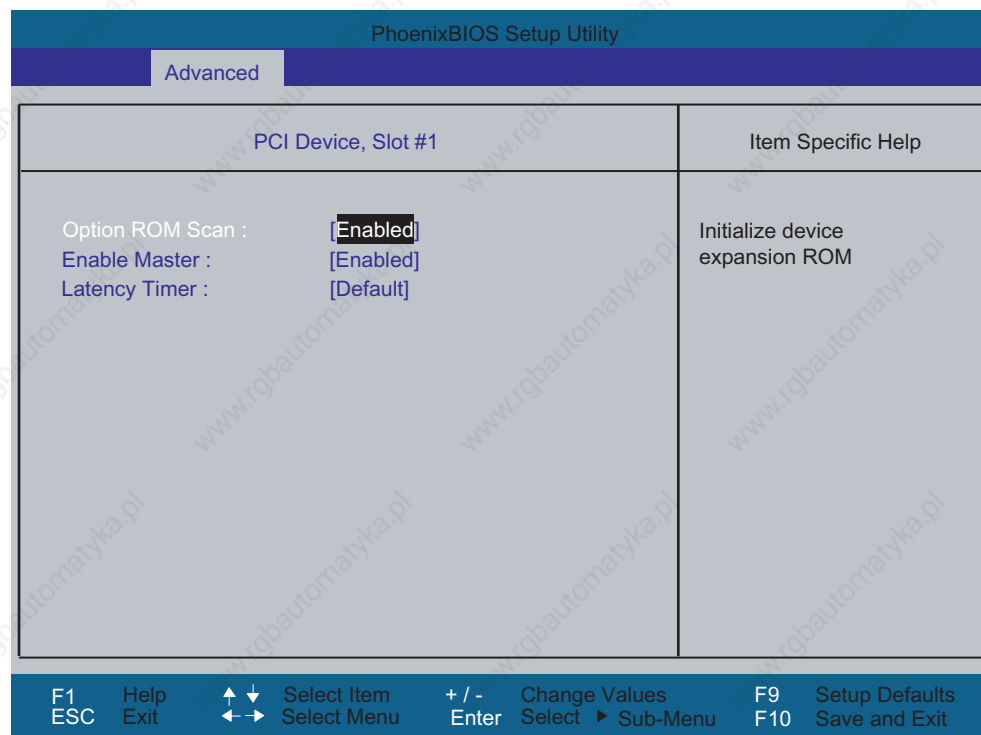
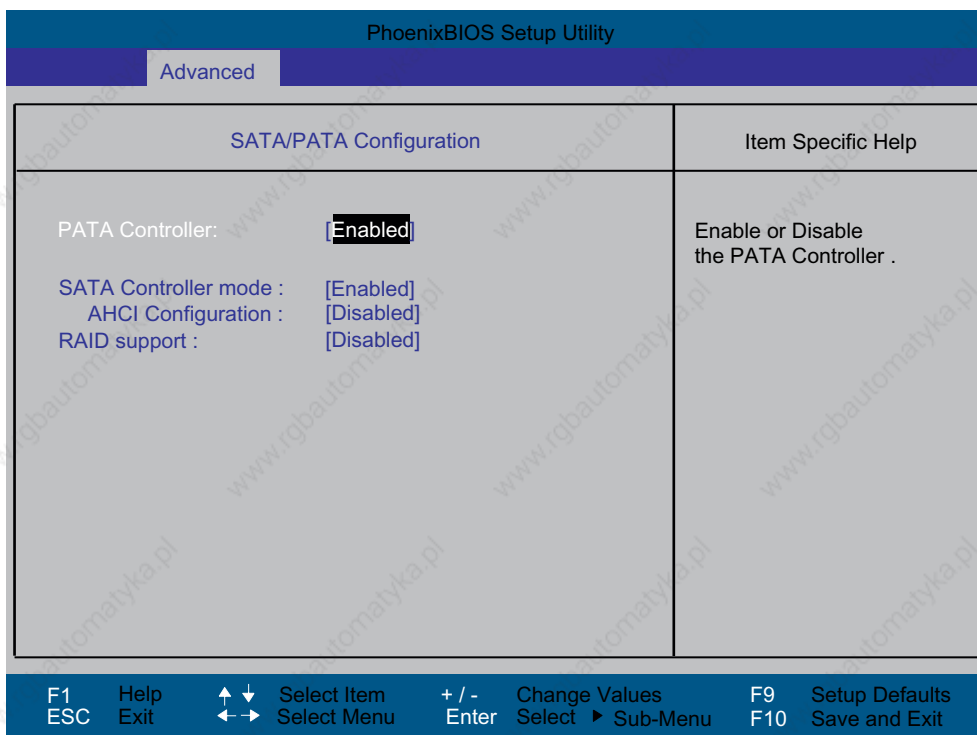

Figure 16-13 PCI Devices submenu, slot #1

ROM scan option:	[Enabled]	The ROM option of the PCI module (if present) is enabled
	[Disabled]	The ROM option of a PCI module is disabled.
Enable Master	[Enabled]	This slot can be assigned master functions
	[Disabled]	This slot can only operate as PCI slave.
Latency Timer	[Default]	The number of active PCI clock cycles of the master modules is determined by this module
	[0020H to 00E0H]	These settings are used to set the maximum number of active PCI clock cycles to the selected value.
	<b>You should only use a value different from the default if the module or its application requires it.</b>	

"SATA/PATA Configuration" submenu



PATA Controller:	[Enabled] [Disabled]	Disables or enables the PATA controller
SATA Controller mode	[Enhanced]	SATA drive = Primary on the SATA controller in native mode. PATA drive = Primary on the PATA controller in legacy mode.
	[Compatible]	SATA drive = Primary on the SATA controller, in legacy mode PATA drive = drive on the SATA controller in legacy mode
AHCI Configuration	[Disabled] [Enabled]	Enhanced AHCI: WinXP-SP1 + IAA driver supports AHCI mode
RAID support	[Disabled] [Enabled]	Disables or enables RAID support

16.4.6 Security menu

You can only edit the fields enclosed in square brackets. Two passwords can be assigned to protect your PC from unauthorized use. The Supervisor password can be used to restrict usage of the hard disk.

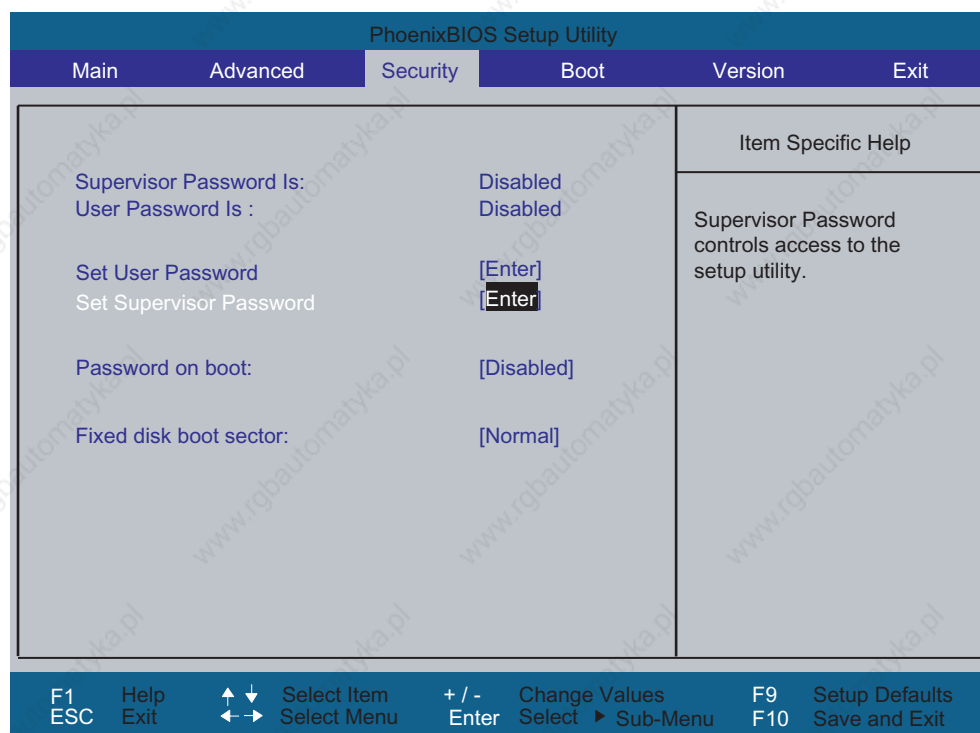

Figure 16-14 Security menu

User Password is	Disabled	The password is disabled.
	Enabled	Certain Setup fields are thus configurable by the user, including the user password.
	The field resets automatically from [Disabled] to [Enabled] when the password is entered.	
Set Supervisor Password	This field opens the dialog box for entering a password. Once it has been entered, the supervisor password can be changed or deleted by pressing "Return" and thus deactivated.	
Set User Password	This field opens the dialog box for entering a password. Once it has been entered correctly, the user password can be changed or deleted by pressing "Return" and thus deactivated.	
Password on boot	[Disabled]	No password required for system boot.
	[Enabled]	Supervisor or user password must be entered for system boot.
Fixed disk boot sector	[Normal]	All types of hard disk access are permitted.
	[Write protect]	The user cannot install an operating system. This is a way of protecting against boot viruses.

### 16.4.7 Boot menu

This menu allows you to assign a priority for the boot devices.



Figure 16-15 Boot Menu

This screen shows all possible boot devices. The boot source with the highest boot priority is at the top. To change the sequence:

Select the boot source with the ↑ ↓ keys, move to the desired position with + or -.

**Note**

During startup the boot drive can be selected using the ESC key.

If a boot device is not available, the next device in the sequence is automatically checked to ascertain whether or not it is bootable.

### 16.4.8 Version menu

This menu contains the information you will have to quote when you send us technical questions about your system.

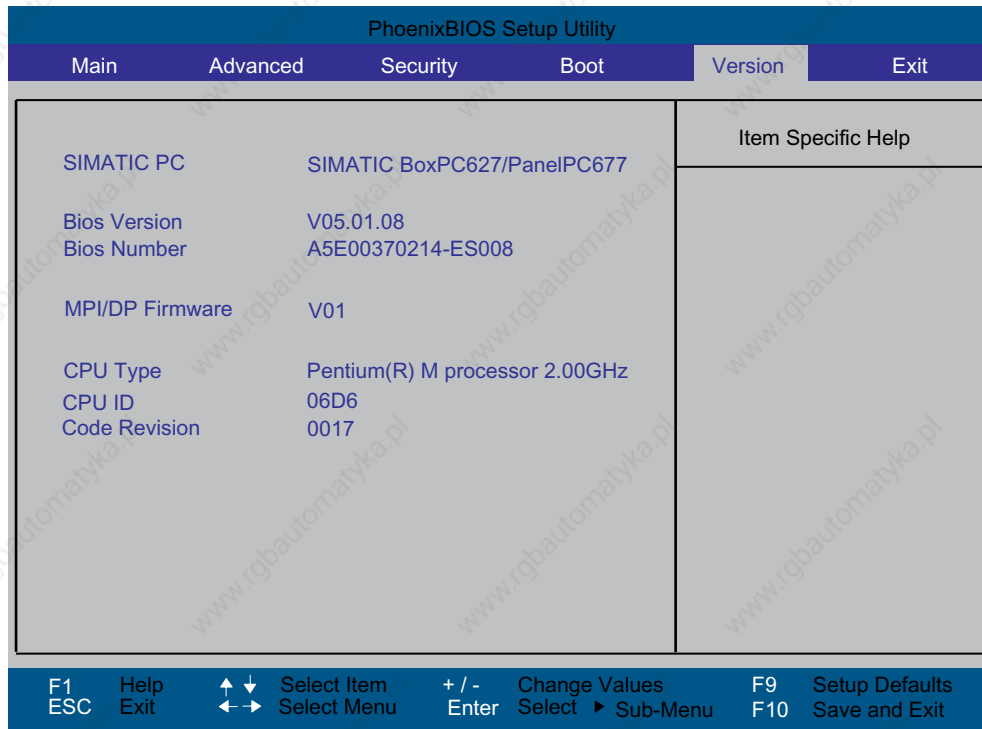

Figure 16-16 "Version" menu (example)

### 16.4.9 Exit Menu

The setup program is always closed from this menu.

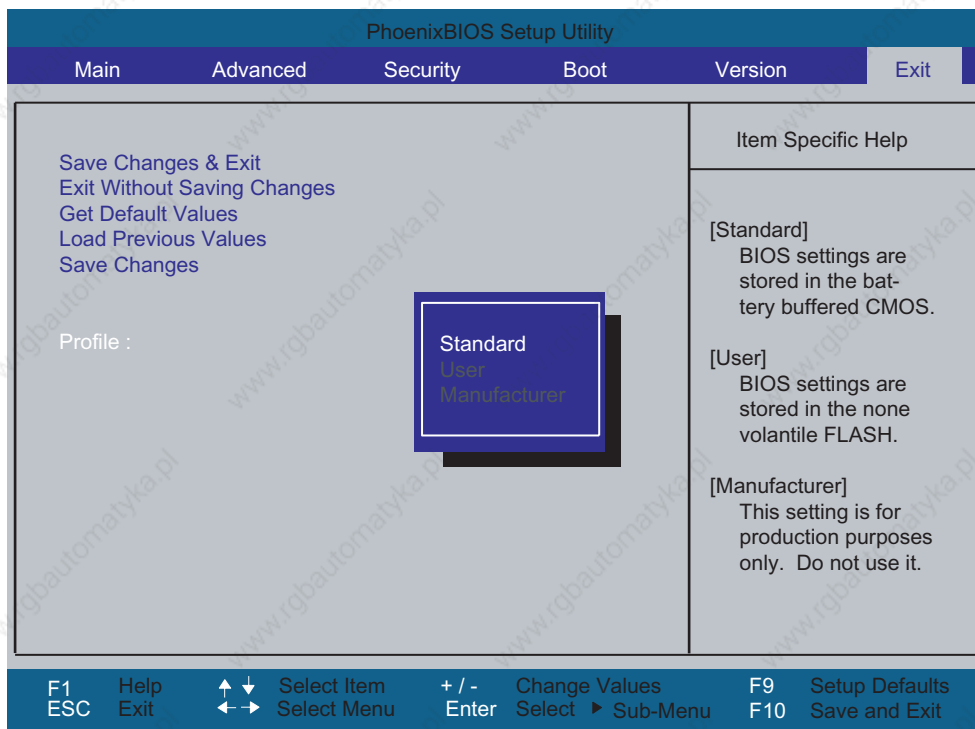

Figure 16-17 Exit menu

Save Changes & Exit	All changes are saved; a system restart is carried out with the new parameters.	
Exit Without Saving Changes	All changes are discarded and the system performs a restart based on the old parameters.	
Get Default Values	All parameters are set to safe values.	
Load Previous Values	The last saved values are reloaded.	
Save Changes	Save all Setup settings.	
Profile	Default	The BIOS settings are saved in the battery-backed CMOS
	User	The BIOS settings are saved
	Manufacturer	This setting is only used for production purposes. Do not use.

## 16.4.10 Default BIOS Setup entries

### Documenting your device configuration

If you have changed any default settings in Setup, you can enter them in the following table. You can then refer to these entries for any future hardware modifications.

---

#### Note

Print out the table below and keep the pages in a safe place once you made your entries.

---

### BIOS Setup default settings

System parameters	Defaults	Custom entries
-------------------	----------	----------------

Main		
System Time	hh:mm:ss	
System Date	MM/DD/YYYY	
IDE Channel 0 Master	257MB	
IDE Channel 0 Slave	None	
SATA Port 0	120GB SATA1	
SATA Port 1	None	
SATA Port 2	None	
SATA Port 3	None	
Memory Cache	Write Back	

Boot Options		
Quick Boot Mode	Enabled	
SETUP prompt	Enabled	
POST Errors	All, but not keyboard	
Summary screen	Enabled	
Diagnostic screen	Enabled	
Post Code/Status	LPC Bus	

Keyboard Features		
Numlock	On	
Key Click	Disabled	
Keyboard auto-repeat rate	30/sec	
Keyboard auto-repeat delay	½ sec	



Hardware Options		
PCI-MPI/DP	Enabled	
On-board Ethernet 1	Enabled	
On-board Ethernet 1 Address	08000624xxxx	
On-board Ethernet 1 Remote Boot	Disabled	
On-board Ethernet 2	Enabled	
On-board Ethernet 2 Address	08000624xxxx	
On-board Ethernet 2 Remote Boot	Disabled	
SafeCard functions	Enabled	
Fan Control	Enabled	
CRT / LCD selection	Simultan. Auto	

Advanced		
Installed O/S	Other	
Reset Configuration Data	No	
Legacy USB support	Enabled	
USB controller restart	Disabled	

I/O Device Configuration		
Internal COM 1	Enabled	
Base I/O address	3F8	
Interrupt	IRQ 4	

PCI Configuration		
<b>PCI Device Slot 1</b>		
ROM scan option:	Enabled	
Enable Master	Enabled	
Latency timer	Default	
<b>PCI Device Slot 2</b>		
ROM scan option:	Enabled	
Enable Master	Enabled	
Latency timer	Default	

SATA/PATA Configuration		
PATA Controller:	Enabled	
SATA Controller mode	Enhanced	
AHCI Configuration	Disabled	
RAID support	Disabled	

<b>Security</b>		
Supervisor Password Is	Disabled	
User Password is	Disabled	
Set User Password	Enter	
Set Supervisor Password	Enter	
Password on boot	Disabled	
Fixed disk boot sector	Standard	

<b>Boot</b>		
Boot priority order:		
Excluded from boot order:		

<b>Version</b>		
SIMATIC PC	SIMATIC BoxPC627/ PanelPC677	
BIOS Version	V05.01.08	
BIOS Number	A5E00378214-ES008	
MPI/DP Firmware	V01	
CPU Type	Pentium® M processor 2.00 GHz	
CPU ID	06D6	
Code Revision	0017	



# Appendix

# A

## A.1 Guidelines and declarations

### Notes on the CE Label



The following applies to the SIMATIC product described in this documentation:

### EMC Directive

The devices fulfill the requirements for the EC directive "89/336/EEC Electromagnetic Compatibility", and the following fields of application applies according to this CE label:

Area of Application	Requirement for	
	Emitted interference	Immunity to interferences
Domestic housing area, business and trade areas and small businesses.	EN 61000-6-3: 2001	EN 61000-6-1: 2001
Industry	EN 61000-6-4: 2001	EN 61000-6-2: 2001

The device is also compliant with the EN 61000-3-2:2000 (harmonic currents) and EN 61000-3-3:1995 (voltage fluctuation and flicker) standards.

### Low-voltage directive

The devices with AC and DC power supply are compliant with the requirements of the EC Directive 73/23/EEC "Low-Voltage Directive." Conformance with this directive has been verified according to EN 60950-1.

### Declaration of conformity

The EC declaration of conformity and the corresponding documentation are made available to authorities in accordance with the EC directives stated above. Your sales representative can provide these on request.

### Note the installation guidelines

The installation guidelines and safety instructions given in this documentation have to be noted during commissioning and operation.

**Connecting peripherals**

The requirements relating to noise immunity according to EN 61000-6-2:2001 are met when you connect a peripheral suitable for an industrial environment. Peripheral devices are only be connected via shielded cables.

**A.2 Certificates and approvals**

**DIN ISO 9001 certificate**

The quality assurance system for the entire product process (development, production, and marketing) at Siemens fulfills the requirements of ISO 9001 (corresponds to EN29001: 1987).

This has been certified by DQS (the German society for the certification of quality management systems).







EQ-Net certificate no.: 1323-01

**Software License Agreement**

The device is shipped with preinstalled software. Please observe the respective license agreements.

**Approvals for the USA, Canada and Australia**

**Product safety**

One of the following markings on a device is indicative of the corresponding approval:	
	Underwriters Laboratories (UL) per UL 60950-1 (I.T.E) or per UL 508 (IND.CONT.EQ)
	Underwriters Laboratories (UL) according to Canadian standard C22.2 No. 60950-1 (I.T.E) or C22.2 No. 142 (IND.CONT.EQ)
	Underwriters Laboratories (UL) to Standard UL 60950-1, Report E11 5352 and Canadian Standard C22.2 no. 60950-1 (I.T.E), or to UL508 and C22.2 no. 142 (IND.CONT.EQ)
	UL recognition mark
	Canadian Standard Association (CSA) per Standard C22.2. No. 60950-1 (LR 81690) or per C22.2 No. 142 (LR 63533)
	Canadian Standard Association (CSA) to the American Standard UL 60950-1 (LR 81690), or to the UL 508 (LR 63533)

## EMC

<b>USA</b>	
Federal Communications Commission Radio Frequency Interference Statement	This equipment has been tested and found to comply with the limits for a Class A digital device, pursuant to Part 15 of the FCC Rules. These limits are designed to provide reasonable protection against harmful interference when the equipment is operated in a commercial environment. This equipment generates, uses, and can radiate radio frequency energy and, if not installed and used in accordance with the instruction manual, may cause harmful interference to radio communications. Operation of this equipment in a residential area is likely to cause harmful interference in which case the user will be required to correct the interference at his own expense.
Shielded Cables	Shielded cables must be used with this equipment to maintain compliance with FCC regulations.
Modifications	Changes or modifications not expressly approved by the manufacturer could void the user's authority to operate the equipment.
Conditions of Operations	This device complies with Part 15 of the FCC Rules. Operation is subject to the following two conditions: (1) this device may not cause harmful interference, and (2) this device must accept any interference received, including interference that may cause undesired operation.

<b>CANADA</b>	
Canadian Notice	This Class A digital apparatus complies with Canadian ICES-003.
Avis Canadien	Cet appareil numérique de la classe A est conforme à la norme NMB-003 du Canada.

<b>AUSTRALIA</b>	
	This product meets the requirements of the AS/NZS 3548 Norm.

## A.3 Service and support

### Additional support

If you have any further questions relating to the products described in this documentation, contact your local representative at the SIEMENS office nearest you.

Find your contact partner at:

<http://www.siemens.com/automation/partner>

A guide to the technical documentation for the various SIMATIC products and systems is available at:

<http://www.siemens.de/simatic-tech-doku-portal>

The online catalog and the online ordering system is available at:

<http://mall.automation.siemens.com/>

### Training center

Siemens offers a number of training courses to familiarize you with the SIMATIC automation system. Please contact your regional Training Center, or the central Training Center in D90327 Nuremberg.

Phone: +49 (911) 895-3200.

Internet: <http://www.sitrain.com>

### Technical support

You can reach technical support for all A&D products at:

- Support request form on the web:  
<http://www.siemens.de/automation/support-request>
- Phone: +49 180 5050 222
- Fax: +49 180 5050 223

Further information about our technical support is available in the Internet at [www.siemens.com/automation/service](http://www.siemens.com/automation/service)

When you contact the customer support, please have the following information for the technician on hand:

- BIOS version
- Order No. (MLFB) of the device
- Installed additional software
- Installed additional hardware



## Service & support on the Internet

In addition to our documentation, we offer our complete knowledge base on the Internet at.

<http://www.siemens.com/asis>

There you will find:

- The newsletter which provides the latest information on your products
- Relevant documentation for your application which you can access via the search function in our service & support database.
- The current BIOS version
- A forum is available for users and specialists from all over the world to exchange experiences
- Your local Siemens partner for Automation & Drives in our partner database
- Information about on-site service, repairs, spare parts. Lots more is available under "Services"

**You can find the latest information about your device at the following address:**

<http://support.automation.siemens.com>



## ESD Guidelines

### B.1 ESD Guidelines

#### What does ESD mean?

All electronic modules are equipped with highly integrated modules or components. Based on their design, these electronic components are highly sensitive to overvoltage and thus to discharge of static electricity.

The electrostatic sensitive components/modules are commonly referred to as ESD devices. You can also find the commonly used international designation ESD for electrostatic sensitive device.

Electrostatic sensitive modules are identified by the following symbol:



---

#### Caution

Electrostatic sensitive devices may be destroyed by voltages and energies that are undetectable to a human. Voltages of this kind occur as soon as a component or an assembly is touched by a person who is not grounded against static electricity. The damage to a module as a result of overvoltage cannot usually be detected immediately. It may only become apparent after a long period of operation.

---

**Electrical charge**

Anyone who is not connected to the electrical potential of their surroundings can be electrostatically charged.

The figure below shows the maximum electrostatic voltages that can accumulate in a person who is operating equipment when he/she comes into contact with the materials indicated. These values correspond with specifications to IEC 801-2.

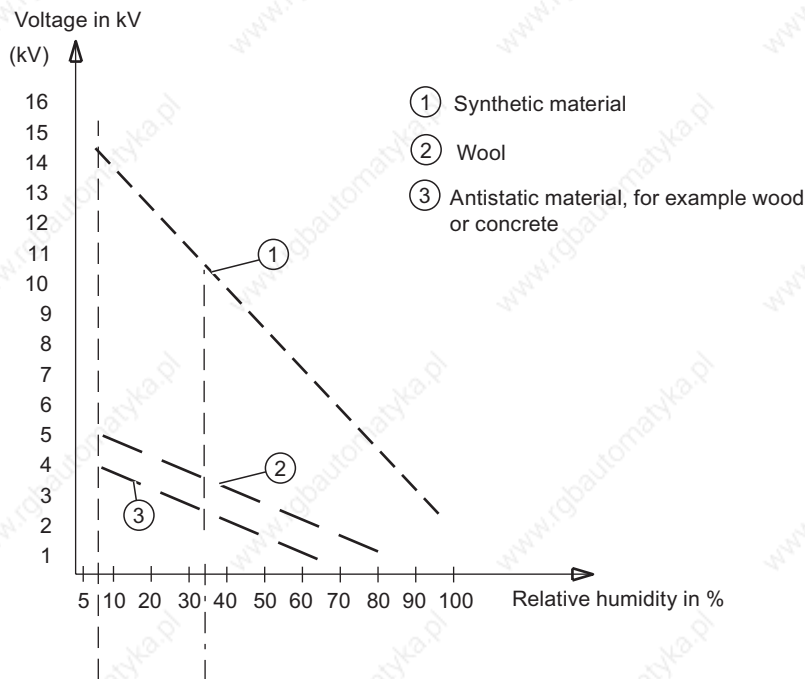

Figure B-1 Electrostatic voltages on an operator

**Basic protective measures against discharge of static electricity**

- Ensure good equipotential bonding:  
When handling electrostatic sensitive devices, ensure that your body, the workplace and packaging are grounded. This helps you avoid static charge.
- As a general rule, only touch electrostatic sensitive devices when this is unavoidable (e.g. during maintenance work). When you touch modules, make sure that you do not touch either the pins on the modules or the printed conductors. This prevents any discharge of static electricity to sensitive component and thus avoids damage.

Discharge electrostatic energy from your body before you perform measurements on a module. To do so, touch a grounded metallic object. Always use grounded measuring instruments.

## Abbreviations

### C.1 Abbreviations

Abbreviation	Term	Meaning
AC	Alternating current	Alternating current
ACPI	Advanced Configuration and Power Interface	
PLC	Automation device	
AGP	Accelerated Graphics Port	High speed bus system
APIC	Advanced Programmable Interrupt Controller	Extended programmable interrupt controller
APM	Advanced Power Management	Tool for monitoring and reducing power consumption of the PC
PLC	Automation system	
AT	Advanced Technology	
ATA	Advanced Technology Attachment	
ATX	AT-Bus-Extended	
AWG	American Wire Gauge	US standard for the cable diameter
BIOS	Basic Input Output System	Basic Input Output System
CAN	Controller Area Network	
CD-ROM	Compact Disc – Read Only Memory	Removable storage medium for large data volumes
CD-RW	Compact Disc – Rewritable	Rewritable CD
CE	Communauté Européenne (CE symbol)	The product is in conformance with all applicable EC directives
CF	Compact Flash	
CGA	Color Graphics Adapter	Standard monitor interface
CLK	Clock pulse	Clock signal for controllers
CMOS	Complementary Metal Oxide Semiconductors	Complementary metal oxide semiconductors
COA	Certificate of authentication	Microsoft Windows Product Key
CoL	Certificate of License	License authorization
COM	Communications Port	Term for the serial interface
CP	Communication Processor	Communication computer
CPU	Central Processing Unit	CPU

## Abbreviations

### C.1 Abbreviations

Abbreviation	Term	Meaning
CSA	Canadian Standards Association	Canadian organisation for tests and certifications according to own or binational standards (with UL / USA) standards
CTS	Clear To Send	Clear to send
DRAM	Dynamic Random Access Memory	
DC	Direct Current	DC current
DCD	Data Carrier Detect	Data carrier signal detection
DMA	Direct Memory Access	Direct memory access
DOS	Disc Operating System	Operating system without GUI
DP	Decentralized peripherals	
DQS	Deutsche Gesellschaft zur Zertifizierung von Qualitätsmanagement mBH	
DDRAM	Double Data Random Access Memory	Memory chip with high-speed interface
DSR	Data Set Ready	Ready for operation
DTR	Data Terminal Ready	Data terminal is ready
DVD	Digital Versatile Disc	Digital versatile disk
DVI	Digital Visual Interface	Digital display interface
ECC	Error Correction Code	Error correction code
ECP	Extended capability port	Extended parallel port
EGA	Enhanced Graphics Adapter	PC to monitor interface
ESD	Components sensitive to electrostatic charge	
DM	Electronic Manual	
EIDE	Enhanced Integrated Drive Electronics	An enhancement of the IDE standard
EISA	Extended Industry Standard Architecture	Extended ISA standard
EMM	Expanded Memory Manager	Manages memory expansions
EM64T	Extended Memory 64 technology	
EN	European standard	
EPROM / EEPROM	Erasable Programmable Read-Only Memory / Electrically Erasable Programmable Read-Only Memory	Plug-in submodules with EPROM/EEPROM chips
EPP	Enhanced Parallel Port	Bi-directional Centronics interface
ESC	Escape character	Control character
EWf	Enhanced Write Filter	
FAQ	Frequently Asked Questions	FAQs
FAT 32	File Allocation Table 32-bit	32-bit file allocation table
FD	Floppy disk	Disk drive, 3.5"
FSB	Front Side Bus	
GND	Ground	Chassis ground
HD	Hard disk	Hard disk
HDA	High Definition Audio	
HU	Height unit	
HMI	Human Machine Interface	User interface
HT	Hyper-Threading	

Abbreviation	Term	Meaning
HTML	Hyper Text Markup Language	Script language for creating Internet pages.
HTTP	Hypertext Transfer Protocol	Protocol for data transfer on the Internet
Hardware	Hardware	
I/O	Input/Output	Data input/output on computers
IDE	Integrated Device Electronics	
IEC	International Electrical Commission	
IP	Ingress Protection	Degree of protection
IR	Infrared	Infrared
IRDA	Infrared Data Association	Standard for data transfer via IR module
IRQ	Interrupt Request	Interrupt request
ISA	Industry Standard Architecture	Bus for expansion modules
IT	Information Technology	Information technology
LAN	Local Area Network	Computer network that is limited to a local area.
LCD	Liquid Crystal Display	Liquid crystal display
LEDs	Light Emitting Diode	Light emitting diode
LPT	Line Printer	Printer port
LVDS	Low Voltage Differential Signaling	
LW	Disk drive	
MAC	Media access control	Media access control
MC	Memory Card	Memory card in credit card format
MLFB	Machine-readable product designation	
MMC	Micro Memory Card	Memory card with the format 32 x 24.5 mm
MPI	Multipoint-capable interface for programming devices	
MS-DOS	Microsoft Disc Operating System	
MTBF	Mean Time Between Failures	
MUI	Multilanguage User Interface	Language localization in Windows
NA	Not Applicable	
NAMUR	Normenarbeitsgemeinschaft für Mess- und Regelungstechnik in der chemischen Industrie (standardization body for instrumentation and control technology in the chemicals industry)	
NC	Not Connected	Not connected
NCQ	Native Command Queuing	Automatic re-sorting of the file and disk access, for increased performance
NEMA	National Electrical Manufacturers Association	Syndicate of manufacturers of electrical components in the USA
NMI	Non Maskable Interrupt	Interrupt the processor can not reject
NTFS	New Techniques File System	Secure file system for certain versions of Windows (NT, 2000, XP)
OPC	OLE for Process Control	Standardized interface for industrial processes
PATA	Parallel ATA	
PC	Personal computer	

## Abbreviations

### C.1 Abbreviations

Abbreviation	Term	Meaning
PCI	Peripheral Component Interconnect	High-speed expansion bus
PCMCIA	Personal Computer Memory Card International Association	
PE	Protective Earth	Protective conductor
PG	Programming device	
PIC	Programmable Interrupt Controller	Programmable interrupt controller
POST	Power On Self Test	
PXE	Preboot Execution Environment	Software for running new PCs without hard disk data via the network
RAID	Redundant Array of Independent Disks	Redundant hard disk array
RAM	Random Access Memory	
RI	Ring Input	Incoming call
ROM	Read-Only Memory	
RS 485	Reconciliation Sublayer 485	Bi-directional bus system designed for up to 32 nodes
RTC	Real Time Clock	Real-time clock
RTS	Reliable Transfer Service	Request to send
RxD	Receive Data	Data transfer signal
SATA	Serial ATA	
SCSI	Small Computer System Interface	
SDRAM	Synchronous DRAM	
SELV	Safety Extra Low Voltage	Safety extra low voltage
SMART	Self Monitoring Analysis and Reporting Technology	Hard disk error diagnostics program
SMS	Short Message Service	Short message via telecommunication network
SNMP	Simple Network Management Protocol	Network protocol
SO-DIMM	Small Outline Dual Inline Memory Module	
SOM	SafeCard on Motherboard (SOM)	
SPP	Standard Parallel Port	Synonym for parallel port
SVGA	Super Video Graphics Array	Enhanced VGA standard with at least 256 colors
SVP	Serial number of the device	
SW	Software	
TCO	Total Cost of Ownership	
TFT	Thin-Film-Transistor	Type of LCD flat-screen
TTY	Tele Type	Asynchronous data transfer
TxD	Transmit Data	Data transfer signal
TWD	Watchdog Time	Watchdog monitoring time
UL	Underwriters Laboratories Inc.	US organisation for tests and certifications according to own or binational standards (with CSA / Canada) standards
UMA	Unified Memory Architecture	
URL	Uniform Resource Locator	Designation of the full address of an Internet page
USB	Universal Serial Bus	



Abbreviation	Term	Meaning
UXGA	Ultra Extended Graphics Array	Graphic standard, maximum resolution 1.600 x 1.200 pixels
V.24		ITU-T standardized recommendation for data transfer via serial ports
VDE	Verein deutscher Elektrotechniker (Union of German Electrical Engineers)	
VGA	Video Graphics Array	Video adapter which meets industrial standard
VRM	Voltage Regulator Module	
W2k	Windows 2000	
WAV	Wave Length Encoding	Loss-free file format for audio data
WD	Watchdog	Program monitoring with error detection and alarming.
WLAN	Wireless LAN	Wireless local area network
WWW	World Wide Web	
XGA	Extended Graphics Array	Graphic standard, maximum resolution 1.024 x 768 pixels

*Abbreviations*

*C.1 Abbreviations*

---

# Glossary

## **ATAPI CD-ROM Drive**

AT-Bus Attachment Packet Interface (connected to AT bus) CD-ROM drive

## **Automation device (AG)**

The programmable logical controllers (PLC) of the SIMATIC S5 system consist of a central controller, one or more CPUs, and various other modules (e.g. I/O modules).

## **Automation system (AS)**

The programmable logical controllers (PLC) of the SIMATIC S7 system consist of a central controller, one or more CPUs, and various I/O modules.

## **Backup**

Duplicate of a program, data carrier or database, used either for archiving purposes or for the protection of vital and non-replaceable data against loss when the working copy is corrupted. Some applications automatically generate backup copies of data files, and manage both the current and the previous versions on the hard disk.

## **Baud**

Physical unit for the step speed in signal transmission. Defines the number of transferred signal states per second. With only two states, one baud is equivalent to a transmission rate of 1 bps.

## **BEEP code**

If the BIOS detects a boot error, it outputs an audible warning based on the current test result

## **Boot diskette**

A diskette that contains a boot sector and an initial loader for the operating system. This can be used to load the operating system from the disk.

## **Booting**

Start or restart of the computer. During booting the operating system is transferred from the system data carrier to the work memory.

### Cache

High-speed access buffer for interim storage (buffering) of requested data.

### CE marking

Communauté Européene The CE symbol confirms the conformance of the product with all applicable EC directives, e.g. the EMC directive.

### Chipset

Located on the motherboard, connects the processor with the RAM, the graphic controller, the PCI bus, and the external interfaces.

### Cold start

A start sequence, starting when the computer is switched on. The system usually performs some basic hardware checks within the cold start sequence, and then loads the operating system from the hard disk to work memory -> boot

### COM interface

The COM interface is a serial V.24 interface. The interface is suitable for asynchronous data transfer.

### Configuration files

These are files containing data which define the configuration after restart. Examples of such files are CONFIG.SYS, AUTOEXEC.BAT and the registry files .

### Configuration software

The configuration software updates the device configuration when new modules are installed . This is done either by copying the configuration files supplied with the module or by manual configuration using the configuration utility.

### Controller

Integrated hardware and software controllers that control the functions of certain internal or peripheral devices (for example, the keyboard controller).

### Device configuration

The configuration of a PC or programming device contains information on hardware and device options, such as memory configuration, drive types, monitor, network address, etc. The data are stored in a configuration file and enable the operating system to load the correct device drivers and configure the correct device parameters. . If changes are made to the hardware configuration, the user can change entries in the configuration file using the SETUP program. .

**Disc-at-once**

With this burning technique, data are written to a CD in a single session, and the CD is then closed. Further write access is then no longer possible.

**Drivers**

Program parts of the operating system. They adapt user program data to the specific formats required by I/O devices such as hard disk, printers, and monitors.

**EMC directive**

Directive concerning **E**lectromagnetic **C**ompatibility. Compliance is confirmed by the CE symbol and the EC certificate of conformity.

**Energy management**

The energy management functions of a modern PC allow individual control over the current consumption of vital computer components (e.g. of the monitor, hard disk and CPU), by restricting their activity based on the current system or component load. Energy management is of particular importance for mobile PCs.

**Energy options**

The energy options can be used to reduce energy consumption of the computer, while keeping it ready for immediate use. This can be configured in Windows by selecting Settings > Control Panel > Energy options.

**ESD guidelines**

Directive for using electrostatic sensitive components.

**Ethernet**

Local network (bus structure) for text and data communication with a transfer rate of 10/100 Mbps.

**Formatting**

Basic partitioning of memory space on a magnetic data carrier into tracks and segments. Formatting deletes all data on a data carrier. All data carriers must be formatted prior to their first use.

**Gender changer**

Using the gender changer (25-pin / 25-pin), the COM1/V24/AG interface of the SIMATIC PC family can be converted to the usual 25-pin male connector.

### **Hard disks**

Hard disks represent a form of magnetic disk storage medium (Winchester drives, hard disks) with integrated magnetic disks.

### **Hot swapping**

The SATA interface gives the device's hard drive system hot-swap capability. The prerequisite for this is a RAID1 system, comprising a SATA RAID controller (onboard or as a slot board, and at least two SATA swap frames. The advantage of hot swapping is that defective hard disks can be replaced without the need for rebooting.

### **Hub**

A term in network technology. In a network, a device joining communication lines at a central location, providing a common connection to all devices on the network.

### **Hyper Threading**

HT technology enables the parallel processing of tasks. HT is only effective when all relevant system components, such as processors, operating systems and applications are supported.

### **Image**

This refers to the image, for example, of hard disk partitions saved to a file in order to restore them when necessary.

### **Intel chip set 915 GM**

The chip set organizes the data traffic between the main processor, working memory, cache, slots and other interfaces.

Functions of the 915 GM: Front side bus with 533 MHz, Intel® graphical media accelerator 900, support for up to 2 GB dual-channel DDR2 memories, Intel® High definition audio, Intel® display power-saving technology 2 (Intel® DPST 2)

### **Interface**

see Interface

### **Interface, multi-point**

MPI is the programming interface of SIMATIC S7/M7. Allows central access to programmable modules, text-based displays and OPs. The MPI nodes can intercommunicate.

### **LAN**

**Local Area Network:** LAN is a local network that consists of a group of computers and other devices that are distributed across a relatively restricted range and are linked with communication cables. The devices connected to a LAN are called nodes. The purpose of networks is the mutual use of files, printers or other resources.

**Legacy USB support**

Support of USB devices (e.g. mouse, keyboard) on the USB ports without driver.

**License key**

The license key represents the electronic license stamp of a license. Siemens provides the license keys for protected software.

**License key diskette**

The license key diskette contains the authorizations or license keys required to enable protected SIMATIC software.

**Low-voltage directive**

EC directive for product safety of products operated with low voltage (AC 50V to 1000V, DV 70V to 1500V) that are not governed by other directives. Compliance is confirmed by the CE symbol and the EC certificate of conformity.

**LPT interface**

The LPT interface (Centronics interface) is a parallel interface that can be used to connect a printer.

**Memory card**

Memory cards in credit card format. Memory for user programs and parameters, for example, for programmable modules and CPs.

**Module**

Modules are plug-in units for PLCs, programming devices or PCs. They are available as local modules, expansion modules, interfaces or mass storage (Mass storage module).

**Module bracket**

The module bracket is used to fasten modules and ensure safe contact and transport. Shocks and vibrations especially affect large, heavy modules. It is therefore recommended to use the module bracket for this type of module. There are also short, compact and light modules on the market. The module bracket was not designed for these modules because the standard fastening is sufficient for them.

**Motherboard**

The motherboard is the core of the computer. Here, data are processed and stored, and interfaces and device I/Os are controlled and managed.

### **Operating system**

Summarizing term describing all functions for program execution, allocation of system resources to the various user programs, and for controlling and monitoring consistency of the operating mode in cooperation with the hardware (e.g. Windows XP Professional).

### **Packet writing**

The CD-RW is used as a diskette medium. The CD can then be read only by packet-writing compatible software or has to be finalized. Finalization of a CD closes the CD within an ISO9660 shell. You can still write to the CD-RW several times in spite of finalization. Not all CD drives can read packet-written CDs. There are restrictions to using this method in general data transfer.

### **PATA**

An interface for hard disk drives and optical drives with parallel data transfer of up to 100 Mbps.

### **PC card**

Trademark of the Personal Computer Memory Card International Association (PCMCIA). Designation for auxiliary cards that conform with PCMCIA specifications. A PC card that has roughly the size of a credit card can be plugged into a PCMCIA slot. Version 1 specifies cards of Type I with a thickness of 3.3 millimeters, which is conceived mainly for use as external memory. Version 2 of the PCMCIA specification also defines a card Type II with a thickness of 5 mm and a card of the Type III with a thickness of 10.5 mm. Type II cards can realize devices such as modems, fax and network interface cards. Type III cards are equipped with devices that require more space, for example wireless communication modules or rotary storage media (hard disks, for example).

### **PC/104 / PC/104-Plus**

Two bus architectures are especially fashionable today in the industrial world. PC/104 and PC/104-*Plus*. Both are standard in single-board computers of the PC class. The electrical and logical layout of the two bus systems is identical with ISA (PC/104) and PCI (PC/104-*Plus*). Software cannot usually detect a difference between them and normal desktop bus systems. Their advantage is the compact design and the resulting space they save.

### **PCMCIA**

Association consisting of approx. 450 member companies of the computer industry. Their focus is set on providing worldwide standards for miniaturization and flexible use of PC expansion cards, and thus to provide a basic technology to the market.

### **Pentium M**

Intel processor type: The architecture of the processor is designed for mobile computing; the processor features superior performance characteristics for computer applications and enhanced power-saving functions



**Pixel**

**Pixel**Element (picture point). The pixel represents the smallest element that can be reproduced on-screen or on a printer.

**POST**

Self-test performed by the BIOS after the computer is switched on. Performs a RAM test and a graphic controller test, for example. The system outputs audible signals (beep codes) if the BIOS detects any errors; the relevant message indicating cause of error is output on the screen.

**PROFIBUS/MPI**

**Process Field Bus** (standard bus system for process applications)

**PXE server**

A **Preboot Execution Environment** server is part of a network environment and can provide software to connected computers even before they boot. This can involve operating system installations or servicing tools, for example.

**RAID**

**Redundant Array of Independent Disks**: Data storage system which is used to store data along with the error correction codes (e.g. parity bits) on at least two hard disks, in order to increase system reliability and performance. The hard disk array is controlled by management programs and a hard disk controller for error correction. The RAID system is usually implemented in network servers.

**Recovery CD**

Contains the tools for setting up the hard disks and the Windows operating system.

**Reset**

Hardware reset: Reset/restart of the PC using a button/switch.

**Restart**

Warm start of a computer in operating state without switching off the power supply (Ctrl + Alt + Del)

**Restore DVD**

The Restore DVD is used to restore the system partition or the entire hard disk to factory state if the system has crashed. The bootable DVD contains all the necessary image files. You can also create a boot disk allowing restoration via the network.

## **ROM**

Read-Only Memory ROM is a read-only memory in which every memory location can be addressed individually. The programs or data are permanently stored and are not lost in the event of a power failure.

## **SCSI interface**

Small Computer System Interface Interface for connecting SCSI devices (e.g. hard disk or optical drives)

## **Session at once**

In session at once, the CD can be written to both with an audio session and a data session. The two sessions are written to at once (as in disc at once).

## **SETUP (BIOS Setup)**

A program in which information about the device configuration (that is, the configuration of the hardware on the PC/PG) is defined. The device configuration of the PC/PG is preset with defaults. Changes must therefore be entered in the SETUP if a memory extension, new modules or a new drive are added to the hardware configuration.

## **Track-at-once**

In track-at-once recording, a CD can be written to in bits in several sessions if the CD was not closed.

## **Troubleshooting**

Error cause, cause analysis, remedy

## **V.24 interface**

The V.24 interface is a standardized interface for data transmission. Printers, modems, and other hardware modules can be connected to a V.24 interface

## **Warm restart**

The restart of a computer after a program was aborted. The operating system is loaded and restarted again. The hot key CTRL+ ALT+ DEL can be used to perform a warm start.

## **Windows**

Microsoft Windows is a multitasking graphical user interface. Windows provides a standard graphical interface based on drop-down menus, windowed regions on the screen, and allows operation with a pointer device such as a mouse.

## WLAN

**Wireless LAN** is a local network that transmits data via radio waves, infrared light or another wireless technology. Wireless LAN is mainly used in connection with mobile computers in the office or in factory environments.



# Index

## 2

- 24 V DC power supply, 3-11
  - Connecting, 6-4

## A

- Abbreviations, C-1
- Accessories, 3-4
- Advanced Menu
  - BIOS Setup, 16-38
- Allocation of resources, 10-7
- Antivirus software, 7-2
- Approvals, 4-3
- Assignment
  - External ports, 16-4
  - I/O addresses, 16-21
  - Interrupts, 16-23
  - Memory addresses, 16-24
  - PCI IRQ channels, 16-18
  - Resources, 10-6

## B

- Battery, 2-2
- Battery replacement, 11-3
- BEEP codes, 12-3
- Benefits, 3-2
- BIOS
  - Advanced Menu, 16-38
  - Beep codes, 12-3
  - Boot Menu, 16-44
  - Defaults, 16-47
  - Main menu, 16-28
  - Menu layout, 16-26
  - Security menu, 16-42
  - Setup, 16-25
  - Setup menus, 16-26
- Boot Options, 16-33
- Boot sequence
  - Error messages, 12-1
- Booting
  - Error messages, 12-1

- Bottom, 3-7
- Burning
  - CD-R / CD-RW, 7-3
- Bus board
  - Design, 16-17
  - Removing, 11-7

## C

- CD-R / CD-RW
  - Operating notes, 7-3
- CE label, A-1
- Certificates
  - Certifications and approvals, A-2
- Certifications and approvals
  - Certificates, A-2
- Characteristics, 3-3
- Climatic conditions, 14-2
- COA label, 4-2
- Cold restart, 7-1
- COM port
  - Interfaces, 3-9
- COM/LPT configuration, 16-39
- Compact Flash
  - Detailed descriptions, 16-9
  - Installing/removing a card, 10-16
  - Partitioning, 10-16
- Compact Flash Card, 3-9
- Connecting
  - 24 V DC power supply, 6-4
  - I/Os, 6-1
  - Peripherals, A-2
- Connecting components, 3-9
- Connection, 6-3
  - Power supply 120/230 V AC, 6-2

## D

- Data backup, 11-28
- Data exchange, 8-1
- Date, 16-28
  - BIOS Setup, 16-28
- Declaration of conformity, A-1
- Defaults

- BIOS, 16-47
- Degree of protection, 14-1
- Design
  - Bus board, 16-17
- Device
  - Open, 10-2
  - unpacking, 4-1
- Device configuration, 16-47
- DiagMonitor
  - expansion, 3-4
  - Fan monitoring, 9-2, 9-4
  - Temperature monitoring, 9-1
- Diagnostics, 13-3
  - BIOS beep codes, 12-3
  - DiagMonitor, 9-1
  - SOM (Safecard On Motherboard), 9-1
  - Troubleshooting, 13-1
- Dimension drawing, 15-1, 15-4
- Dimensions, 14-1
- Display
  - Interfaces, 3-10
  - Ports, 16-10
- Drive bay module, 10-8
  - Removing, 10-10
- Drivers, 11-26
- DVD ROM
  - Installing burner/DVD software, 11-27
- DVD ROM/CD RW
  - Removing, 10-11
- DVD-ROM
  - Operating notes, 7-3
- DVI interface, 16-7, 16-8

## E

- Electrostatic sensitive devices, 2-2
- Electrostatically sensitive devices, B-1
- EMC, A-3
- EMC directive, A-1
- Equipment fan, 11-10, 11-12
- Equipotential bonding terminal, 6-5
- Error messages
  - BIOS beep codes, 12-3
  - Booting, 12-1
  - Troubleshooting, 13-1
- ESD guidelines, 2-2
- ESD Guidelines, B-1
- expansion, 3-4
- Expansion
  - Module, 10-6
  - PCI/AT cards, 10-6
- Extension
  - Memory, 10-3

- External ports, 16-4

## F

- Factory state, 11-17, 11-20
- Fan
  - Monitoring, 9-4
- Fans
  - Monitoring, 9-2
  - Removal, 11-10, 11-12
- FAQs, 13-3
- Fault, 13-3
- Field devices, 8-1
- Firewall, 7-2
- Front view, 3-6

## G

- General technical data, 14-1
- Guidelines
  - ESD Guidelines, B-1

## H

- Hard disk drive
  - Removing, 10-12
- Hardware Options, 16-36
  - BIOS Setup, 16-36
- Heat-conducting paste, 11-16

## I

- I/O addresses
  - Assignment, 16-21
- I/O front interface, 16-13
- I/Os, 6-1
- Identification data, 4-2
- IEC power connector, 3-10
- Image
  - creating, 11-28
- Initial commissioning, 7-1
- Installation
  - Memory modules, 10-4
  - Modules, 10-6
- Installation
  - Burner / DVD software, 11-27
- Integration
  - Profibus, 8-1
  - RJ45 Ethernet, 8-1
- Interconnection to SIMATIC S7, 8-1
- Interfaces, 3-9, 16-3
  - Ethernet RJ 45, 8-1, 16-2

- Keyboard, 16-35
- PROFIBUS, 3-9, 8-1, 14-3
- RJ45 Ethernet, 3-4, 16-36
- USB, 3-4, 14-3
- VGA, 3-4, 3-9
- Interfaces assignment on the motherboard
  - ATX power supply, 16-10
- Internal interfaces, 16-14
- Interrupts, 16-23
  - Assignment, 16-23
- IT communication, 8-1

## K

- Keyboard
  - BIOS Setup, 16-35
  - BIOS Setup, 16-35
  - Features, 16-35
  - Interfaces, 3-9

## L

- Language selection
  - Windows XP, 11-24
- Language selection for Windows 2000, 11-21
- License key, 11-17, 11-19
- Lithium battery, 11-2
- Localized information, 6-3
- Low-voltage directive, A-1
- LPT port
  - BIOS Setup, 16-39
- LVDS
  - Ports, 16-10

## M

- Mech. Environmental Conditions, 14-2
- Memory
  - Extension, 10-3
- Memory addresses
  - Assignment, 16-24
- Memory configuration, 10-5
- memory modules
  - Removing, 10-5
- Memory modules
  - Installation, 10-4
- Messages
  - BIOS beep codes, 12-3
- Modules
  - Installation, 10-3
  - Module bracket, 10-6
- Monitoring

- DiagMonitor, 9-1
- Fan, 9-4
- Fans, 9-2
- SOM (Safecard On Motherboard), 9-3
- Temperature, 9-1
- Watchdog, 9-2
- Monitoring functions, 3-3
- Motherboard, 11-8, 14-2, 16-1
  - External ports, 16-4
  - Internal interfaces, 16-14
  - Location of the interfaces, 16-3
  - Removing, 11-8
- Mounting angle
  - Screw-mounting, 5-1, 5-2, 5-3
- Multilanguage User Interface, 11-21

## O

- On / Off switch, 3-8
- Online ordering system, 8-1
- Open
  - Device, 10-2
- Operating system, 7-1
  - Initial commissioning, 7-1
  - Windows 2000, 11-21, 11-22
  - Windows XP, 11-20, 11-21, 11-22
  - Windows XP Embedded, 11-25
- Operator panels
  - Interfaces, 3-10
- Output voltage, 14-5, 14-6

## P

- Parallel port
  - BIOS Setup, 16-39
- Partitioning
  - Windows 2000, 11-21
  - Windows XP, 11-21
  - Windows XP Embedded, 11-25
  - Windows XP Professional, 11-25
- Password
  - Boot, 16-43
  - Supervisor, 16-42
  - User, 16-43
- PCI / AT cards
  - BIOS Setup, 16-40
  - Technical specifications, 14-2
- PCI configuration, 16-40
- PCI Devices, 16-41
- PCI IRQ channels
  - Assignment, 16-18
- PCI/AT cards
  - Extension, 10-6

Peripherals

Connecting, A-2

Permitted mounting positions, 4-4

Pin assignment of the interfaces on the motherboard

COM2 (X31), 16-9

DVI, 16-7, 16-8

Ethernet, 16-6

PROFIBUS / MPI, 16-5

USB, 16-4

Ports

Display, 16-10

LVDS, 16-10

POST codes

BIOS beep codes, 12-3

Power consumption, 14-1

Power Good Signal, 14-5, 14-6

Power requirements, 14-4

Power supply, 6-2

AC power supply, 14-5

DC power supply, 14-6

IEC power connector, 3-10

Power requirements of the components, 14-4

Removing, 11-5

Power supply 120/230 V AC, 3-10

Primary Master, 16-29

BIOS Setup, 16-29

Primary Slave

BIOS Setup, 16-29

Processor, 11-14, 14-2

Latch, 11-15

Replacement, 11-14

PROFIBUS, 8-1, 14-3

Integration, 8-1

Interfaces, 16-2

Technical specifications, 14-3

PROFIBUS/MPI interface, 16-5

**R**

RAID Level 1, 7-8

RAID system, 7-4

Management functions, 7-8

Rear view, 3-6

Recovery CD, 11-23

Recovery functions, 11-23

Removing

Bus board, 11-7

Drive bay module, 10-10

DVD ROM/CD RW, 10-11

Fans, 11-10, 11-12

Hard disk drive, 10-12

memory modules, 10-5

Motherboard, 11-8

Power supply, 11-5

Processor, 11-14

Repairs, 2-1, 11-1

Replacing

Battery, 11-2

Restore CD, 11-17, 11-19

RJ45 Ethernet, 8-1, 16-6

Interfaces, 3-4

**S**

Safety instructions, 2-1

Secondary Master

BIOS Setup, 16-29

Secondary Slave

BIOS Setup, 16-29

Security menu

BIOS Setup, 16-42

Serial interface, 3-9

BIOS Setup, 16-39

Service, A-4

Setting up partitions, 11-21

Side view, 3-7

SIMATIC S7

Integration, 8-1

Slots, 3-3

Socket, 11-16

SOFTNET for PROFIBUS, 8-1

SOFTNET S7

Integration, 8-1

Software, 11-17

SOM (Safecard On Motherboard), 9-3

Temperature monitoring, 9-3

Standard versions, 3-4

Status displays, 14-3

Steel slot cover, 10-6

Supply voltage, 6-3, 14-1

Support, A-4

System Date, 16-28

BIOS Setup, 16-28

System parameters, 16-47

System partition, 11-17, 11-19

System resources, 16-21

Currently allocated system resources, 16-21

Interrupt assignments, 16-23

System Time, 16-28

BIOS Setup, 16-28

**T**

Temperature, 14-2

Fan monitoring, 9-2, 9-4

Monitoring, 9-1



Temperature error, 13-3  
Third-party modules, 13-2  
Time of day, 16-28  
    BIOS Setup, 16-28  
Tools, 10-11, 11-2, 11-16  
Training center, A-4  
Transport, 4-1  
Troubleshooting, 13-3  
Troubleshooting/FAQs, 13-1

## U

Updates  
    Operating system, 11-27  
    User programs and drives, 11-27, 11-28  
USB, 14-3  
    Interface assignments, 16-4  
    Interfaces, 3-4, 16-2  
    Technical specifications, 14-3  
User Password, 16-43

## V

Vent slots, 4-3  
Version menu  
    BIOS Setup, 16-45  
VGA  
    Interfaces, 3-4, 3-9

## W

Warranty, 2-1  
Watchdog  
    Monitoring function, 9-2  
    Monitoring times, 9-2  
Weight, 14-1  
Windows 2000  
    Partitioning the hard disk, 11-21, 11-22  
Windows Security Center, 7-2  
Windows XP  
    Language selection, 11-24  
    Partitioning the hard disk, 11-21, 11-22  
Windows XP Embedded  
    Data backup, 11-28  
    Partitioning the hard disk, 11-25  
    Reinstalling the Operating System, 11-17  
    Setting up partitions, 11-25  
    Updates, 11-27  
Windows XP Professional  
    Data backup, 11-28  
    Partitioning the hard disk, 11-25  
    Reinstalling the operating system, 11-19





**Siemens AG**

Automation and Drives  
Industrial Automation Systems  
Postfach 4848  
90437 NUERNBERG  
Federal Republic of Germany

[www.siemens.com/automation](http://www.siemens.com/automation)

ID: A5E00362052-03