

Configuration Manual, Edition 12/2004

sinamics

Synchronous Servomotors  
1FT6

**SIEMENS**



# SIEMENS

## SINAMICS

### 1FT6 Synchronous Motors

#### Configuration Manual

**Foreword**

---

**Motor Description**

---

**1**

**Electrical Connections**

---

**2**

**Technical Data and Speed-Torque Diagrams**

---

**3**

**Motor Components (Options)**

---

**4**

**Dimension Drawings**

---

**5**

**Appendix**

---

**A**

**(PFT6), Edition 12.2004**

6SN1197-0AD12-0BP0

## Safety Guidelines

This manual contains notices you have to observe in order to ensure your personal safety, as well as to prevent damage to property. The notices referring to your personal safety are highlighted in the manual by a safety alert symbol, notices referring to property damage only have no safety alert symbol. These notices shown below are graded according to the degree of danger.



### Danger

indicates that death or severe personal injury **will** result if proper precautions are not taken.



### Warning

indicates that death or severe personal injury **may** result if proper precautions are not taken.



### Caution

with a safety alert symbol, indicates that minor personal injury can result if proper precautions are not taken.

### Caution

without a safety alert symbol, indicates that property damage can result if proper precautions are not taken.

### Notice

indicates that an unintended result or situation can occur if the corresponding information is not taken into account.

If more than one degree of danger is present, the warning notice representing the highest degree of danger will be used. A notice warning of injury to persons with a safety alert symbol may also include a warning relating to property damage.

## Qualified Personnel

The device/system may only be set up and used in conjunction with this documentation. Commissioning and operation of a device/system may only be performed by **qualified personnel**. Within the context of the safety notes in this documentation qualified persons are defined as persons who are authorized to commission, ground and label devices, systems and circuits in accordance with established safety practices and standards.

## Prescribed Usage

Note the following:



### Warning

This device may only be used for the applications described in the catalog or the technical description and only in connection with devices or components from other manufacturers which have been approved or recommended by Siemens. Correct, reliable operation of the product requires proper transport, storage, positioning and assembly as well as careful operation and maintenance.

## Trademarks

All names identified by ® are registered trademarks of the Siemens AG. The remaining trademarks in this publication may be trademarks whose use by third parties for their own purposes could violate the rights of the owner.

### Copyright Siemens AG 2004. All rights reserved.

The distribution and duplication of this document or the utilization and transmission of its contents are not permitted without express written permission. Offenders will be liable for damages. All rights, including rights created by patent grant or registration of a utility model or design, are reserved.

### Disclaimer of Liability

We have reviewed the contents of this publication to ensure consistency with the hardware and software described. Since variance cannot be precluded entirely, we cannot guarantee full consistency. However, the information in this publication is reviewed regularly and any necessary corrections are included in subsequent editions.

Siemens AG  
Automation and Drives  
Postfach 4848, 90327 Nuremberg, Germany

Siemens AG 2005  
Technical data subject to change



## Designation of the documentation

### Printing history

Brief details of this edition and previous editions are listed below.

The status of each edition is shown by the code in the "Remarks" column.

*Status code in the "Remarks" column:*

- A** New documentation
- B** Unrevised reprint with new Order No.
- C** Revised edition with new status

If factual changes have been made on the page since the last edition, this is indicated by a new edition coding in the header on that page.

<b>Edition</b>	<b>Order No. for 1FT6</b>	<b>Remarks</b>
12.04	6SN1197-0AD12-0BP0	<b>A</b>

### Trademarks

SINAMICS®, SIMOTION®, SIMATIC®, SIMATIC HMI®, SIMATIC NET®, SIROTEC®, SINUMERIK®, SIMODRIVE®, SIMOVERT MASTERDRIVES® and MOTION-CONNECT® are registered trademarks of Siemens AG. Other names in this publication might be trademarks whose use by a third party for his own purposes may violate the rights of the registered holder.

Further information is available on the Internet under:  
<http://www.siemens.com/motioncontrol>

This publication was produced with SIPS+

© Siemens AG 2004. All rights reserved.

The control system may support functions that are not described in this documentation. However, no claim can be made regarding the availability of these functions when the equipment is first supplied or in the event of servicing.

Order No. 6SN1197-0AD07-0BP2  
Printed in the Federal Republic of Germany

We have checked that the contents of this document correspond to the hardware and software described. Nonetheless, differences might exist and therefore we cannot guarantee that they are completely identical. The information given in this publication is reviewed at regular intervals and any corrections that might be necessary are made in the subsequent printings. Suggestions for improvement are also welcome.

We reserve the right to make technical changes.

Siemens-Aktiengesellschaft



# Foreword

## Information on the documentation

This document is part of the Technical Customer Documentation which has been developed for the SINAMICS S120 system. All of the documents are available individually. The documentation list, which includes all Advertising Brochures, Catalogs, Overviews, Short Descriptions, Operating Instructions and Technical Descriptions with Order No., ordering address and price can be obtained from your local Siemens office.

This document does not purport to cover all details or variations in equipment, nor to provide for every possible contingency to be met in connection with installation, operation or maintenance.

We would also like to point-out that the contents of this document are neither part of nor modify any prior or existing agreement, commitment or contractual relationship. The sales contract contains the entire obligations of Siemens. The warranty contained in the contract between the parties is the sole warranty of Siemens. Any statements contained herein neither create new warranties nor modify the existing warranty.

## Structure of the documentation for 1FK and 1FT motors

Table 1 Configuration Manual, individual sections

Title	Order No. (MLFB)	Language
Synchronous Motors, General Section for SIMODRIVE, SIMOVERT MASTERDRIVES and SINAMICS S120	6SN1197-0AD07-0AP□	German
Synchronous Motors, 1FK7 Motor Section for SINAMICS S120	6SN1197-0AD16-0AP□	German
Synchronous Motors, 1FT6 Motor Section for SINAMICS S120	6SN1197-0AD12-0AP□	German

## Hotline

If you have any questions, please contact the following Hotline:

A&D Technical Support

Phone: +49 (180) 5050-222

Fax: +49 (180) 5050-223

<http://www.siemens.de/automation/support-request>

If you have any questions regarding the documentation (suggestions, corrections) then please send a fax to the following number:

+49 (9131) 98-2176

Fax form: Refer to the response sheet at the end of the document

## Danger and warning information



---

### Danger

Start-up/commissioning is absolutely prohibited until it has been completely ensured that the machine, in which the components described here are to be installed, is in full compliance with the specifications of Directive 98/37/EC.

SINAMICS devices and synchronous motors may only be commissioned by suitably qualified personnel.

This personnel must carefully observe the technical customer documentation associated with this product and be knowledgeable about and carefully observe the danger and warning information.

Operational electrical equipment and motors have parts and components which are at hazardous voltage levels.

When the machine or system is operated, hazardous axis movements can occur.

All of the work carried-out on the electrical machine or system must be carried-out with it in a no-voltage condition.

SINAMICS drive units are designed for operation on low-ohmic, grounded line supply systems (TN line supply systems).

---



---

### Warning

The successful and safe operation of this equipment and motors is dependent on professional transport, storage, installation and mounting as well as careful operator control, service and maintenance.

For special versions of the drive units and motors, information and data in the catalogs and quotations additionally apply.

In addition to the danger and warning information/instructions in the technical customer documentation supplied, the applicable domestic, local and plant-specific regulations and requirements must be carefully taken into account.

---



---

**Caution**

The motors can have surface temperatures of over +100° C.

This is the reason that temperature-sensitive components, e.g. cables or electronic components may neither be in contact nor be attached to the motor.

When connecting-up cables, please observe that they

- are not damaged
  - are not subject to tensile stress
  - cannot be touched by rotating components.
- 



---

**Caution**

The DRIVE-CLiQ interface contains motor and encoder-specific data as well as an electronic rating plate. This is the reason that this Sensor Module may only be operated on the original motor - and may not be mounted onto other motors or replaced by a sensor module from other motors.

The DRIVE-CLiQ interface has direct contact to components that can be damaged/destroyed by electrostatic discharge (ESDS). Neither hands nor tools that could be electrostatically charged may come into contact with the connections.

---

---

**Caution**

SINAMICS drive units with synchronous motors are subject, as part of the routine test, to a voltage test in accordance with EN 50178. While the electrical equipment of industrial machines is being subject to a voltage test in accordance with EN60204-1, Section 19.4, all SINAMICS drive unit connections must be disconnected/withdrawn in order to avoid damaging the SINAMICS drive units.

Motors should be connected-up according to the circuit diagram provided. It is not permissible to directly connect the motors to the three-phase line supply. Motors will be destroyed if they are connected directly to the three-phase line supply.

---

---

**Note**

SINAMICS units with synchronous motors fulfill, when operational and in dry operating rooms, the Low-Voltage Directive 73/23/EEC.

SINAMICS units with synchronous motors fulfill, in the configuration specified in the associated EC Declaration of Conformity, the EMC Directive 89/336/EEC.

---

## ESDS instructions



### Caution

An electrostatic-sensitive device (ESDS) is an individual component, integrated circuit, or module that can be damaged by electrostatic fields or discharges.

ESDS regulations for handling boards and equipment:

When handling components that can be destroyed by electrostatic discharge, it must be ensured that personnel, the workstation and packaging are well grounded!

Personnel in ESD zones with conductive floors may only touch electronic components if they are

- grounded through an ESDS bracelet and
- wearing ESDS shoes or ESDS shoe grounding strips.

Electronic boards may only be touched when absolutely necessary.

Electronic boards may not be brought into contact with plastics and articles of clothing manufactured from man-made fibers.

Electronic boards may only be placed on conductive surfaces (table with ESDS surface, conductive ESDS foam rubber, ESDS packing bag, ESDS transport containers).

Electronic boards may not be brought close to data terminals, monitors or television sets. Minimum clearance to screens > 10 cm).

Measurements may only be carried-out on electronic boards and modules if

- the measuring instrument is grounded (e.g. via a protective conductor) or
- before making measurements with a potential-free measuring device, the measuring head is briefly discharged (e.g. by touching an unpainted blank piece of metal on the control cabinet).

## Standards, regulations

The appropriate standards, regulations are directly assigned to the functional requirements.





# Table of Contents

	Foreword .....	iii
<b>1</b>	<b>Motor Description .....</b>	<b>1-1</b>
1.1	Features .....	1-1
1.2	Technical features.....	1-3
1.3	Technical features, options, supplements .....	1-4
1.4	Order designation .....	1-5
1.5	Technical data.....	1-8
1.6	Armature short-circuit braking.....	1-15
1.7	Cooling .....	1-21
1.7.1	Cooling types .....	1-21
1.7.2	Forced ventilation.....	1-21
1.7.3	Water-cooling.....	1-23
1.8	Coupling output.....	1-28
<b>2</b>	<b>Electrical Connections.....</b>	<b>2-1</b>
2.1	Connection overview.....	2-1
2.2	Power connection .....	2-2
2.2.1	Possible connections .....	2-2
2.2.2	Connector connection.....	2-2
2.2.3	Connection through a terminal box.....	2-3
2.3	DRIVE-CLiQ.....	2-5
2.4	Motors with DRIVE-CLiQ .....	2-5
2.5	Motors without DRIVE-CLiQ .....	2-6
2.6	Rotating the connector at the motor .....	2-7
<b>3</b>	<b>Technical Data and Speed-Torque Diagrams.....</b>	<b>3-1</b>
3.1	Speed-torque diagrams .....	3-1
3.1.1	Introduction .....	3-1
3.1.2	1FT6 series, non-ventilated .....	3-2
3.1.3	1FT6 series, force ventilated.....	3-62
3.1.4	1FT6 series, water cooled.....	3-94
3.2	Cantilever force diagrams .....	3-128
3.3	Axial forces.....	3-133

<b>4</b>	<b>Motor Components (Options)</b> .....	<b>4-1</b>
4.1	Thermal motor protection .....	4-1
4.2	Encoders .....	4-3
4.2.1	Encoder overview .....	4-3
4.3	Motors with DRIVE-CLiQ .....	4-4
4.4	Motors without DRIVE-CLiQ .....	4-5
4.4.1	Incremental encoders .....	4-5
4.4.2	Absolute value encoders .....	4-7
4.4.3	Resolvers .....	4-10
4.5	Holding brake (option) .....	4-12
4.6	Gearbox (option) .....	4-13
4.6.1	Introduction .....	4-13
4.6.2	Planetary gearbox 1-stage .....	4-13
4.6.3	Planetary gearbox 2-stage .....	4-18
<b>5</b>	<b>Dimension Drawings</b> .....	<b>5-1</b>
5.1	Introduction .....	5-1
5.2	1FT6 with DRIVE-CLiQ .....	5-2
5.2.1	Non-ventilated 1FT6 motors .....	5-2
5.2.2	Force-ventilated 1FT6 motors .....	5-10
5.2.3	Water-cooled 1FT6 motors .....	5-13
5.3	1FT6 without DRIVE-CLiQ .....	5-18
5.3.1	Non-ventilated 1FT6 motors .....	5-18
5.3.2	Force-ventilated 1FT6 motors .....	5-28
5.3.3	Water-cooled 1FT6 motors .....	5-34
<b>A</b>	<b>Appendix</b> .....	<b>A-1</b>
A.1	References .....	A-1
	<b>Index</b>	

**Tables**

Table 1	Configuration Manual, individual sections .....	iii
Table 1-1	Features of the standard design .....	1-3
Table 1-2	Options and supplements .....	1-4
Table 1-3	Resistor braking for the 1FT6 series, shaft heights 28 to 48, non-ventilated .....	1-15
Table 1-4	Resistor braking for the 1FT6 series, shaft heights 63 to 80, non-ventilated .....	1-16
Table 1-5	Resistor braking for the 1FT6 series, shaft heights 100 to 132, non-ventilated .....	1-17
Table 1-6	Resistor braking for the 1FT6 series, force-ventilated .....	1-18
Table 1-7	Resistor braking for the 1FT6 series, water cooling .....	1-19
Table 1-8	Minimum clearance to parts and components mounted by the customer .....	1-22
Table 1-9	Technical data for the cooling circuit .....	1-23
Table 1-10	Materials used in the motor cooling circuit.....	1-24
Table 1-11	Manufacturers of chemical additives .....	1-25
Table 1-12	Cooling powers to be dissipated .....	1-26
Table 1-13	Assignment of the drive-out couplings to the motors .....	1-28
Table 2-1	Description of the diagram .....	2-4
Table 2-2	Connections for the terminal box .....	2-4
Table 3-1	1FT6021 non-ventilated .....	3-2
Table 3-2	1FT6024 non-ventilated .....	3-4
Table 3-3	1FT6031 non-ventilated .....	3-6
Table 3-4	1FT6034 non-ventilated .....	3-8
Table 3-5	1FT6041 non-ventilated .....	3-10
Table 3-6	1FT6044 non-ventilated .....	3-12
Table 3-7	1FT6061 non-ventilated .....	3-14
Table 3-8	1FT6061 non-ventilated .....	3-16
Table 3-9	1FT6062 non-ventilated .....	3-18
Table 3-10	1FT6062 non-ventilated .....	3-20
Table 3-11	1FT6064 non-ventilated .....	3-22
Table 3-12	1FT6064 non-ventilated .....	3-24
Table 3-13	1FT6081 non-ventilated .....	3-26
Table 3-14	1FT6081 non-ventilated .....	3-28
Table 3-15	1FT6082 non-ventilated .....	3-30
Table 3-16	1FT6082 non-ventilated .....	3-32
Table 3-17	1FT6084 non-ventilated .....	3-34
Table 3-18	1FT6084 non-ventilated .....	3-36
Table 3-19	1FT6086 non-ventilated .....	3-38
Table 3-20	1FT6086 non-ventilated .....	3-40

## Table of Contents

---

Table 3-21	1FT6102 non-ventilated .....	3-42
Table 3-22	1FT6102 non-ventilated .....	3-44
Table 3-23	1FT6105 non-ventilated .....	3-46
Table 3-24	1FT6105 non-ventilated .....	3-48
Table 3-25	1FT6108 non-ventilated .....	3-50
Table 3-26	1FT6108 non-ventilated .....	3-52
Table 3-27	1FT6132 non-ventilated .....	3-54
Table 3-28	1FT6132 non-ventilated .....	3-56
Table 3-29	1FT6134 non-ventilated .....	3-58
Table 3-30	1FT6136 non-ventilated .....	3-60
Table 3-31	1FT6084 force ventilated .....	3-62
Table 3-32	1FT6084 force ventilated .....	3-64
Table 3-33	1FT6086 force ventilated .....	3-66
Table 3-34	1FT6086 force ventilated .....	3-68
Table 3-35	1FT6105 force ventilated .....	3-70
Table 3-36	1FT6105 force ventilated .....	3-72
Table 3-37	1FT6108 force ventilated .....	3-74
Table 3-38	1FT6108 force ventilated .....	3-76
Table 3-39	1FT6132 force ventilated .....	3-78
Table 3-40	1FT6132 force ventilated .....	3-80
Table 3-41	1FT6134 force ventilated .....	3-82
Table 3-42	1FT6134 force ventilated .....	3-84
Table 3-43	1FT6136 force ventilated .....	3-86
Table 3-44	1FT6136 force ventilated .....	3-88
Table 3-45	1FT6163 force ventilated .....	3-90
Table 3-46	1FT6168 force ventilated .....	3-92
Table 3-47	1FT6062, water cooled .....	3-94
Table 3-48	1FT6062, water cooled .....	3-96
Table 3-49	1FT6064, water cooled .....	3-98
Table 3-50	1FT6064, water cooled .....	3-100
Table 3-51	1FT6084, water cooled .....	3-102
Table 3-52	1FT6084, water cooled .....	3-104
Table 3-53	1FT6086, water cooled .....	3-106
Table 3-54	1FT6086, water cooled .....	3-108
Table 3-55	1FT6105, water cooled .....	3-110
Table 3-56	1FT6108, water cooled .....	3-112
Table 3-57	1FT6108, water cooled .....	3-114
Table 3-58	1FT6132, water cooled .....	3-116

Table 3-59	1FT6134, water cooled .....	3-118
Table 3-60	1FT6136, water cooled .....	3-120
Table 3-61	1FT6138, water cooled .....	3-122
Table 3-62	1FT6163, water cooled .....	3-124
Table 3-63	1FT6168, water cooled .....	3-126
Table 3-64	Explanation of the formula abbreviations.....	3-128
Table 4-1	Features and technical data.....	4-1
Table 4-2	Encoders for motors with and without DRIVE-CLiQ .....	4-3
Table 4-3	Prefabricated cable .....	4-4
Table 4-4	Technical data, incremental encoders sin/cos 1Vpp .....	4-5
Table 4-5	Connection assignment for 17-pin flange-mounted socket .....	4-6
Table 4-6	Prefabricated cable .....	4-6
Table 4-7	Technical data, absolute value encoder .....	4-7
Table 4-8	Prefabricated cable .....	4-9
Table 4-9	Technical data, resolvers .....	4-10
Table 4-10	Connection assignment for 12-pin flange-mounted socket.....	4-11
Table 4-11	Prefabricated cable .....	4-11
Table 4-12	Technical data of the holding brakes used for 1FT6 motors .....	4-12
Table 4-13	1FT6 series with 1-stage planetary gearbox (alpha company).....	4-16
Table 4-14	1FT6 series with 1-stage planetary gearbox (alpha company), continued.....	4-17
Table 4-15	1FT6 series with 2-stage planetary gearbox (alpha company).....	4-21
Table 4-16	1FT6 series with 2-stage planetary gearbox (alpha company).....	4-22



# Motor Description

## 1.1 Features

### Overview

1FT6 motors are compact permanent-magnet synchronous motors. 1FT6 motors with integrated encoders can be operated with the SINAMICS S120 drive system.

The fully digital control system of the SINAMICS S120 drive system and the encoder technology of the 1FT6 motors fulfill the highest demands in terms of dynamic performance, speed setting range, and rotational and positioning accuracy.

The motors are primarily designed for operation without external cooling, and the heat is dissipated through the motor surface. The heat that is predominantly generated in the stator winding and in the stator core can be directly dissipated via the good thermal coupling to the motor enclosure. The concept of brushless, permanent-field synchronous motors shows its special merits here.



Figure 1-1 1FT6 motors

## Motor Description

---

### 1.1 Features

#### Benefits

- Optimum surface quality of the workpiece due to high rotational accuracy (sinusoidal current injection)
- Short non-productive idle times due to high dynamic performance
- Power and signal connections for use in very dirty environments
- Simple installation due to reduced cabling requirements
- Can absorb high cantilever forces

#### Application

- High-performance machine tools
- Machines with high requirements in terms of dynamic performance and precision

#### Standards, regulations

The appropriate standards, regulations are directly assigned to the functional requirements.



## 1.2 Technical features

Table 1-1 Features of the standard design

Technical features	Version
Motor type	Permanent-magnet synchronous motor
Type of construction (acc. to EN60034-7; IEC 60034-7)	IM B5 (IM V1, IM V3) for SH 28 to 132 IM B35 (IM V15, IM V36) for 132 to 160 (options, refer to the table)
Degree of protection <sup>4)</sup> (acc. to EN60034-5; IEC 60034-5)	IP64; core types IP65 (options, refer to the table)
Cooling (acc. to EN60034-6; IEC 60034-6)	Non-ventilated <sup>2)</sup> Force-ventilated <sup>2)3)</sup> Water-cooled
Thermal motor protection (acc. to EN 60034-11; IEC 60034-11)	KTY84 temperature sensor in the stator winding
Shaft end (acc. to DIN 748-3; IEC 60072-1)	Cylindrical; without keyway and without fitted key tolerance field k6 (option, refer to the table)
Radial eccentricity, concentricity and axial eccentricity (acc. to DIN 42955; IEC 60072-1)	Tolerance N (normal) options, refer to the Table)
Vibration severity (acc. to EN 60034-14; IEC 60034-14)	Grade N (normal) (options, refer to the table)
Max. sound pressure level (acc. to DIN EN ISO 1680) + 3 dB	SH 28 to 48: approx. 55 dB(A) SH 63 to 100: approx. 70 dB(A) SH 132 to 160 (non-ventilated or water-cooled): approx. 70 dB(A) SH 132 to 160 (force-ventilated): approx. 74 dB(A) The specified values apply to all shaft heights up to speed $n_N$ .
Bearings	Roller bearings with permanent grease lubrication (lubrication over the bearing lifetime) bearing lifetime 20000 h SH 36, 48: Locating bearings on the NDE SH 28, 63 to 160: Locating bearing on the DE
Winding insulation (acc. to EN 60034-1; IEC 60034-1)	Temperature class F for a winding temperature rise of $\Delta T = 100 \text{ K}$ at an ambient temperature of $40 \text{ }^\circ\text{C}$ .
Installation altitude (acc. to EN and IEC 60034-1)	$\leq 1000 \text{ m}$ above sea level, otherwise power-de-rating factor <sup>2)</sup> 2000 m factor 0.94 2500 m factor 0.9
Magnetic material	Magnetic material
Electrical connection	The power is connected either through a terminal box or connector Encoder signals through connectors
Speed encoder, integrated	Optical encoders: <ul style="list-style-type: none"> <li>• Incremental encoders sin/cos 1Vpp (I-2048)</li> <li>• Absolute value encoder EnDat (A-2048 and A-512) <sup>1)</sup></li> <li>• Resolver, two-pole/multi-pole</li> </ul> For more detailed information, refer to the Chapter Encoders.
Rating plate	A second rating plate is provided for all motors

Footnotes, refer to the next page

## 1.3 Technical features, options, supplements

Table 1-2 Options and supplements

Technical feature	Version
Type of construction (acc. to EN60034-7; IEC 60034-7)	IM B14 for SH 63 to 100
Degree of protection <sup>4)</sup> (acc. to EN 60034-5; IEC 60034-5)	IP65, IP67, IP68 Information: SH 28 is only available in degree of protection IP64 or IP67. IP67 and IP68 with sealing air connection. Force-ventilated motors, only available in degree of protection IP64 and IP65 (fan IP54).
Shaft end (acc. to EN and IEC 60034-14)	Cylindrical; with keyway and fitted key; Tolerance field k6 H=half key balancing
Radial eccentricity, concentricity and axial eccentricity (acc. to DIN 42955; IEC 60072-1)	Tolerance R (reduced)
Vibration severity (acc. to EN 60034-14; IEC 60034-14)	Grade R
Mounted/integrated components	Mounted planetary gear for SH 28 to 132 (geared motors only available with vibration severity grade N)
Cable outlet for terminal boxes	Outlet direction can be selected in steps of 90°

<sup>1)</sup>When using an absolute value encoder and non-ventilated or forced ventilation, the rated torque is reduced by 10 % (refer to the Table, Technical data)

<sup>2)</sup> Power de-rating for temperatures > 40 °C and/or installation altitudes > 1000 m, refer to the Configuration Manual "General Section for Synchronous Motors"

<sup>3)</sup> Forced ventilation cannot be used in the presence of flammable, corrosive, electrically conductive or explosive dust.

<sup>4)</sup> For motors with degree of protection IP67 and IP68, since 01/2001, an M5 inner thread is provided in the cover on the NDE. This allows compressed air to be connected. The pressure in the motor should be within the range from 0.05 to 0.1 bar. The compressed air must be dry and clean. For instance, the DA300 compressed air service unit from the Heidenhain company can be used.

For 1FT6 motors without optical encoders, it is sufficient to have a pre-filter that filters-out any foreign bodies above 3 µm.

For 1FT6 motors with optical encoder, in addition to the pre-filter element, a fine filter is required that filters-out foreign bodies above 0.01 µm.

## 1.4 Order designation

### Order designation (standard types), SH 28 to SH 132 (non-ventilated, forced-ventilated and water-cooled)

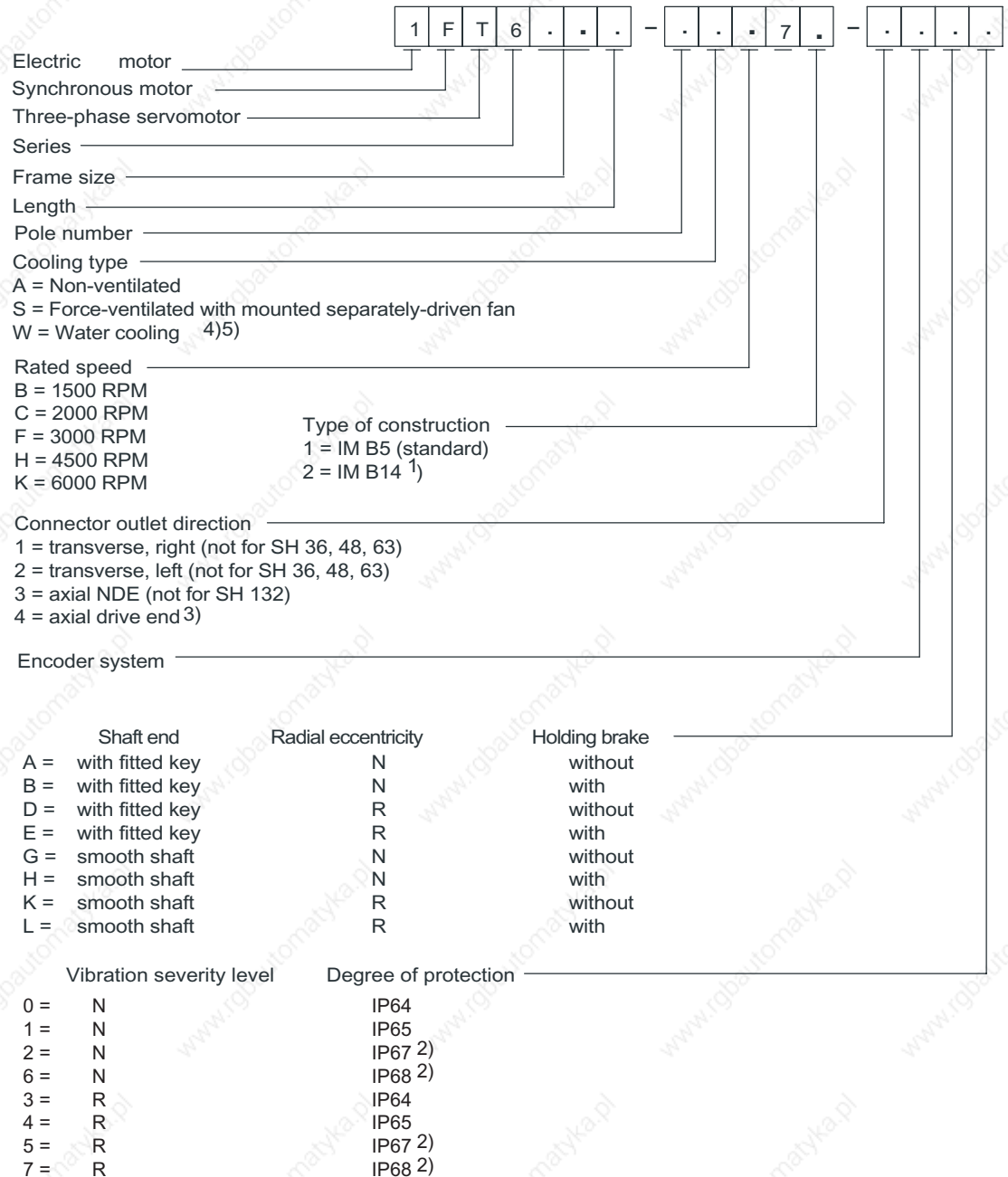

1) Only for SH 63, 80, 100

2) Not for force ventilated motors

3) For 1FT6062 - only in conjunction with a water connection, either at the side or below

4) Water connection is only possible at the righthand side (code -ZQ20) or lefthand side (-ZQ21) or at the bottom (-ZQ22).

5) Without code -ZQ2□, the motor will be supplied with a water connection at the top.

## Motor Description

### 1.4 Order designation

#### Order designation (core types)

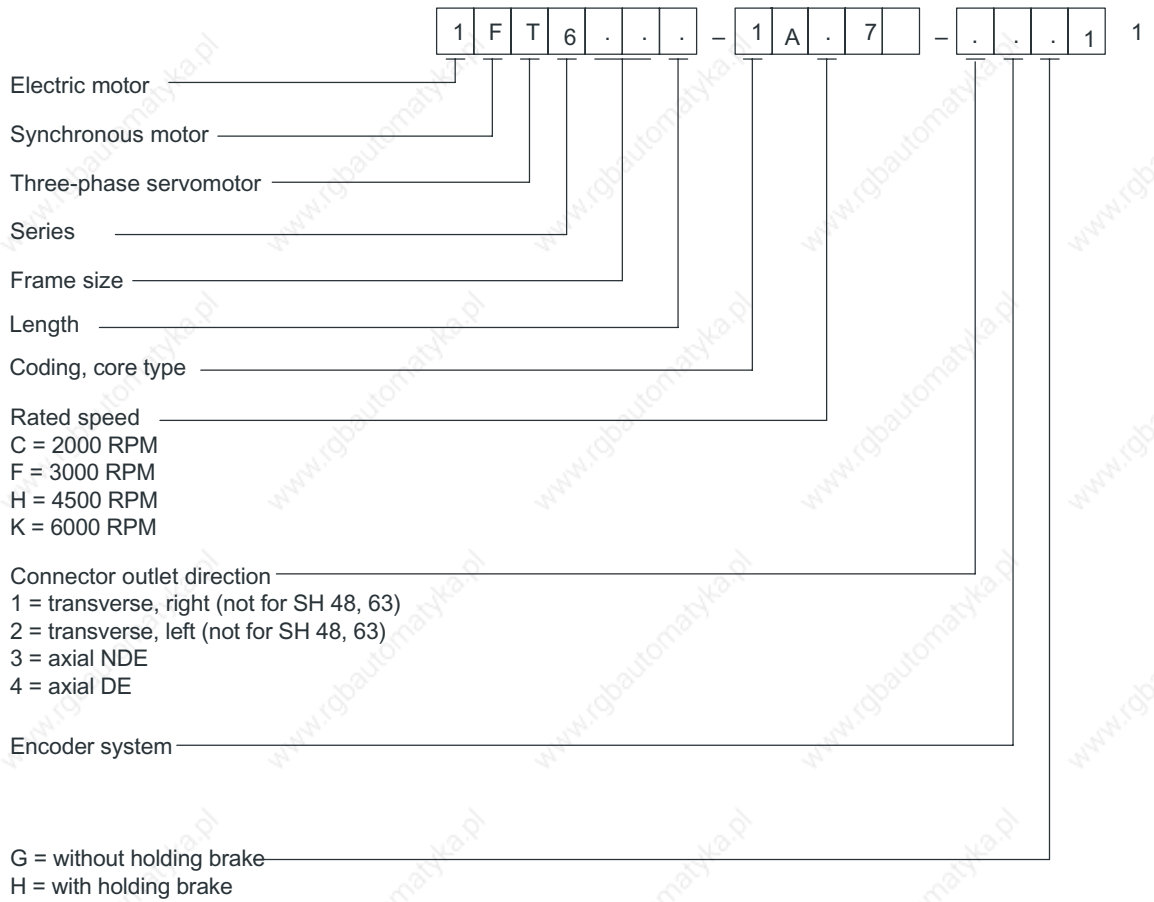

**Order designation for  
SH 132 water cooling and  
SH 160 forced ventilation and water cooling**

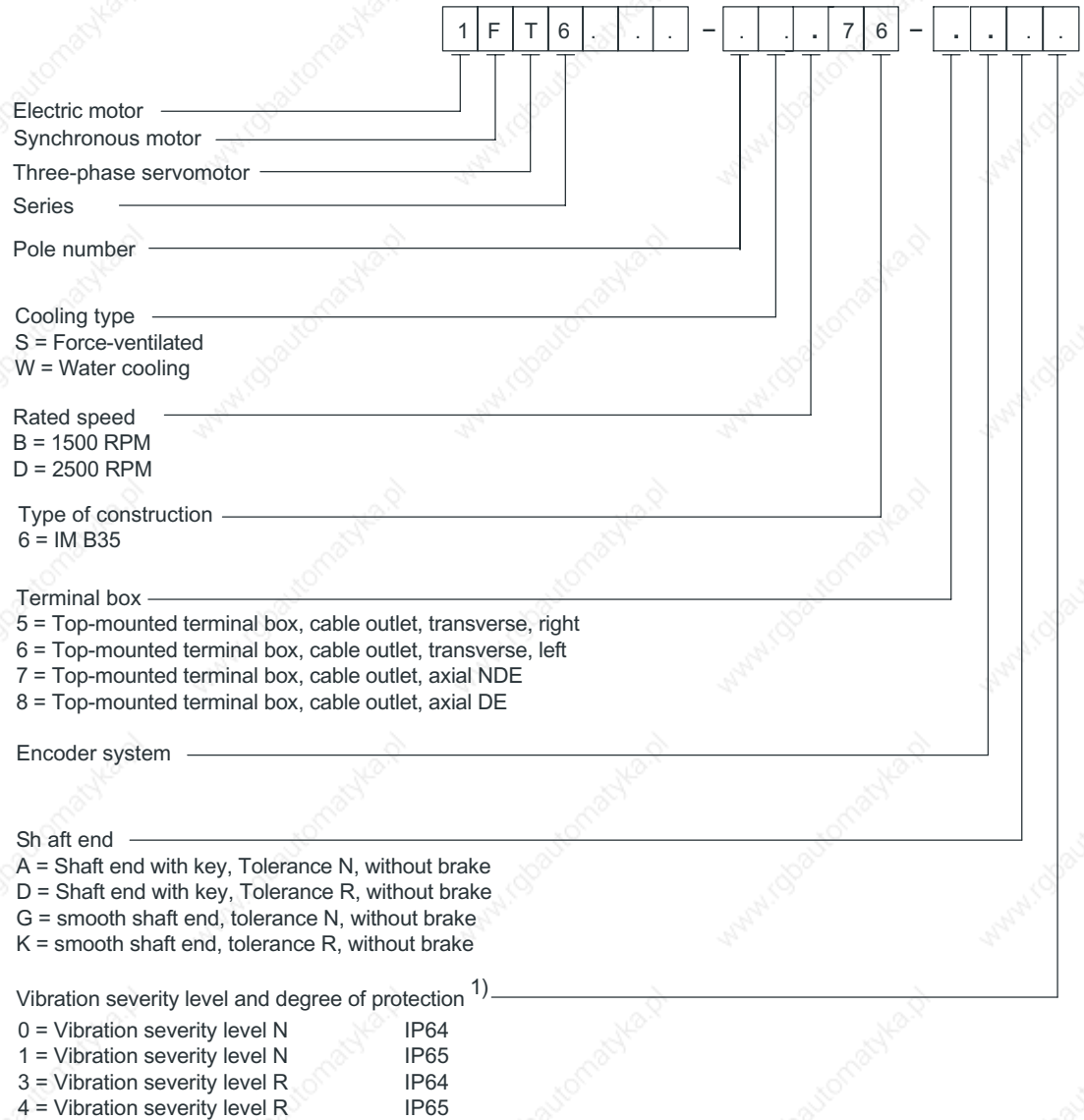

<sup>1)</sup> Specified degree of protection is only valid for water cooling; for air cooling, restrictions apply as a result of the mounted fan IP54

## Motor Description

### 1.5 Technical data

## 1.5 Technical data

Core types have a grey background. 100 K values are specified in the table.

### Technical data 1FT6, rated speed 1500 RPM

$n_N$ [RPM]	$M_0$ [Nm]	$M_N$ [Nm]	$M_N$ 1) [Nm]	Motor type 1FT6--	$I_0$ [A]	$I_N$ [A]	Connector size 2)	Cross-section 3) [mm <sup>2</sup> ]	Cable type 4) 5) 6FX□002- 6)	Terminal box 2)
Non-ventilated										
1500	27.0	24.5	22.05	102-8AB7 □	8.7	8.4	1.5	4 x 1.5	5□S21-1 □□0	gk130
1500	50.0	41.0	36.9	105-8AB7 □	16.0	14.5	1.5	4 x 2.5	5□S31-1 □□0	gk130
1500	70.0	61.0	54.9	108-8AB7 □	22.3	20.5	1.5	4 x 4	5□S41-1 □□0	gk130
1500	75.0	62.0	55.8	132-6AB7 □	21.6	19	1.5	4 x 4	5□S41-1 □□0	gk230
1500	95.0	75.0	67.5	134-6AB7 □	27.0	24	1.5	4 x 4	5□S41-1 □□0	gk230
1500	115.0	88.0	79.2	136-6AB7 □	34.0	27	1.5	4 x 10	5□S61-1 □□0	gk230
Forced ventilation										
1500	65.0	59.0	53.1	105-8SB7 □	21.9	21.7	1.5	4 x 4	5□S41-1 □□0	gk130
1500	90.0	83.0	74.7	108-8SB7 □	30.0	31	1.5	4 x 6	5□S51-1 □□0	gk130
1500	110.0	102.0	91.8	132-6SB7 □	36.0	36	3	4 x 10	5□S13-1 □□0	gk230
1500	140.0	130.0	117.0	134-6SB7 □	44.0	45	3	4 x 10	5□S13-1 □□0	gk230
1500	175.0	160.0	144.0	136-6SB7 □	55.0	55	3	4 x 16	5□S23-1 □□0	gk420
1500	425	385	347	163-8SB7 □ <sup>8)</sup>	151	136	—	—	—	gk630
1500	600	540	486	168-8SB7 □ <sup>8)</sup>	194	174	—	—	—	gk630
Water cooling										
1500	119.0	116.0	116.0	108-8WB7 □	43.0	43	3	4 x 10	5□S13-1 □□0	gk230
1500	155	150	150	132-6WB7 □ <sup>8)</sup>	58	58	—	—	—	gk630
1500	200	190	190	134-6WB7 □ <sup>8)</sup>	73	67	—	—	—	gk630
1500	240	230	230	136-6WB7 □ <sup>8)</sup>	92	90	—	—	—	gk630
1500	300	290	290	138-6WB7 □ <sup>8)</sup>	112	112	—	—	—	gk630
1500	450	450	450	163-8WB7 □ <sup>8)</sup>	160	160	—	—	—	gk630
1500	700	690	690	168-8WB7 □ <sup>8)</sup>	225	221	—	—	—	gk630

Pole number

without brake cable:  
with brake cable:

with overall shield  
with overall shield

C  
D

Lengths 7)  
(examples)

5 m A F  
10 m B A  
15 m B F  
18 m B J  
25 m C F

Cables are not included with the motors - they must be separately ordered.

- 1) With absolute value encoder (due to the max. temperature of the encoder)
- 2) Power connector and terminal box mutually exclude one another
- 3) Motor with terminal boxes, max. cross-section that can be connected, refer to the Table "Connections for terminal boxes"
- 4) The electrical shock hazard protection of the power cables depends on the size of the selected power module (refer to the Configuration Manual, Drive Converters)
- 5) Motor with terminal boxes, power and signals cables, refer to Catalog, Chapter "Connection system MOTION-CONNECT"
- 6) 6FX8002 = MOTION-CONNECT 800;  
6FX5002 = MOTION-CONNECT 500;  
Technical data, refer to Catalog, Chapter "Connection system MOTION-CONNECT"
- 7) Cables can be supplied in integer lengths of precisely 1 meter;  
Length code, refer to the Configuration Manual "General Part for Synchronous Motors"
- 8) For 1FT613□ motors, the maximum current and the rated current of the converter must be carefully observed.  
1FT616□ motors can only be operated with SIMOVERT MASTERDRIVES MC drive converters.



Motor Description

1.5 Technical data

Technical data 1FT6, rated speed 2000 RPM

n <sub>N</sub> [RPM]	M <sub>0</sub> [Nm]	M <sub>N</sub> [Nm]	M <sub>N</sub> <sup>1)</sup> [Nm]	Motor type 1FT6-	I <sub>0</sub> [A]	I <sub>N</sub> [A]	Connector size 2)	Cross-section 3) [mm <sup>2</sup> ]	Cable type 4)5) 6FX□002- 6)	Terminal box 2)
Non-ventilated										
2000	4.0	3.7	3.3	061-6AC7□	1.9	1.9	1	4 x 1.5	5□S01-1□□□	—
2000	6.0	5.2	4.6	062-6AC7□	2.7	2.6	1	4 x 1.5	5□S01-1□□□	—
2000	9.5	8.0	7.2	064-6AC7□	4.2	3.8	1	4 x 1.5	5□S01-1□□□	—
2000	8.0	7.5	6.7	081-8AC7□	3.9	4.1	1.5	4 x 1.5	5□S21-1□□□	—
2000	13.0	11.4	10.0	082-8AC7□	6.6	6.6	1.5	4 x 1.5	5□S21-1□□□	—
2000	20.0	16.9	15.2	084-8AC7□	8.8	8.3	1.5	4 x 1.5	5□S21-1□□□	—
2000	27.0	22.5	20.2	086-8AC7□	11.3	10.9	1.5	4 x 1.5	5□S21-1□□□	—
2000	27.0	23.0	20.7	102-□AC7□	12.1	11	1.5	4 x 1.5	5□S21-1□□□	gk130
2000	50.0	38.0	34.2	105-□AC7□	21.4	17.6	1.5	4 x 4	5□S41-1□□□	gk130
2000	70.0	55.0	49.5	108-8AC7□	29.0	24.5	1.5	4 x 6	5□S51-1□□□	gk130
2000	75.0	55.0	49.5	132-6AC7□	29.0	23	1.5	4 x 6	5□S51-1□□□	gk230
2000	95.0	65.0	58.5	134-6AC7□	36.0	27	1.5	4 x 10	5□S61-1□□□	gk230
2000	115.0	74.0	66.6	136-6AC7□	42.0	30	3	4 x 10	5□S13-1□□□	gk230
Forced ventilation										
2000	65.0	56.0	50.4	105-8SC7□	30.0	28	1.5	4 x 6	5□S51-1□□□	gk230
2000	90.0	80.0	72.0	108-8SC7□	41.0	40	3	4 x 10	5□S13-1□□□	gk230
2000	110.0	98.0	88.2	132-6SC7□	47.0	46	3	4 x 10	5□S13-1□□□	gk420
2000	140.0	125.0	112.5	134-6SC7□	58.0	57	3	4 x 16	5□S23-1□□□	gk420
2000	175.0	155.0	139.5	136-6SC7□	77.0	72	3	4 x 25	5DS33-1□□□	gk420
Water cooling										
2000	85.0	82.0	82.0	105-8WC7□	58.0	60	3	4 x 16	5□S23-1□□□	gk230
2000	119.0	115.0	115.0	108-8WC7□	57.0	57	3	4 x 16	5□S23-1□□□	gk230

1 Core type without brake cable: with overall shield  
8 Pole number with brake cable: with overall shield

C  
D

Lengths<sup>7)</sup>  
(examples)

5 m AF  
10 m BA  
15 m BF  
18 m BJ  
25 m CF

Cables are not included with the motors -  
they must be separately ordered.

- 1) With absolute value encoder (due to the max. temperature of the encoder)
- 2) Power connector and terminal box mutually exclude one another
- 3) Motor with terminal boxes, max. cross-section that can be connected, refer to the Table "Connections for terminal boxes"
- 4) The electrical shock hazard protection of the power cables depends on the size of the selected power module (refer to the Configuration Manual, Drive Converters)
- 5) Motor with terminal boxes, power and signals cables, refer to Catalog, Chapter "Connection system MOTION-CONNECT"
- 6) 6FX8002 = MOTION-CONNECT 800;  
6FX5002 = MOTION-CONNECT 500;
- Technical data, refer to Catalog, Chapter "Connection system MOTION-CONNECT"
- 7) Cables can be supplied in integer lengths of precisely 1 meter;  
Length code, refer to the Configuration Manual "General Part for Synchronous Motors"



## Technical data 1FT6, rated speed 2500 RPM

$n_N$ [RPM]	$M_0$ [Nm]	$M_N$ [Nm]	$M_N^{1)}$ [Nm]	Motor type 1FT6-	$I_0$ [A]	$I_N$ [A]	Connector size <sup>2)</sup>	Cross-section <sup>3)</sup> [mm <sup>2</sup> ]	Cable type <sup>4) 5)</sup> 6FX□002- <sup>6)</sup>	Terminal box <sup>2)</sup>
Forced ventilation										
2500	425	340	306	163-8SD 7□ <sup>8)</sup>	226	185	—	—	—	gk630
Water cooling										
2500	155	148	148	132-6WD7 □ <sup>8)</sup>	92	82	—	—	—	gk630
2500	200	185	185	134-6WD7 □ <sup>8)</sup>	122	115	—	—	—	gk630
2500	240	220	220	136-6WD7 □ <sup>8)</sup>	158	149	—	—	—	gk630
2500	300	275	275	138-6WD7 □ <sup>8)</sup>	167	162	—	—	—	gk630
2500	425	340	340	163-8WD7 □ <sup>8)</sup>	240	240	—	—	—	gk630

Pole number

Cables are not included in the scope of supply of the motors - they must be separately ordered.

- 1) With absolute value encoder (due to the max. temperature of the encoder)
- 2) Power connector and terminal box mutually exclude one another
- 3) Motor with terminal boxes, max. cross-section that can be connected, refer to the Table "Connections for terminal boxes"
- 4) The electrical shock hazard protection of the power cables depends on the size of the selected power module (refer to the Configuration Manual, Drive Converters)
- 5) Motor with terminal boxes, power and signals cables, refer to Catalog, Chapter "Connection system MOTION-CONNECT"
- 6) 6FX8002 = MOTION-CONNECT 800;  
6FX5002 = MOTION-CONNECT 500;  
Technical data, refer to Catalog, Chapter "Connection system MOTION-CONNECT"
- 7) Cables can be supplied in integer lengths of precisely 1 meter;  
Length code, refer to the Configuration Manual "General Part for Synchronous Motors"
- 8) For 1FT613□ motors, the maximum current and the rated current of the converter must be carefully observed.  
1FT616□ motors can only be operated with SIMOVERT MASTERDRIVES MC drive converters.

## Motor Description

### 1.5 Technical data

#### Technical data 1FT6, rated speed 3000 RPM

$n_N$ [RPM]	$M_0$ [Nm]	$M_N$ [Nm]	$M_N^{1)}$ [Nm]	Motor type 1FT6-	$I_0$ [A]	$I_N$ [A]	Connector size 2)	Cross-section 3) [mm <sup>2</sup> ]	Cable type 4) 5) 6FX□002- 6)	Terminal box 2)
Non-ventilated										
3000	2.6	2.15	2.0	041-4AF7□	1.9	1.7	1	4 x 1.5	5□S01-1 □□□	—
3000	5.0	4.3	4.1	044-□AF7□	3.0	2.9	1	4 x 1.5	5□S01-1 □□□	—
3000	4.0	3.5	3.3	061-6AF7□	2.7	2.6	1	4 x 1.5	5□S01-1 □□□	—
3000	6.0	4.7	4.5	062-□AF7□	4.1	3.4	1	4 x 1.5	5□S01-1 □□□	—
3000	9.5	7.0	6.7	064-□AF7□	6.1	4.9	1	4 x 1.5	5□S01-1 □□□	—
3000	8.0	6.9	6.6	081-8AF7□	5.8	5.6	1.5	4 x 1.5	5□S21-1 □□□	—
3000	13.0	10.3	9.8	082-□AF7□	9.6	8.7	1.5	4 x 1.5	5□S21-1 □□□	—
3000	20.0	14.7	14.0	084-□AF7□	13.2	11	1.5	4 x 1.5	5□S21-1 □□□	—
3000	27.0	18.5	17.6	086-□AF7□	16.4	13	1.5	4 x 2.5	5□S31-1 □□□	—
3000	27.0	19.5	18.5	102-8AF7□	16.9	13.2	1.5	4 x 2.5	5□S31-1 □□□	gk130
3000	50.0	31.0	29.0	105-8AF7□	32.0	22.5	1.5	4 x 6	5□S51-1 □□□	gk130
3000	70.0	37.0	33.3	108-8AF7□	41.0	25	3	4 x 10	5□S13-1 □□□	gk230
3000	75.0	36.0	34.2	132-6AF7□	43.0	23	3	4 x 10	5□S13-1 □□□	gk230
Forced ventilation										
3000	26.0	22.0	21.0	084-8SF7□	18.2	17	1.5	4 x 2.5	5□S31-1 □□□	—
3000	35.0	31.0	29.0	086-8SF7□	25.0	24.5	1.5	4 x 4	5□S41-1 □□□	—
3000	65.0	50.0	48.0	105-8SF7□	42.0	35	3	4 x 10	5□S13-1 □□□	gk230
3000	90.0	70.0	63.0	108-8SF7□	62.0	53	3	4 x 16	5□S23-1 □□□	gk420
3000	110.0	90.0	81.0	132-6SF7□	69.0	62	3	4 x 25	5DS33-1 □□□	gk420
3000	140.0	110.0	99.0	134-6SF7□	83.0	72	3	4 x 25	5DS33-1 □□□	gk420
3000	175.0	145.0	130.5	136-6SF7□	110.0	104	—	—	—	gk420
Water cooling										
3000	10.2	10.1	10.1	062-6WF7□	6.9	6.9	1	4 x 1.5	5□S01-1 □□□	—
3000	16.2	16.1	16.1	064-6WF7□	10.3	10.3	1	4 x 1.5	5□S01-1 □□□	—
3000	35.0	35.0	35.0	084-8WF7□	24.5	27	1.5	4 x 4	5□S41-1 □□□	—
3000	47.0	46.0	46.0	086-8WF7□	34.0	37	1.5	4 x 10	5□S61-1 □□□	—
3000	85.0	78.0	78.0	105-8WF7□	83.0	82	3	4 x 25	5DS33-1 □□□	gk420
3000	119.0	109.0	109.0	108-8WF7□	86.0	81	3	4 x 35	5DS43-1 □□□	gk420

1 Core type  
4, 6, 8 Pole number

without brake cable:  
with brake cable:

with overall shield  
with overall shield

C  
D

Lengths <sup>7)</sup>  
(examples)

5 m A F  
10 m B A  
15 m B F  
18 m B J  
25 m C F

Cables are not included with the motors - they must be separately ordered. Footnotes, refer to the next page.

## Technical data 1FT6, rated speed 4500 RPM

$n_N$ [RPM]	$M_0$ [Nm]	$M_N$ [Nm]	$M_N^{1)}$ [Nm]	Motor type 1FT6-	$I_0$ [A]	$I_N$ [A]	Connector size 2)	Cross-section 3) [mm <sup>2</sup> ]	Cable type 4) 5) 6FX□002- 6)	Terminal box 2)
Non-ventilated										
4500	4.0	2.9	2.6	061-6AH7□	4.0	3.4	1	4 x 1.5	5□S01-1 □□□	—
4500	6.0	3.6	3.2	062-□SH7□	5.7	3.9	1	4 x 1.5	5□S01-1 □□□	—
4500	9.5	4.8	4.3	064-□SH7□	9.0	5.5	1	4 x 1.5	5□S01-1 □□□	—
4500	8.0	5.8	5.2	081-8AH7□	8.6	7.3	1.5	4 x 1.5	5□S21-1 □□□	—
4500	13.0	8.5	7.7	082-□SH7□	14.8	11	1.5	4 x 1.5	5□S21-1 □□□	—
4500	20.0	10.5	9.5	084-□SH7□	19.8	12.5	1.5	4 x 4	5□S41-1 □□□	—
4500	27.0	12.0	10.8	086-□SH7□	23.3	12.6	1.5	4 x 4	5□S41-1 □□□	—
4500	27.0	12.0	10.8	102-8AH7□	24.1	12	1.5	4 x 4	5□S41-1 □□□	gk130
Forced ventilation										
4500	26.0	20.0	18.0	084-8SH7□	26.0	24.5	1.5	4 x 4	5□S41-1 □□□	—
4500	35.0	27.0	24.3	086-8SH7□	38.0	32	3	4 x 10	5□S13-1 □□□	—
4500	65.0	40.0	36.0	105-8SH7□	59.0	41	3	4 x 16	5□S23-1 □□□	gk420
Water cooling										
4500	10.2	10.0	10.0	062-6WH7□	9.7	9.6	1	4 x 1.5	5□S01-1 □□□	—
4500	16.2	16.0	16.0	064-6WH7□	15.4	15.2	1	4 x 2.5	5□S11-1 □□□	—
4500	35.0	35.0	35.0	084-8WH7□	37.0	39	1.5	4 x 10	5□S61-1 □□□	—
4500	47.0	45.0	45.0	086-8WH7□	52.0	53	3	4 x 16	5□S23-1 □□□	—

1 Core type  
6, 8 Pole number

without brake cable: with overall shield  
with brake cable: with overall shield

C  
D

Lengths 7)  
(examples)

5 m A F  
10 m B A  
15 m B F  
18 m B J  
25 m C F

Cables are not included with the motors - they must be separately ordered.

- 1) With absolute value encoder (due to the max. temperature of the encoder)
- 2) Power connector and terminal box mutually exclude one another
- 3) Motor with terminal boxes, max. cross-section that can be connected, refer to the Table "Connections for terminal boxes"
- 4) The electrical shock hazard protection of the power cables depends on the size of the selected power module (refer to the Configuration Manual, Drive Converters)
- 5) Motor with terminal boxes, power and signals cables, refer to Catalog, Chapter "Connection system MOTION-CONNECT"
- 6) 6FX8002 = MOTION-CONNECT 800;  
6FX5002 = MOTION-CONNECT 500;  
Technical data, refer to Catalog, Chapter "Connection system MOTION-CONNECT"
- 7) Cables can be supplied in integer lengths of precisely 1 meter;  
Length code, refer to the Configuration Manual "General Part for Synchronous Motors"

Motor Description

1.5 Technical data

Technical data 1FT6, rated speed 6000 RPM

n <sub>N</sub> [RPM]	M <sub>0</sub> [Nm]	M <sub>N</sub> [Nm]	M <sub>N</sub> <sup>1)</sup> [Nm]	Motor type 1FT6-	I <sub>0</sub> [A]	I <sub>N</sub> [A]	Connector size 2)	Cross-section 3) [mm <sup>2</sup> ]	Cable type 4) 5) 6FX□002- 6)	Terminal box 2)
Non-ventilated										
6000	0.4	0.3	0.22	021-6AK71	1.25	1.1	1	4 x 1.5	5□S01-1 □□0	—
6000	0.8	0.5	0.37	024-6AK71	1.25	0.9	1	4 x 1.5	5□S01-1 □□0	—
6000	1.0	0.75	0.6	031-4AK71	1.4	1.2	1	4 x 1.5	5□S01-1 □□0	—
6000	2.0	1.4	1.2	034-□AK71	2.6	2.1	1	4 x 1.5	5□S01-1 □□0	—
6000	2.6	1.7	1.4	041-4AK71	3.0	2.4	1	4 x 1.5	5□S01-1 □□0	—
6000	5.0	3.0	2.6	044-4AK71	5.9	4.1	1	4 x 1.5	5□S01-1 □□0	—
6000	4.0	2.1	1.8	061-6AK7□	5.0	3.1	1	4 x 1.5	5□S01-1 □□0	—
6000	6.0	2.1	1.8	062-6AK7□	7.6	3.2	1	4 x 1.5	5□S01-1 □□0	—
6000	9.5	2.1	1.8	064-6AK7□	12.0	3.5	1	4 x 1.5	5□S01-1 □□0	—
6000	8.0	4.6	3.9	081-8AK7□	11.1	7.7	1.5	4 x 1.5	5□S21-1 □□0	—
6000	13.0	5.5	4.7	082-8AK7□	17.3	9.1	1.5	4 x 2.5	5□S31-1 □□0	—
6000	20.0	6.5	5.5	084-□AK7□	24.1	9.2	1.5	4 x 4	5□S41-1 □□0	—
Forced ventilation										
6000	26.0	17.0	14.5	084-8SK7□	35.0	25.5	1.5	4 x 10	5□S61-1 □□0	—
6000	35.0	22.0	18.7	086-8SK7□	44.0	29.0	3	4 x 10	5□S13-1 □□0	—
Water cooling										
6000	10.2	9.8	9.8	062-6WK7□	12.9	12.7	1	4 x 1.5	5□S01-1 □□0	—
6000	16.2	15.8	15.8	064-6WK7□	20.5	20	1	4 x 2.5	5□S11-1 □□0	—
6000	35.0	34.0	34.0	084-8WK7□	47.0	51	3	4 x 10	5□S13-1 □□0	—
6000	47.0	44.0	44.0	086-8WK7□	59.0	58	3	4 x 16	5□S23-1 □□0	—

1 Core type  
4, 8 Pole number

without brake cable:  
with brake cable:

with overall shield  
with overall shield

C  
D

Lengths <sup>7)</sup>  
(examples)

5 m A F  
10 m B A  
15 m B F  
18 m B J  
25 m C F

Cables are not included with the motors - they must be separately ordered.

- 1) With absolute value encoder (due to the max. temperature of the encoder)
- 2) Power connector and terminal box mutually exclude one another
- 3) Motor with terminal boxes, max. cross-section that can be connected, refer to the Table "Connections for terminal boxes"
- 4) The electrical shock hazard protection of the power cables depends on the size of the selected power module (refer to the Configuration Manual, Drive Converters)
- 5) Motor with terminal boxes, power and signals cables, refer to Catalog, Chapter "Connection system MOTION-CONNECT"
- 6) 6FX8002 = MOTION-CONNECT 800;  
6FX5002 = MOTION-CONNECT 500;  
Technical data, refer to Catalog, Chapter "Connection system MOTION-CONNECT"
- 7) Cables can be supplied in integer lengths of precisely 1 meter;  
Length code, refer to the Configuration Manual "General Part for Synchronous Motors"

## 1.6 Armature short-circuit braking

Definition as described in the Configuration Manual "General Section".

### Dimensioning the braking resistors for optimum short-circuit braking

The correct dimensioning ensures an optimum braking time. The braking torques which are obtained are also listed in the tables. Data apply for braking from the rated speed and moment of inertia  $J_{\text{external}} = J_{\text{mot}}$ . If the motor brakes from another speed, then the braking time **cannot** be linearly reduced. However, longer braking times cannot occur if the speed at the start of braking is less than the rated speed.

The data in the following table is calculated for rated values according to the data sheet. The variance during production as well as iron saturation have not been taken into account here. Higher currents and torques can occur than those calculated as a result of the saturation.

The ratings of the resistors must match the particular  $I^2t$  load capability, refer to the Configuration Manual "General Section for Synchronous Motors".

### Non-ventilated

Table 1-3 Resistor braking for the 1FT6 series, shaft heights 28 to 48, non-ventilated

Motor type	Braking resistor external $R_{\text{opt}} [\Omega]$	Average braking torque $M_{\text{br rms}} [\text{Nm}]$		Max. braking torque $M_{\text{br max}} [\text{Nm}]$	rms braking current $I_{\text{br rms}} [\text{A}]$	
		without external braking resistor	with external braking resistor		without external braking resistor	with external braking resistor
<b>SH 28, SH 36, SH 48, non-ventilated</b>						
1FT6021-6AK7□	–	1.1	–	1.6	6.8	–
1FT6024-6AK7□	–	2.7	–	3.7	8.3	–
1FT6031-4AK7□	4.4	2.1	2.3	2.8	6.9	6.4
1FT6034-4AK7□	3.7	3.6	4.4	5.5	13	12
1FT6041-4AF7□	0.31	6.7	6.8	8.4	10	10
1FT6041-4AK7□	2.6	5.8	6.8	8.4	18	17
1FT6044-4AF7□	2.0	13	14	17	18	17
1FT6044-4AK7□	1.8	10	14	17	37	33

Motor Description

1.6 Armature short-circuit braking

Table 1-4 Resistor braking for the 1FT6 series, shaft heights 63 to 80, non-ventilated

Motor type	Braking resistor external $R_{opt}$ [Ω]	Average braking torque $M_{br\ rms}$ [Nm]		Max. braking torque $M_{br\ max}$ [Nm]	rms braking current $I_{br\ rms}$ [A]	
		without external braking resistor	with external braking resistor		without external braking resistor	with external braking resistor
<b>SH 63 non-ventilated</b>						
1FT6061-6AC7□	9.2	3.2	3.6	4.5	4.0	3.7
1FT6061-6AF7□	9.4	2.7	3.6	4.5	5.7	5.2
1FT6061-6AH7□	7.3	2.2	3.6	4.5	8.7	7.8
1FT6061-6AK7□	7.1	1.8	3.6	4.5	10	9.3
1FT6062-6AC7□	7.7	4.7	5.7	7.0	5.9	5.4
1FT6062-6AF7□	6.4	4.0	5.7	7.0	9.0	8.1
1FT6062-6AH7□	5.5	3.2	5.7	7.0	13	11
1FT6062-6AK7□	4.4	2.6	5.7	7.0	17	15
1FT6064-6AC7□	5.9	6.8	9.1	11	9.3	8.5
1FT6064-6AF7□	5.0	5.5	9.1	11	14	12
1FT6064-6AH7□	3.6	4.4	9.1	11	20	18
1FT6064-6AK7□	2.9	3.6	9.1	11	27	24
<b>SH 80 non-ventilated</b>						
1FT6081-8AC7□	6.5	5.1	6.9	8.6	7.8	7.1
1FT6081-8AF7□	5.1	4.1	6.9	8.6	12	11
1FT6081-8AH7□	3.7	3.2	6.9	8.6	18	16
1FT6081-8AK7□	3.4	2.4	6.9	8.6	21	19
1FT6082-8AC7□	4.2	6.0	11	13	13	11
1FT6082-8AF7□	3.2	5.8	11	13	19	17
1FT6082-8AH7□	2.4	3.9	11	13	27	24
1FT6082-8AK7□	2.2	3.8	11	13	35	31
1FT6084-8AC7□	3.5	11	18	22	19	17
1FT6084-8AF7□	2.6	8.2	18	22	28	25
1FT6084-8AH7□	1.7	6.8	18	22	44	39
1FT6084-8AK7□	1.7	4.7	18	22	49	44
1FT6086-8AC7□	2.7	15	27	34	26	23
1FT6086-8AF7□	2.1	12	27	34	38	34
1FT6086-8AH7□	1.6	10	27	34	57	51

Table 1-5 Resistor braking for the 1FT6 series, shaft heights 100 to 132, non-ventilated

Motor type	Braking re-sistor external $R_{opt}$ [ $\Omega$ ]	Average braking torque $M_{br\ rms}$ [Nm]		Max. braking torque $M_{br\ max}$ [Nm]	rms braking current $I_{br\ rms}$ [A]		
		without external braking resistor	with external braking resistor		without external braking resistor	with external braking resistor	
<b>SH 100 non-ventilated</b>							
1FT6102-8AB7□	3.9	13	24	30	18	16	
1FT6102-8AC7□	2.8	11	24	30	25	23	
1FT6102-8AF7□	2.3	8.1	24	30	35	31	
1FT6102-8AH7□	1.7	6.5	24	30	51	46	
1FT6105-8AB7□	2.2	21	43	54	33	29	
1FT6105-8AC7□	1.7	17	43	54	44	39	
1FT6105-8AF7□	1.2	13	43	54	65	58	
1FT6108-8AB7□	1.4	32	71	88	53	47	
1FT6108-8AC7□	1.2	26	71	88	68	61	
1FT6108-8AF7□	0.9	21	71	88	99	89	
<b>SH 132 non-ventilated</b>							
1FT6132-6AB7□	1.0 <sup>1)</sup>	37	83	105	56	50	
1FT6132-6AC7□	1.2 <sup>1)</sup>	32	83	105	75	67	
1FT6132-6AF7□	0.8 <sup>1)</sup>	23	83	105	110	100	
1FT6134-6AB7□	1.2 <sup>1)</sup>	47	110	140	72	65	
1FT6134-6AC7□	0.9 <sup>1)</sup>	40	110	140	99	89	
1FT6136-6AB7□	0.9 <sup>1)</sup>	55	130	170	91	82	
1FT6136-6AC7□	0.8 <sup>1)</sup>	45	130	170	115	105	

<sup>1)</sup> When utilized to  $M_0$  (100 K), a braking resistor must be used in order to prevent partial demagnetization.

When utilized to  $M_0$  (60 K), the additional braking resistor is not required.



1.6 Armature short-circuit braking

Forced cooling

Table 1-6 Resistor braking for the 1FT6 series, force-ventilated

Motor type	Braking resistor external $R_{opt}$ [ $\Omega$ ]	Average braking torque $M_{br\ rms}$ [Nm]		Max. braking torque $M_{br\ max}$ [Nm]	rms braking current $I_{br\ rms}$ [A]		
		without external braking resistor	with external braking resistor		without external braking resistor	with external braking resistor	
<b>SH 80, force ventilated</b>							
1FT6084-8SF7□	2.3	8.1	18	22	29	26	
1FT6084-8SH7□	1.7	6.8	18	22	44	39	
1FT6084-8SK7□	1.4	4.7	18	22	54	48	
1FT6086-8SF7□	1.6	11	27	34	42	38	
1FT6086-8SH7□	1.1	7.5	27	34	61	55	
1FT6086-8SK7□	1.1	6.6	27	34	74	66	
<b>SH 100, force ventilated</b>							
1FT6105-8SB7□	2.0	21	44	55	35	31	
1FT6105-8SC7□	1.5	17	44	55	47	42	
1FT6105-8SF7□	1.2	13	44	55	65	58	
1FT6105-8SH7□	0.9	10	44	55	96	86	
1FT6108-8SB7□	1.2	33	71	88	58	52	
1FT6108-8SC7□	0.9	27	71	88	77	69	
1FT6108-8SF7□	0.6	20	71	88	115	103	
<b>SH 132, force ventilated</b>							
1FT6132-6SB7□	1.2	36 <sup>1)</sup>	83	105	63	57	
1FT6132-6SC7□	1.0	30 <sup>1)</sup>	83	105	83	74	
1FT6132-6SF7□	0.7	23 <sup>1)</sup>	83	105	120	110	
1FT6134-6SB7□	0.9	49 <sup>1)</sup>	110	140	81	73	
1FT6134-6SC7□	0.8	40 <sup>1)</sup>	110	140	105	95	
1FT6134-6SF7□	0.6	30 <sup>1)</sup>	110	140	150	140	
1FT6136-6SB7□	0.8	54 <sup>1)</sup>	130	170	99	88	
1FT6136-6SC7□	0.6	43 <sup>1)</sup>	130	170	130	120	
1FT6136-6SF7□	0.5	33 <sup>1)</sup>	130	170	190	170	
<b>SH 160, force ventilated</b>							
1FT6163-8SB7□	0.3 <sup>2)</sup>	–	380	490	–	270	
1FT6163-8SD7□	0.25 <sup>2)</sup>	–	380	490	–	390	
1FT6168-8SB7□	0.27 <sup>2)</sup>	–	530	680	–	340	

1) When utilized acc. to  $M_0$  (100 K) a series braking resistor must be used in order to prevent partial de-magnetization. When utilized according to  $M_0$  (60 K), the additional braking resistor is not required.

2) In order to prevent that the motors are de-magnetized, when short-circuit braking from the rated speed, the above specified supplementary resistors must be connected in series.



## Water-cooling

Table 1-7 Resistor braking for the 1FT6 series, water cooling

Motor type	Braking resistor external $R_{opt}$ [ $\Omega$ ]	Average braking torque $M_{br\ rms}$ [Nm]		Max. braking torque $M_{br\ max}$ [Nm]	rms braking current $I_{br\ rms}$ [A]		
		without external braking resistor	with external braking resistor		without external braking resistor	Max. Braking torque $M_{br\ max}$ [Nm]	
<b>SH 60, water cooling</b>							
1FT6062-6WF7□	6.4	4.0	5.7	7.0	9	8.1	
1FT6062-6WH7□	5.5	3.2	5.7	7.0	13	11	
1FT6062-6WK7□	4.4	2.6	5.7	7.0	17	15	
1FT6064-6WF7□	5.0	5.5	9.1	11	14	12	
1FT6064-6WH7□	3.6	4.4	9.1	11	20	18	
1FT6064-6WK7□	2.9	3.6	9.1	11	27	24	
<b>SH 80, water cooling</b>							
1FT6084-8WF7□	2.3	8.1	18	22	29	26	
1FT6084-8WH7□	1.6	6.5	18	22	44	40	
1FT6084-8WK7□	1.4	4.7	18	22	54	48	
1FT6086-8WF7□	1.6	11	27	34	42	38	
1FT6086-8WH7□	1.1	7.5	27	34	61	55	
1FT6086-8WK7□	1.1	6.6	27	34	74	66	
<b>SH 100, water cooling</b>							
1FT6105- □WC7□	0.8	17	44	55	65	58	
1FT6105- □WF7□	0.6	14	44	55	96	86	
1FT6108- □WB7□	1.2	33	71	88	58	52	
1FT6108- □WC7□	0.9	27	71	88	77	69	
1FT6108- □WF7□	0.6	21	71	88	115	103	
<b>SH 132, water cooling</b>							
1FT6132-6WB7□	0.9	40 <sup>1)</sup>	85	105	72	65	
1FT6132-6WD7□	0.7	27 <sup>1)</sup>	85	105	115	100	
1FT6134-6WB7□	0.7	47 <sup>1)</sup>	110	140	92	82	
1FT6134-6WD7□	0.5	33 <sup>1)</sup>	110	140	150	140	
1FT6136-6WB7□	0.6	56 <sup>1)</sup>	130	170	115	100	
1FT6136-6WD7□	0.35	40 <sup>1)</sup>	130	170	200	180	
1FT6138-6WB7□	0.42	69 <sup>1)</sup>	170	220	150	140	
1FT6138-6WD7□	0.32	50 <sup>1)</sup>	170	220	240	210	
<b>SH 160, water cooling</b>							
1FT6163-8WB7□	0.3 <sup>2)</sup>	–	380	490	–	270	
1FT6163-8WD7□	0.25 <sup>2)</sup>	–	380	490	–	390	
1FT6168-8WB7□	0.27 <sup>2)</sup>	–	530	680	–	340	

**1.6 Armature short-circuit braking**

- 1) When utilized acc. to  $M_0$  (100 K) a series braking resistor must be used in order to prevent partial de-magnetization. When utilized according to  $M_0$  (60 K), the additional braking resistor is not required.
- 2) It is absolutely prohibited to short-circuit the winding when using smaller supplementary resistors than those specified. When braking from the rated speed, the resistors listed prevent partial de-magnetization of the rotor.

## 1.7 Cooling

### 1.7.1 Cooling types

The different cooling types are defined in the Configuration Manual "General Section for Synchronous Motors"..

### 1.7.2 Forced ventilation

Degree of protection IP54 (acc. to EN 60529).

Degrees of protection IP64, IP65, IP67 and IP68 are not possible

The hot discharged air may not be drawn-in again.



#### Caution

Forced ventilation cannot be used in the presence of flammable, corrosive, electrically conductive or explosive dust.

### Forced ventilation, SH 80 and SH 100

Air flow direction from NDE to DE.

If the air flow direction is reversed, this reduces the torque yield by approx. 20 %.

Mechanical changes to the motor with respect to non-ventilated versions:

- The power connector is about 12 mm higher.
- A sheet metal envelope is located over the motor frame from the non-drive end side. The axial fan is mounted in this sheet metal envelope. There is a cut-out in the sheet metal envelope at the connector positions. This means that the motor is only partially cooled by the air flow (three-sided ventilation).
- The motor dimensions can be taken from the dimension drawings.

Connection:	Connector, Size 1, Order No.: 6FX2003-0CA10
Supply voltage:	1-ph. 230/260 V AC, 50/60 Hz
Maximum current:	0.3 A

Connector assignment for fan connections  
SH 80 and SH 100:

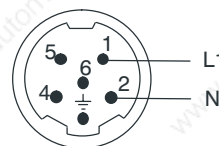

1.7 Cooling

**Forced ventilation, SH 132**

Air flow direction from DE to NDE

The air is blown through the enclosure corners of the extruded profile using a mounted radial fan.

Connection: via terminal box  
Supply voltage: 3-ph. 400/480 V AC, 50/60 Hz  
Maximum current: 0.4 A

**Forced ventilation, SH 160**

Air flow direction from DE to NDE

The air is blow through the enclosure corners of the extruded profile using a mounted radial fan.

Connection: via terminal box  
Supply voltage: 3-ph. 400/480 V AC, 50/60 Hz  
Maximum current: 0.8 A

**Minimum clearance between parts and components mounted by the customer and the air discharge opening**

The following minimum clearance must be maintained between parts and components mounted by the customer and the air discharge opening:

Table 1-8 Minimum clearance to parts and components mounted by the customer

Shaft height [mm]	Minimum clearance [mm]
80	20
100	30
132	60
160	80

### 1.7.3 Water-cooling

The power loss generated by the motor is dissipated using a water cooling system. The machinery construction company must connect-up a cooling system (e.g. heat exchanger).

The rated motor torques, specified in the motor data sheets apply for water-cooled operation and a water intake temperature of < 30 °C.

---

#### Notice

If the motor is operated without water cooling, then the rated motor torque is reduced as a function of the heat losses which can be dissipated by convection and radiation. In this case, the data for non-ventilated operation apply.

---



---

#### Note

It is not possible to retrofit a motor for water cooling.

---

The cooling medium must be pre-cleaned and filtered in order to prevent the cooling circuit from becoming blocked. The maximum permissible particle size after filtering is 100 µm.

### Cooling circuit

---

#### Notice

If current is flowing through the motor, then the cooling circuit must be activated.

---

Table 1-9 Technical data for the cooling circuit

Motor type	Water flow rate [l]	Max. permissible pressure [bar]	Flow rate [l/min]
1FT6062	0.2	2.5	5
1FT6064	0.26	2.5	5
1FT6082	0.4	2.5	5
1FT6084	0.5	2.5	5
1FT6086	0.6	2.5	5
1FT6105	1.1	2.5	5
1FT6108	1.5	2.5	5
1FT6132	2.1	6.0	8
1FT6134	2.4	6.0	8
1FT6136	2.7	6.0	8
1FT6138	3.1	6.0	8
1FT6163	4.7	6.0	10
1FT6168	5.7	6.0	10

Pressure drop, intake/return: < 0.1 bar

**Materials used in the cooling circuits**

The anti-corrosion additives used should be harmonized with the cooling system manufacturer - i.e. the materials of the motor cooler and the materials of the fittings and cooling medium hoses listed in the Table.

Table 1-10 Materials used in the motor cooling circuit

Motor type	Bearing end shield	Enclosure	Sealing agent	Connecting plate
1FT606□ 1FT608□ 1FT610□	Aluminum	Aluminum	Terostat	Stainless steel
1FT613□ 1FT616□	Gray cast iron	Aluminum	Terostat	—

**Cooling medium and anti-corrosion protection**

**Notice**

It is not permissible that ice forms in the cooling circuit, neither in operation nor during storage.

The checking and change intervals for the cooling medium should be harmonized with the companies supplying the anti-corrosion agent and the cooling system.

We recommend that an anti-corrosion agent is added to water as cooling-medium (e.g. Antifrogen N from the Hoechst Company or Tyfocor from Tyforop Chemie GmbH, refer to the Table below).

Observe the specifications of the anti-corrosion agent manufacturer regarding the ratio of water to anti-corrosion agent.

For Tyfocor, the ratio of 75 % water and 25 % anti-corrosion agent should not be exceeded.

When using another cooling medium (e.g. oil, cooling-lubricating medium) de-rating may be required in order that the thermal motor limit is not exceeded. The de-rating can be determined using the following data:

- Specific density:  $\rho$  [kg/m<sup>3</sup>]
- Specific thermal capacitance:  $c_p$  [J/(kg K)]
- Intake temperature:  $t_v$  [°C]
- Flow quantity:  $v$  [l/min]

The enquiry must be sent to the manufacturer's plant (Hotline).

The motor power still does not have to be reduced for oil-water mixtures with less than 10 %.

**Note**

Different anti-corrosion agents should not be mixed.

Table 1-11 Manufacturers of chemical additives

Company	Address	Telephone/URL
Tyforop Chemie GmbH	Hellbrookstr. 5a, D-22305 Hamburg	URL: www.tyfo.de
Joh.A. Beckiser Wassertechnik GmbH	Bergstr. 17 D-40699 Erkrath	Phone: 02104 / 40075
CINCINNATI CIMCOOL Cincinnati Milacron b. v./ Cimcool Division	Postfach 98 NL-3031 AB Vlaardingen	Phone: 003110 / 4600660
Fuchs Petrolub AG	Friesenheimer Strasse 17 D-68169 Mannheim	Phone: 0621 / 3802-0 URL: www.fuchs-oil.com
Hebro Chemie GmbH	Rostocker Straße D-41199 Mönchengladbach	Phone: 02166 / 6009-0 URL: www.hebro-chemie.de
Fa. Hoechst	Refer to the Internet address	URL: www.hoechst.com
Houghton Lubricor GmbH	Werkstrasse 26 D-52076 Aachen	Phone: 02408 / 14060
Schilling-Chemie GmbH u. Produktions KG	Steinbeißstr. 20 D-71691 Freiberg	Phone: 07141 / 7030

**Note**

These recommendations involve third-party products which we know to be basically suitable. It goes without saying that similar products from other manufacturers can also be used. Our recommendations should be considered as such. We cannot accept any liability for the quality and properties/features of third-party products.

**Cooling-medium intake temperature**

The intake temperatures should be selected so that no moisture condensation forms on the surface of the motor:  $T_{cool} \leq T_{ambient} - 2^{\circ} C$

The motors are designed for operation up to a cooling medium temperature of +30°C, but still maintaining all of the specified motor data. The continuous torque changes for other intake temperatures.

**Cooling powers to be dissipated**

The values specified in Table refer to a cooling-medium temperature of 30 °C and maximum speed in S1 duty.

Table 1-12 Cooling powers to be dissipated

Motor type	Cooling powers to be dissipated [W]
1FT6062-6WF7□	600
1FT6062-6WH7□	650
1FT6062-6WK7□	700
1FT6064-6WF7□	800
1FT6064-6WH7□	850
1FT6064-6WK7□	900
1FT6084-8WF7□	1500
1FT6084-8WH7□	1900
1FT6084-8WK7□	2200
1FT6086-8WF7□	1800
1FT6086-8WH7□	2000
1FT6086-8WK7□	2400
1FT6105-8WC7□	2000
1FT6105-8WF7□	2100
1FT6108-8WB7□	1900
1FT6108-8WC7□	2100
1FT6108-8WF7□	2100
1FT6132-6WB7□	2600
1FT6132-6WD7□	2700
1FT6134-6WB7□	2700
1FT6134-6WD7□	3100
1FT6136-6WB7□	3300
1FT6136-6WD7□	3600
1FT6138-6WB7□	3600
1FT6138-6WD7□	4000
1FT6163-8WB7□	4500
1FT6163-8WD7□	6000
1FT6168-8WB7□	7500



## **Cooling system**

A cooling system (i.e. heat exchanger) must be used in order to guarantee a cooling medium intake temperature of +30°C. It is possible to operate several motors from a single cooling system. The cooling system is not included in the scope of supply.

Cooling system manufacturer, refer to the Catalog.

The cooling power is calculated from the sum of the power losses of the connected motors. The power of the pump and the distribution to different cooling circuits should be engineered corresponding to the specified flow and the pressure losses of the individual cooling circuits.

If one pump is used with distribution to several cooling circuits, then it may be necessary to use a flow controller.

## 1.8 Coupling output

The KTR company offers the pinion wheels of its Rotex GS couplings with various shore hardnesses. The values specified in Table correspond to pinion wheels recommended by KTR with a Shore hardness of 98 or 95 Sh A GS.

They must be optimally harmonized with the mounted mechanical system. A coupling pre-selection is provided in Table . Please contact the coupling manufacturer for detailed design information. Ordering address, refer to the Configuration Manual "General Section" or Internet [www.ktr.com](http://www.ktr.com).

Table 1-13 Assignment of the coupling outputs to the motors

Shaft height of the 1FT6 motor	d <sub>w</sub> [mm] <sup>1)</sup>	Rotex GS Size	98 Sh A GS		TR [Nm] <sup>4)</sup>
			TKN [Nm] <sup>2)</sup>	TKmax [Nm] <sup>3)</sup>	
1FT602	9	9	5	10	2.6
1FT603	14	14	12.5	25	8.1
1FT6041	19	19	17	34	32
1FT6044	19	24	60	120	39
1FT606x-6A	24	24	60	120	43
1FT6062-6W	24	24	60	120	43
1FT6064-6W	24	28	60	120	91
1FT608x-8A	32	28	160	320	102
1FT608x-8S	32	28	160	320	102
1FT6084-8W	32	28	160	320	102
1FT6086-8W	32	38	325	650	113
1FT6102..5	38	38	325	650	122
1FT6108	38	42	450	900	—
1FT613x-6A	48	42	450	900	—
1FT613x-6S	48	42	450	900	—
1FT6132..4-6W	48	48	525	1050	—
1FT6136..8-6W	48	55	685	1370	—
1FT6163	55	65	940 <sup>5)</sup>	1880 <sup>5)</sup>	—
1FT6168	55	75	1920 <sup>5)</sup>	3840 <sup>5)</sup>	—

<sup>1)</sup> d<sub>w</sub> = diameter, motor shaft end

<sup>2)</sup> T<sub>KN</sub> = rated coupling torque

<sup>3)</sup> T<sub>Kmax</sub> = maximum coupling torque

<sup>4)</sup> T<sub>R</sub> = friction-locked torque (torque that can be transmitted with a clamping hub at d<sub>w</sub>)

<sup>5)</sup> values for 95 Sh A GS



### Warning

The accelerating torque may not exceed the friction-locked torque of the coupling!

### Notice

We cannot accept any liability for the quality and properties/features of third-party products.

## Electrical Connections

### 2.1 Connection overview

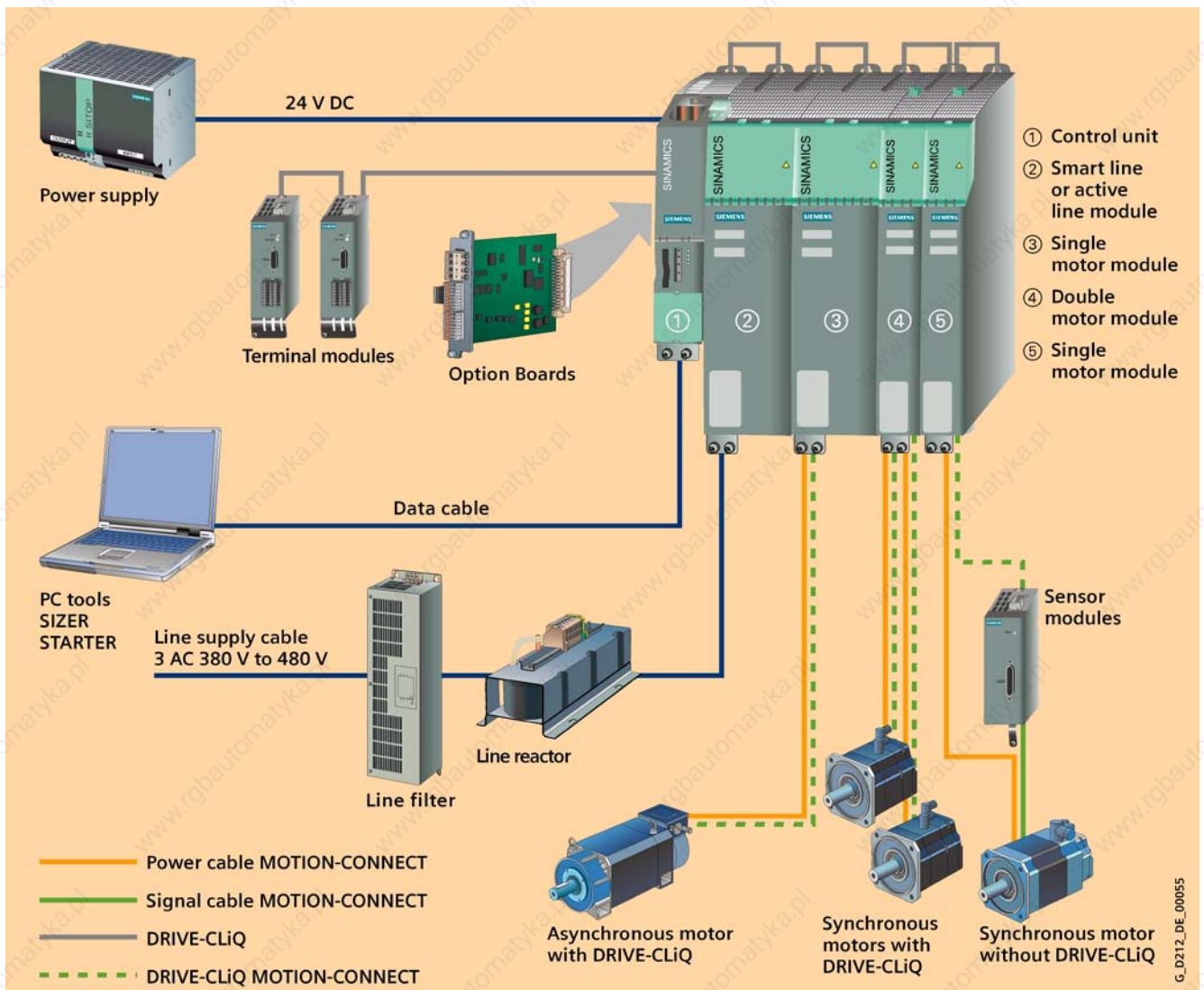

Figure 2-1 Connection overview SINAMICS S120

## 2.2 Power connection

### 2.2.1 Possible connections



#### Warning

The motors are not designed to be connected directly to the line supply.

#### Connection via power connector or terminal box

Certain motor types can either be connected via power connectors or via terminal boxes.

Several motors types can only be connected through a power connector.

### 2.2.2 Connector connection

#### Connection assignment, power connector at the motor

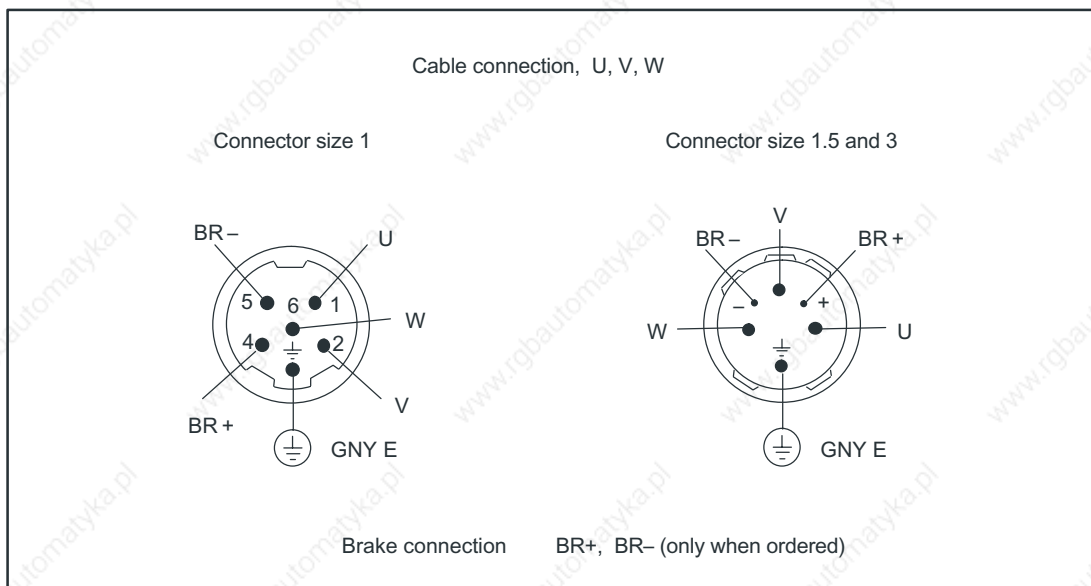

Figure 2-2 Power connection

### 2.2.3 Connection through a terminal box

- The terminal assignment in the terminal box must be implemented according to the diagram.
- The protective conductor must be connected.
- Cable lugs acc. to DIN 46234 must be used.
- Connect-up an optional brake (refer to the diagram).

#### Notice

Motors with a rated power of more than 100 kW must be grounded using the additional M12 grounding stud provided at the NDE bearing endshield.

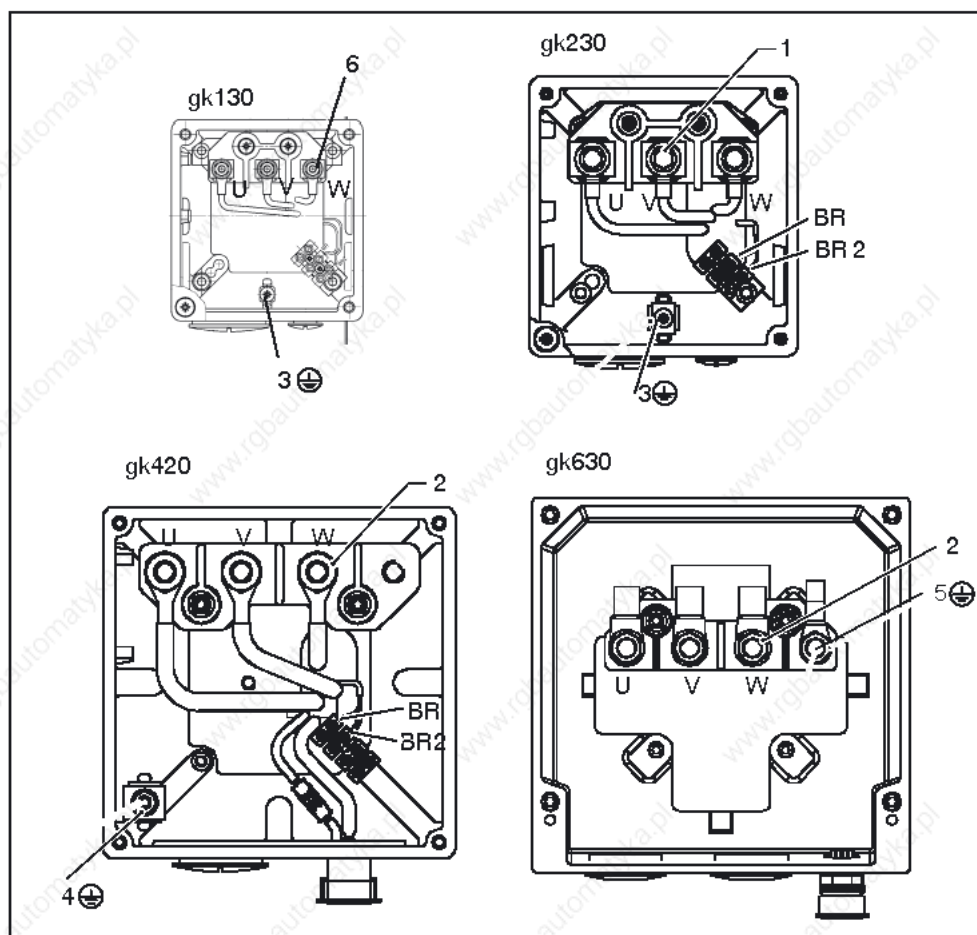

Figure 2-3 Terminal assignment in the terminal boxes

2.2 Power connection

Table 2-1 Description of the diagram

No.	Description	No.	Description
1	M5 connecting studs	5	M10 grounding studs
2	M10 connecting studs	6	M4 connecting studs
3	M4 grounding stud	BR	Brake connection
4	M6 grounding stud		

Table 2-2 Connections for the terminal box

Terminal box type	Cable gland	Max. outer cable diameter <sup>3)</sup> [mm]	Max. current [A] <sup>1)</sup>	Power connection	Max. cross-section per phase	Ground connection	Brake connection <sup>2)</sup>
gk130	1 x Pg29	30	36	3 x M4	1 x 6 mm <sup>2</sup>	M4	1.5 mm <sup>2</sup>
gk230	1 x Pg29	30	66	3 x M5	1 x 16 mm <sup>2</sup>	M4	1.5 mm <sup>2</sup>
gk420	1 x Pg36	37	104	4 x M10	1 x 35 mm <sup>2</sup>	M6	1.5 mm <sup>2</sup>
gk630	2 x M32 x 1.5	25	112	3 x M10	2 x 16 mm <sup>2</sup>	M10	—
gk630	2 x M40 x 1.5	32	176	3 x M10	2 x 35 mm <sup>2</sup>	M10	—
gk630	2 x M50 x 1.5	41	209	3 x M10	2 x 50 mm <sup>2</sup>	M10	—

1) Data acc. to DIN EN 60204-1 (routing type C, ambient temperature 40° C)

2) BR/BR2 (terminal strip, only for versions with brake)

3) Dependent on the seal used

## 2.3 DRIVE-CLiQ

The encoder system can only be connected to SINAMICS S120 via DRIVE-CLiQ.

The DRIVE-CLiQ interface is either established through the sensor module at the motor (motors with DRIVE-CLiQ) or in the cabinet using sensor module, cabinet-mounted (for motors without DRIVE-CLiQ).

## 2.4 Motors with DRIVE-CLiQ

Motors with DRIVE-CLiQ have a sensor module that includes the encoder evaluation, the motor temperature sensing as well as an electronic rating plate with a unique identification number and motor and encoder-specific data.

These motors with DRIVE-CLiQ can be connected to the corresponding motor module directly via the MOTION-CONNECT DRIVE-CLiQ cables supplied. This means that data is directly transferred to the control unit.

These motors make start-up and diagnostics much easier, as the motor and encoder type can be identified automatically.

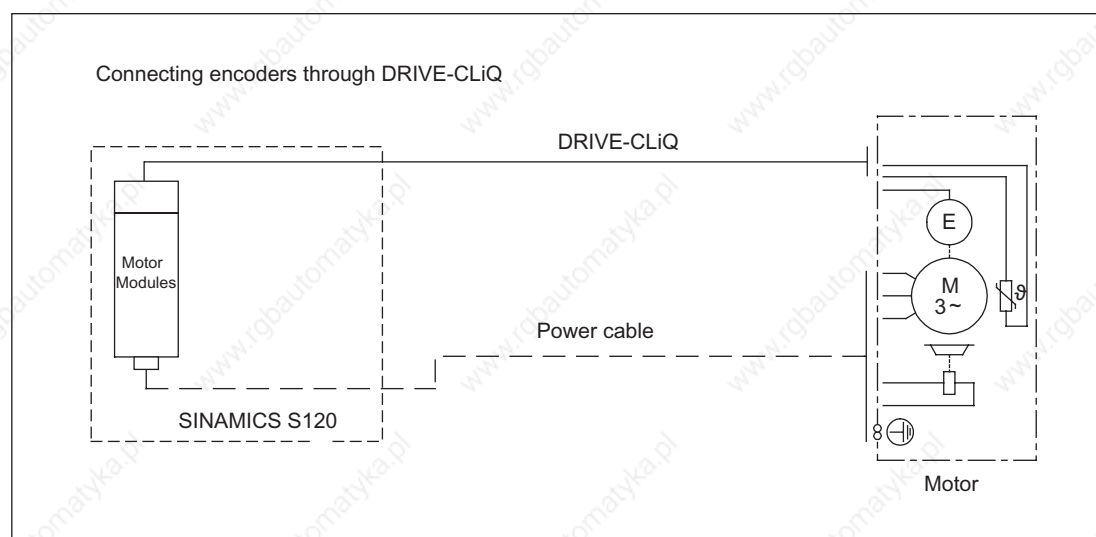

Figure 2-4 Connecting encoders for motors with DRIVE-CLiQ



## 2.5 Motors without DRIVE-CLiQ

When fed from SINAMICS S120, motors without DRIVE-CLiQ require a sensor module, cabinet-mounted. The sensor modules evaluate the signals from the connected motor sensors or external sensors and convert them to DRIVE-CLiQ. In conjunction with motor encoders, the motor temperature can also be evaluated using sensor modules. Additional information is provided in the SINAMICS Equipment Manual.

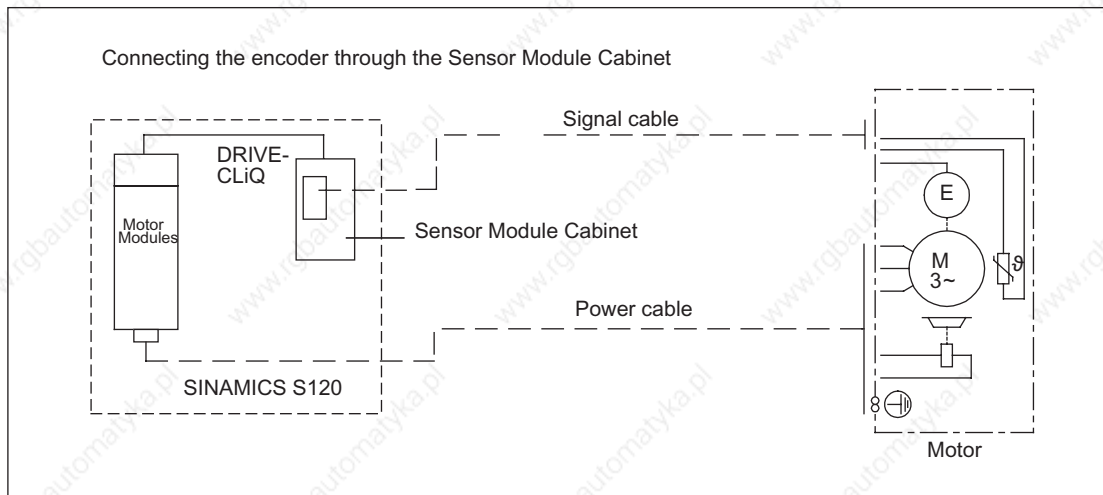

Figure 2-5 Connecting encoders without DRIVE-CLiQ



## 2.6 Rotating the connector at the motor

### Rotating the connector at the motor

The DRIVE-CLiQ interface can be rotated but the amount of rotation is limited.

#### Notice

The permissible range of rotation may not be exceeded.

Do not exceed max. turning torques of 8 Nm.

In order to guarantee the degree of protection, the connector may only be rotated a max. of 10x up to its end stop.

The connector should be rotated using a mating connector attached at the connector thread.

Connecting cables must be secured against tensile stress and bending.

The motors connectors must be secured so that they cannot be rotated any further.

It is not permissible to subject connectors to a continuous force.

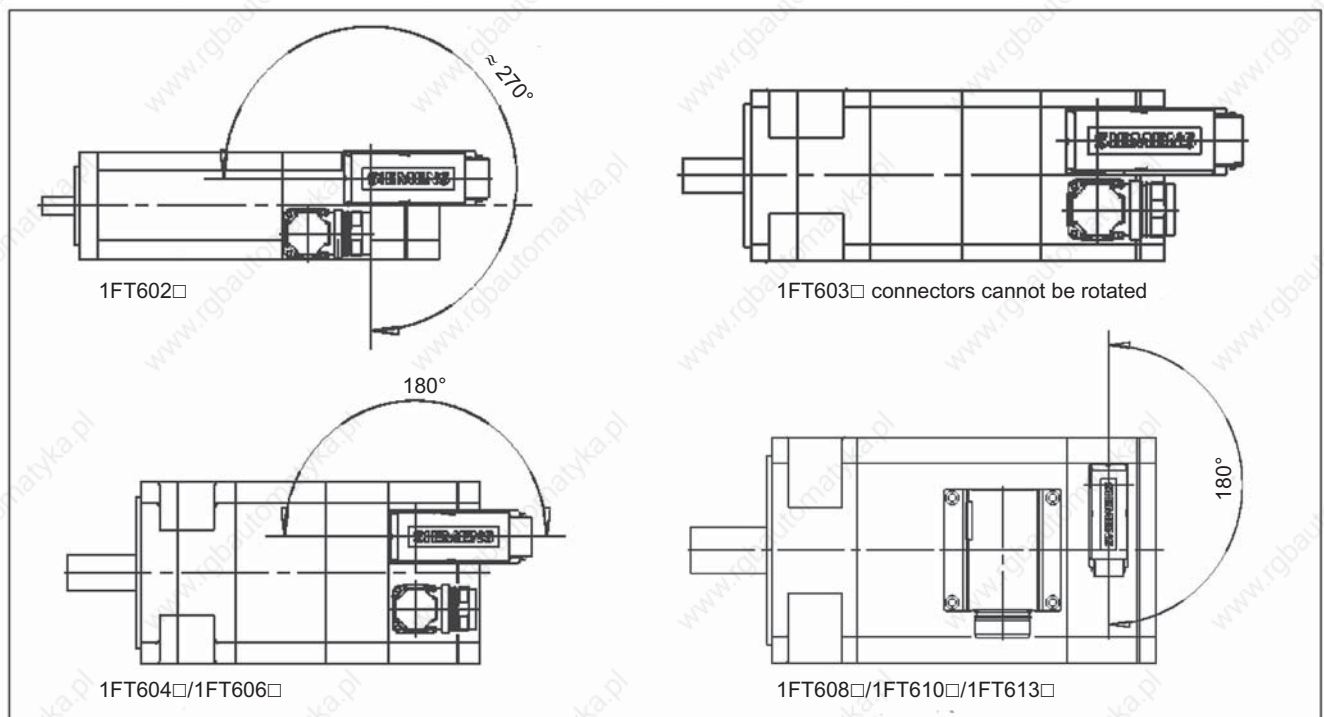

Figure 2-6 Connectors can be rotated

*2.6 Rotating the connector at the motor*

## Technical Data and Speed-Torque Diagrams

### 3.1 Speed-torque diagrams

#### 3.1.1 Introduction

---

**Note**

Refer to the Configuration Manual "General Section for Synchronous Motors" for a description of how the voltage limiting characteristics are shifted.

The specified thermal S3 limit characteristics are referred to  $\Delta T = 100$  K for  
1 min cycle duration for SH 28  
10 min cycle duration for SH 36, 48, 63, 80, 100, 132, 160

---

3.1 Speed-torque diagrams

3.1.2 1FT6 series, non-ventilated

Table 3-1 1FT6021 non-ventilated

1FT6021				
Technical data	Code	Units	-6AK71	
Engineering data				
Rated speed	$n_N$	RPM	6000	
No. of poles	2p		6	
Rated torque (100K)	$M_{N(100K)}$	Nm	0.3	
Rated current (100K)	$I_{N(100K)}$	A	1.1	
Stall torque (60K)	$M_0(60K)$	Nm	0.33	
Stall torque (100K)	$M_0(100K)$	Nm	0.40	
Stall current (60K)	$I_0(60K)$	A	1.0	
Stall current (100K)	$I_0(100K)$	A	1.25	
Moment of inertia (with brake)	$J_{mot}$	$10^{-4}$ kgm <sup>2</sup>	0.28	
Moment of inertia (without brake)	$J_{mot}$	$10^{-4}$ kgm <sup>2</sup>	0.21	
Optimum operating point				
Optimum speed	$n_{opt}$	RPM	6000	
Optimum power	$P_{opt}$	kW	0.19	
Limiting data				
Max. permissible speed (mech.)	$n_{max}$	RPM	12000	
Max. torque	$M_{max}$	Nm	1.5	
Max. current	$I_{max}$	A	5	
Physical constants				
Torque constant	$k_T$	Nm/A	0.32	
Voltage constant	$k_E$	V/1000 RPM	20.5	
Winding resistance at 20° C	$R_{ph}$	Ohm	7.2	
Rotating field inductance	$L_D$	mH	4	
Electrical time constant	$T_{el}$	ms	0.56	
Shaft torsional stiffness	$C_t$	Nm/rad	3000	
Mechanical time constant	$T_{mech}$	ms	4.4	
Thermal time constant	$T_{th}$	min	15	
Weight with brake	m	kg	1.4	
Weight without brake	m	kg	1.2	

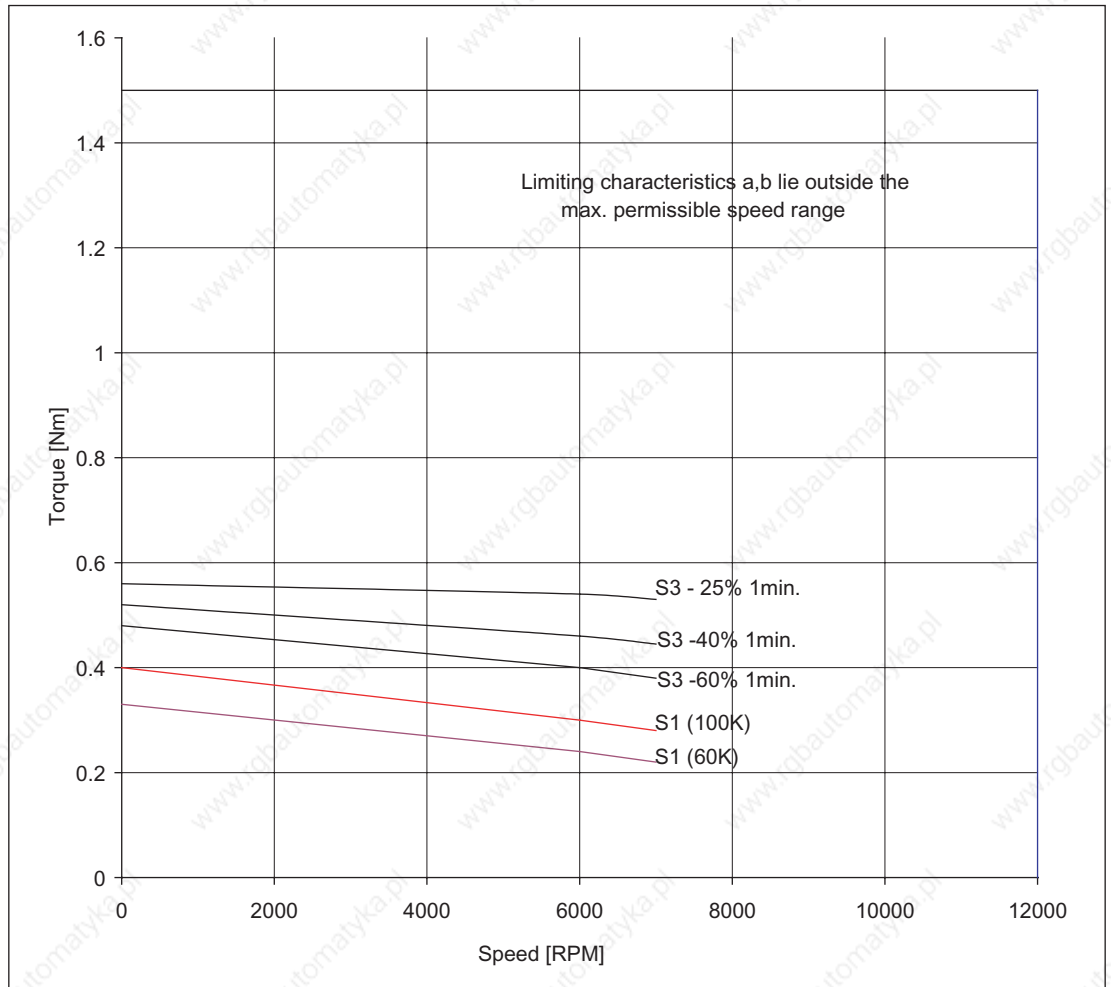

Figure 3-1 Speed-torque diagram 1FT6021-6AK71

[a] SINAMICS S120 SMART LINE,  $V_{DC\ link}=540V\ (DC)$ ,  $V_{mot}=380V_{rms}$

[b] SINAMICS S120 ACTIVE LINE,  $V_{DC\ link}=600V\ (DC)$ ,  $V_{mot}=425V_{rms}$

## Technical Data and Speed-Torque Diagrams

### 3.1 Speed-torque diagrams

Table 3-2 1FT6024 non-ventilated

1FT6024				
Technical data	Code	Units	-6AK71	
Engineering data				
Rated speed	$n_N$	RPM	6000	
No. of poles	2p		6	
Rated torque (100K)	$M_{N(100K)}$	Nm	0.5	
Rated current (100K)	$I_N(100K)$	A	0.9	
Stall torque (60K)	$M_0(60K)$	Nm	0.66	
Stall torque (100K)	$M_0(100K)$	Nm	0.8	
Stall current (60K)	$I_0(60K)$	A	1.0	
Stall current (100K)	$I_0(100K)$	A	1.25	
Moment of inertia (with brake)	$J_{mot}$	$10^{-4}$ kgm <sup>2</sup>	0.41	
Moment of inertia (without brake)	$J_{mot}$	$10^{-4}$ kgm <sup>2</sup>	0.34	
Optimum operating point				
Optimum speed	$n_{opt}$	RPM	6000	
Optimum power	$P_{opt}$	kW	0.31	
Limiting data				
Max. permissible speed (mech.)	$n_{max}$	RPM	12000	
Max. torque	$M_{max}$	Nm	3.15	
Max. current	$I_{max}$	A	5	
Physical constants				
Torque constant	$k_T$	Nm/A	0.63	
Voltage constant	$k_E$	V/1000 RPM	41	
Winding resistance at 20° C	$R_{ph}$	Ohm	10.9	
Rotating field inductance	$L_D$	mH	7	
Electrical time constant	$T_{el}$	ms	0.64	
Shaft torsional stiffness	$C_t$	Nm/rad	3000	
Mechanical time constant	$T_{mech}$	ms	2.8	
Thermal time constant	$T_{th}$	min	15	
Weight with brake	m	kg	2.3	
Weight without brake	m	kg	2.1	

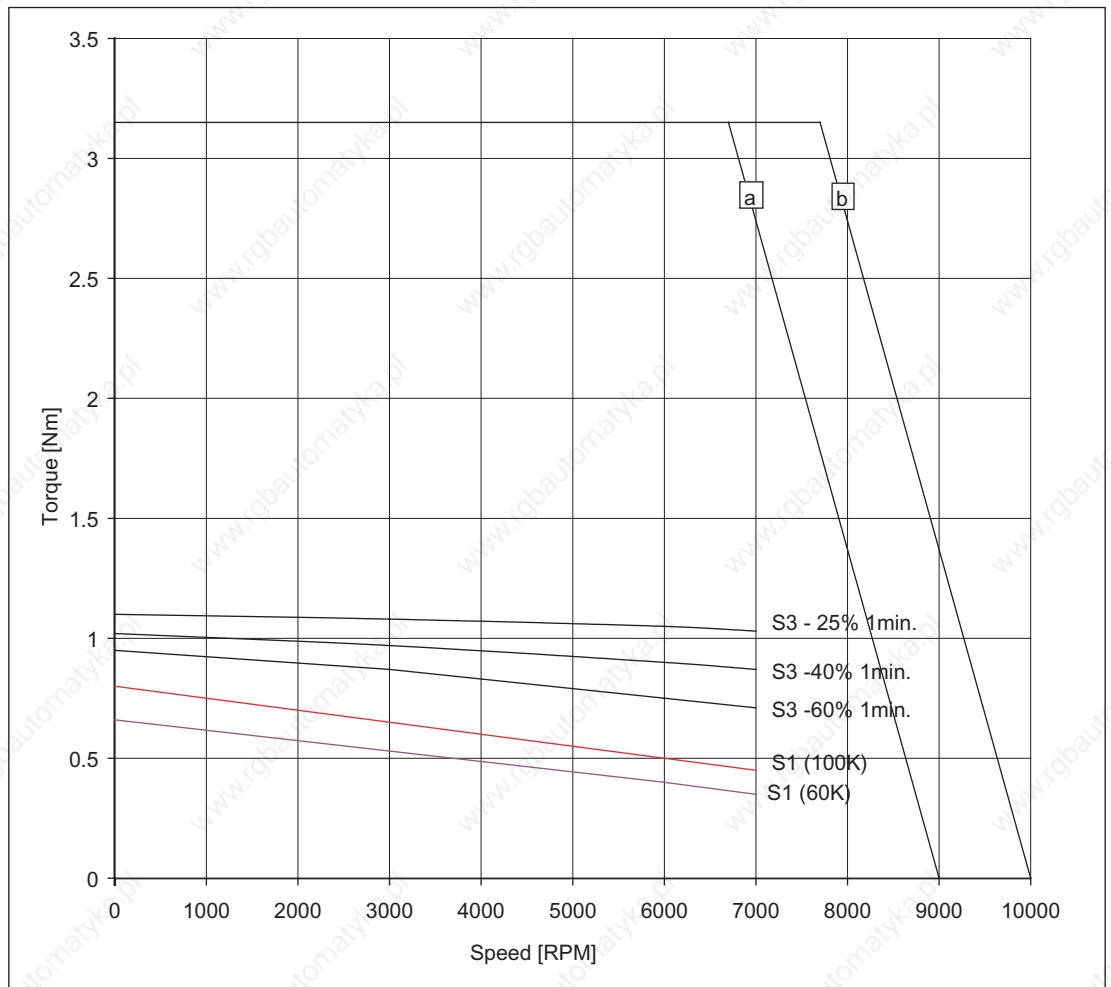

Figure 3-2 Speed-torque diagram 1FT6024-6AK71

[a] SINAMICS S120 SMART LINE,  $V_{DC\ link}=540V$  (DC),  $V_{mot}=380V_{rms}$

[b] SINAMICS S120 ACTIVE LINE,  $V_{DC\ link}=600V$  (DC),  $V_{mot}=425V_{rms}$

## Technical Data and Speed-Torque Diagrams

### 3.1 Speed-torque diagrams

Table 3-3 1FT6031 non-ventilated

1FT6031				
Technical data	Code	Units	-4AK71	
Engineering data				
Rated speed	$n_N$	RPM	6000	
No. of poles	2p		4	
Rated torque (100K)	$M_{N(100K)}$	Nm	0.75	
Rated current (100K)	$I_N(100K)$	A	1.2	
Stall torque (60K)	$M_0(60K)$	Nm	0.83	
Stall torque (100K)	$M_0(100K)$	Nm	1.0	
Stall current (60K)	$I_0(60K)$	A	1.1	
Stall current (100K)	$I_0(100K)$	A	1.4	
Moment of inertia (with brake)	$J_{mot}$	$10^{-4}$ kgm <sup>2</sup>	0.77	
Moment of inertia (without brake)	$J_{mot}$	$10^{-4}$ kgm <sup>2</sup>	0.65	
Optimum operating point				
Optimum speed	$n_{opt}$	RPM	6000	
Optimum power	$P_{opt}$	kW	0.47	
Limiting data				
Max. permissible speed (mech.)	$n_{max}$	RPM	9700	
Max. torque	$M_{max}$	Nm	4	
Max. current	$I_{max}$	A	5.8	
Physical constants				
Torque constant	$k_T$	Nm/A	0.72	
Voltage constant	$k_E$	V/1000 RPM	47	
Winding resistance at 20° C	$R_{ph}$	Ohm	6.9	
Rotating field inductance	$L_D$	mH	18	
Electrical time constant	$T_{el}$	ms	2.6	
Shaft torsional stiffness	$C_t$	Nm/rad	7500	
Mechanical time constant	$T_{mech}$	ms	2.6	
Thermal time constant	$T_{th}$	min	20	
Weight with brake	m	kg	3.5	
Weight without brake	m	kg	3.1	

[a] SINAMICS S120 SMART LINE,  $V_{DC\ link}=540V$  (DC),  $V_{mot}=380V_{rms}$

[b] SINAMICS S120 ACTIVE LINE,  $V_{DC\ link}=600V$  (DC),  $V_{mot}=425V_{rms}$



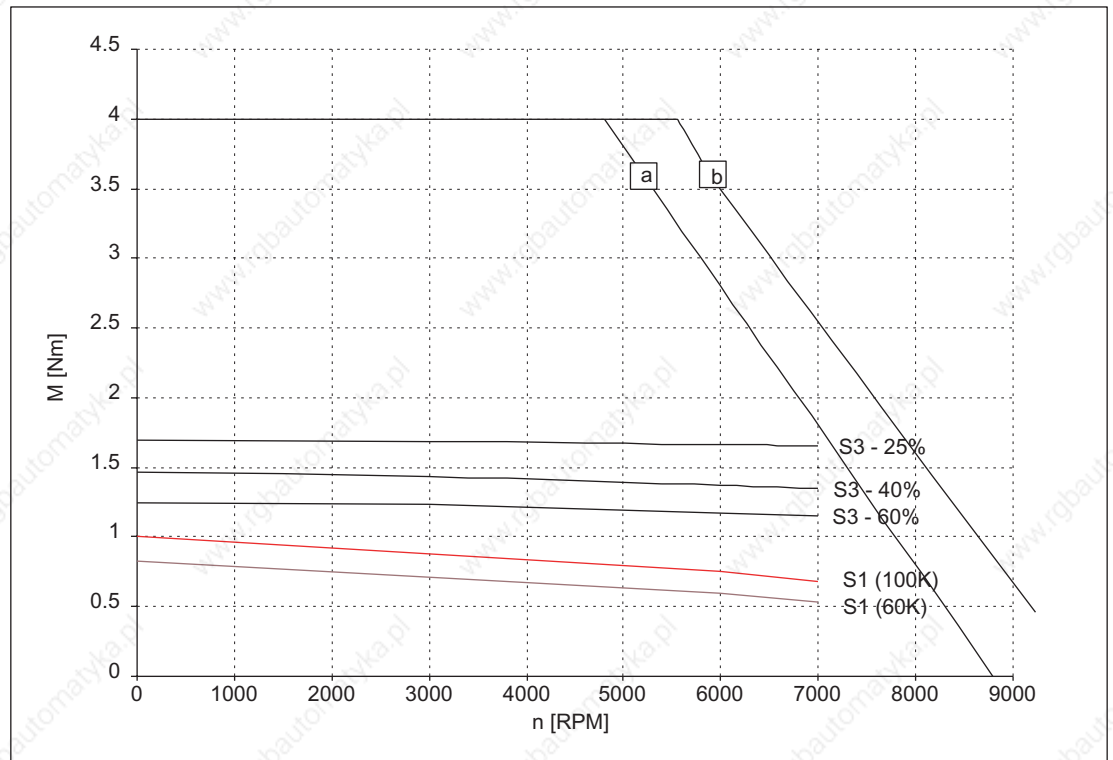

Figure 3-3 Speed-torque diagram 1FT6031-4AK71

## Technical Data and Speed-Torque Diagrams

### 3.1 Speed-torque diagrams

Table 3-4 1FT6034 non-ventilated

1FT6034				
Technical data	Code	Units	-4AK71	
Engineering data				
Rated speed	$n_N$	RPM	6000	
No. of poles	2p		4	
Rated torque (100K)	$M_{N(100K)}$	Nm	1.4	
Rated current (100K)	$I_{N(100K)}$	A	2.1	
Stall torque (60K)	$M_{0(60K)}$	Nm	1.65	
Stall torque (100K)	$M_{0(100K)}$	Nm	2	
Stall current (60K)	$I_{0(60K)}$	A	2.1	
Stall current (100K)	$I_{0(100K)}$	A	2.6	
Moment of inertia (with brake)	$J_{mot}$	$10^{-4}$ kgm <sup>2</sup>	1.22	
Moment of inertia (without brake)	$J_{mot}$	$10^{-4}$ kgm <sup>2</sup>	1.1	
Optimum operating point				
Optimum speed	$n_{opt}$	RPM	6000	
Optimum power	$P_{opt}$	kW	0.88	
Limiting data				
Max. permissible speed (mech.)	$n_{max}$	RPM	9700	
Max. torque	$M_{max}$	Nm	7.7	
Max. current	$I_{max}$	A	10.5	
Physical constants				
Torque constant	$k_T$	Nm/A	0.75	
Voltage constant	$k_E$	V/1000 RPM	49	
Winding resistance at 20° C	$R_{ph}$	Ohm	2.6	
Rotating field inductance	$L_D$	mH	10	
Electrical time constant	$T_{el}$	ms	3.8	
Shaft torsional stiffness	$C_t$	Nm/rad	7500	
Mechanical time constant	$T_{mech}$	ms	1.5	
Thermal time constant	$T_{th}$	min	20	
Weight with brake	m	kg	4.8	
Weight without brake	m	kg	4.4	

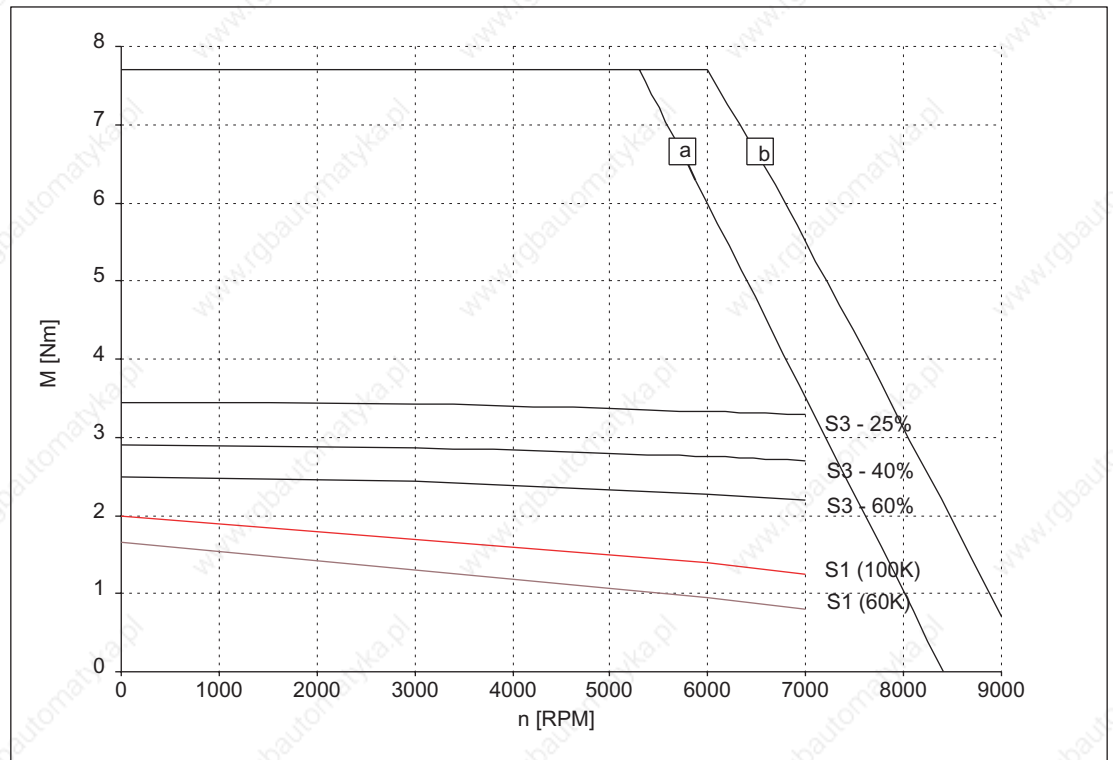

Figure 3-4 Speed-torque diagram 1FT6034

[a] SINAMICS S120 SMART LINE,  $V_{DC\ link}=540V$  (DC),  $V_{mot}=380V_{rms}$

[b] SINAMICS S120 ACTIVE LINE,  $V_{DC\ link}=600V$  (DC),  $V_{mot}=425V_{rms}$

## Technical Data and Speed-Torque Diagrams

### 3.1 Speed-torque diagrams

Table 3-5 1FT6041 non-ventilated

1FT6041					
Technical data	Code	Units	-4AF71	-4AK71	
Engineering data					
Rated speed	$n_N$	RPM	3000	6000	
No. of poles	2p		4	4	
Rated torque (100K)	$M_{N(100K)}$	Nm	2.15	1.7	
Rated current (100K)	$I_N(100K)$	A	1.7	2.4	
Stall torque (60K)	$M_0(60K)$	Nm	2.15	2.15	
Stall torque (100K)	$M_0(100K)$	Nm	2.6	2.6	
Stall current (60K)	$I_0(60K)$	A	1.5	2.5	
Stall current (100K)	$I_0(100K)$	A	1.9	3.0	
Moment of inertia (with brake)	$J_{mot}$	$10^{-4}$ kgm <sup>2</sup>	3.98	3.98	
Moment of inertia (without brake)	$J_{mot}$	$10^{-4}$ kgm <sup>2</sup>	2.9	2.9	
Optimum operating point					
Optimum speed	$n_{opt}$	RPM	3000	6000	
Optimum power	$P_{opt}$	kW	0.68	1.07	
Limiting data					
Max. permissible speed (mech.)	$n_{max}$	RPM	7700	7700	
Max. torque	$M_{max}$	Nm	10	10	
Max. current	$I_{max}$	A	7.7	12.8	
Physical constants					
Torque constant	$k_T$	Nm/A	1.38	0.83	
Voltage constant	$k_E$	V/1000 RPM	90	54	
Winding resistance at 20° C	$R_{ph}$	Ohm	6.6	2.37	
Rotating field inductance	$L_D$	mH	22	8	
Electrical time constant	$T_{el}$	ms	3.3	3.4	
Shaft torsional stiffness	$C_t$	Nm/rad	14000	14000	
Mechanical time constant	$T_{mech}$	ms	3	3	
Thermal time constant	$T_{th}$	min	30	30	
Weight with brake	m	kg	7.8	7.8	
Weight without brake	m	kg	6.6	6.6	

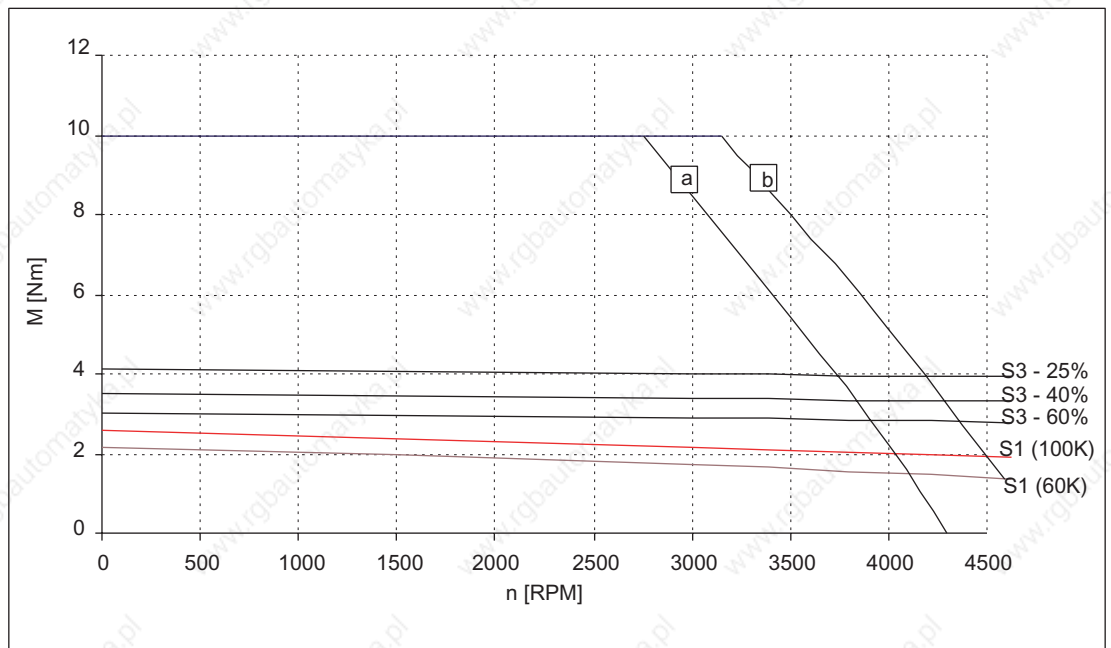

Figure 3-5 Speed-torque diagram 1FT6041-4AF71

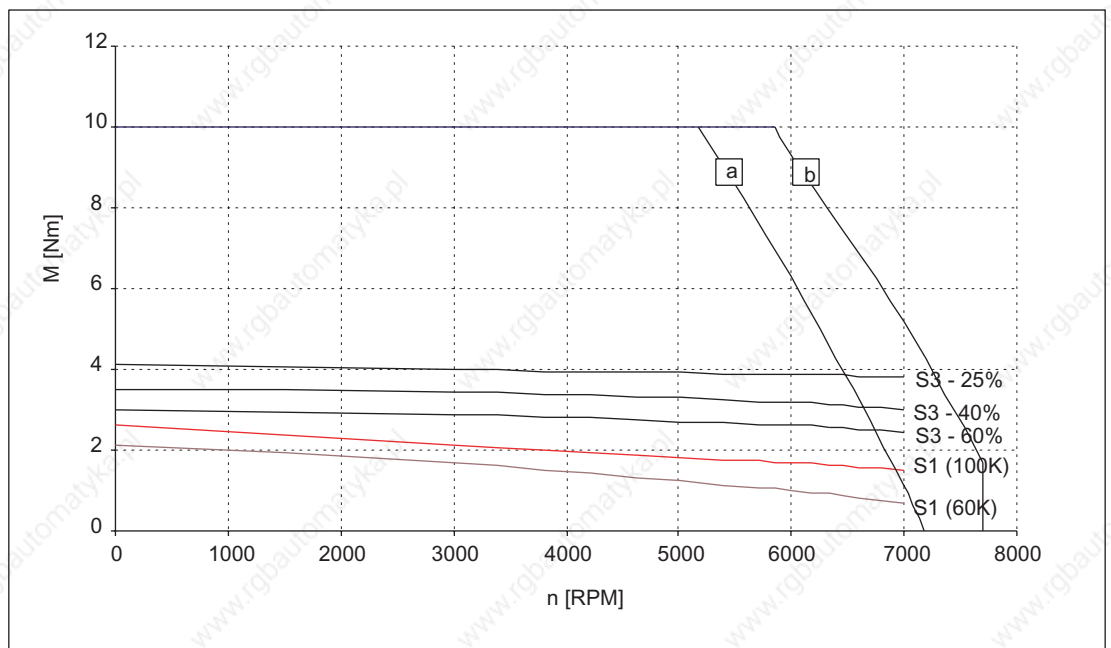

Figure 3-6 Speed-torque diagram 1FT6041-4AK71

[a] SINAMICS S120 SMART LINE,  $V_{DC\ link}=540V\ (DC)$ ,  $V_{mot}=380V_{rms}$

[b] SINAMICS S120 ACTIVE LINE,  $V_{DC\ link}=600V\ (DC)$ ,  $V_{mot}=425V_{rms}$

## Technical Data and Speed-Torque Diagrams

### 3.1 Speed-torque diagrams

Table 3-6 1FT6044 non-ventilated

1FT6044					
Technical data	Code	Units	-□AF71	-4AK71	
Engineering data					
Rated speed	$n_N$	RPM	3000	6000	
No. of poles	2p		4	4	
Rated torque (100K)	$M_N(100K)$	Nm	4.3	3.0	
Rated current (100K)	$I_N(100K)$	A	2.9	4.1	
Stall torque (60K)	$M_{l0}(60K)$	Nm	4.2	4.2	
Stall torque (100K)	$M_{l0}(100K)$	Nm	5.0	5.0	
Stall current (60K)	$I_{l0}(60K)$	A	2.4	4.8	
Stall current (100K)	$I_{l0}(100K)$	A	3.0	5.9	
Moment of inertia (with brake)	$J_{mot}$	$10^{-4}$ kgm <sup>2</sup>	6.18	6.18	
Moment of inertia (without brake)	$J_{mot}$	$10^{-4}$ kgm <sup>2</sup>	5.1	5.1	
Optimum operating point					
Optimum speed	$n_{opt}$	RPM	3000	6000	
Optimum power	$P_{opt}$	kW	1.35	1.88	
Limiting data					
Max. permissible speed (mech.)	$n_{max}$	RPM	7700	7700	
Max. torque	$M_{max}$	Nm	18	18	
Max. current	$I_{max}$	A	11	22	
Physical constants					
Torque constant	$k_T$	Nm/A	1.68	0.85	
Voltage constant	$k_E$	V/1000 RPM	109	55	
Winding resistance at 20° C	$R_{ph}$	Ohm	3.05	0.78	
Rotating field inductance	$L_D$	mH	16	4.1	
Electrical time constant	$T_{el}$	ms	5.2	5.3	
Shaft torsional stiffness	$C_t$	Nm/rad	11000	11000	
Mechanical time constant	$T_{mech}$	ms	1.7	1.7	
Thermal time constant	$T_{th}$	min	30	30	
Weight with brake	m	kg	9.5	9.5	
Weight without brake	m	kg	8.3	8.3	

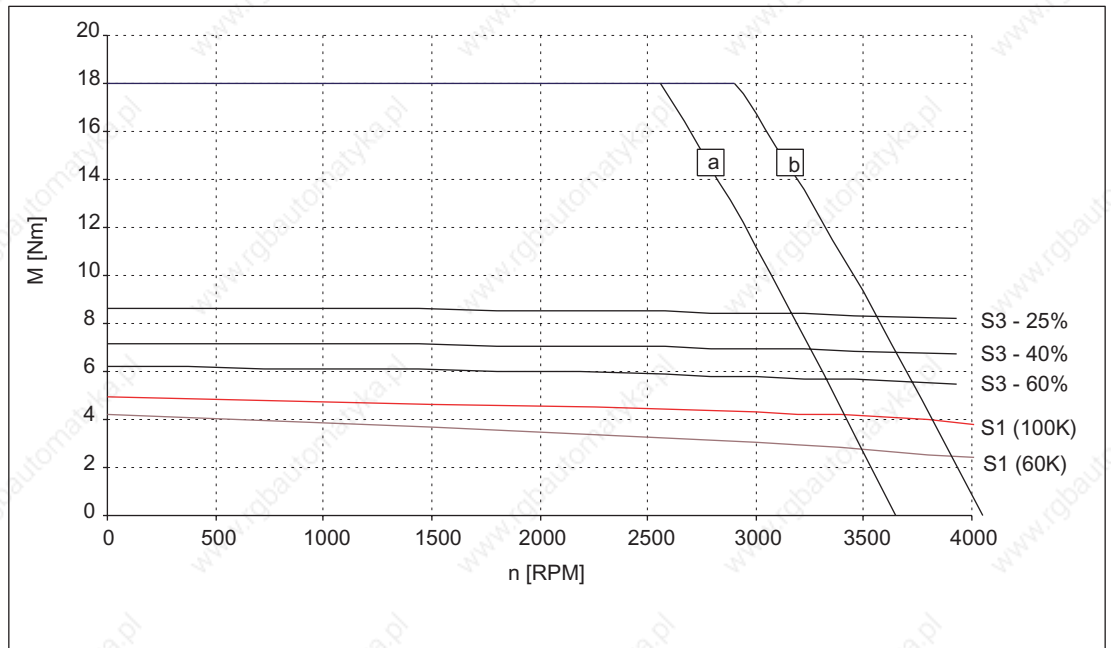

Figure 3-7 Speed-torque diagram 1FT6044-□AF71

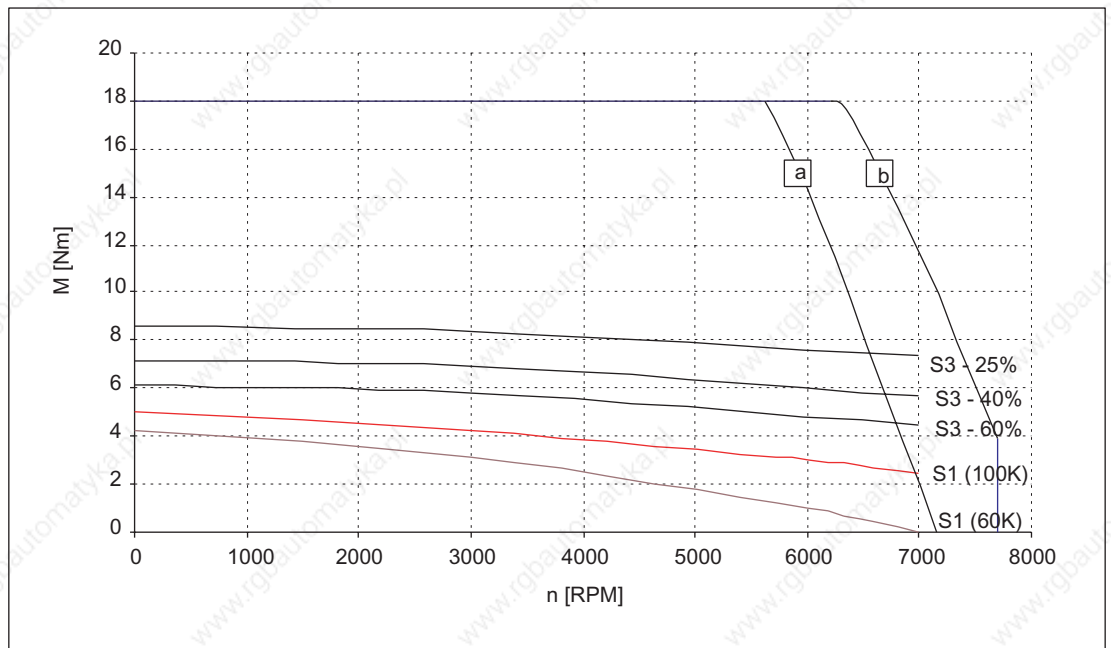

Figure 3-8 Speed-torque diagram 1FT6044-4AK71

[a] SINAMICS S120 SMART LINE,  $V_{DC\ link}=540V$  (DC),  $V_{mot}=380V_{rms}$

[b] SINAMICS S120 ACTIVE LINE,  $V_{DC\ link}=600V$  (DC),  $V_{mot}=425V_{rms}$

## Technical Data and Speed-Torque Diagrams

### 3.1 Speed-torque diagrams

Table 3-7 1FT6061 non-ventilated

1FT6061					
Technical data	Code	Units	-6AC7□	-6AF7□	
Engineering data					
Rated speed	$n_N$	RPM	2000	3000	
No. of poles	2p		6	6	
Rated torque (100K)	$M_{N(100K)}$	Nm	3.7	3.5	
Rated current (100K)	$I_N(100K)$	A	1.9	2.6	
Stall torque (60K)	$M_0(60K)$	Nm	3.3	3.3	
Stall torque (100K)	$M_0(100K)$	Nm	4.0	4.0	
Stall current (60K)	$I_0(60K)$	A	1.6	2.2	
Stall current (100K)	$I_0(100K)$	A	1.9	2.7	
Moment of inertia (with brake)	$J_{mot}$	$10^{-4}$ kgm <sup>2</sup>	9.3	9.3	
Moment of inertia (without brake)	$J_{mot}$	$10^{-4}$ kgm <sup>2</sup>	6	6	
Optimum operating point					
Optimum speed	$n_{opt}$	RPM	2000	3000	
Optimum power	$P_{opt}$	kW	0.77	1.1	
Limiting data					
Max. permissible speed (mech.)	$n_{max}$	RPM	9100	9100	
Max. torque	$M_{max}$	Nm	16	16	
Max. current	$I_{max}$	A	10	14	
Physical constants					
Torque constant	$k_T$	Nm/A	2.07	1.48	
Voltage constant	$k_E$	V/1000 RPM	132	94	
Winding resistance at 20° C	$R_{ph}$	Ohm	9.3	4.71	
Rotating field inductance	$L_D$	mH	59	30	
Electrical time constant	$T_{el}$	ms	6.3	6.4	
Shaft torsional stiffness	$C_t$	Nm/rad	34000	34000	
Mechanical time constant	$T_{mech}$	ms	3.9	3.9	
Thermal time constant	$T_{th}$	min	20	20	
Weight with brake	m	kg	9.5	9.5	
Weight without brake	m	kg	8	8	



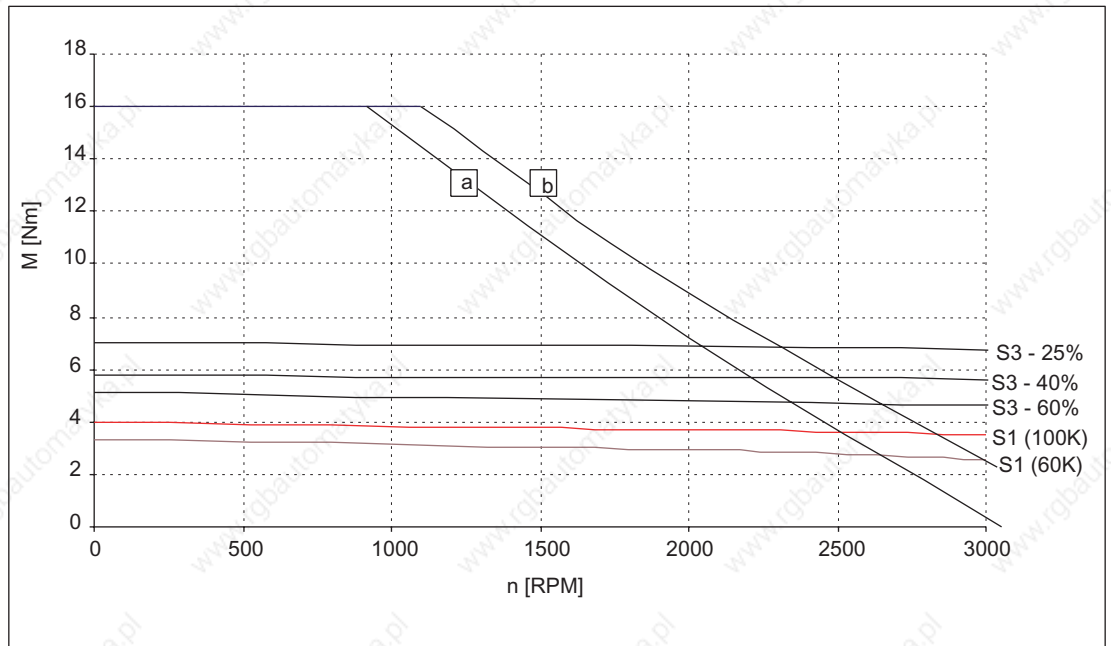

Figure 3-9 Speed-torque diagram 1FT6061-6AC7□

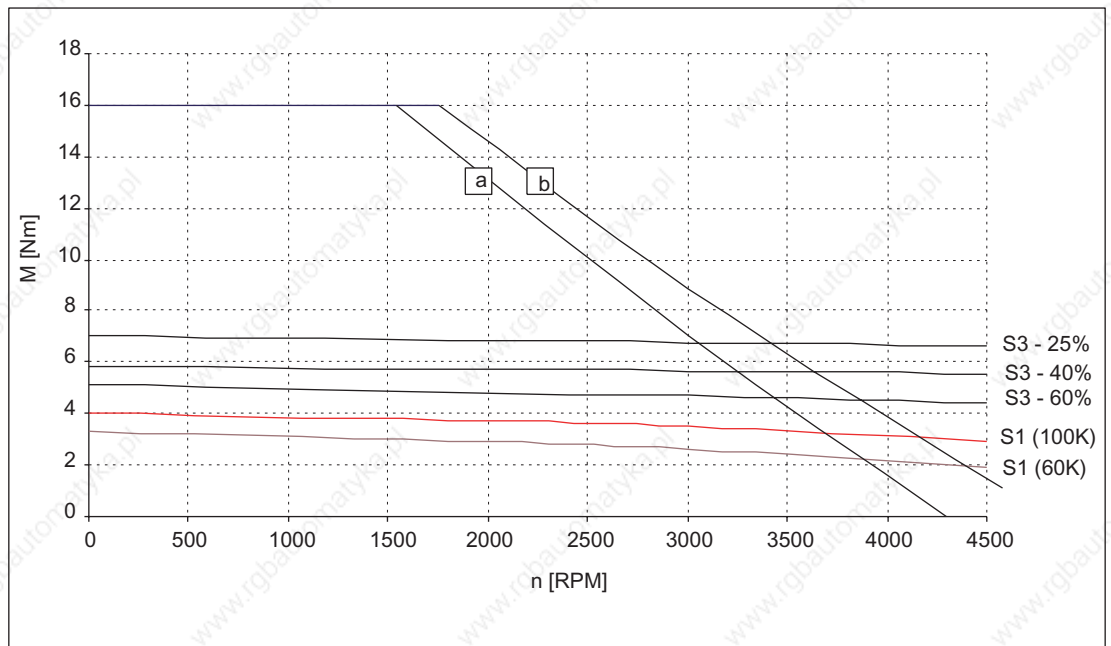

Figure 3-10 Speed-torque diagram 1FT6061-6AF7□

[a] SINAMICS S120 SMART LINE,  $V_{DC\ link}=540V$  (DC),  $V_{mot}=380V_{rms}$

[b] SINAMICS S120 ACTIVE LINE,  $V_{DC\ link}=600V$  (DC),  $V_{mot}=425V_{rms}$

## Technical Data and Speed-Torque Diagrams

### 3.1 Speed-torque diagrams

Table 3-8 1FT6061 non-ventilated

1FT6061					
Technical data	Code	Units	-6AH7□	-6AK7□	
Engineering data					
Rated speed	$n_N$	RPM	4500	6000	
No. of poles	2p		6	6	
Rated torque (100K)	$M_{N(100K)}$	Nm	2.9	2.1	
Rated current (100K)	$I_N(100K)$	A	3.4	3.1	
Stall torque (60K)	$M_0(60K)$	Nm	3.3	3.3	
Stall torque (100K)	$M_0(100K)$	Nm	4	4	
Stall current (60K)	$I_0(60K)$	A	3.3	4	
Stall current (100K)	$I_0(100K)$	A	4	5	
Moment of inertia (with brake)	$J_{mot}$	$10^{-4}$ kgm <sup>2</sup>	9.3	9.3	
Moment of inertia (without brake)	$J_{mot}$	$10^{-4}$ kgm <sup>2</sup>	6	6	
Optimum operating point					
Optimum speed	$n_{opt}$	RPM	4500	5000	
Optimum power	$P_{opt}$	kW	1.37	1.38	
Limiting data					
Max. permissible speed (mech.)	$n_{max}$	RPM	9100	9100	
Max. torque	$M_{max}$	Nm	16	16	
Max. current	$I_{max}$	A	21	26	
Physical constants					
Torque constant	$k_T$	Nm/A	0.99	0.80	
Voltage constant	$k_E$	V/1000 RPM	63	51	
Winding resistance at 20° C	$R_{ph}$	Ohm	2.1	1.42	
Rotating field inductance	$L_D$	mH	13.3	9	
Electrical time constant	$T_{el}$	ms	6.3	6.3	
Shaft torsional stiffness	$C_t$	Nm/rad	34000	34000	
Mechanical time constant	$T_{mech}$	ms	3.9	4.0	
Thermal time constant	$T_{th}$	min	20	20	
Weight with brake	m	kg	9.5	9.5	
Weight without brake	m	kg	8	8	

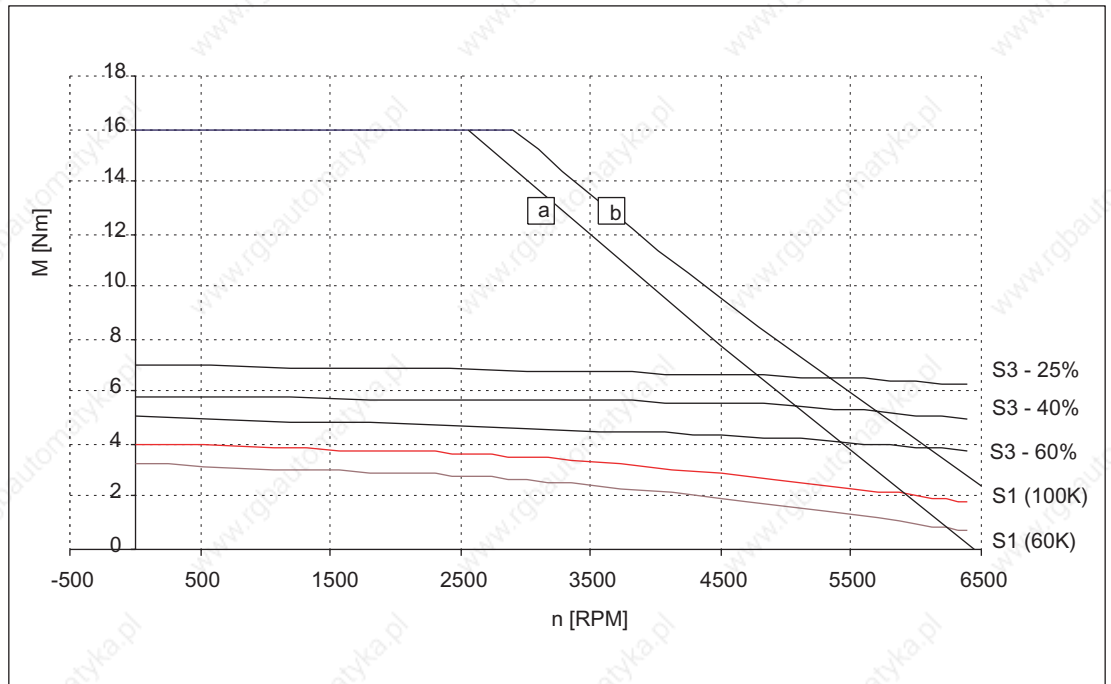

Figure 3-11 Speed-torque diagram 1FT6061-6AH7

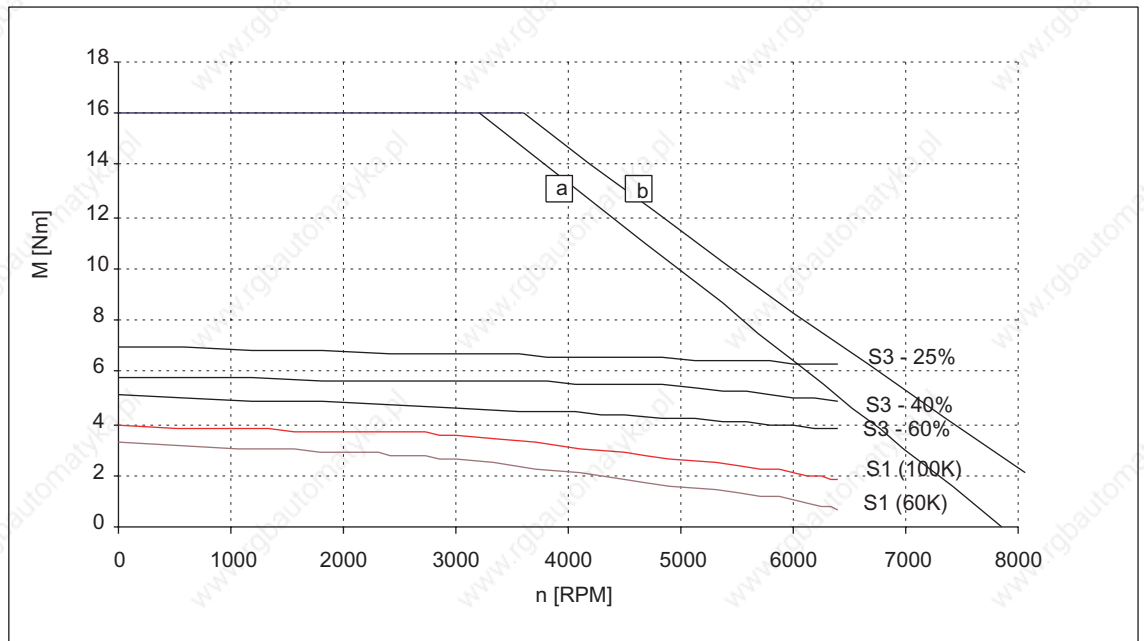

Figure 3-12 Speed-torque diagram 1FT6061-6AK7

[a] SINAMICS S120 SMART LINE,  $V_{DC\ link}=540V\ (DC)$ ,  $V_{mot}=380V_{rms}$

[b] SINAMICS S120 ACTIVE LINE,  $V_{DC\ link}=600V\ (DC)$ ,  $V_{mot}=425V_{rms}$

Technical Data and Speed-Torque Diagrams

3.1 Speed-torque diagrams

Table 3-9 1FT6062 non-ventilated

1FT6062					
Technical data	Code	Units	-6AC7□	-6AF7□	
Engineering data					
Rated speed	$n_N$	RPM	2000	3000	
No. of poles	2p		6	6	
Rated torque (100K)	$M_{N(100K)}$	Nm	5.2	4.7	
Rated current (100K)	$I_N(100K)$	A	2.6	3.4	
Stall torque (60K)	$M_0(60K)$	Nm	5	5	
Stall torque (100K)	$M_0(100K)$	Nm	6	6	
Stall current (60K)	$I_0(60K)$	A	2.2	3.3	
Stall current (100K)	$I_0(100K)$	A	2.7	4.1	
Moment of inertia (with brake)	$J_{mot}$	$10^{-4}$ kgm <sup>2</sup>	11.8	11.8	
Moment of inertia (without brake)	$J_{mot}$	$10^{-4}$ kgm <sup>2</sup>	8.5	8.5	
Optimum operating point					
Optimum speed	$n_{opt}$	RPM	2000	3000	
Optimum power	$P_{opt}$	kW	1.09	1.48	
Limiting data					
Max. permissible speed (mech.)	$n_{max}$	RPM	9100	9100	
Max. torque	$M_{max}$	Nm	24	24	
Max. current	$I_{max}$	A	15	22	
Physical constants					
Torque constant	$k_T$	Nm/A	2.22	1.48	
Voltage constant	$k_E$	V/1000 RPM	141	94	
Winding resistance at 20° C	$R_{ph}$	Ohm	5.8	2.57	
Rotating field inductance	$L_D$	mH	43	19	
Electrical time constant	$T_{el}$	ms	7.4	7.4	
Shaft torsional stiffness	$C_t$	Nm/rad	32000	32000	
Mechanical time constant	$T_{mech}$	ms	3.0	3.0	
Thermal time constant	$T_{th}$	min	25	25	
Weight with brake	$m$	kg	11	11	
Weight without brake	$m$	kg	9.5	9.5	

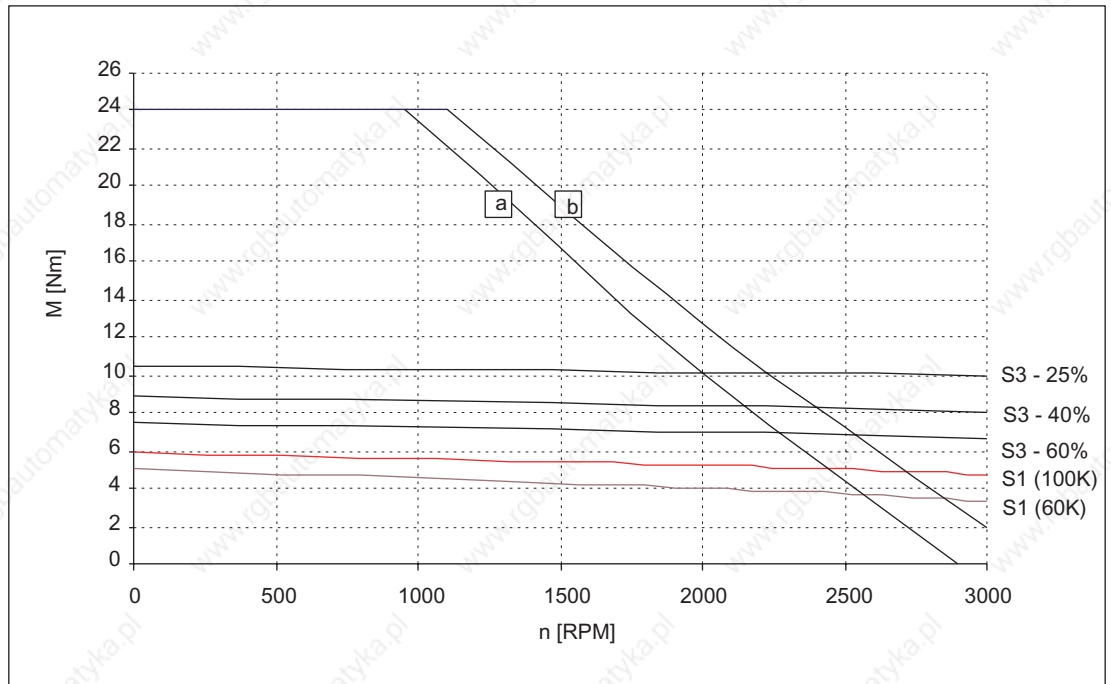

Figure 3-13 Speed-torque diagram 1FT6062-6AC7

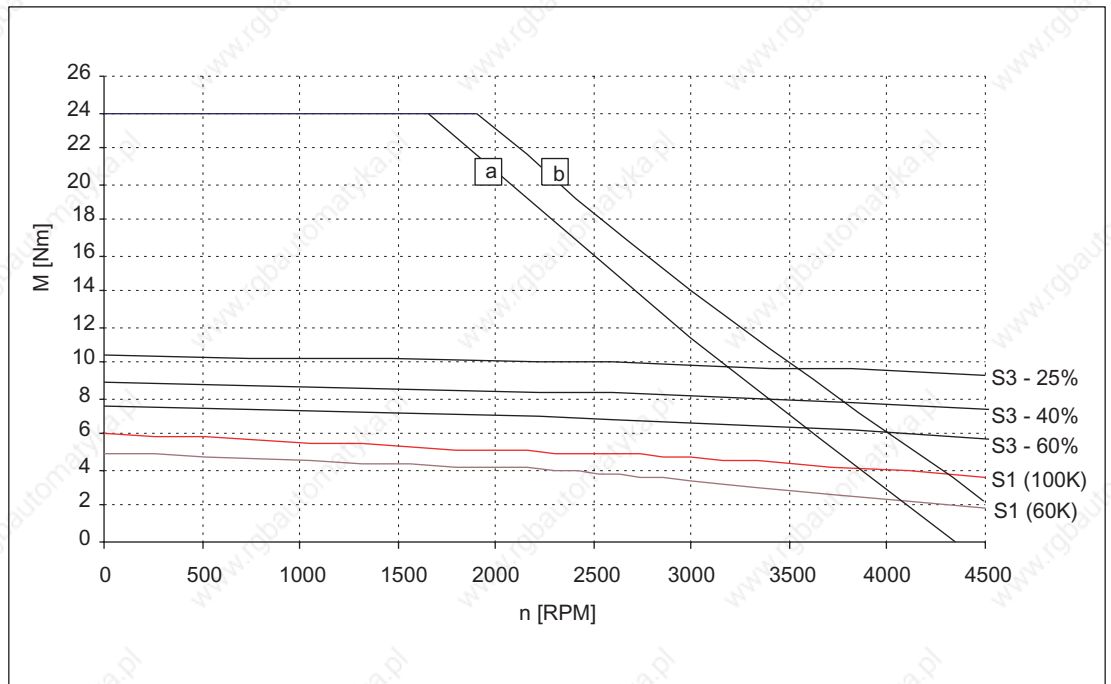

Figure 3-14 Speed-torque diagram 1FT6062-6AF7

[a] SINAMICS S120 SMART LINE,  $V_{DC\ link}=540V$  (DC),  $V_{mot}=380V_{rms}$

[b] SINAMICS S120 ACTIVE LINE,  $V_{DC\ link}=600V$  (DC),  $V_{mot}=425V_{rms}$

## Technical Data and Speed-Torque Diagrams

### 3.1 Speed-torque diagrams

Table 3-10 1FT6062 non-ventilated

1FT6062					
Technical data	Code	Units	-6AH7□	-6AK7□	
Engineering data					
Rated speed	$n_N$	RPM	4500	6000	
No. of poles	2p		6	6	
Rated torque (100K)	$M_{N(100K)}$	Nm	3.6	2.1	
Rated current (100K)	$I_N(100K)$	A	3.9	3.2	
Stall torque (60K)	$M_0(60K)$	Nm	5	5	
Stall torque (100K)	$M_0(100K)$	Nm	6	6	
Stall current (60K)	$I_0(60K)$	A	4.7	6.2	
Stall current (100K)	$I_0(100K)$	A	5.7	7.6	
Moment of inertia (with brake)	$J_{mot}$	$10^{-4}$ kgm <sup>2</sup>	11.8	11.8	
Moment of inertia (without brake)	$J_{mot}$	$10^{-4}$ kgm <sup>2</sup>	8.5	8.5	
Optimum operating point					
Optimum speed	$n_{opt}$	RPM	4500	4500	
Optimum power	$P_{opt}$	kW	1.70	1.70	
Limiting data					
Max. permissible speed (mech.)	$n_{max}$	RPM	9100	9100	
Max. torque	$M_{max}$	Nm	24	24	
Max. current	$I_{max}$	A	31	41	
Physical constants					
Torque constant	$k_T$	Nm/A	1.05	0.79	
Voltage constant	$k_E$	V/1000 RPM	67	50	
Winding resistance at 20° C	$R_{ph}$	Ohm	1.31	0.74	
Rotating field inductance	$L_D$	mH	9.7	5.5	
Electrical time constant	$T_{el}$	ms	7.4	7.4	
Shaft torsional stiffness	$C_t$	Nm/rad	32000	32000	
Mechanical time constant	$T_{mech}$	ms	3.0	3.0	
Thermal time constant	$T_{th}$	min	25	25	
Weight with brake	m	kg	11	11	
Weight without brake	m	kg	9.5	9.5	

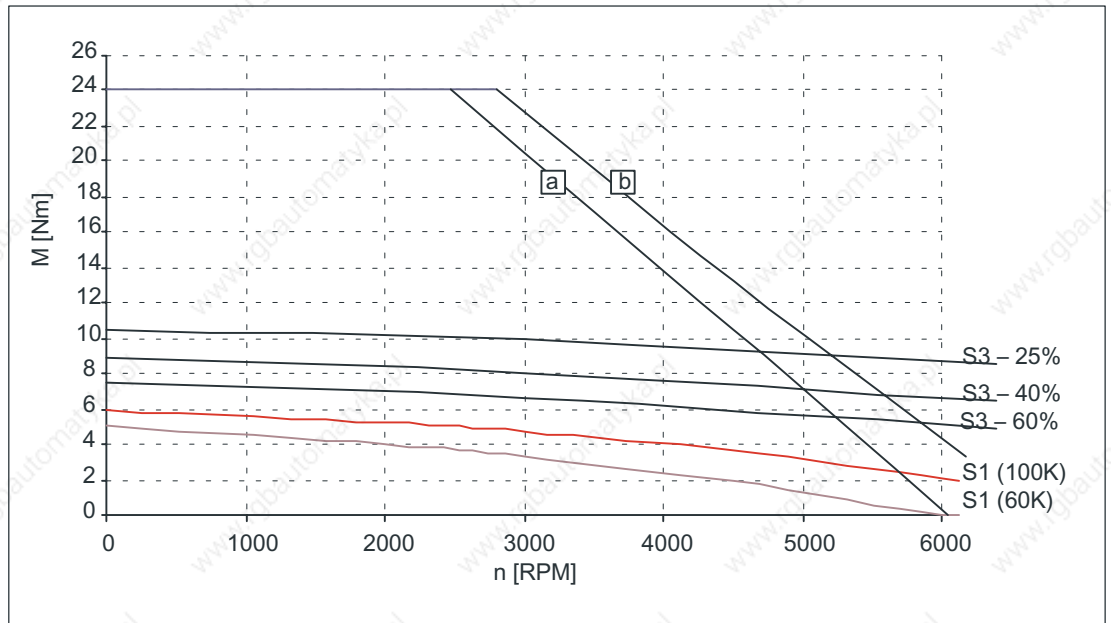

Figure 3-15 Speed-torque diagram 1FT6062-6AH7□

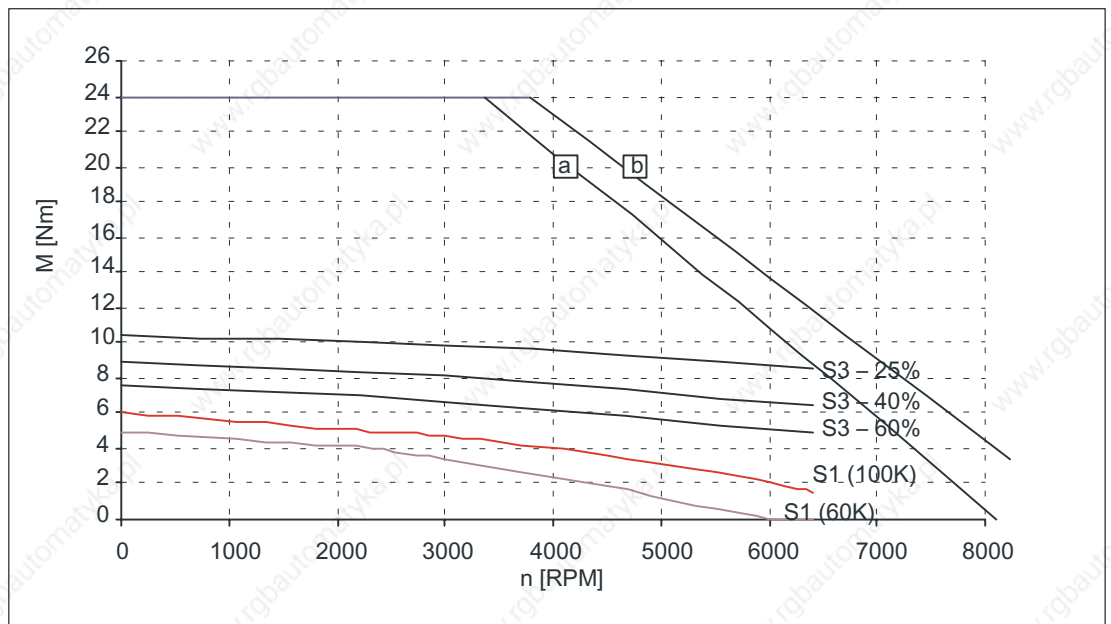

Figure 3-16 Speed-torque diagram 1FT6062-6AK7□

[a] SINAMICS S120 SMART LINE,  $V_{DC\ link}=540V$  (DC),  $V_{mot}=380V_{rms}$

[b] SINAMICS S120 ACTIVE LINE,  $V_{DC\ link}=600V$  (DC),  $V_{mot}=425V_{rms}$

## Technical Data and Speed-Torque Diagrams

### 3.1 Speed-torque diagrams

Table 3-11 1FT6064 non-ventilated

1FT6064					
Technical data	Code	Units	-6AC7□	-6AF7□	
Engineering data					
Rated speed	$n_N$	RPM	2000	3000	
No. of poles	2p		6	6	
Rated torque (100K)	$M_{N(100K)}$	Nm	8.0	7.0	
Rated current (100K)	$I_N(100K)$	A	3.8	4.9	
Stall torque (60K)	$M_0(60K)$	Nm	7.9	7.9	
Stall torque (100K)	$M_0(100K)$	Nm	9.5	9.5	
Stall current (60K)	$I_0(60K)$	A	3.4	4.9	
Stall current (100K)	$I_0(100K)$	A	4.2	6.1	
Moment of inertia (with brake)	$J_{mot}$	$10^{-4}$ kgm <sup>2</sup>	16.3	16.3	
Moment of inertia (without brake)	$J_{mot}$	$10^{-4}$ kgm <sup>2</sup>	13	13	
Optimum operating point					
Optimum speed	$n_{opt}$	RPM	2000	3000	
Optimum power	$P_{opt}$	kW	1.68	2.20	
Limiting data					
Max. permissible speed (mech.)	$n_{max}$	RPM	9100	9100	
Max. torque	$M_{max}$	Nm	38	38	
Max. current	$I_{max}$	A	23	33	
Physical constants					
Torque constant	$k_T$	Nm/A	2.26	1.57	
Voltage constant	$k_E$	V/1000 RPM	144	100	
Winding resistance at 20° C	$R_{ph}$	Ohm	2.93	1.40	
Rotating field inductance	$L_D$	mH	28	13.5	
Electrical time constant	$T_{el}$	ms	9.6	9.6	
Shaft torsional stiffness	$C_t$	Nm/rad	27000	27000	
Mechanical time constant	$T_{mech}$	ms	2.2	2.2	
Thermal time constant	$T_{th}$	min	30	30	
Weight with brake	m	kg	13	13	
Weight without brake	m	kg	12.5	12.5	



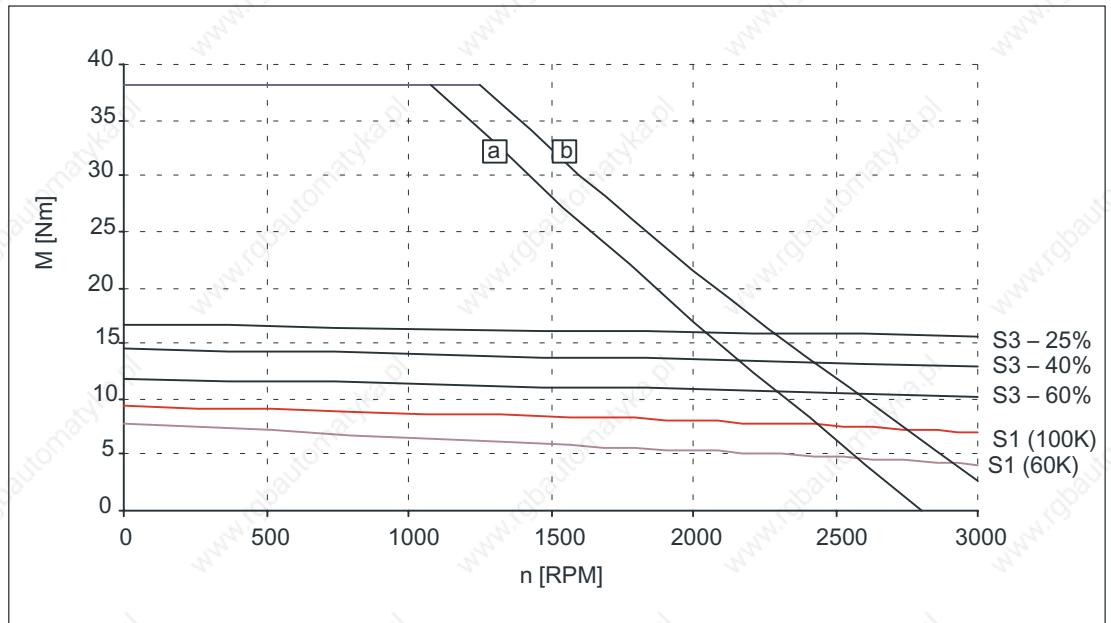

Figure 3-17 Speed-torque diagram 1FT6064-6AC7□

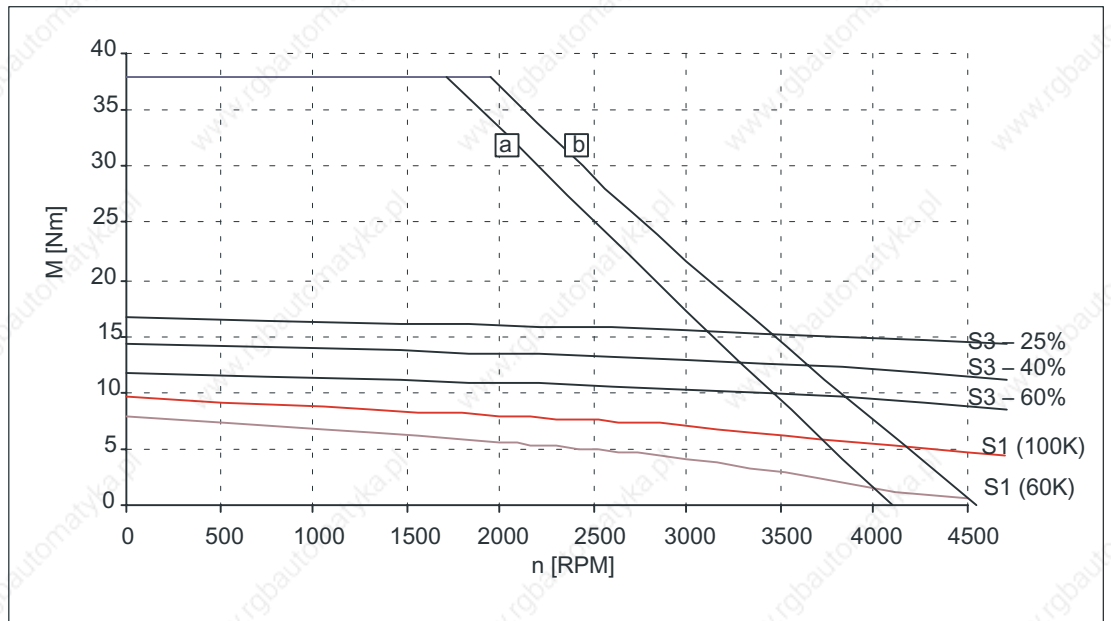

Figure 3-18 Speed-torque diagram 1FT6064-6AF7□

[a] SINAMICS S120 SMART LINE,  $V_{DC\ link}=540V$  (DC),  $V_{mot}=380V_{rms}$

[b] SINAMICS S120 ACTIVE LINE,  $V_{DC\ link}=600V$  (DC),  $V_{mot}=425V_{rms}$

## Technical Data and Speed-Torque Diagrams

### 3.1 Speed-torque diagrams

Table 3-12 1FT6064 non-ventilated

1FT6064					
Technical data	Code	Units	-6AH7□	-6AK7□	
Engineering data					
Rated speed	$n_N$	RPM	4500	6000	
No. of poles	2p		6	6	
Rated torque (100K)	$M_{N(100K)}$	Nm	4.8	2.1	
Rated current (100K)	$I_N(100K)$	A	5.5	3.5	
Stall torque (60K)	$M_0(60K)$	Nm	7.9	7.9	
Stall torque (100K)	$M_0(100K)$	Nm	9.5	9.5	
Stall current (60K)	$I_0(60K)$	A	7.3	9.8	
Stall current (100K)	$I_0(100K)$	A	9.0	12.0	
Moment of inertia (with brake)	$J_{mot}$	$10^{-4}$ kgm <sup>2</sup>	16.3	16.3	
Moment of inertia (without brake)	$J_{mot}$	$10^{-4}$ kgm <sup>2</sup>	13	13	
Optimum operating point					
Optimum speed	$n_{opt}$	RPM	4500	4500	
Optimum power	$P_{opt}$	kW	2.26	2.26	
Limiting data					
Max. permissible speed (mech.)	$n_{max}$	RPM	9100	9100	
Max. torque	$M_{max}$	Nm	38	38	
Max. current	$I_{max}$	A	49	66	
Physical constants					
Torque constant	$k_T$	Nm/A	1.05	0.79	
Voltage constant	$k_E$	V/1000 RPM	67	50	
Winding resistance at 20° C	$R_{ph}$	Ohm	0.63	0.35	
Rotating field inductance	$L_D$	mH	6	3.4	
Electrical time constant	$T_{el}$	ms	9.5	9.7	
Shaft torsional stiffness	$C_t$	Nm/rad	27000	27000	
Mechanical time constant	$T_{mech}$	ms	2.2	2.2	
Thermal time constant	$T_{th}$	min	30	30	
Weight with brake	m	kg	13	13	
Weight without brake	m	kg	12.5	12.5	

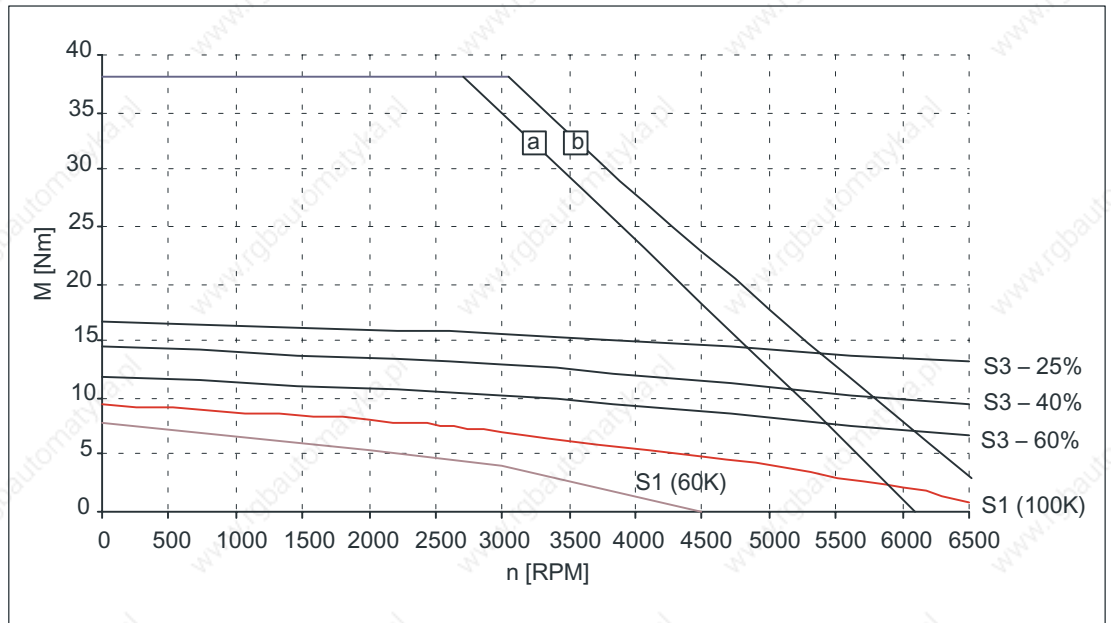

Figure 3-19 Speed-torque diagram 1FT6064-6AH7□

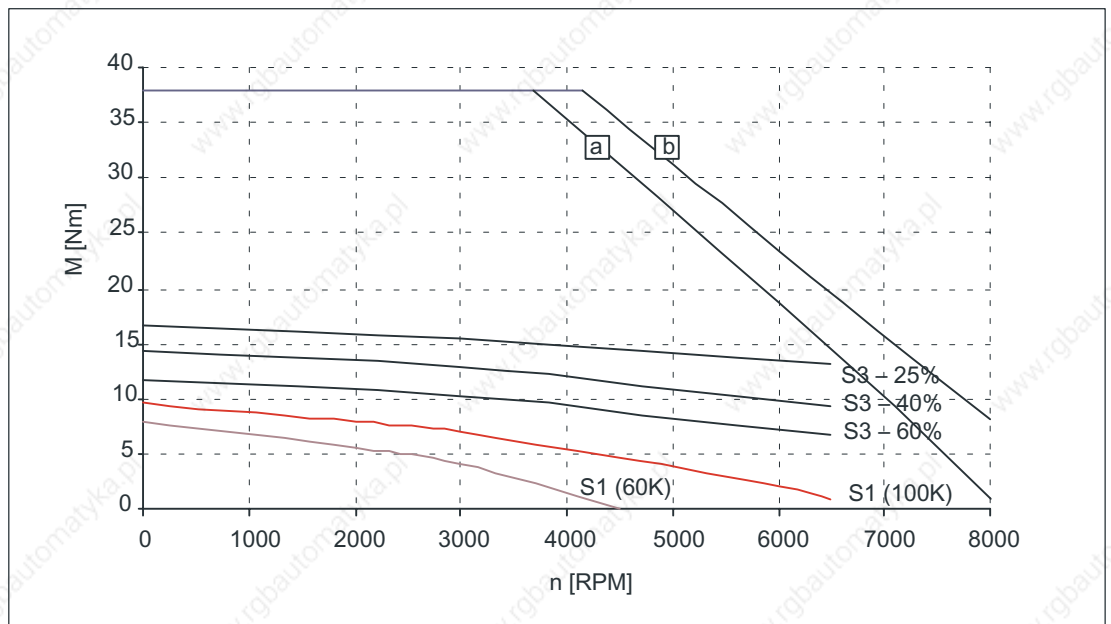

Figure 3-20 Speed-torque diagram 1FT6064-6AK7□

[a] SINAMICS S120 SMART LINE,  $V_{DC\ link}=540V$  (DC),  $V_{mot}=380V_{rms}$

[b] SINAMICS S120 ACTIVE LINE,  $V_{DC\ link}=600V$  (DC),  $V_{mot}=425V_{rms}$

## Technical Data and Speed-Torque Diagrams

### 3.1 Speed-torque diagrams

Table 3-13 1FT6081 non-ventilated

1FT6081						
Technical data	Code	Units	-8AC7□	-8AF7□		
Engineering data						
Rated speed	$n_N$	RPM	2000	3000		
No. of poles	2p		8	8		
Rated torque (100K)	$M_{N(100K)}$	Nm	7.5	6.9		
Rated current (100K)	$I_N(100K)$	A	4.1	5.6		
Stall torque (60K)	$M_0(60K)$	Nm	6.6	6.6		
Stall torque (100K)	$M_0(100K)$	Nm	8.0	8.0		
Stall current (60K)	$I_0(60K)$	A	3.1	4.7		
Stall current (100K)	$I_0(100K)$	A	3.9	5.8		
Moment of inertia (with brake)	$J_{mot}$	$10^{-4}$ kgm <sup>2</sup>	24.8	24.8		
Moment of inertia (without brake)	$J_{mot}$	$10^{-4}$ kgm <sup>2</sup>	21	21		
Optimum operating point						
Optimum speed	$n_{opt}$	RPM	2000	3000		
Optimum power	$P_{opt}$	kW	1.57	2.17		
Limiting data						
Max. permissible speed (mech.)	$n_{max}$	RPM	7900	7900		
Max. torque	$M_{max}$	Nm	26	26		
Max. current	$I_{max}$	A	16.5	24.5		
Physical constants						
Torque constant	$k_T$	Nm/A	2.07	1.38		
Voltage constant	$k_E$	V/1000 RPM	132	88		
Winding resistance at 20° C	$R_{ph}$	Ohm	3.08	1.37		
Rotating field inductance	$L_D$	mH	23	10.3		
Electrical time constant	$T_{el}$	ms	7.5	7.5		
Shaft torsional stiffness	$C_t$	Nm/rad	100000	100000		
Mechanical time constant	$T_{mech}$	ms	4.5	4.5		
Thermal time constant	$T_{th}$	min	25	25		
Weight with brake	m	kg	14	14		
Weight without brake	m	kg	12.5	12.5		

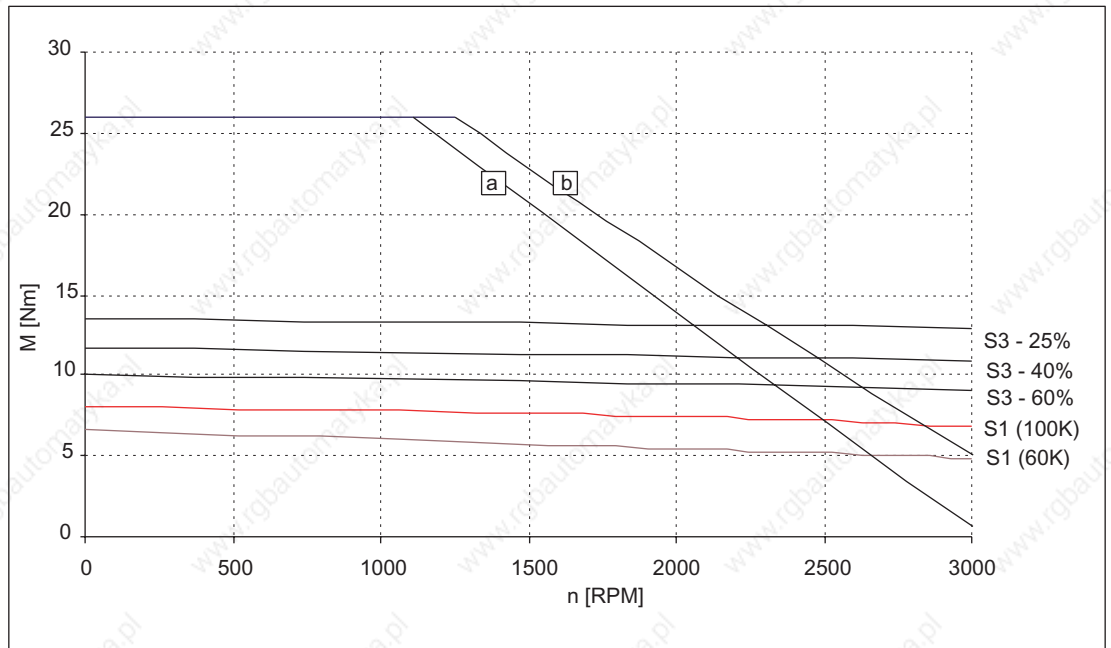

Figure 3-21 Speed-torque diagram 1FT6081-8AC7□

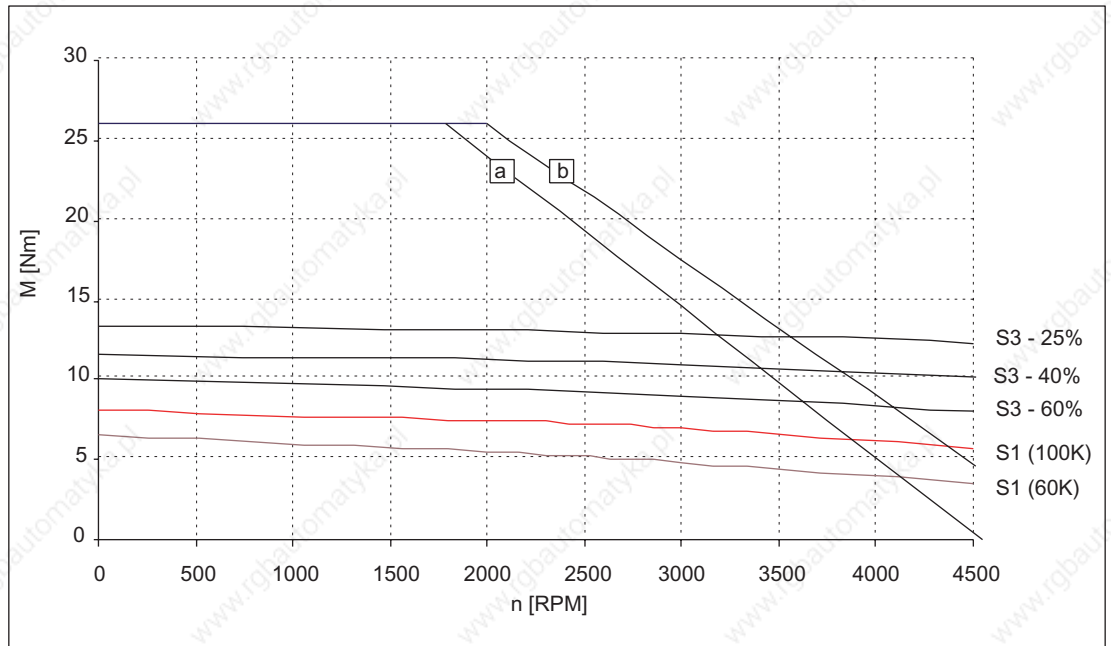

Figure 3-22 Speed-torque diagram 1FT6081-8AF7□

[a] SINAMICS S120 SMART LINE,  $V_{DC \text{ link}}=540V$  (DC),  $V_{\text{mot}}=380V_{\text{rms}}$

[b] SINAMICS S120 ACTIVE LINE,  $V_{DC \text{ link}}=600V$  (DC),  $V_{\text{mot}}=425V_{\text{rms}}$

## Technical Data and Speed-Torque Diagrams

### 3.1 Speed-torque diagrams

Table 3-14 1FT6081 non-ventilated

1FT6081					
Technical data	Code	Units	-8AH7□	-8AK7□	
Engineering data					
Rated speed	$n_N$	RPM	4500	6000	
No. of poles	2p		8	8	
Rated torque (100K)	$M_{N(100K)}$	Nm	5.8	4.6	
Rated current (100K)	$I_N(100K)$	A	7.3	7.7	
Stall torque (60K)	$M_0(60K)$	Nm	6.6	6.6	
Stall torque (100K)	$M_0(100K)$	Nm	8.0	8.0	
Stall current (60K)	$I_0(60K)$	A	7.0	8.9	
Stall current (100K)	$I_0(100K)$	A	8.6	11.1	
Moment of inertia (with brake)	$J_{mot}$	$10^{-4}$ kgm <sup>2</sup>	24.8	24.8	
Moment of inertia (without brake)	$J_{mot}$	$10^{-4}$ kgm <sup>2</sup>	21	21	
Optimum operating point					
Optimum speed	$n_{opt}$	RPM	4500	6000	
Optimum power	$P_{opt}$	kW	2.73	2.89	
Limiting data					
Max. permissible speed (mech.)	$n_{max}$	RPM	7900	7900	
Max. torque	$M_{max}$	Nm	26	26	
Max. current	$I_{max}$	A	37	46	
Physical constants					
Torque constant	$k_T$	Nm/A	0.93	0.72	
Voltage constant	$k_E$	V/1000 RPM	59	46	
Winding resistance at 20° C	$R_{ph}$	Ohm	0.61	0.38	
Rotating field inductance	$L_D$	mH	4.6	3	
Electrical time constant	$T_{el}$	ms	7.5	7.9	
Shaft torsional stiffness	$C_t$	Nm/rad	100000	100000	
Mechanical time constant	$T_{mech}$	ms	4.4	4.6	
Thermal time constant	$T_{th}$	min	25	25	
Weight with brake	m	kg	14	14	
Weight without brake	m	kg	12.5	12.5	

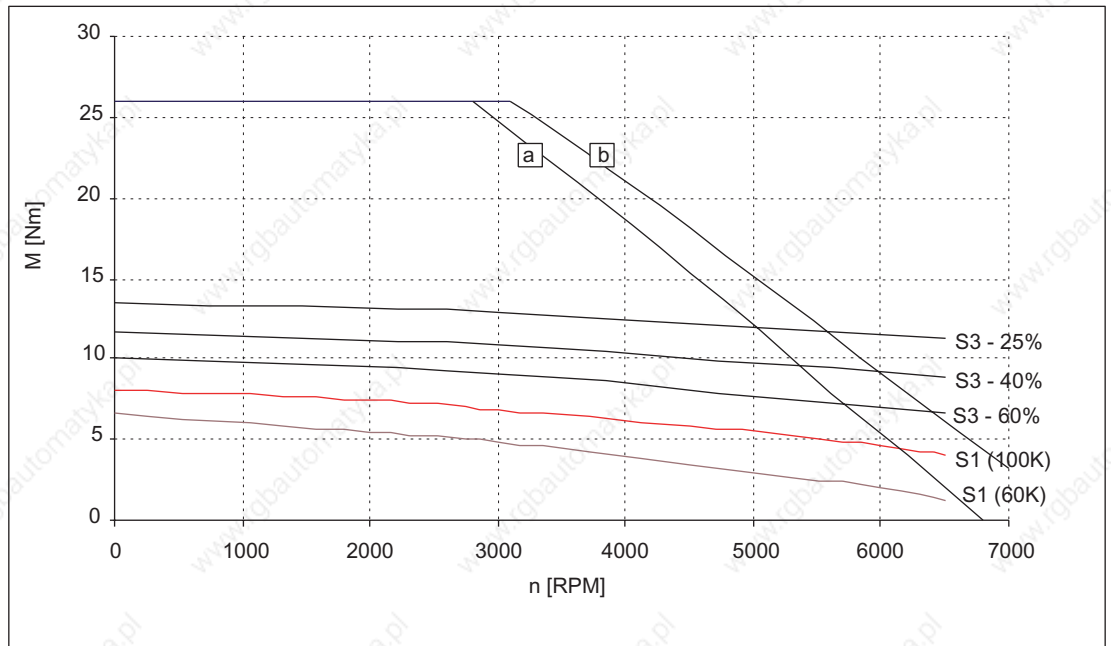

Figure 3-23 Speed-torque diagram 1FT6081-8AH7

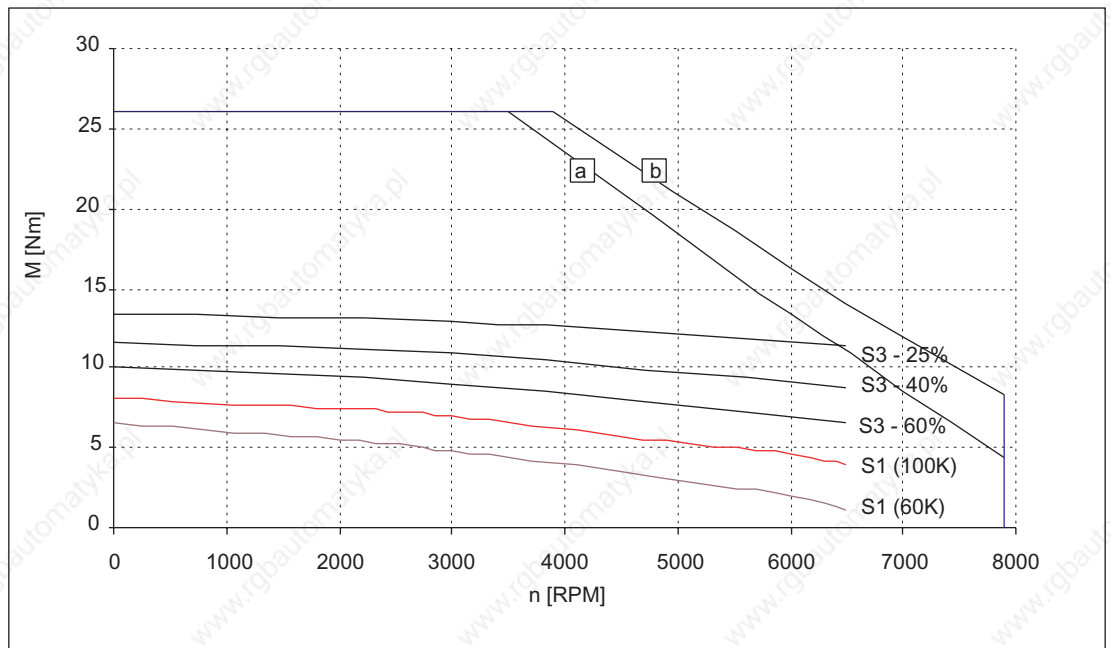

Figure 3-24 Speed-torque diagram 1FT6081-8AK7

[a] SINAMICS S120 SMART LINE,  $V_{DC \text{ link}}=540V$  (DC),  $V_{mot}=380V_{rms}$

[b] SINAMICS S120 ACTIVE LINE,  $V_{DC \text{ link}}=600V$  (DC),  $V_{mot}=425V_{rms}$

## Technical Data and Speed-Torque Diagrams

### 3.1 Speed-torque diagrams

Table 3-15 1FT6082 non-ventilated

1FT6082					
Technical data	Code	Units	-8AC7□	-□AF7□	
Engineering data					
Rated speed	$n_N$	RPM	2000	3000	
No. of poles	2p		8	8	
Rated torque (100K)	$M_{N(100K)}$	Nm	11.4	10.3	
Rated current (100K)	$I_N(100K)$	A	6.6	8.7	
Stall torque (60K)	$M_0(60K)$	Nm	10.8	10.8	
Stall torque (100K)	$M_0(100K)$	Nm	13	13	
Stall current (60K)	$I_0(60K)$	A	5.4	7.8	
Stall current (100K)	$I_0(100K)$	A	6.6	9.6	
Moment of inertia (with brake)	$J_{mot}$	$10^{-4}$ kgm <sup>2</sup>	33.8	33.8	
Moment of inertia (without brake)	$J_{mot}$	$10^{-4}$ kgm <sup>2</sup>	30	30	
Optimum operating point					
Optimum speed	$n_{opt}$	RPM	2000	3000	
Optimum power	$P_{opt}$	kW	2.39	3.24	
Limiting data					
Max. permissible speed (mech.)	$n_{max}$	RPM	7900	7900	
Max. torque	$M_{max}$	Nm	42	42	
Max. current	$I_{max}$	A	28	41	
Physical constants					
Torque constant	$k_T$	Nm/A	1.96	1.35	
Voltage constant	$k_E$	V/1000 RPM	125	86	
Winding resistance at 20° C	$R_{ph}$	Ohm	1.48	0.69	
Rotating field inductance	$L_D$	mH	13.6	6.2	
Electrical time constant	$T_{el}$	ms	9.2	9.0	
Shaft torsional stiffness	$C_t$	Nm/rad	90000	90000	
Mechanical time constant	$T_{mech}$	ms	3.5	3.4	
Thermal time constant	$T_{th}$	min	30	30	
Weight with brake	m	kg	16.5	16.5	
Weight without brake	m	kg	15	15	



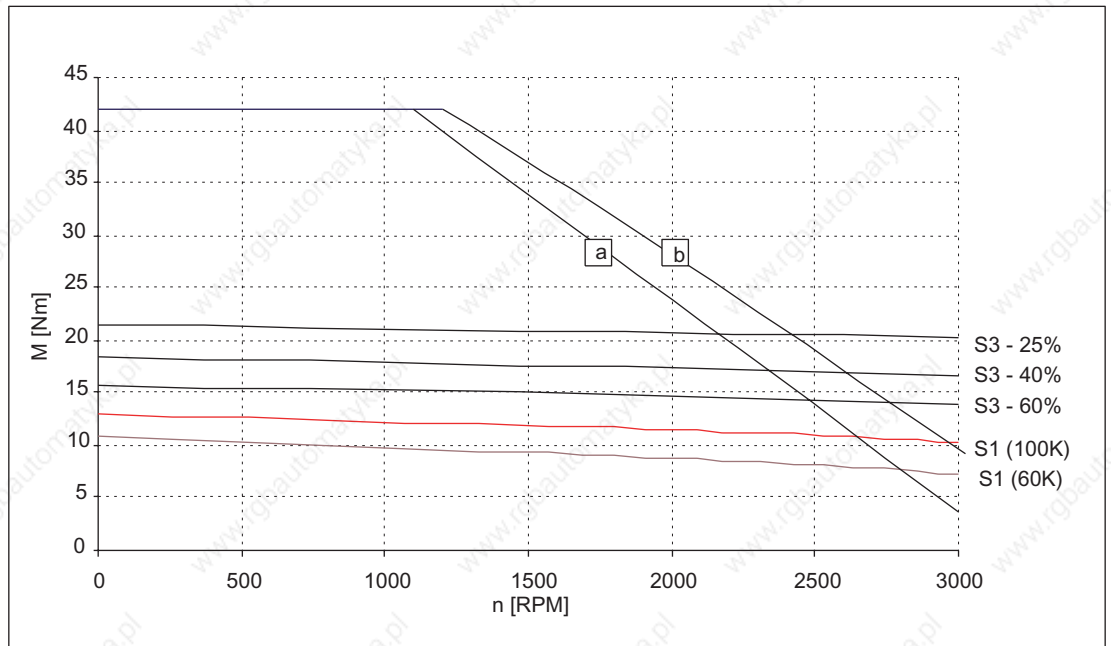

Figure 3-25 Speed-torque diagram 1FT6082-8AC7

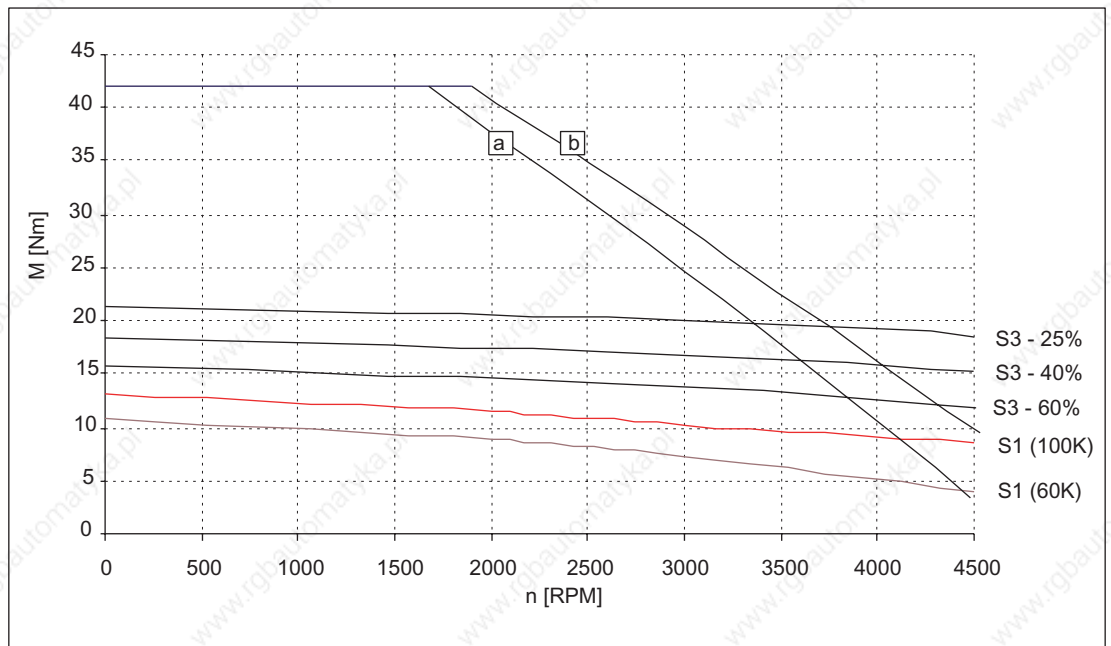

Figure 3-26 Speed-torque diagram 1FT6082-8AF7

[a] SINAMICS S120 SMART LINE,  $V_{\text{DC link}}=540\text{V (DC)}$ ,  $V_{\text{mot}}=380\text{V}_{\text{rms}}$

[b] SINAMICS S120 ACTIVE LINE,  $V_{\text{DC link}}=600\text{V (DC)}$ ,  $V_{\text{mot}}=425\text{V}_{\text{rms}}$

## Technical Data and Speed-Torque Diagrams

### 3.1 Speed-torque diagrams

Table 3-16 1FT6082 non-ventilated

1FT6082					
Technical data	Code	Units	-8AH7□	-8AK7□	
Engineering data					
Rated speed	$n_N$	RPM	4500	6000	
No. of poles	2p		8	8	
Rated torque (100K)	$M_{N(100K)}$	Nm	8.5	5.5	
Rated current (100K)	$I_N(100K)$	A	11	9.1	
Stall torque (60K)	$M_0(60K)$	Nm	10.8	10.8	
Stall torque (100K)	$M_0(100K)$	Nm	13	13.0	
Stall current (60K)	$I_0(60K)$	A	12.0	14.0	
Stall current (100K)	$I_0(100K)$	A	14.8	17.3	
Moment of inertia (with brake)	$J_{mot}$	$10^{-4}$ kgm <sup>2</sup>	33.8	33.8	
Moment of inertia (without brake)	$J_{mot}$	$10^{-4}$ kgm <sup>2</sup>	30	30	
Optimum operating point					
Optimum speed	$n_{opt}$	RPM	4500	4500	
Optimum power	$P_{opt}$	kW	4.01	4.01	
Limiting data					
Max. permissible speed (mech.)	$n_{max}$	RPM	7900	7900	
Max. torque	$M_{max}$	Nm	42	42	
Max. current	$I_{max}$	A	60	73	
Physical constants					
Torque constant	$k_T$	Nm/A	0.88	0.75	
Voltage constant	$k_E$	V/1000 RPM	56	48	
Winding resistance at 20° C	$R_{ph}$	Ohm	0.30	0.21	
Rotating field inductance	$L_D$	mH	2.9	1.9	
Electrical time constant	$T_{el}$	ms	9.7	9.0	
Shaft torsional stiffness	$C_t$	Nm/rad	90000	90000	
Mechanical time constant	$T_{mech}$	ms	3.5	3.4	
Thermal time constant	$T_{th}$	min	30	30	
Weight with brake	m	kg	16.5	16.5	
Weight without brake	m	kg	15	15	

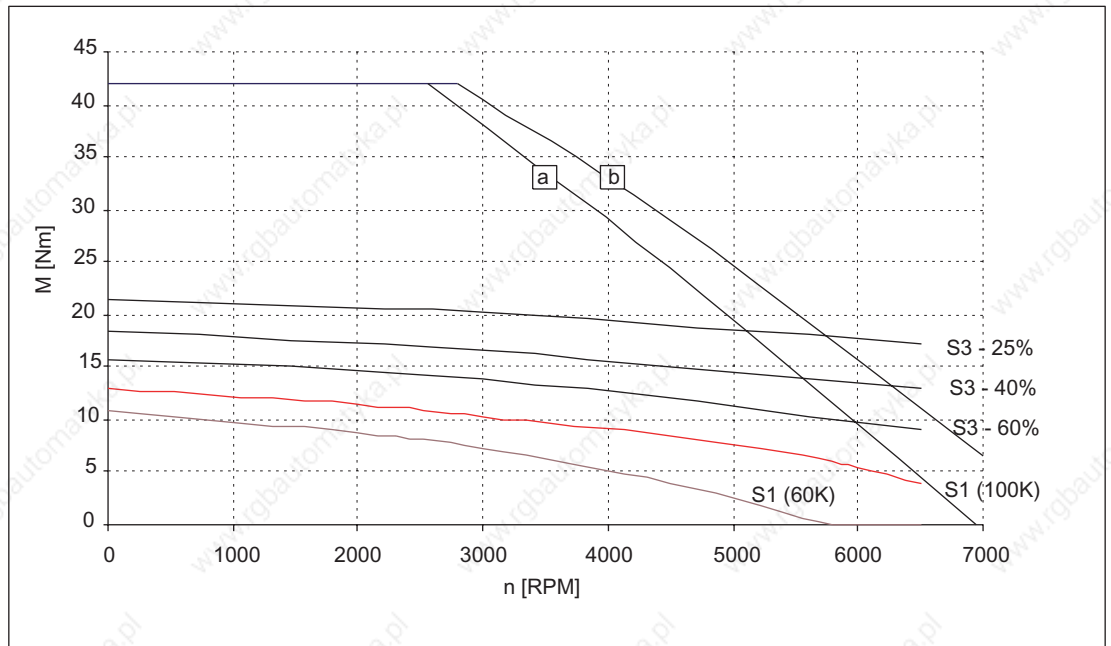

Figure 3-27 Speed-torque diagram 1FT6082-8AH7□

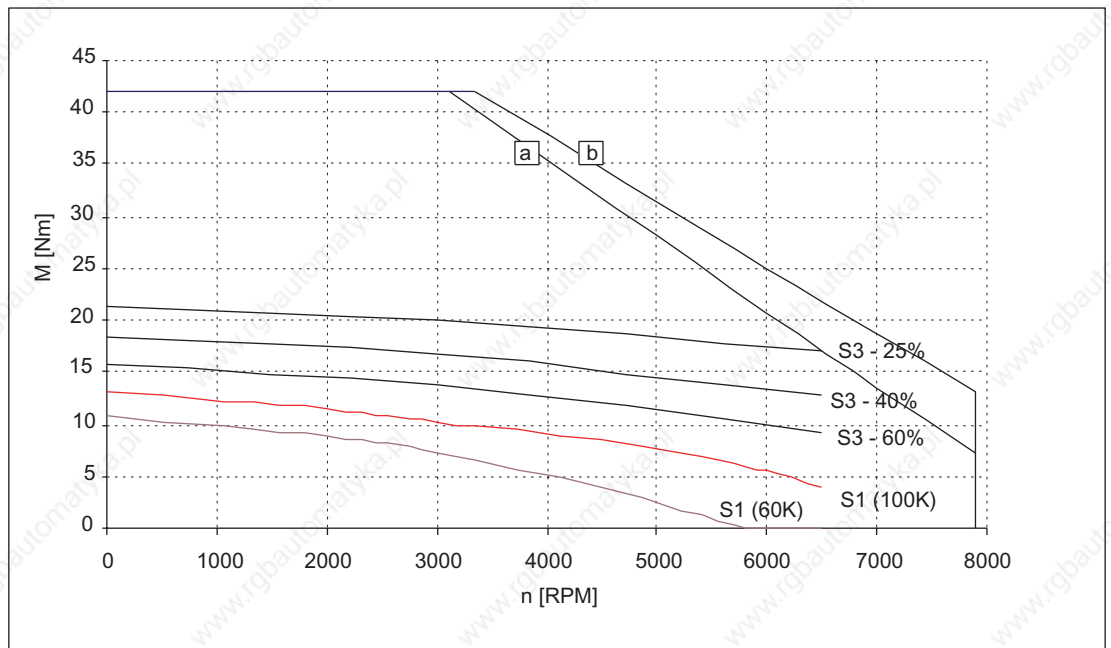

Figure 3-28 Speed-torque diagram 1FT6082-8AK7□

[a] SINAMICS S120 SMART LINE,  $V_{\text{DC link}}=540\text{V (DC)}$ ,  $V_{\text{mot}}=380\text{V}_{\text{rms}}$

[b] SINAMICS S120 ACTIVE LINE,  $V_{\text{DC link}}=600\text{V (DC)}$ ,  $V_{\text{mot}}=425\text{V}_{\text{rms}}$

Technical Data and Speed-Torque Diagrams

3.1 Speed-torque diagrams

Table 3-17 1FT6084 non-ventilated

1FT6084					
Technical data	Code	Units	-8AC7□	-□AF7□	
Engineering data					
Rated speed	$n_N$	RPM	2000	3000	
No. of poles	2p		8	8	
Rated torque (100K)	$M_{N(100K)}$	Nm	16.9	14.7	
Rated current (100K)	$I_N(100K)$	A	8.3	11	
Stall torque (60K)	$M_0(60K)$	Nm	16.6	16.6	
Stall torque (100K)	$M_0(100K)$	Nm	20	20	
Stall current (60K)	$I_0(60K)$	A	7.2	10.7	
Stall current (100K)	$I_0(100K)$	A	8.8	13.2	
Moment of inertia (with brake)	$J_{mot}$	$10^{-4}$ kgm <sup>2</sup>	61.1	61.1	
Moment of inertia (without brake)	$J_{mot}$	$10^{-4}$ kgm <sup>2</sup>	48	48	
Optimum operating point					
Optimum speed	$n_{opt}$	RPM	2000	3000	
Optimum power	$P_{opt}$	kW	3.54	4.62	
Limiting data					
Max. permissible speed (mech.)	$n_{max}$	RPM	7900	7900	
Max. torque	$M_{max}$	Nm	65	65	
Max. current	$I_{max}$	A	38	56	
Physical constants					
Torque constant	$k_T$	Nm/A	2.26	1.52	
Voltage constant	$k_E$	V/1000 RPM	144	97	
Winding resistance at 20° C	$R_{ph}$	Ohm	0.91	0.41	
Rotating field inductance	$L_D$	mH	10.4	4.8	
Electrical time constant	$T_{el}$	ms	11.4	11.7	
Shaft torsional stiffness	$C_t$	Nm/rad	76000	76000	
Mechanical time constant	$T_{mech}$	ms	2.6	2.6	
Thermal time constant	$T_{th}$	min	35	35	
Weight with brake	m	kg	24	24	
Weight without brake	m	kg	20.5	20.5	

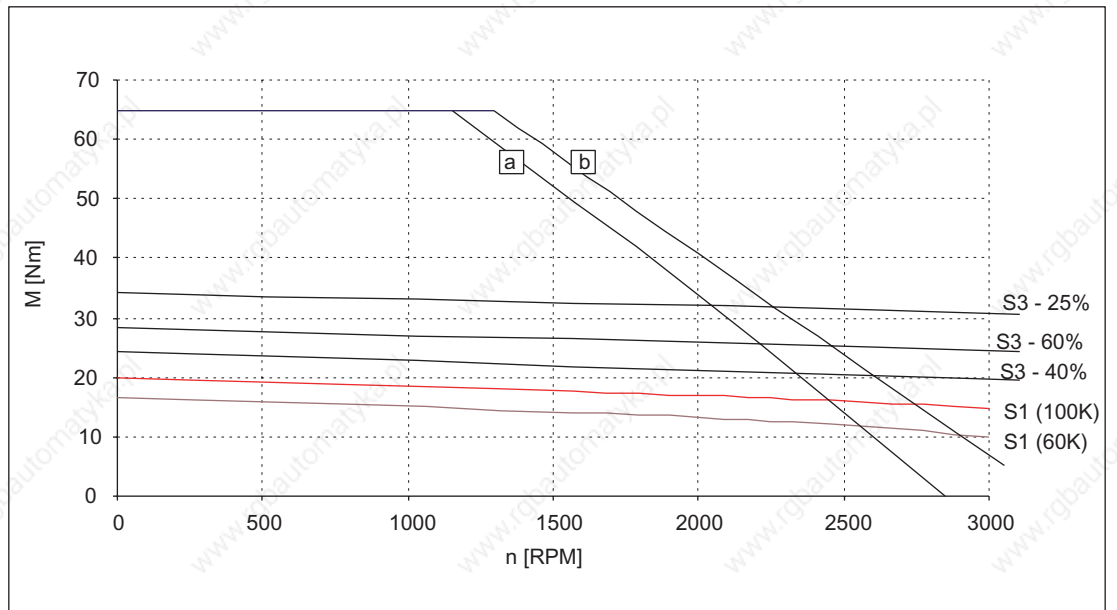

Figure 3-29 Speed-torque diagram 1FT6084-8AC7

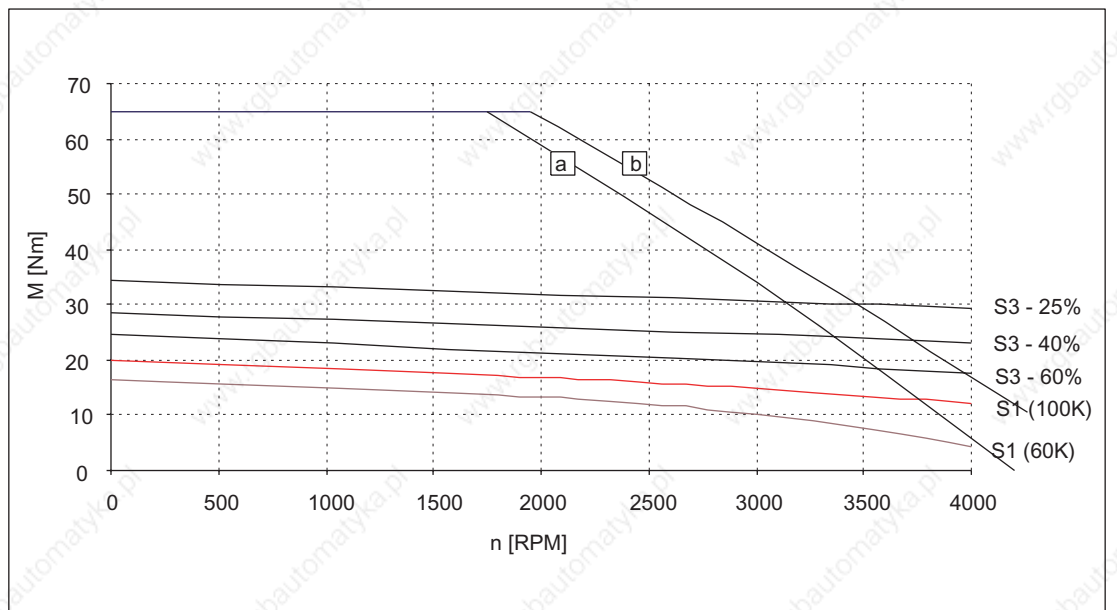

Figure 3-30 Speed-torque diagram 1FT6084-AF7

[a] SINAMICS S120 SMART LINE,  $V_{DC \text{ link}}=540\text{V (DC)}$ ,  $V_{mot}=380\text{V}_{rms}$

[b] SINAMICS S120 ACTIVE LINE,  $V_{DC \text{ link}}=600\text{V (DC)}$ ,  $V_{mot}=425\text{V}_{rms}$

Technical Data and Speed-Torque Diagrams

3.1 Speed-torque diagrams

Table 3-18 1FT6084 non-ventilated

1FT6084					
Technical data	Code	Units	-□AH7□	-□AK7□	
Engineering data					
Rated speed	$n_N$	RPM	4500	6000	
No. of poles	2p		8	8	
Rated torque (100K)	$M_{N(100K)}$	Nm	10.5	6.5	
Rated current (100K)	$I_N(100K)$	A	12.5	9.2	
Stall torque (60K)	$M_0(60K)$	Nm	16.6	16.6	
Stall torque (100K)	$M_0(100K)$	Nm	20	20	
Stall current (60K)	$I_0(60K)$	A	16.2	19.5	
Stall current (100K)	$I_0(100K)$	A	19.8	24.1	
Moment of inertia (with brake)	$J_{mot}$	$10^{-4}$ kgm <sup>2</sup>	61.1	61.1	
Moment of inertia (without brake)	$J_{mot}$	$10^{-4}$ kgm <sup>2</sup>	48	48	
Optimum operating point					
Optimum speed	$n_{opt}$	RPM	4000	4000	
Optimum power	$P_{opt}$	kW	5.03	5.03	
Limiting data					
Max. permissible speed (mech.)	$n_{max}$	RPM	7900	7900	
Max. torque	$M_{max}$	Nm	65	65	
Max. current	$I_{max}$	A	86	100	
Physical constants					
Torque constant	$k_T$	Nm/A	1.01	0.83	
Voltage constant	$k_E$	V/1000 RPM	64	53	
Winding resistance at 20° C	$R_{ph}$	Ohm	0.18	0.12	
Rotating field inductance	$L_D$	mH	2	1.5	
Electrical time constant	$T_{el}$	ms	11.1	12.5	
Shaft torsional stiffness	$C_t$	Nm/rad	76000	76000	
Mechanical time constant	$T_{mech}$	ms	2.5	2.5	
Thermal time constant	$T_{th}$	min	35	35	
Weight with brake	m	kg	24	24	
Weight without brake	m	kg	20.5	20.5	

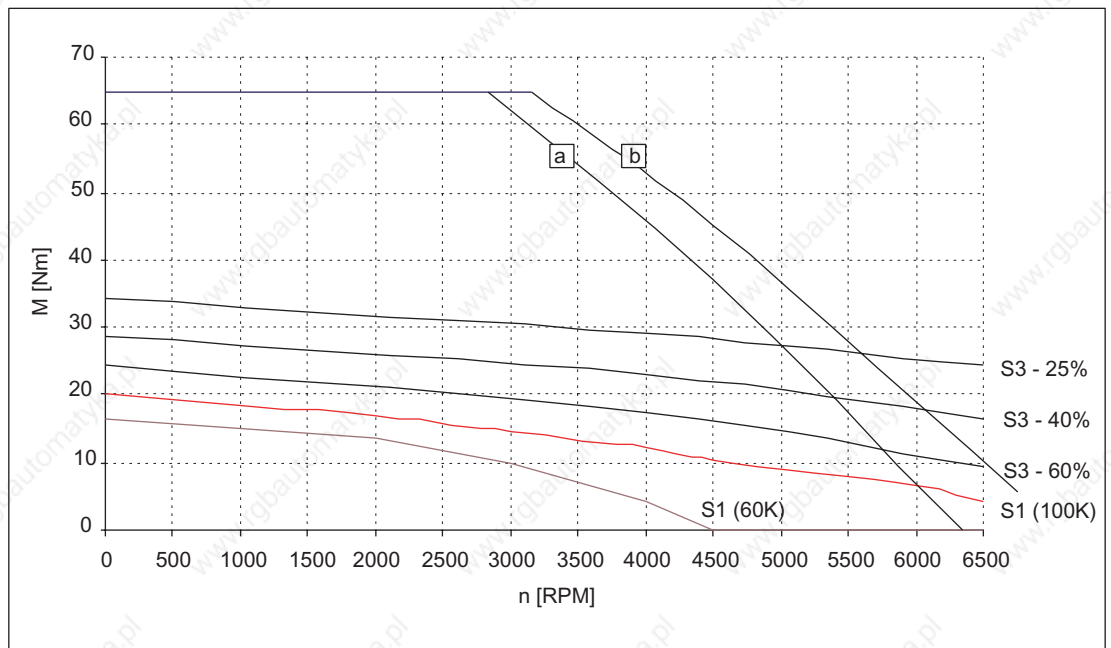

Figure 3-31 Speed-torque diagram 1FT6084-□AH7□

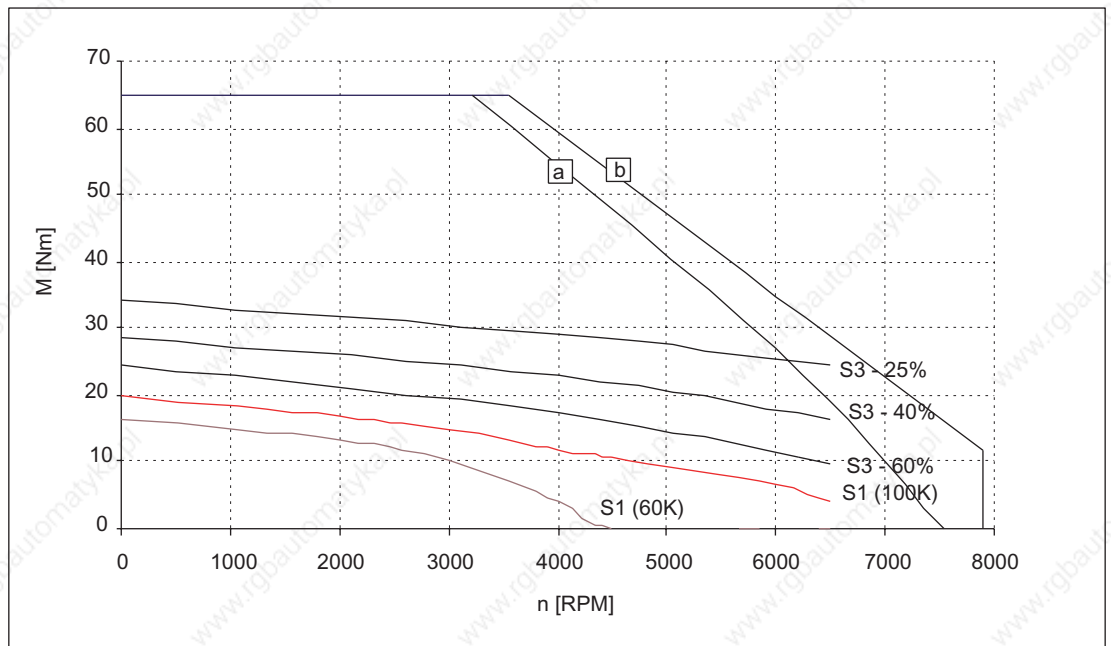

Figure 3-32 Speed-torque diagram 1FT6084-□AK7□

[a] SINAMICS S120 SMART LINE,  $V_{\text{DC link}}=540\text{V (DC)}$ ,  $V_{\text{mot}}=380\text{V}_{\text{rms}}$

[b] SINAMICS S120 ACTIVE LINE,  $V_{\text{DC link}}=600\text{V (DC)}$ ,  $V_{\text{mot}}=425\text{V}_{\text{rms}}$

## Technical Data and Speed-Torque Diagrams

### 3.1 Speed-torque diagrams

Table 3-19 1FT6086 non-ventilated

1FT6086				
Technical data	Code	Units	-8AC7□	
Engineering data				
Rated speed	$n_N$	RPM	2000	
No. of poles	2p		8	
Rated torque (100K)	$M_{N(100K)}$	Nm	22.5	
Rated current (100K)	$I_N(100K)$	A	10.9	
Stall torque (60K)	$M_0(60K)$	Nm	22.4	
Stall torque (100K)	$M_0(100K)$	Nm	27	
Stall current (60K)	$I_0(60K)$	A	9.2	
Stall current (100K)	$I_0(100K)$	A	11.3	
Moment of inertia (with brake)	$J_{mot}$	$10^{-4}$ kgm <sup>2</sup>	79.6	
Moment of inertia (without brake)	$J_{mot}$	$10^{-4}$ kgm <sup>2</sup>	66.5	
Optimum operating point				
Optimum speed	$n_{opt}$	RPM	2000	
Optimum power	$P_{opt}$	kW	4.71	
Limiting data				
Max. permissible speed (mech.)	$n_{max}$	RPM	7900	
Max. torque	$M_{max}$	Nm	90	
Max. current	$I_{max}$	A	48	
Physical constants				
Torque constant	$k_T$	Nm/A	2.39	
Voltage constant	$k_E$	V/1000 RPM	152	
Winding resistance at 20° C	$R_{ph}$	Ohm	0.65	
Rotating field inductance	$L_D$	mH	8	
Electrical time constant	$T_{el}$	ms	12.3	
Shaft torsional stiffness	$C_t$	Nm/rad	65000	
Mechanical time constant	$T_{mech}$	ms	2.3	
Thermal time constant	$T_{th}$	min	45	
Weight with brake	$m$	kg	29	
Weight without brake	$m$	kg	25.5	



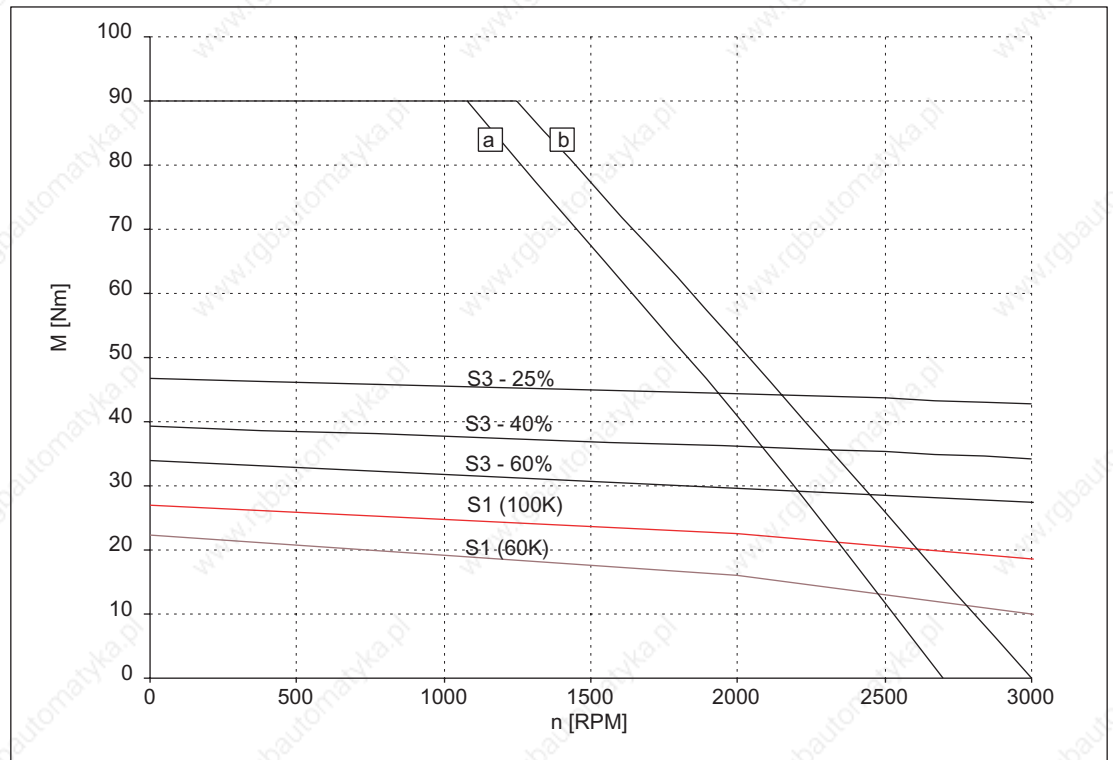

Figure 3-33 Speed-torque diagram 1FT6086-8AC7□

[a] SINAMICS S120 SMART LINE,  $V_{DC\ link}=540V$  (DC),  $V_{mot}=380V_{rms}$

[b] SINAMICS S120 ACTIVE LINE,  $V_{DC\ link}=600V$  (DC),  $V_{mot}=425V_{rms}$

## Technical Data and Speed-Torque Diagrams

### 3.1 Speed-torque diagrams

Table 3-20 1FT6086 non-ventilated

1FT6086					
Technical data	Code	Units	-□AF7□	-□AH7□	
Engineering data					
Rated speed	$n_N$	RPM	3000	4500	
No. of poles	2p		8	8	
Rated torque (100K)	$M_{N(100K)}$	Nm	18.5	12	
Rated current (100K)	$I_N(100K)$	A	13	12.6	
Stall torque (60K)	$M_0(60K)$	Nm	22.4	22.4	
Stall torque (100K)	$M_0(100K)$	Nm	27	27	
Stall current (60K)	$I_0(60K)$	A	13.3	18.9	
Stall current (100K)	$I_0(100K)$	A	16.4	23.3	
Moment of inertia (with brake)	$J_{mot}$	$10^{-4}$ kgm <sup>2</sup>	79.6	79.6	
Moment of inertia (without brake)	$J_{mot}$	$10^{-4}$ kgm <sup>2</sup>	66.5	66.5	
Optimum operating point					
Optimum speed	$n_{opt}$	RPM	3000	3000	
Optimum power	$P_{opt}$	kW	5.81	5.81	
Limiting data					
Max. permissible speed (mech.)	$n_{max}$	RPM	7900	7900	
Max. torque	$M_{max}$	Nm	90	90	
Max. current	$I_{max}$	A	71	102	
Physical constants					
Torque constant	$k_T$	Nm/A	1.65	1.16	
Voltage constant	$k_E$	V/1000 RPM	105	74	
Winding resistance at 20° C	$R_{ph}$	Ohm	0.31	0.15	
Rotating field inductance	$L_D$	mH	3.8	1.8	
Electrical time constant	$T_{el}$	ms	12.3	12	
Shaft torsional stiffness	$C_t$	Nm/rad	65000	65000	
Mechanical time constant	$T_{mech}$	ms	2.3	2.2	
Thermal time constant	$T_{th}$	min	45	45	
Weight with brake	m	kg	29	29	
Weight without brake	m	kg	25.5	25.5	

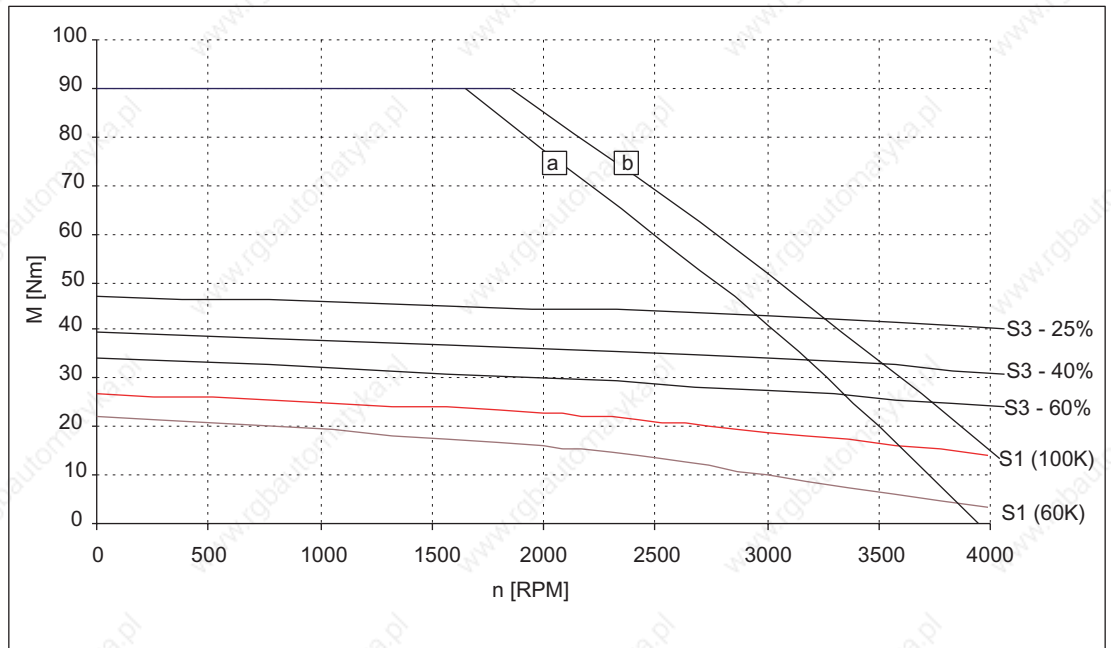

Figure 3-34 Speed-torque diagram 1FT6086-□AF7□

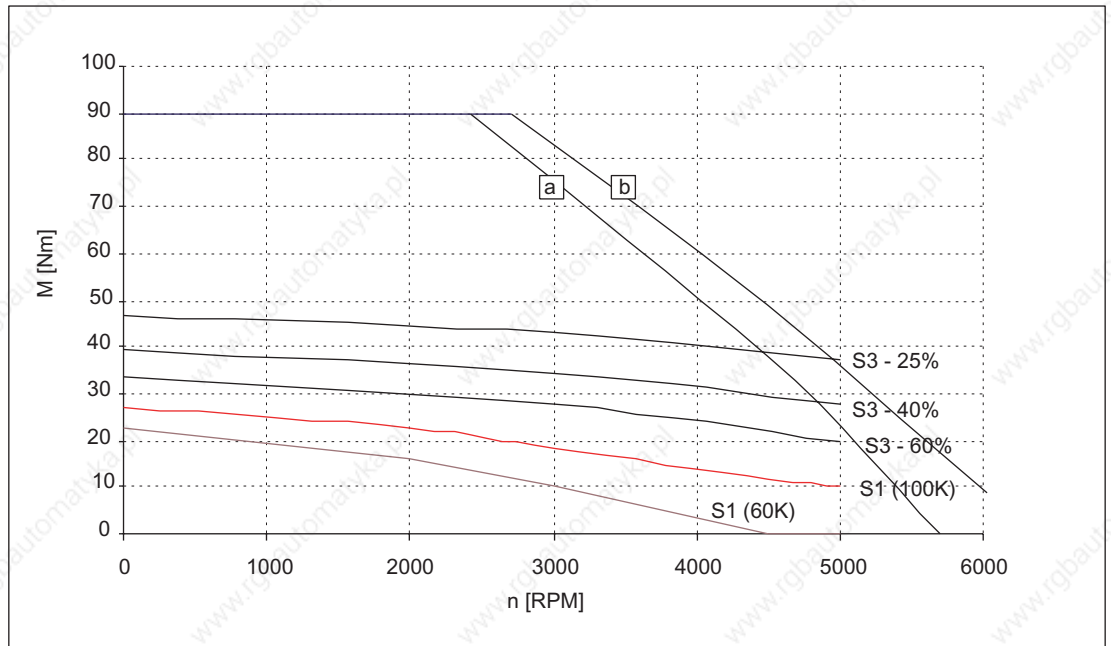

Figure 3-35 Speed-torque diagram 1FT6086-□AH7□

[a] SINAMICS S120 SMART LINE,  $V_{DC\ link}=540V\ (DC)$ ,  $V_{mot}=380V_{rms}$

[b] SINAMICS S120 ACTIVE LINE,  $V_{DC\ link}=600V\ (DC)$ ,  $V_{mot}=425V_{rms}$

## Technical Data and Speed-Torque Diagrams

### 3.1 Speed-torque diagrams

Table 3-21 1FT6102 non-ventilated

1FT6102					
Technical data	Code	Units	-8AB7□	-□AC7□	
Engineering data					
Rated speed	$n_N$	RPM	1500	2000	
No. of poles	2p		8	8	
Rated torque (100K)	$M_{N(100K)}$	Nm	24.5	23	
Rated current (100K)	$I_N(100K)$	A	8.4	11	
Stall torque (60K)	$M_0(60K)$	Nm	22.4	22.4	
Stall torque (100K)	$M_0(100K)$	Nm	27	27	
Stall current (60K)	$I_0(60K)$	A	7.0	9.8	
Stall current (100K)	$I_0(100K)$	A	8.7	12.1	
Moment of inertia (with brake)	$J_{mot}$	$10^{-4}$ kgm <sup>2</sup>	130	130	
Moment of inertia (without brake)	$J_{mot}$	$10^{-4}$ kgm <sup>2</sup>	99	99	
Optimum operating point					
Optimum speed	$n_{opt}$	RPM	1500	2000	
Optimum power	$P_{opt}$	kW	3.85	4.82	
Limiting data					
Max. permissible speed (mech.)	$n_{max}$	RPM	5600	5600	
Max. torque	$M_{max}$	Nm	80	80	
Max. current	$I_{max}$	A	42	59	
Physical constants					
Torque constant	$k_T$	Nm/A	3.11	2.23	
Voltage constant	$k_E$	V/1000 RPM	198	142	
Winding resistance at 20° C	$R_{ph}$	Ohm	0.82	0.42	
Rotating field inductance	$L_D$	mH	15.1	7.7	
Electrical time constant	$T_{el}$	ms	18	18	
Shaft torsional stiffness	$C_t$	Nm/rad	137000	137000	
Mechanical time constant	$T_{mech}$	ms	2.5	2.5	
Thermal time constant	$T_{th}$	min	40	40	
Weight with brake	m	kg	32	32	
Weight without brake	m	kg	27.5	27.5	

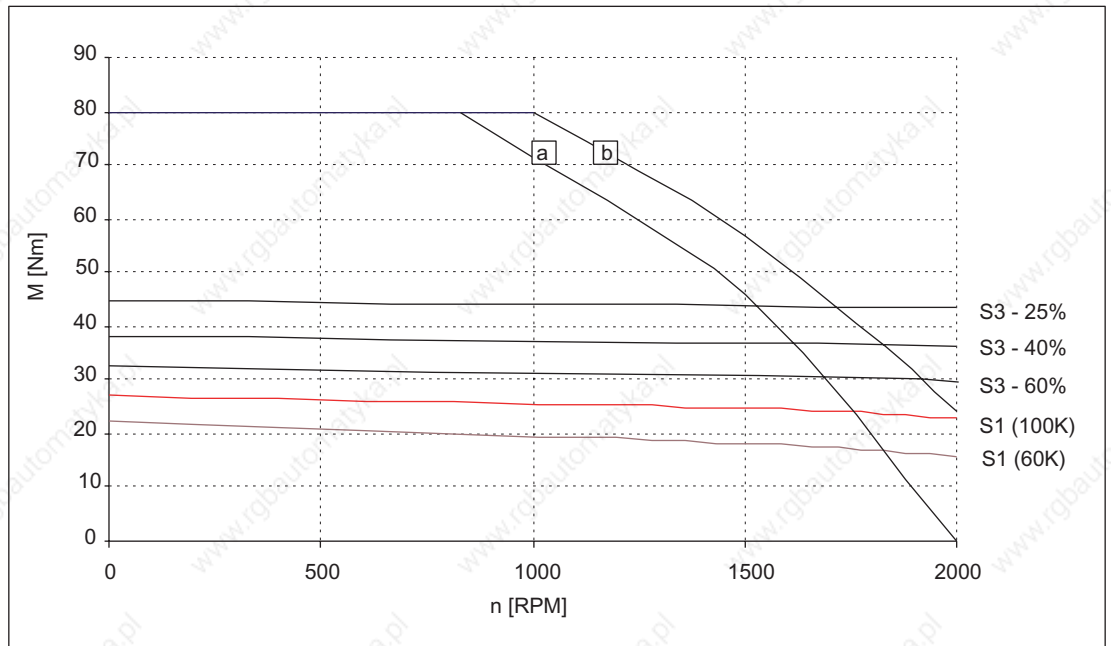

Figure 3-36 Speed-torque diagram 1FT6102-8AB7

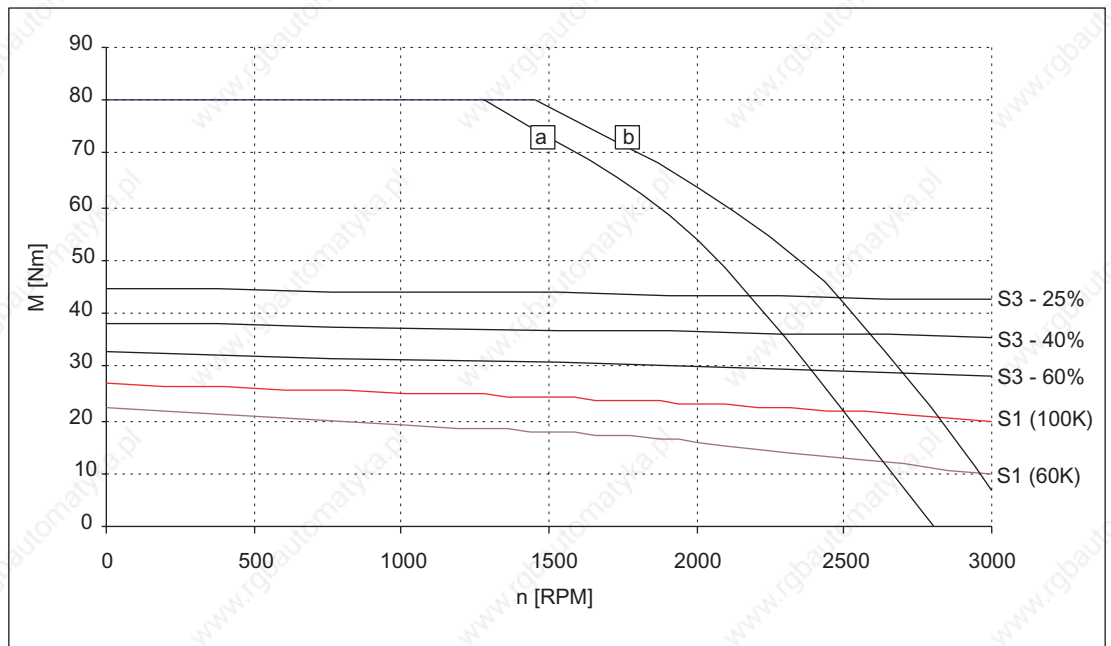

Figure 3-37 Speed-torque diagram 1FT6102-8AC7

[a] SINAMICS S120 SMART LINE,  $V_{DC \text{ link}}=540V$  (DC),  $V_{mot}=380V_{rms}$

[b] SINAMICS S120 ACTIVE LINE,  $V_{DC \text{ link}}=600V$  (DC),  $V_{mot}=425V_{rms}$

## Technical Data and Speed-Torque Diagrams

### 3.1 Speed-torque diagrams

Table 3-22 1FT6102 non-ventilated

1FT6102					
Technical data	Code	Units	-8AF7□	-8AH7□	
Engineering data					
Rated speed	$n_N$	RPM	3000	4500	
No. of poles	2p		8	8	
Rated torque (100K)	$M_{N(100K)}$	Nm	19.5	12	
Rated current (100K)	$I_N(100K)$	A	13.2	12	
Stall torque (60K)	$M_0(60K)$	Nm	22.4	22.4	
Stall torque (100K)	$M_0(100K)$	Nm	27	27	
Stall current (60K)	$I_0(60K)$	A	13.7	19.7	
Stall current (100K)	$I_0(100K)$	A	16.9	24.1	
Moment of inertia (with brake)	$J_{mot}$	$10^{-4}$ kgm <sup>2</sup>	130	130	
Moment of inertia (without brake)	$J_{mot}$	$10^{-4}$ kgm <sup>2</sup>	99	99	
Optimum operating point					
Optimum speed	$n_{opt}$	RPM	3000	3000	
Optimum power	$P_{opt}$	kW	6.13	6.13	
Limiting data					
Max. permissible speed (mech.)	$n_{max}$	RPM	5600	5600	
Max. torque	$M_{max}$	Nm	80	80	
Max. current	$I_{max}$	A	82	118	
Physical constants					
Torque constant	$k_T$	Nm/A	1.60	1.12	
Voltage constant	$k_E$	V/1000 RPM	102	71	
Winding resistance at 20° C	$R_{ph}$	Ohm	0.22	0.11	
Rotating field inductance	$L_D$	mH	4	1.9	
Electrical time constant	$T_{el}$	ms	18	17	
Shaft torsional stiffness	$C_t$	Nm/rad	137000	137000	
Mechanical time constant	$T_{mech}$	ms	2.6	2.6	
Thermal time constant	$T_{th}$	min	40	40	
Weight with brake	m	kg	32	32	
Weight without brake	m	kg	27.5	27.5	

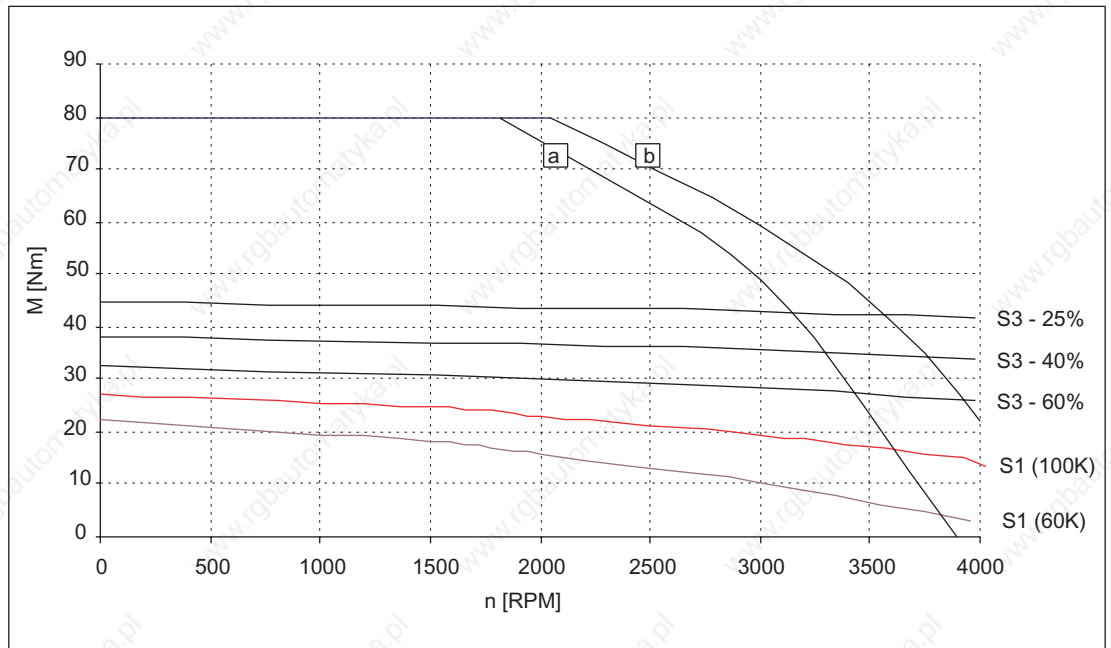

Figure 3-38 Speed-torque diagram 1FT6102-8AF7□

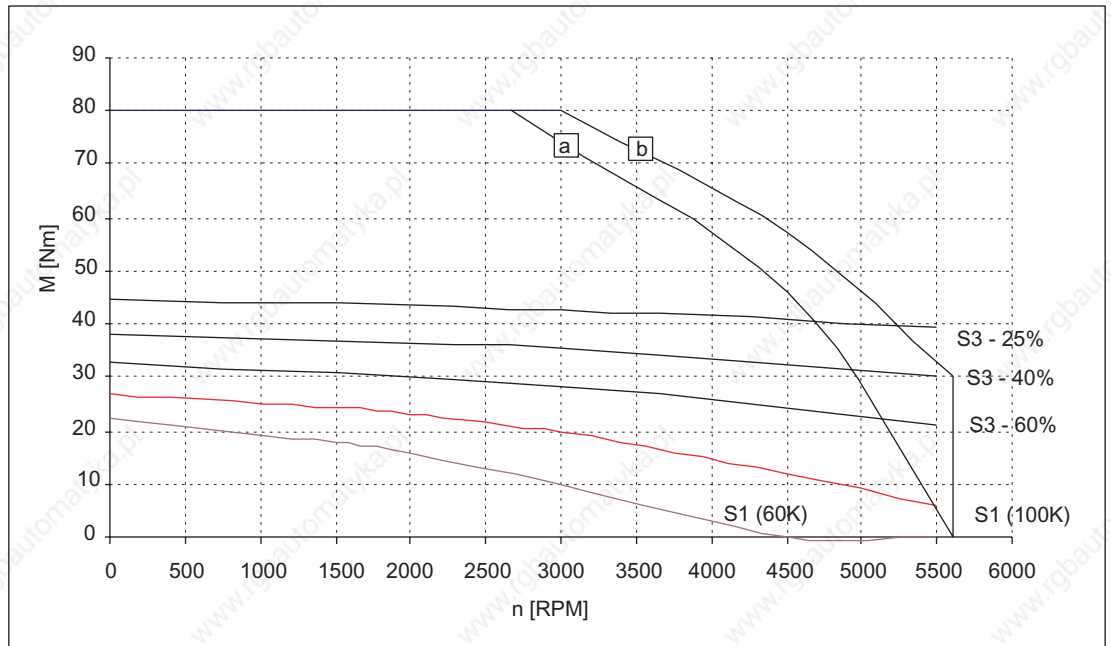

Figure 3-39 Speed-torque diagram 1FT6102-8AH7□

[a] SINAMICS S120 SMART LINE,  $V_{\text{DC link}}=540\text{V}$  (DC),  $V_{\text{mot}}=380\text{V}_{\text{rms}}$

[b] SINAMICS S120 ACTIVE LINE,  $V_{\text{DC link}}=600\text{V}$  (DC),  $V_{\text{mot}}=425\text{V}_{\text{rms}}$

## Technical Data and Speed-Torque Diagrams

### 3.1 Speed-torque diagrams

Table 3-23 1FT6105 non-ventilated

1FT6105					
Technical data	Code	Units	-8AB7□	-□8AH7□	
Engineering data					
Rated speed	$n_N$	RPM	1500	2000	
No. of poles	2p		8	8	
Rated torque (100K)	$M_{N(100K)}$	Nm	41	38	
Rated current (100K)	$I_N(100K)$	A	14.5	17.6	
Stall torque (60K)	$M_0(60K)$	Nm	42	42	
Stall torque (100K)	$M_0(100K)$	Nm	50	50	
Stall current (60K)	$I_0(60K)$	A	13.1	17.6	
Stall current (100K)	$I_0(100K)$	A	16	21.4	
Moment of inertia (with brake)	$J_{mot}$	$10^{-4}$ kgm <sup>2</sup>	199	199	
Moment of inertia (without brake)	$J_{mot}$	$10^{-4}$ kgm <sup>2</sup>	168	168	
Optimum operating point					
Optimum speed	$n_{opt}$	RPM	1500	2000	
Optimum power	$P_{opt}$	kW	6.44	7.96	
Limiting data					
Max. permissible speed (mech.)	$n_{max}$	RPM	5600	5600	
Max. torque	$M_{max}$	Nm	140	140	
Max. current	$I_{max}$	A	77	103	
Physical constants					
Torque constant	$k_T$	Nm/A	3.13	2.34	
Voltage constant	$k_E$	V/1000 RPM	199	149	
Winding resistance at 20° C	$R_{ph}$	Ohm	0.39	0.22	
Rotating field inductance	$L_D$	mH	8.4	4.7	
Electrical time constant	$T_{el}$	ms	22	21	
Shaft torsional stiffness	$C_t$	Nm/rad	113000	113000	
Mechanical time constant	$T_{mech}$	ms	2.0	2.0	
Thermal time constant	$T_{th}$	min	45	45	
Weight with brake	m	kg	44	44	
Weight without brake	m	kg	39.5	39.5	



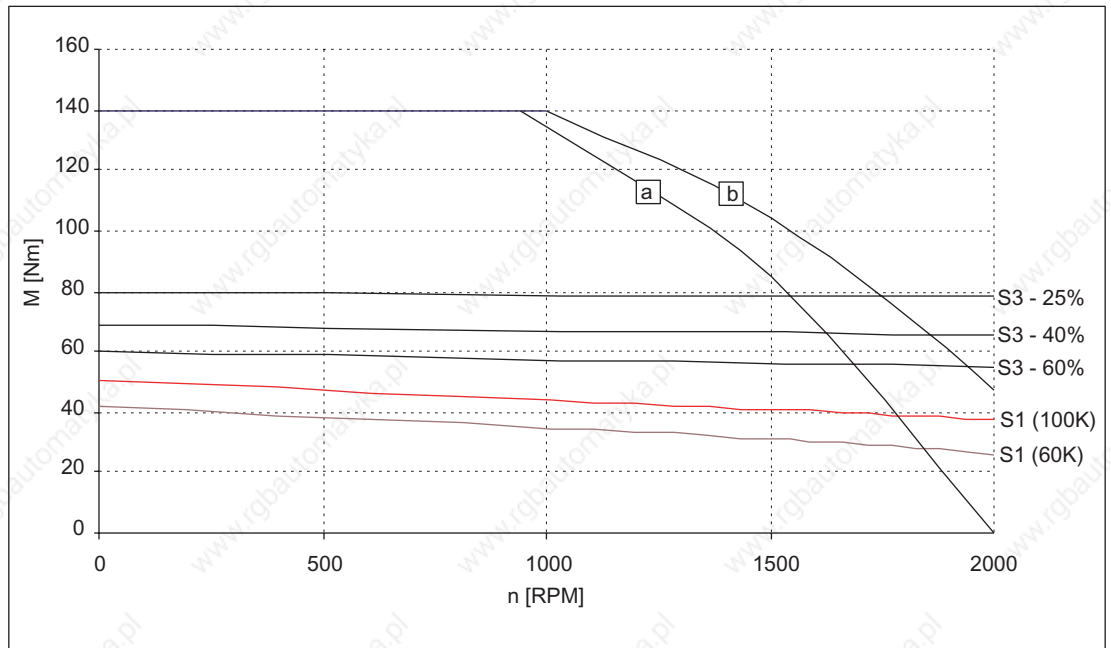

Figure 3-40 Speed-torque diagram 1FT6105-8AB7

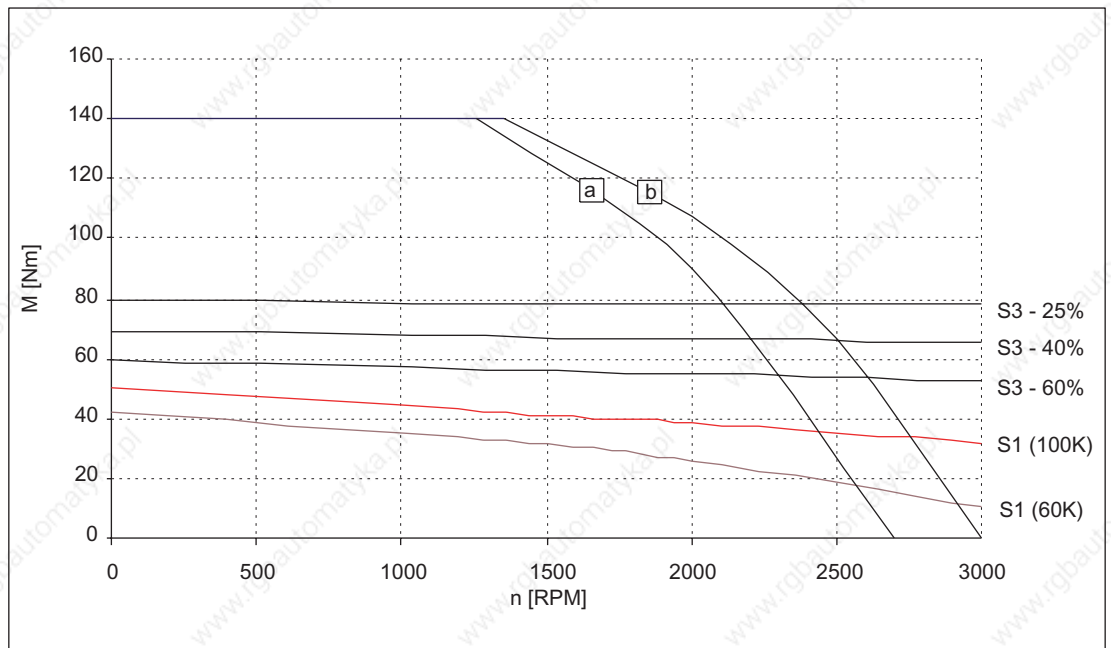

Figure 3-41 Speed-torque diagram 1FT6105-8AC7

[a] SINAMICS S120 SMART LINE,  $V_{DC\ link}=540V$  (DC),  $V_{mot}=380V_{rms}$

[b] SINAMICS S120 ACTIVE LINE,  $V_{DC\ link}=600V$  (DC),  $V_{mot}=425V_{rms}$

## Technical Data and Speed-Torque Diagrams

### 3.1 Speed-torque diagrams

Table 3-24 1FT6105 non-ventilated

1FT6105				
Technical data	Code	Units	-8AF7□	
Engineering data				
Rated speed	$n_N$	RPM	3000	
No. of poles	2p		8	
Rated torque (100K)	$M_{N(100K)}$	Nm	31	
Rated current (100K)	$I_N(100K)$	A	22.5	
Stall torque (60K)	$M_0(60K)$	Nm	42	
Stall torque (100K)	$M_0(100K)$	Nm	50	
Stall current (60K)	$I_0(60K)$	A	26	
Stall current (100K)	$I_0(100K)$	A	32	
Moment of inertia (with brake)	$J_{mot}$	$10^{-4}$ kgm <sup>2</sup>	199	
Moment of inertia (without brake)	$J_{mot}$	$10^{-4}$ kgm <sup>2</sup>	168	
Optimum operating point				
Optimum speed	$n_{opt}$	RPM	3000	
Optimum power	$P_{opt}$	kW	9.74	
Limiting data				
Max. permissible speed (mech.)	$n_{max}$	RPM	5600	
Max. torque	$M_{max}$	Nm	140	
Max. current	$I_{max}$	A	155	
Physical constants				
Torque constant	$k_T$	Nm/A	1.56	
Voltage constant	$k_E$	V/1000 RPM	99	
Winding resistance at 20° C	$R_{ph}$	Ohm	0.098	
Rotating field inductance	$L_D$	mH	2.1	
Electrical time constant	$T_{el}$	ms	21	
Shaft torsional stiffness	$C_t$	Nm/rad	113000	
Mechanical time constant	$T_{mech}$	ms	2.0	
Thermal time constant	$T_{th}$	min	45	
Weight with brake	$m$	kg	44	
Weight without brake	$m$	kg	39.5	

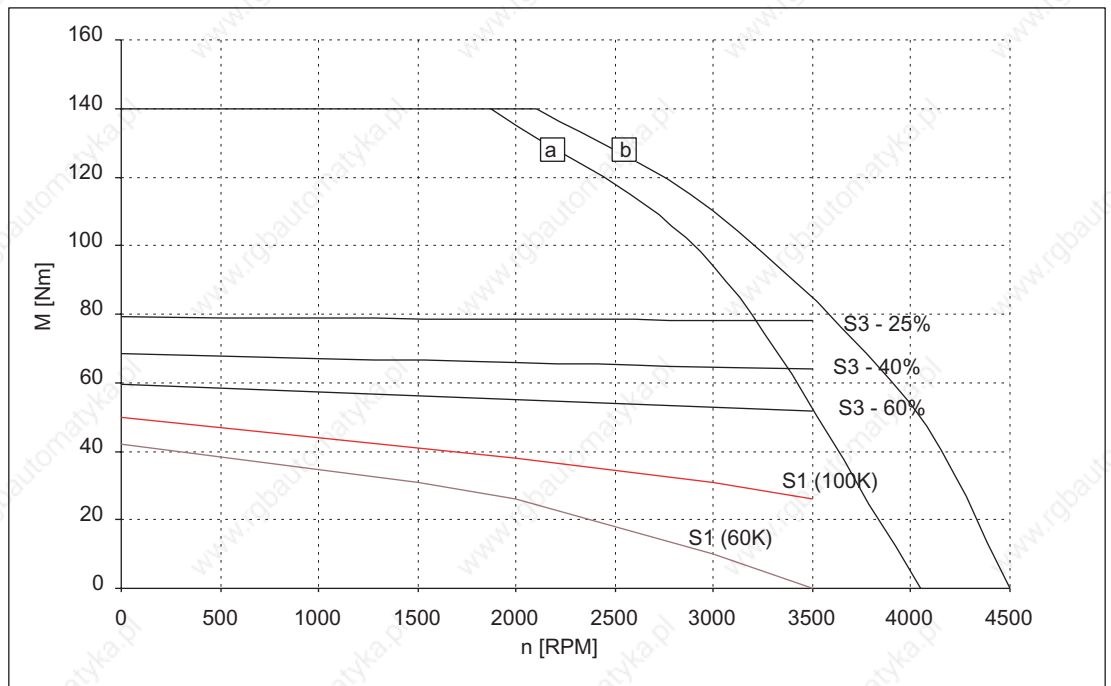

Figure 3-42 Speed-torque diagram 1FT6105-8AF7□

[a] SINAMICS S120 SMART LINE,  $V_{DC\ link}=540V$  (DC),  $V_{mot}=380V_{rms}$

[b] SINAMICS S120 ACTIVE LINE,  $V_{DC\ link}=600V$  (DC),  $V_{mot}=425V_{rms}$

## Technical Data and Speed-Torque Diagrams

### 3.1 Speed-torque diagrams

Table 3-25 1FT6108 non-ventilated

1FT6108					
Technical data	Code	Units	-8AB7□	-8AC7□	
Engineering data					
Rated speed	$n_N$	RPM	1500	2000	
No. of poles	2p		8	8	
Rated torque (100K)	$M_{N(100K)}$	Nm	61	55	
Rated current (100K)	$I_N(100K)$	A	20.5	24.5	
Stall torque (60K)	$M_0(60K)$	Nm	58	58	
Stall torque (100K)	$M_0(100K)$	Nm	70	70	
Stall current (60K)	$I_0(60K)$	A	18.1	23.5	
Stall current (100K)	$I_0(100K)$	A	22.3	29	
Moment of inertia (with brake)	$J_{mot}$	$10^{-4}$ kgm <sup>2</sup>	291	291	
Moment of inertia (without brake)	$J_{mot}$	$10^{-4}$ kgm <sup>2</sup>	260	260	
Optimum operating point					
Optimum speed	$n_{opt}$	RPM	1500	2000	
Optimum power	$P_{opt}$	kW	9.58	11.5	
Limiting data					
Max. permissible speed (mech.)	$n_{max}$	RPM	5600	5600	
Max. torque	$M_{max}$	Nm	220	220	
Max. current	$I_{max}$	A	107	139	
Physical constants					
Torque constant	$k_T$	Nm/A	3.14	2.42	
Voltage constant	$k_E$	V/1000 RPM	200	154	
Winding resistance at 20° C	$R_{ph}$	Ohm	0.22	0.13	
Rotating field inductance	$L_D$	mH	5.2	3.1	
Electrical time constant	$T_{el}$	ms	24	24	
Shaft torsional stiffness	$C_t$	Nm/rad	92000	92000	
Mechanical time constant	$T_{mech}$	ms	1.7	1.7	
Thermal time constant	$T_{th}$	min	55	55	
Weight with brake	m	kg	60	60	
Weight without brake	m	kg	55.5	55.5	

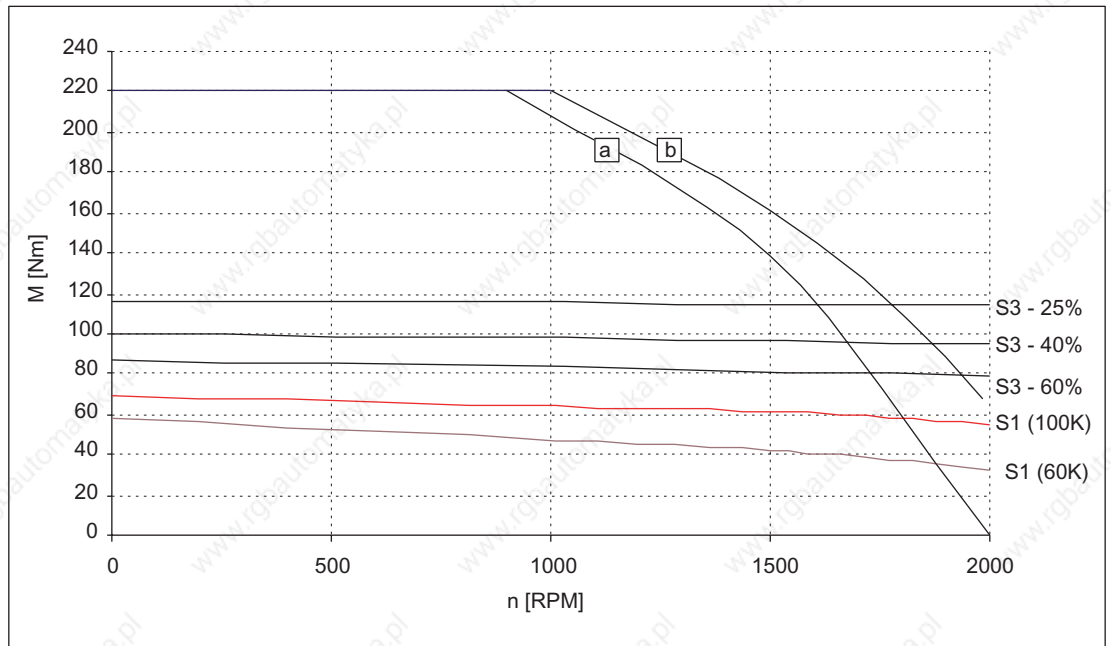

Figure 3-43 Speed-torque diagram 1FT6108-8AB7

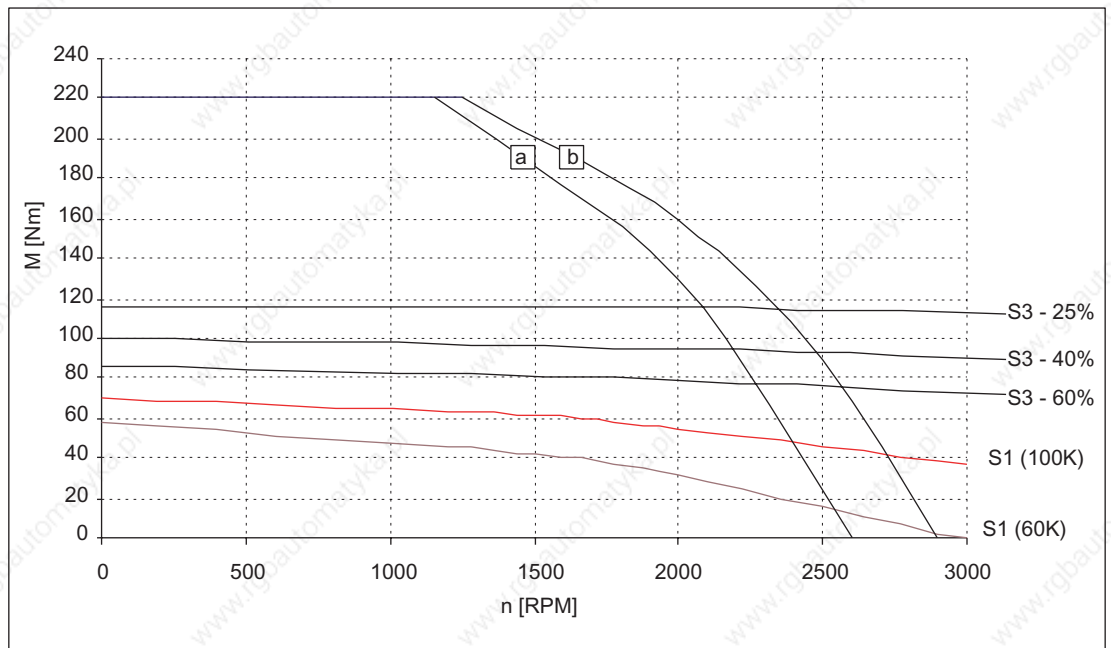

Figure 3-44 Speed-torque diagram 1FT6108-8AC7

[a] SINAMICS S120 SMART LINE,  $V_{DC \text{ link}}=540V$  (DC),  $V_{mot}=380V_{rms}$

[b] SINAMICS S120 ACTIVE LINE,  $V_{DC \text{ link}}=600V$  (DC),  $V_{mot}=425V_{rms}$

## Technical Data and Speed-Torque Diagrams

### 3.1 Speed-torque diagrams

Table 3-26 1FT6108 non-ventilated

1FT6108				
Technical data	Code	Units	-8AF7□	
Engineering data				
Rated speed	$n_N$	RPM	3000	
No. of poles	2p		8	
Rated torque (100K)	$M_{N(100K)}$	Nm	37	
Rated current (100K)	$I_N(100K)$	A	25	
Stall torque (60K)	$M_0(60K)$	Nm	58	
Stall torque (100K)	$M_0(100K)$	Nm	70	
Stall current (60K)	$I_0(60K)$	A	33	
Stall current (100K)	$I_0(100K)$	A	41	
Moment of inertia (with brake)	$J_{mot}$	$10^{-4}$ kgm <sup>2</sup>	291	
Moment of inertia (without brake)	$J_{mot}$	$10^{-4}$ kgm <sup>2</sup>	260	
Optimum operating point				
Optimum speed	$n_{opt}$	RPM	2500	
Optimum power	$P_{opt}$	kW	12.0	
Limiting data				
Max. permissible speed (mech.)	$n_{max}$	RPM	5600	
Max. torque	$M_{max}$	Nm	220	
Max. current	$I_{max}$	A	198	
Physical constants				
Torque constant	$k_T$	Nm/A	1.70	
Voltage constant	$k_E$	V/1000 RPM	108	
Winding resistance at 20° C	$R_{ph}$	Ohm	0.065	
Rotating field inductance	$L_D$	mH	1.5	
Electrical time constant	$T_{el}$	ms	23	
Shaft torsional stiffness	$C_t$	Nm/rad	92000	
Mechanical time constant	$T_{mech}$	ms	1.8	
Thermal time constant	$T_{th}$	min	55	
Weight with brake	$m$	kg	60	
Weight without brake	$m$	kg	55.5	

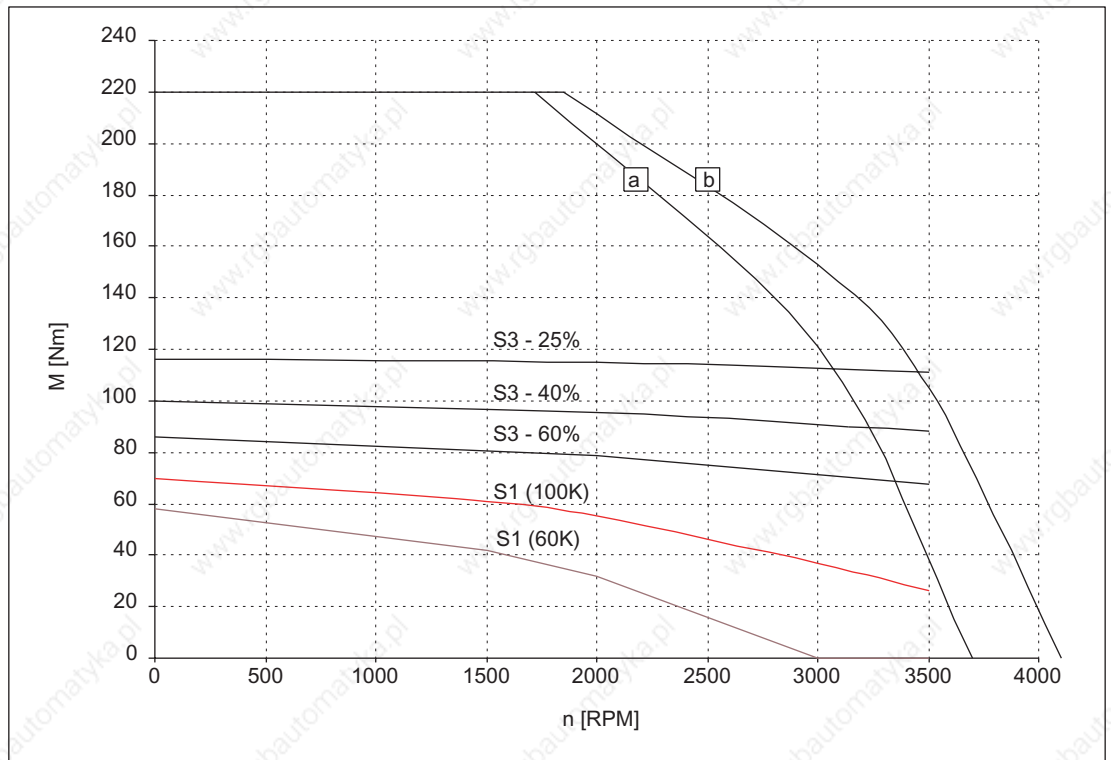

Figure 3-45 Speed-torque diagram 1FT6108-8AF7□

[a] SINAMICS S120 SMART LINE,  $V_{DC\ link}=540V$  (DC),  $V_{mot}=380V_{rms}$

[b] SINAMICS S120 ACTIVE LINE,  $V_{DC\ link}=600V$  (DC),  $V_{mot}=425V_{rms}$

## Technical Data and Speed-Torque Diagrams

### 3.1 Speed-torque diagrams

Table 3-27 1FT6132 non-ventilated

1FT6132					
Technical data	Code	Units	-6AB71	-6AC71	
Engineering data					
Rated speed	$n_N$	RPM	1500	2000	
No. of poles	2p		6	6	
Rated torque (100K)	$M_{N(100K)}$	Nm	62	55	
Rated current (100K)	$I_N(100K)$	A	19	23	
Stall torque (60K)	$M_0(60K)$	Nm	62	62	
Stall torque (100K)	$M_0(100K)$	Nm	75	75	
Stall current (60K)	$I_0(60K)$	A	17.4	23.1	
Stall current (100K)	$I_0(100K)$	A	21.6	29	
Moment of inertia (with brake)	$J_{mot}$	$10^{-4}$ kgm <sup>2</sup>	508	508	
Moment of inertia (without brake)	$J_{mot}$	$10^{-4}$ kgm <sup>2</sup>	430	430	
Optimum operating point					
Optimum speed	$n_{opt}$	RPM	1500	2000	
Optimum power	$P_{opt}$	kW	9.74	11.5	
Limiting data					
Max. permissible speed (mech.)	$n_{max}$	RPM	3600	3600	
Max. torque	$M_{max}$	Nm	248	248	
Max. current	$I_{max}$	A	96	128	
Physical constants					
Torque constant	$k_T$	Nm/A	3.48	2.61	
Voltage constant	$k_E$	V/1000 RPM	224	168	
Winding resistance at 20° C	$R_{ph}$	Ohm	0.23	0.13	
Rotating field inductance	$L_D$	mH	7.4	4.15	
Electrical time constant	$T_{el}$	ms	37	36	
Shaft torsional stiffness	$C_t$	Nm/rad	258000	258000	
Mechanical time constant	$T_{mech}$	ms	2.4	2.5	
Thermal time constant	$T_{th}$	min	65	65	
Weight with brake	m	kg	95	95	
Weight without brake	m	kg	85.0	85.0	



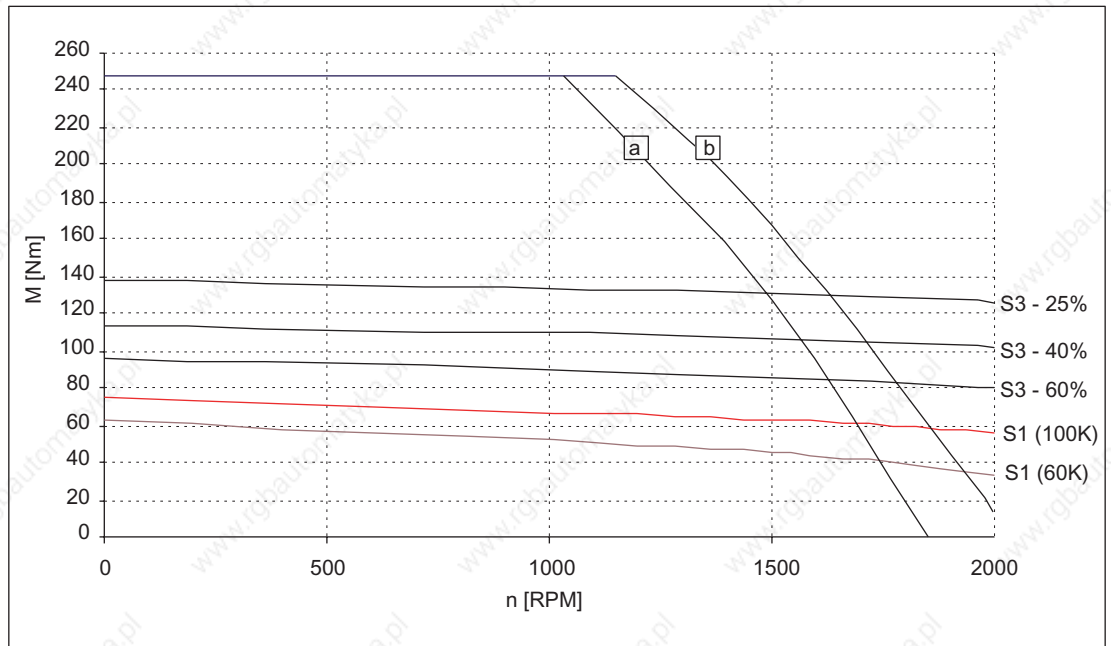

Figure 3-46 Speed-torque diagram 1FT6132-6AB71

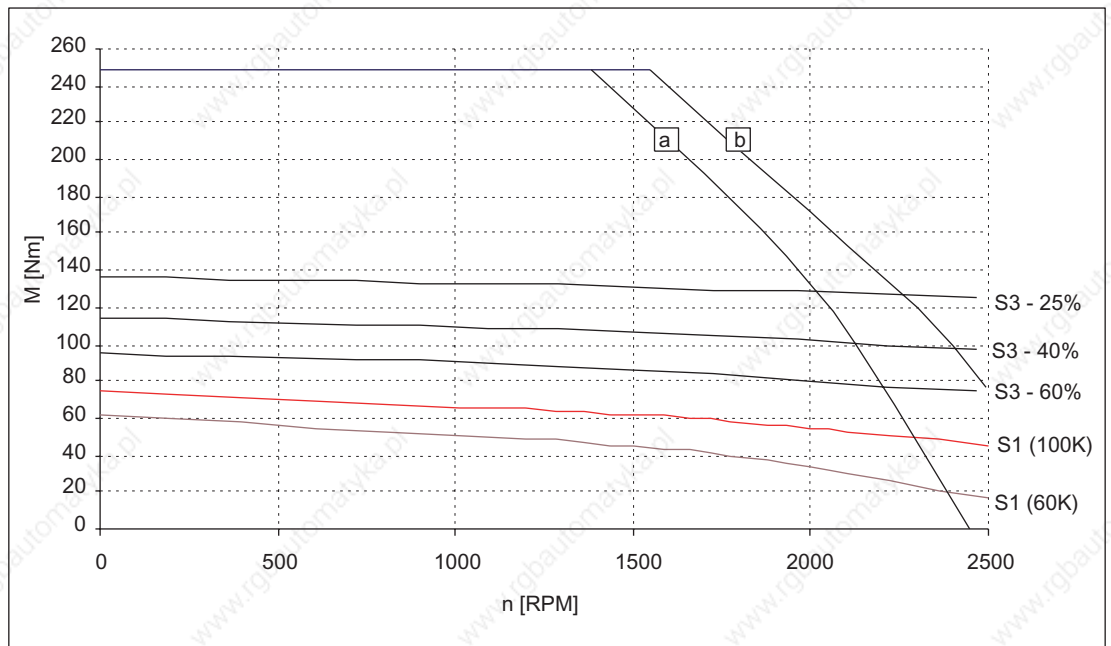

Figure 3-47 Speed-torque diagram 1FT6132-6AC71

[a] SINAMICS S120 SMART LINE,  $V_{DC \text{ link}}=540V$  (DC),  $V_{mot}=380V_{rms}$

[b] SINAMICS S120 ACTIVE LINE,  $V_{DC \text{ link}}=600V$  (DC),  $V_{mot}=425V_{rms}$

## Technical Data and Speed-Torque Diagrams

### 3.1 Speed-torque diagrams

Table 3-28 1FT6132 non-ventilated

1FT6132				
Technical data	Code	Units	-6AF71	
Engineering data				
Rated speed	$n_N$	RPM	3000	
No. of poles	2p		6	
Rated torque (100K)	$M_{N(100K)}$	Nm	36	
Rated current (100K)	$I_N(100K)$	A	23	
Stall torque (60K)	$M_0(60K)$	Nm	62	
Stall torque (100K)	$M_0(100K)$	Nm	75	
Stall current (60K)	$I_0(60K)$	A	35	
Stall current (100K)	$I_0(100K)$	A	43	
Moment of inertia (with brake)	$J_{mot}$	$10^{-4}$ kgm <sup>2</sup>	508	
Moment of inertia (without brake)	$J_{mot}$	$10^{-4}$ kgm <sup>2</sup>	430	
Optimum operating point				
Optimum speed	$n_{opt}$	RPM	2500	
Optimum power	$P_{opt}$	kW	12.0	
Limiting data				
Max. permissible speed (mech.)	$n_{max}$	RPM	3600	
Max. torque	$M_{max}$	Nm	248	
Max. current	$I_{max}$	A	192	
Physical constants				
Torque constant	$k_T$	Nm/A	1.74	
Voltage constant	$k_E$	V/1000 RPM	112	
Winding resistance at 20° C	$R_{ph}$	Ohm	0.057	
Rotating field inductance	$L_D$	mH	1.85	
Electrical time constant	$T_{el}$	ms	37	
Shaft torsional stiffness	$C_t$	Nm/rad	258000	
Mechanical time constant	$T_{mech}$	ms	2.4	
Thermal time constant	$T_{th}$	min	65	
Weight with brake	$m$	kg	95	
Weight without brake	$m$	kg	85.0	

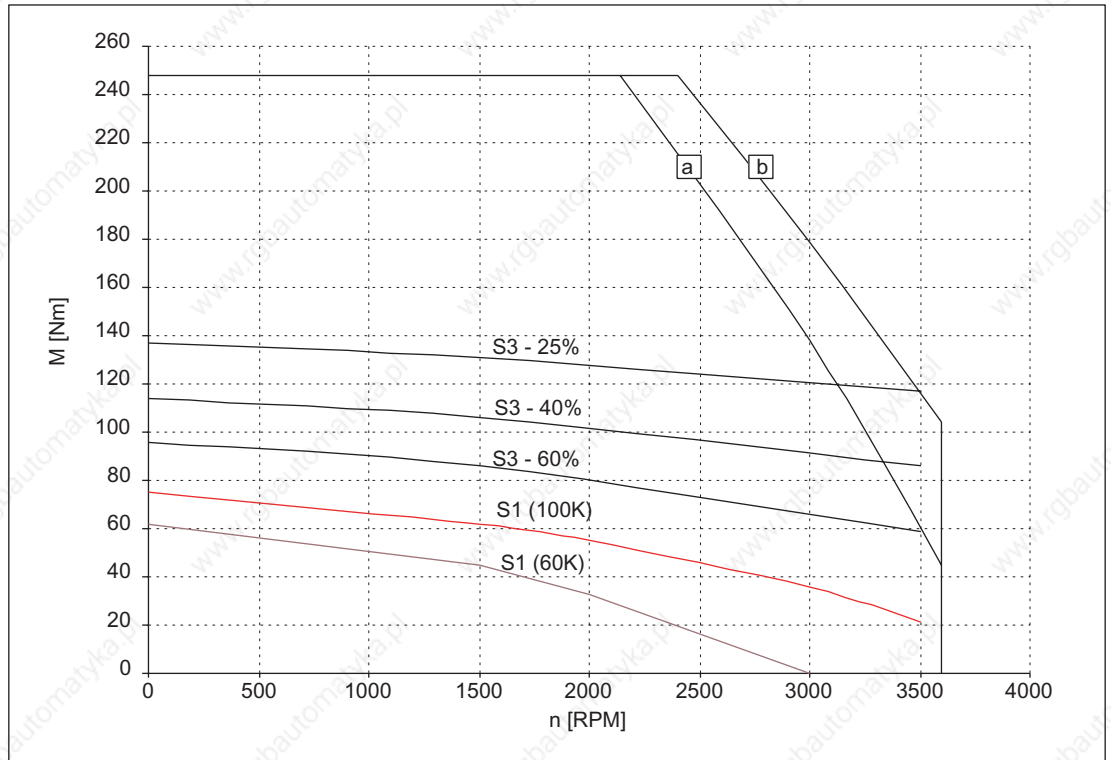

Figure 3-48 Speed-torque diagram 1FT6132-6AF71

[a] SINAMICS S120 SMART LINE,  $V_{\text{DC link}}=540\text{V (DC)}$ ,  $V_{\text{mot}}=380\text{V}_{\text{rms}}$

[b] SINAMICS S120 ACTIVE LINE,  $V_{\text{DC link}}=600\text{V (DC)}$ ,  $V_{\text{mot}}=425\text{V}_{\text{rms}}$

## Technical Data and Speed-Torque Diagrams

### 3.1 Speed-torque diagrams

Table 3-29 1FT6134 non-ventilated

1FT6134					
Technical data	Code	Units	-6AB71	-6AC71	
Engineering data					
Rated speed	$n_N$	RPM	1500	2000	
No. of poles	2p		6	6	
Rated torque (100K)	$M_{N(100K)}$	Nm	75	65	
Rated current (100K)	$I_N(100K)$	A	24	27	
Stall torque (60K)	$M_0(60K)$	Nm	79	79	
Stall torque (100K)	$M_0(100K)$	Nm	95	95	
Stall current (60K)	$I_0(60K)$	A	21.7	30	
Stall current (100K)	$I_0(100K)$	A	27	36	
Moment of inertia (with brake)	$J_{mot}$	$10^{-4}$ kgm <sup>2</sup>	625	625	
Moment of inertia (without brake)	$J_{mot}$	$10^{-4}$ kgm <sup>2</sup>	547	547	
Optimum operating point					
Optimum speed	$n_{opt}$	RPM	1500	2000	
Optimum power	$P_{opt}$	kW	11.8	13.6	
Limiting data					
Max. permissible speed (mech.)	$n_{max}$	RPM	3600	3600	
Max. torque	$M_{max}$	Nm	316	316	
Max. current	$I_{max}$	A	125	170	
Physical constants					
Torque constant	$k_T$	Nm/A	3.54	2.61	
Voltage constant	$k_E$	V/1000 RPM	228	168	
Winding resistance at 20° C	$R_{ph}$	Ohm	0.17	0.094	
Rotating field inductance	$L_D$	mH	5.8	3.1	
Electrical time constant	$T_{el}$	ms	34	33	
Shaft torsional stiffness	$C_t$	Nm/rad	234000	234000	
Mechanical time constant	$T_{mech}$	ms	2.2	2.3	
Thermal time constant	$T_{th}$	min	70	70	
Weight with brake	m	kg	110	110	
Weight without brake	m	kg	100	100	

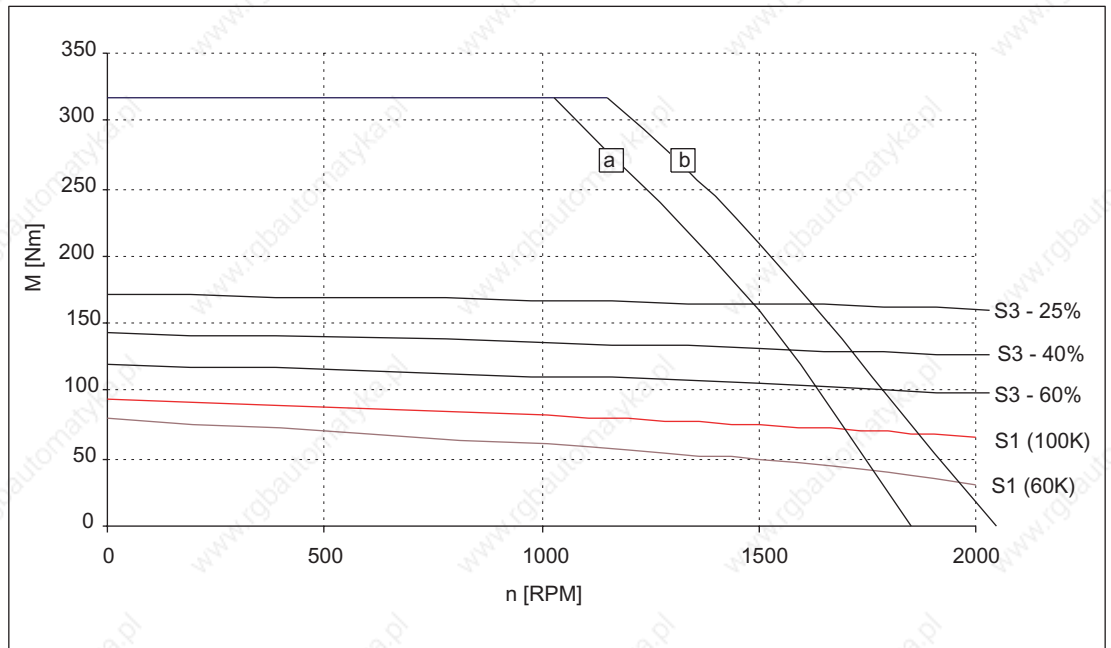

Figure 3-49 Speed-torque diagram 1FT6134-6AB71

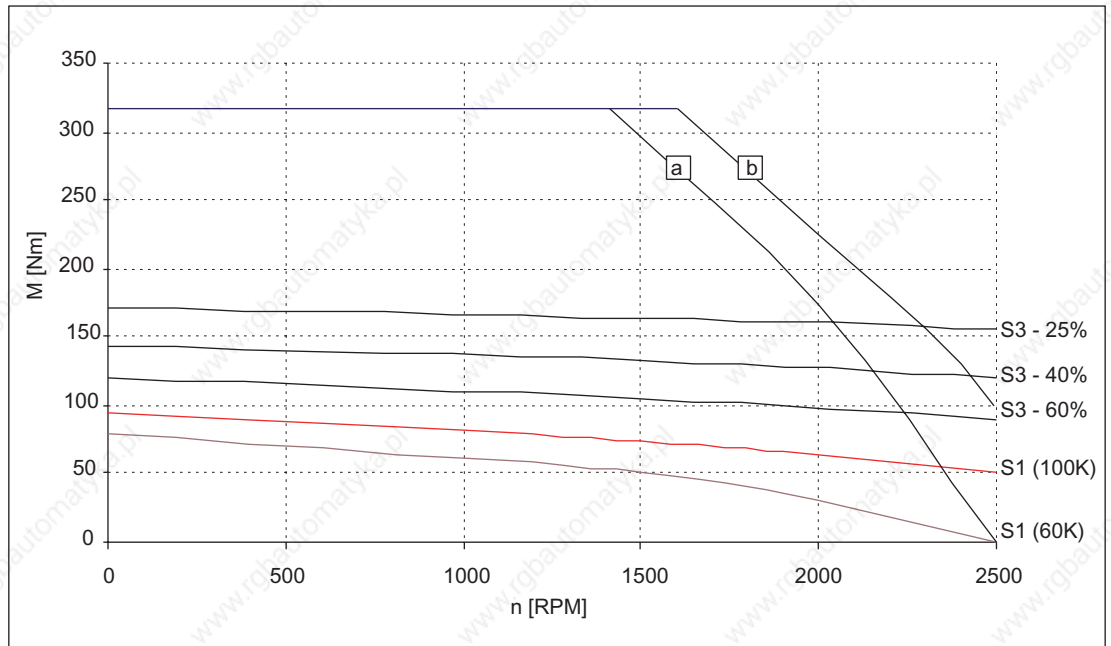

Figure 3-50 Speed-torque diagram 1FT6134-6AC71

[a] SINAMICS S120 SMART LINE,  $V_{DC \text{ link}}=540V$  (DC),  $V_{mot}=380V_{rms}$

[b] SINAMICS S120 ACTIVE LINE,  $V_{DC \text{ link}}=600V$  (DC),  $V_{mot}=425V_{rms}$

## Technical Data and Speed-Torque Diagrams

### 3.1 Speed-torque diagrams

Table 3-30 1FT6136 non-ventilated

1FT6136					
Technical data	Code	Units	-6AB71	-6AC7□	
Engineering data					
Rated speed	$n_N$	RPM	1500	2000	
No. of poles	2p		6	6	
Rated torque (100K)	$M_{N(100K)}$	Nm	88	74	
Rated current (100K)	$I_N(100K)$	A	27	30	
Stall torque (60K)	$M_0(60K)$	Nm	95	95	
Stall torque (100K)	$M_0(100K)$	Nm	115	115	
Stall current (60K)	$I_0(60K)$	A	27	34	
Stall current (100K)	$I_0(100K)$	A	34	42	
Moment of inertia (with brake)	$J_{mot}$	$10^{-4}$ kgm <sup>2</sup>	742	742	
Moment of inertia (without brake)	$J_{mot}$	$10^{-4}$ kgm <sup>2</sup>	664	664	
Optimum operating point					
Optimum speed	$n_{opt}$	RPM	1500	2000	
Optimum power	$P_{opt}$	kW	13.8	15.5	
Limiting data					
Max. permissible speed (mech.)	$n_{max}$	RPM	3600	3600	
Max. torque	$M_{max}$	Nm	380	380	
Max. current	$I_{max}$	A	146	183	
Physical constants					
Torque constant	$k_T$	Nm/A	3.40	2.72	
Voltage constant	$k_E$	V/1000 RPM	219	175	
Winding resistance at 20° C	$R_{ph}$	Ohm	0.12	0.075	
Rotating field inductance	$L_D$	mH	4.4	2.8	
Electrical time constant	$T_{el}$	ms	41	41	
Shaft torsional stiffness	$C_t$	Nm/rad	214000	214000	
Mechanical time constant	$T_{mech}$	ms	2.1	2.0	
Thermal time constant	$T_{th}$	min	75	75	
Weight with brake	m	kg	125	125	
Weight without brake	m	kg	117	117	

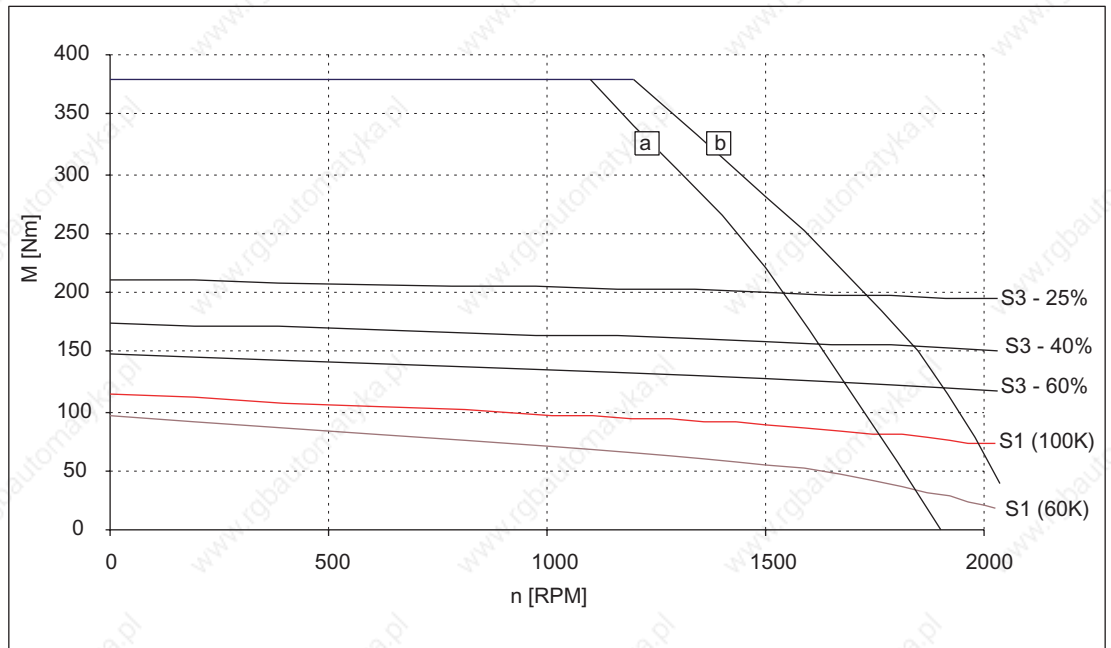

Figure 3-51 Speed-torque diagram 1FT6136-6AB71

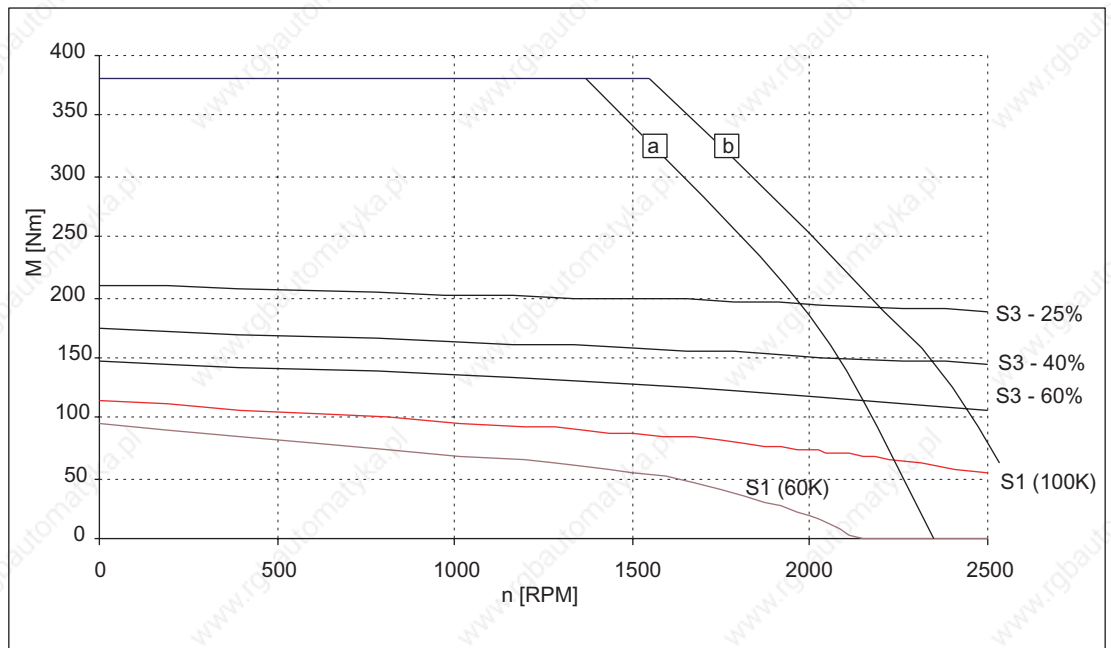

Figure 3-52 Speed-torque diagram 1FT6136-6AC7

[a] SINAMICS S120 SMART LINE,  $V_{DC \text{ link}}=540V$  (DC),  $V_{mot}=380V_{rms}$

[b] SINAMICS S120 ACTIVE LINE,  $V_{DC \text{ link}}=600V$  (DC),  $V_{mot}=425V_{rms}$

3.1 Speed-torque diagrams

3.1.3 1FT6 series, force ventilated

Table 3-31 1FT6084 force ventilated

1FT6084				
Technical data	Code	Units	-8SF7□	
Engineering data				
Rated speed	$n_N$	RPM	3000	
No. of poles	2p		8	
Rated torque (100K)	$M_{N(100K)}$	Nm	22.0	
Rated current (100K)	$I_N(100K)$	A	17.0	
Stall torque (60K)	$M_0(60K)$	Nm	21.6	
Stall torque (100K)	$M_0(100K)$	Nm	26.0	
Stall current (60K)	$I_0(60K)$	A	14.8	
Stall current (100K)	$I_0(100K)$	A	18.2	
Moment of inertia (with brake)	$J_{mot}$	$10^{-4}$ kgm <sup>2</sup>	61.1	
Moment of inertia (without brake)	$J_{mot}$	$10^{-4}$ kgm <sup>2</sup>	48.0	
Optimum operating point				
Optimum speed	$N_{opt}$	RPM	3000	
Optimum power	$P_{opt}$	kW	6.91	
Limiting data				
Max. permissible speed (mech.)	$N_{max}$	RPM	7900	
Max. torque	$M_{max}$	Nm	65	
Max. current	$I_{max}$	A	59	
Physical constants				
Torque constant	$k_t$	Nm/A	1.43	
Voltage constant	$k_E$	V/1000 RPM	91	
Winding resistance at 20° C	$R_{ph}$	Ohm	0.37	
Rotating field inductance	$L_D$	mH	4.3	
Electrical time constant	$T_{el}$	ms	11.6	
Shaft torsional stiffness	$C_t$	Nm/rad	76000	
Mechanical time constant	$T_{mech}$	ms	2.6	
Thermal time constant	$T_{th}$	min	15	
Weight with brake	$m$	kg	28.5	
Weight without brake	$m$	kg	25.0	



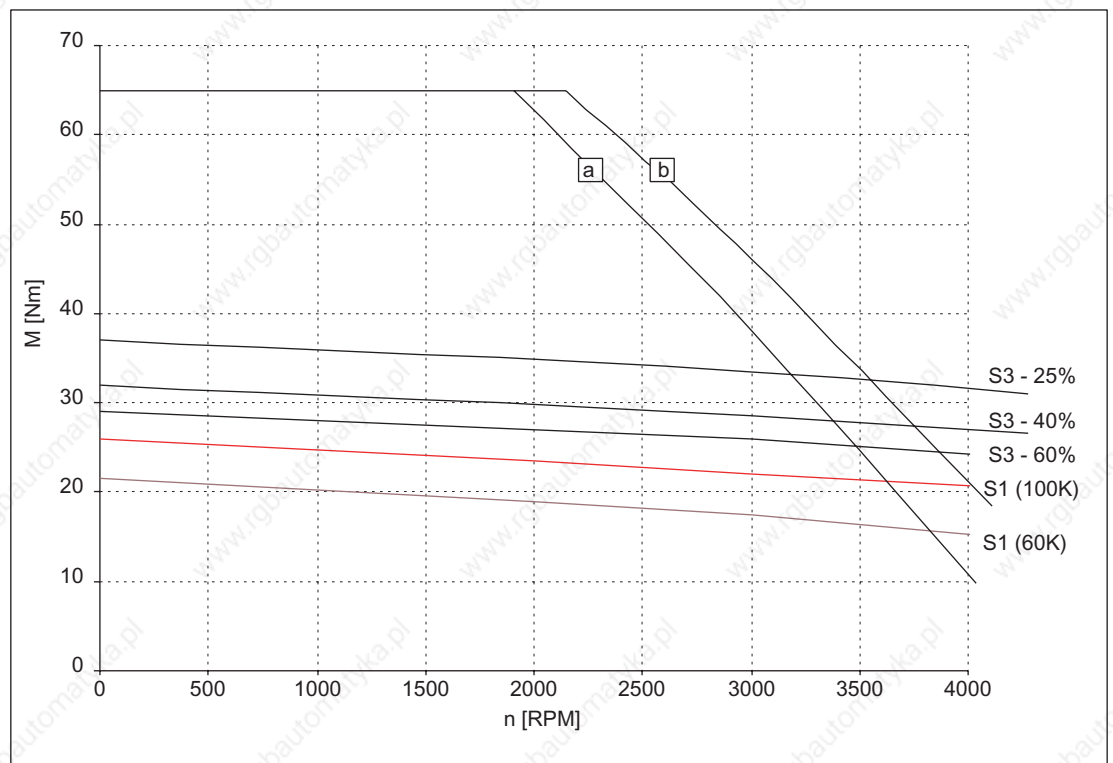

Figure 3-53 Speed-torque diagram 1FT6084-8SF7□

[a] SINAMICS S120 SMART LINE,  $V_{\text{DC link}}=540\text{V (DC)}$ ,  $V_{\text{mot}}=380\text{V}_{\text{rms}}$

[b] SINAMICS S120 ACTIVE LINE,  $V_{\text{DC link}}=600\text{V (DC)}$ ,  $V_{\text{mot}}=425\text{V}_{\text{rms}}$

## Technical Data and Speed-Torque Diagrams

### 3.1 Speed-torque diagrams

Table 3-32 1FT6084 force ventilated

1FT6084					
Technical data	Code	Units	-8SH7□	-8SK7□	
Engineering data					
Rated speed	$n_N$	RPM	4500	6000	
No. of poles	2p		8	8	
Rated torque (100K)	$M_{N(100K)}$	Nm	20.0	17.0	
Rated current (100K)	$I_N(100K)$	A	24.5	25.5	
Stall torque (60K)	$M_0(60K)$	Nm	21.6	21.6	
Stall torque (100K)	$M_0(100K)$	Nm	26.0	26.0	
Stall current (60K)	$I_0(60K)$	A	21.0	29.0	
Stall current (100K)	$I_0(100K)$	A	26.0	35.0	
Moment of inertia (with brake)	$J_{mot}$	$10^{-4}$ kgm <sup>2</sup>	61.1	61.1	
Moment of inertia (without brake)	$J_{mot}$	$10^{-4}$ kgm <sup>2</sup>	48.0	48.0	
Optimum operating point					
Optimum speed	$N_{opt}$	RPM	4500	6000	
Optimum power	$P_{opt}$	kW	9.42	10.68	
Limiting data					
Max. permissible speed (mech.)	$N_{max}$	RPM	7900	7900	
Max. torque	$M_{max}$	Nm	65	65	
Max. current	$I_{max}$	A	86	112	
Physical constants					
Torque constant	$k_t$	Nm/A	1.01	0.74	
Voltage constant	$k_E$	V/1000 RPM	64	47	
Winding resistance at 20° C	$R_{ph}$	Ohm	0.18	0.1	
Rotating field inductance	$L_D$	mH	2.0	1.2	
Electrical time constant	$T_{el}$	ms	11.1	12.0	
Shaft torsional stiffness	$C_t$	Nm/rad	76000	76000	
Mechanical time constant	$T_{mech}$	ms	2.5	2.6	
Thermal time constant	$T_{th}$	min	15	15	
Weight with brake	m	kg	28.5	28.5	
Weight without brake	m	kg	25.0	25.0	

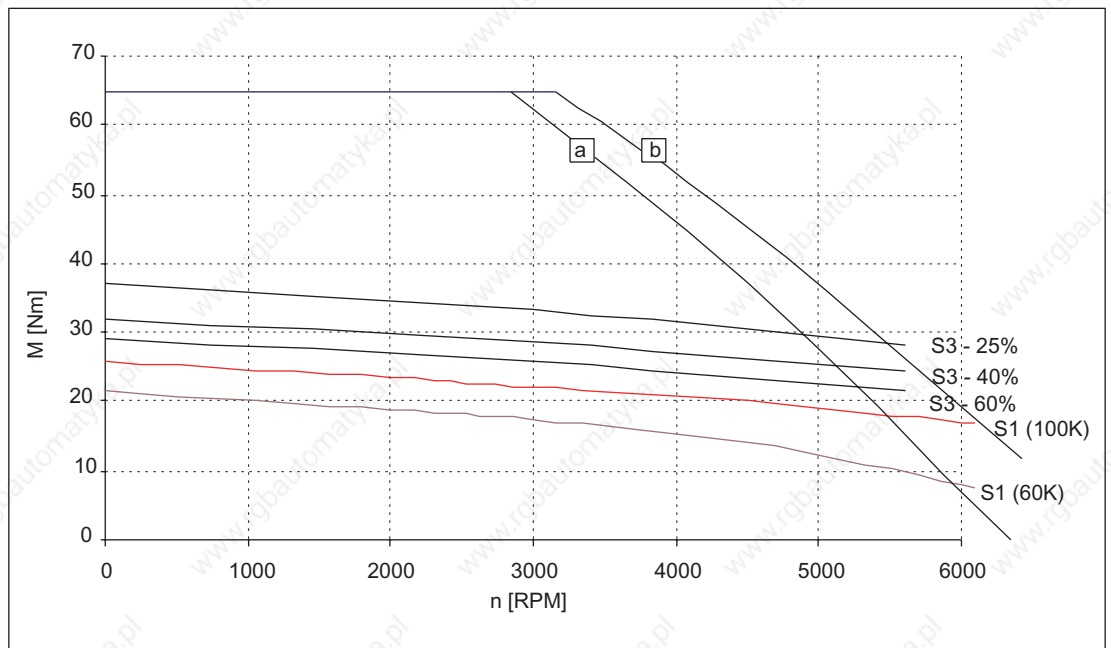

Figure 3-54 Speed-torque diagram 1FT6084-8SH7

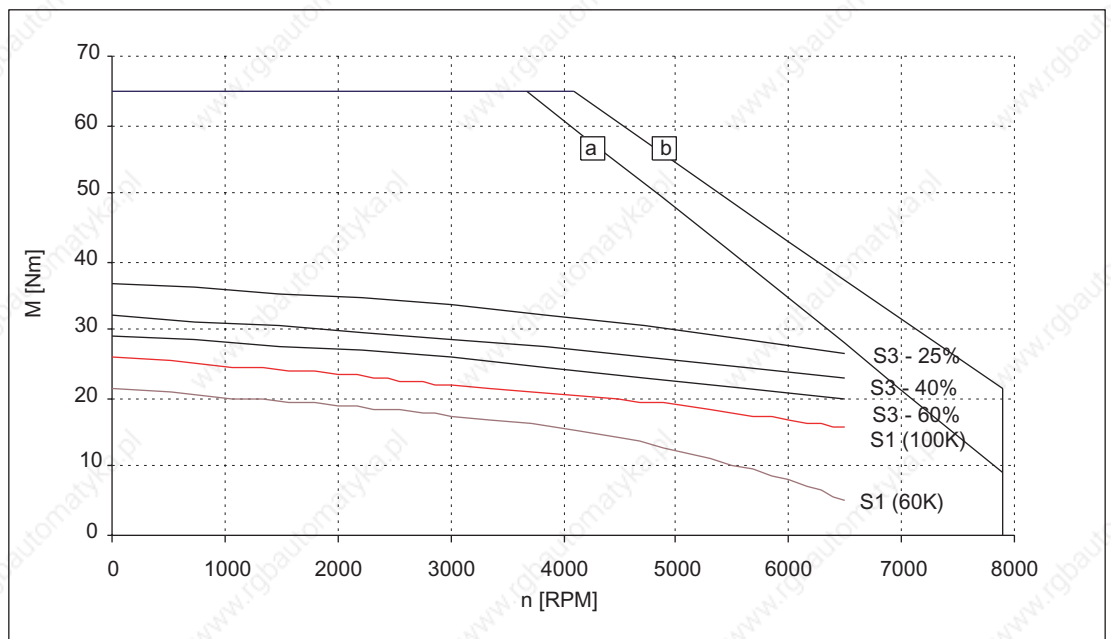

Figure 3-55 Speed-torque diagram 1FT6084-8SK7

[a] SINAMICS S120 SMART LINE,  $V_{DC\ link}=540V$  (DC),  $V_{mot}=380V_{rms}$

[b] SINAMICS S120 ACTIVE LINE,  $V_{DC\ link}=600V$  (DC),  $V_{mot}=425V_{rms}$

## Technical Data and Speed-Torque Diagrams

### 3.1 Speed-torque diagrams

Table 3-33 1FT6086 force ventilated

1FT6086				
Technical data	Code	Units	-8SF7□	
Engineering data				
Rated speed	$n_N$	RPM	3000	
No. of poles	2p		8	
Rated torque (100K)	$M_{N(100K)}$	Nm	31.0	
Rated current (100K)	$I_N(100K)$	A	24.5	
Stall torque (60K)	$M_0(60K)$	Nm	29.0	
Stall torque (100K)	$M_0(100K)$	Nm	35.0	
Stall current (60K)	$I_0(60K)$	A	20.3	
Stall current (100K)	$I_0(100K)$	A	25.0	
Moment of inertia (with brake)	$J_{mot}$	$10^{-4}$ kgm <sup>2</sup>	79.6	
Moment of inertia (without brake)	$J_{mot}$	$10^{-4}$ kgm <sup>2</sup>	66.5	
Optimum operating point				
Optimum speed	$N_{opt}$	RPM	3000	
Optimum power	$P_{opt}$	kW	9.74	
Limiting data				
Max. permissible speed (mech.)	$N_{max}$	RPM	7900	
Max. torque	$M_{max}$	Nm	90	
Max. current	$I_{max}$	A	80	
Physical constants				
Torque constant	$k_t$	Nm/A	1.40	
Voltage constant	$k_E$	V/1000 RPM	89	
Winding resistance at 20° C	$R_{ph}$	Ohm	0.23	
Rotating field inductance	$L_D$	mH	2.9	
Electrical time constant	$T_{el}$	ms	12.6	
Shaft torsional stiffness	$C_t$	Nm/rad	65000	
Mechanical time constant	$T_{mech}$	ms	2.3	
Thermal time constant	$T_{th}$	min	15	
Weight with brake	$m$	kg	33.5	
Weight without brake	$m$	kg	30.0	

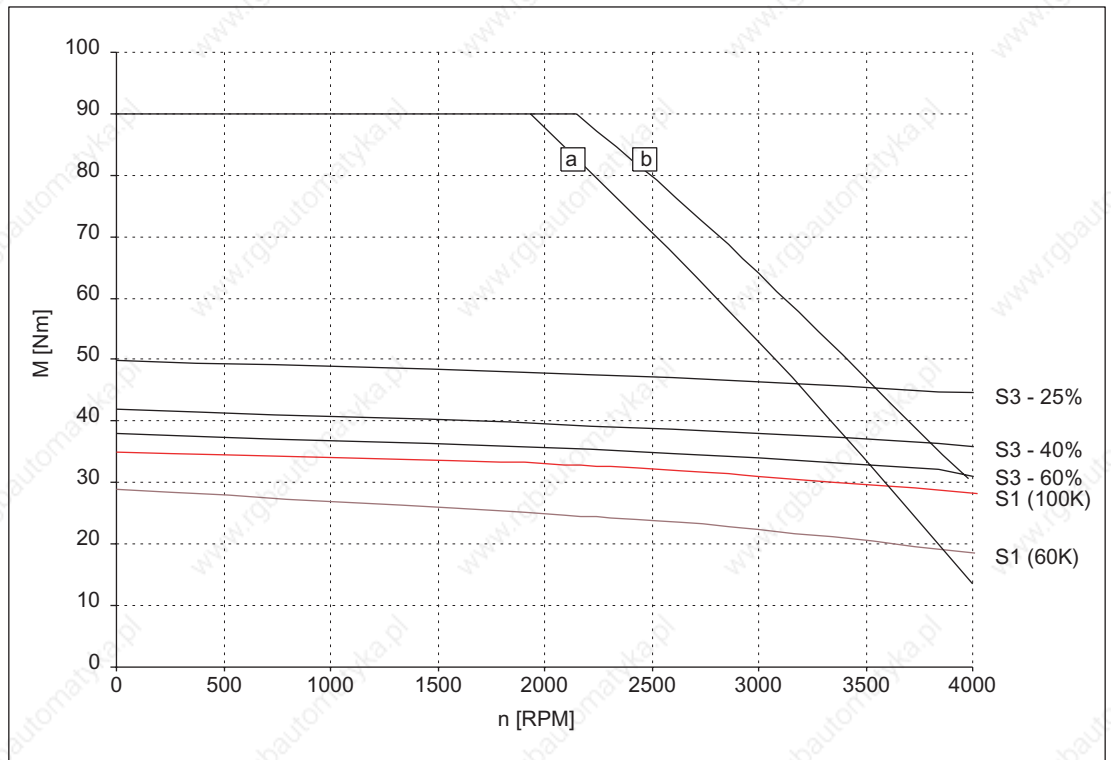

Figure 3-56 Speed-torque diagram 1FT6086-8SF7□

[a] SINAMICS S120 SMART LINE,  $V_{DC \text{ link}}=540V$  (DC),  $V_{mot}=380V_{rms}$

[b] SINAMICS S120 ACTIVE LINE,  $V_{DC \text{ link}}=600V$  (DC),  $V_{mot}=425V_{rms}$

## Technical Data and Speed-Torque Diagrams

### 3.1 Speed-torque diagrams

Table 3-34 1FT6086 force ventilated

1FT6086					
Technical data	Code	Units	-8SH7□	-8SK7□	
Engineering data					
Rated speed	$n_N$	RPM	4500	6000	
No. of poles	2p		8	8	
Rated torque (100K)	$M_{N(100K)}$	Nm	27.0	22.0	
Rated current (100K)	$I_{N(100K)}$	A	32.0	29.0	
Stall torque (60K)	$M_0(60K)$	Nm	29.0	29.0	
Stall torque (100K)	$M_0(100K)$	Nm	35.0	35.0	
Stall current (60K)	$I_0(60K)$	A	31.0	35.0	
Stall current (100K)	$I_0(100K)$	A	38.0	44.0	
Moment of inertia (with brake)	$J_{mot}$	$10^{-4}$ kgm <sup>2</sup>	79.6	79.6	
Moment of inertia (without brake)	$J_{mot}$	$10^{-4}$ kgm <sup>2</sup>	66.5	66.5	
Optimum operating point					
Optimum speed	$N_{opt}$	RPM	4500	5800	
Optimum power	$P_{opt}$	kW	12.7	14.0	
Limiting data					
Max. permissible speed (mech.)	$N_{max}$	RPM	7900	7900	
Max. torque	$M_{max}$	Nm	90	90	
Max. current	$I_{max}$	A	122	141	
Physical constants					
Torque constant	$k_t$	Nm/A	0.91	0.80	
Voltage constant	$k_E$	V/1000 RPM	58	51	
Winding resistance at 20° C	$R_{ph}$	Ohm	0.096	0.072	
Rotating field inductance	$L_D$	mH	1.3	0.95	
Electrical time constant	$T_{el}$	ms	13.5	13.2	
Shaft torsional stiffness	$C_t$	Nm/rad	65000	65000	
Mechanical time constant	$T_{mech}$	ms	2.3	2.2	
Thermal time constant	$T_{th}$	min	15	15	
Weight with brake	m	kg	33.5	33.5	
Weight without brake	m	kg	30.0	30.0	

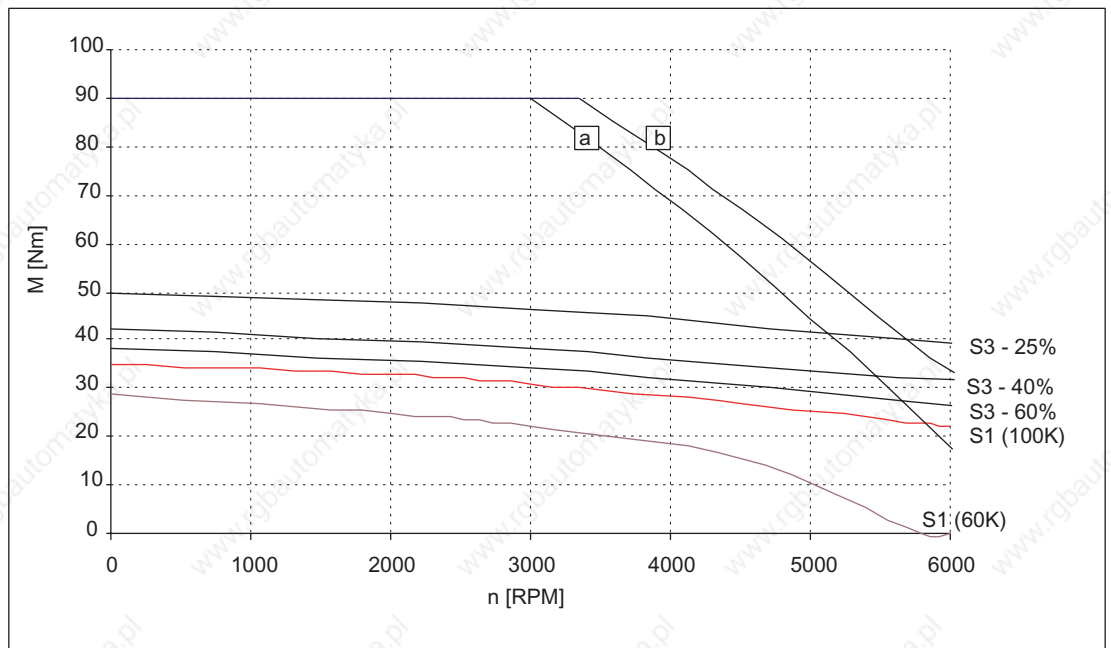

Figure 3-57 Speed-torque diagram 1FT6086-8SH7□

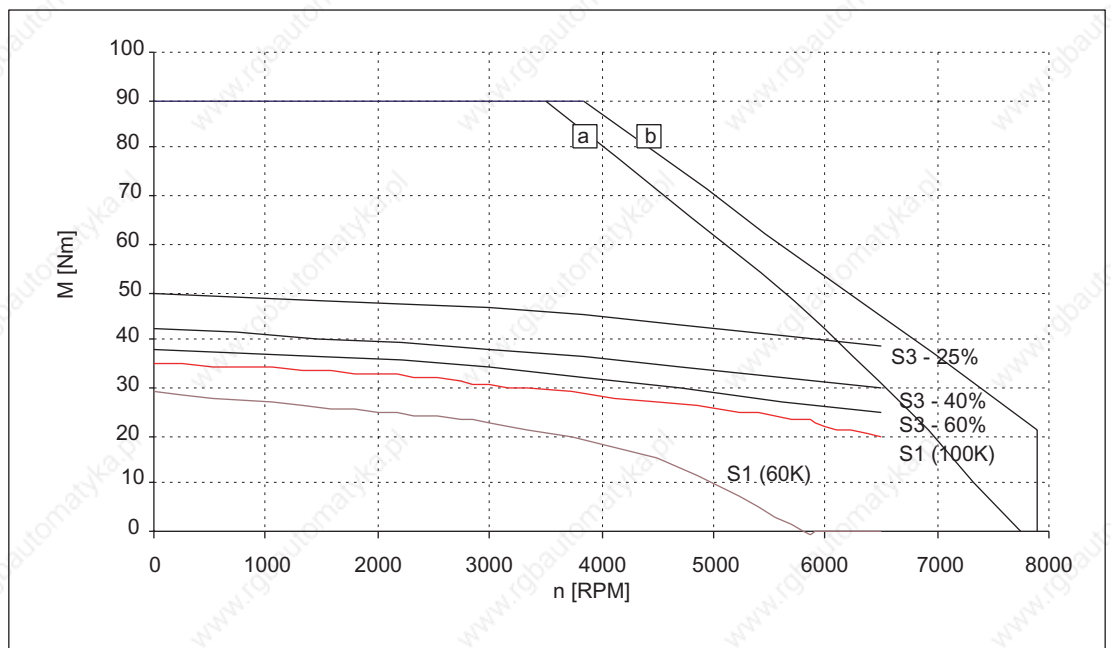

Figure 3-58 Speed-torque diagram 1FT6086-8SK7□

[a] SINAMICS S120 SMART LINE,  $V_{DC\ link}=540V\ (DC)$ ,  $V_{mot}=380V_{rms}$

[b] SINAMICS S120 ACTIVE LINE,  $V_{DC\ link}=600V\ (DC)$ ,  $V_{mot}=425V_{rms}$

## Technical Data and Speed-Torque Diagrams

### 3.1 Speed-torque diagrams

Table 3-35 1FT6105 force ventilated

1FT6105					
Technical data	Code	Units	-8SB7□	-8SC7□	
Engineering data					
Rated speed	$n_N$	RPM	1500	2000	
No. of poles	2p		8	8	
Rated torque (100K)	$M_{N(100K)}$	Nm	59.0	56.0	
Rated current (100K)	$I_{N(100K)}$	A	21.7	28.0	
Stall torque (60K)	$M_0(60K)$	Nm	54.0	54.0	
Stall torque (100K)	$M_0(100K)$	Nm	65.0	65.0	
Stall current (60K)	$I_0(60K)$	A	17.8	24.2	
Stall current (100K)	$I_0(100K)$	A	21.9	30.0	
Moment of inertia (with brake)	$J_{mot}$	$10^{-4}$ kgm <sup>2</sup>	199	199	
Moment of inertia (without brake)	$J_{mot}$	$10^{-4}$ kgm <sup>2</sup>	168	168	
Optimum operating point					
Optimum speed	$N_{opt}$	RPM	1500	2000	
Optimum power	$P_{opt}$	kW	9.27	11.73	
Limiting data					
Max. permissible speed (mech.)	$N_{max}$	RPM	5600	5600	
Max. torque	$M_{max}$	Nm	140	140	
Max. current	$I_{max}$	A	81	110	
Physical constants					
Torque constant	$k_t$	Nm/A	2.97	2.18	
Voltage constant	$k_E$	V/1000 RPM	189	139	
Winding resistance at 20° C	$R_{ph}$	Ohm	0.35	0.19	
Rotating field inductance	$L_D$	mH	7.5	4.1	
Electrical time constant	$T_{el}$	ms	21.0	22.0	
Shaft torsional stiffness	$C_t$	Nm/rad	113000	113000	
Mechanical time constant	$T_{mech}$	ms	2.0	2.0	
Thermal time constant	$T_{th}$	min	20	20	
Weight with brake	m	kg	50	50	
Weight without brake	m	kg	45.5	45.5	



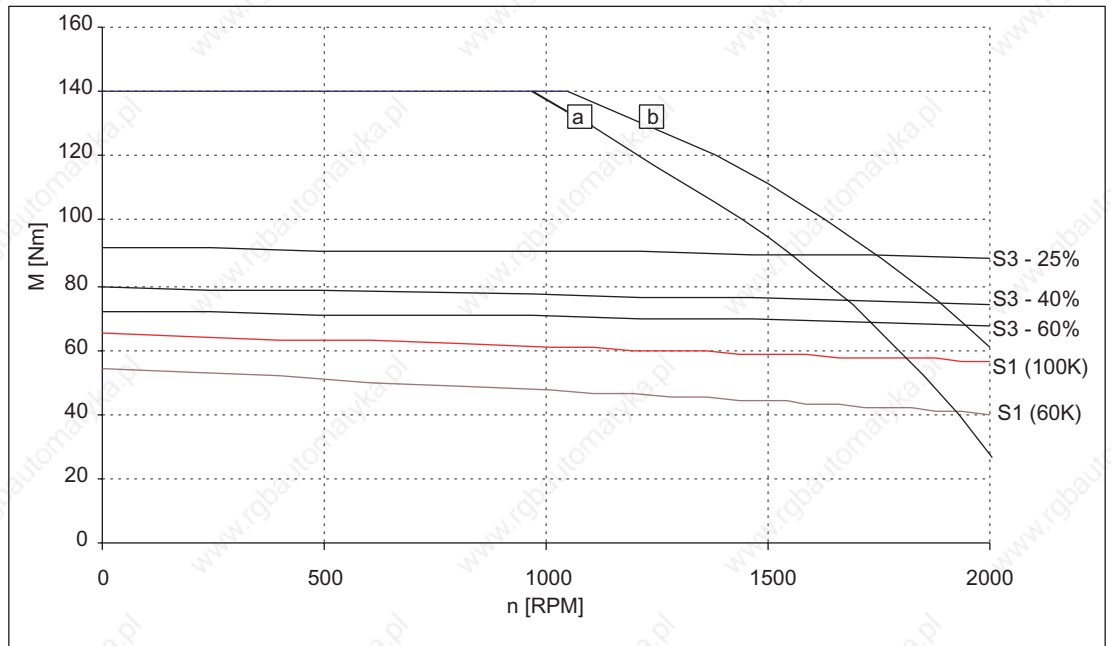

Figure 3-59 Speed-torque diagram 1FT6105-8SB7

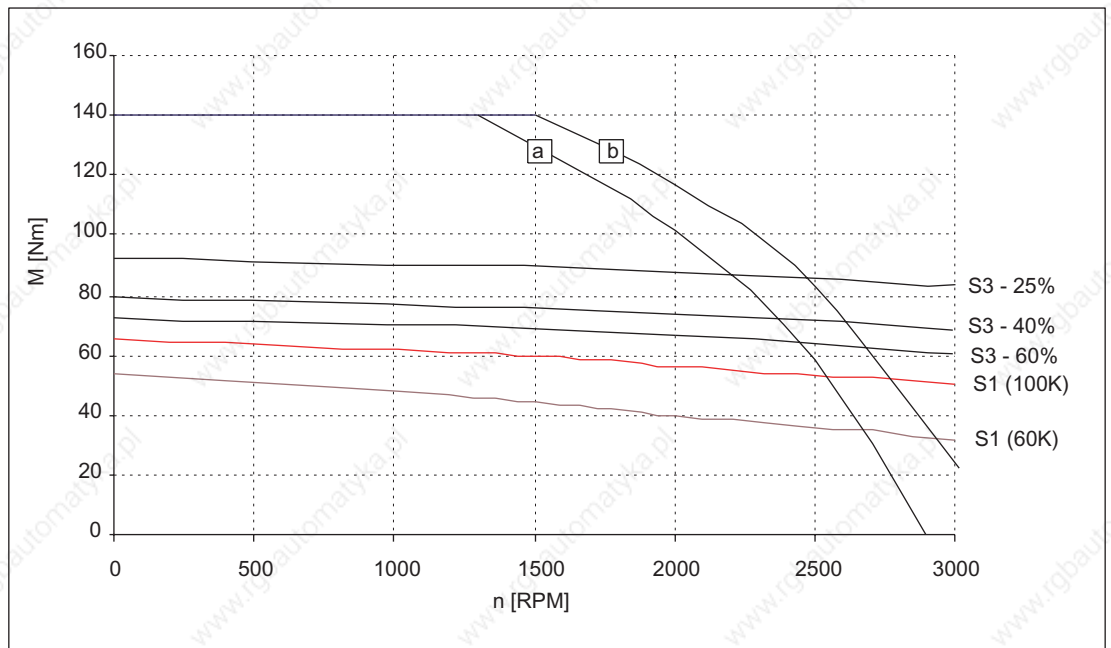

Figure 3-60 Speed-torque diagram 1FT6105-8SC7

[a] SINAMICS S120 SMART LINE,  $V_{DC \text{ link}}=540V$  (DC),  $V_{mot}=380V_{rms}$

[b] SINAMICS S120 ACTIVE LINE,  $V_{DC \text{ link}}=600V$  (DC),  $V_{mot}=425V_{rms}$

## Technical Data and Speed-Torque Diagrams

### 3.1 Speed-torque diagrams

Table 3-36 1FT6105 force ventilated

1FT6105					
Technical data	Code	Units	-8SF7□	-8SH7□	
Engineering data					
Rated speed	$n_N$	RPM	3000	4500	
No. of poles	2p		8	8	
Rated torque (100K)	$M_{N(100K)}$	Nm	50.0	40.0	
Rated current (100K)	$I_N(100K)$	A	35.0	41.0	
Stall torque (60K)	$M_0(60K)$	Nm	54.0	54.0	
Stall torque (100K)	$M_0(100K)$	Nm	65.0	65.0	
Stall current (60K)	$I_0(60K)$	A	34.0	48.0	
Stall current (100K)	$I_0(100K)$	A	42.0	59.0	
Moment of inertia (with brake)	$J_{mot}$	$10^{-4}$ kgm <sup>2</sup>	199	199	
Moment of inertia (without brake)	$J_{mot}$	$10^{-4}$ kgm <sup>2</sup>	168	168	
Optimum operating point					
Optimum speed	$N_{opt}$	RPM	3000	4500	
Optimum power	$P_{opt}$	kW	15.7	18.8	
Limiting data					
Max. permissible speed (mech.)	$N_{max}$	RPM	5600	5600	
Max. torque	$M_{max}$	Nm	140	140	
Max. current	$I_{max}$	A	155	221	
Physical constants					
Torque constant	$k_t$	Nm/A	1.56	1.10	
Voltage constant	$k_E$	V/1000 RPM	99	70	
Winding resistance at 20° C	$R_{ph}$	Ohm	0.098	0.048	
Rotating field inductance	$L_D$	mH	2.1	1.0	
Electrical time constant	$T_{el}$	ms	21.0	21.0	
Shaft torsional stiffness	$C_t$	Nm/rad	113000	113000	
Mechanical time constant	$T_{mech}$	ms	2.0	2.0	
Thermal time constant	$T_{th}$	min	20	20	
Weight with brake	m	kg	50	50	
Weight without brake	m	kg	45.5	45.5	

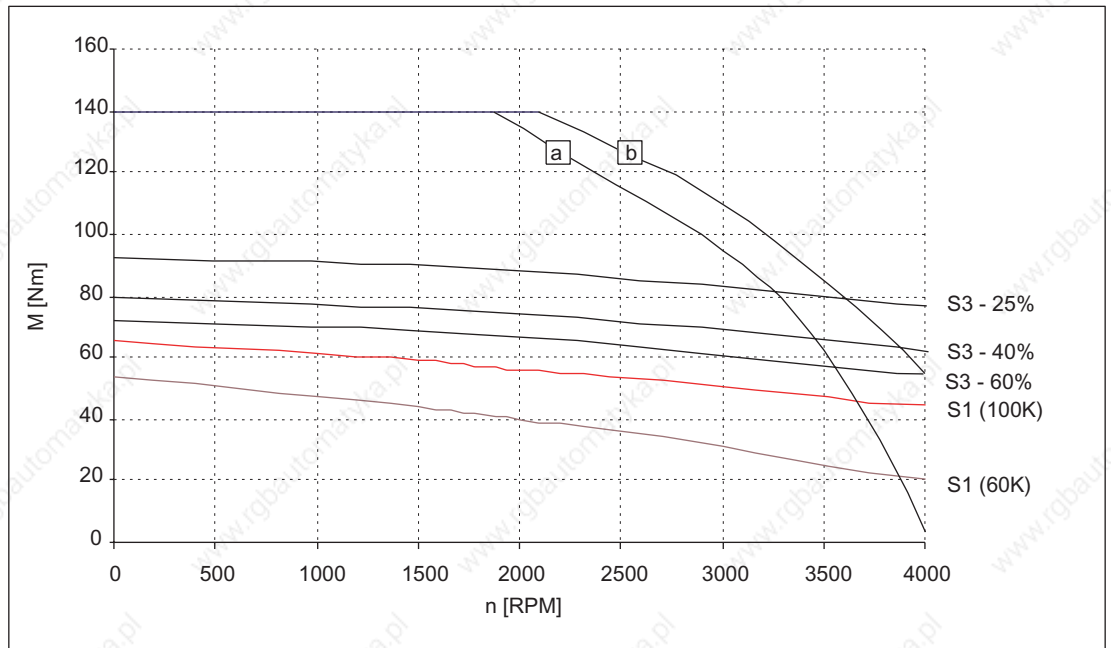

Figure 3-61 Speed-torque diagram 1FT6105-8SF7□

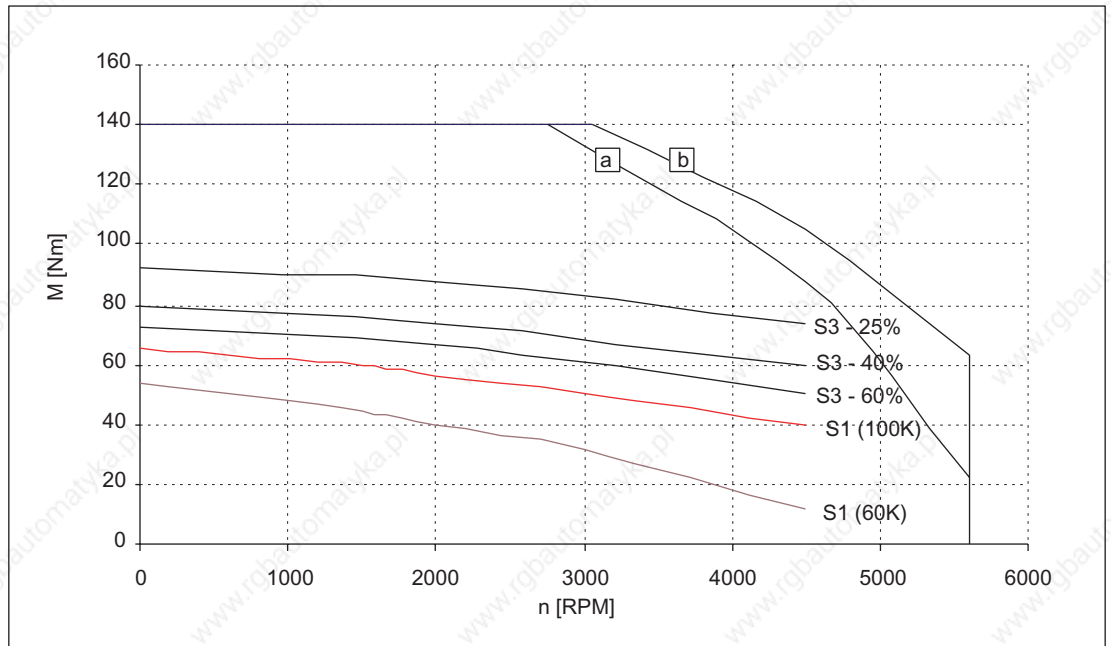

Figure 3-62 Speed-torque diagram 1FT6105-8SH7□

[a] SINAMICS S120 SMART LINE,  $V_{DC\ link}=540V$  (DC),  $V_{mot}=380V_{rms}$

[b] SINAMICS S120 ACTIVE LINE,  $V_{DC\ link}=600V$  (DC),  $V_{mot}=425V_{rms}$

## Technical Data and Speed-Torque Diagrams

### 3.1 Speed-torque diagrams

Table 3-37 1FT6108 force ventilated

1FT6108					
Technical data	Code	Units	-8SB7□	-8SC7□	
Engineering data					
Rated speed	$n_N$	RPM	1500	2000	
No. of poles	2p		8	8	
Rated torque (100K)	$M_{N(100K)}$	Nm	83	80	
Rated current (100K)	$I_N(100K)$	A	31	40	
Stall torque (60K)	$M_0(60K)$	Nm	75	75	
Stall torque (100K)	$M_0(100K)$	Nm	90	90	
Stall current (60K)	$I_0(60K)$	A	25	34	
Stall current (100K)	$I_0(100K)$	A	31	41	
Moment of inertia (with brake)	$J_{mot}$	$10^{-4}$ kgm <sup>2</sup>	291	291	
Moment of inertia (without brake)	$J_{mot}$	$10^{-4}$ kgm <sup>2</sup>	260	260	
Optimum operating point					
Optimum speed	$N_{opt}$	RPM	1500	2000	
Optimum power	$P_{opt}$	kW	13.0	16.8	
Limiting data					
Max. permissible speed (mech.)	$N_{max}$	RPM	5600	5600	
Max. torque	$M_{max}$	Nm	220	220	
Max. current	$I_{max}$	A	116	154	
Physical constants					
Torque constant	$k_t$	Nm/A	2.91	2.18	
Voltage constant	$k_E$	V/1000 RPM	195	139	
Winding resistance at 20° C	$R_{ph}$	Ohm	0.19	0.11	
Rotating field inductance	$L_D$	mH	4.4	2.5	
Electrical time constant	$T_{el}$	ms	23.0	23.0	
Shaft torsional stiffness	$C_t$	Nm/rad	92000	92000	
Mechanical time constant	$T_{mech}$	ms	1.8	1.8	
Thermal time constant	$T_{th}$	min	20	20	
Weight with brake	m	kg	66	66	
Weight without brake	m	kg	61.5	61.5	

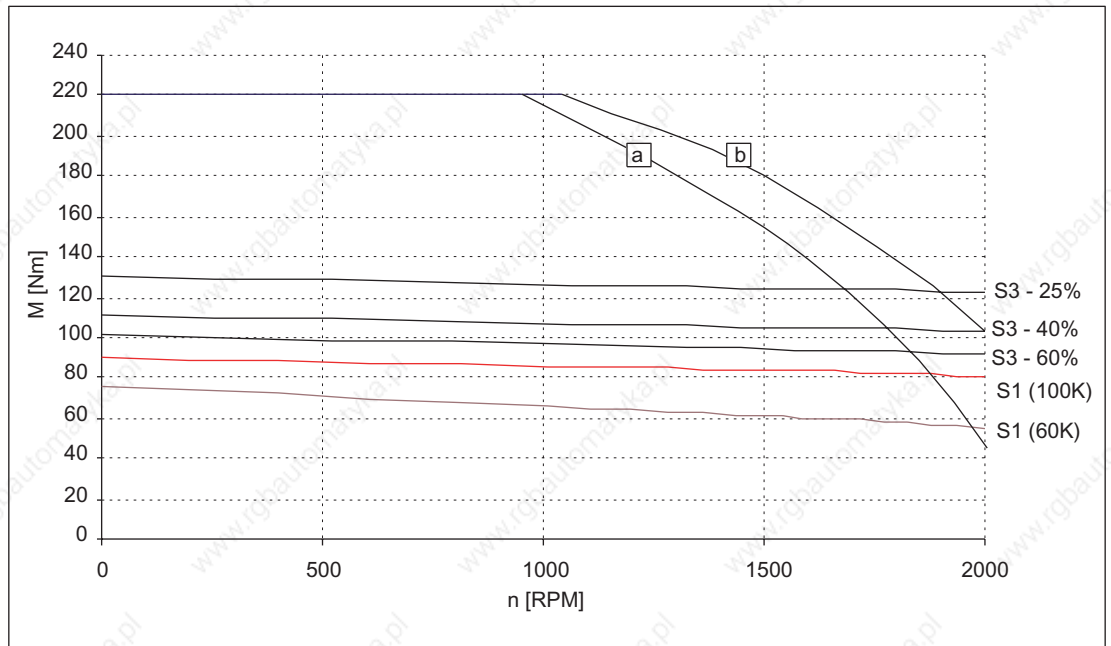

Figure 3-63 Speed-torque diagram 1FT6108-8SB7

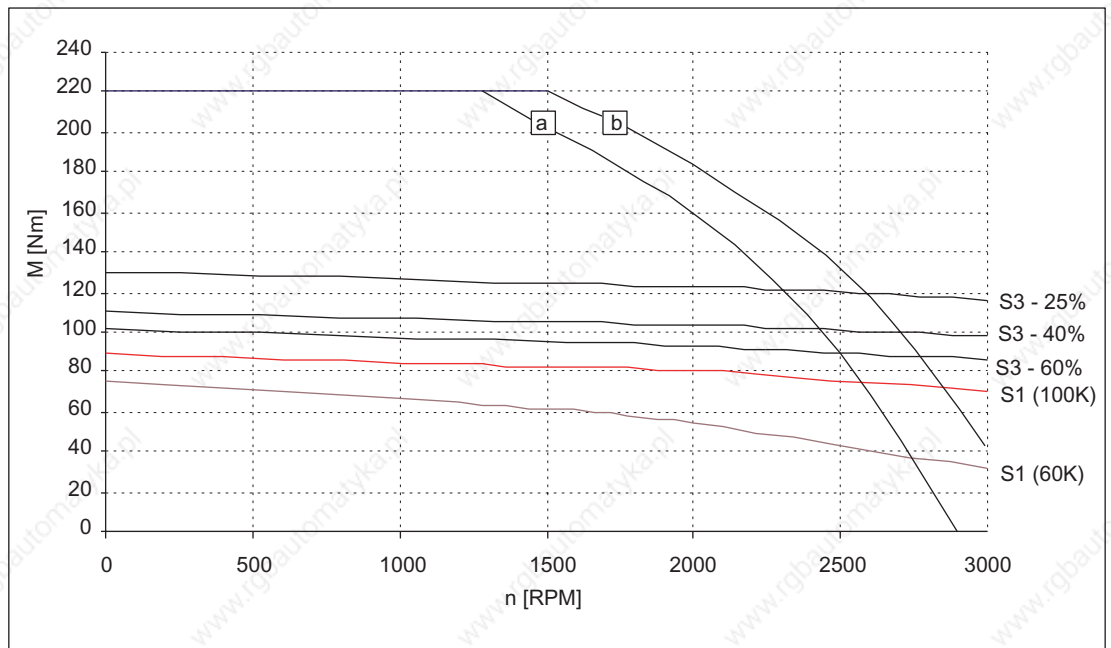

Figure 3-64 Speed-torque diagram 1FT6108-8SC7

[a] SINAMICS S120 SMART LINE,  $V_{DC\ link}=540V$  (DC),  $V_{mot}=380V_{rms}$

[b] SINAMICS S120 ACTIVE LINE,  $V_{DC\ link}=600V$  (DC),  $V_{mot}=425V_{rms}$

## Technical Data and Speed-Torque Diagrams

### 3.1 Speed-torque diagrams

Table 3-38 1FT6108 force ventilated

1FT6108				
Technical data	Code	Units	-8SF7□	
Engineering data				
Rated speed	$n_N$	RPM	3000	
No. of poles	2p		8	
Rated torque (100K)	$M_{N(100K)}$	Nm	70	
Rated current (100K)	$I_N(100K)$	A	53	
Stall torque (60K)	$M_0(60K)$	Nm	75	
Stall torque (100K)	$M_0(100K)$	Nm	90	
Stall current (60K)	$I_0(60K)$	A	51	
Stall current (100K)	$I_0(100K)$	A	62	
Moment of inertia (with brake)	$J_{mot}$	$10^{-4}$ kgm <sup>2</sup>	291	
Moment of inertia (without brake)	$J_{mot}$	$10^{-4}$ kgm <sup>2</sup>	260	
Optimum operating point				
Optimum speed	$N_{opt}$	RPM	3000	
Optimum power	$P_{opt}$	kW	22.0	
Limiting data				
Max. permissible speed (mech.)	$N_{max}$	RPM	5600	
Max. torque	$M_{max}$	Nm	220	
Max. current	$I_{max}$	A	231	
Physical constants				
Torque constant	$k_t$	Nm/A	1.45	
Voltage constant	$k_E$	V/1000 RPM	92	
Winding resistance at 20° C	$R_{ph}$	Ohm	0.048	
Rotating field inductance	$L_D$	mH	1.1	
Electrical time constant	$T_{el}$	ms	23.0	
Shaft torsional stiffness	$C_t$	Nm/rad	92000	
Mechanical time constant	$T_{mech}$	ms	1.8	
Thermal time constant	$T_{th}$	min	20	
Weight with brake	$m$	kg	66	
Weight without brake	$m$	kg	61.5	

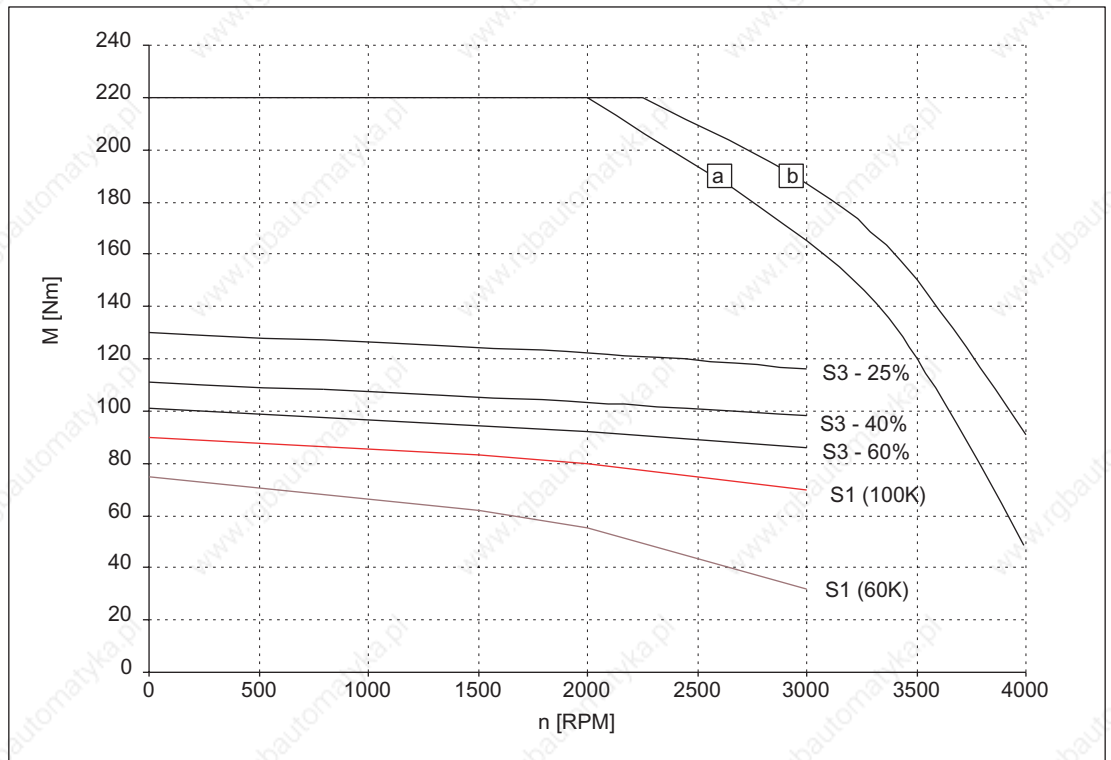

Figure 3-65 Speed-torque diagram 1FT6108-8SF7□

[a] SINAMICS S120 SMART LINE,  $V_{\text{DC link}}=540\text{V (DC)}$ ,  $V_{\text{mot}}=380\text{V}_{\text{rms}}$

[b] SINAMICS S120 ACTIVE LINE,  $V_{\text{DC link}}=600\text{V (DC)}$ ,  $V_{\text{mot}}=425\text{V}_{\text{rms}}$

## Technical Data and Speed-Torque Diagrams

### 3.1 Speed-torque diagrams

Table 3-39 1FT6132 force ventilated

1FT6132					
Technical data	Code	Units	-6SB71	-6SC71	
Engineering data					
Rated speed	$n_N$	RPM	1500	2000	
No. of poles	2p		6	6	
Rated torque (100K)	$M_{N(100K)}$	Nm	102	98	
Rated current (100K)	$I_N(100K)$	A	36	46	
Stall torque (60K)	$M_0(60K)$	Nm	91	91	
Stall torque (100K)	$M_0(100K)$	Nm	110	110	
Stall current (60K)	$I_0(60K)$	A	29	38	
Stall current (100K)	$I_0(100K)$	A	36	47	
Moment of inertia (with brake)	$J_{mot}$	$10^{-4}$ kgm <sup>2</sup>	508	508	
Moment of inertia (without brake)	$J_{mot}$	$10^{-4}$ kgm <sup>2</sup>	430	430	
Optimum operating point					
Optimum speed	$N_{opt}$	RPM	1500	2000	
Optimum power	$P_{opt}$	kW	16.0	20.5	
Limiting data					
Max. permissible speed (mech.)	$N_{max}$	RPM	3600	3600	
Max. torque	$M_{max}$	Nm	248	248	
Max. current	$I_{max}$	A	108	144	
Physical constants					
Torque constant	$k_t$	Nm/A	3.05	2.32	
Voltage constant	$k_E$	V/1000 RPM	196	149	
Winding resistance at 20° C	$R_{ph}$	Ohm	0.17	0.10	
Rotating field inductance	$L_D$	mH	5.7	3.3	
Electrical time constant	$T_{el}$	ms	38	37	
Shaft torsional stiffness	$C_t$	Nm/rad	258000	258000	
Mechanical time constant	$T_{mech}$	ms	2.4	2.4	
Thermal time constant	$T_{th}$	min	25	25	
Weight with brake	m	kg	101	101	
Weight without brake	m	kg	91	91	



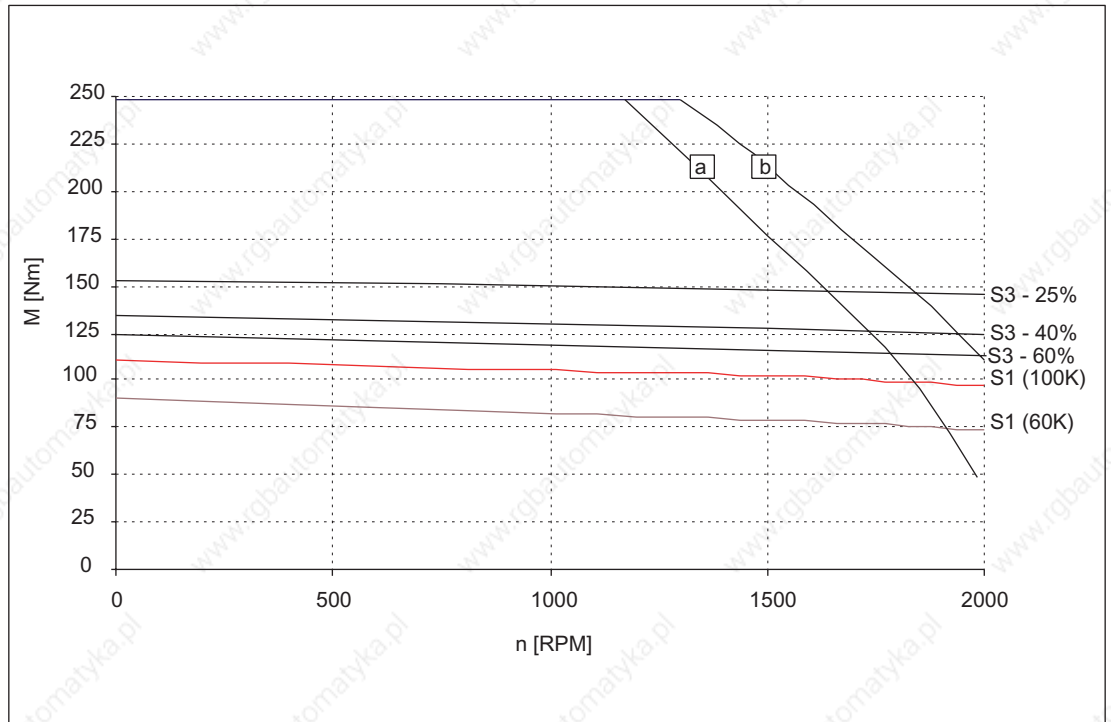

Figure 3-66 Speed-torque diagram 1FT6132-6SB71

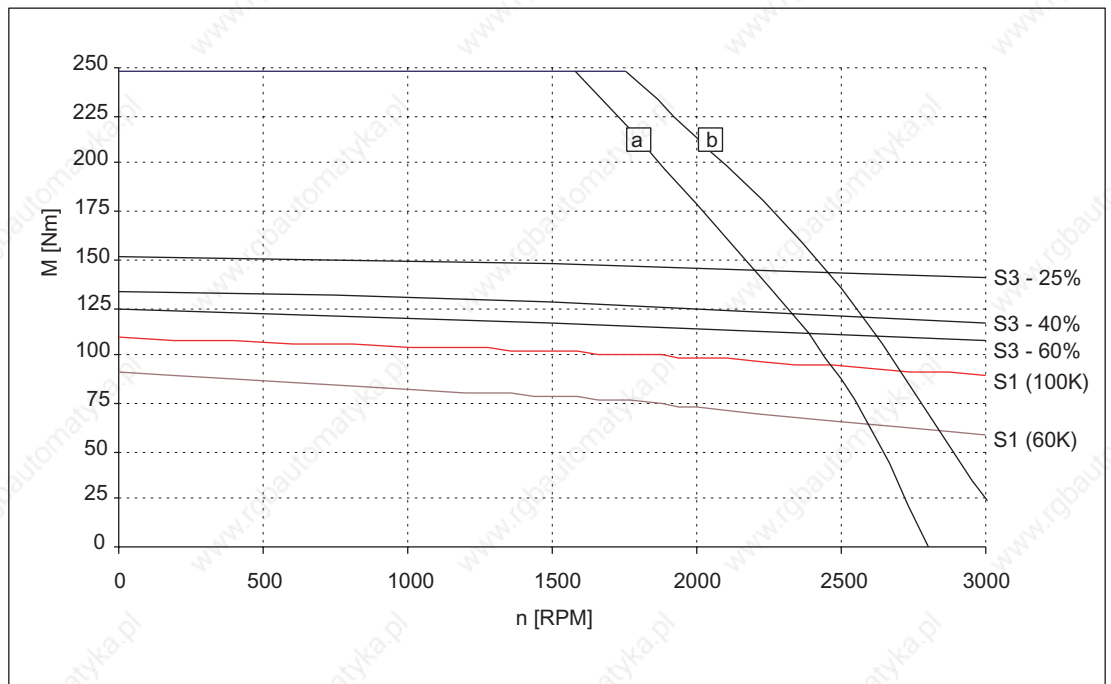

Figure 3-67 Speed-torque diagram 1FT6132-6SC71

[a] SINAMICS S120 SMART LINE,  $V_{DC\ link}=540V$  (DC),  $V_{mot}=380V_{rms}$

[b] SINAMICS S120 ACTIVE LINE,  $V_{DC\ link}=600V$  (DC),  $V_{mot}=425V_{rms}$

## Technical Data and Speed-Torque Diagrams

### 3.1 Speed-torque diagrams

Table 3-40 1FT6132 force ventilated

1FT6132				
Technical data	Code	Units	-6SF71	
Engineering data				
Rated speed	$n_N$	RPM	3000	
No. of poles	2p		6	
Rated torque (100K)	$M_{N(100K)}$	Nm	90	
Rated current (100K)	$I_N(100K)$	A	62	
Stall torque (60K)	$M_0(60K)$	Nm	91	
Stall torque (100K)	$M_0(100K)$	Nm	110	
Stall current (60K)	$I_0(60K)$	A	55	
Stall current (100K)	$I_0(100K)$	A	69	
Moment of inertia (with brake)	$J_{mot}$	$10^{-4}$ kgm <sup>2</sup>	508	
Moment of inertia (without brake)	$J_{mot}$	$10^{-4}$ kgm <sup>2</sup>	430	
Optimum operating point				
Optimum speed	$N_{opt}$	RPM	3000	
Optimum power	$P_{opt}$	kW	28.3	
Limiting data				
Max. permissible speed (mech.)	$N_{max}$	RPM	3600	
Max. torque	$M_{max}$	Nm	248	
Max. current	$I_{max}$	A	209	
Physical constants				
Torque constant	$k_t$	Nm/A	1.6	
Voltage constant	$k_E$	V/1000 RPM	103	
Winding resistance at 20° C	$R_{ph}$	Ohm	0.048	
Rotating field inductance	$L_D$	mH	1.55	
Electrical time constant	$T_{el}$	ms	37	
Shaft torsional stiffness	$C_t$	Nm/rad	258000	
Mechanical time constant	$T_{mech}$	ms	2.4	
Thermal time constant	$T_{th}$	min	25	
Weight with brake	$m$	kg	101	
Weight without brake	$m$	kg	91	

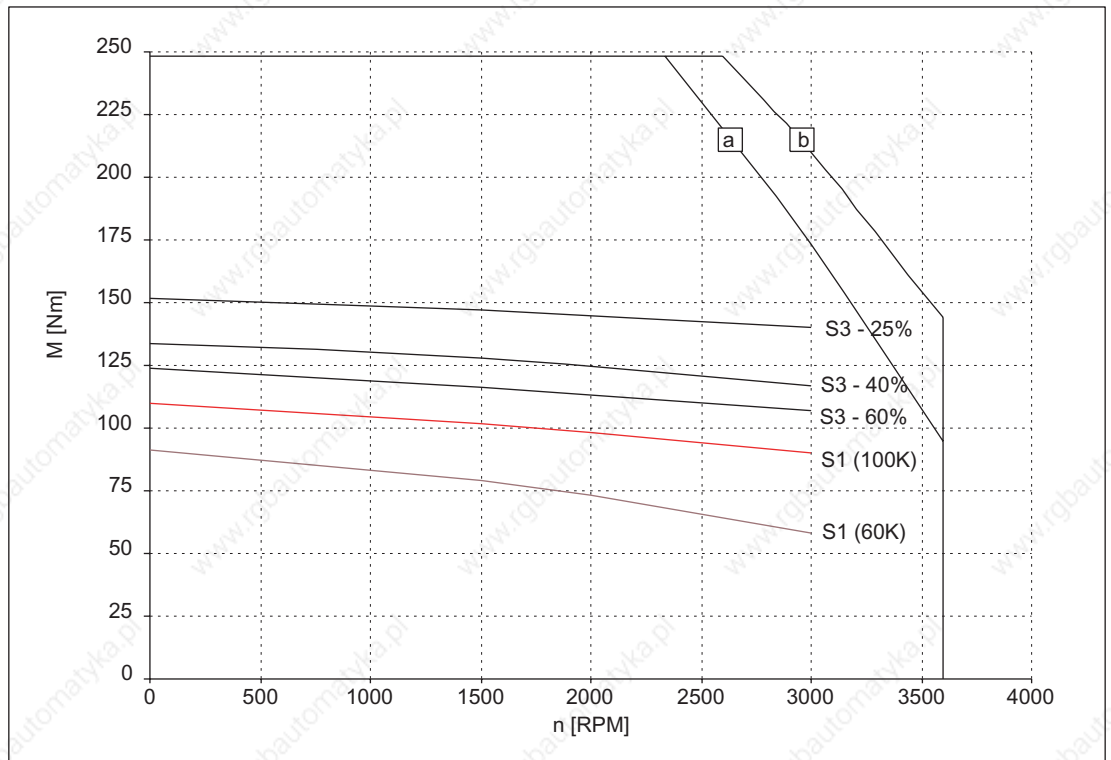

Figure 3-68 Speed-torque diagram 1FT6132-6SF71

[a] SINAMICS S120 SMART LINE,  $V_{DC \text{ link}}=540V$  (DC),  $V_{mot}=380V_{rms}$

[b] SINAMICS S120 ACTIVE LINE,  $V_{DC \text{ link}}=600V$  (DC),  $V_{mot}=425V_{rms}$

## Technical Data and Speed-Torque Diagrams

### 3.1 Speed-torque diagrams

Table 3-41 1FT6134 force ventilated

1FT6134					
Technical data	Code	Units	-6SB71	-6SC71	
Engineering data					
Rated speed	$n_N$	RPM	1500	2000	
No. of poles	2p		6	6	
Rated torque (100K)	$M_{N(100K)}$	Nm	130	125	
Rated current (100K)	$I_N(100K)$	A	45	57	
Stall torque (60K)	$M_0(60K)$	Nm	116	116	
Stall torque (100K)	$M_0(100K)$	Nm	140	140	
Stall current (60K)	$I_0(60K)$	A	36	47	
Stall current (100K)	$I_0(100K)$	A	44	58	
Moment of inertia (with brake)	$J_{mot}$	$10^{-4}$ kgm <sup>2</sup>	625	625	
Moment of inertia (without brake)	$J_{mot}$	$10^{-4}$ kgm <sup>2</sup>	547	547	
Optimum operating point					
Optimum speed	$n_{opt}$	RPM	1500	2000	
Optimum power	$P_{opt}$	kW	20.4	26.2	
Limiting data					
Max. permissible speed (mech.)	$n_{max}$	RPM	3600	3600	
Max. torque	$M_{max}$	Nm	316	316	
Max. current	$I_{max}$	A	140	182	
Physical constants					
Torque constant	$k_T$	Nm/A	3.17	2.43	
Voltage constant	$k_E$	V/1000 RPM	204	156	
Winding resistance at 20° C	$R_{ph}$	Ohm	0.14	0.081	
Rotating field inductance	$L_D$	mH	4.6	2.7	
Electrical time constant	$T_{el}$	ms	33	33	
Shaft torsional stiffness	$C_t$	Nm/rad	234000	234000	
Mechanical time constant	$T_{mech}$	ms	2.3	2.3	
Thermal time constant	$T_{th}$	min	25	25	
Weight with brake	m	kg	116	116	
Weight without brake	m	kg	106	106	

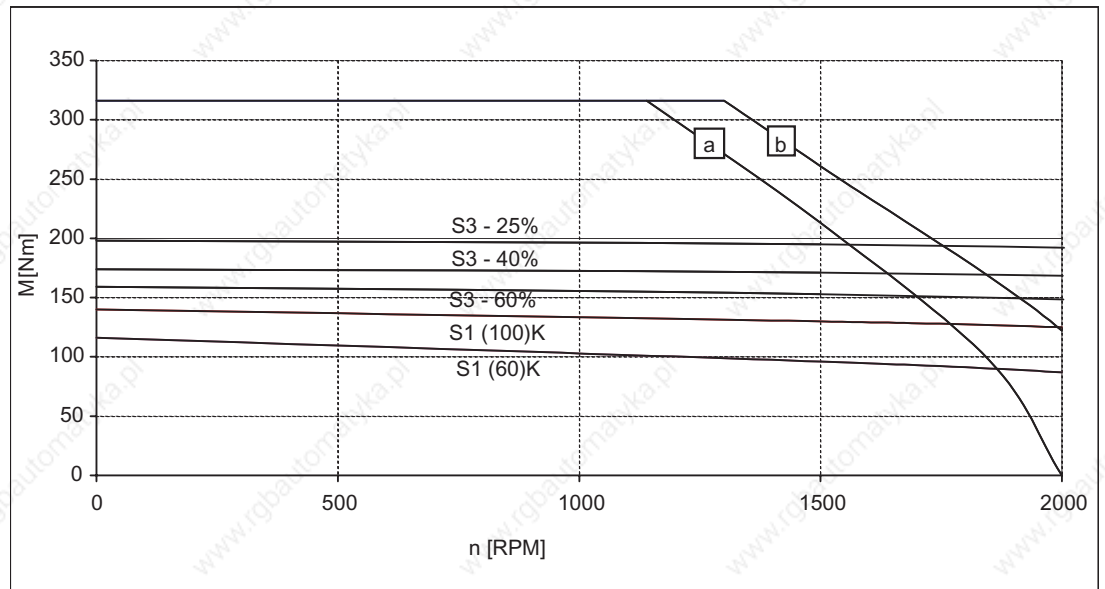

Figure 3-69 Speed-torque diagram 1FT6134-6SB71

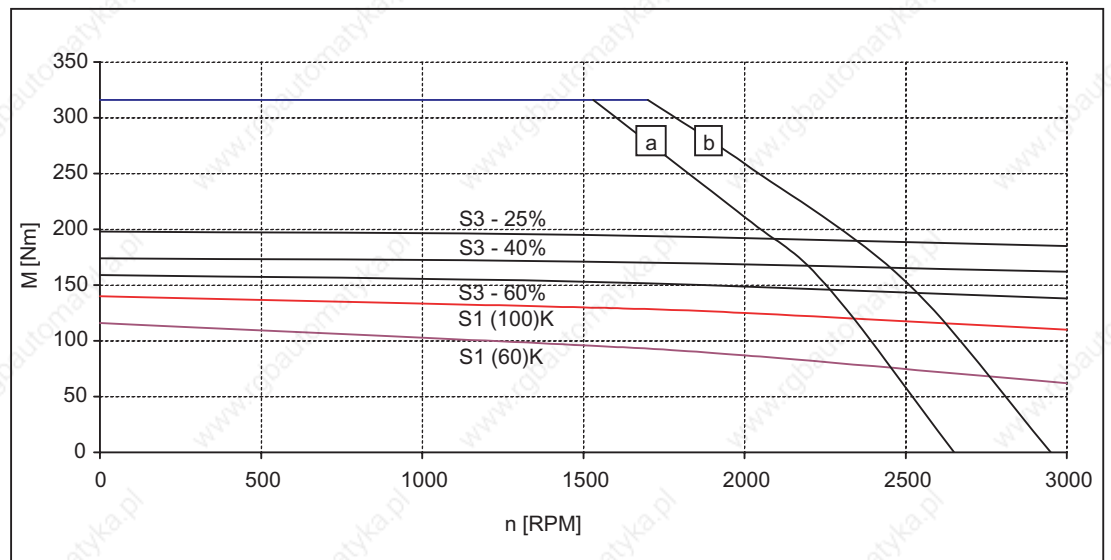

Figure 3-70 Speed-torque diagram 1FT6134-6SC71

[a] SINAMICS S120 SMART LINE,  $V_{DC\ link}=540V$  (DC),  $V_{mot}=380V_{rms}$

[b] SINAMICS S120 ACTIVE LINE,  $V_{DC\ link}=600V$  (DC),  $V_{mot}=425V_{rms}$

## Technical Data and Speed-Torque Diagrams

### 3.1 Speed-torque diagrams

Table 3-42 1FT6134 force ventilated

1FT6134					
Technical data	Code	Units	-6SF71		
Engineering data					
Rated speed	$n_N$	RPM	3000		
No. of poles	2p		6		
Rated torque (100K)	$M_{N(100K)}$	Nm	110		
Rated current (100K)	$I_N(100K)$	A	72		
Stall torque (60K)	$M_0(60K)$	Nm	116		
Stall torque (100K)	$M_0(100K)$	Nm	140		
Stall current (60K)	$I_0(60K)$	A	67		
Stall current (100K)	$I_0(100K)$	A	83		
Moment of inertia (with brake)	$J_{mot}$	$10^{-4}$ kgm <sup>2</sup>	625		
Moment of inertia (without brake)	$J_{mot}$	$10^{-4}$ kgm <sup>2</sup>	547		
Optimum operating point					
Optimum speed	$n_{opt}$	RPM	3000		
Optimum power	$P_{opt}$	kW	35		
Limiting data					
Max. permissible speed (mech.)	$n_{max}$	RPM	3600		
Max. torque	$M_{max}$	Nm	316		
Max. current	$I_{max}$	A	264		
Physical constants					
Torque constant	$k_T$	Nm/A	1.68		
Voltage constant	$k_E$	V/1000 RPM	108		
Winding resistance at 20° C	$R_{ph}$	Ohm	0.039		
Rotating field inductance	$L_D$	mH	1.3		
Electrical time constant	$T_{el}$	ms	33		
Shaft torsional stiffness	$C_t$	Nm/rad	234000		
Mechanical time constant	$T_{mech}$	ms	2.3		
Thermal time constant	$T_{th}$	min	25		
Weight with brake	m	kg	116		
Weight without brake	m	kg	106		

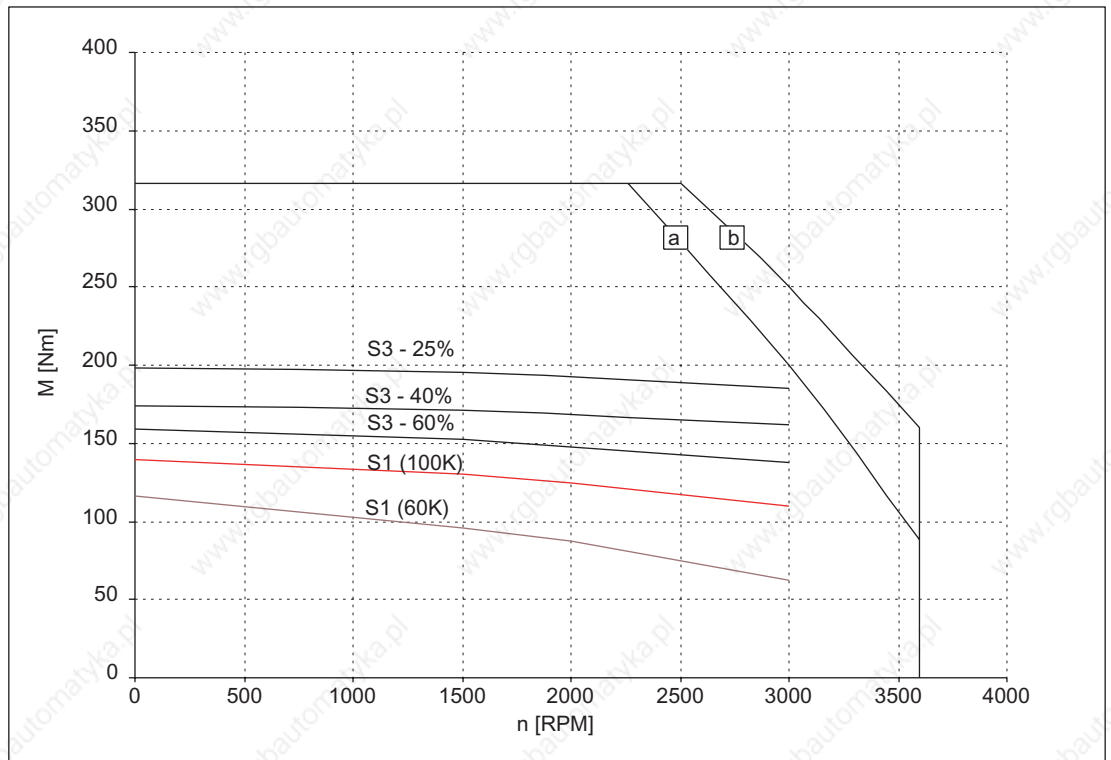

Figure 3-71 Speed-torque diagram 1FT6134-6SF71

[a] SINAMICS S120 SMART LINE,  $V_{DC \text{ link}}=540V$  (DC),  $V_{mot}=380V_{rms}$

[b] SINAMICS S120 ACTIVE LINE,  $V_{DC \text{ link}}=600V$  (DC),  $V_{mot}=425V_{rms}$

## Technical Data and Speed-Torque Diagrams

### 3.1 Speed-torque diagrams

Table 3-43 1FT6136 force ventilated

1FT6136					
Technical data	Code	Units	-6SB71	-6SC71	
Engineering data					
Rated speed	$n_N$	RPM	1500	2000	
No. of poles	2p		6	6	
Rated torque (100K)	$M_{N(100K)}$	Nm	160	155	
Rated current (100K)	$I_{N(100K)}$	A	55	72	
Stall torque (60K)	$M_0(60K)$	Nm	145	145	
Stall torque (100K)	$M_0(100K)$	Nm	175	175	
Stall current (60K)	$I_0(60K)$	A	45	62	
Stall current (100K)	$I_0(100K)$	A	55	77	
Moment of inertia (with brake)	$J_{mot}$	$10^{-4}$ kgm <sup>2</sup>	742	742	
Moment of inertia (without brake)	$J_{mot}$	$10^{-4}$ kgm <sup>2</sup>	664	664	
Optimum operating point					
Optimum speed	$n_{opt}$	RPM	1500	2000	
Optimum power	$P_{opt}$	kW	25	32	
Limiting data					
Max. permissible speed (mech.)	$n_{max}$	RPM	3600	3600	
Max. torque	$M_{max}$	Nm	380	380	
Max. current	$I_{max}$	A	156	219	
Physical constants					
Torque constant	$k_T$	Nm/A	3.17	2.27	
Voltage constant	$k_E$	V/1000 RPM	204	146	
Winding resistance at 20° C	$R_{ph}$	Ohm	0.1	0.052	
Rotating field inductance	$L_D$	mH	3.8	2.0	
Electrical time constant	$T_{el}$	ms	43	42	
Shaft torsional stiffness	$C_t$	Nm/rad	214000	214000	
Mechanical time constant	$T_{mech}$	ms	2.0	2.0	
Thermal time constant	$T_{th}$	min	25	25	
Weight with brake	m	kg	131	131	
Weight without brake	m	kg	123	123	



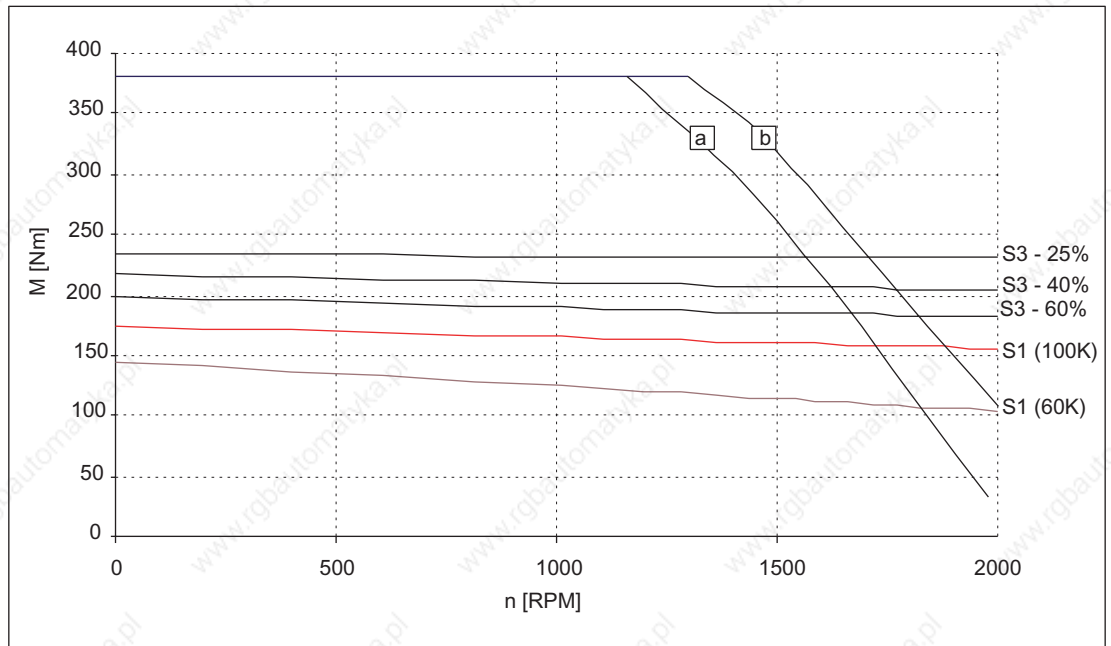

Figure 3-72 Speed-torque diagram 1FT6136-6SB71

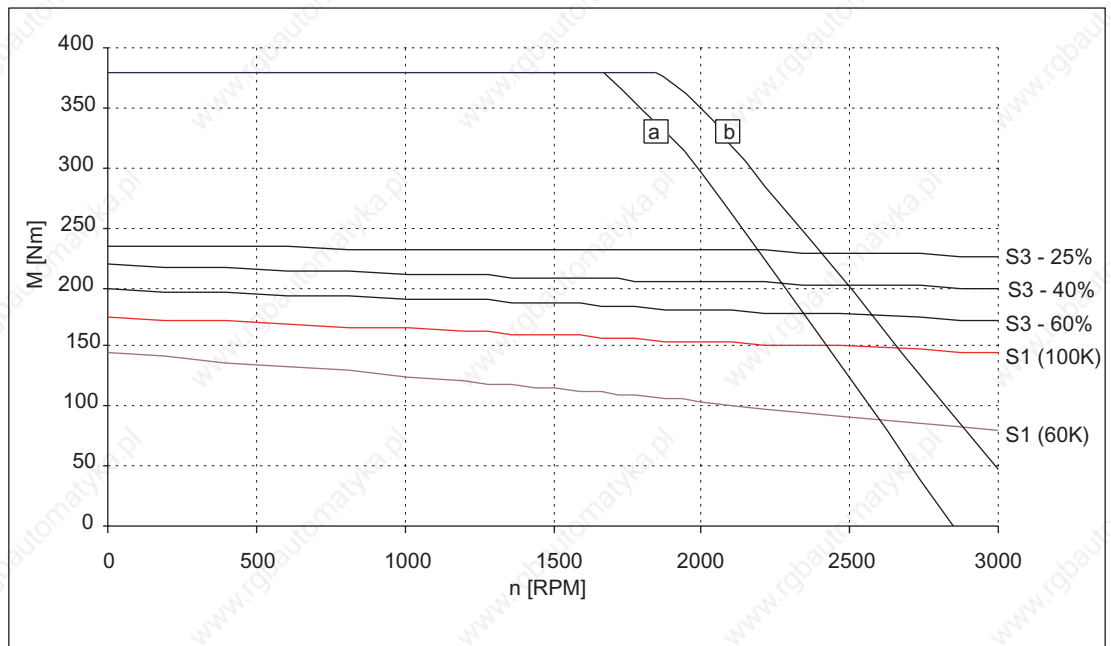

Figure 3-73 Speed-torque diagram 1FT6136-6SC71

[a] SINAMICS S120 SMART LINE,  $V_{DC \text{ link}}=540V$  (DC),  $V_{mot}=380V_{rms}$

[b] SINAMICS S120 ACTIVE LINE,  $V_{DC \text{ link}}=600V$  (DC),  $V_{mot}=425V_{rms}$

## Technical Data and Speed-Torque Diagrams

### 3.1 Speed-torque diagrams

Table 3-44 1FT6136 force ventilated

1FT6136				
Technical data	Code	Units	-6SF71	
Engineering data				
Rated speed	$n_N$	RPM	3000	
No. of poles	2p		6	
Rated torque (100K)	$M_{N(100K)}$	Nm	145	
Rated current (100K)	$I_N(100K)$	A	104	
Stall torque (60K)	$M_0(60K)$	Nm	145	
Stall torque (100K)	$M_0(100K)$	Nm	175	
Stall current (60K)	$I_0(60K)$	A	89	
Stall current (100K)	$I_0(100K)$	A	110	
Moment of inertia (with brake)	$J_{mot}$	$10^{-4}$ kgm <sup>2</sup>	742	
Moment of inertia (without brake)	$J_{mot}$	$10^{-4}$ kgm <sup>2</sup>	664	
Optimum operating point				
Optimum speed	$n_{opt}$	RPM	3000	
Optimum power	$P_{opt}$	kW	46	
Limiting data				
Max. permissible speed (mech.)	$n_{max}$	RPM	3600	
Max. torque	$M_{max}$	Nm	380	
Max. current	$I_{max}$	A	313	
Physical constants				
Torque constant	$k_T$	Nm/A	1.59	
Voltage constant	$k_E$	V/1000 RPM	102	
Winding resistance at 20° C	$R_{ph}$	Ohm	0.025	
Rotating field inductance	$L_D$	mH	0.96	
Electrical time constant	$T_{el}$	ms	44	
Shaft torsional stiffness	$C_t$	Nm/rad	214000	
Mechanical time constant	$T_{mech}$	ms	2.0	
Thermal time constant	$T_{th}$	min	25	
Weight with brake	$m$	kg	131	
Weight without brake	$m$	kg	123	

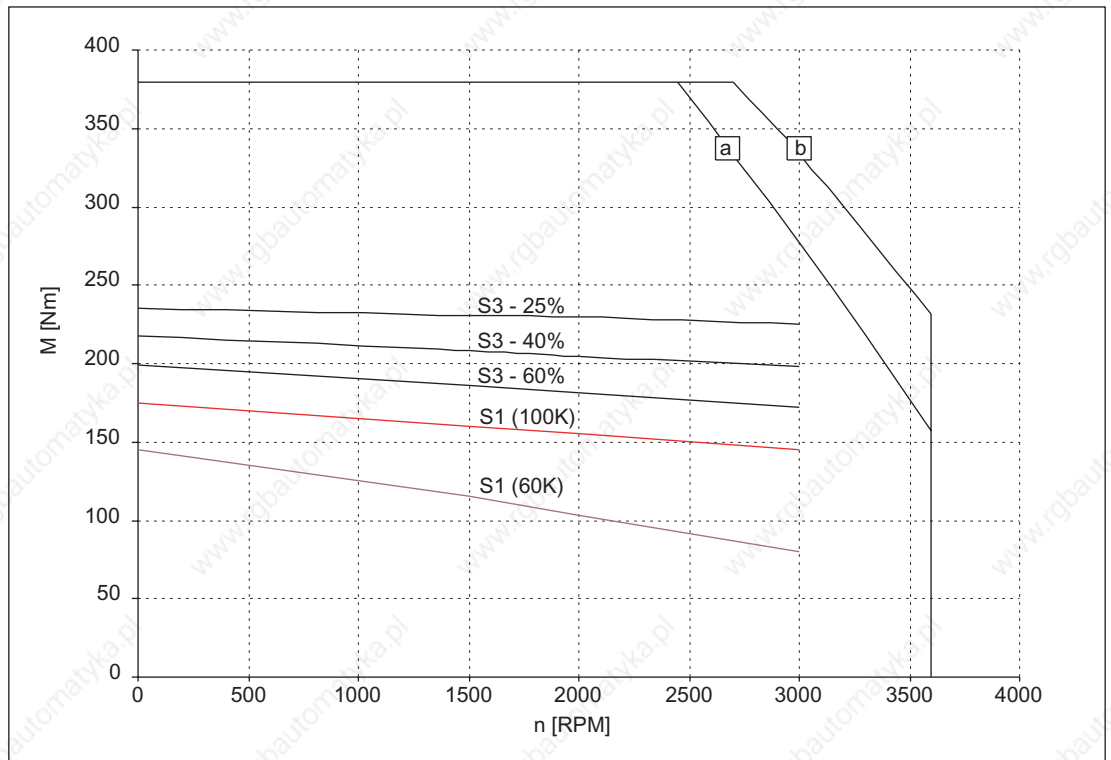

Figure 3-74 Speed-torque diagram 1FT6136-6SF71

[a] SINAMICS S120 SMART LINE,  $V_{\text{DC link}}=540\text{V (DC)}$ ,  $V_{\text{mot}}=380\text{V}_{\text{rms}}$

[b] SINAMICS S120 ACTIVE LINE,  $V_{\text{DC link}}=600\text{V (DC)}$ ,  $V_{\text{mot}}=425\text{V}_{\text{rms}}$

## Technical Data and Speed-Torque Diagrams

### 3.1 Speed-torque diagrams

Table 3-45 1FT6163 force ventilated

1FT6163					
Technical data	Code	Units	-8SB7	-8SD7	
Engineering data					
Rated speed	$n_N$	RPM	1500	2500	
No. of poles	2p		8	8	
Rated torque (100K)	$M_{N(100K)}$	Nm	385	340	
Rated current (100K)	$I_{N(100K)}$	A	136	185	
Stall torque (60K)	$M_0(60K)$	Nm	360	360	
Stall torque (100K) <sup>1)</sup>	$M_0(100K)$	Nm	425	425	
Stall current (60K)	$I_0(60K)$	A	124	186	
Stall current (100K)	$I_0(100K)$	A	151	226	
Moment of inertia (with brake)	$J_{mot}$	$10^{-4}$ kgm <sup>2</sup>	—	—	
Moment of inertia (without brake)	$J_{mot}$	$10^{-4}$ kgm <sup>2</sup>	2300	2300	
Optimum operating point					
Optimum speed	$n_{opt}$	RPM	1500	2500	
Optimum power	$P_{opt}$	kW	60.5	89.0	
Limiting data					
Max. permissible speed (mech.)	$n_{max}$	RPM	3100	3100	
Max. torque	$M_{max}$	Nm	900	900	
Max. current <sup>1)</sup>	$I_{max}$	A	372	558	
Physical constants					
Torque constant	$k_T$	Nm/A	2.81	1.88	
Voltage constant	$k_E$	V/1000 RPM	186	124	
Winding resistance at 20° C	$R_{ph}$	Ohm	0.026	0.012	
Rotating field inductance	$L_D$	mH	0.81	0.36	
Electrical time constant	$T_{el}$	ms	31	30	
Shaft torsional stiffness	$C_t$	Nm/rad	472100	472100	
Mechanical time constant	$T_{mech}$	ms	2.3	2.3	
Thermal time constant	$T_{th}$	min	25	25	
Weight with brake	m	kg	—	—	
Weight without brake	m	kg	170	170	

1) Observe the maximum and rated current of the drive converter

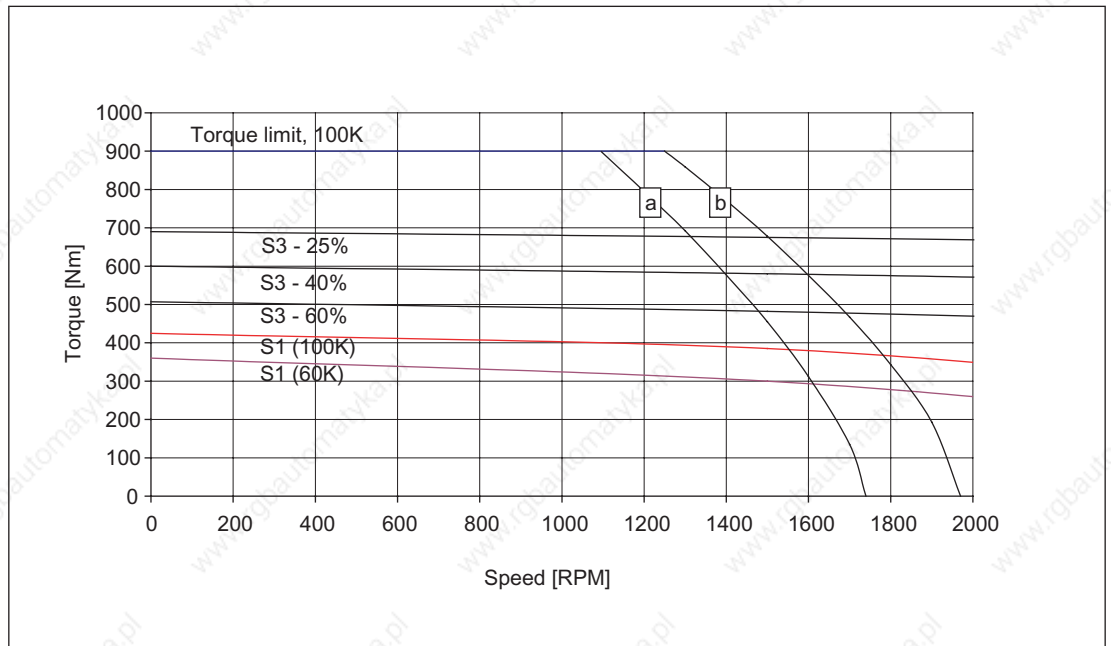

Figure 3-75 Speed-torque diagram 1FT6163-8SB7

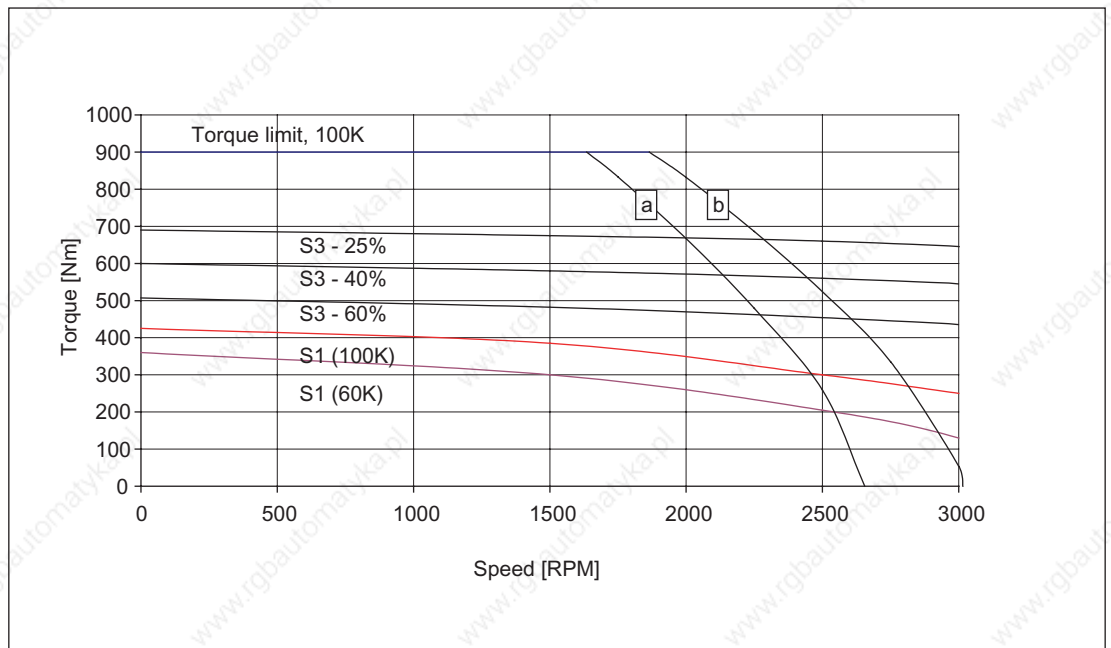

Figure 3-76 Speed-torque diagram 1FT6163-8SD7

[a] SINAMICS S120 SMART LINE,  $V_{DC\ link}=540V\ (DC)$ ,  $V_{mot}=380V_{rms}$

[b] SINAMICS S120 ACTIVE LINE,  $V_{DC\ link}=600V\ (DC)$ ,  $V_{mot}=425V_{rms}$

## Technical Data and Speed-Torque Diagrams

### 3.1 Speed-torque diagrams

Table 3-46 1FT6168 force ventilated

1FT6168				
Technical data	Code	Units	-8SB7	
Engineering data				
Rated speed	$n_N$	RPM	1500	
No. of poles	2p		8	
Rated torque (100K)	$M_{N(100K)}$	Nm	540	
Rated current (100K)	$I_N(100K)$	A	174	
Stall torque (60K)	$M_0(60K)$	Nm	510	
Stall torque (100K)	$M_0(100K)$	Nm	600	
Stall current (60K)	$I_0(60K)$	A	165	
Stall current (100K)	$I_0(100K)$	A	194	
Moment of inertia (with brake)	$J_{mot}$	$10^{-4}$ kgm <sup>2</sup>	—	
Moment of inertia (without brake)	$J_{mot}$	$10^{-4}$ kgm <sup>2</sup>	3100	
Optimum operating point				
Optimum speed	$n_{opt}$	RPM	1500	
Optimum power	$P_{opt}$	kW	85	
Limiting data				
Max. permissible speed (mech.)	$n_{max}$	RPM	3100	
Max. torque	$M_{max}$	Nm	1200	
Max. current <sup>1)</sup>	$I_{max}$	A	479	
Physical constants				
Torque constant	$k_T$	Nm/A	3.09	
Voltage constant	$k_E$	V/1000 RPM	203	
Winding resistance at 20° C	$R_{ph}$	Ohm	0.02	
Rotating field inductance	$L_D$	mH	0.69	
Electrical time constant	$T_{el}$	ms	35	
Shaft torsional stiffness	$C_t$	Nm/rad	431600	
Mechanical time constant	$T_{mech}$	ms	1.9	
Thermal time constant	$T_{th}$	min	25	
Weight with brake	$m$	kg	—	
Weight without brake	$m$	kg	210	

1) Observe the maximum and rated current of the drive converter

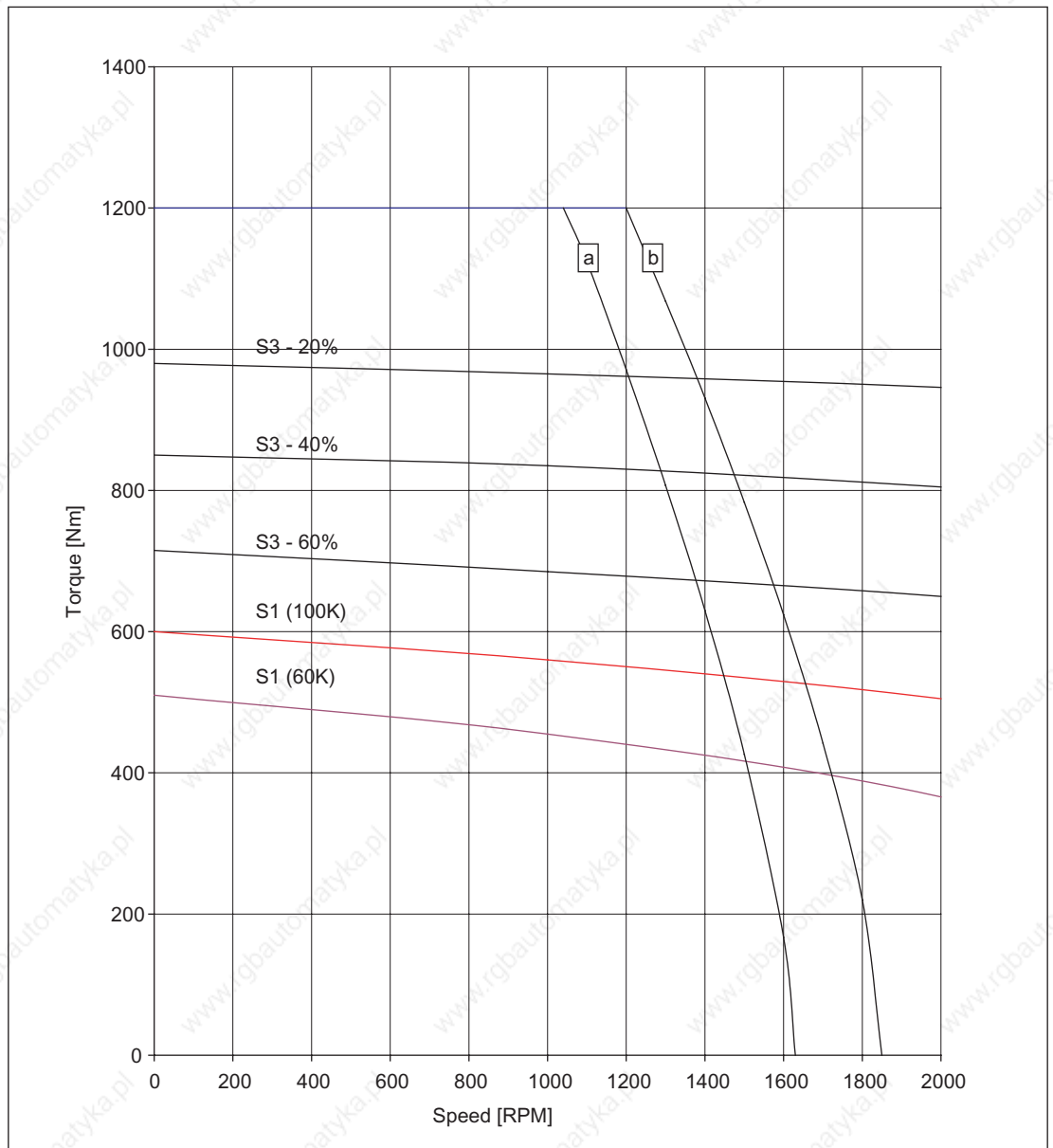

Figure 3-77 Speed-torque diagram 1FT6168-8SB7

[a] SINAMICS S120 SMART LINE,  $V_{DC \text{ link}}=540V$  (DC),  $V_{mot}=380V_{rms}$

[b] SINAMICS S120 ACTIVE LINE,  $V_{DC \text{ link}}=600V$  (DC),  $V_{mot}=425V_{rms}$

3.1 Speed-torque diagrams

3.1.4 1FT6 series, water cooled

Table 3-47 1FT6062, water cooled

1FT6062					
Technical data	Code	Unit	-6WF7□		
Engineering data					
Rated speed	$n_N$	RPM	3000		
Pole number	2p		6		
Rated torque (100K)	$M_{N(100K)}$	Nm	10.1		
Rated current (100K)	$I_N(100K)$	A	6.9		
Stall torque (60K)	$M_0(60K)$	Nm	8.5		
Stall torque (100K)	$M_0(100K)$	Nm	10.2		
Stall current (60K)	$I_0(60K)$	A	5.6		
Stall current (100K)	$I_0(100K)$	A	6.9		
Moment of inertia (with brake)	$J_{mot}$	$10^{-4}$ kgm <sup>2</sup>	11.8		
Moment of inertia (without brake)	$J_{mot}$	$10^{-4}$ kgm <sup>2</sup>	8.5		
Optimum operating point					
Optimum speed	$n_{opt}$	RPM	3000		
Optimum power	$P_{opt}$	kW	3.19		
Limiting data					
Max. permissible speed (mech.)	$n_{max}$	RPM	9100		
Max. torque	$M_{max}$	Nm	24		
Max. current	$I_{max}$	A	22		
Physical constants					
Torque constant	$k_T$	Nm/A	1.48		
Voltage constant	$k_E$	V/1000 RPM	94		
Winding resistance at 20° C	$R_{ph}$	Ohm	2.57		
Rotating field inductance	$L_D$	mH	19		
Electrical time constant	$T_{el}$	ms	7.4		
Shaft torsional stiffness	$C_t$	Nm/rad	32000		
Mechanical time constant	$T_{mech}$	ms	3.0		
Thermal time constant	$T_{th}$	min	1.5		
Weight with brake	m	kg	11		
Weight without brake	m	kg	9.5		



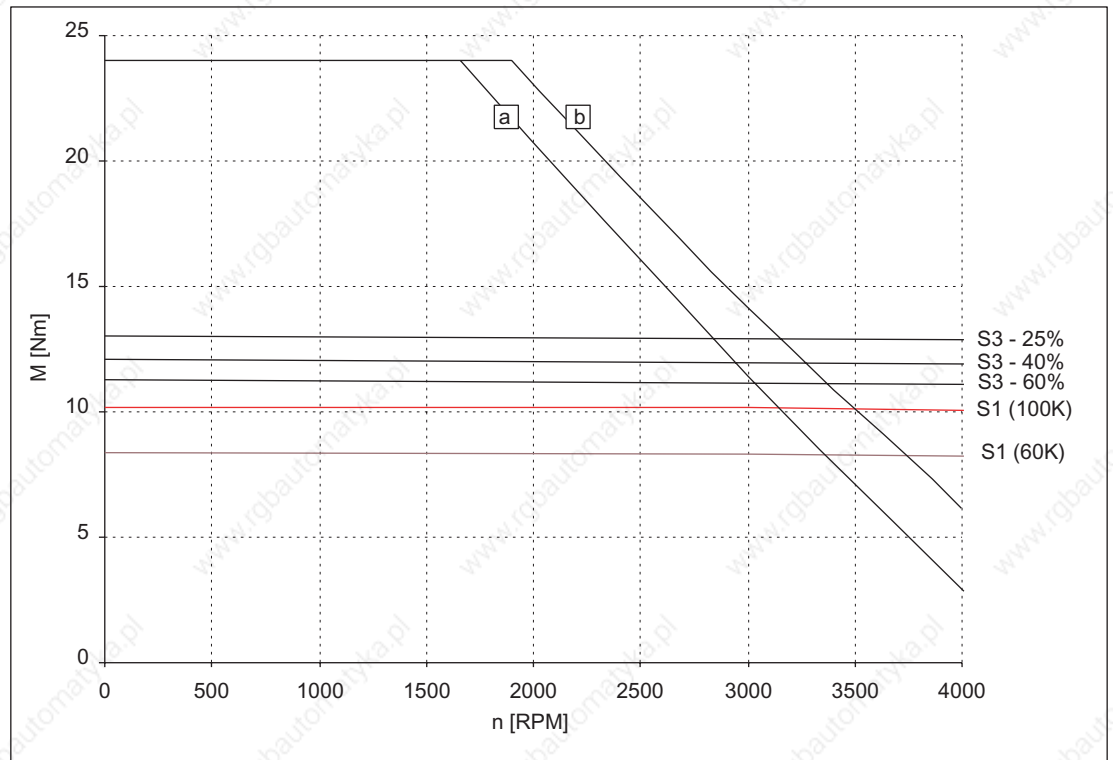

Figure 3-78 Speed-torque diagram 1FT6062-6WF7□

[a] SINAMICS S120 SMART LINE,  $V_{DC \text{ link}}=540V$  (DC),  $V_{mot}=380V_{rms}$

[b] SINAMICS S120 ACTIVE LINE,  $V_{DC \text{ link}}=600V$  (DC),  $V_{mot}=425V_{rms}$

## Technical Data and Speed-Torque Diagrams

### 3.1 Speed-torque diagrams

Table 3-48 1FT6062, water cooled

1FT6062					
Technical data	Code	Unit	-6WH7□	-6WK7□	
Engineering data					
Rated speed	$n_N$	RPM	4500	6000	
Pole number	2p		6	6	
Rated torque (100K)	$M_{N(100K)}$	Nm	10	9.8	
Rated current (100K)	$I_N(100K)$	A	9.6	12.7	
Stall torque (60K)	$M_0(60K)$	Nm	8.5	8.5	
Stall torque (100K)	$M_0(100K)$	Nm	10.2	10.2	
Stall current (60K)	$I_0(60K)$	A	7.9	10.6	
Stall current (100K)	$I_0(100K)$	A	9.7	12.9	
Moment of inertia (with brake)	$J_{mot}$	$10^{-4}$ kgm <sup>2</sup>	11.8	11.8	
Moment of inertia (without brake)	$J_{mot}$	$10^{-4}$ kgm <sup>2</sup>	8.5	8.5	
Optimum operating point					
Optimum speed	$n_{opt}$	RPM	4500	6000	
Optimum power	$P_{opt}$	kW	4.71	6.16	
Limiting data					
Max. permissible speed (mech.)	$n_{max}$	RPM	9100	9100	
Max. torque	$M_{max}$	Nm	24	24	
Max. current	$I_{max}$	A	31	41	
Physical constants					
Torque constant	$k_T$	Nm/A	1.05	0.79	
Voltage constant	$k_E$	V/1000 RPM	67	50	
Winding resistance at 20° C	$R_{ph}$	Ohm	1.31	0.74	
Rotating field inductance	$L_D$	mH	9.7	5.5	
Electrical time constant	$T_{el}$	ms	7.4	7.4	
Shaft torsional stiffness	$C_t$	Nm/rad	32000	32000	
Mechanical time constant	$T_{mech}$	ms	3.0	3.0	
Thermal time constant	$T_{th}$	min	1.5	1.5	
Weight with brake	m	kg	11	11	
Weight without brake	m	kg	9.5	9.5	

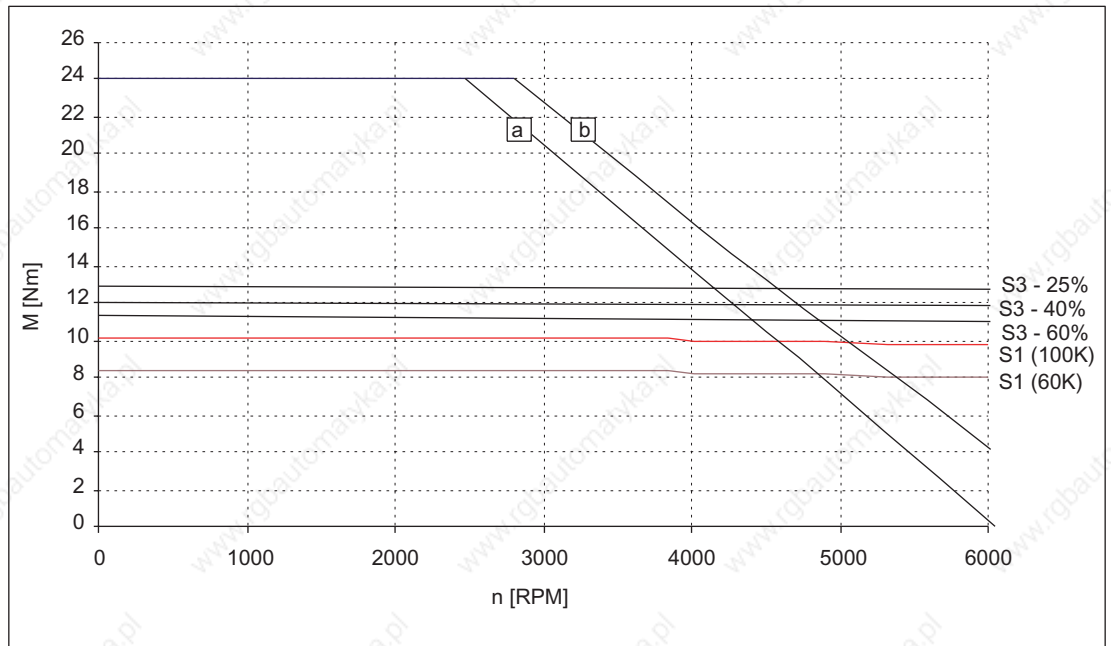

Figure 3-79 Speed-torque diagram 1FT6062-6WH7□

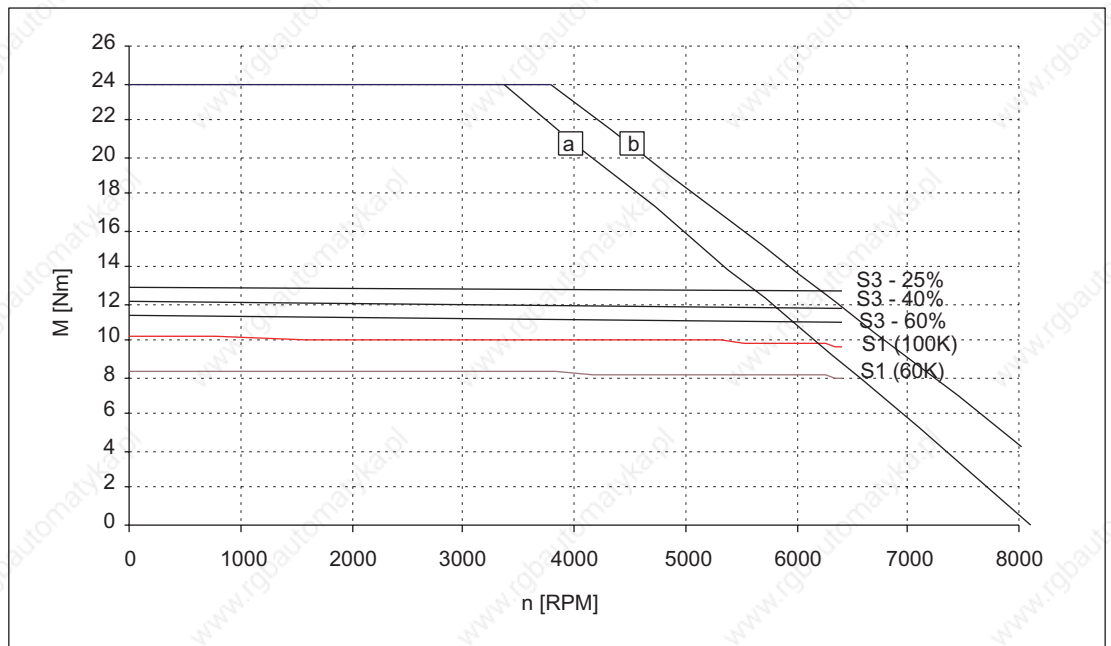

Figure 3-80 Speed-torque diagram 1FT6062-6WK7□

[a] SINAMICS S120 SMART LINE,  $V_{\text{DC link}}=540\text{V (DC)}$ ,  $V_{\text{mot}}=380\text{V}_{\text{rms}}$

[b] SINAMICS S120 ACTIVE LINE,  $V_{\text{DC link}}=600\text{V (DC)}$ ,  $V_{\text{mot}}=425\text{V}_{\text{rms}}$

## Technical Data and Speed-Torque Diagrams

### 3.1 Speed-torque diagrams

Table 3-49 1FT6064, water cooled

1FT6064				
Technical data	Code	Unit	-6WF7□	
Engineering data				
Rated speed	$n_N$	RPM	3000	
Pole number	2p		6	
Rated torque (100K)	$M_{N(100K)}$	Nm	16.1	
Rated current (100K)	$I_N(100K)$	A	10.3	
Stall torque (60K)	$M_0(60K)$	Nm	13.4	
Stall torque (100K)	$M_0(100K)$	Nm	16.2	
Stall current (60K)	$I_0(60K)$	A	8.4	
Stall current (100K)	$I_0(100K)$	A	10.3	
Moment of inertia (with brake)	$J_{mot}$	$10^{-4}$ kgm <sup>2</sup>	16.3	
Moment of inertia (without brake)	$J_{mot}$	$10^{-4}$ kgm <sup>2</sup>	13	
Optimum operating point				
Optimum speed	$n_{opt}$	RPM	3000	
Optimum power	$P_{opt}$	kW	5.06	
Limiting data				
Max. permissible speed (mech.)	$n_{max}$	RPM	9100	
Max. torque	$M_{max}$	Nm	38	
Max. current	$I_{max}$	A	33	
Physical constants				
Torque constant	$k_T$	Nm/A	1.57	
Voltage constant	$k_E$	V/1000 RPM	100	
Winding resistance at 20° C	$R_{ph}$	Ohm	1.40	
Rotating field inductance	$L_D$	mH	13.5	
Electrical time constant	$T_{el}$	ms	9.6	
Shaft torsional stiffness	$C_t$	Nm/rad	27000	
Mechanical time constant	$T_{mech}$	ms	2.2	
Thermal time constant	$T_{th}$	min	1.5	
Weight with brake	m	kg	13	
Weight without brake	m	kg	12.5	

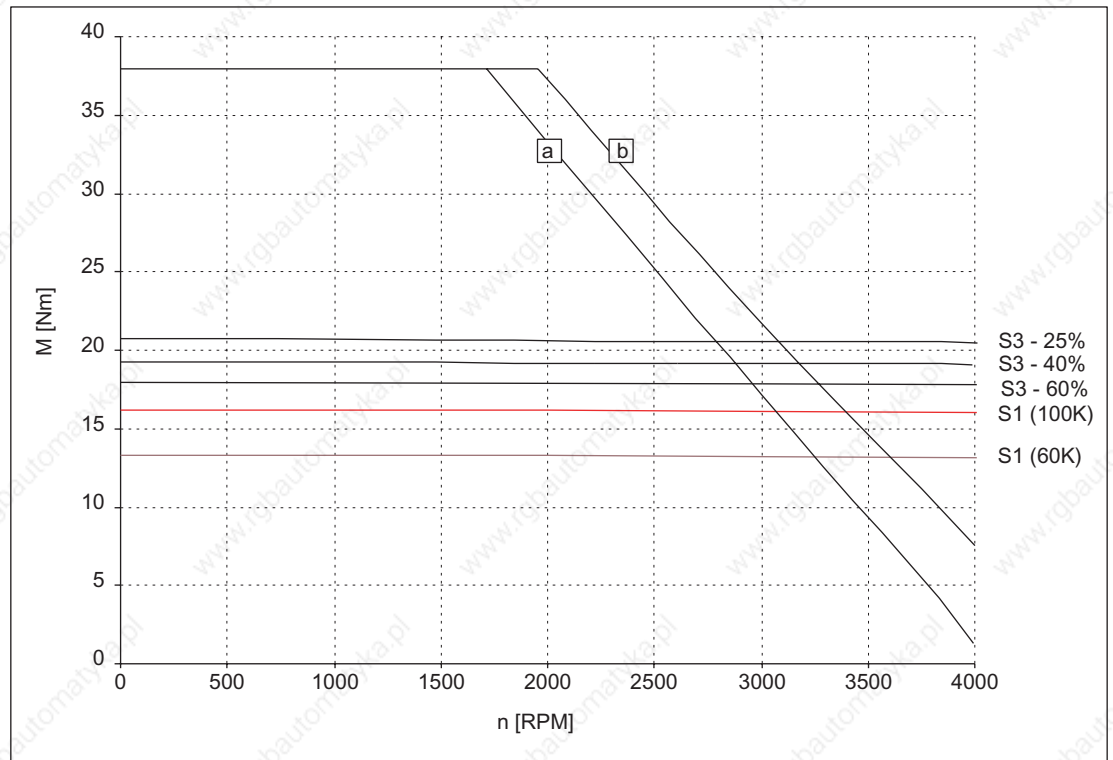

Figure 3-81 Speed-torque diagram 1FT6064-6WF7□

[a] SINAMICS S120 SMART LINE,  $V_{DC \text{ link}}=540V$  (DC),  $V_{mot}=380V_{rms}$

[b] SINAMICS S120 ACTIVE LINE,  $V_{DC \text{ link}}=600V$  (DC),  $V_{mot}=425V_{rms}$

## Technical Data and Speed-Torque Diagrams

### 3.1 Speed-torque diagrams

Table 3-50 1FT6064, water cooled

1FT6064					
Technical data	Code	Unit	-6WH7□	-6WK7□	
Engineering data					
Rated speed	$n_N$	RPM	4500	6000	
Pole number	2p		6	6	
Rated torque (100K)	$M_{N(100K)}$	Nm	16	15.8	
Rated current (100K)	$I_N(100K)$	A	15.2	20	
Stall torque (60K)	$M_0(60K)$	Nm	13.4	13.4	
Stall torque (100K)	$M_0(100K)$	Nm	16.2	16.2	
Stall current (60K)	$I_0(60K)$	A	12.5	16.7	
Stall current (100K)	$I_0(100K)$	A	15.4	20.5	
Moment of inertia (with brake)	$J_{mot}$	$10^{-4}$ kgm <sup>2</sup>	16.3	16.3	
Moment of inertia (without brake)	$J_{mot}$	$10^{-4}$ kgm <sup>2</sup>	13	13	
Optimum operating point					
Optimum speed	$n_{opt}$	RPM	4500	6000	
Optimum power	$P_{opt}$	kW	7.54	9.93	
Limiting data					
Max. permissible speed (mech.)	$n_{max}$	RPM	9100	9100	
Max. torque	$M_{max}$	Nm	38	38	
Max. current	$I_{max}$	A	49	66	
Physical constants					
Torque constant	$k_T$	Nm/A	1.05	0.79	
Voltage constant	$k_E$	V/1000 RPM	67	50	
Winding resistance at 20° C	$R_{ph}$	Ohm	0.63	0.35	
Rotating field inductance	$L_D$	mH	6	3.4	
Electrical time constant	$T_{el}$	ms	9.5	9.7	
Shaft torsional stiffness	$C_t$	Nm/rad	27000	27000	
Mechanical time constant	$T_{mech}$	ms	2.2	2.2	
Thermal time constant	$T_{th}$	min	1.5	1.5	
Weight with brake	m	kg	13	13	
Weight without brake	m	kg	12.5	12.5	

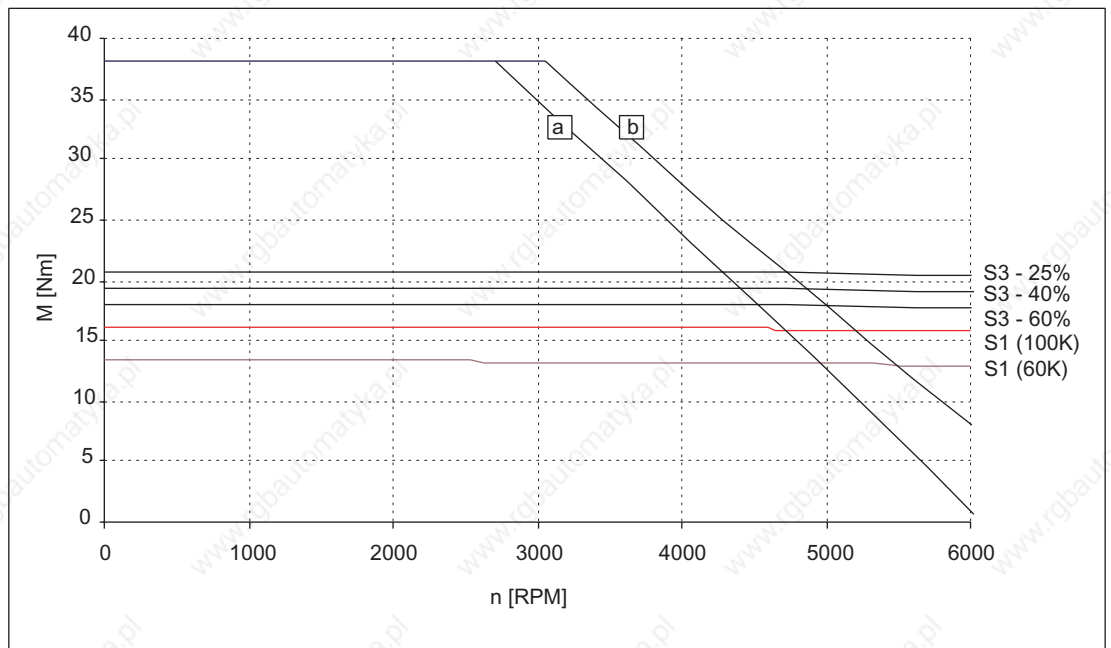

Figure 3-82 Speed-torque diagram 1FT6064-6WH7□

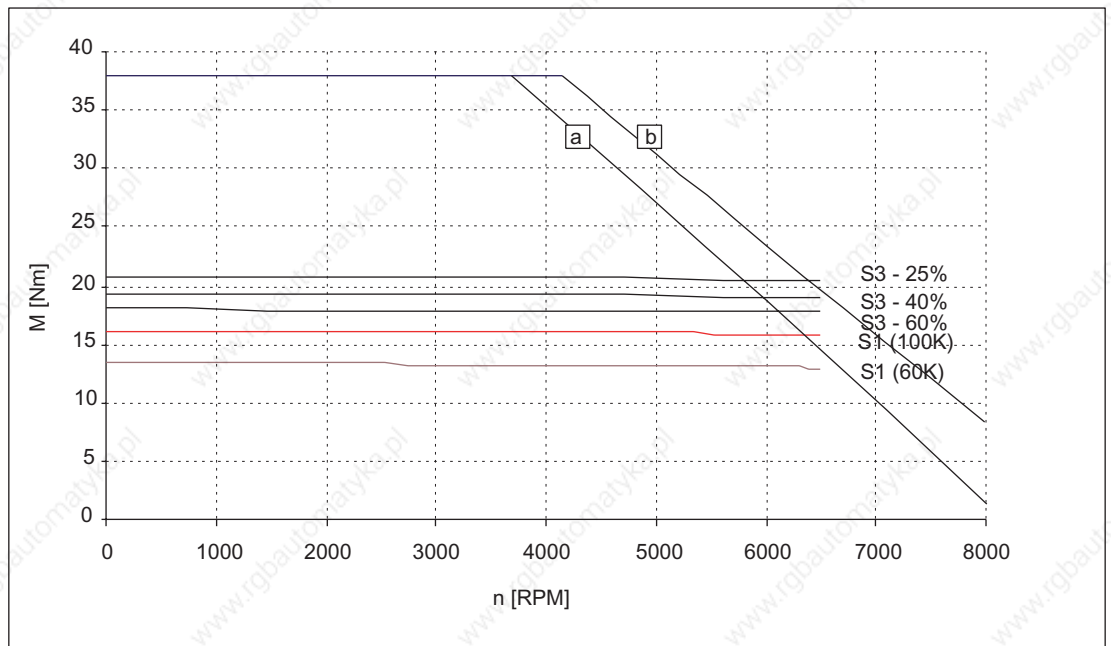

Figure 3-83 Speed-torque diagram 1FT6064-6WK7□

[a] SINAMICS S120 SMART LINE,  $V_{DC\ link}=540V\ (DC)$ ,  $V_{mot}=380V_{rms}$

[b] SINAMICS S120 ACTIVE LINE,  $V_{DC\ link}=600V\ (DC)$ ,  $V_{mot}=425V_{rms}$

## Technical Data and Speed-Torque Diagrams

### 3.1 Speed-torque diagrams

Table 3-51 1FT6084, water cooled

1FT6084				
Technical data	Code	Unit	-8WF7□	
Engineering data				
Rated speed	$n_N$	RPM	3000	
Pole number	2p		8	
Rated torque (100K)	$M_{N(100K)}$	Nm	35	
Rated current (100K)	$I_N(100K)$	A	27	
Stall torque (60K)	$M_0(60K)$	Nm	29	
Stall torque (100K)	$M_0(100K)$	Nm	35	
Stall current (60K)	$I_0(60K)$	A	19.9	
Stall current (100K)	$I_0(100K)$	A	24.5	
Moment of inertia (with brake)	$J_{mot}$	$10^{-4}$ kgm <sup>2</sup>	61.1	
Moment of inertia (without brake)	$J_{mot}$	$10^{-4}$ kgm <sup>2</sup>	48	
Optimum operating point				
Optimum speed	$n_{opt}$	RPM	3000	
Optimum power	$P_{opt}$	kW	11.0	
Limiting data				
Max. permissible speed (mech.)	$n_{max}$	RPM	7900	
Max. torque	$M_{max}$	Nm	65	
Max. current	$I_{max}$	A	59	
Physical constants				
Torque constant	$k_T$	Nm/A	1.43	
Voltage constant	$k_E$	V/1000 RPM	91	
Winding resistance at 20° C	$R_{ph}$	Ohm	0.37	
Rotating field inductance	$L_D$	mH	4.3	
Electrical time constant	$T_{el}$	ms	11.6	
Shaft torsional stiffness	$C_t$	Nm/rad	76000	
Mechanical time constant	$T_{mech}$	ms	2.6	
Thermal time constant	$T_{th}$	min	1.5	
Weight with brake	$m$	kg	24.5	
Weight without brake	$m$	kg	21	



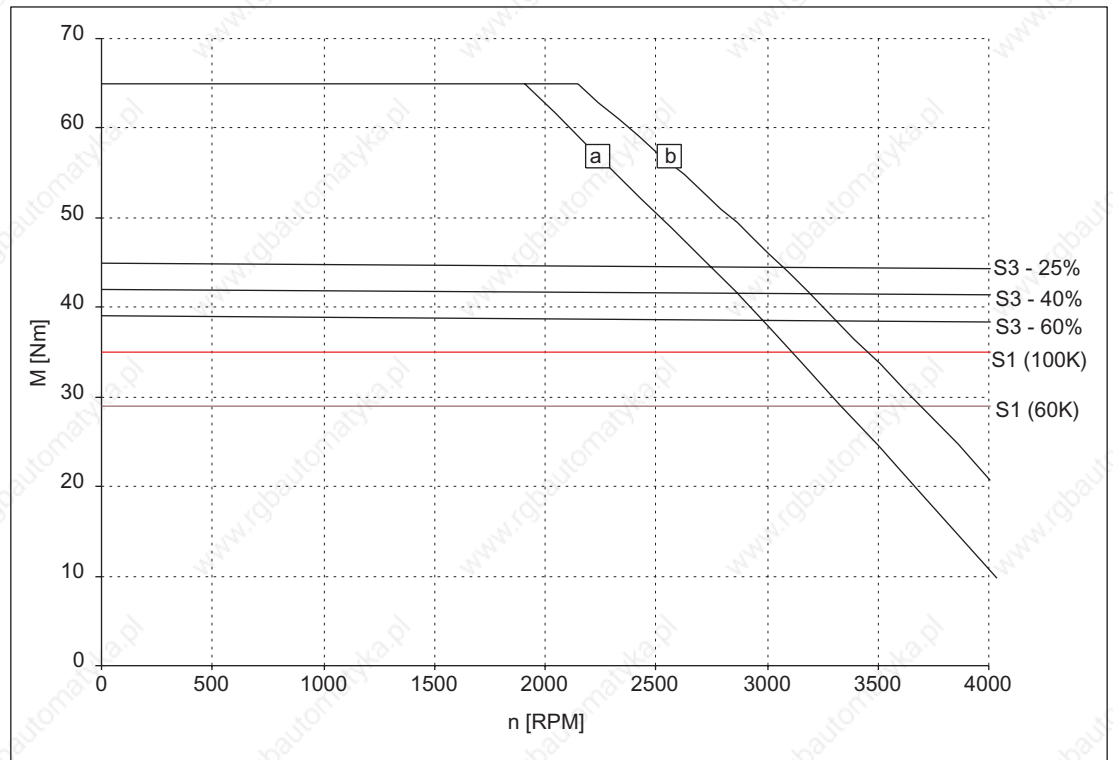

Figure 3-84 Speed-torque diagram 1FT6084-8WF7□

[a] SINAMICS S120 SMART LINE,  $V_{DC \text{ link}}=540V$  (DC),  $V_{mot}=380V_{rms}$

[b] SINAMICS S120 ACTIVE LINE,  $V_{DC \text{ link}}=600V$  (DC),  $V_{mot}=425V_{rms}$

## Technical Data and Speed-Torque Diagrams

### 3.1 Speed-torque diagrams

Table 3-52 1FT6084, water cooled

1FT6084					
Technical data	Code	Unit	-8WH7□	-8WK7□	
Engineering data					
Rated speed	$n_N$	RPM	4500	6000	
Pole number	2p		8	8	
Rated torque (100K)	$M_{N(100K)}$	Nm	35	34	
Rated current (100K)	$I_N(100K)$	A	39	51	
Stall torque (60K)	$M_0(60K)$	Nm	29	29	
Stall torque (100K)	$M_0(100K)$	Nm	35	35	
Stall current (60K)	$I_0(60K)$	A	30	38	
Stall current (100K)	$I_0(100K)$	A	37	47	
Moment of inertia (with brake)	$J_{mot}$	$10^{-4}$ kgm <sup>2</sup>	61.1	61.1	
Moment of inertia (without brake)	$J_{mot}$	$10^{-4}$ kgm <sup>2</sup>	48	48	
Optimum operating point					
Optimum speed	$n_{opt}$	RPM	4500	6000	
Optimum power	$P_{opt}$	kW	16.5	21.4	
Limiting data					
Max. permissible speed (mech.)	$n_{max}$	RPM	7900	7900	
Max. torque	$M_{max}$	Nm	65	65	
Max. current	$I_{max}$	A	90	112	
Physical constants					
Torque constant	$k_T$	Nm/A	0.96	0.74	
Voltage constant	$k_E$	V/1000 RPM	61	47	
Winding resistance at 20° C	$R_{ph}$	Ohm	0.17	0.1	
Rotating field inductance	$L_D$	mH	1.9	1.2	
Electrical time constant	$T_{el}$	ms	11.2	12.0	
Shaft torsional stiffness	$C_t$	Nm/rad	76000	76000	
Mechanical time constant	$T_{mech}$	ms	2.7	2.6	
Thermal time constant	$T_{th}$	min	1.5	1.5	
Weight with brake	m	kg	24	26	
Weight without brake	m	kg	21	21	

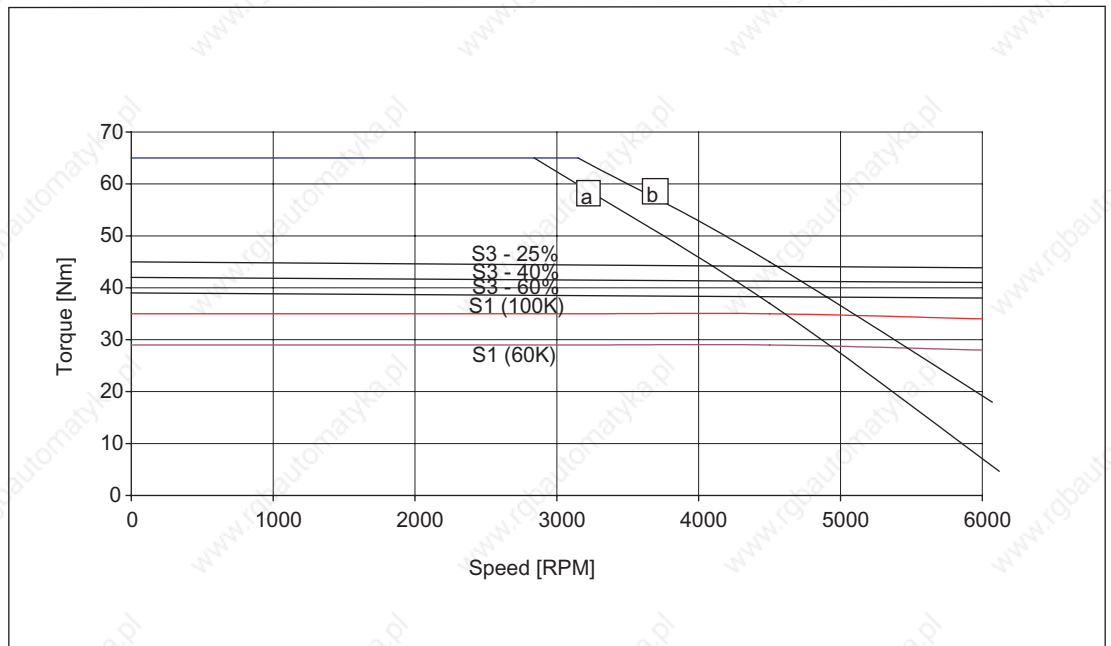

Figure 3-85 Speed-torque diagram 1FT6084-8WH71

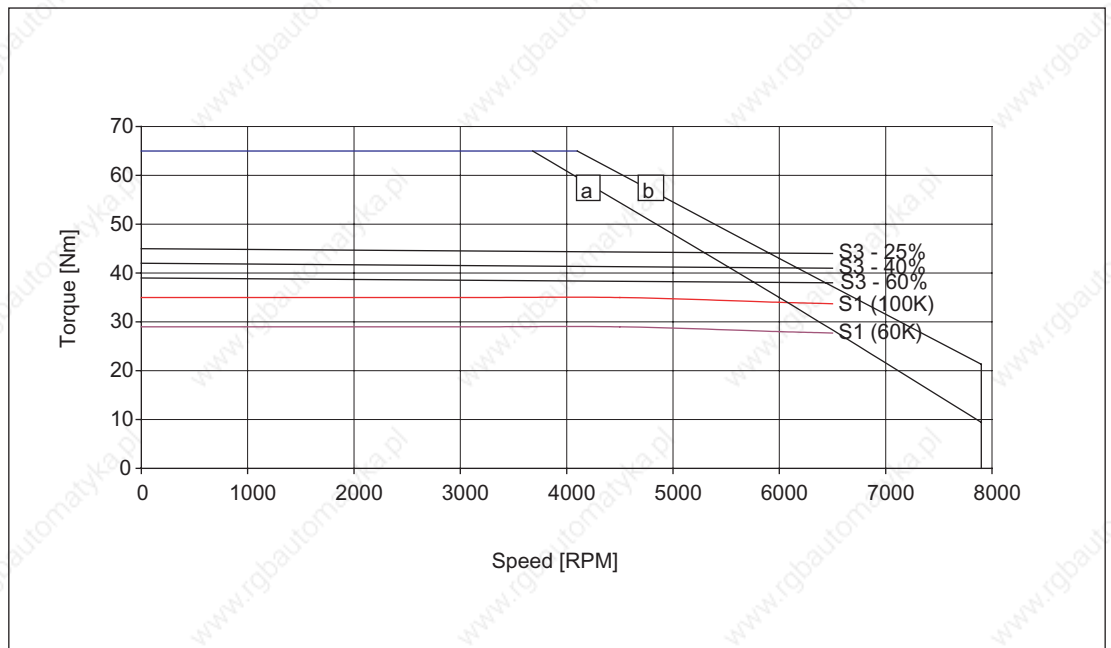

Figure 3-86 Speed-torque diagram 1FT6084-8WK71

[a] SINAMICS S120 SMART LINE,  $V_{DC \text{ link}}=540V$  (DC),  $V_{mot}=380V_{rms}$

[b] SINAMICS S120 ACTIVE LINE,  $V_{DC \text{ link}}=600V$  (DC),  $V_{mot}=425V_{rms}$

## Technical Data and Speed-Torque Diagrams

### 3.1 Speed-torque diagrams

Table 3-53 1FT6086, water cooled

1FT6086				
Technical data	Code	Unit	-8WF7□	
Engineering data				
Rated speed	$n_N$	RPM	3000	
Pole number	2p		8	
Rated torque (100K)	$M_{N(100K)}$	Nm	46	
Rated current (100K)	$I_N(100K)$	A	37	
Stall torque (60K)	$M_0(60K)$	Nm	39	
Stall torque (100K)	$M_0(100K)$	Nm	47	
Stall current (60K)	$I_0(60K)$	A	27	
Stall current (100K)	$I_0(100K)$	A	34	
Moment of inertia (with brake)	$J_{mot}$	$10^{-4}$ kgm <sup>2</sup>	79.6	
Moment of inertia (without brake)	$J_{mot}$	$10^{-4}$ kgm <sup>2</sup>	66.5	
Optimum operating point				
Optimum speed	$n_{opt}$	RPM	3000	
Optimum power	$P_{opt}$	kW	14.5	
Limiting data				
Max. permissible speed (mech.)	$n_{max}$	RPM	7900	
Max. torque	$M_{max}$	Nm	90	
Max. current	$I_{max}$	A	80	
Physical constants				
Torque constant	$k_T$	Nm/A	1.4	
Voltage constant	$k_E$	V/1000 RPM	89	
Winding resistance at 20° C	$R_{ph}$	Ohm	0.23	
Rotating field inductance	$L_D$	mH	2.9	
Electrical time constant	$T_{el}$	ms	12.6	
Shaft torsional stiffness	$C_t$	Nm/rad	65000	
Mechanical time constant	$T_{mech}$	ms	2.3	
Thermal time constant	$T_{th}$	min	1.5	
Weight with brake	$m$	kg	29.5	
Weight without brake	$m$	kg	26	

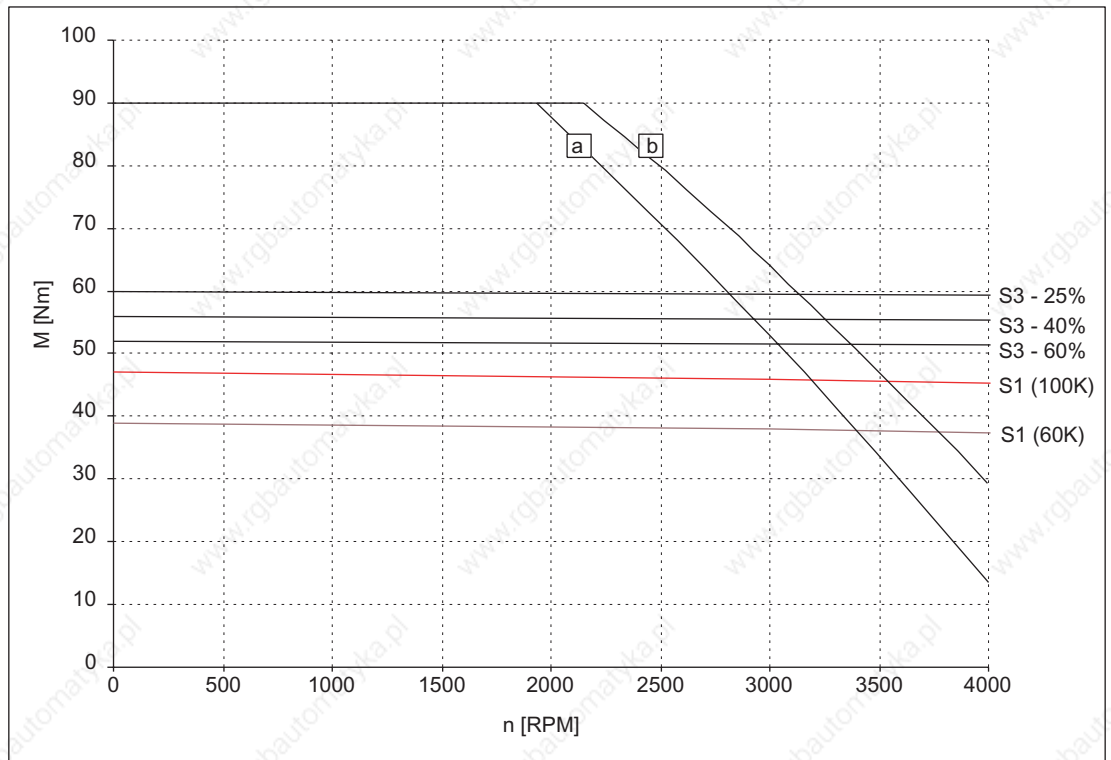

Figure 3-87 Speed-torque diagram 1FT6086-8WF7

[a] SINAMICS S120 SMART LINE,  $V_{DC \text{ link}}=540V$  (DC),  $V_{mot}=380V_{rms}$

[b] SINAMICS S120 ACTIVE LINE,  $V_{DC \text{ link}}=600V$  (DC),  $V_{mot}=425V_{rms}$

## Technical Data and Speed-Torque Diagrams

### 3.1 Speed-torque diagrams

Table 3-54 1FT6086, water cooled

1FT6086					
Technical data	Code	Unit	-8WH7□	-8WK7□	
Engineering data					
Rated speed	$n_N$	RPM	4500 <sup>1)</sup>	6000	
Pole number	2p		8	8	
Rated torque (100K)	$M_{N(100K)}$	Nm	45 <sup>1)</sup>	44	
Rated current (100K)	$I_N(100K)$	A	53 <sup>1)</sup>	58	
Stall torque (60K)	$M_0(60K)$	Nm	39	39	
Stall torque (100K)	$M_0(100K)$	Nm	47	47	
Stall current (60K)	$I_0(60K)$	A	42	48	
Stall current (100K)	$I_0(100K)$	A	52.0	59	
Moment of inertia (with brake)	$J_{mot}$	$10^{-4}$ kgm <sup>2</sup>	79.6	79.6	
Moment of inertia (without brake)	$J_{mot}$	$10^{-4}$ kgm <sup>2</sup>	66.5	66.5	
Optimum operating point					
Optimum speed	$n_{opt}$	RPM	4500	6000	
Optimum power	$P_{opt}$	kW	21.2	27.6	
Limiting data					
Max. permissible speed (mech.)	$n_{max}$	RPM	7900	7900	
Max. torque	$M_{max}$	Nm	90	90	
Max. current	$I_{max}$	A	122	141	
Physical constants					
Torque constant	$k_T$	Nm/A	0.91	0.80	
Voltage constant	$k_E$	V/1000 RPM	58	51	
Winding resistance at 20° C	$R_{ph}$	Ohm	0.096	0.072	
Rotating field inductance	$L_D$	mH	1.3	0.95	
Electrical time constant	$T_{el}$	ms	13.5	13.2	
Shaft torsional stiffness	$C_t$	Nm/rad	65000	65000	
Mechanical time constant	$T_{mech}$	ms	2.3	2.2	
Thermal time constant	$T_{th}$	min	1.5	1.5	
Weight with brake	m	kg	29.5	29.5	
Weight without brake	m	kg	26	26	

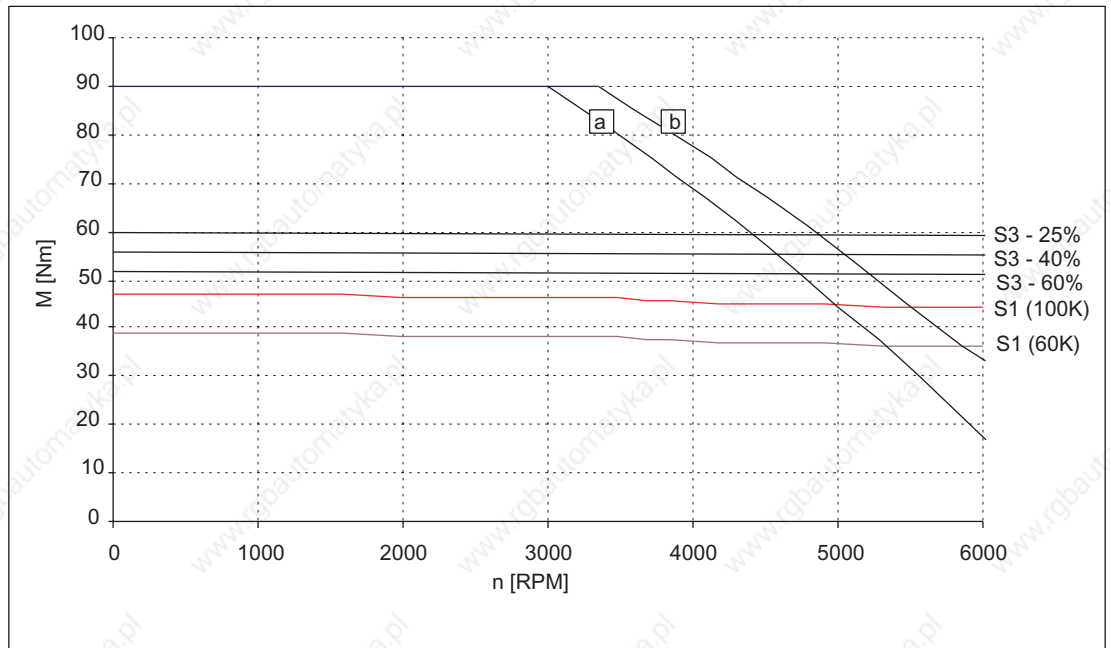

Figure 3-88 Speed-torque diagram 1FT6086-8WH7□

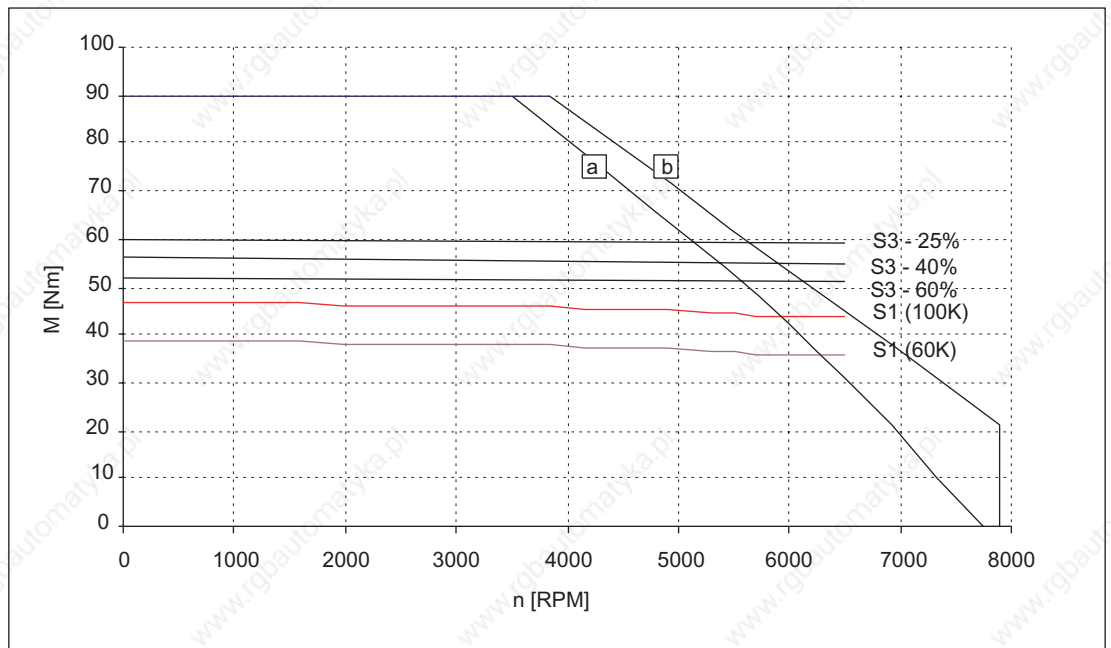

Figure 3-89 Speed-torque diagram 1FT6086-8WK7□

[a] SINAMICS S120 SMART LINE,  $V_{DC \text{ link}}=540V$  (DC),  $V_{mot}=380V_{rms}$

[b] SINAMICS S120 ACTIVE LINE,  $V_{DC \text{ link}}=600V$  (DC),  $V_{mot}=425V_{rms}$

## Technical Data and Speed-Torque Diagrams

### 3.1 Speed-torque diagrams

Table 3-55 1FT6105, water cooled

1FT6105					
Technical data	Code	Unit	-8WC7□	-8WF7□	
Engineering data					
Rated speed	$n_N$	RPM	2000	3000	
Pole number	2p		8	8	
Rated torque (100K)	$M_{N(100K)}$	Nm	82	78	
Rated current (100K)	$I_N(100K)$	A	60	82	
Stall torque (60K)	$M_0(60K)$	Nm	70	70	
Stall torque (100K)	$M_0(100K)$	Nm	85	85	
Stall current (60K)	$I_0(60K)$	A	47	67	
Stall current (100K)	$I_0(100K)$	A	58	83	
Moment of inertia (with brake)	$J_{mot}$	$10^{-4}$ kgm <sup>2</sup>	199	199	
Moment of inertia (without brake)	$J_{mot}$	$10^{-4}$ kgm <sup>2</sup>	168	168	
Optimum operating point					
Optimum speed	$n_{opt}$	RPM	2000	3000	
Optimum power	$P_{opt}$	kW	17.2	24.5	
Limiting data					
Max. permissible speed (mech.)	$n_{max}$	RPM	5600	5600	
Max. torque	$M_{max}$	Nm	140	140	
Max. current	$I_{max}$	A	155	221	
Physical constants					
Torque constant	$k_T$	Nm/A	1.45	1.02	
Voltage constant	$k_E$	V/1000 RPM	99	70	
Winding resistance at 20° C	$R_{ph}$	Ohm	0.098	0.048	
Rotating field inductance	$L_D$	mH	2.1	1.0	
Electrical time constant	$T_{el}$	ms	21	21	
Shaft torsional stiffness	$C_t$	Nm/rad	113000	113000	
Mechanical time constant	$T_{mech}$	ms	2.3	2.3	
Thermal time constant	$T_{th}$	min	1.5	1.5	
Weight with brake	m	kg	50	50	
Weight without brake	m	kg	45.5	45.5	



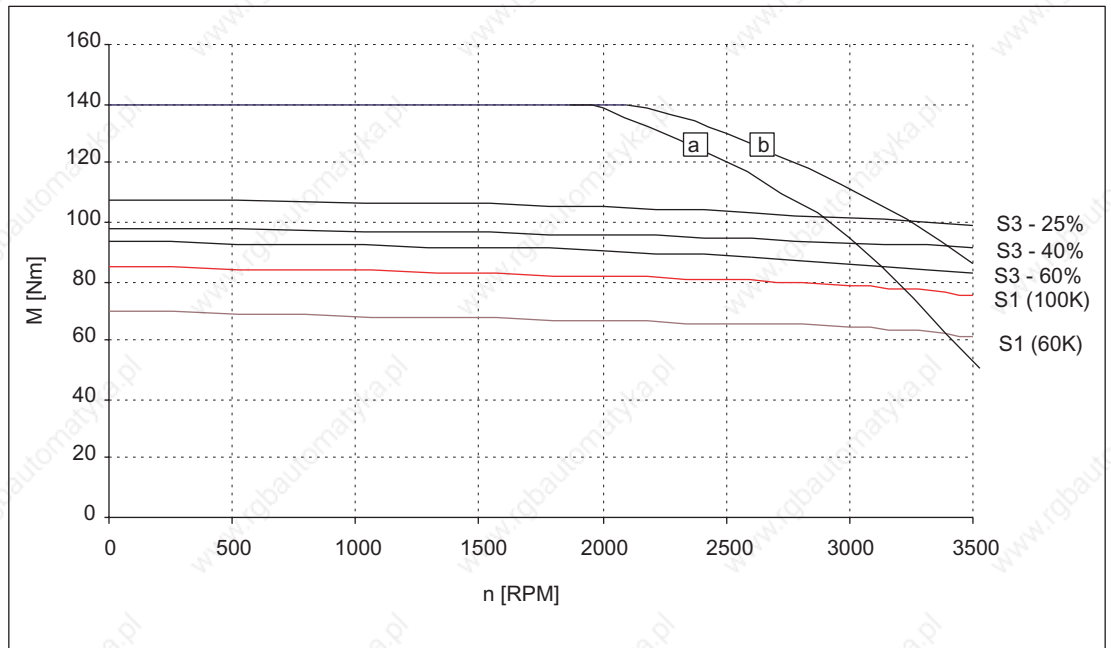

Figure 3-90 Speed-torque diagram 1FT6105-8WC7□

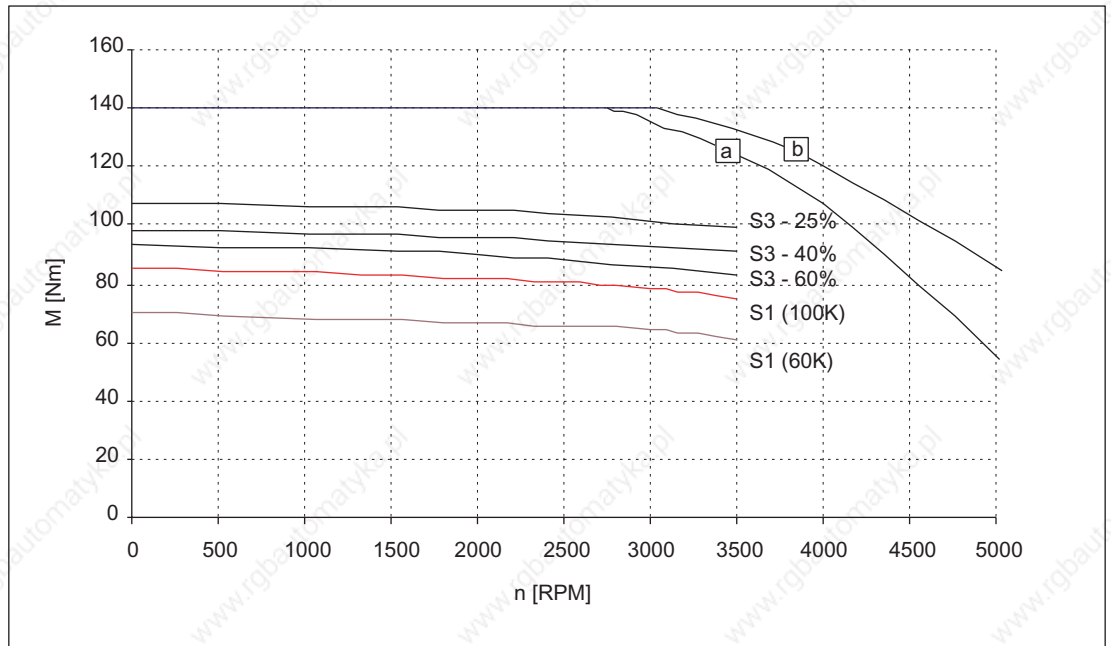

Figure 3-91 Speed-torque diagram 1FT6105-8WF7□

[a] SINAMICS S120 SMART LINE,  $V_{DC\ link}=540V$  (DC),  $V_{mot}=380V_{rms}$

[b] SINAMICS S120 ACTIVE LINE,  $V_{DC\ link}=600V$  (DC),  $V_{mot}=425V_{rms}$

## Technical Data and Speed-Torque Diagrams

### 3.1 Speed-torque diagrams

Table 3-56 1FT6108, water cooled

1FT6108					
Technical data	Code	Unit	-8WB7	-8WC7	
Engineering data					
Rated speed	$n_N$	RPM	1500	2000	
Pole number	2p		8	8	
Rated torque (100K)	$M_{N(100K)}$	Nm	116	115	
Rated current (100K)	$I_N(100K)$	A	43	57	
Stall torque (60K)	$M_0(60K)$	Nm	98	98	
Stall torque (100K)	$M_0(100K)$	Nm	119	119	
Stall current (60K)	$I_0(60K)$	A	35	46	
Stall current (100K)	$I_0(100K)$	A	43	57	
Moment of inertia (with brake)	$J_{mot}$	$10^{-4}$ kgm <sup>2</sup>	291	291	
Moment of inertia (without brake)	$J_{mot}$	$10^{-4}$ kgm <sup>2</sup>	260	260	
Optimum operating point					
Optimum speed	$n_{opt}$	RPM	1500	2000	
Optimum power	$P_{opt}$	kW	18.2	24.1	
Limiting data					
Max. permissible speed (mech.)	$n_{max}$	RPM	5600	5600	
Max. torque	$M_{max}$	Nm	220	220	
Max. current	$I_{max}$	A	116	154	
Physical constants					
Torque constant	$k_T$	Nm/A	2.76	2.07	
Voltage constant	$k_E$	V/1000 RPM	185	139	
Winding resistance at 20° C	$R_{ph}$	Ohm	0.19	0.11	
Rotating field inductance	$L_D$	mH	4.4	2.5	
Electrical time constant	$T_{el}$	ms	23	23	
Shaft torsional stiffness	$C_t$	Nm/rad	92000	92000	
Mechanical time constant	$T_{mech}$	ms	1.9	2.0	
Thermal time constant	$T_{th}$	min	1.5	1.5	
Weight with brake	m	kg	66	66	
Weight without brake	m	kg	61.5	61.5	

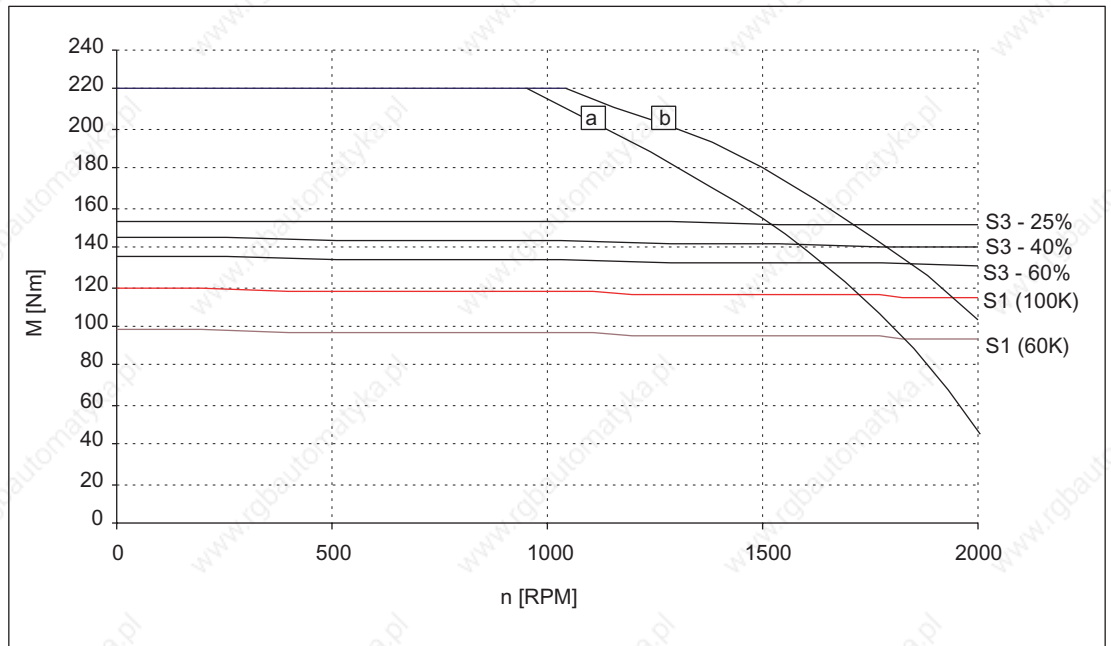

Figure 3-92 Speed-torque diagram 1FT6108-8WB7□

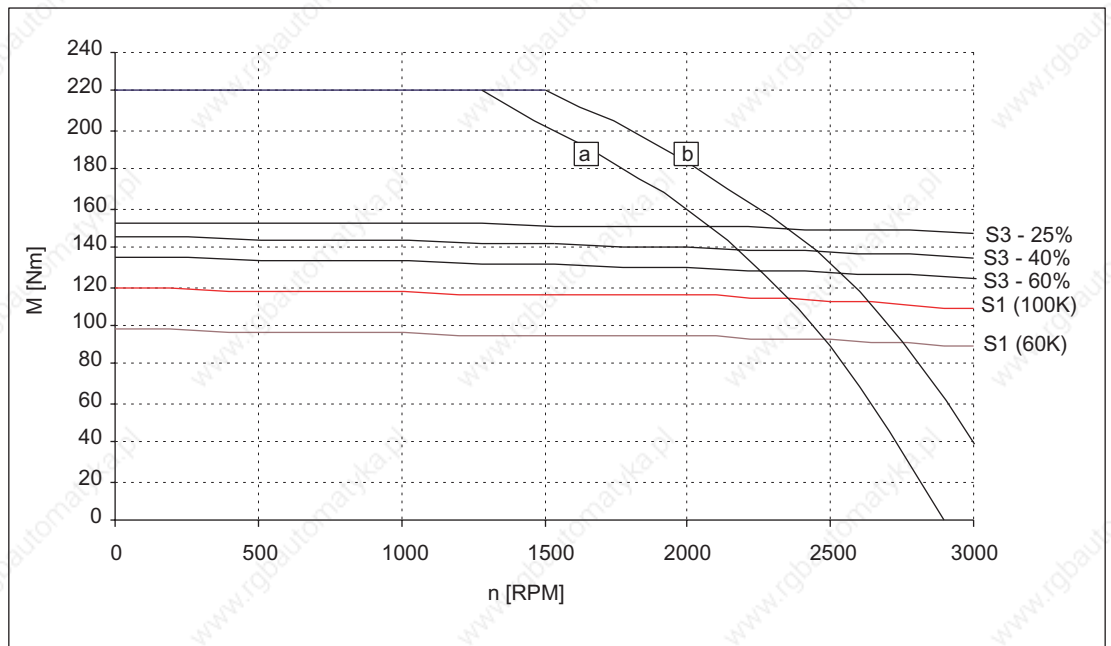

Figure 3-93 Speed-torque diagram 1FT6108-8WC7□

[a] SINAMICS S120 SMART LINE,  $V_{\text{DC link}}=540\text{V (DC)}$ ,  $V_{\text{mot}}=380\text{V}_{\text{rms}}$

[b] SINAMICS S120 ACTIVE LINE,  $V_{\text{DC link}}=600\text{V (DC)}$ ,  $V_{\text{mot}}=425\text{V}_{\text{rms}}$

## Technical Data and Speed-Torque Diagrams

### 3.1 Speed-torque diagrams

Table 3-57 1FT6108, water cooled

1FT6108				
Technical data	Code	Unit	-8WF7□	
Configuring data				
Rated speed	$n_N$	RPM	3000	
Pole number	2p		8	
Rated torque (100K)	$M_{N(100K)}$	Nm	109	
Rated current (100K)	$I_{N(100K)}$	A	81	
Stall torque (60K)	$M_{0(60K)}$	Nm	98	
Stall torque (100K)	$M_{0(100K)}$	Nm	119	
Stall current (60K)	$I_{0(60K)}$	A	70	
Stall current (100K)	$I_{0(100K)}$	A	86	
Moment of inertia (with brake)	$J_{mot}$	$10^{-4}$ kgm <sup>2</sup>	291	
Moment of inertia (without brake)	$J_{mot}$	$10^{-4}$ kgm <sup>2</sup>	260	
Optimum operating point				
Optimum speed	$n_{opt}$	RPM	3000	
Optimum power	$P_{opt}$	kW	34	
Limiting data				
Max. permissible speed (mech.)	$n_{max}$	RPM	5600	
Max. torque	$M_{max}$	Nm	220	
Max. current	$I_{max}$	A	231	
Physical constants				
Torque constant	$k_T$	Nm/A	1.38	
Voltage constant	$k_E$	V/1000 RPM	92	
Winding resistance at 20° C	$R_{ph}$	Ohm	0.048	
Rotating field inductance	$L_D$	mH	1.1	
Electrical time constant	$T_{el}$	ms	23	
Shaft torsional stiffness	$C_t$	Nm/rad	92000	
Mechanical time constant	$T_{mech}$	ms	2.0	
Thermal time constant	$T_{th}$	min	1.5	
Weight with brake	m	kg	66	
Weight without brake	m	kg	61.5	

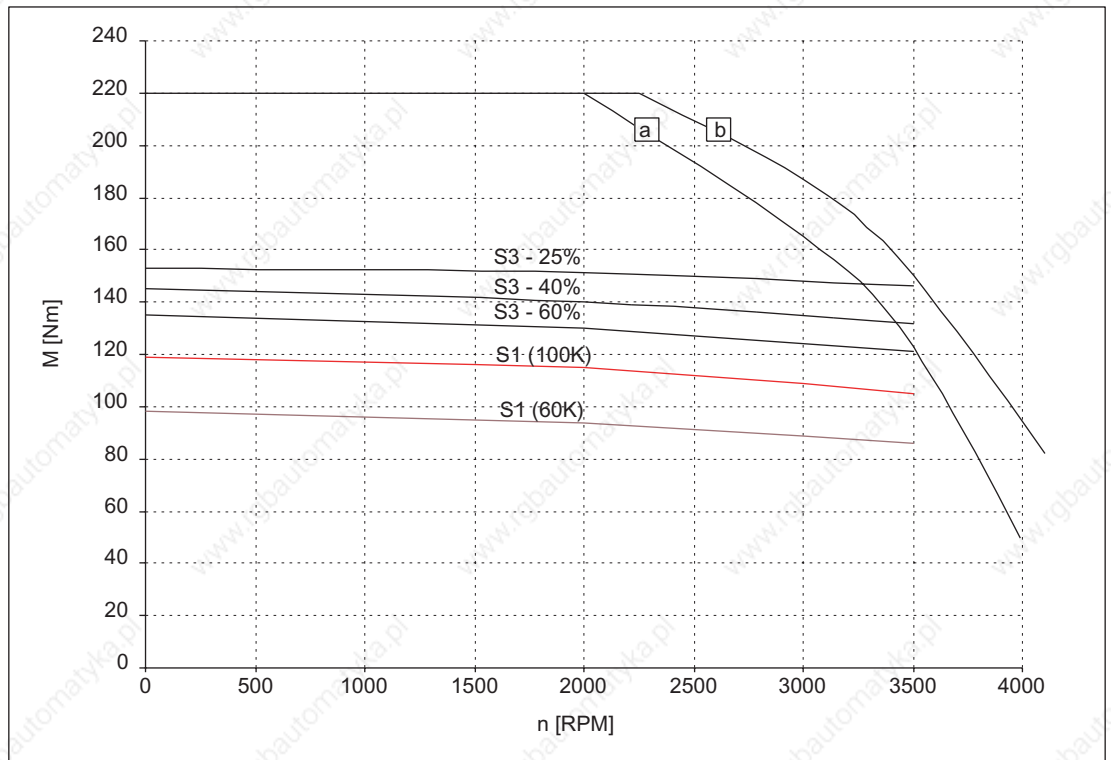

Figure 3-94 Speed-torque diagram 1FT6108-8WF7

[a] SINAMICS S120 SMART LINE,  $V_{DC\ link}=540V$  (DC),  $V_{mot}=380V_{rms}$

[b] SINAMICS S120 ACTIVE LINE,  $V_{DC\ link}=600V$  (DC),  $V_{mot}=425V_{rms}$

## Technical Data and Speed-Torque Diagrams

### 3.1 Speed-torque diagrams

Table 3-58 1FT6132, water cooled

1FT6132					
Technical data	Code	Unit	-6WB7□	-6WD7□	
Configuring data					
Rated speed	$n_N$	RPM	1500	2500	
Pole number	2p		6	6	
Rated torque (100K)	$M_{N(100K)}$	Nm	150	148	
Rated current (100K)	$I_{N(100K)}$	A	58	82	
Stall torque (60K)	$M_0(60K)$	Nm	120	120	
Stall torque (100K)	$M_0(100K)$	Nm	155	155	
Stall current (60K)	$I_0(60K)$	A	45	71	
Stall current (100K)	$I_0(100K)$	A	58	92	
Moment of inertia (with brake)	$J_{mot}$	$10^{-4}$ kgm <sup>2</sup>	—	—	
Moment of inertia (without brake)	$J_{mot}$	$10^{-4}$ kgm <sup>2</sup>	430	430	
Optimum operating point					
Optimum speed	$n_{opt}$	RPM	1500	2500	
Optimum power	$P_{opt}$	kW	23.6	35.3	
Limiting data					
Max. permissible speed (mech.)	$n_{max}$	RPM	3600	3600	
Max. torque	$M_{max}$	Nm	250	250	
Max. current	$I_{max}$	A	124.5	197	
Physical constants					
Torque constant	$k_T$	Nm/A	2.67	1.68	
Voltage constant	$k_E$	V/1000 RPM	177	112	
Winding resistance at 20° C	$R_{ph}$	Ohm	0.15	0.057	
Rotating field inductance	$L_D$	mH	4.5	1.8	
Electrical time constant	$T_{el}$	ms	30	32	
Shaft torsional stiffness	$C_t$	Nm/rad	262300	262300	
Mechanical time constant	$T_{mech}$	ms	2.7	2.6	
Thermal time constant	$T_{th}$	min	6	6	
Weight with brake	m	kg	—	—	
Weight without brake	m	kg	90	90	

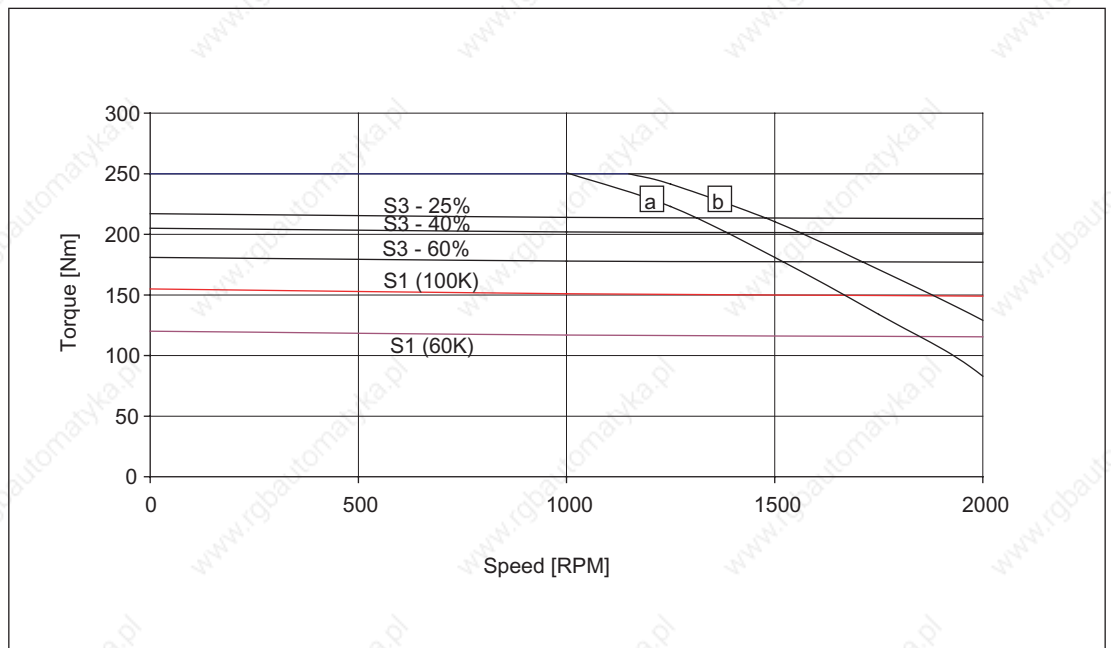

Figure 3-95 Speed-torque diagram 1FT6132-6WB7

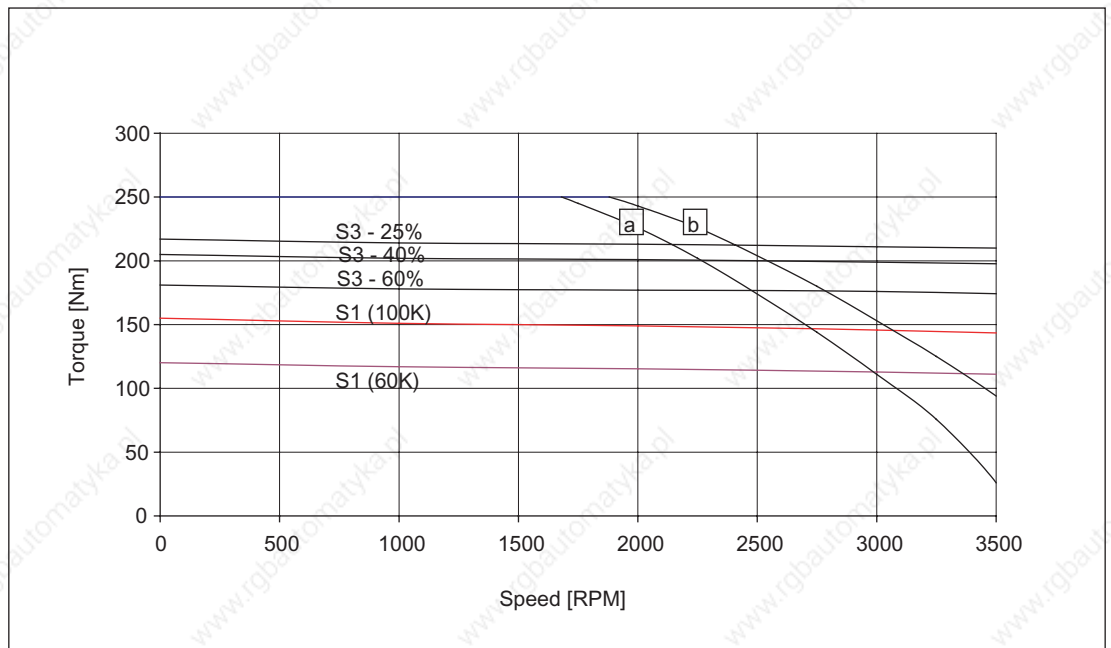

Figure 3-96 Speed-torque diagram 1FT6132-6WD7

[a] SINAMICS S120 SMART LINE,  $V_{DC \text{ link}}=540V$  (DC),  $V_{mot}=380V_{rms}$

[b] SINAMICS S120 ACTIVE LINE,  $V_{DC \text{ link}}=600V$  (DC),  $V_{mot}=425V_{rms}$

## Technical Data and Speed-Torque Diagrams

### 3.1 Speed-torque diagrams

Table 3-59 1FT6134, water cooled

1FT6134					
Technical data	Code	Unit	-6WB7□	-6WD7□	
Configuring data					
Rated speed	$n_N$	RPM	1500	2500	
Pole number	2p		6	6	
Rated torque (100K)	$M_{N(100K)}$	Nm	185	185	
Rated current (100K)	$I_N(100K)$	A	67	115	
Stall torque (60K)	$M_0(60K)$	Nm	155	155	
Stall torque (100K)	$M_0(100K)$	Nm	200	200	
Stall current (60K)	$I_0(60K)$	A	57	95	
Stall current (100K)	$I_0(100K)$	A	73	122	
Moment of inertia (with brake)	$J_{mot}$	$10^{-4}$ kgm <sup>2</sup>	—	—	
Moment of inertia (without brake)	$J_{mot}$	$10^{-4}$ kgm <sup>2</sup>	547	547	
Optimum operating point					
Optimum speed	$n_{opt}$	RPM	1500	2500	
Optimum power	$P_{opt}$	kW	29	48.4	
Limiting data					
Max. permissible speed (mech.)	$n_{max}$	RPM	3600	3600	
Max. torque	$M_{max}$	Nm	320	320	
Max. current	$I_{max}$	A	158	263	
Physical constants					
Torque constant	$k_T$	Nm/A	2.74	1.64	
Voltage constant	$k_E$	V/1000 RPM	180	108	
Winding resistance at 20° C	$R_{ph}$	Ohm	0.105	0.038	
Rotating field inductance	$L_D$	mH	3.6	1.3	
Electrical time constant	$T_{el}$	ms	34	34	
Shaft torsional stiffness	$C_t$	Nm/rad	237500	237500	
Mechanical time constant	$T_{mech}$	ms	2.3	2.3	
Thermal time constant	$T_{th}$	min	6	6	
Weight with brake	m	kg	—	—	
Weight without brake	m	kg	103	103	



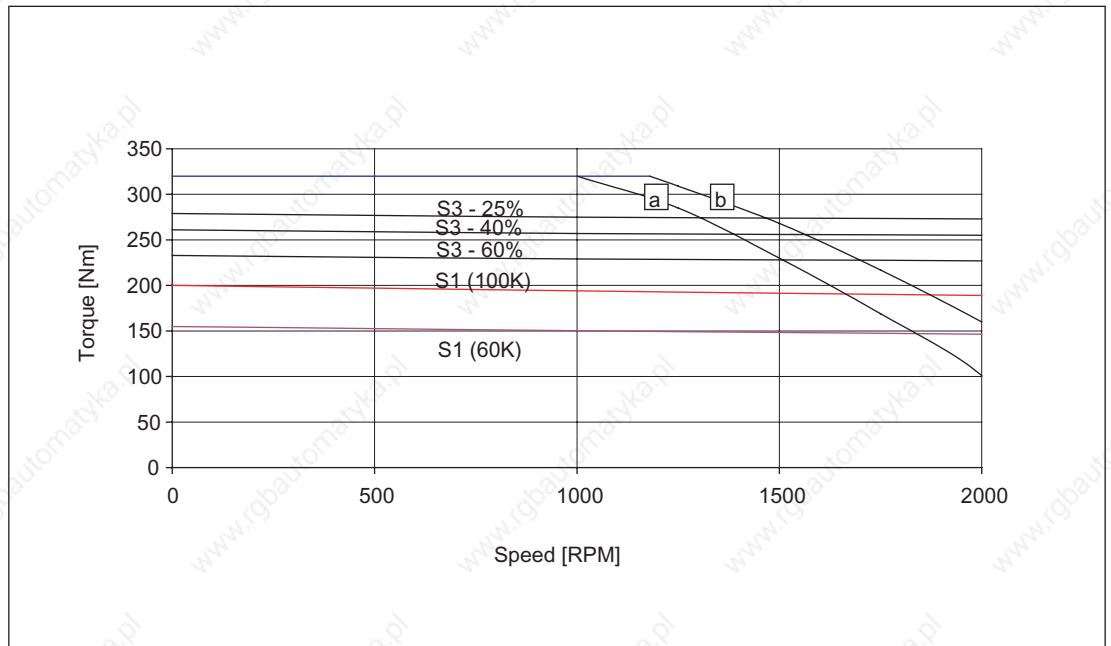

Figure 3-97 Speed-torque diagram 1FT6134-6WB7□

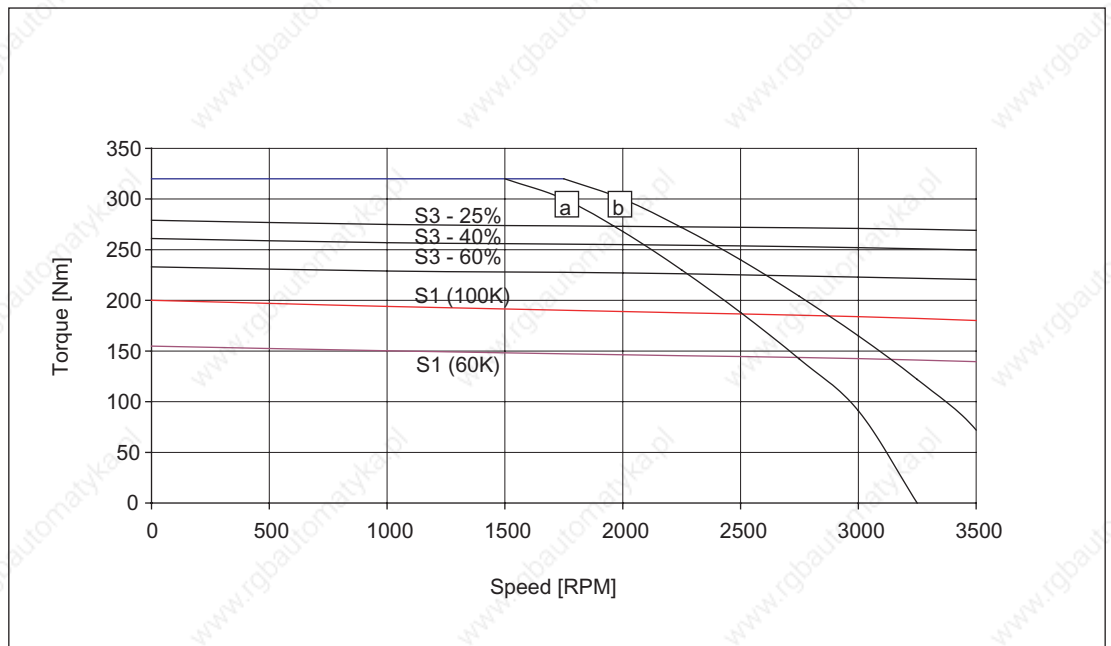

Figure 3-98 Speed-torque diagram 1FT6134-6WD7□

[a] SINAMICS S120 SMART LINE,  $V_{DC \text{ link}}=540V$  (DC),  $V_{mot}=380V_{rms}$

[b] SINAMICS S120 ACTIVE LINE,  $V_{DC \text{ link}}=600V$  (DC),  $V_{mot}=425V_{rms}$

## Technical Data and Speed-Torque Diagrams

### 3.1 Speed-torque diagrams

Table 3-60 1FT6136, water cooled

1FT6136					
Technical data	Code	Unit	-6WB7□	-6WD7□	
Configuring data					
Rated speed	$n_N$	RPM	1500	2500	
Pole number	2p		6	6	
Rated torque (100K)	$M_{N(100K)}$	Nm	230	220	
Rated current (100K)	$I_{N(100K)}$	A	90	149	
Stall torque (60K)	$M_0(60K)$	Nm	200	200	
Stall torque (100K)	$M_0(100K)$	Nm	240	240	
Stall current (60K)	$I_0(60K)$	A	75	129	
Stall current (100K)	$I_0(100K)$	A	92	158	
Moment of inertia (with brake)	$J_{mot}$	$10^{-4}$ kgm <sup>2</sup>	—	—	
Moment of inertia (without brake)	$J_{mot}$	$10^{-4}$ kgm <sup>2</sup>	664	664	
Optimum operating point					
Optimum speed	$n_{opt}$	RPM	1500	2500	
Optimum power	$P_{opt}$	kW	36.1	57.6	
Limiting data					
Max. permissible speed (mech.)	$n_{max}$	RPM	3600	3600	
Max. torque	$M_{max}$	Nm	390	390	
Max. current <sup>1)</sup>	$I_{max}$	A	198	339	
Physical constants					
Torque constant	$k_T$	Nm/A	2.61	1.52	
Voltage constant	$k_E$	V/1000 RPM	176	103	
Winding resistance at 20° C	$R_{ph}$	Ohm	0.077	0.026	
Rotating field inductance	$L_D$	mH	2.8	0.95	
Electrical time constant	$T_{el}$	ms	36	37	
Shaft torsional stiffness	$C_t$	Nm/rad	217000	217000	
Mechanical time constant	$T_{mech}$	ms	2.3	2.2	
Thermal time constant	$T_{th}$	min	6	6	
Weight with brake	m	kg	—	—	
Weight without brake	m	kg	120	120	

1) Observe the maximum and rated current of the drive converter

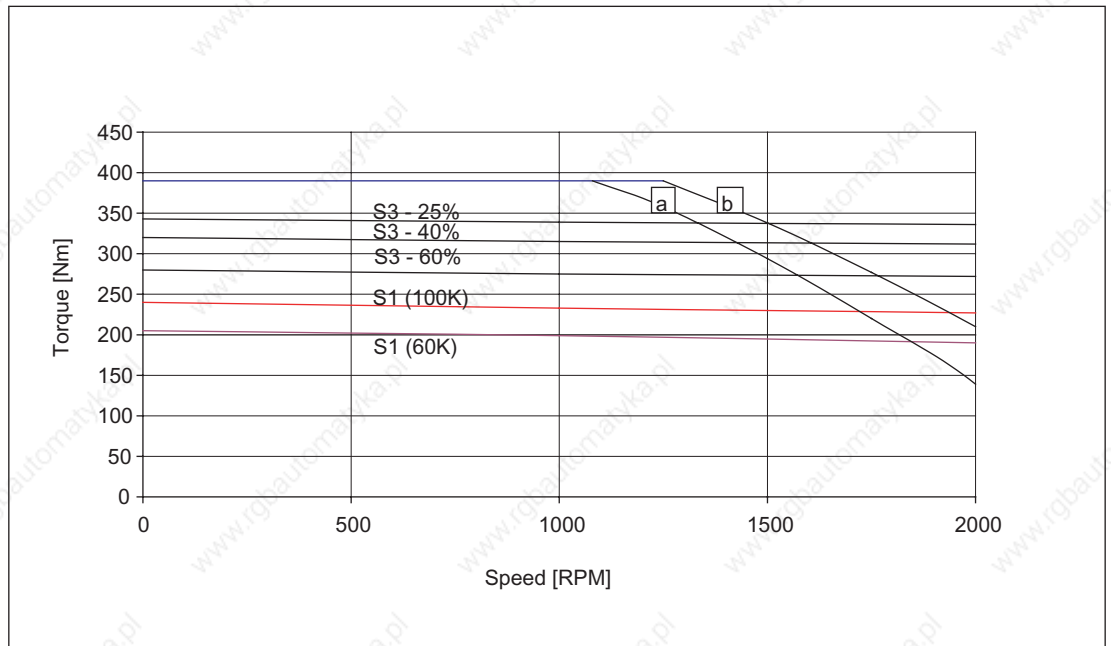

Figure 3-99 Speed-torque diagram 1FT6136-6WB7□

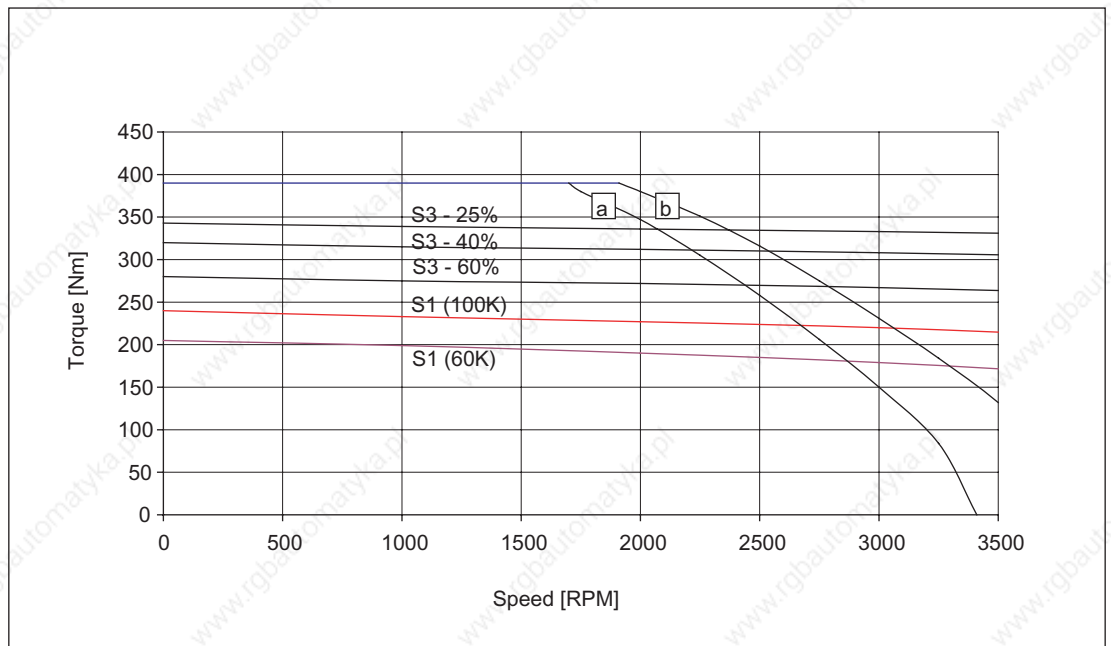

Figure 3-100 Speed-torque diagram 1FT6136-6WD7□

[a] SINAMICS S120 SMART LINE,  $V_{DC \text{ link}}=540V \text{ (DC)}$ ,  $V_{mot}=380V_{rms}$

[b] SINAMICS S120 ACTIVE LINE,  $V_{DC \text{ link}}=600V \text{ (DC)}$ ,  $V_{mot}=425V_{rms}$

## Technical Data and Speed-Torque Diagrams

### 3.1 Speed-torque diagrams

Table 3-61 1FT6138, water cooled

1FT6138					
Technical data	Code	Unit	-6WB7□	-6WD7□	
Configuring data					
Rated speed	$n_N$	RPM	1500	2500	
Pole number	2p		6	6	
Rated torque (100K)	$M_{N(100K)}$	Nm	290	275	
Rated current (100K)	$I_{N(100K)}$	A	112	162	
Stall torque (60K)	$M_0(60K)$	Nm	232	232	
Stall torque (100K)	$M_0(100K)$	Nm	300	300	
Stall current (60K)	$I_0(60K)$	A	87	129	
Stall current (100K)	$I_0(100K)$	A	112	167	
Moment of inertia (with brake)	$J_{mot}$	$10^{-4}$ kgm <sup>2</sup>	—	—	
Moment of inertia (without brake)	$J_{mot}$	$10^{-4}$ kgm <sup>2</sup>	845	845	
Optimum operating point					
Optimum speed	$n_{opt}$	RPM	1500	2500	
Optimum power	$P_{opt}$	kW	45.5	72	
Limiting data					
Max. permissible speed (mech.)	$n_{max}$	RPM	3600	3600	
Max. torque	$M_{max}$	Nm	500	500	
Max. current <sup>1)</sup>	$I_{max}$	A	263	395	
Physical constants					
Torque constant	$k_T$	Nm/A	2.68	1.80	
Voltage constant	$k_E$	V/1000 RPM	168	112	
Winding resistance at 20° C	$R_{ph}$	Ohm	0.052	0.023	
Rotating field inductance	$L_D$	mH	2	0.87	
Electrical time constant	$T_{el}$	ms	38	38	
Shaft torsional stiffness	$C_t$	Nm/rad	192000	192000	
Mechanical time constant	$T_{mech}$	ms	1.8	1.8	
Thermal time constant	$T_{th}$	min	6	6	
Weight with brake	m	kg	—	—	
Weight without brake	m	kg	137	137	

1) Observe the maximum and rated current of the drive converter

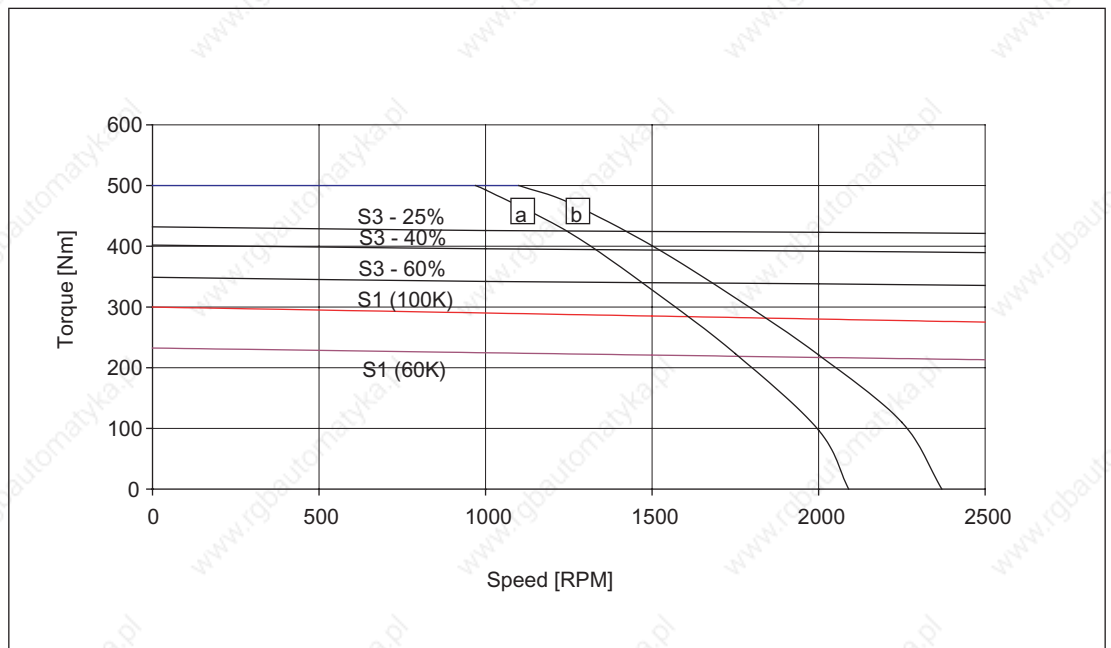

Figure 3-101 Speed-torque diagram 1FT6138-6WB7□

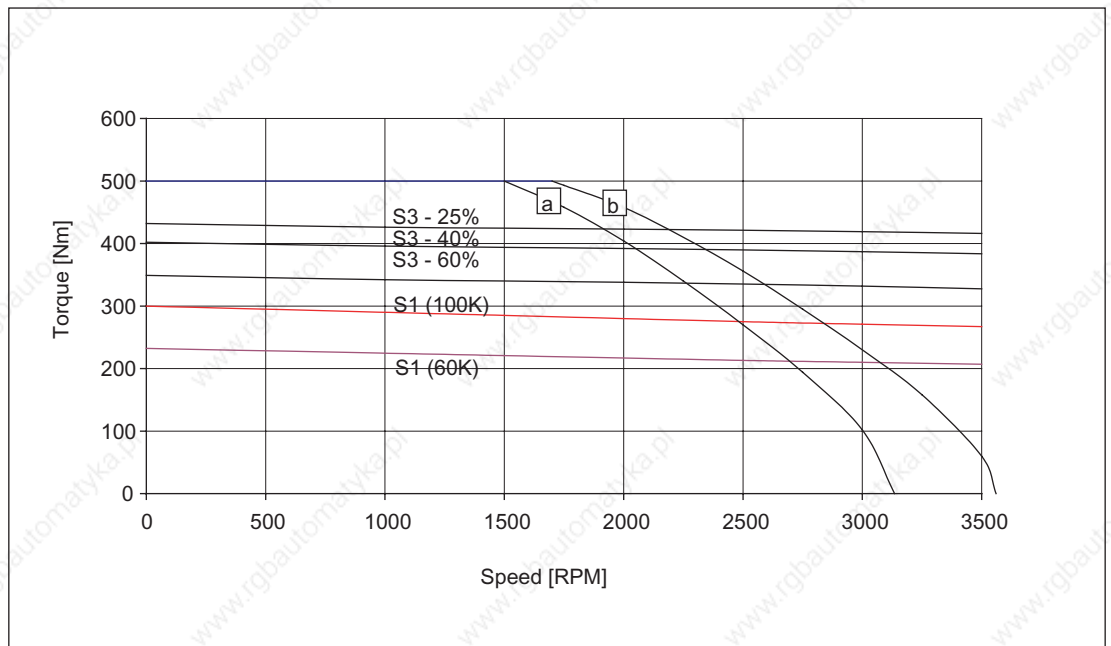

Figure 3-102 Speed-torque diagram 1FT6138-6WD7□

[a] SINAMICS S120 SMART LINE,  $V_{DC\ link}=540V$  (DC),  $V_{mot}=380V_{rms}$

[b] SINAMICS S120 ACTIVE LINE,  $V_{DC\ link}=600V$  (DC),  $V_{mot}=425V_{rms}$

## Technical Data and Speed-Torque Diagrams

### 3.1 Speed-torque diagrams

Table 3-62 1FT6163, water cooled

1FT6163					
Technical data	Code	Unit	-8WB7□	-8WD7□	
Configuring data					
Rated speed	$n_N$	RPM	1500	2500	
Pole number	2p		8	8	
Rated torque (100K)	$M_{N(100K)}$	Nm	450	450	
Rated current (100K) <sup>1)</sup>	$I_{N(100K)}$	A	160	240	
Stall torque (60K)	$M_0(60K)$	Nm	430	430	
Stall torque (100K)	$M_0(100K)$	Nm	450	450	
Stall current (60K) <sup>1)</sup>	$I_0(60K)$	A	150	224	
Stall current (100K)	$I_0(100K)$	A	160	240	
Moment of inertia (with brake)	$J_{mot}$	$10^{-4}$ kgm <sup>2</sup>	—	—	
Moment of inertia (without brake)	$J_{mot}$	$10^{-4}$ kgm <sup>2</sup>	2300	2300	
Optimum operating point					
Optimum speed	$n_{opt}$	RPM	1500	2500	
Optimum power	$P_{opt}$	kW	71	118	
Limiting data					
Max. permissible speed (mech.)	$n_{max}$	RPM	3100	3100	
Max. torque	$M_{max}$	Nm	900	900	
Max. current <sup>1)</sup>	$I_{max}$	A	372	558	
Physical constants					
Torque constant	$k_T$	Nm/A	2.81	1.88	
Voltage constant	$k_E$	V/1000 RPM	186	124	
Winding resistance at 20° C	$R_{ph}$	Ohm	0.026	0.012	
Rotating field inductance	$L_D$	mH	0.81	0.36	
Electrical time constant	$T_{el}$	ms	31	30	
Shaft torsional stiffness	$C_t$	Nm/rad	472100	472100	
Mechanical time constant	$T_{mech}$	ms	2.3	2.4	
Thermal time constant	$T_{th}$	min	8	8	
Weight with brake	m	kg	—	—	
Weight without brake	m	kg	170	170	

1) Observe the maximum and rated current of the drive converter

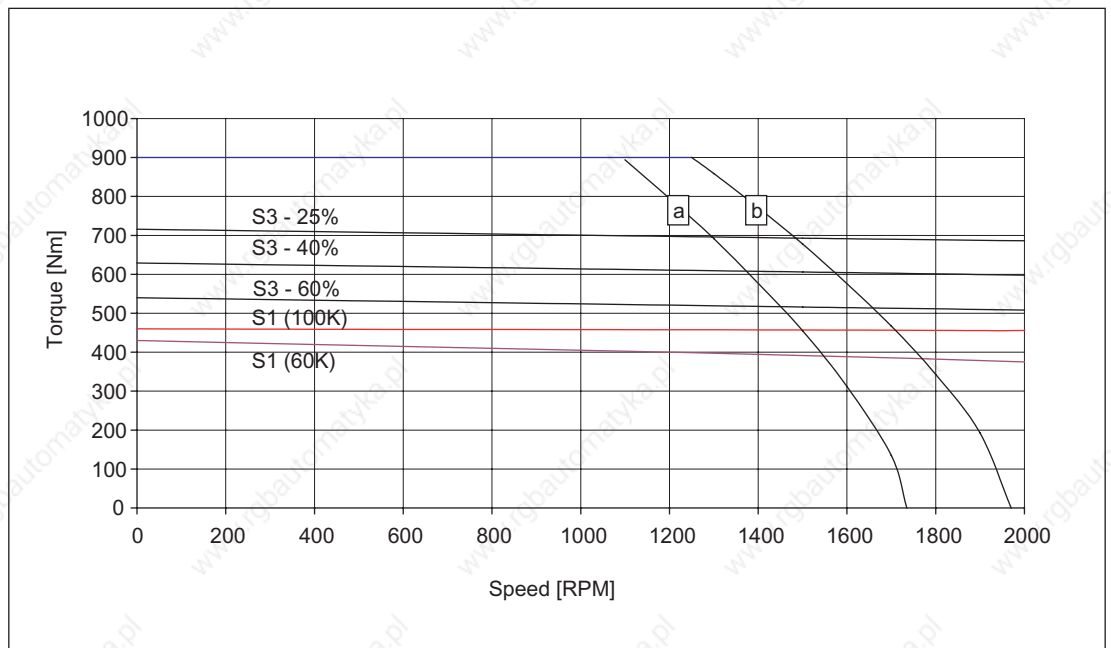

Figure 3-103 Speed-torque diagram 1FT6163-8WB7□

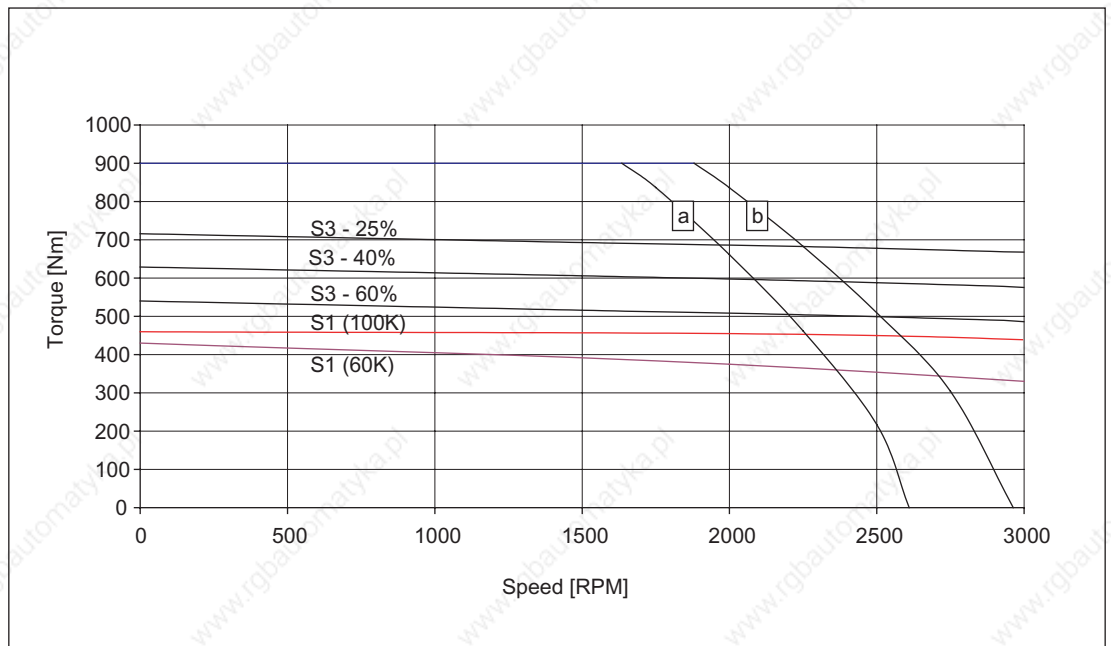

Figure 3-104 Speed-torque diagram 1FT6163-8WD7□

[a] SINAMICS S120 SMART LINE,  $V_{DC \text{ link}}=540V \text{ (DC)}$ ,  $V_{mot}=380V_{rms}$

[b] SINAMICS S120 ACTIVE LINE,  $V_{DC \text{ link}}=600V \text{ (DC)}$ ,  $V_{mot}=425V_{rms}$

## Technical Data and Speed-Torque Diagrams

### 3.1 Speed-torque diagrams

Table 3-63 1FT6168, water cooled

1FT6168				
Technical data	Code	Unit	-8WB7□	
Configuring data				
Rated speed	$n_N$	RPM	1500	
Pole number	2p		8	
Rated torque (100K)	$M_{N(100K)}$	Nm	690	
Rated current (100K) <sup>1)</sup>	$I_{N(100K)}$	A	221	
Stall torque (60K)	$M_0(60K)$	Nm	600	
Stall torque (100K)	$M_0(100K)$	Nm	700	
Stall current (60K)	$I_0(60K)$	A	193	
Stall current (100K)	$I_0(100K)$	A	225	
Moment of inertia (with brake)	$J_{mot}$	$10^{-4}$ kgm <sup>2</sup>	—	
Moment of inertia (without brake)	$J_{mot}$	$10^{-4}$ kgm <sup>2</sup>	3100	
Optimum operating point				
Optimum speed	$n_{opt}$	RPM	1500	
Optimum power	$P_{opt}$	kW	108	
Limiting data				
Max. permissible speed (mech.)	$n_{max}$	RPM	3100	
Max. torque	$M_{max}$	Nm	1200	
Max. current <sup>1)</sup>	$I_{max}$	A	479	
Physical constants				
Torque constant	$k_T$	Nm/A	3.11	
Voltage constant	$k_E$	V/1000 RPM	203	
Winding resistance at 20° C	$R_{ph}$	Ohm	0.02	
Rotating field inductance	$L_D$	mH	0.69	
Electrical time constant	$T_{el}$	ms	35	
Shaft torsional stiffness	$C_t$	Nm/rad	431600	
Mechanical time constant	$T_{mech}$	ms	1.9	
Thermal time constant	$T_{th}$	min	8	
Weight with brake	$m$	kg	—	
Weight without brake	$m$	kg	210	

1) Observe the maximum and rated current of the drive converter



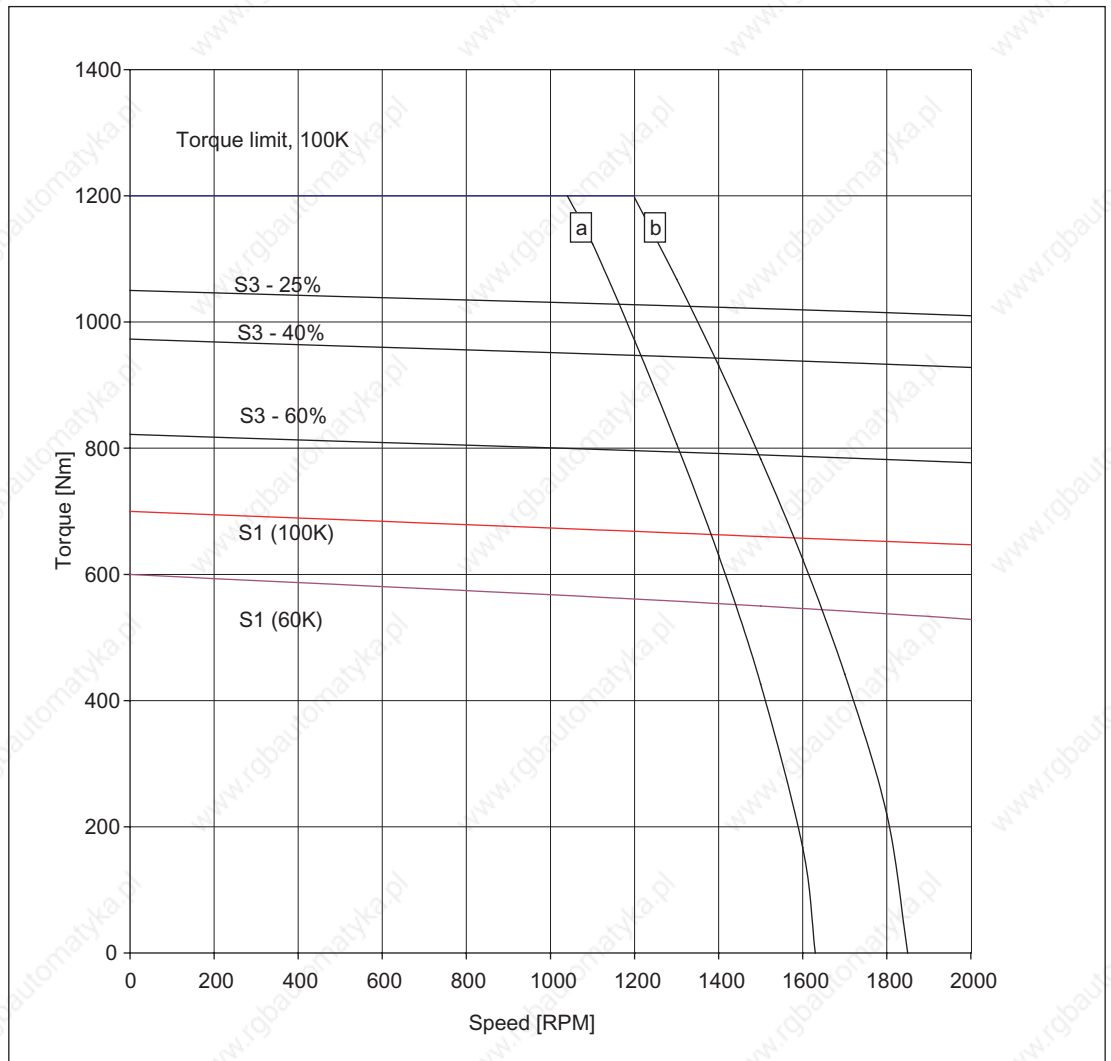

Figure 3-105 Speed-torque diagram 1FT6168-8WB7

[a] SINAMICS S120 SMART LINE,  $V_{DC \text{ link}}=540V$  (DC),  $V_{mot}=380V_{rms}$

[b] SINAMICS S120 ACTIVE LINE,  $V_{DC \text{ link}}=600V$  (DC),  $V_{mot}=425V_{rms}$

### 3.2 Cantilever force diagrams

#### Cantilever force stressing

Point of application of cantilever forces  $F_Q$  at the shaft end

- for average operating speeds
- for a nominal bearing lifetime of 20.000 h

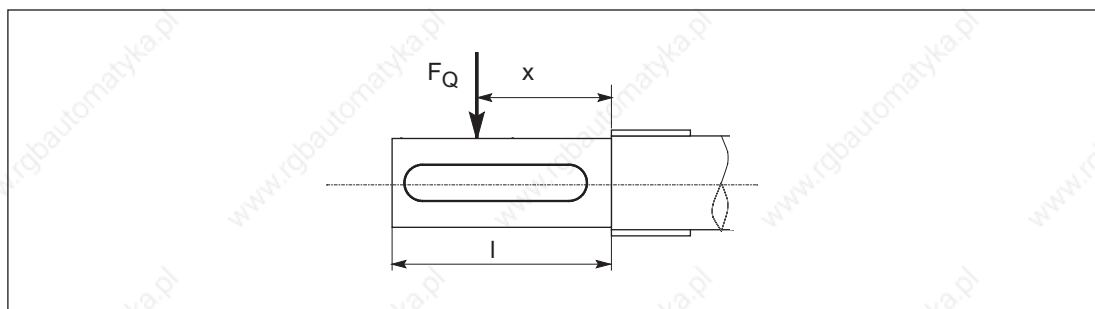

Figure 3-106 Force application point at the drive shaft end

Dimension  $x$ : Distance between the point of application of force  $F_Q$  and the shaft shoulder in mm.

Dimension  $l$ : Length of the shaft end in mm.

#### Calculating the belt pre-tension force $F_R$

$$F_R [N] = 2 \cdot M_0 \cdot c / d_R$$

$$F_R \leq F_{Qperm}$$

Table 3-64 Explanation of the formula abbreviations

Formula abbreviations	Units	Description
$F_R$	N	Belt pre-tension
$M_0$	Nm	Motor stall torque
$c$	—	Pre-tensioning factor; the pre-tensioning factor is an empirical value from the belt manufacturer. It can be assumed as follows: for toothed belts: $c = 1.5$ to $2.2$ for flat belts $c = 2.2$ to $3.0$
$d_R$	m	Effective diameter of the belt pulley

When using other configurations, the actual forces, generated from the torque being transferred, must be taken into account.

Cantilever force 1FT6024, 1FT6028

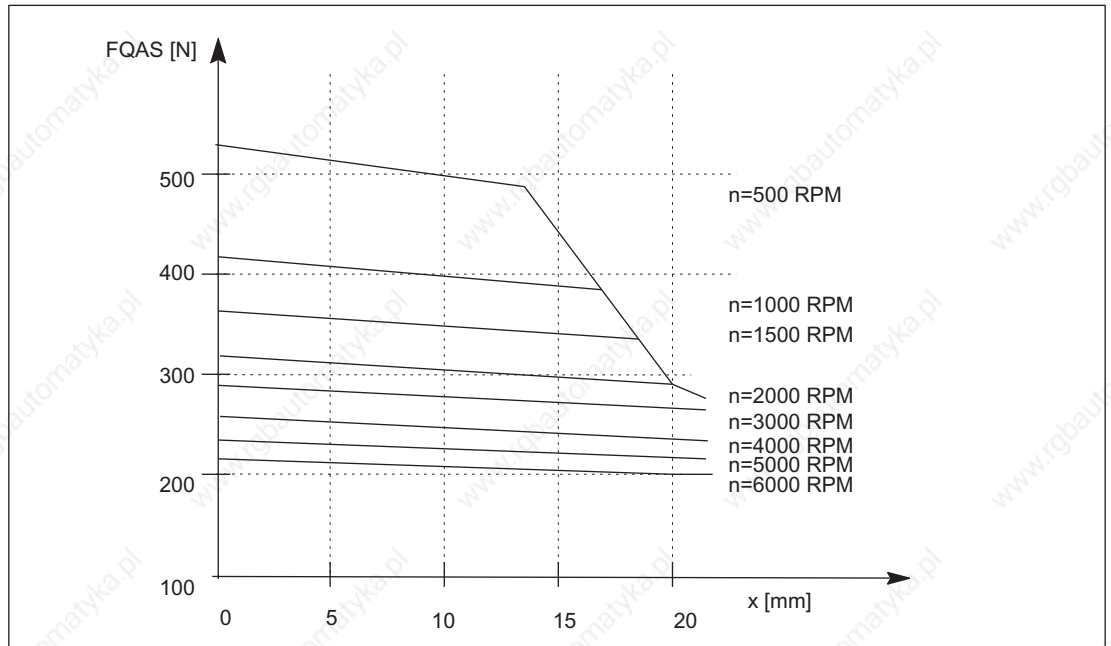

Figure 3-107 Cantilever force  $F_Q$  at a distance  $x$  from the shaft shoulder for a nominal bearing lifetime of 20,000 h

Cantilever force 1FT6031, 1FT6034

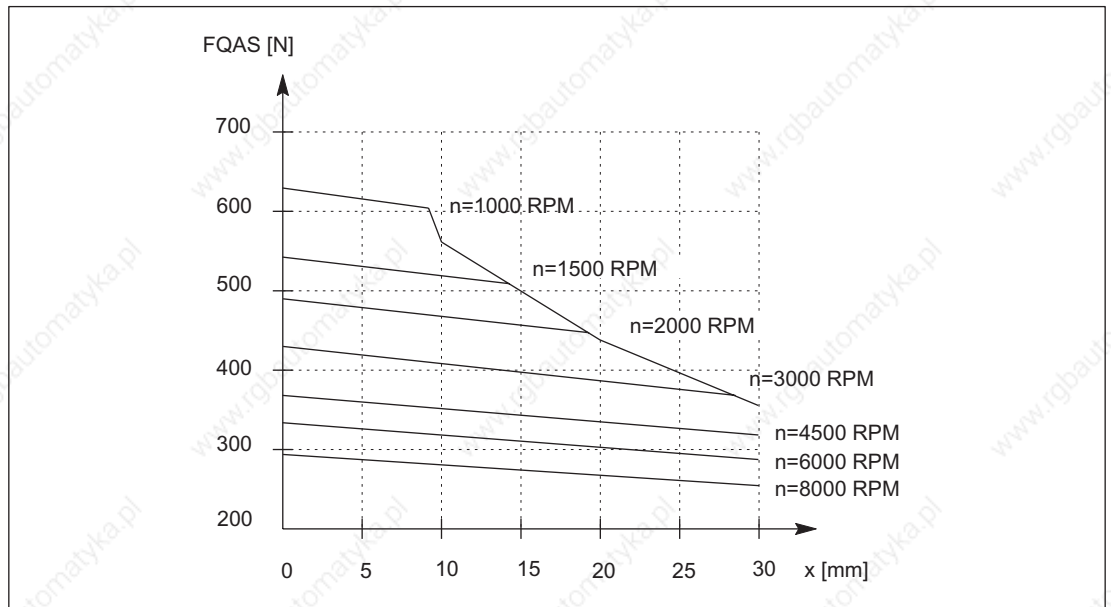

Figure 3-108 Cantilever force  $F_Q$  at a distance  $x$  from the shaft shoulder for a nominal bearing lifetime of 20,000 h

3.2 Cantilever force diagrams

Cantilever force 1FT6041, 1FT6044

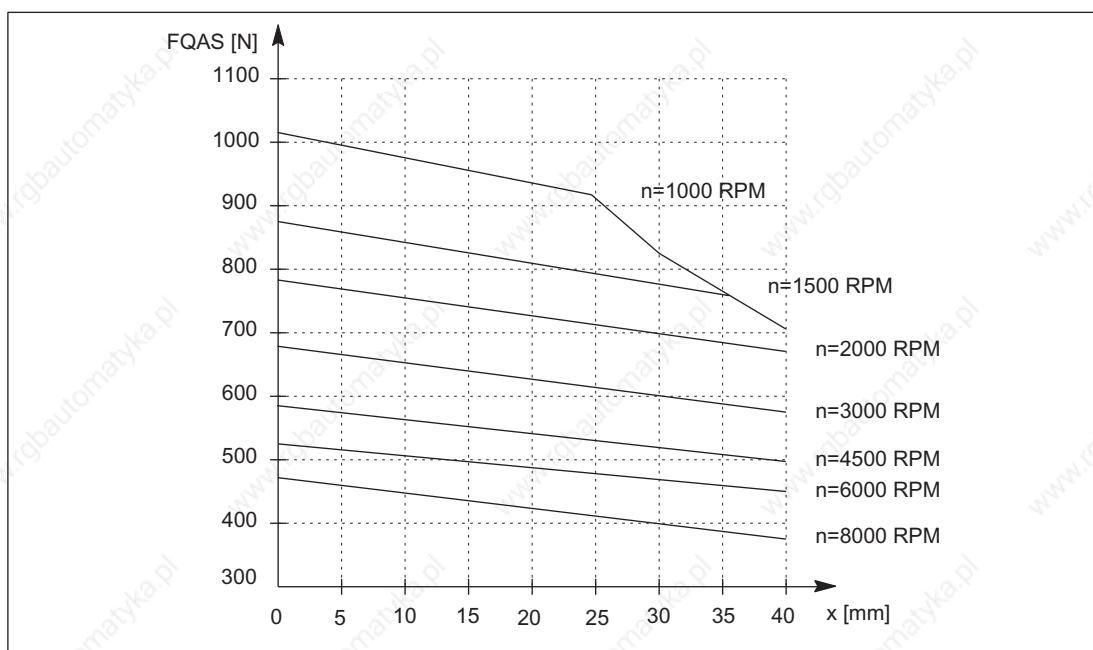

Figure 3-109 Cantilever force  $F_Q$  at a distance  $x$  from the shaft shoulder for a nominal bearing lifetime of 20,000 h

Cantilever force 1FT6061, 1FT6062, 1FT6064

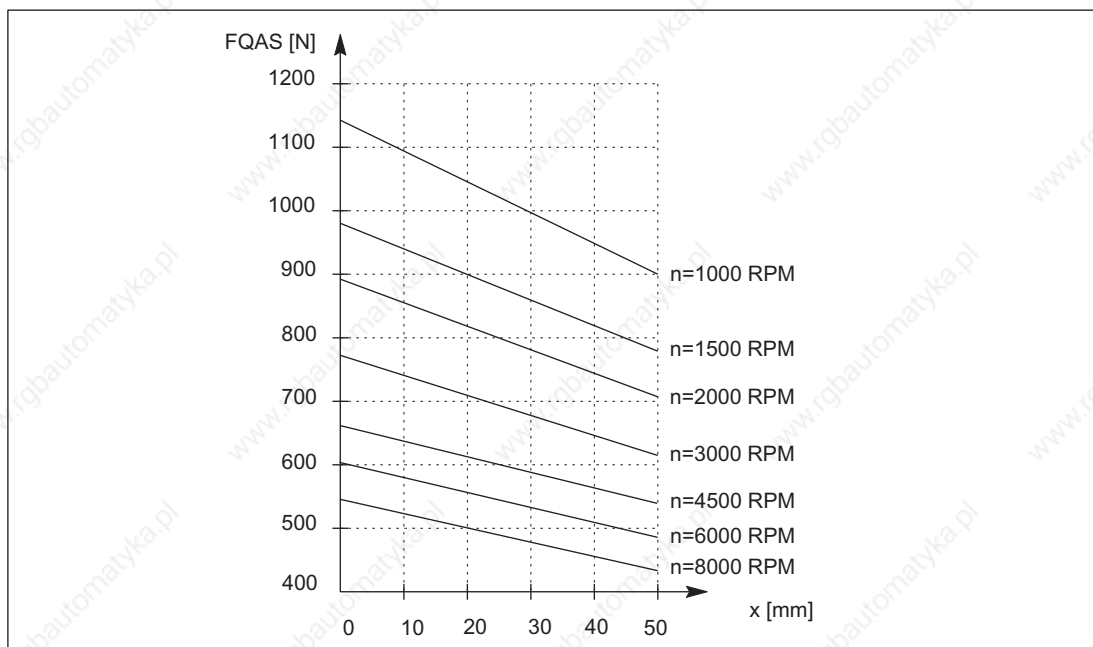

Figure 3-110 Cantilever force  $F_Q$  at a distance  $x$  from the shaft shoulder for a nominal bearing lifetime of 20,000 h

**Cantilever force 1FT6081, 1FT6082, 1FT6084, 1FT6086**

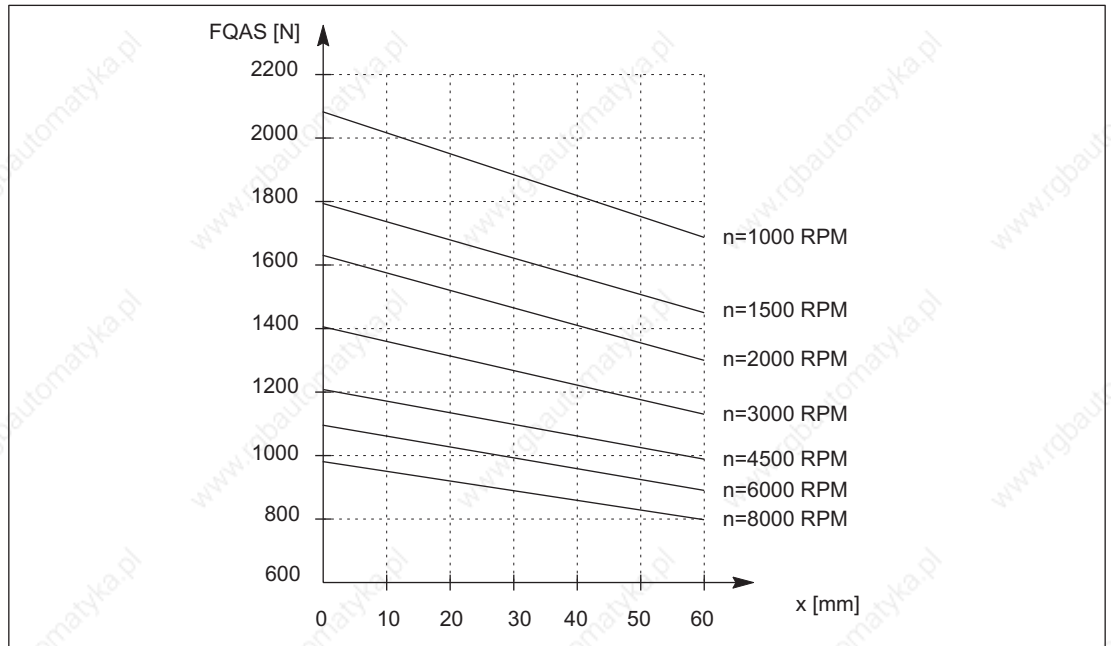

Figure 3-111 Cantilever force  $F_Q$  at a distance  $x$  from the shaft shoulder for a nominal bearing lifetime of 20,000 h

**Cantilever force 1FT6102, 1FT6105, 1FT6108**

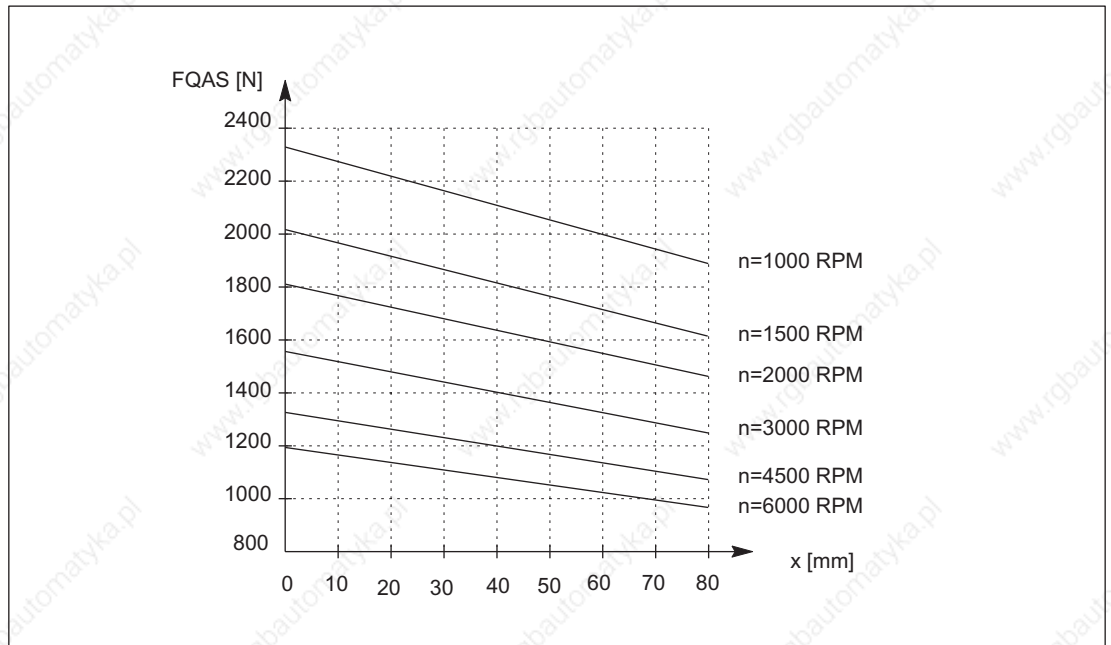

Figure 3-112 Cantilever force  $F_Q$  at a distance  $x$  from the shaft shoulder for a nominal bearing lifetime of 20,000 h

3.2 Cantilever force diagrams

Cantilever force 1FT6132, 1FT6134, 1FT6136, 1FT6138

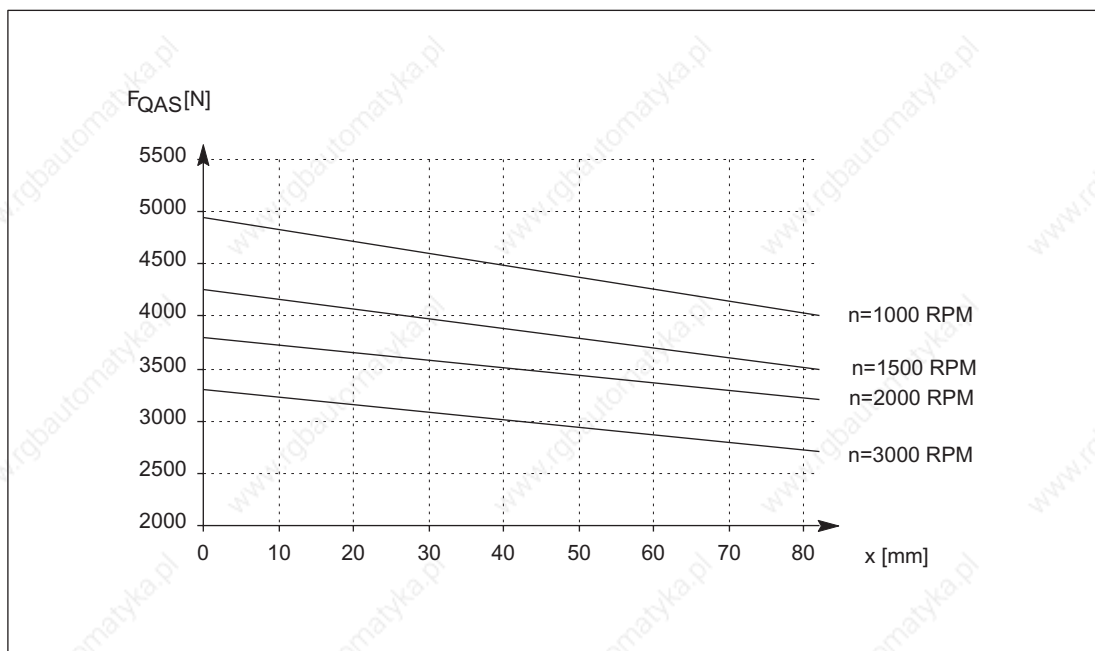

Figure 3-113 Cantilever force  $F_Q$  at a distance  $x$  from the shaft shoulder for a nominal bearing lifetime of 20,000 h

Cantilever force 1FT6163, 1FT6168

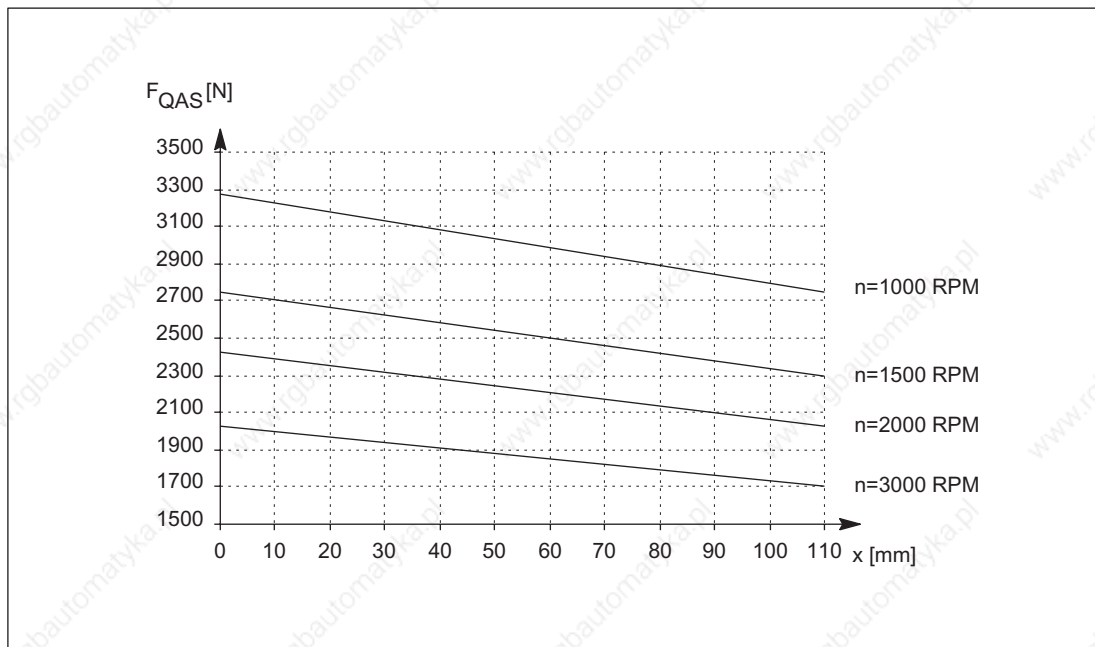

Figure 3-114 Cantilever force  $F_Q$  at a distance  $x$  from the shaft shoulder for a nominal bearing lifetime of 20,000 h

### 3.3 Axial forces

#### Axial force stressing



---

**Warning**

Motors with integrated holding brake cannot be subject to axial forces!

---

When using, for example, helical toothed wheels as drive element, in addition to the radial force, there is also an axial force on the motor bearings. For axial forces, the spring-loading of the bearings can be overcome so that the rotor moves corresponding to the axial bearing play present (up to 0.2 mm).

The permissible axial force can be approximately calculated using the following formula:

$$F_A = 0.35 \cdot F_Q$$

### 3.3 Axial forces



## Motor Components (Options)

### 4.1 Thermal motor protection

A temperature-dependent resistor is integrated as temperature sensor to monitor the motor temperature.

Table 4-1 Features and technical data

Type	KTY 84 (PTC thermistor)
Resistance when cold (20°C)	approx. 580 Ohm
Resistance when hot (100°C)	approx. 1000 Ohm
Connecting	via signal cable
Response temperature	Pre-warning at 120 °C ± 5 °C Alarm/trip at 155 °C ± 5 °C

The resistance of the KTY 84 thermistor changes proportionally to the winding temperature change.

The temperature signal is sensed and evaluated in the drive converter whose closed-loop control takes into account the temperature characteristic of the motor resistances.

When a fault occurs, an appropriate message is output at the drive converter. When the motor temperature increases, a message "Alarm motor overtemperature" is output; this must be externally evaluated. If this signal is not observed, the drive converter shuts down with the appropriate fault message when the motor limiting temperature or the shutdown temperature is exceeded.



#### Warning

If the user carries-out an additional high-voltage test, then the ends of the temperature sensor cables must be short-circuited before the test is carried-out!

If the test voltage is connected to a temperature sensor terminal, then it will be destroyed.

The polarity must be carefully observed.

The temperature sensor is designed so that the DIN/EN requirement for "protective separation" is fulfilled.

4.1 Thermal motor protection



**Caution**

The integrated temperature sensor protects the synchronous against an overload condition

Shaft heights, 28 to 48 up to  $2 \cdot I_{060K}$  and speed  $\leftrightarrow 0$

from shaft height 63 up to  $4 \cdot I_{060K}$  and speed  $\leftrightarrow 0$

For load applications that are critical from a thermal perspective - e.g. overload when the motor is stationary or an overload of  $4 \cdot M_0$  longer than 4 s, adequate protection is no longer available. This is the reason that additional protection must be provided.

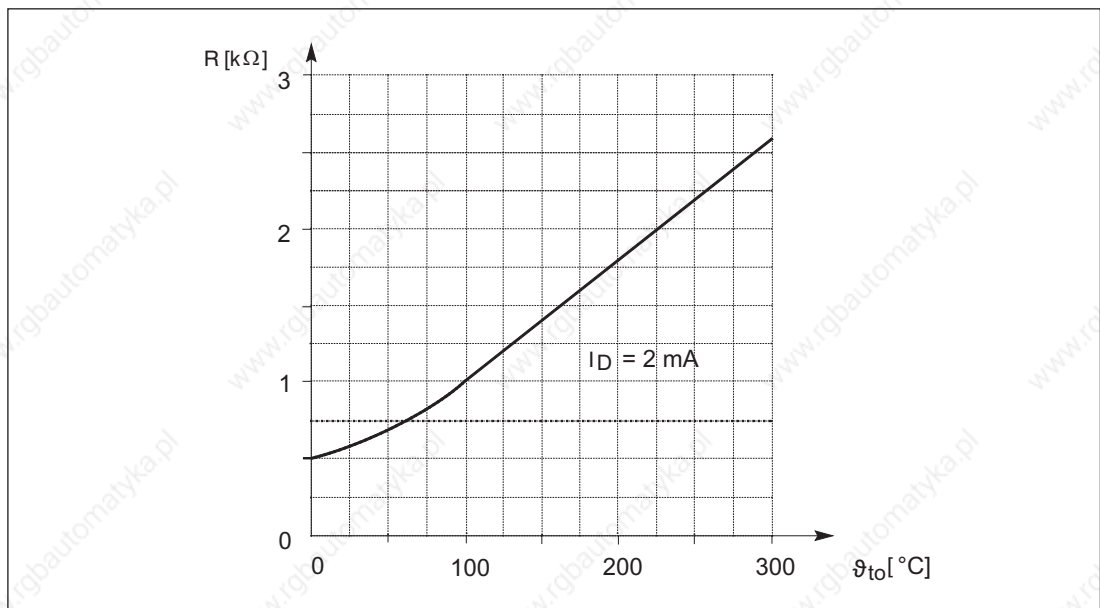

Figure 4-1 Resistance characteristic of the KTY 84 as a function of the temperature

## 4.2 Encoders

### 4.2.1 Encoder overview

The encoder is selected with the appropriate letters in the motor Order No. (MLFB) at the 14th position.

#### Note

The letter code at the 14th position of the Order No. (MLFB) is different for motors with and without DRIVE-CLiQ.

Table 4-2 Encoders for motors with and without DRIVE-CLiQ

Motor types	Incremental encoders sin/cos 1 Vpp (for low shaft heights) (I-2048)	Incremental encoders sin/cos 1 Vpp (I-2048)	Absolute value encoders EnDat (A-2048)	Absolute value encoders EnDat (A-512)	Resolvers 2-pole/ multi-pole
Order No. (MLFB) 14th position for motors with DRIVE-CLiQ	D	D	F	L	U / P
Order No. (MLFB) 14th position for motors without DRIVE-CLiQ	A	A	E	H	S / T
1FT6 02□	X			X	X
1FT6 03□		X	X		X
1FT6 04□		X	X		X
1FT6 06□		X	X		X
1FT6 08□		X	X		X
1FT6 10□		X	X		X
1FT6 13□		X	X		X
1FT6 16□		X	X		X

#### Notice

When the encoder is replaced, the position of the encoder system with respect to the motor EMF must be adjusted. Only qualified personnel may replace an encoder.

### 4.3 Motors with DRIVE-CLiQ

Motors with DRIVE-CLiQ have a sensor module that includes the encoder evaluation, the motor temperature sensing and an electronic rating plate.

This sensor module instead of the signal connector and has a 10-pin RJ45-plus socket.



#### Caution

The sensor module contains motor and encoder-specific data as well as an electronic rating plate. This is the reason that this sensor module may only be operated on the original motor - and may not be mounted onto other motors or replaced by a sensor module from other motors.

The sensor module has direct contact to components that can be destroyed by electrostatic discharge (ESDS). Neither hands nor tools that could be electrostatically charged may come into contact with the connections.

#### Cables

For all encoder types (incremental encoder, absolute value encoder, resolver), the same DRIVE-CLiQ cable is used.

The following cable should be used to connect an encoder:

Table 4-3 Prefabricated cable

6FX	□	002	-	□DC□□	-	□□□	0
	↓					↓↓↓	
	↓					Length	
		5 MOTION-CONNECT®500				Max. cable length 100 m	
		8 MOTION-CONNECT®800				Max. cable length 50 m	

Only prefabricated cables from Siemens (MOTION-CONNECT) may be used.

Additional technical data and length code, refer to Catalog, Chapter "MOTION-CONNECT connection system"

## 4.4 Motors without DRIVE-CLiQ

### 4.4.1 Incremental encoders

Function:

- Angular measuring system for commutation
- Speed actual value sensing
- Indirect incremental measuring system for the position control loop
- One zero pulse (reference mark) per revolution

Table 4-4 Technical data, incremental encoders sin/cos 1Vpp

Features	Incremental encoders sin/cos 1 Vpp (I-2048)	Incremental encoders sin/cos 1 Vpp (low SH) (I-2048)
Mech. limiting speed	15000 RPM	12000 RPM
Operating voltage	5V ± 5%	5V ± 5%
Current consumption	max. 150 mA	max. 150 mA
Resolution, incremental	2048	2048
Incremental signals	1 Vpp	1 Vpp
Angular error	± 40"	± 80"
C-D track (rotor position)	available	available

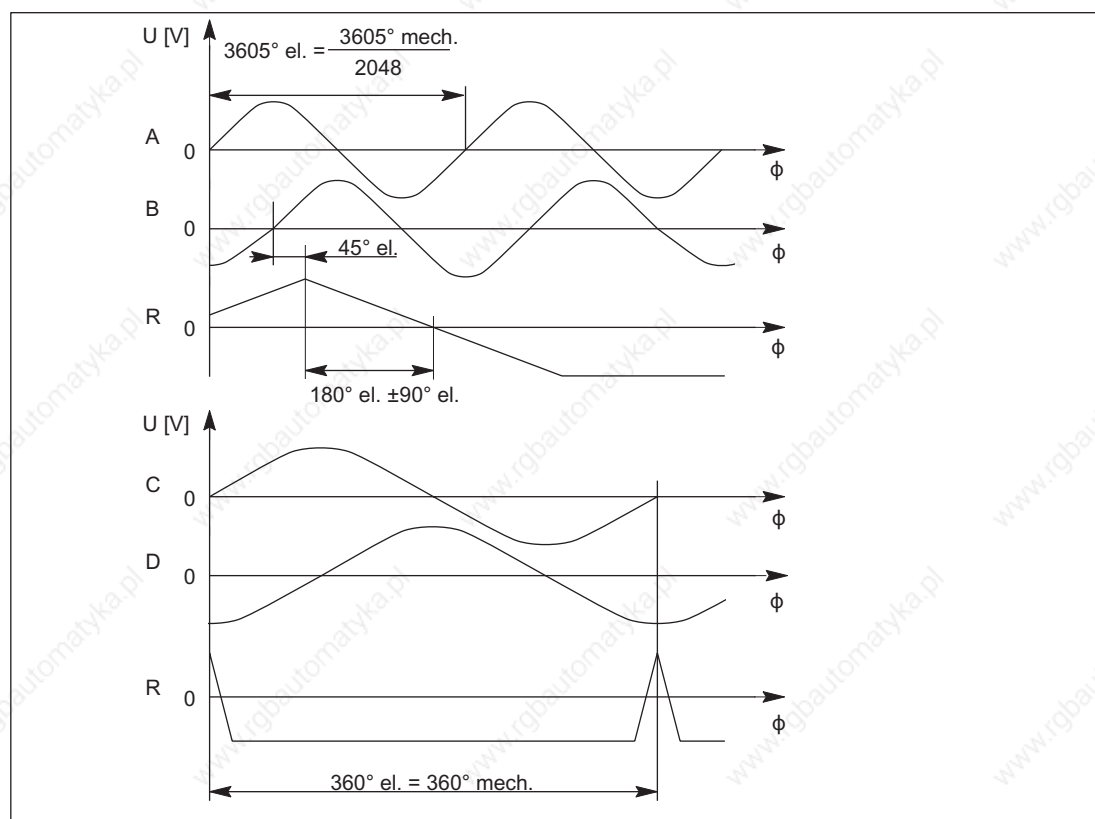
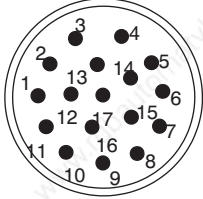

Figure 4-2 Signal sequence and assignment for a positive direction of rotation

Connection assignment for 17-pin flange-mounted socket with pin contacts

Table 4-5 Connection assignment for 17-pin flange-mounted socket

PIN No.	Signal	
1	A+	 <p>When viewing the plug-in side (pins)</p>
2	A-	
3	R+	
4	D-	
5	C+	
6	C-	
7	M encoder	
8	+Temp	
9	-Temp	
10	P encoder	
11	B+	
12	B-	
13	R-	
14	D+	
15	0 V sense	
16	5 V sense	
17	not connected	

Cables

Table 4-6 Prefabricated cable

<b>6FX</b>	<input type="checkbox"/>	<b>002</b>	-	<b>2CA31</b>	-	<input type="checkbox"/> <input type="checkbox"/> <input type="checkbox"/>	<b>0</b>
	↓					↓↓↓	
	↓					Length	
		5 MOTION-CONNECT®500				Max. cable length 100 m	
		8 MOTION-CONNECT®800					

Additional technical data and length code, refer to Catalog, Chapter "MOTION-CONNECT connection system"

## 4.4.2 Absolute value encoders

Function:

- Angular measuring system to impress current
- Speed actual value sensing
- Absolute measuring system for the position control loop

Table 4-7 Technical data, absolute value encoder

Features	Absolute value encoders EnDat (A-2048)	Absolute value encoders EnDat (A-512)
Mech. limiting speed	12000 RPM	12000 RPM
Operating voltage	5V ± 5%	5V ± 5%
Current consumption	max. 300 mA	max. 200 mA
Resolution, incremental (periods per revolution)	2048	512
Resolution, absolute (coded revolutions)	4096	4096
Incremental signals	1 Vpp	1 Vpp
Serial absolute position interface	EnDat	EnDat
Angular error	± 40"	± 80"

### Note

As a result of the reduced maximum operating temperature of absolute value encoders with respect to incremental encoders, the thermally permissible rated motor torque is reduced by 10%.

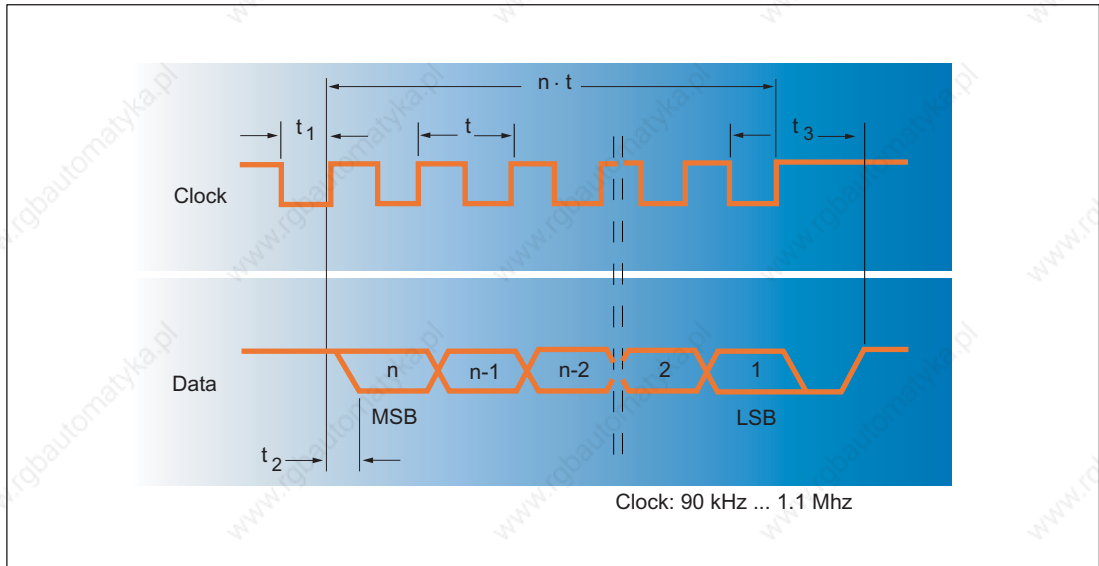

Figure 4-3 Output signals, absolute value encoders

Connection assignment for 17-pin flange-mounted socket with pin contacts

PIN No.	Signal
1	A+
2	A-
3	+data
4	not connected
5	+clock
6	not connected
7	M encoder
8	+Temp
9	-Temp
10	P encoder
11	B+
12	B-
13	-data
14	-clock
15	0 V sense
16	5 V sense
17	not connected

When viewing the plug-in side (pins)



## Cables

Table 4-8 Prefabricated cable

6FX	□	002	-	2EQ10	-	□□□	0
	↓ ↓					↓↓↓ Length	
		5 MOTION-CONNECT®500				Max. cable length 100 m	
		8 MOTION-CONNECT®800					

For other technical data and length code, refer to Catalog, Chapter "MOTION-CONNECT connection system"

### 4.4.3 Resolvers

**Notice**

A max. operating frequency of 470 Hz must be maintained for SINAMICS S120.

Function:

- Speed actual value sensing
- Rotor position encoder for inverter control
- Indirect incremental measuring system for the position control loop

Table 4-9 Technical data, resolvers

Features	Resolvers
Mech. limiting speed	15 000 RPM
Excitation voltage	5 V (rms) to 13 V (rms)
Excitation frequency	4 kHz to 10 kHz
Current consumption	< 80 mA (rms)
Angular accuracy (bandwidth)	
2-pole	< 14'
multi-pole	< 4'
Pole number (The pole number is identical with the motor pole number)	2, 4, 6 or 8
Ratio	0.5

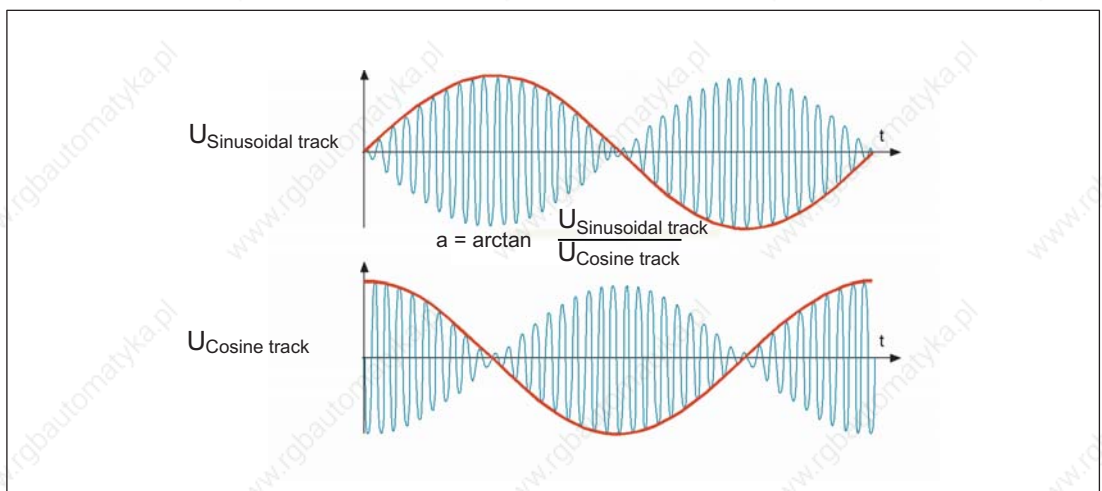
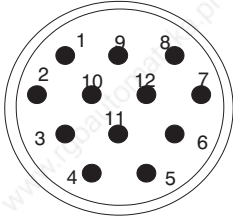

Figure 4-4 Output signals, resolver

### Connection assignment for 12-pin flange-mounted socket with pin contacts

Table 4-10 Connection assignment for 12-pin flange-mounted socket

PIN No.	Signal	
1	S2	 <p>When viewing the plug-in side (pins)</p>
2	S4	
3	not connected	
4	not connected	
5	not connected	
6	not connected	
7	R2/R3	
8	+Temp	
9	-Temp	
10	R1	
11	S1	
12	S3	

### Cables

Table 4-11 Prefabricated cable

6FX	□	002	-	2CF02	-	□□□	0
	↓					↓↓↓	
	↓					Length	
		5 MOTION-CONNECT®500				2-pole resolver: Max. cable length 50 m	
		8 MOTION-CONNECT®800				Multi-pole resolver: Max. cable length 130 m	

Additional technical data and length code, refer to Catalog, Chapter "MOTION-CONNECT connection system"

4.5 Holding brake (option)

## 4.5 Holding brake (option)

For a description of the function, refer to the Configuration Manual "General Section for Synchronous Motors".

The holding brake cannot be retrofitted! Motors with holding brake are longer by the mounted space required (refer to the dimension drawing).

Table 4-12 Technical data of the holding brakes used for 1FT6 motors

Motor type	Brake type	Holding torque M <sub>4</sub> <sup>1)</sup>	Direct current	Opening time with varistor	Closing time with varistor	Highest switching energy
		[Nm]	[A]	[ms]	[ms]	[J]
1FT602□	EBD 0.11 B	1	0.3	20	10	9
1FT603□	EBD 0.15 B	2	0.4	30	15	27
1FT604□	EBD 0.4 BA	5	0.8	50	20	125
1FT606□	EBD 1.5 B	15	0.8	130	30	320
1FT6081	EBD 1.2 B	15	0.8	150	35	750
1FT6082	EBD 1.2 B	15	0.8	150	35	750
1FT6084	EBD 3.5 BN	28	0.9	180	35	1600
1FT6086	EBD 3.5 BN	28	0.9	180	35	1600
1FT610□	EBD 4 B	70	1.4	220	50	2100
1FT613□ <sup>2)</sup>	EBD 8 B	140	1.7	300	90	9800

<sup>1)</sup> Standardized acc. to VDE 0580 with varistor circuitry

<sup>2)</sup> not for water cooling

### Holding torque M<sub>4</sub>

The holding torque M<sub>4</sub> is the minimum brake torque in steady-state operation (when the motor is at a standstill).

## 4.6 Gearbox (option)

### 4.6.1 Introduction

When engineering/dimensioning gearboxes, refer to the documentation "General Section"

### 4.6.2 Planetary gearbox 1-stage

Cyclic operation S3 60 % (power on duration < 60% or power on duration < 20 min.):

Servomotors non-ventilated	Planetary gear 1-stage	Available gear ratios $i =$	Available gear ratios $i =$				Max. perm. motor speed 1)	Max. perm. drive-out torque 1)	Max. perm. rad. drive-out shaft load 2)	Max. perm. ax. drive-out shaft load 2)
			4	5	7	10	$n_{G1}$ $n_1$ RPM	$M_{2G}$ $T_{2B}$ Nm	$F_r$ $F_{2Rmax}$ N	$F_a$ $F_{2Amax}$ N
1FT 6021	SP 060S - MF1 ( $\leq 4$ arcmin)	1.9				x	6000	40 (32 for $i = 10$ )	2700	2400
1FT 6024			x	x	x	x				
1FT 6031			x	x	x	x				
1FT 6034			x	x	x	x				
1FT 6034	SP 075S - MF1 ( $\leq 4$ arcmin)	3.9				x	6000	110 (90 for $i = 10$ )	4000	3350
1FT 6041			x	x	x	x				
1FT 6044			x	x	x	x				
1FT 6061	SP 100S - MF1 ( $\leq 3$ arcmin)	7.7	x	x	x	x	4500	300 (225 for $i = 10$ )	6300	5650
1FT 6062			x	x	x	x				
1FT 6064			x	x	x	x				
1FT 6081	SP 140S - MF1 ( $\leq 3$ arcmin)	17.2	x	x	x	x	4000	600 (480 for $i = 10$ )	9450	9870
1FT 6082			x	x	x	x				
1FT 6084			x	x	x	x				
1FT 6086			x	x	x	x				
1FT 6086	SP 180S - MF1 ( $\leq 3$ arcmin)	34				x	3500	1100 (880 for $i = 10$ )	14700	14150
1FT 6102			x	x	x	x				
1FT 6105			x	x	x	x				
1FT 6108			x	x	x	x				
1FT 6105	SP 210 - MF1 <sup>3)</sup> ( $\leq 4$ arcmin)	53				x	2500	1900 (1520 for $i = 10$ )	18000	22500
1FT 6108						x				
1FT 6132			x	x	x	x				
1FT 6134			x	x	x	x				
1FT 6136			x	x	x	x				
1FT 6134	SP 240 - MF1 <sup>3)</sup> ( $\leq 4$ arcmin)	80				x	2200	2720	27000	27800
1FT 6136						x				

Order code	J02	J03	J05	J09
Gearbox shaft <u>with</u> key	J02	J03	J05	J09
Gearbox shaft <u>without</u> key	J22	J23	J25	J29

4.6 Gearbox (option)

Ordering data: 1FT6□□□-□A□7□-1□□1-Z

Prerequisite for mounting a planetary gear:

IP65, smooth motor shaft end, radial eccentricity tolerance N and vibration severity grade N.

Z = J□□ (SP060S up to SP180S and SP210/SP240, horizontal type of construction)

Z = J□□ + M1□ (SP210 to SP240 in a vertical type of construction)

1) Values for cyclic/positioning duty S3 60 %

2) Referred to the center of the drive-out shaft

3) Caution, oil quantities depend, for these versions, on the mounting position for V types of construction, a "9" must be located at the 12th position of the Order No. [MLFB] and a **second** code is required:

Type of construction IM V1: **M1H**

Type of construction IM V3: **M1G**

Continuous duty S1 (power-on duration > 60% or > 20 min.)

For continuous duty, corresponding to this definition, the limit values from the table below are applicable for

- Motor speed  $n_{1N}$  (RPM)
- Drive-out torques  $T_{2N}$  (Nm)
- Gearbox temperature, max. 90°C

Planetary gear 1-stage		Available			
		Gear ratios $i =$			
Type		4	5	7	10
SP 060S - MF1	$n_{1N}$	3300	3300	4000	4000
	$T_{2N}$	26	26	26	17
SP 075S - MF1	$n_{1N}$	2900	2900	3100	3100
	$T_{2N}$	75	75	75	52
SP 100S - MF1	$n_{1N}$	2500	2500	2800	2800
	$T_{2N}$	180	175	170	120
SP 0140S - MF1	$n_{1N}$	2100	2100	2600	2600
	$T_{2N}$	360	360	360	220
SP 180S - MF1	$n_{1N}$	1500	1500	2300	2300
	$T_{2N}$	750	750	750	750
SP 210-MF1 <sup>3)</sup>	$n_{1N}$	1200	1200	1700	1700
	$T_{2N}$	1000	1000	1000	1000
SP 240-MF1 <sup>3)</sup>	$n_{1N}$	1000	1000	1500	1500
	$T_{2N}$	1700	1700	1700	1700

3) Caution, oil quantities depend, for these versions, on the mounting position for V types of construction, a "9" must be located at the 12th position of the Order No. [MLFB] and a **second** code is required:

Type of construction IM V1: **M1H**

Type of construction IM V3: **M1G**

### Moments of inertia of the gearboxes

Servomotors non-ventilated	Planetary gear 1-stage	Available gear ratios $i =$				
Type	Type	4	5	7	10	
Moment of inertia (referred to the drive)						
1FT 602.	SP 060S - MF1	$J_1$ [kgcm <sup>2</sup> ]	0.16	0.13	0.11	0.10
1FT 603.	SP 060S - MF1	$J_1$ [kgcm <sup>2</sup> ]	0.24	0.22	0.19	0.18
1FT 603.	SP 075S - MF1	$J_1$ [kgcm <sup>2</sup> ]	0.69	0.58	0.48	0.42
1FT 604.	SP 075S - MF1	$J_1$ [kgcm <sup>2</sup> ]	0.94	0.83	0.73	0.67
1FT 606.	SP 100S - MF1	$J_1$ [kgcm <sup>2</sup> ]	3.65	2.99	2.81	2.58
1FT 608.	SP 140S - MF1	$J_1$ [kgcm <sup>2</sup> ]	14.26	13.06	11.97	11.39
1FT 608.	SP 180S - MF1	$J_1$ [kgcm <sup>2</sup> ]	45.08	36.37	28.57	24.40
1FT 610.	SP 180S - MF1	$J_1$ [kgcm <sup>2</sup> ]	45.08	36.37	28.57	24.40
1FT 610.	SP 210 - MF1 <sup>3)</sup>	$J_1$ [kgcm <sup>2</sup> ]	75.80	63.50	52.90	47.10
1FT 613.	SP 210 - MF1 <sup>3)</sup>	$J_1$ [kgcm <sup>2</sup> ]	75.80	63.50	52.90	47.10
1FT 613.	SP 240 - MF1 <sup>3)</sup>	$J_1$ [kgcm <sup>2</sup> ]	146.30	119.90	96.40	83.10

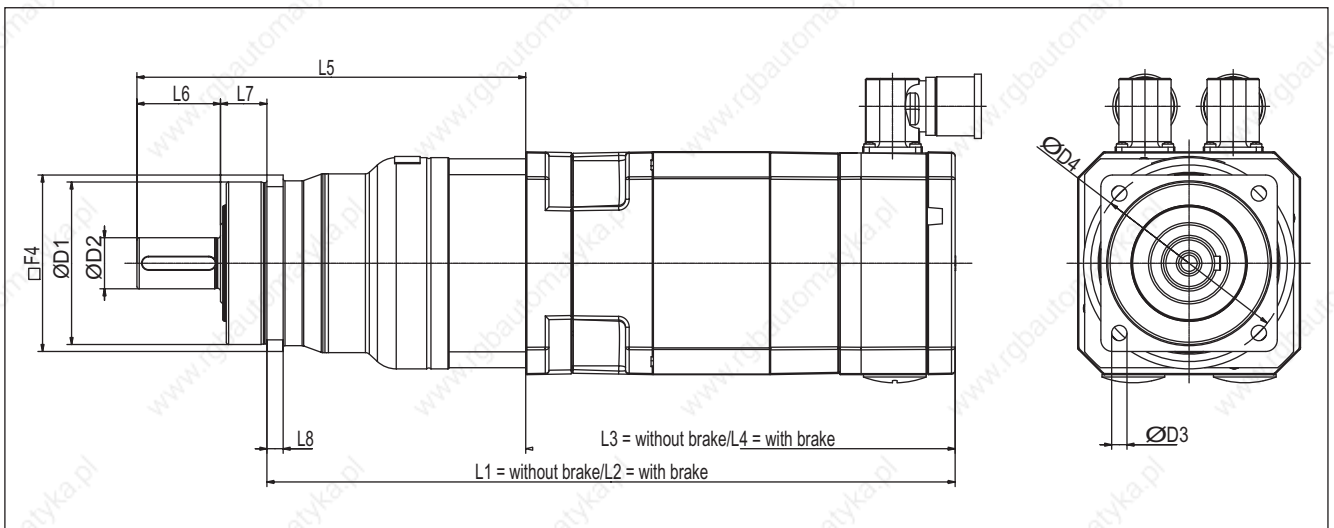

Figure 4-5 1FT6 series with 1-stage planetary gearbox (alpha company)

Motor Components (Options)

4.6 Gearbox (option)

Table 4-13 1FT6 series with 1-stage planetary gearbox (alpha company)

Non-ventilated servomotor								
Type	Dimension L3 = without brake		L4 = with brake		L1 = without brake		L2 = with brake	
	Resolver	"Incr. encoder sin/cos 1 V <sub>pp</sub> absolute value encoder"	Resolver	"Incr. encoder sin/cos 1 V <sub>pp</sub> absolute value encoder"	Resolver	"Incr. encoder sin/cos 1 V <sub>pp</sub> absolute value encoder"	Resolver	"Incr. encoder sin/cos 1 V <sub>pp</sub> absolute value encoder"
1FT 6021-A	193	193	218	218	282	282	307	307
1FT 6024-A	233	233	258	258	322	322	347	347
1FT 6031-A	180	220	200	240	274	314	294	334
1FT 6034-A	220	260	240	280	314	354	334	374
1FT 6034-A	220	260	240	280	328	368	348	388
1FT 6041-A	185	228	220	263	297	340	332	375
1FT 6044-A	235	278	270	313	347	390	382	425
1FT 6061-A	198	228	228	258	327	357	357	387
1FT 6062-A	223	253	253	283	352	382	382	412
1FT 6064-A	273	303	303	333	402	432	432	462
1FT 6081-A	221	221	248	248	392	392	419	419
1FT 6082-A	246	246	273	273	417	417	444	444
1FT 6084-A	296	296	342	342	467	467	513	513
1FT 6086-A	346	346	392	392	517	517	563	563
1FT 6086-A	346	346	392	392	544	544	590	590
1FT 6102-A	295	295	341	341	493	493	539	539
1FT 6105-A	370	370	416	416	568	568	614	614
1FT 6105-A	370	370	416	416	577	577	623	623
1FT 6108-A	470	470	516	516	668	668	714	714
1FT 6108-A	470	470	516	516	677	677	723	723
1FT 6132-A	423	423	473	473	630	630	680	680
1FT 6134-A	473	473	523	523	680	680	730	730
1FT 6134-A	473	473	523	523	739	739	789	789
1FT 6136-A	523	523	573	573	730	730	780	780
1FT 6136-A	523	523	573	573	789	789	839	839



Table 4-14 1FT6 series with 1-stage planetary gearbox (alpha company), continued

Non-ventilated servomotor	Planetary gearbox 1-stage									
	Type	□F4	Type	Dimensions						
				ØD1	ØD2	ØD3	ØD4	L5	L6	L7
1FT 6021-A	62	SP060S-MF1	60	16	5.5	68	137	28	20	6
1FT 6024-A	62	SP060S-MF1	60	16	5.5	68	137	28	20	6
1FT 6031-A	62	SP060S-MF1	60	16	5.5	68	142	28	20	6
1FT 6034-A	62	SP060S-MF1	60	16	5.5	68	142	28	20	6
1FT 6034-A	76	SP075S-MF1	70	22	6.6	85	164	36	20	7
1FT 6041-A	76	SP075S-MF1	70	22	6.6	85	168	36	20	7
1FT 6044-A	76	SP075S-MF1	70	22	6.6	85	168	36	20	7
1FT 6061-A	101	SP100S-MF1	90	32	9	120	217	58	30	10
1FT 6062-A	101	SP100S-MF1	90	32	9	120	217	58	30	10
1FT 6064-A	101	SP100S-MF1	90	32	9	120	217	58	30	10
1FT 6081-A	141	SP140S-MF1	130	40	11	165	283	82	30	12
1FT 6082-A	141	SP140S-MF1	130	40	11	165	283	82	30	12
1FT 6084-A	141	SP140S-MF1	130	40	11	165	283	82	30	12
1FT 6086-A	141	SP140S-MF1	130	40	11	165	283	82	30	12
1FT 6086-A	182	SP180S-MF1	160	55	13.5	215	310	82	30	15
1FT 6102-A	182	SP180S-MF1	160	55	13.5	215	310	82	30	15
1FT 6105-A	182	SP180S-MF1	160	55	13.5	215	310	82	30	15
1FT 6105-A	212	SP210-MF1	180	75	17	250	350	105	38	17
1FT 6108-A	182	SP180S-MF1	160	55	13.5	215	310	82	30	15
1FT 6108-A	212	SP210-MF1	180	75	17	250	350	105	38	17
1FT 6132-A	212	SP210-MF1	180	75	17	250	350	105	38	17
1FT 6134-A	212	SP210-MF1	180	75	17	250	350	105	38	17
1FT 6134-A	242	SP240-MF1	200	85	17	290	436	130	40	20
1FT 6136-A	212	SP210-MF1	180	75	17	250	350	105	38	17
1FT 6136-A	242	SP240-MF1	200	85	17	290	436	130	40	20

Motor Components (Options)

4.6 Gearbox (option)

4.6.3 Planetary gearbox 2-stage

Cyclic duty S3 60% (power-on duration < 60% or power-on duration < 20 min.):

Servomotor, non-ventilated	Planetary gear 2-stage	Available gear ratios i =						Max. perm. motor speed	Max. perm. drive-out torque	Max. perm. radial drive-out shaft load	Max. perm. axial drive-out shaft load
			Gearbox weight	16	20	28	40	50	$n_{G1}$ $n_1$ RPM	$M_{2G}$ $T_{2B}$ Nm	$F_r$ $F_{2Rmax}$ N
Type	Type	Kg									
1FT 6021	SP 060S - MF2 (≤ 6 arcmin)	2	X	X	X	X	X	6000	40	2700	2400
1FT 6024			X	X	X	X					
1FT 6031			X	X	X						
1FT 6024	SP 075S - MF2 (≤ 6 arcmin)	3.6					X	6000	110	4000	3350
1FT 6031						X	X				
1FT 6034			X	X	X						
1FT 6041			X	X							
1FT 6034	SP 100S - MF2 (≤ 5 arcmin)	7.9				X	X	4500	300	6300	5650
1FT 6041					X	X	X				
1FT 6044			X	X	X						
1FT 6061			X	X	X	X					
1FT 6062			X	X	X						
1FT 6064			X								
1FT 6044	SP 140S - MF2 (≤ 5 arcmin)	17				X	X	4000	600	9450	9870
1FT 6061						X	X				
1FT 6062						X					
1FT 6064				X	X						
1FT 6081			X	X	X	X					
1FT 6082			X	X							
1FT 6084	X										
1FT 6064	SP 180S - MF2 (≤ 5 arcmin)	36.4				X	X	4000	1100	14700	14150
1FT 6081						X	X				
1FT 6082					X	X					
1FT 6084			X	X	X						
1FT 6086			X	X							
1FT 6102	X										
1FT 6082	SP 210-MF2 <sup>3)</sup> (≤ 6 arcmin)	50					X	3500	1900	18000	22500
1FT 6105			X								
1FT 6084	SP 240-MF2 <sup>3)</sup> (≤ 6 arcmin)	70				X	X	3500	3400	27000	27800
1FT 6086					X	X	X				
1FT 6102					X	X	X				
1FT 6105				X	X						
1FT 6108			X	X							
1FT 6132			X	X							
1FT 6134			X								
1FT 6136			X								

Code						
Gearbox shaft <u>with</u> fitted key	J12	J13	J15	J16	J17	
Gearbox shaft <u>without</u> fitted key	J32	J33	J35	J36	J37	

- 1) Values for cyclic/positioning duty S3 60 %
- 2) referred to the center of the drive-out shaft
- 3) refer to footnote 3 on the next page

Ordering data: 1FT6□□□-□A□7□-1□□1-Z

Prerequisites for mounting a planetary gearbox:

IP65, smooth motor shaft end, radial eccentricity N and vibration severity grade N.

Z = J □□ (SP060S to SP180S and SP210/SP240 in a horizontal type of construction)

Z = J □□ + M1□ (SP210 to SP240 in a vertical type of construction)

### Continuous duty S1 (power-on duration > 60% or > 20 min.):

For continuous operation, corresponding to the definition, the limit values from the table below apply for:

- Motor speed  $n_{1N}$  (RPM)
- Drive-out torques  $T_{2N}$  (Nm)
- Max. gearbox temperature, 90°C

Planetary gear 2-stage		Available gear ratios $i =$				
		16	20	28	40	50
Type						
SP 060S - MF2	$n_{1N}$	4400	4400	4400	4400	4800
	$T_{2N}$	26	26	26	26	26
SP 075S - MF2	$n_{1N}$	3500	3500	3500	3500	3800
	$T_{2N}$	75	75	75	75	75
SP 100S - MF2	$n_{1N}$	3100	3100	3100	3100	3500
	$T_{2N}$	180	180	180	180	175
SP 140S - MF2	$n_{1N}$	2900	2900	2900	2900	3200
	$T_{2N}$	360	360	360	360	360
SP 180S - MF2	$n_{1N}$	2700	2700	2700	2700	2900
	$T_{2N}$	750	750	750	750	750
SP 210 - MF2 <sup>3)</sup>	$n_{1N}$	2100	2100	2100	2300	2300
	$T_{2N}$	1000	1000	1000	1000	1000
SP 240 - MF2 <sup>3)</sup>	$n_{1N}$	1900	1900	1900	2100	2100
	$T_{2N}$	1700	1700	1700	1700	1700

<sup>3)</sup> Caution For these versions, the amount of oil depends on the mounting position - for types of construction a "9" should be set at the 12th position of the Order No. (MLFB) and a **second** code is required:

Type of construction IM V1: **M1H**

Type of construction IM V3: **M1G**

4.6 Gearbox (option)

Moments of inertia of the gearboxes

Servomotor non-ventilated	Planetary gear 2-stage	Available gear ratios $i =$					
			16	20	28	40	50
Type	Type						
Moment of inertia (referred to the drive)							
1FT 602.	SP 060S - MF2	$J_1$ [kgcm <sup>2</sup> ]	0.08	0.07	0.06	0.06	0.06
1FT 602.	SP 075S - MF2	$J_1$ [kgcm <sup>2</sup> ]	0.17	0.14	0.11	0.10	0.10
1FT 603.	SP 060S - MF2	$J_1$ [kgcm <sup>2</sup> ]	0.18	0.17	0.16	0.16	0.16
1FT 603.	SP 075S - MF2	$J_1$ [kgcm <sup>2</sup> ]	0.25	0.22	0.19	0.18	0.18
1FT 603.	SP 100S - MF2	$J_1$ [kgcm <sup>2</sup> ]	0.72	0.60	0.49	0.43	0.43
1FT 604.	SP 075S - MF2	$J_1$ [kgcm <sup>2</sup> ]	0.68	0.65	0.62	0.61	0.61
1FT 604.	SP 100S - MF2	$J_1$ [kgcm <sup>2</sup> ]	0.96	0.84	0.73	0.67	0.66
1FT 604.	SP 140S - MF2	$J_1$ [kgcm <sup>2</sup> ]	2.79	2.26	1.84	1.58	1.57
1FT 606.	SP 100S - MF2	$J_1$ [kgcm <sup>2</sup> ]	2.60	2.48	2.36	2.31	2.30
1FT 606.	SP 140S - MF2	$J_1$ [kgcm <sup>2</sup> ]	3.61	3.08	2.66	2.39	2.38
1FT 606.	SP 180S - MF2	$J_1$ [kgcm <sup>2</sup> ]	10.24	8.48	6.90	6.06	5.98
1FT 608.	SP 140S - MF2	$J_1$ [kgcm <sup>2</sup> ]	9.60	9.07	8.65	8.39	8.37
1FT 608.	SP 180S - MF2	$J_1$ [kgcm <sup>2</sup> ]	15.83	14.08	12.49	11.65	11.58
1FT 608.	SP 210-MF2 <sup>3)</sup>	$J_1$ [kgcm <sup>2</sup> ]	36.30	34.50	32.30	23.10	21.90
1FT 608.	SP 240-MF2 <sup>3)</sup>	$J_1$ [kgcm <sup>2</sup> ]	47.30	43.10	37.50	32.40	29.50
1FT 610.	SP 180S - MF2	$J_1$ [kgcm <sup>2</sup> ]	14.36	12.06	11.02	10.17	10.10
1FT 610.	SP 210-MF2 <sup>3)</sup>	$J_1$ [kgcm <sup>2</sup> ]	37.40	35.60	33.40	24.30	23.00
1FT 610.	SP 240-MF2 <sup>3)</sup>	$J_1$ [kgcm <sup>2</sup> ]	48.40	44.20	38.60	33.60	30.60
1FT 613.	SP 240-MF2 <sup>3)</sup>	$J_1$ [kgcm <sup>2</sup> ]	53.00	48.80	43.20	38.10	35.10

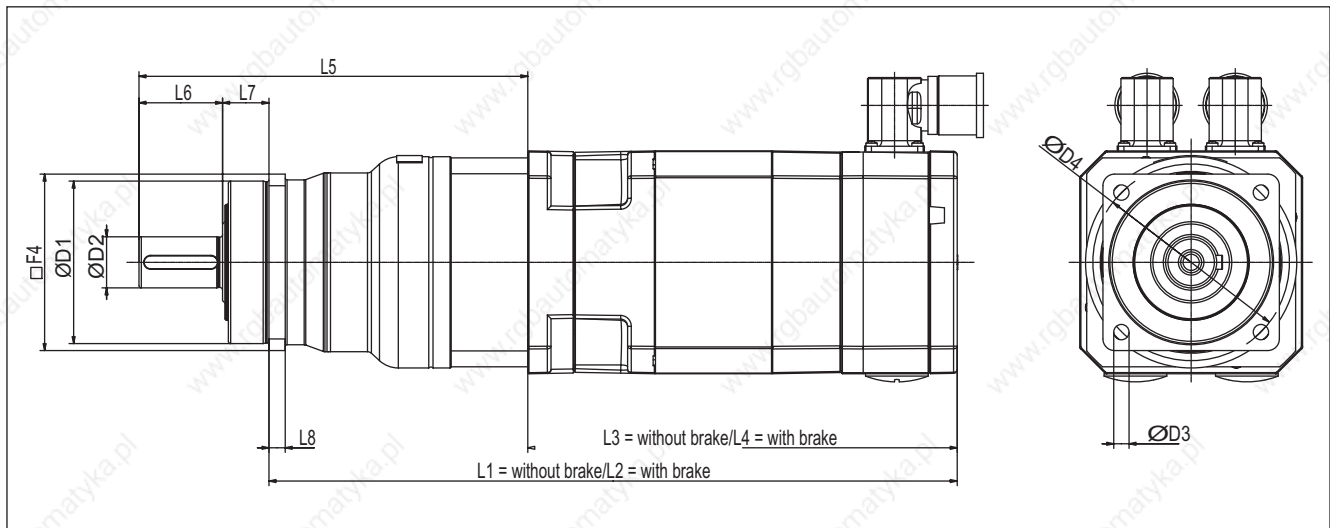

Figure 4-6 1FT6 series with 2-stage planetary gearbox (alpha company)

Table 4-15 1FT6 series with 2-stage planetary gearbox (alpha company)

Servomotor, non-ventilated								
Type	Dimensions L3 = without brake		L4 = with brake		L1 = without brake		L2 = with brake	
	Resolver	"Incr. encoder sin/cos 1 V <sub>pp</sub> absolute value encoder"	Resolvers	"Incr. encoder sin/cos 1 V <sub>pp</sub> absolute value encoder"	Resolvers	"Incr. encoder sin/cos 1 V <sub>pp</sub> absolute value encoder"	Resolvers	"Incr. encoder sin/cos 1 V <sub>pp</sub> absolute value encoder"
1FT 6021-A	193	193	218	218	301	301	326	326
1FT 6021-A	193	193	218	218	312	312	337	337
1FT 6024-A	233	233	258	258	341	341	366	366
1FT 6024-A	233	233	258	258	352	352	377	377
1FT 6024-A	233	233	258	258	375	375	400	400
1FT 6031-A	180	220	200	240	296	336	316	356
1FT 6031-A	180	220	200	240	303	343	323	363
1FT 6031-A	180	220	200	240	322	362	342	382
1FT 6034-A	220	260	240	280	343	383	363	403
1FT 6034-A	220	260	240	280	362	402	382	422
1FT 6034-A	220	260	240	280	406	446	426	466
1FT 6041-A	185	228	220	263	321	364	356	399
1FT 6041-A	185	228	220	263	331	374	366	409
1FT 6041-A	185	228	220	263	371	414	406	449
1FT 6044-A	235	278	270	313	381	424	416	459
1FT 6044-A	235	278	270	313	421	464	456	499
1FT 6044-A	235	278	270	313	469	512	504	547
1FT 6061-A	198	228	228	258	362	392	392	422
1FT 6061-A	198	228	228	258	391	421	421	451
1FT 6061-A	198	228	228	258	432	462	462	492
1FT 6062-A	223	253	253	283	387	417	417	447
1FT 6062-A	223	253	253	283	416	446	446	476
1FT 6064-A	273	303	303	333	437	467	467	497
1FT 6064-A	273	303	303	333	466	496	496	526
1FT 6064-A	273	303	303	333	507	537	537	567
1FT 6081-A	221	221	248	248	441	441	468	468
1FT 6081-A	221	221	248	248	464	464	491	491
1FT 6081-A	221	221	248	248	475	475	502	502
1FT 6082-A	246	246	273	273	466	466	493	493
1FT 6082-A	246	246	273	273	489	489	516	516
1FT 6082-A	246	246	273	273	500	500	527	527
1FT 6084-A	296	296	342	342	516	516	562	562
1FT 6084-A	296	296	342	342	539	539	585	585
1FT 6084-A	296	296	342	342	580	580	626	626

Motor Components (Options)

4.6 Gearbox (option)

Servomotor, non-ventilated								
Type	Dimensions L3 = without brake		L4 = with brake		L1 = without brake		L2 = with brake	
	Resolver	"Incr. encoder sin/cos 1 V <sub>pp</sub> absolute value encoder"	Resolvers	"Incr. encoder sin/cos 1 V <sub>pp</sub> absolute value encoder"	Resolvers	"Incr. encoder sin/cos 1 V <sub>pp</sub> absolute value encoder"	Resolvers	"Incr. encoder sin/cos 1 V <sub>pp</sub> absolute value encoder"
1FT 6086-A	346	346	392	392	566	566	612	612
1FT 6086-A	346	346	392	392	589	589	635	635
1FT 6102-A	295	295	341	341	538	538	584	584
1FT 6102-A	295	295	341	341	579	579	625	625
1FT 6105-A	370	370	416	416	624	624	670	670
1FT 6105-A	370	370	416	416	654	654	700	700
1FT 6108-A	470	470	516	516	754	754	800	800
1FT 6132-A	423	423	473	473	677	677	727	727
1FT 6134-A	473	473	523	523	757	757	807	807
1FT 6136-A	523	523	573	573	807	807	857	857

Table 4-16 1FT6 series with 2-stage planetary gearbox (alpha company)

Servomotor, non-ventilated	Planetary gearbox 2-stage									
	Type	□F4	Type	Dimensions						
				ØD1	ØD2	ØD3	ØD4	L5	L6	L7
1FT 6021-A	62	SP060S - MF2	60	16	5.5	68	156	28	20	6
1FT 6021-A	76	SP075S - MF2	70	22	6.6	85	175	36	20	7
1FT 6024-A	62	SP060S - MF2	60	16	5.5	68	156	28	20	6
1FT 6024-A	76	SP075S - MF2	70	22	6.6	85	175	36	20	7
1FT 6024-A	101	SP100S - MF2	90	32	9	120	230	58	30	10
1FT 6031-A	62	SP060S - MF2	60	16	5.5	68	164	28	20	6
1FT 6031-A	76	SP075S - MF2	70	22	6.6	85	179	36	20	7
1FT 6031-A	101	SP100S - MF2	90	32	9	120	230	58	30	10
1FT 6034-A	76	SP075S - MF2	70	22	6.6	85	179	36	20	7
1FT 6034-A	101	SP100S - MF2	90	32	9	120	230	58	30	10
1FT 6034-A	141	SP140S - MF2	130	40	11	165	298	82	30	12
1FT 6041-A	76	SP075S - MF2	70	22	6.6	85	192	36	20	7
1FT 6041-A	101	SP100S - MF2	90	32	9	120	234	58	30	10
1FT 6041-A	141	SP140S - MF2	130	40	11	165	298	82	30	12
1FT 6044-A	101	SP100S - MF2	90	32	9	120	234	58	30	10
1FT 6044-A	141	SP140S - MF2	130	40	11	165	298	82	30	12

Servomotor, non-ventilated		Planetary gearbox 2-stage								
Type	□F4	Type	Dimensions							
			ØD1	ØD2	ØD3	ØD4	L5	L6	L7	L8
1FT 6044-A	182	SP180S - MF2	160	55	13.5	215	346	82	30	15
1FT 6061-A	101	SP100S - MF2	90	32	9	120	252	58	30	10
1FT 6061-A	141	SP140S - MF2	130	40	11	165	305	82	30	12
1FT 6061-A	182	SP180S - MF2	160	55	13.5	215	346	82	30	15
1FT 6062-A	101	SP100S - MF2	90	32	9	120	252	58	30	10
1FT 6062-A	141	SP140S - MF2	130	40	11	165	305	82	30	12
1FT 6064-A	101	SP100S - MF2	90	32	9	120	252	58	30	10
1FT 6064-A	141	SP140S - MF2	130	40	11	165	305	82	30	12
1FT 6064-A	182	SP180S - MF2	160	55	13.5	215	346	82	30	15
1FT 6081-A	141	SP140S - MF2	130	40	11	165	332	82	30	12
1FT 6081-A	182	SP180S - MF2	160	55	13.5	215	355	82	30	15
1FT 6081-A	121	SP210 - MF2	180	75	17	250	397	105	38	17
1FT 6082-A	141	SP140S - MF2	130	40	11	165	332	82	30	12
1FT 6082-A	182	SP180S - MF2	160	55	13.5	215	355	82	30	15
1FT 6082-A	121	SP210 - MF2	180	75	17	250	397	105	38	17
1FT 6084-A	141	SP140S - MF2	130	40	11	165	332	82	30	12
1FT 6084-A	182	SP180S - MF2	160	55	13.5	215	355	82	30	15
1FT 6084-A	242	SP240 - MF2	200	85	17	290	454	130	40	20
1FT 6086-A	141	SP140S - MF2	130	40	11	165	332	82	30	12
1FT 6086-A	182	SP180S - MF2	160	55	13.5	215	355	82	30	15
1FT 6102-A	182	SP180S - MF2	160	55	13.5	215	355	82	30	15
1FT 6102-A	242	SP240 - MF2	200	85	17	290	454	130	40	20
1FT 6105-A	212	SP210 - MF2	180	75	17	250	397	105	38	17
1FT 6105-A	242	SP240 - MF2	200	85	17	290	454	130	40	20
1FT 6108-A	242	SP240 - MF2	200	85	17	290	454	130	40	20
1FT 6132-A	212	SP210 - MF2	180	75	17	250	397	105	38	170
1FT 6134-A	242	SP240 - MF2	200	85	17	290	454	130	40	20
1FT 6136-A	242	SP240 - MF2	200	85	17	290	454	130	40	20

## *Motor Components (Options)*

---

### *4.6 Gearbox (option)*



## Dimension Drawings

### 5.1 Introduction

---

**Note**

Siemens AG reserves the right to change the dimensions of the motors as part of mechanical design improvements without prior notice. This means that dimensions drawings can go out-of-date. Up-to-date dimension drawings can be requested at no charge from your local SIEMENS sales department.

---

## 5.2 1FT6 with DRIVE-CLiQ

### 5.2.1 Non-ventilated 1FT6 motors

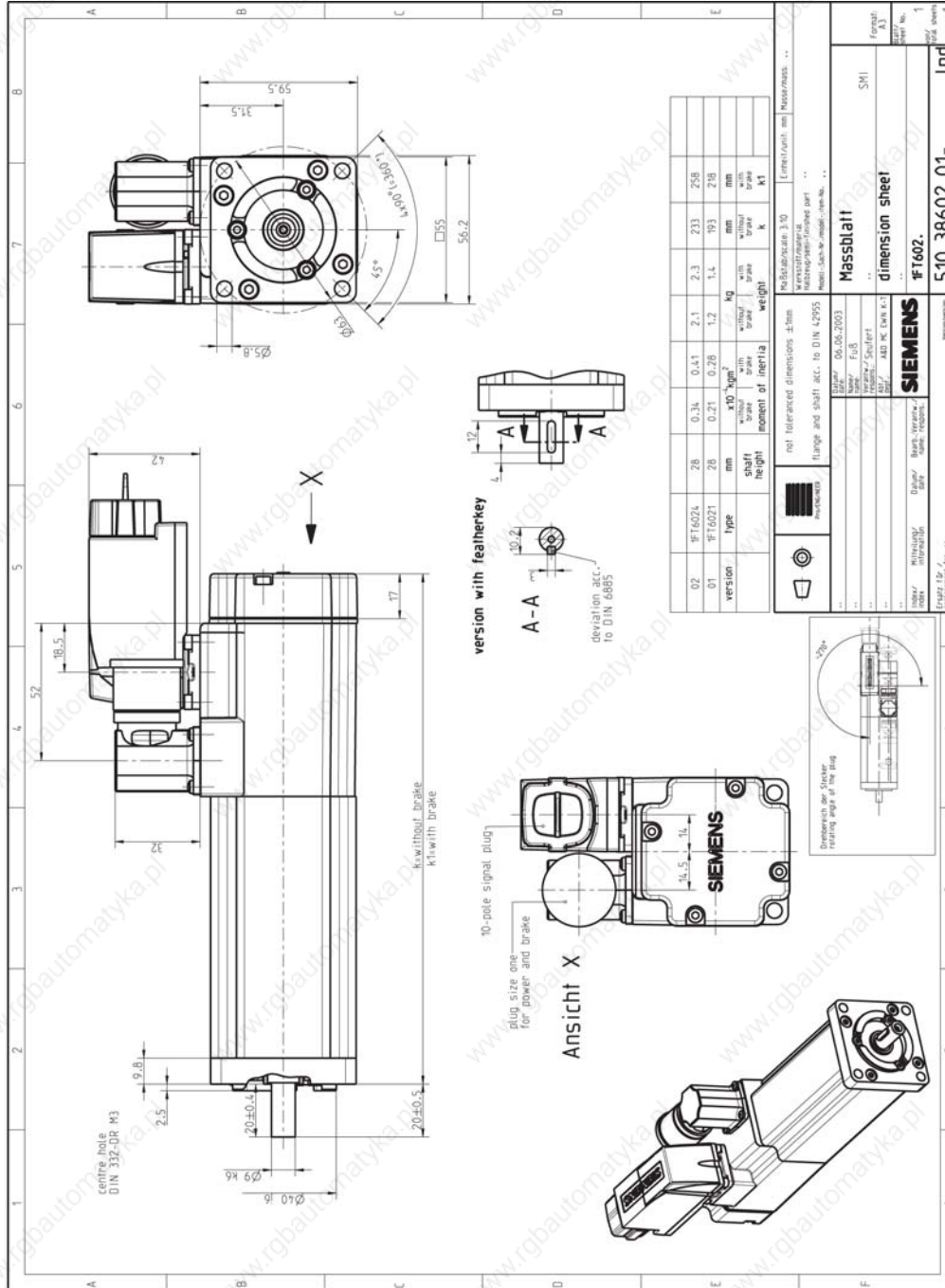

Figure 5-1 1FT602□-□A□DQ











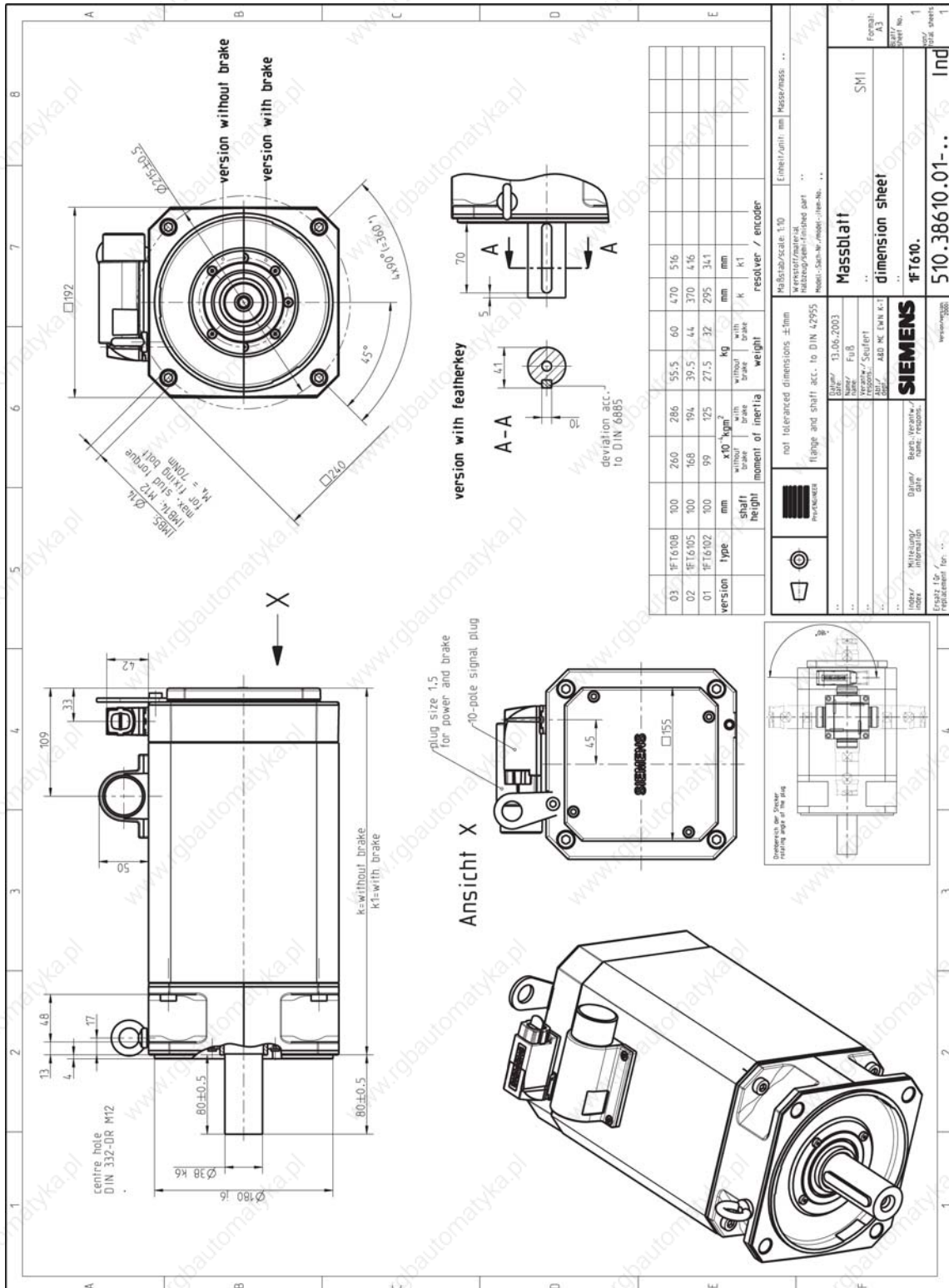

Figure 5-6 1FT610□-□A□plug□DQ







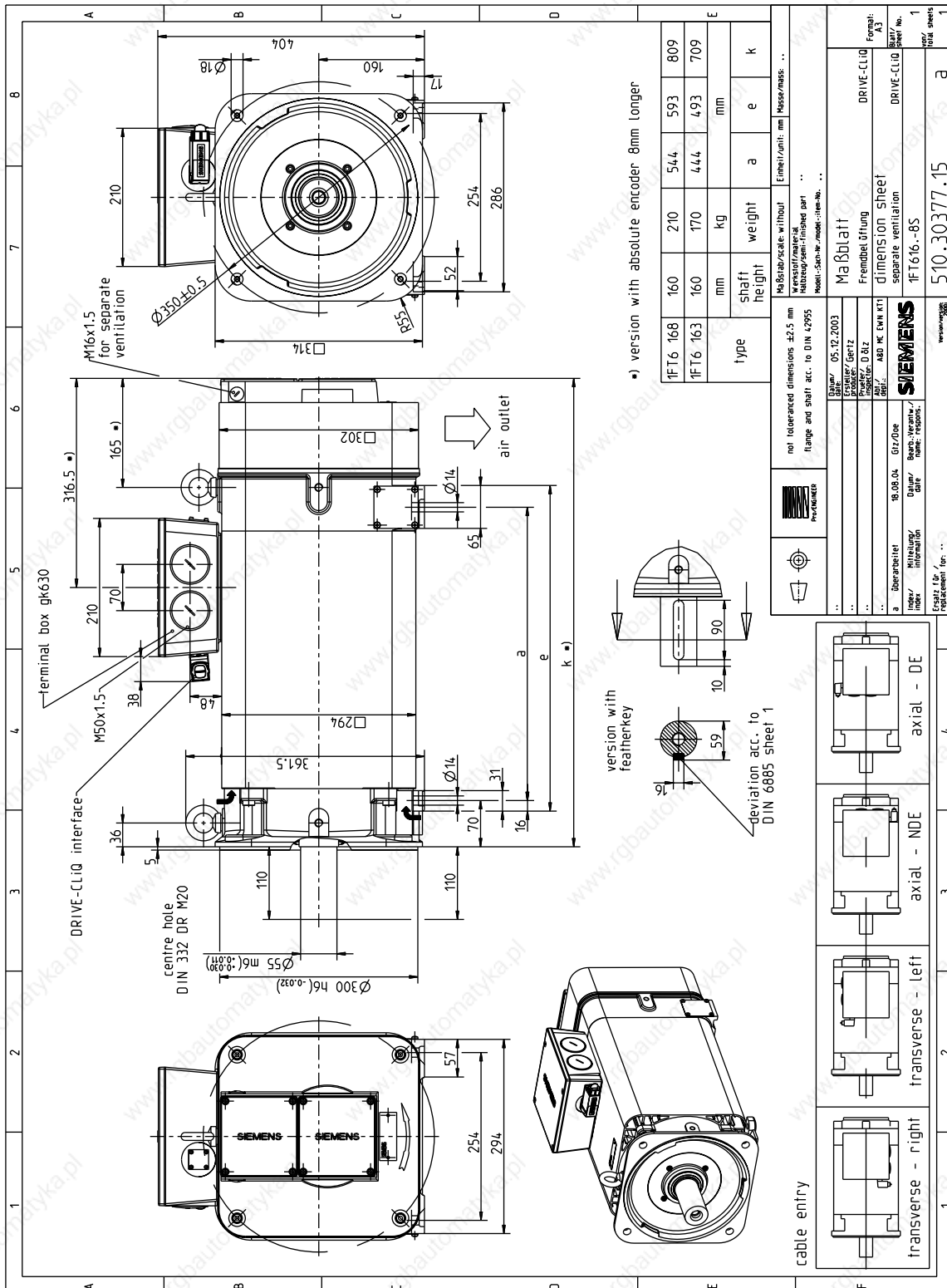

Figure 5-8 1FT616x-8Sx76-5xxx\_DQ





Dimension Drawings  
5.2 1FT6 with DRIVE-CLiQ

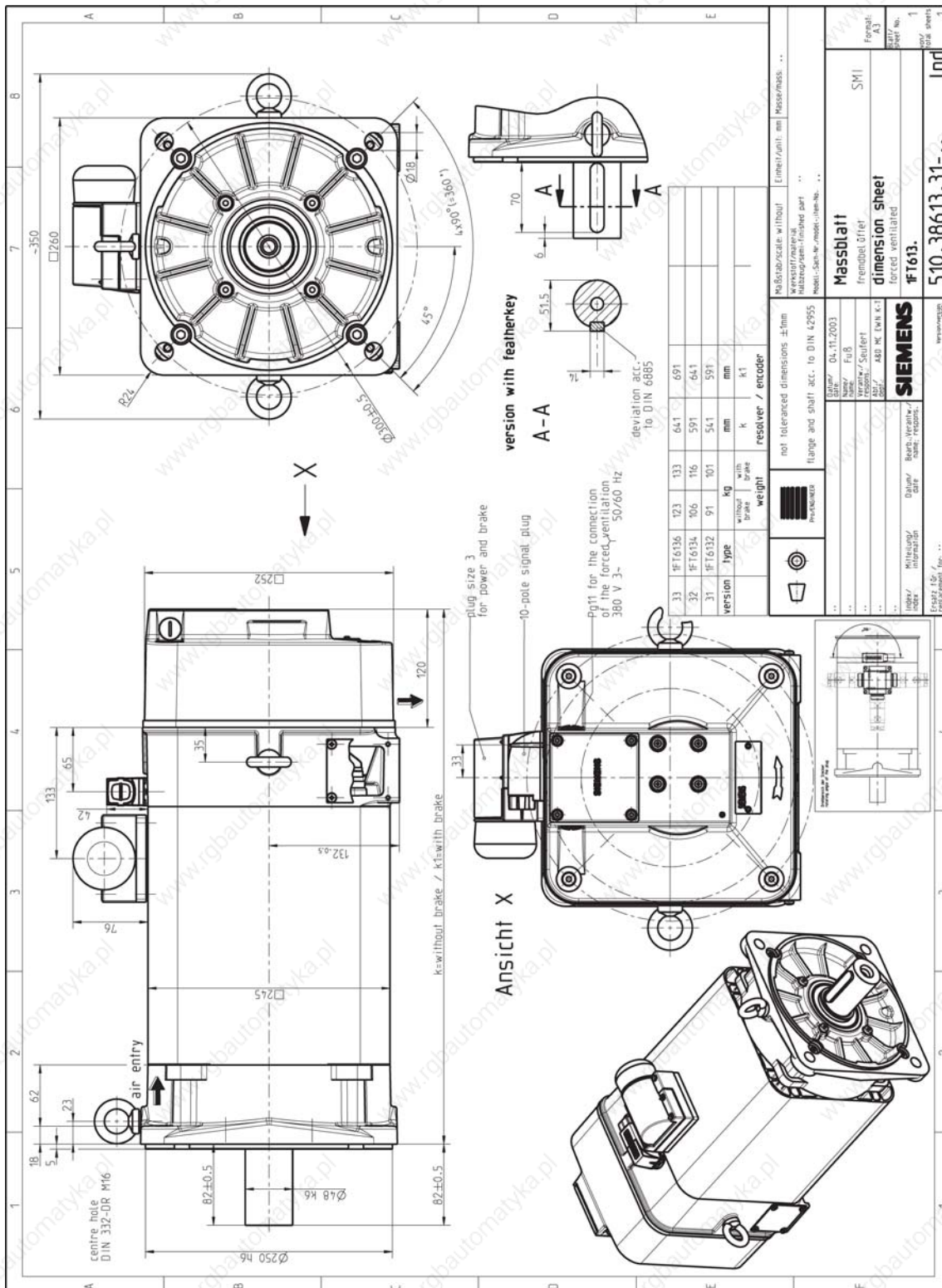

Figure 5-11 1FT613□-□S□plug□DQ





Dimension Drawings  
5.2 1FT6 with DRIVE-CLIQ

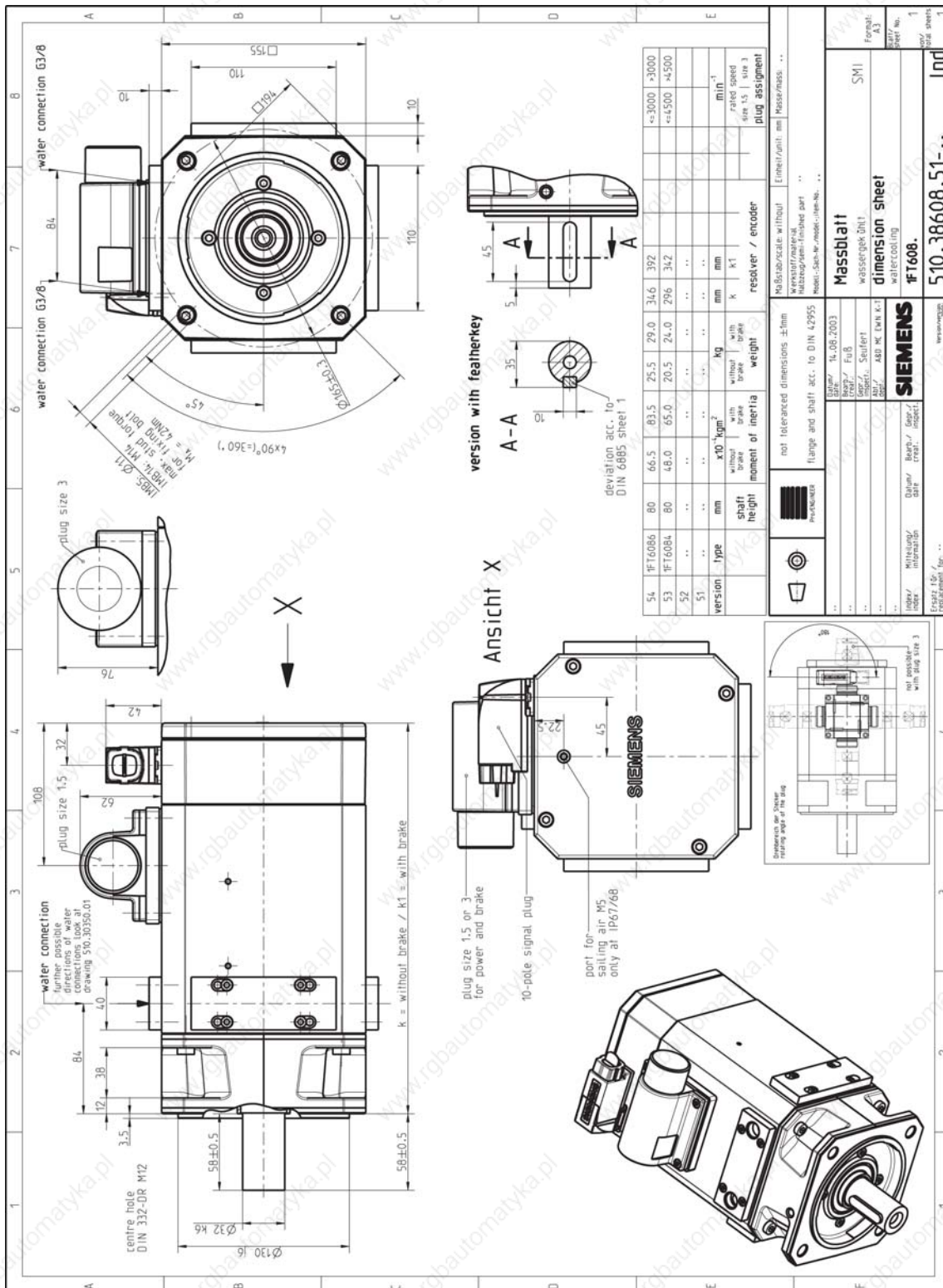

Figure 5-13 1FT608□-□W□DQ





5.2 1FT6 with DRIVE-CLIQ

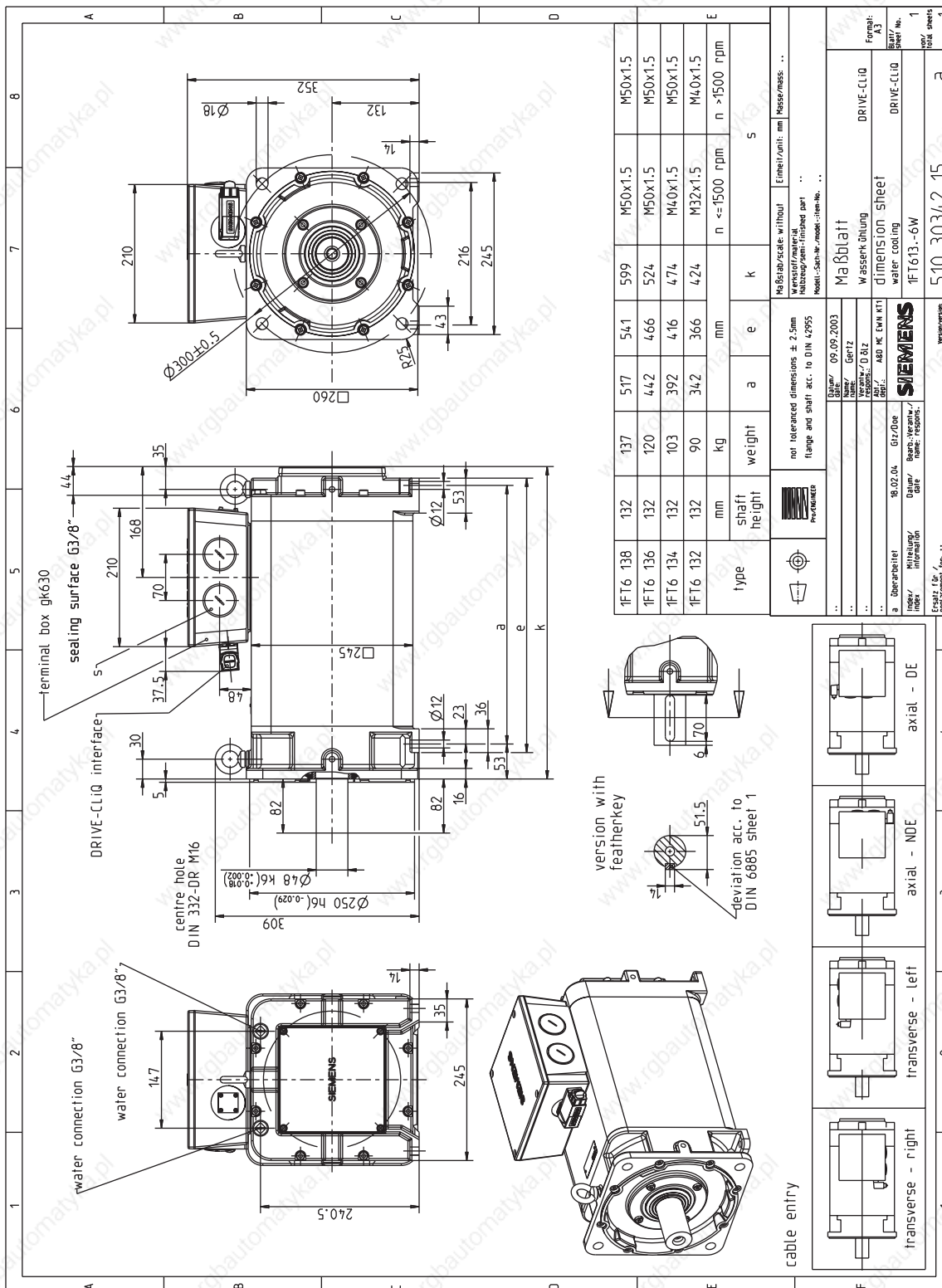

Figure 5-15 1FT613x-6Wx76-5xxx\_DQ





### 5.3 1FT6 without DRIVE-CLiQ

#### 5.3.1 Non-ventilated 1FT6 motors

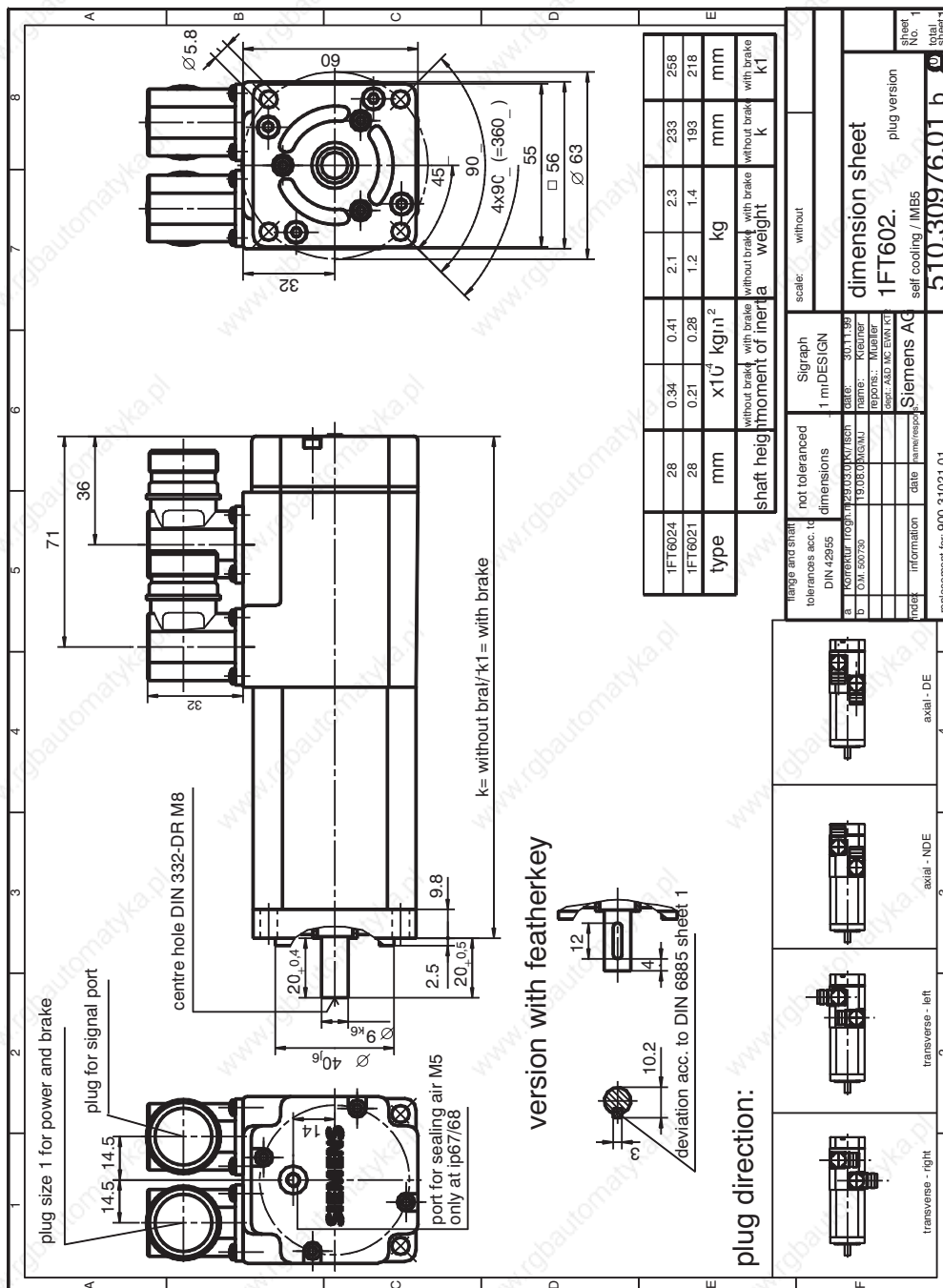

Figure 5-17 1FT602□ non-ventilated with connector, Size 1

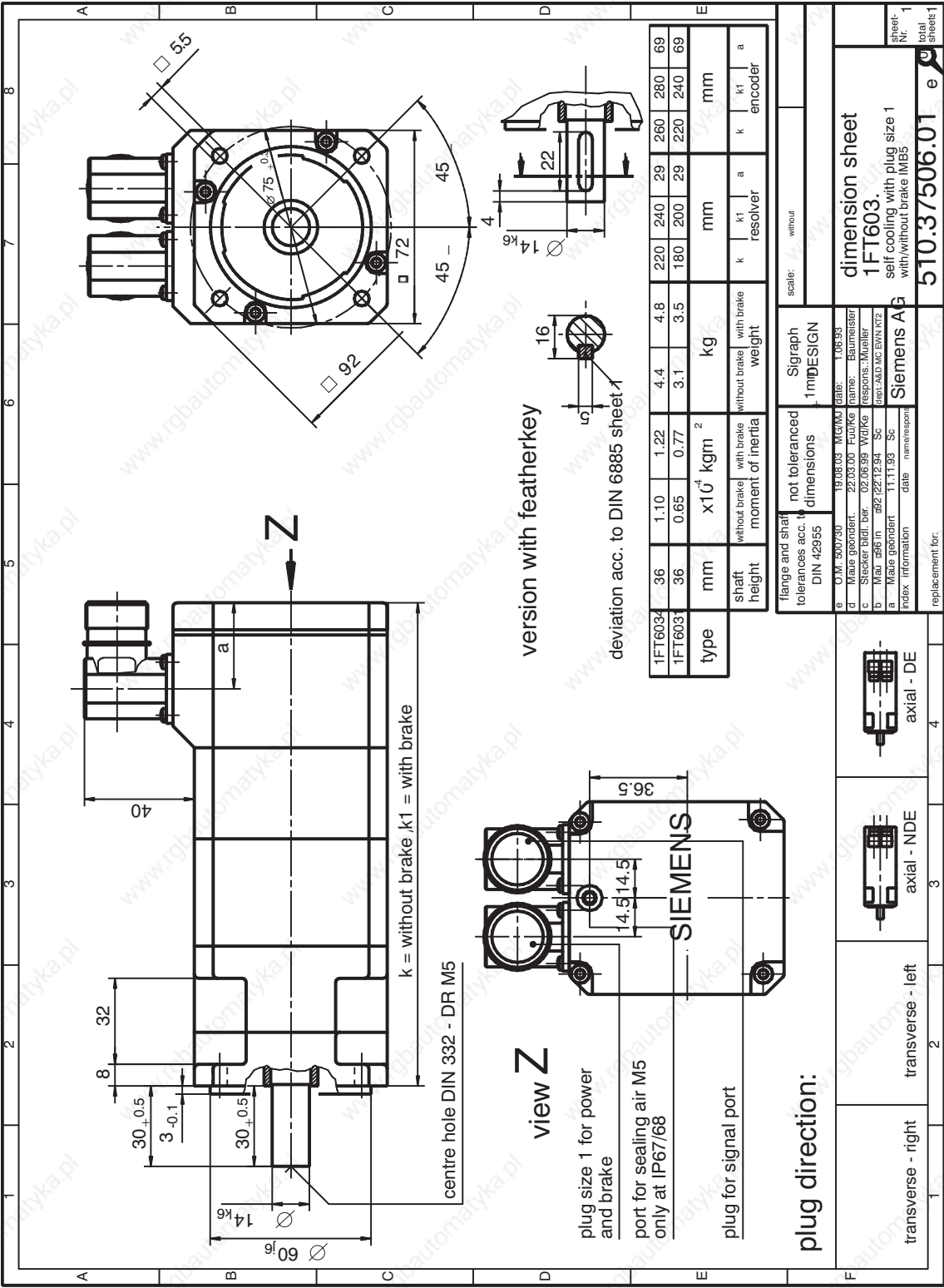

Figure 5-18 1FT603□ non-ventilated with connector, Size 1

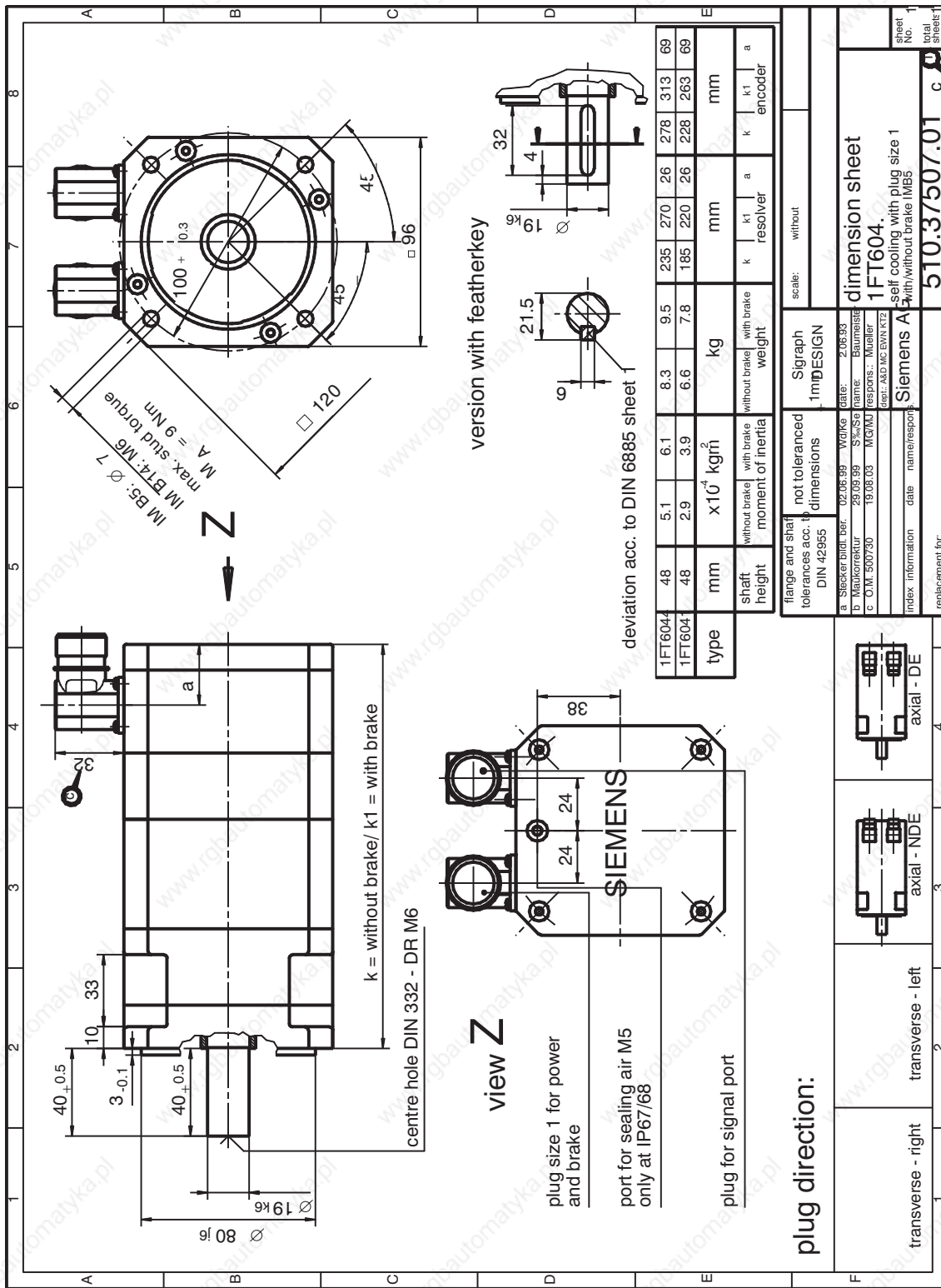

Figure 5-19 1FT604□ non-ventilated with connector, Size 1

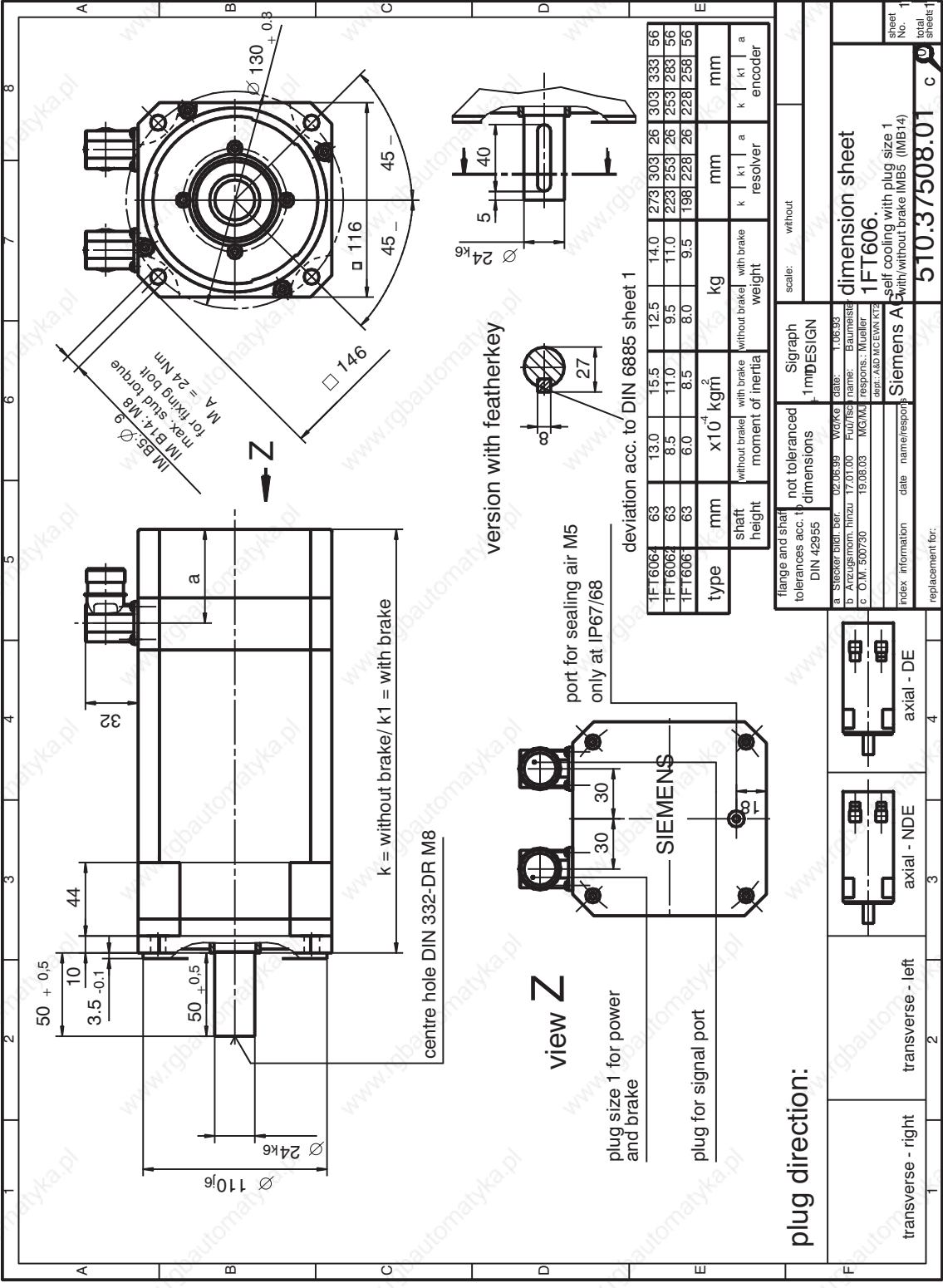

Figure 5-20 1FT606□ non-ventilated with connector, Size 1



5.3 1FT6 without DRIVE-CLiQ

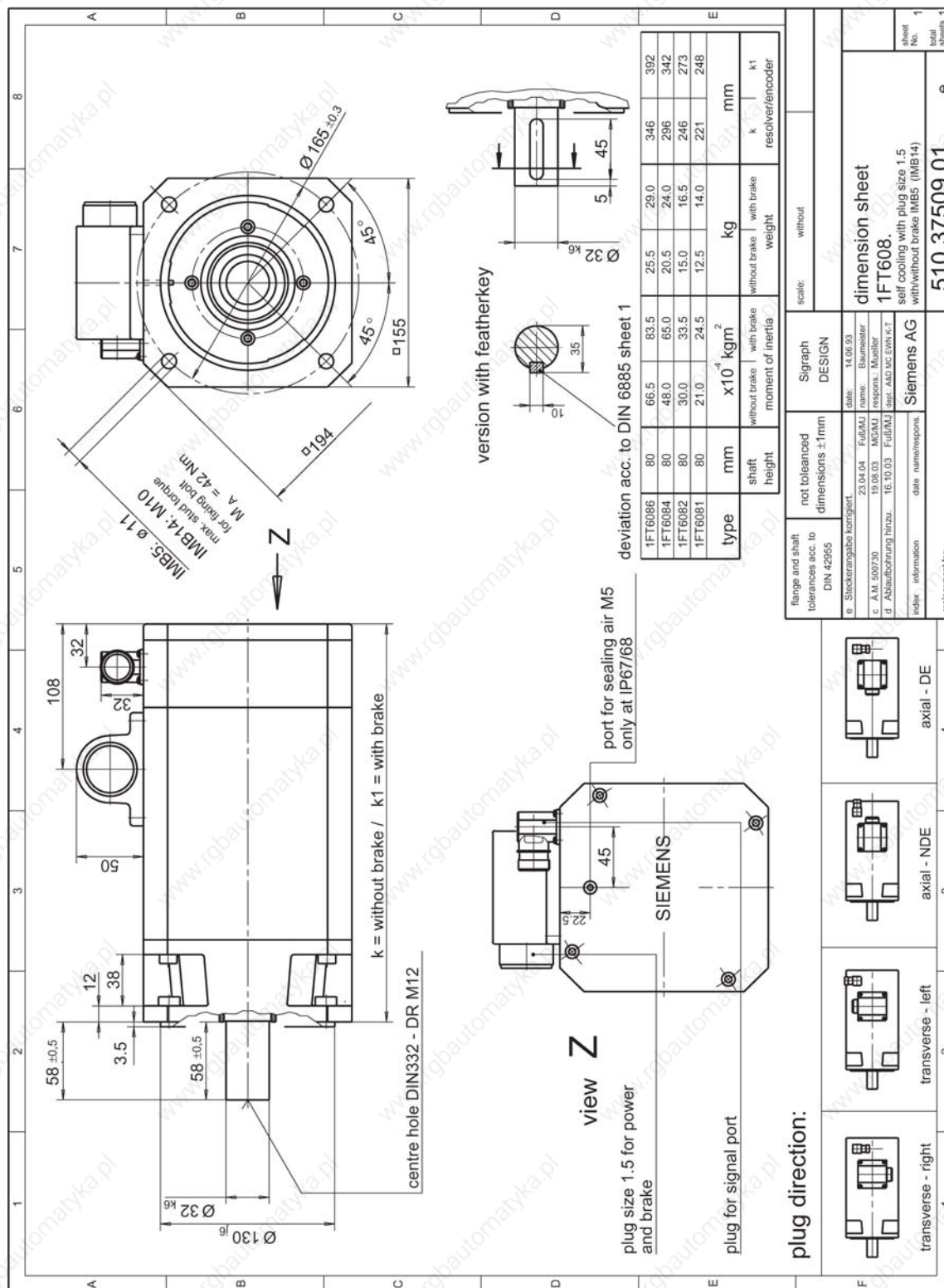

Figure 5-21 1FT608□ non-ventilated with connector, Size 1.5

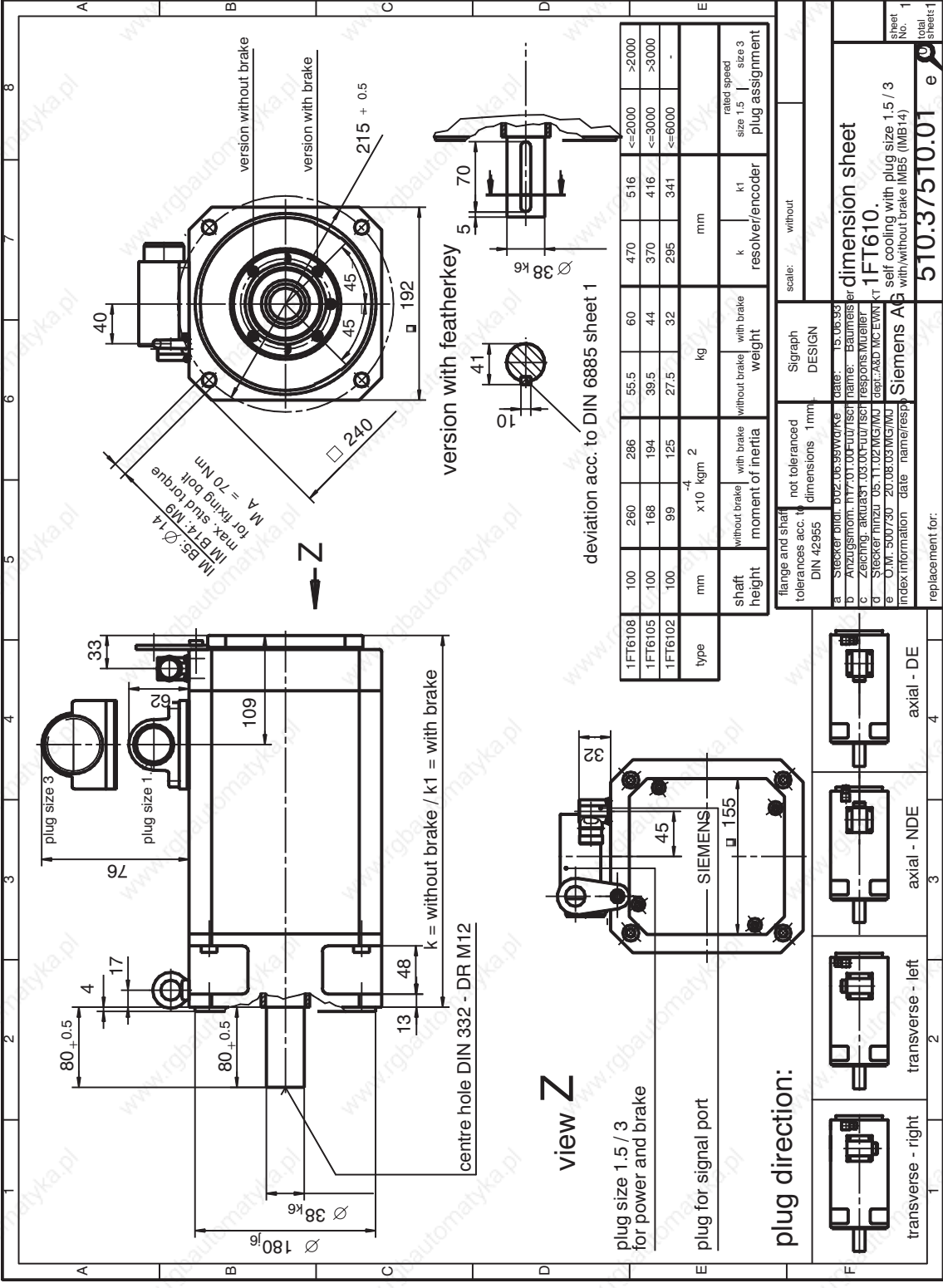

Figure 5-22 1FT610□ non-ventilated with connector, Size 1.5

5.3 1FT6 without DRIVE-CLiQ

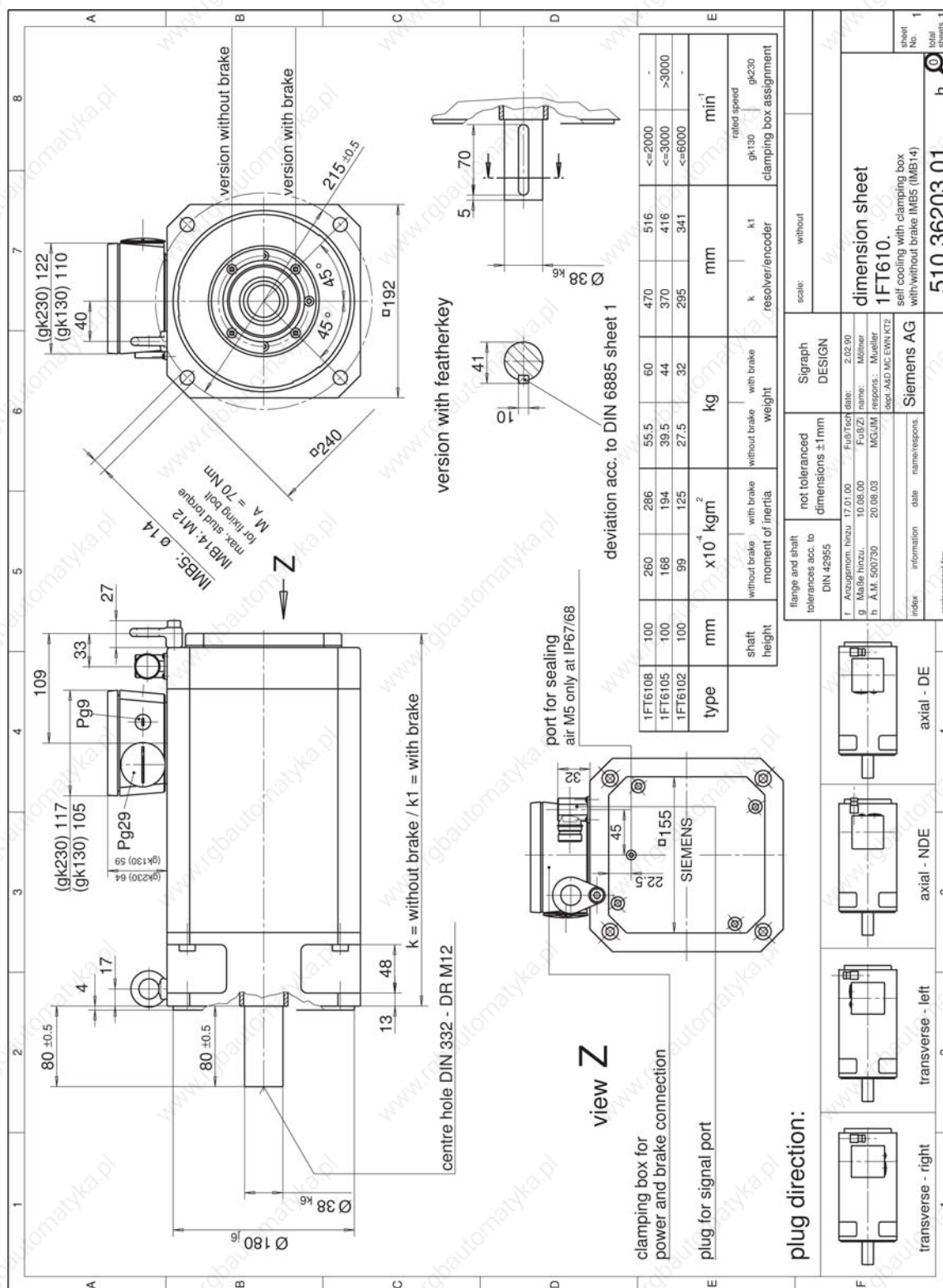

Figure 5-23 1FT610□ non-ventilated with terminal box



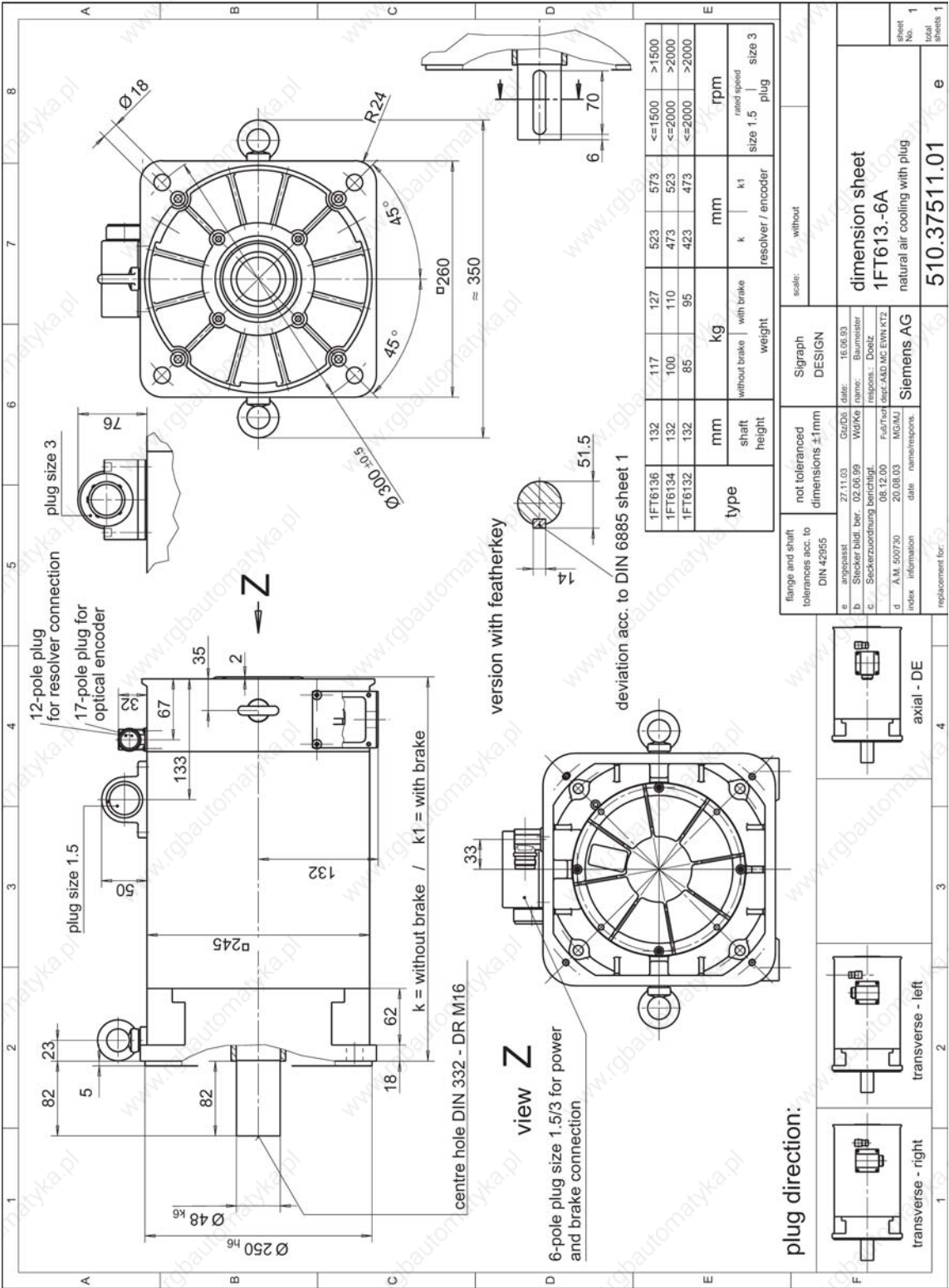

Figure 5-24 1FT613□ non-ventilated with connector, Size 1.5/3

5.3 1FT6 without DRIVE-CLiQ

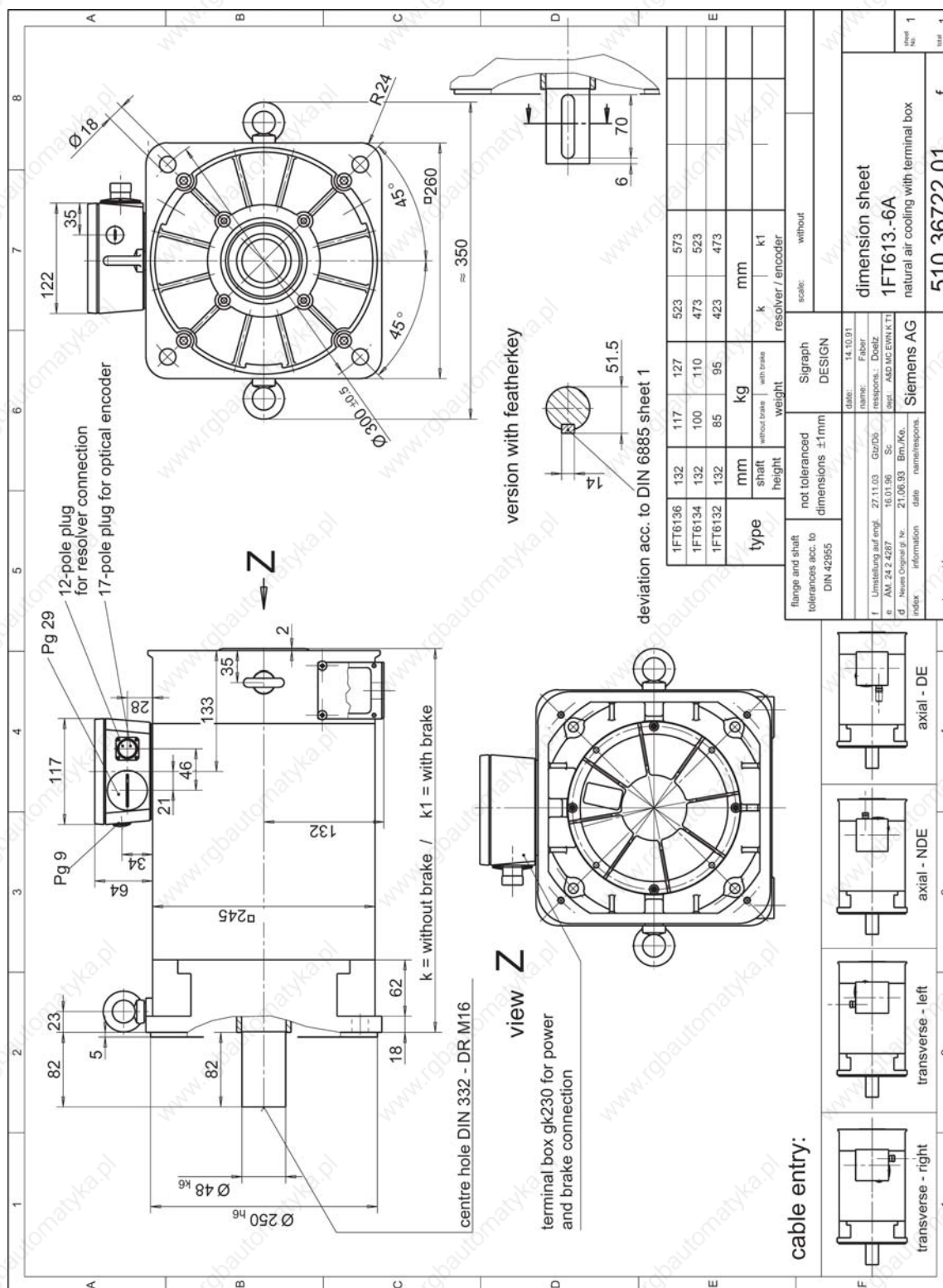

Figure 5-25 1FT613□ non-ventilated with terminal box



5.3.2 Force-ventilated 1FT6 motors

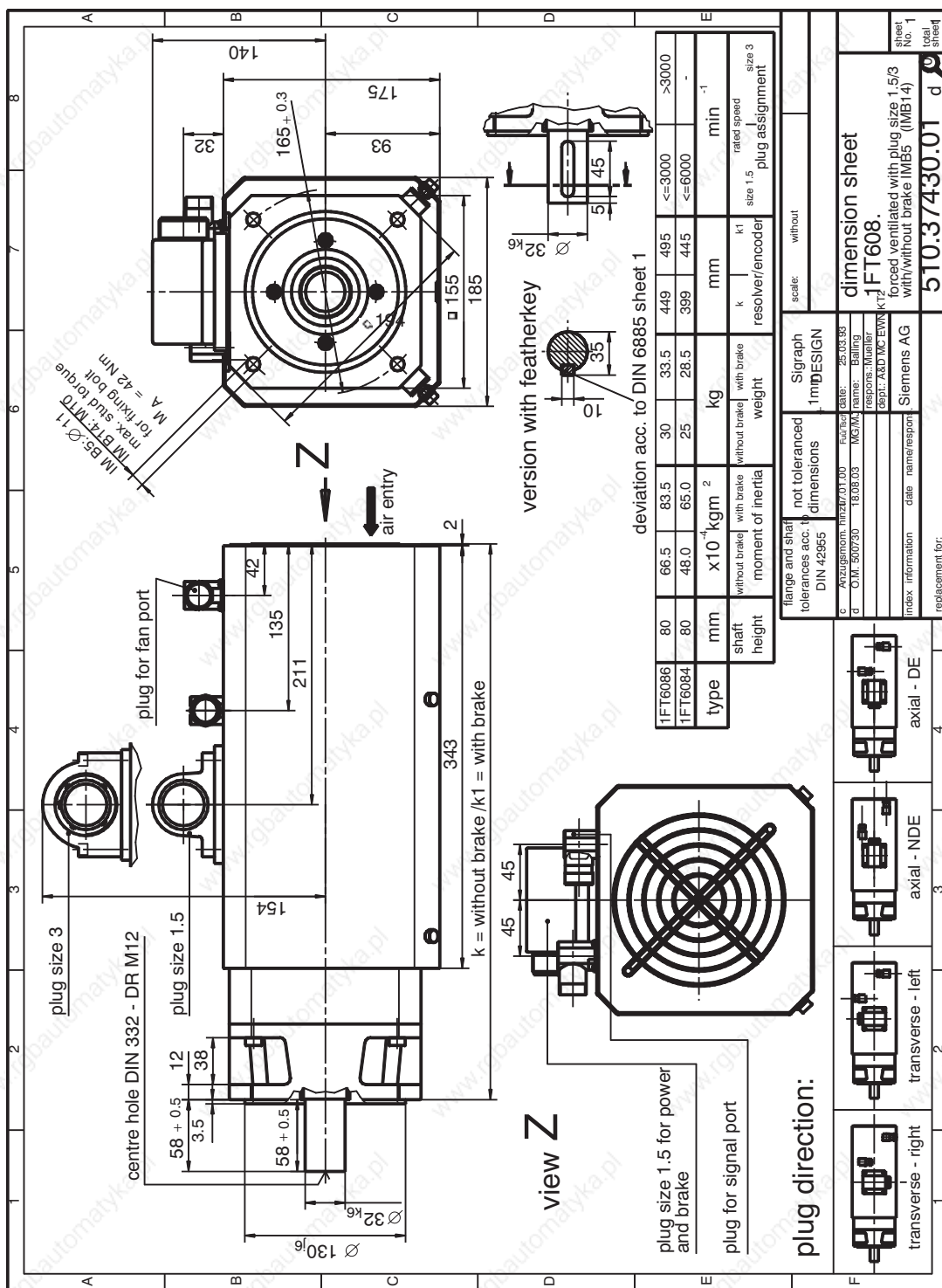

Figure 5-27 1FT608 force-ventilated with connector, Size 1.5/3



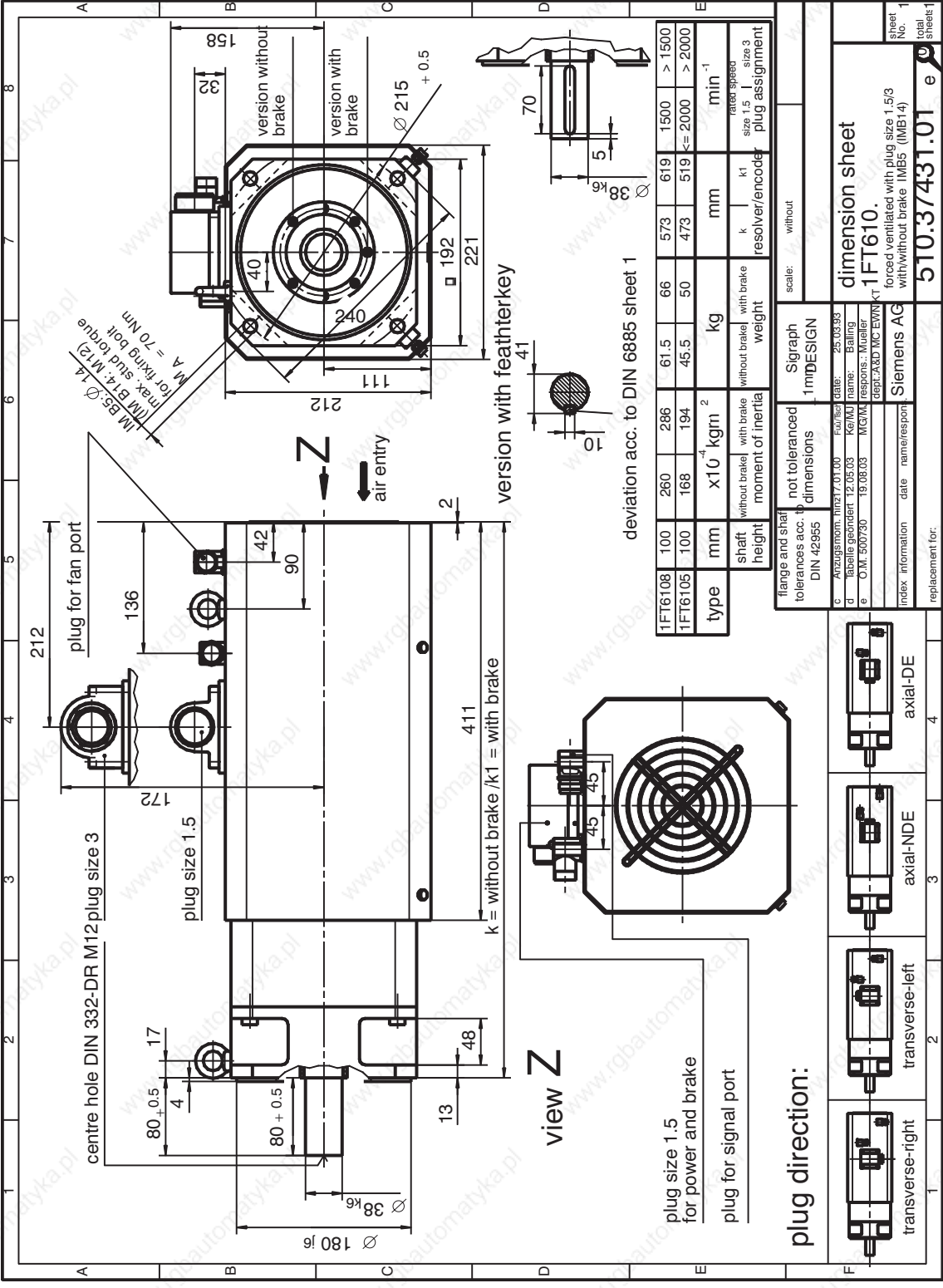

Figure 5-28 1FT610 force-ventilated with connector, Size 1.5/3



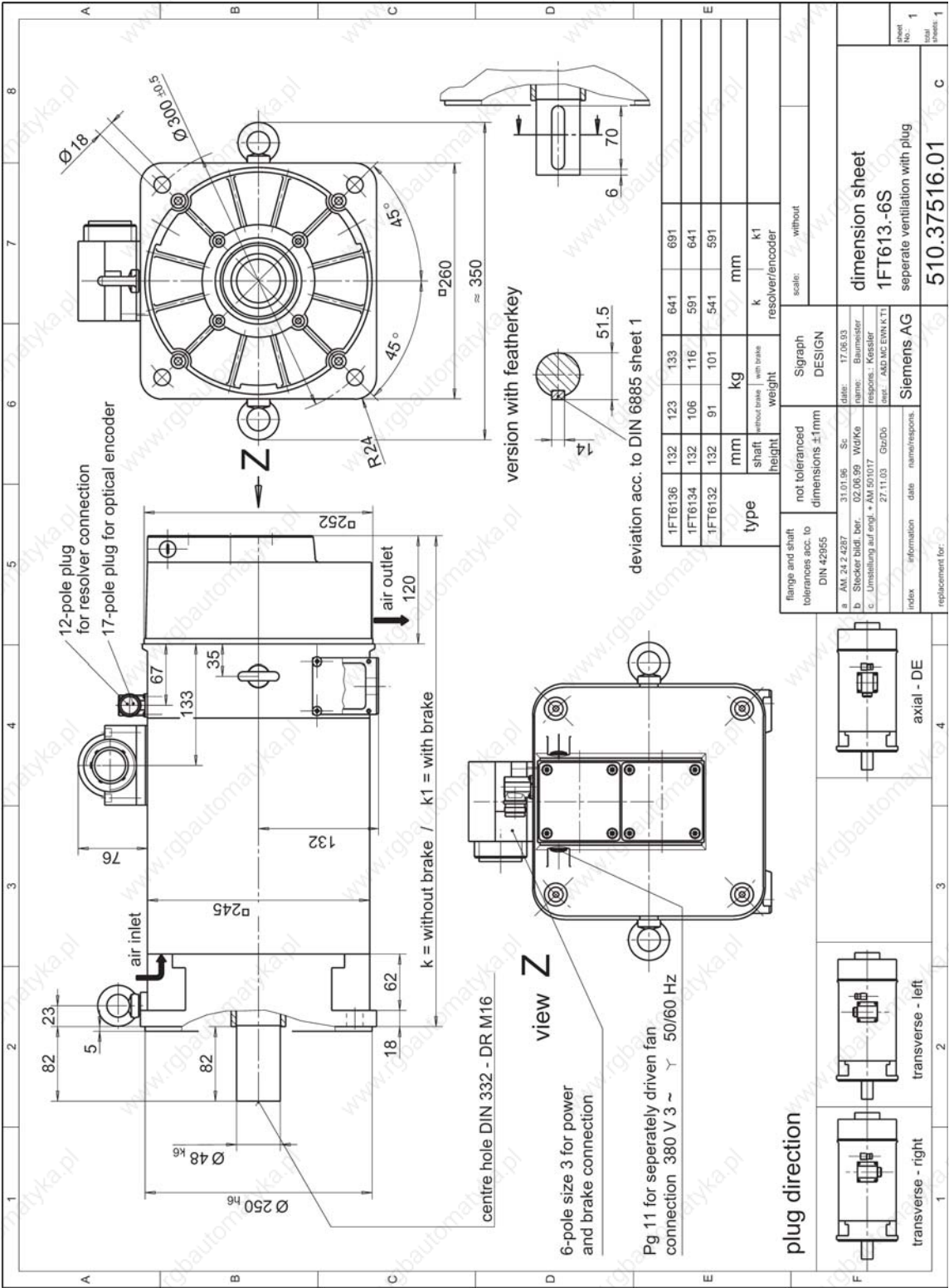

Figure 5-30 1FT613 force-ventilated with connector

Dimension Drawings

5.3 1FT6 without DRIVE-CLiQ

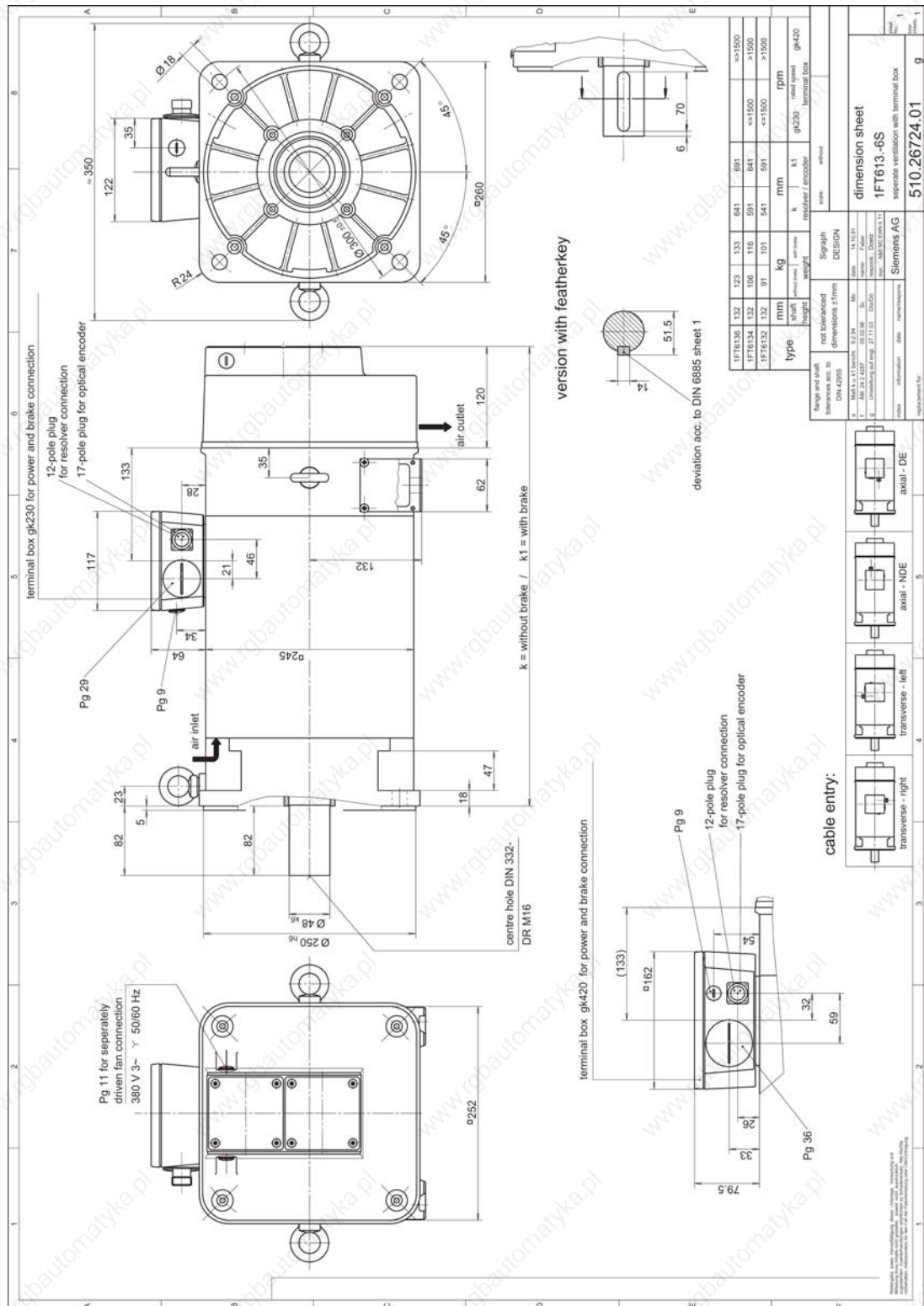

Figure 5-31 1FT613 force-ventilated with terminal box





5.3.3 Water-cooled 1FT6 motors

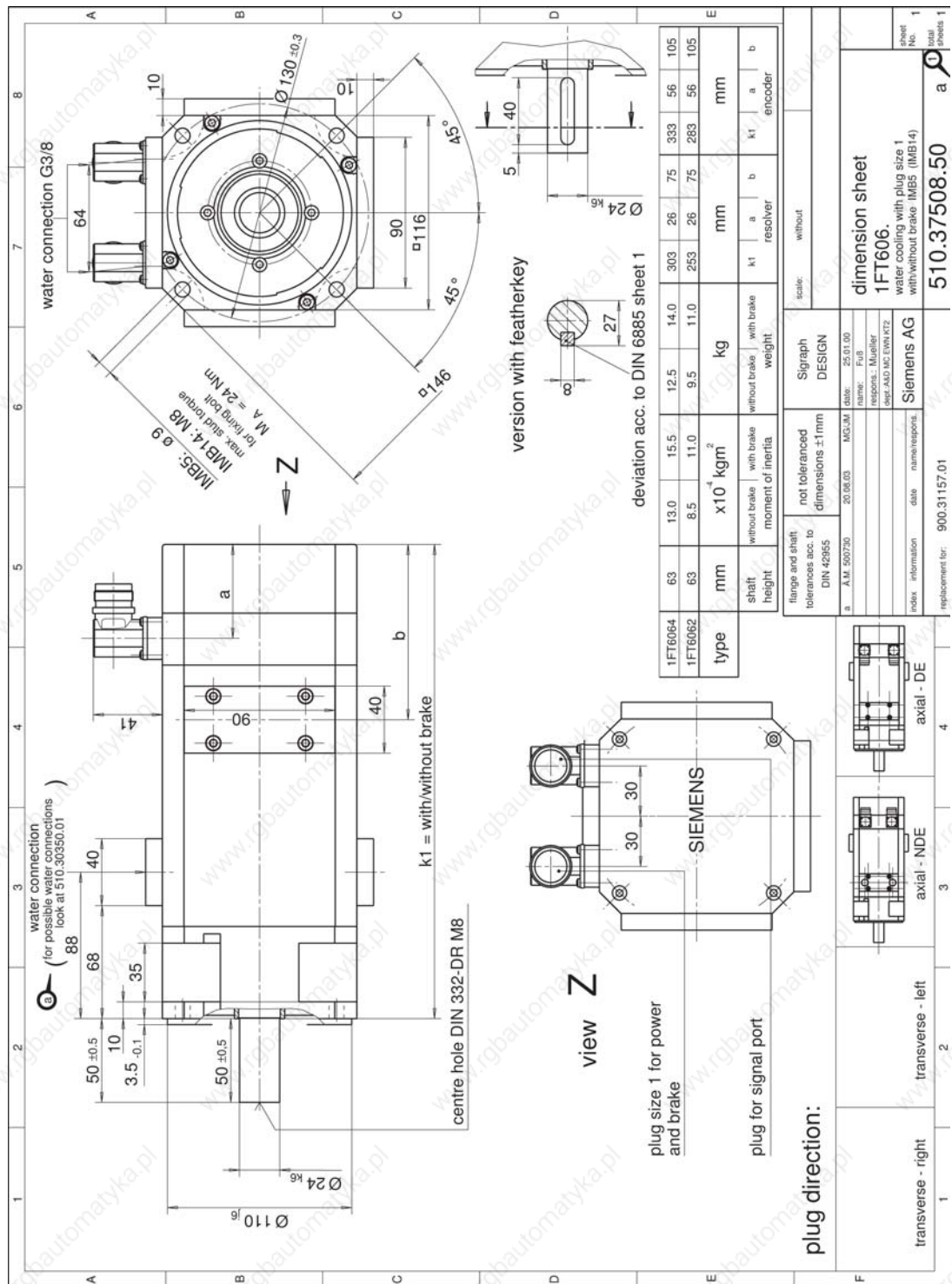

Figure 5-33 1FT606□ water-cooled with connector, Size 1

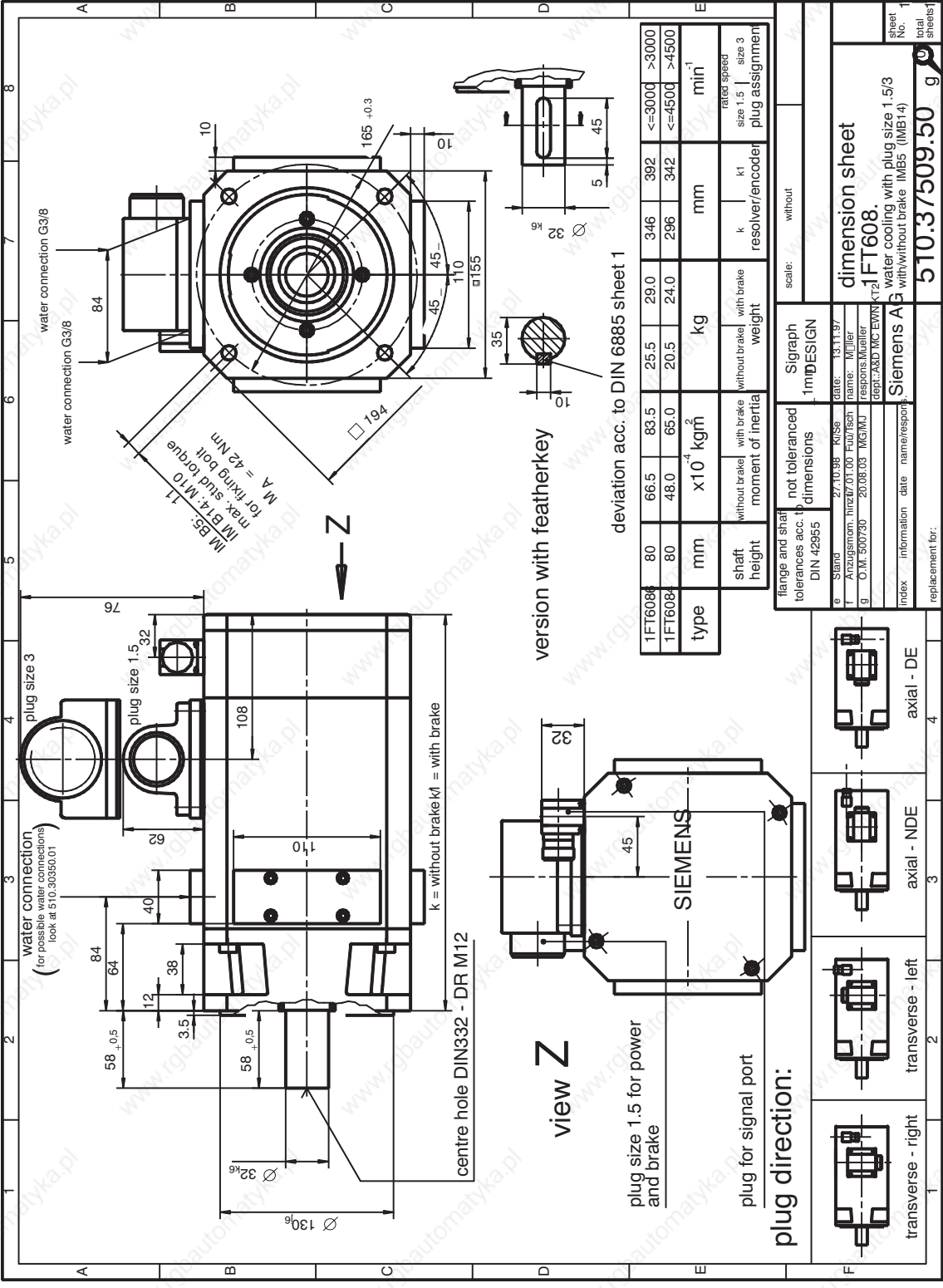

Figure 5-34 1FT608□ water-cooled with connector, Size 1.5/3







Dimension Drawings

5.3 1FT6 without DRIVE-CLiQ

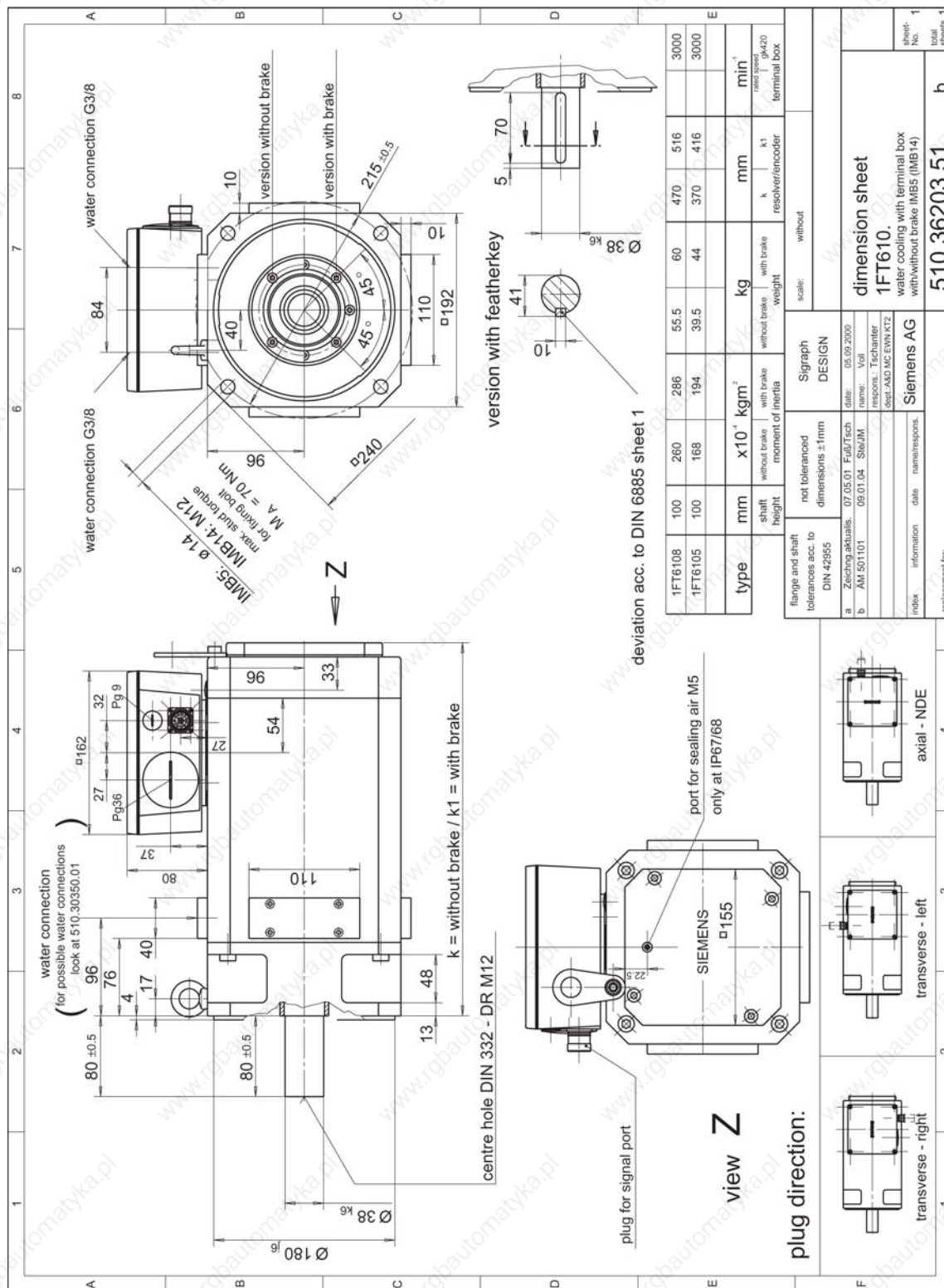

Figure 5-37 1FT610 water cooling with terminal box, rated speed = 3000 RPM

Dimension Drawings  
5.3 1FT6 without DRIVE-CLiQ

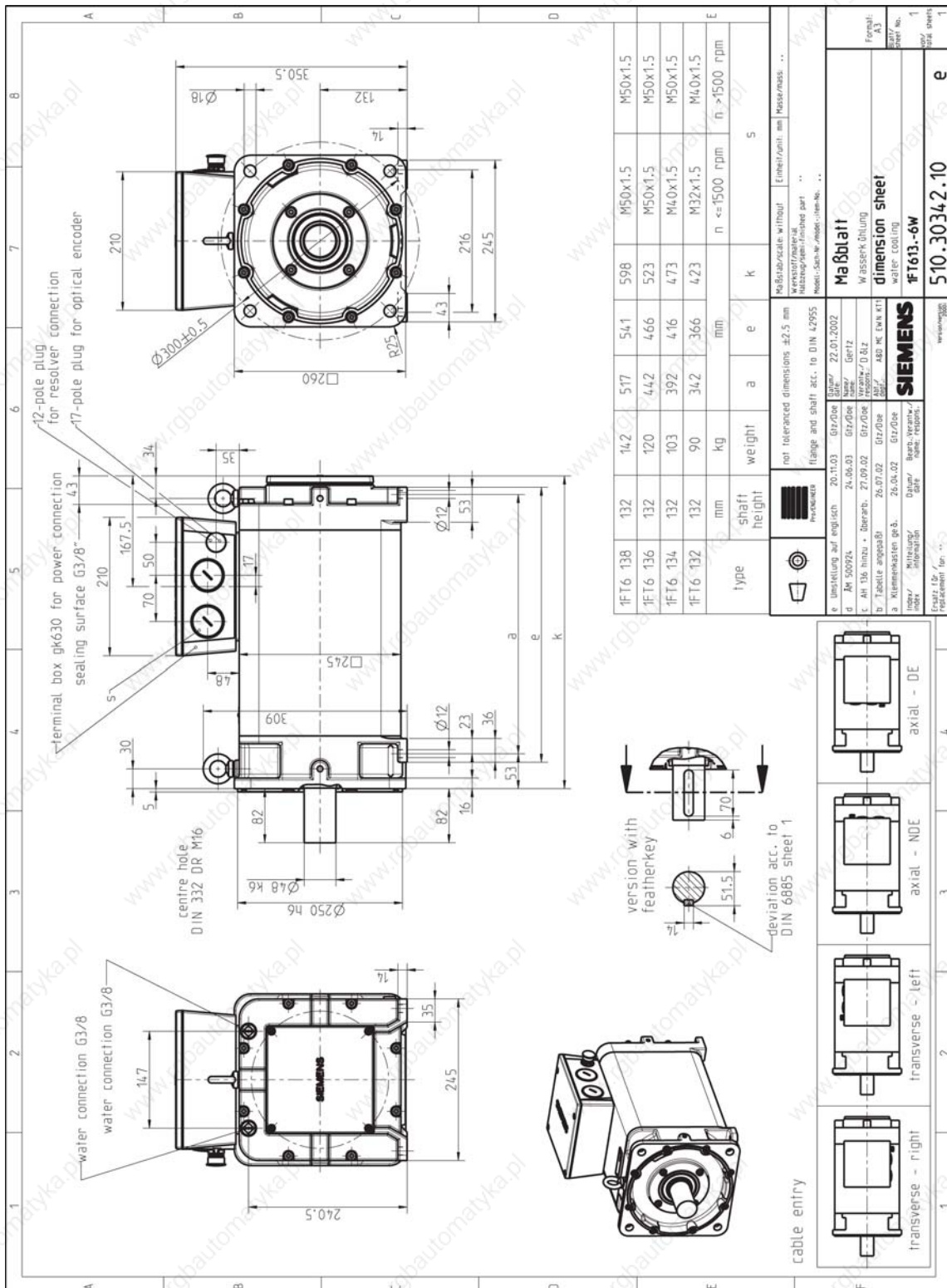

Figure 5-38 1FT613□ water-cooled with terminal box

5.3 1FT6 without DRIVE-CLiQ

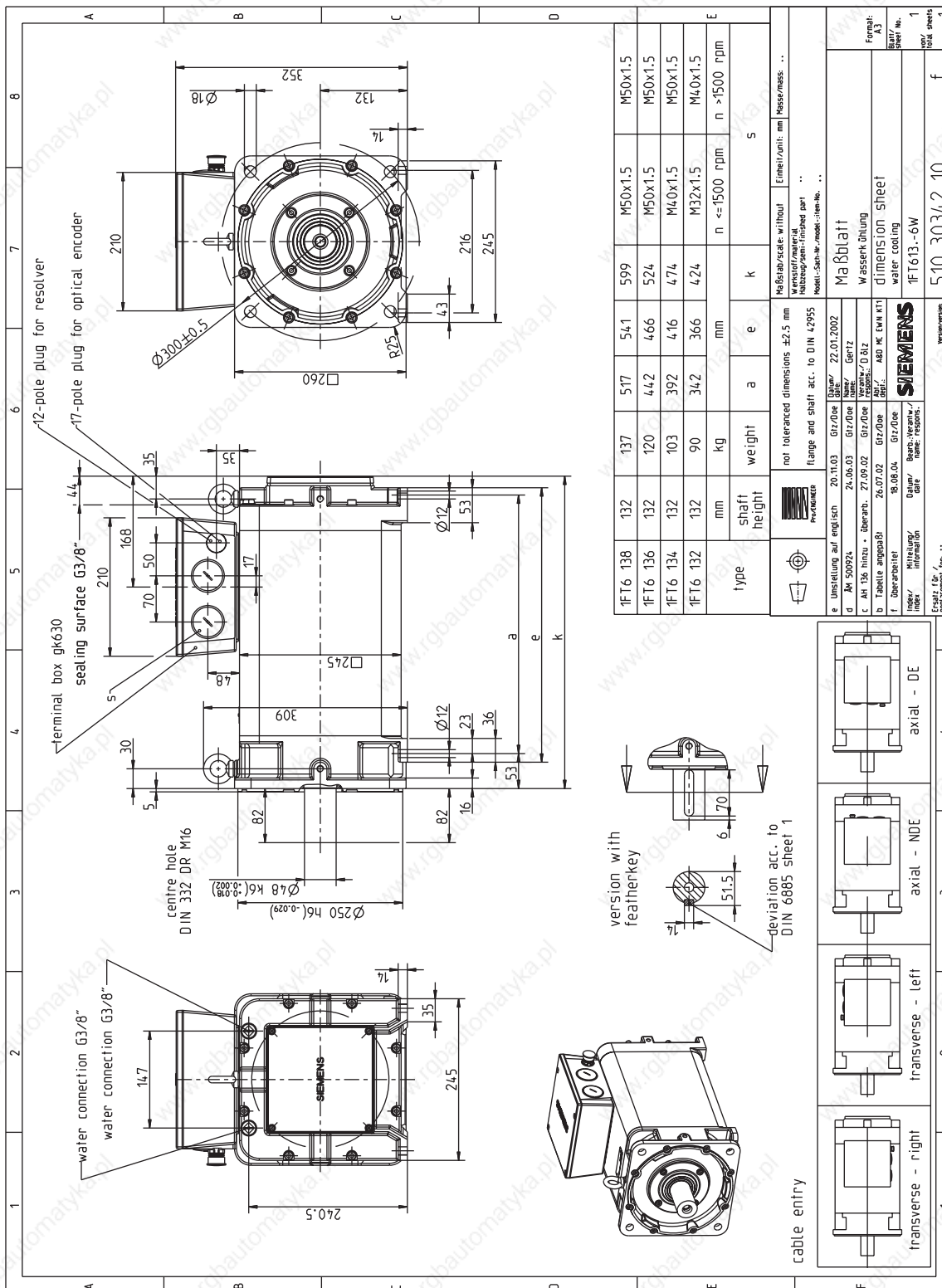

Figure 5-39 1FT613x-6Wx76-5xxx



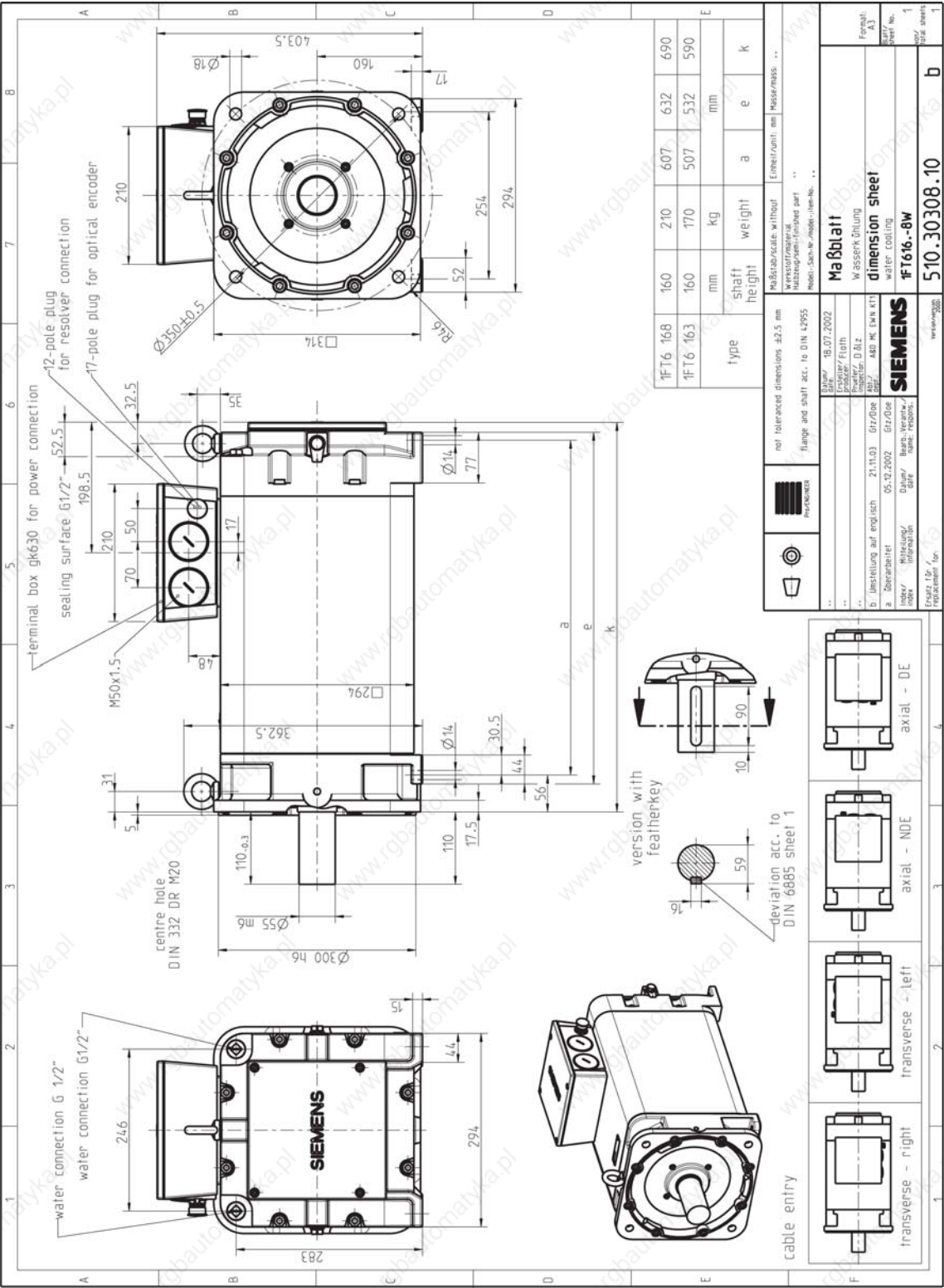

Figure 5-40 1FT616□ water-cooled with terminal box



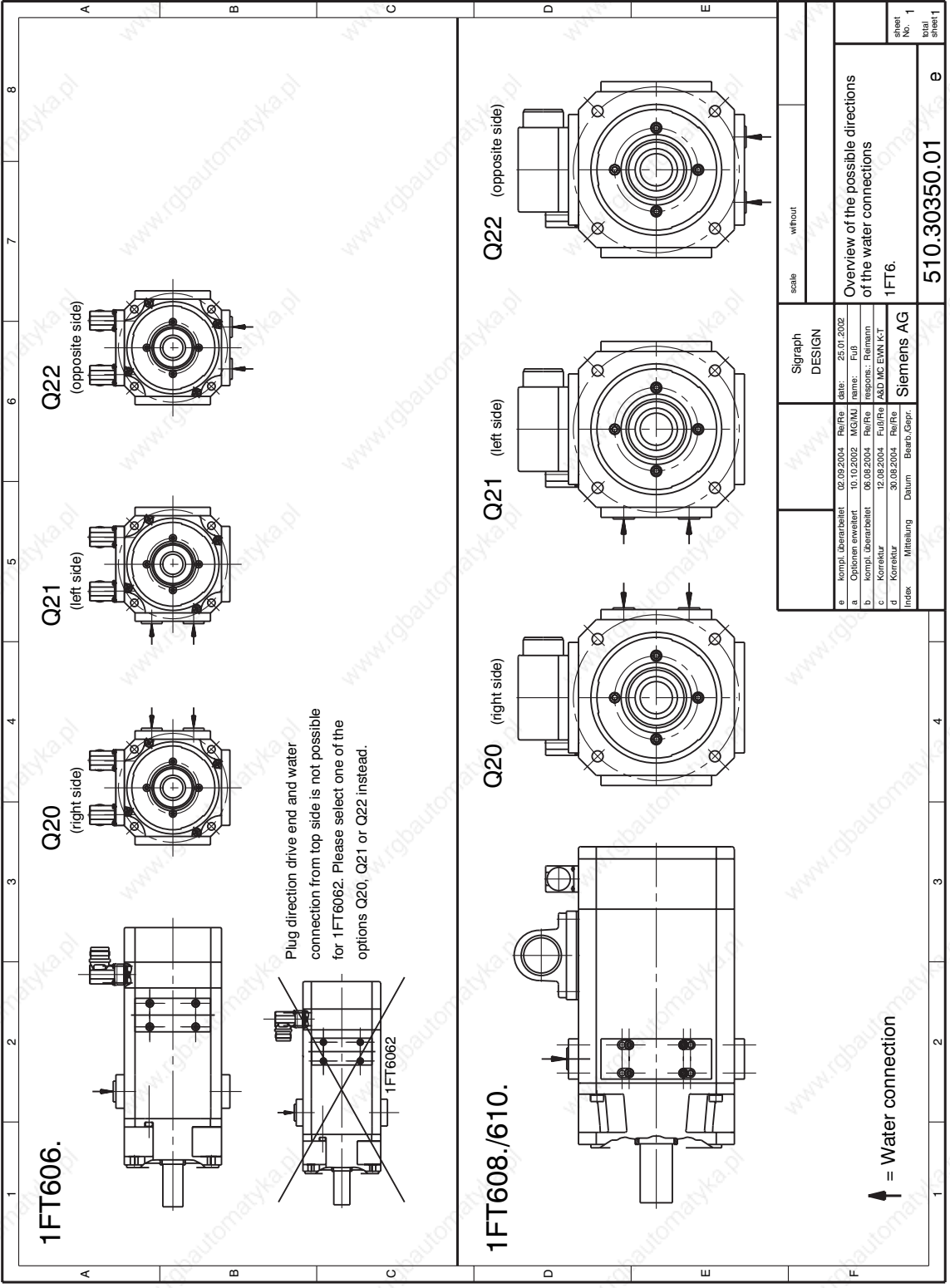

Figure 5-42 1FT6\_cooling connections



## Appendix

### A.1 References

An overview of publications that is updated monthly is provided in a number of languages in the Internet at:

<<http://www.siemens.com/motioncontrol>>  
through "Support", "Technical Documentation", "Documentation Overview"

#### General Documentation

<b>/D 21.2/</b>	<b>SINAMICS S120 Catalog</b> SINAMICS S120 Servo Control Drive System
<b>/NC 60/</b>	<b>SINUMERIK and SIMODRIVE Catalog</b> Automation Systems for Machine Tools
<b>/DA65.3/</b>	<b>SIMOVERT MASTERDRIVES Catalog</b> Synchronous and Induction Motors for SIMOVERT MASTERDRIVES

#### Electronic Documentation

<b>/CD1/</b>	<b>DOC ON CD</b> The SINUMERIK System (includes all SINUMERIK 840D/810D and SIMODRIVE 611D)
<b>/CD2/</b>	<b>DOC ON CD</b> The SINAMICS System

## Manufacturer/Service Documentation

<b>/PJAL/</b>	<b>Configuration Manual, Synchronous Motors</b> SINAMICS S120, SIMODRIVE 611, SIMOVERT MASTERDRIVES Synchronous Motors, General Section
<b>/PFK7S/</b>	<b>Configuration Manual, Synchronous Motors</b> SINAMICS S120 1FK7 Synchronous Motors
<b>/PFT6S/</b>	<b>Configuration Manual, Synchronous Motors</b> SINAMICS S120 1FT6 Synchronous Motors
<b>/PMH2/</b>	<b>Installation Manual, Hollow Shaft Measuring System</b> SINAMICS S120, SIMODRIVE 611, SIMOVERT MASTERDRIVES, SIMAG H2 Hollow-Shaft Measuring System
<b>/PFK7/</b>	<b>Configuration Manual, Synchronous Motors</b> SIMODRIVE 611, SIMOVERT MASTERDRIVES 1FK7 Synchronous Motors
<b>/PFT6/</b>	<b>Configuration Manual, Synchronous Motors</b> SIMODRIVE 611, SIMOVERT MASTERDRIVES 1FT6 Synchronous Motors
<b>/PFK6/</b>	<b>Configuration Manual, Synchronous Motors</b> SIMODRIVE 611, SIMOVERT MASTERDRIVES 1FK6 Synchronous Motors
<b>/PFS6/</b>	<b>Configuration Manual, Synchronous Motors</b> SIMOVERT MASTERDRIVES 1FS6 Synchronous Motors, Explosion-Protected
<b>/PFU/</b>	<b>Configuration Manual, Synchronous Motors</b> SINAMICS S120, SIMOVERT MASTERDRIVES, MICROMASTER SIEMOSYN Synchronous Motors 1FU8

<b>/ASAL/</b>	<b>Configuration Manual, Induction Motors</b> SIMODRIVE 611, SIMOVERT MASTERDRIVES Induction Motors, General Section
<b>/APH2/</b>	<b>Configuration Manual, Induction Motors</b> SIMODRIVE 611 1PH2 Induction Motors
<b>/APH4/</b>	<b>Configuration Manual, Induction Motors</b> SIMODRIVE 611 1PH4 Induction Motors
<b>/APH7S/</b>	<b>Configuration Manual, Induction Motors</b> SIMODRIVE 611 1PH7 Induction Motors
<b>/PPM/</b>	<b>Configuration Manual, Hollow Shaft Motors</b> SIMODRIVE 611 Hollow Shaft Motors for Main Spindle Drives 1PM6 and 1PM4
<b>/PJFE/</b>	<b>Configuration Manual, Synchronous Build-in Motors</b> SIMODRIVE 611 Synchronous Motors for Main Spindle Drives 1FE1 Synchronous Build-in Motors
<b>/PJTM/</b>	<b>Configuration Manual, Build-in Torque Motors</b> SIMODRIVE 611 Build-in Torque Motors 1FW6
<b>/PJLM/</b>	<b>Configuration Manual, Linear Motors</b> SIMODRIVE 611 Linear Motors 1FN1 and 1FN3

**/PMS/**            **Configuration Manual, ECO Motor Spindle**  
SIMODRIVE 611  
ECO Motor Spindle 2SP1

**/APL6/**            **Configuration Manual, Induction Motors**  
SIMOVERT MASTERDRIVES  
Induction Motors 1PL6

**/APH7M/**        **Configuration Manual, Induction Motors**  
SIMOVERT MASTERDRIVES VC/MC  
Induction Motors 1PH7

**/PKTM/**           **Configuration Manual, Complete Torque Motors**  
SIMOVERT MASTERDRIVES  
Complete Torque Motors 1FW3



# Index

## A

Absolute value encoders, 4-7  
Additive, 1-25  
Armature short-circuit braking, 1-15  
Axial force stressing, 3-133

## B

Brake resistors, 1-15

## C

Cantilever force diagrams, 3-128  
Cantilever force stressing, 3-128  
Characteristics, 3-1  
Connector assignment  
    Brake, 2-2  
    Encoder, 2-2  
    Power, 2-2  
Cooling, 1-21  
Cooling medium, 1-24  
Cooling powers to be dissipated, 1-26  
Coupling output, 1-28

## D

Danger and warning information, v  
Dimension drawings, 5-1

## E

Encoders, 4-3  
ESDS instructions, vii

## G

Gearbox  
    1-stage, 4-13  
    2-stage, 4-18

## H

Holding brake, 4-12  
Hotline, iv

## I

Incremental encoders, 4-5  
Interfaces, 2-1

## O

Options, 1-4  
Order designation  
    Core types, 1-6  
    Standard types, 1-5

## R

Resistance characteristic, 4-2  
Resistor braking, 1-15  
    Force ventilated, 1-18  
    Non-ventilated, 1-15  
    Water cooling, 1-19  
Resolvers, 4-10

## S

Speed-torque diagrams  
    Force ventilated, 3-62  
    Non-ventilated, 3-2  
    Water cooling, 3-94  
Standard engineering, 1-1

## T

Technical data  
    nN 1500 RPM, 1-8  
    nN 2000 RPM, 1-10  
    nN 2500 RPM, 1-11  
    nN 3000 RPM, 1-12

## Index

---

nN 4500 RPM, 1-13  
nN 6000 RPM, 1-14  
Technical features, 1-3  
Temperature sensor, KTY 84, 4-1  
Thermal motor protection, 4-1

To  
SIEMENS AG  
A&D MC BMS  
Postfach 3180  
D-91050 Erlangen  
Tel.: +49 (0) 180 / 5050 - 222 (Service Support)  
Fax: +49 (0) 9131 / 98 - 2176 (Documentation)  
email: motioncontrol.docu@erlf.siemens.de

<b>From</b>	
Name	
Company/Department	
Address	
Postal code:	Town:
Telephone:	/
Telefax:	/

<b>Suggestions</b>
<b>Corrections</b>
For Publication/Manual:  Synchronous Motors 1FT6
Manufacturer/Service Documentation
Configuration Manual
Order No.: 6SN1197-0AD12-0BP0
Edition: 12.2004
If you come across any printing errors in this document, please let us know using this form. We would also be grateful for any suggestions and recommendations for improvement.

**Suggestions and/or corrections**





Siemens AG  
Automation & Drives  
Motion Control Systems  
Postfach 3180, D -91050 Erlangen  
Germany

[www.siemens.com/motioncontrol](http://www.siemens.com/motioncontrol)

© Siemens AG 2004  
Subject to change without prior notice  
Order No.: 6SN1197-0AD12-0BP0

Printed in the Federal Republic of Germany