

Perfection in Automation



ACOPOS

USER'S MANUAL

(V1)

Version: **1.0 (February 2002)**
Mod. No.: **MAACP1-E**

We reserve the right to change the contents of this manual without warning. The information contained herein is believed to be accurate as of the date of publication, however, Bernecker + Rainer Industrie-Elektronik Ges.m.b.H. makes no warranty, expressed or implied, with regards to the products or the documentation contained within this book. Bernecker + Rainer Industrie-Elektronik Ges.m.b.H. shall not be liable in the event of incidental or consequential damages in connection with or arising from the furnishing, performance or use of these products. The software names, hardware names and trademarks used in this document are registered by the respective companies.



CHAPTER 1: GENERAL INFORMATION

CHAPTER 2: TECHNICAL DATA

CHAPTER 3: INSTALLATION

CHAPTER 4: DIMENSIONING

CHAPTER 5: WIRING

CHAPTER 6: GETTING STARTED



CHAPTER 7: STANDARDS AND CERTIFICATIONS

INDEX



Chapter 1: General Information	13
1. ACOPOS Servo Family	13
1.1 Secure Operation	13
1.2 Taking it to the Limit	14
1.3 Individual I/O Configurations	14
1.4 Configuring Instead of Programming	15
1.5 Easy Service	15
1.6 Software and Hardware as a Unit	16
1.7 Plain Text for Functions	16
1.8 Simple Function Test	17
1.9 Control Trigger	18
1.10 Cam Profiles for Everyone	19
2. ACOPOS Configurations	20
2.1 CAN	20
2.1.1 Configuration 1	20
2.1.2 Configuration 2	21
3. Safety Guidelines	22
3.1 General Information	22
3.2 Intended Use	22
3.3 Transport and Storage	22
3.4 Installation	23
3.5 Operating	23
3.5.1 Protection against Touching Electrical Parts	23
3.5.2 Protection from Dangerous Movements	24
3.6 Safety Notices	25
Chapter 2: Technical Data	27
1. ACOPOS Servo Family	27
1.1 Modular Servo Drive Concept	27
1.2 General Description	28
1.3 Status LEDs	29
1.3.1 LED Status	30
1.4 ACOPOS 1022, 1045 and 1090	31
1.4.1 Order Data	31
1.4.2 Technical Data	31
1.5 ACOPOS 1640, 128M	33
1.5.1 Order Data	33
1.5.2 Technical Data	33
2. ACOPOS plug-in modules	35
2.1 General Information	35
2.2 Module Overview	35
2.3 AC110 - CAN Interface	36
2.3.1 General Description	36
2.3.2 Order Data	36

Table of Contents

2.3.3 Technical Data	36
2.3.4 CAN Node Number Settings	37
2.3.5 Indications	37
2.4 AC120 - EnDat Encoder Interface	38
2.4.1 General Description	38
2.4.2 Order Data	39
2.4.3 Technical Data	40
2.5 AC122 - Resolver Interface	41
2.5.1 General Description	41
2.5.2 Order Data	42
2.5.3 Technical Data	42
2.6 AC123 - Incremental Encoder and SSI Absolute Encoder Interface	44
2.6.1 General Description	44
2.6.2 Order Data	44
2.6.3 Technical Data	45
2.7 AC130 - Digital Mixed Module	47
2.7.1 General Description	47
2.7.2 Order Data	47
2.7.3 Technical Data	47
3. Cables	51
3.1 General Information	51
3.1.1 Manufactured Cable	51
3.2 Motor Cables	52
3.2.1 Order Data	52
3.2.2 Cable Specification	54
3.3 EnDat Cable	57
3.3.1 Order Data	57
3.3.2 Cable Specification	57
3.4 Resolver Cable	59
3.4.1 Order Data	59
3.4.2 Cable Specification	60
4. Connectors	61
4.1 General Information	61
4.2 Motor Connectors	62
4.2.1 Order Data	62
4.2.2 Specifications for 8PM001.00-1 and 8PM002.00-1	63
4.2.3 Specifications for 8PM003.00-1	64
4.3 Encoder Connector	65
4.3.1 Order Data	65
4.3.2 Specifications for EnDat Connector 8PE001.00-1	66
4.3.3 Specifications for Resolver Connector 8PR001.00-1	67

Chapter 3: Installation	69
1. General Information	69
2. Dimensional Diagram and Installation Dimensions	71
2.1 ACOPOS 1022, 1045, 1090	71
2.2 ACOPOS 1640	72
2.3 ACOPOS 128M	73
3. Installation and Removal of Plug-in Modules	74
3.1 General Information	74
3.1.1 Installation	74
3.1.2 Removal	75
4. Installing Various ACOPOS Series Devices Directly Next to Each Other	76
5. Using Cooling Aggregates in Switching Cabinets	78
Chapter 4: Dimensioning	81
1. Power Mains Connection	81
1.1 General Information	81
1.1.1 System Configuration	81
1.1.2 Supply Voltage Range	81
1.1.3 Protective Ground Connection (PE)	82
1.2 Dimensioning	83
1.2.1 Individual ACOPOS Power Mains Connections	83
1.2.2 Implementing ACOPOS Power Mains Connections for Drive Groups	86
1.3 Fault Current Protection	87
1.3.1 Rated Fault Current	87
1.3.2 Estimating the Discharge Current	88
1.3.3 Manufacturer Used	88
2. DC Bus	89
2.1 General Information	89
2.2 Wiring	90
2.3 Equal Distribution of the Applied Power via the Power Rectifiers	91
2.4 Equal Distribution of the Brake Power on the Braking Resistors	91
3. Motor Connection	92
4. Braking Resistor	94
4.1 General Information	94
4.2 Braking Resistor Connection	95
4.3 Dimensioning the Brake Resistor	96
4.4 Setting Brake Resistor Parameters	99
5. Current Consumption of ACOPOS Plug-in Modules	100
6. Formula Variables Used	101

Chapter 5: Wiring	103
1. General Information	103
1.1 Electromagnetic Compatibility of the Installation	103
1.1.1 General Information	103
1.1.2 Installation Notes	104
1.2 Overview of the Terminal Cross Sections	107
2. Connections ACOPOS 1022, 1045, 1090	108
2.1 Pin Assignments for Plug X1	109
2.2 Pin Assignments for Plug X2	109
2.3 Pin Assignments for Plug X3	110
2.4 Pin Assignments for Plug X4	110
2.5 Pin Assignments for Plug X5	110
2.6 Protective Ground Connection (PE)	111
3. Connections ACOPOS 1640, 128M	112
3.1 Pin Assignments for Plug X1	113
3.2 Pin Assignments for X2	113
3.3 Pin Assignments for X3	114
3.4 Pin Assignments for Plug X4	114
3.5 Pin assignments for X5	115
3.6 Pin Assignments for X6	115
4. Plug-in Module Connections	116
4.1 AC110 - CAN Interface	116
4.1.1 Pin Assignments	116
4.2 AC120 - EnDat Encoder Interface	117
4.2.1 Pin Assignments	117
4.3 AC122 - Resolver Interface	118
4.3.1 Pin Assignments	118
4.4 AC123 - Incremental Encoder and SSI Absolute Encoder Interface	119
4.4.1 Pin Assignments	119
4.5 AC130 - Digital Mixed Module	120
4.5.1 Pin Assignments	120
4.6 Connecting Cables to Plug-in Modules	121
5. Cables	122
5.1 Motor Cable	122
5.1.1 Motor Cable Construction	122
5.1.2 Pin Assignments 8CMxxx.12-1, 8CMxxx.12-3	123
5.1.3 Cable Schematic for 8CMxxx.12-1, 8CMxxx.12-3	123
5.1.4 Pin Assignments for 8CMxxx.12-5	124
5.1.5 Cable Schematic for 8CMxxx.12-5	124
5.2 EnDat Encoder Cables	125
5.2.1 EnDat Encoder Cable Construction	125
5.2.2 Pin Assignments	125
5.2.3 Cable Schematic	126
5.3 Resolver Cables	127
5.3.1 Resolver Cable Construction	127
5.3.2 Pin Assignments	127
5.3.3 Cable Schematic	128

Chapter 6: Getting Started	129
1. Preparation	129
1.1 Unpacking the ACOPOS Servo Drive	129
1.2 Installing and Connecting the ACOPOS Servo Drive	129
1.3 Connecting the ACOPOS Servo Drive with a B&R PLC	129
2. Starting Up an ACOPOS Servo Drive	130
2.1 General Information	130
2.1.1 Sample Project	131
2.1.2 Preparing the Hardware for Sample Project acp10.gdm	131
2.2 Start-up	131
2.2.1 Load Sample Project	131
2.2.2 Preset Values for the Sample Project	134
2.2.3 Preset Values Concerning Wiring	140
2.2.4 Downloading the Project	146
2.2.5 Test Function	148
2.2.6 Starting the Motor Movement	150
 Chapter 7: Standards and Certifications	 159
1. Valid European Guidelines for ACOPOS Servo Drives	159
2. Valid Standards for ACOPOS Servo Drives	159
3. Electrical Limit Values for Immunity Tests according to IEC 61800-3	160
4. Electrical Limit Values for Emission Tests according to IEC 61800-3	161
5. Environmental Limit Values according to IEC 61800-2	162
6. International Certifications	163

CHAPTER 1 • GENERAL INFORMATION

1. ACOPOS Servo Family

With the introduction of the ACOPOS product line - consisting of servo drive and motor components - B&R has provided the basis for complete and uniform automation solutions. Branch specific functions and intuitive tools allow for short development times and create more room for innovation.

1.1 Secure Operation

The embedded parameter chip on the motor is one factor used to guarantee maximum security. It contains all mechanical and electronic data relevant to the functionality of the motor. Parameters no longer have to be set manually and start-up times are substantially reduced. Secure operation also means that relevant data can be requested during service and the cause of the problem can be determined.

EMC was given special attention in order to guarantee proper operation in an industrial environment. Field tests have been carried out under difficult conditions in addition to the tests defined in the standard. The results confirm the excellent values measured by the testing laboratory and during operation. The filter required to meet the CE guidelines is also integrated in the device. This simplifies installation considerably.



Figure 1: Secure Operation

1.2 Taking it to the Limit

Operational security is also improved by monitoring high temperature components (IGBT modules, brake resistor, motor windings). Models with computer support allow component temperatures which cannot be measured directly to be calculated. One example is the junction temperature. This is a decisive value for the maximum load of a semiconductor. Using these models, a sufficiently precise value can be determined for each IGBT. Hot spots can be ruled out and the full dynamic properties of the device can be used at low rpm values and when stalled. The brake resistor and motor windings are monitored in the same way.

This form of monitoring allows better use of absolute limits on the drive and provides the user with the advantages of higher performance at lower costs.

1.3 Individual I/O Configurations

The I/O points needed to operate a servo axis are part of the standard equipment for ACOPOS drives. The user is provided two trigger inputs for tasks requiring precise measurements or print mark control. Sensor and actuator configurations are made using modular plug-in modules. This modular concept allows the optimum configuration to be selected to meet the requirements of the application.



Figure 2: Individual I/O Configurations

1.4 Configuring Instead of Programming

Long-term cooperation with our customers has provided us with fundamental knowledge in many positioning application areas. This knowledge can be passed on to our customers in the form of clear and easy to use function blocks. Industry specific functionality can be quickly and easily implemented in an application program.

1.5 Easy Service

All necessary data is placed in application memory on the controller so that service is limited to simply exchanging the device. The program does not have to be changed. After the system is started again, the controller automatically (or when requested by the user) installs the operating system used on the system. After this procedure is complete, the parameters are sent to the servo drive again. Problems resulting from different software versions or parameters can be ruled out.

1.6 Software and Hardware as a Unit

B&R integrates all relevant technologies in one tool - B&R Automation Studio™.

Adding a B&R ACOPOS servo drive is done in a Windows Look & Feel environment which becomes routine after using the program a few times. Wizards and selection boxes ease configuration of servo axis parameters. The target system is shown in a clear tree structure. Detailed information concerning the target system, with integrated hardware documentation ranging from software to terminal assignments, reduces project development times considerably.

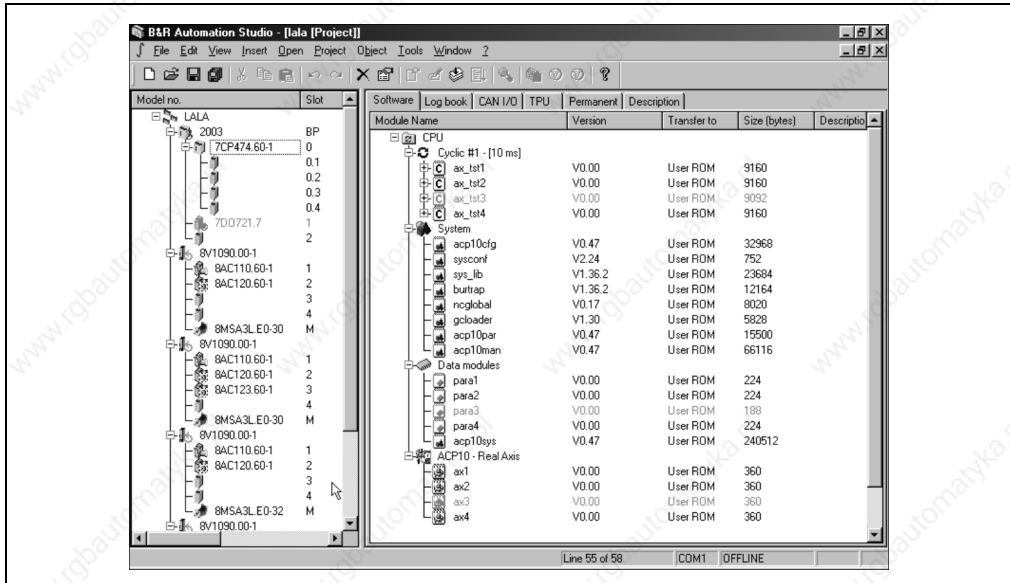

Figure 3: Software and Hardware as a Unit

1.7 Plain Text for Functions

NC Objects that can be accessed by the application program are also stored on the CPU (like the application program).

Creating NC Objects (for axes, a CNC system or a cam profile) takes place using dialog boxes and special data module editors. The individual hardware and software channels are assigned symbolic names. This eases use and increases clarity. The initial parameters are set in a separate editor in plain text.

1.8 Simple Function Test

The built-in NC test allows an axis to be used without a line of program code being written. As seen in the picture, several editors are grouped together as a single window. All movements, ranging from point-to-point movements to gear functions, can be carried out using an NC Action. The reaction of the axis can be seen online in the monitor window. If the trace function is turned on, relevant data - from position to motor temperature - is recorded on the drive. The multiple curve display in the trace window allows simple evaluation of the movement results.

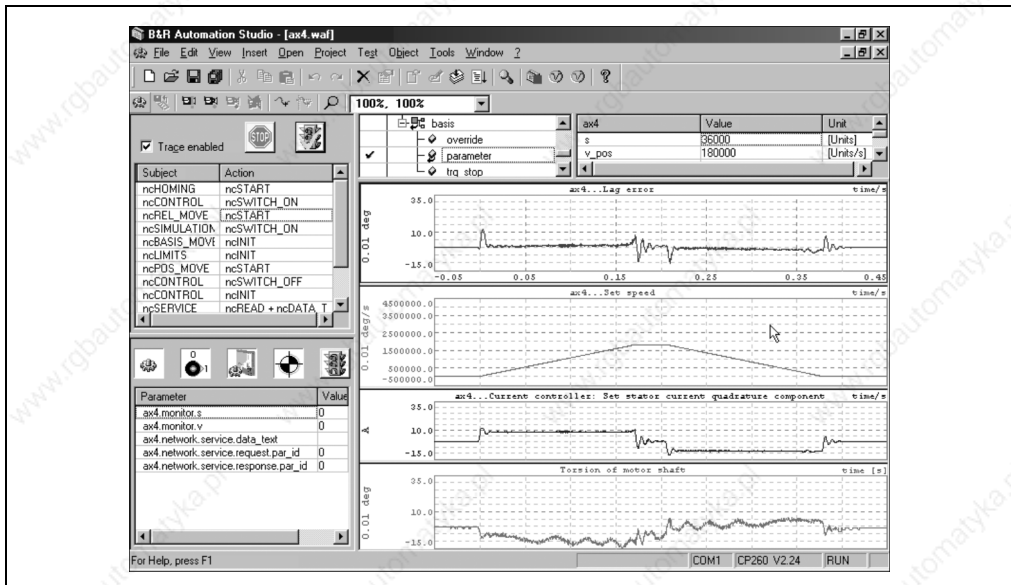

Figure 4: Simple Function Test

1.9 Control Trigger

The oscilloscope in the drive allows movements to be monitored in real time. Many trigger possibilities allow data required for analysis to be easily obtained. The graphic display of diagnosis data supports the user when making fine adjustments and when optimizing the movement. Measurement cursor and reference points allow μ s precision.

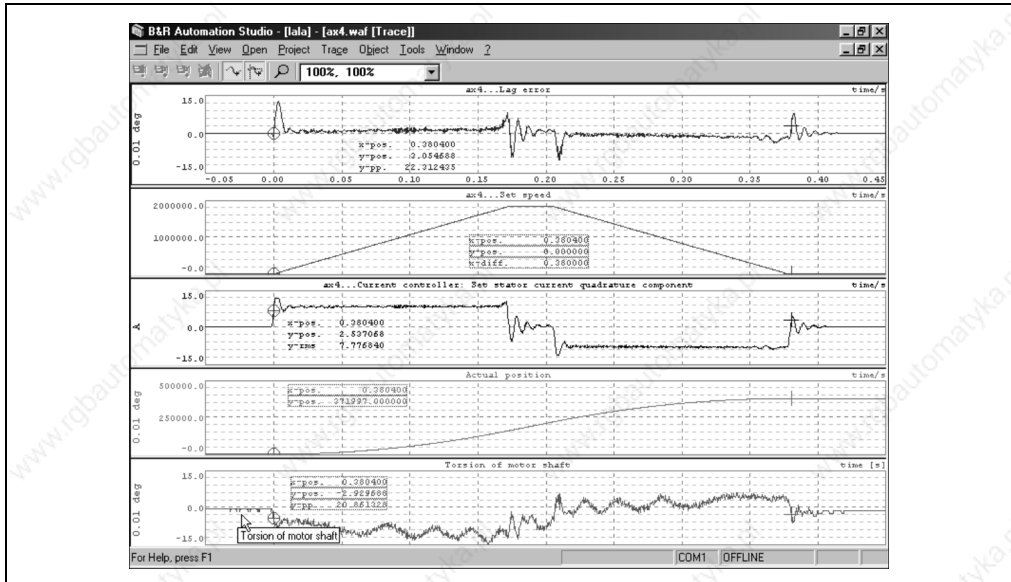

Figure 5: Control Trigger

1.10 Cam Profiles for Everyone

Modular technology plug-ins allow homogenous integration of high performance tools such as the Cam Editor.

The mouse is used to define fixed points, synchronous sections or interpolations. Effects of positioning behavior on speed, acceleration and jolt for the slaves axes connected can be monitored directly.

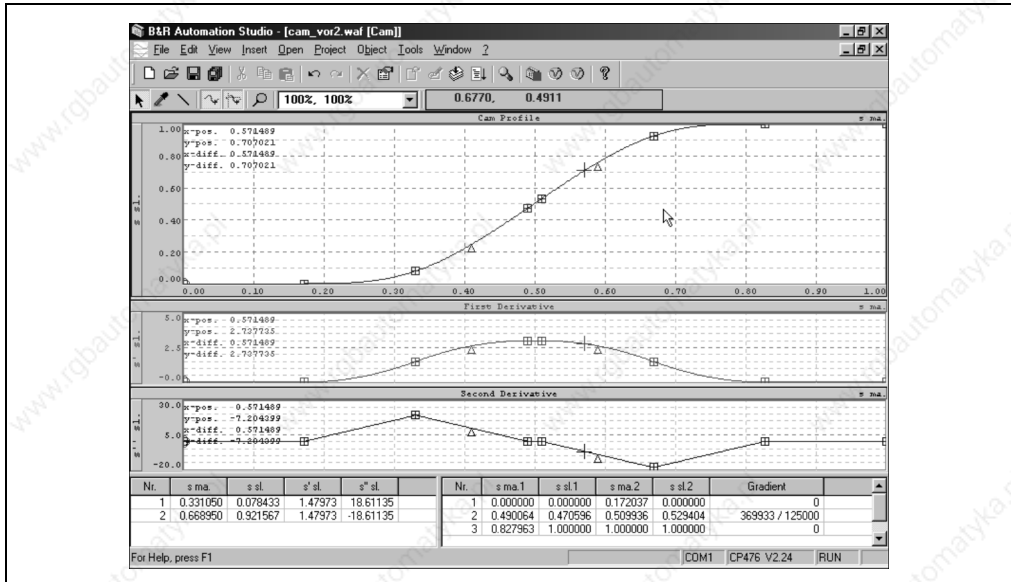

Figure 6: Cam Profiles for Everyone

2. ACOPOS Configurations

2.1 CAN

2.1.1 Configuration 1

Functionality

The following ACOPOS functions are possible with this configuration:

- Point-to-Point
- Electronic Gears
- Electronic Compensation Gears
- Cross Cutter
- Electronic Cam Profiles
- Flying Saw
- Line Shaft

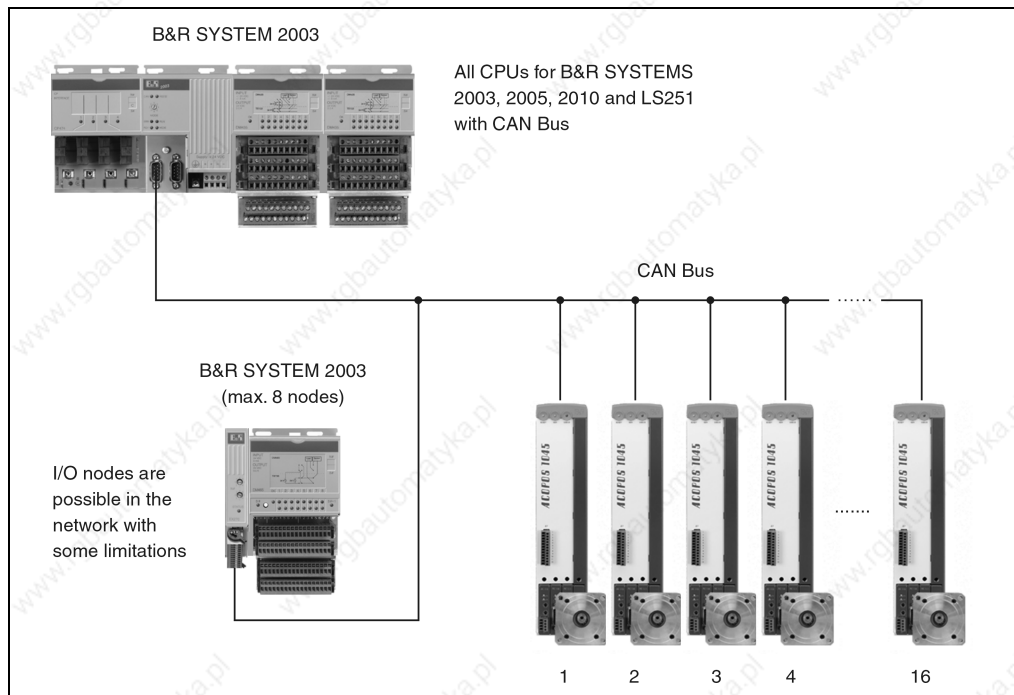

Figure 7: CAN Configuration 1

2.1.2 Configuration 2

Functionality

The following ACOPOS functions are possible with this configuration:

- Point-to-Point
- Electronic Gears
- Electronic Compensation Gears
- Cross Cutter
- Electronic Cam Profiles
- Flying Saw
- Line Shaft
- CNC

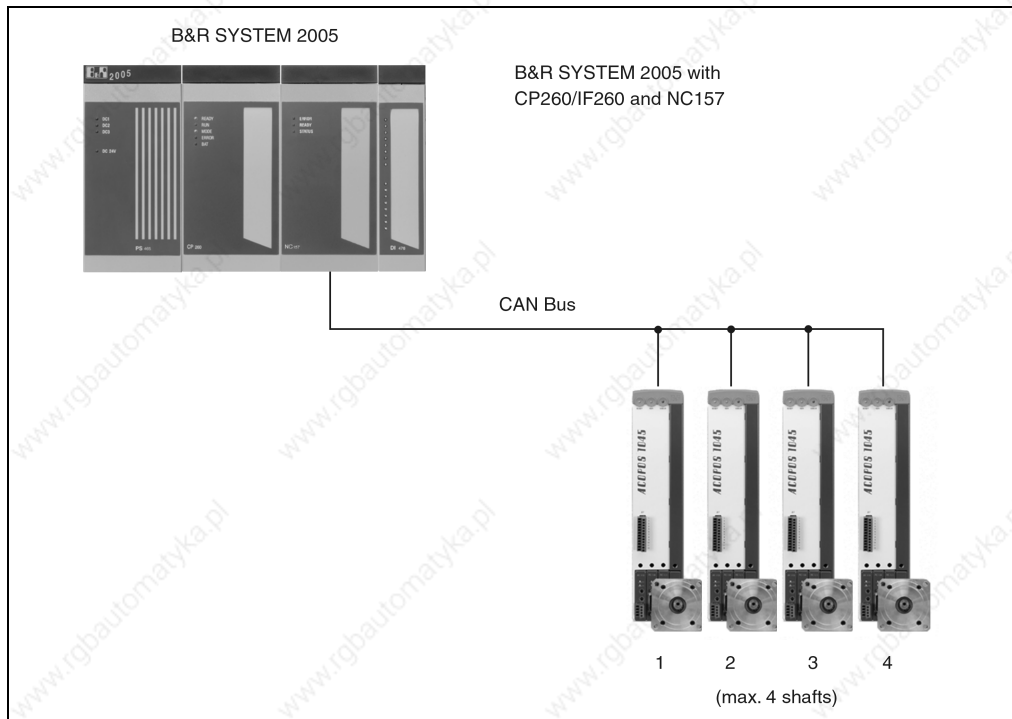

Figure 8: CAN Configuration 2

3. Safety Guidelines

3.1 General Information

Danger!

Servo drives and servo motors can have bare parts with voltages applied (e.g. terminals) or hot surfaces. Additional sources of danger result from moving machine parts. Improperly removing the required covers, inappropriate use, incorrect installation or incorrect operation can result in severe personal injury or damage to property.

All tasks, such as transport, installation, commissioning and service, are only allowed to be carried out by qualified personnel. Qualified personnel are persons familiar with transport, mounting, installation, commissioning and operation of the product and have the respective qualifications (e.g. IEC 60364). Be sure to follow national accident prevention guidelines.

The safety guidelines, connection descriptions (type plate and documentation) and limit values listed in the technical data are to be read carefully before installation and commissioning and must be observed.

Danger!

Handling servo drives incorrectly can cause severe personal injury or damage to property!

3.2 Intended Use

Servo drives are components designed to be installed in electrical systems or machines. They are not being used as intended unless the machine meets EG regulation 98/37/EG (machine regulation) as well as regulation 89/336/EEG (EMC regulation).

The servo drives are only allowed to be operated directly on grounded, three-phase industrial mains (TN, TT power mains). When using the servo drives in living areas, shops and small businesses, additional filtering measures must be implemented by the user.

The technical data as well as the values for connection and environmental guidelines can be found on the type plate and in the documentation. The connection and environmental guidelines must be met.

Electronic devices are generally not fail-safe. If the servo drive fails, the user is responsible for making sure that the motor is placed in a secure state.

3.3 Transport and Storage

During transport and storage, the devices must be protected from excessive stress (mechanical load, temperature, humidity, aggressive atmosphere).

Servo drives contain components sensitive to electrostatic charges which can be damaged by inappropriate handling. During installation/removal of servo drives, provide the necessary safety precautions against electrostatic discharges.

3.4 Installation

The installation must take place according to the documentation using suitable equipment and tools.

The devices are only allowed to be installed without voltage applied and by qualified personnel. Voltage to the switching cabinet should be switched off and prevented from being switched on again.

The general safety regulations and national accident prevention guidelines (e.g. VBG 4) must be observed when working with high voltage systems.

The electrical installation must be carried out according to the relevant guidelines (e.g. line cross section, fuse, protective ground connection, also see chapter 4 "Dimensioning").

3.5 Operation

3.5.1 Protection against Touching Electrical Parts

Danger!

To operate servo drives, it is necessary that certain parts are carrying voltages over 42 VDC. A life-threatening electrical shock could occur if you touch these parts. This could result in death, severe injury or material damage.

Before turning on the servo drive, make sure that the housing is properly connected to protective ground (PE rail). The ground connection must be made, even when testing the servo drive or when operating it for a short time!

Before turning the device on, make sure that all voltage carrying parts are securely covered. During operation, all covers and switching cabinet doors must remain closed.

Control and high power contacts can have voltage applied, even when the motor is not turning. Touching the contacts when the device is switched on is not permitted.

Before working on servo drives, they must be disconnected from the power mains and prevented from being switched on again.

Danger!

After switching off the device, wait until the DC bus discharge time of at least five minutes has passed. The voltage currently on the DC bus must be measured with a suitable measuring device before beginning work. This voltage must be less than 42 V DC to rule out danger. The Run LED going out does not indicate that voltage is not present on the device!

The connections for the signal voltages (5 to 30 V) found on the servo drives are isolated circuits. Therefore, the signal voltage connections and interfaces are only allowed to be connected to devices or electrical components with sufficient isolation according to IEC 60364-4-41 or EN 50178.

Never remove the electrical connections from the servo drive with voltage applied. In unfavorable conditions, arcs can occur causing personal injury and damage to contacts.

3.5.2 Protection from Dangerous Movements

Danger!

Incorrect control of motors can cause unwanted and dangerous movements! Such incorrect behavior can have various causes:

- **Incorrect installation or an error when handling the components**
- **Incorrect or incomplete wiring**
- **Defective devices (servo drive, motor, position encoder, cable, brake)**
- **Incorrect control (e.g. caused by software error)**

Some of these causes can be recognized and prevented by the servo drive using internal monitoring. However, it is generally possible for the motor shaft to move every time the device is switched on! Therefore protection of personnel and the machine can only be guaranteed using higher level safety precautions.

The movement area of machines is must be protected to prevent accidental access. This type of protection can be obtained by using stabile mechanical protection such as protective covers, protective fences, protective gates or photocells.

Removing, bridging or bypassing these safety features and entering the movement area is prohibited.

A sufficient number of emergency stop switches are to be installed directly next to the machine. The emergency stop equipment must be checked before commissioning the machine.

Remove shaft keys on free running motors or prevent them from being catapulted.

The holding brake built into the motors cannot prevent hoists from allowing the load to sink.

3.6 Safety Notices

Safety notices are organized as follows:

Safety Notice	Description
Danger!	Disregarding the safety regulations and guidelines can be life-threatening.
Warning!	Disregarding the safety regulations and guidelines can result in severe injury or heavy damage to material.
Caution!	Disregarding the safety regulations and guidelines can result in injury or damage to material.
Information:	Important information used to prevent errors.

Table 1: Description of the safety notices used in this manual

CHAPTER 2 • TECHNICAL DATA

1. ACOPOS Servo Family

1.1 Modular Servo Drive Concept

Controlling your power transmission system with the new B&R ACOPOS servo drives allows you to fully use the advantages of an optimized system architecture. Applications that require additional positioning tasks such as torque limitation or torque control can be created quickly and elegantly.

The flexible system concept for B&R servo drives is achieved using matched hardware and software components. You can select the optimal system configuration for your application and increase your competitiveness.

- Perfect integration in the B&R 2000 product family
- Object-oriented axis programming minimizes development time and increases reusability
- Integrated technology functions for branch specific tasks
- Operation of synchronous and asynchronous motors possible
- Input voltage range from 400 - 480 VAC ($\pm 10\%$) for use worldwide
- Four slots for plug-in modules
- Connection possibilities for all standard encoder systems
- Reduced commissioning and service times using “embedded motor parameter chip”
- Current regulator scan time up to 50 μs
- CAN fieldbus connection

1.2 General Description

The ACOPOS servo drive series covers a current range from 2.2 - 128 A and a power range from 1 - 64 kW with 5 devices in 2 groups. The devices in a group are designed using the same basic concept.

Group	8V1022.00-1 8V1045.00-1 8V1090.00-1	8V1640.00-1 8V128M.00-1
Power Connections	Plug connection	Fixed
Integrated Power Filter	Yes	... 1)
Mains Failure Monitoring	In preparation	Yes
DC Bus Connection	Yes	Yes
24 VDC Supply	External	External or internal via DC bus
24 VDC Output	No	24 V / 0.5 A
Integrated Brake Chopper	Yes	Yes
Internal Braking Resistor	Yes	Yes 2)
Connection of External Braking Resistor Possible	No	Yes
Monitored Output for Motor Holding Brake	Yes	Yes
Monitored Input for Motor Temperature Sensor	Yes	Yes

Table 2: General description of the ACOPOS servo drive series

1) Integrated line filter in preparation.

2) The braking resistor integrated in the ACOPOS servo drives 1640 and 128M is dimensioned so that it is possible to brake to a stop (in a typical drive situation).

The integrated power supply concept starting with the ACOPOS 1640 allows the 24 VDC voltage supply on the servo drive and the connected encoders and sensors (which can also be supplied via the 24 VDC output) to remain for the entire stopping procedure if there is a power failure. In many cases, it is not necessary to use a 24 VDC UPS which is otherwise needed.

In addition to connection possibilities for all standard encoder systems, the ACOPOS servo drives also provide a modular fieldbus interface.

ACOPOS servo drives are suitable for both synchronous and asynchronous servo motors and have a built-in line filter which meets the limit values for CISPR11, Group 2, Class A.

Caution!

ACOPOS servo drives are suitable for use on a circuit capable of delivering not more than 10000 RMS Symmetrical Amperes, 528 Volts maximum.

1.3 Status LEDs

The ACOPOS servo drives are equipped with three LEDs for direct diagnosis:

	LED	Designation	Color
	1	Ready	green
	2	Run	orange
	3	Error	red

Table 3: Status LEDs ACOPOS servo drives

If no LEDs are lit, the ACOPOS servo drive is not being supplied with 24 VDC.

Danger!

After switching off the device, wait until the DC bus discharge time of at least five minutes has passed. The voltage currently on the DC bus must be measured with a suitable measuring device before beginning work. This voltage must be less than 42 VDC to rule out danger. The Run LED going out does not indicate that voltage is not present on the device!

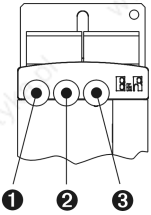
Signal	LED	Description
Ready	green	Lit when the ACOPOS servo drive is ready for operation and the power level can be enabled (operating system present and booted, no permanent or temporary errors).
Run	orange	Lit as soon as the power level is enabled for the ACOPOS servo drive.
Error	red	Lit when an error occurs on the ACOPOS servo drive. After correcting the error, the LED is automatically switched off. Examples of permanent errors: <ul style="list-style-type: none"> • Motor feedback not connected or defective • Low level on the enable input • Motor temperature sensor not connected or defective • Internal error on the device (e.g. IGBT heat sink temperature sensor defective) Examples of temporary errors: <ul style="list-style-type: none"> • 24 VDC supply voltage exceeds the tolerance range • DC bus voltage exceeds the tolerance range • Internal 15 VDC control voltage exceeds the tolerance range • IGBT current limit reached • Over-temperature on the motor (temperature sensor) • Over-temperature on the servo drive (IGBT junction, heat sink, conductive tracks) • Over-temperature on the braking resistor • CAN network faulty

Table 4: LED Status

1.3.1 LED Status

The following timing is used for the indication diagrams:

Block size: 125 ms

Repeats after: 2500 ms

Status changes when booting the operating system loader

Status	LED	Indication
1. Boot procedure for basic hardware active	green	[Grid]
	orange	[Grid]
	red	[Grid]
2. Configuration of CAN plug-in module active	green	[Grid]
	orange	[Grid]
	red	[Grid]
3. Waiting for CAN telegram	green	[Grid]
	orange	[Grid]
	red	[Grid]
4. CAN communication active	green	[Grid]
	orange	[Grid]
	red	[Grid]

Table 5: Status changes when booting the operating system loader

Error status with reference to the CAN plug-in module AC110

Status	LED	Indication
Boot error on CAN basic hardware	green	[Grid]
	orange	[Grid]
	red	[Grid]
Bus Off	green	[Grid]
	orange	[Grid]
	red	[Grid]
CAN node number is 0	green	[Grid]
	orange	[Grid]
	red	[Grid]

Table 6: Error status with reference to the CAN plug-in module AC110

1.4 ACOPOS 1022, 1045 and 1090

1.4.1 Order Data

Model Number	Short Description	Image
Servo Drives		
8V1022.00-1	Servo drive 3 x 400-480V 2.2A 1kW, line filter and braking resistor integrated	
8V1045.00-1	Servo drive 3 x 400-480V 4.4A 2kW, line filter and braking resistor integrated	
8V1090.00-1	Servo drive 3 x 400-480V 8.8A 4kW, line filter and braking resistor integrated	
Accessories		
8AC110.60-2	ACOPOS plug-in module, CAN interface	
8AC120.60-1	ACOPOS plug-in module, EnDat encoder interface	
8AC122.60-1	ACOPOS plug-in module, resolver interface	
8AC123.60-1	ACOPOS plug-in module, incremental encoder and SSI absolute encoder interface	
8AC130.60-1	ACOPOS plug-in module, 8 digital I/O configurable in pairs as 24V input or as output 400/100mA, 2 digital outputs 2A, Order TB712 terminal block separately	

Table 7: Order data ACOPOS 1022, 1045 and 1090

1.4.2 Technical Data

Product ID	8V1022.00-1	8V1045.00-1	8V1090.00-1
General Information			
C-UL-US Listed	Yes		
Power Mains Connection			
Mains Input Voltage	3 x 400 VAC to 480 VAC $\pm 10\%$ Power filter according to IEC 61800-3-A11 second environment (Limits from CISPR11, Group 2, Class A)		
Frequency	48 Hz to 62 Hz		
Installed Load	Max. 3 kVA	Max. 5 kVA	Max. 10 kVA
Starting Current	13 A	13 A	20 A
Switch-on Interval	>1 min		
Power Loss at Max. Device Power without Brake Resistor	120 W	180 W	200 W

Table 8: Technical data ACOPOS 1022, 1045 and 1090

Technical Data • ACOPOS Servo Family

Product ID	8V1022.00-1	8V1045.00-1	8V1090.00-1
24 VDC Supply			
Input Voltage with motor holding brake without motor holding brake	24 VDC +6 % / -2 % 24 VDC +30 % / -20 %		
Current Requirements	Max. 2.5 A + current for motor holding brake		
Motor Connection			
Maximum Switching Frequency	20 kHz	20 kHz	10 kHz
Continuous Current at 400 V	2.2 A _{eff}	4.4 A _{eff}	8.8 A _{eff}
Continuous Current at 480 V	1.7 A _{eff}	3.3 A _{eff}	6.6 A _{eff}
Peak Current	14 A _{eff}	24 A _{eff}	24 A _{eff}
Maximum Motor Line Length	25 m		
Protective Measures	Short circuit and ground fault protection		
Motor Holding Brake Connection			
Maximum Output Current	1 A		
Protective Measures	Short circuit and ground fault protection		
Braking Resistance			
Peak Power Output	3.5 kW	7 kW	7 kW
Continuous Power Output	130 W	200 W	200 W
Operational Conditions			
Environmental Temperature during Operation	0 to 45 °C		
Relative Humidity during Operation	5 to 95 %, non-condensing		
Power Reduction in Relation to Installation Altitude	10 % per 1000 m installation altitude Max. 2,000 m above sea level		
Degree of Pollution according to IEC 60664-1	2 (non-conductive material)		
Overvoltage Category according to IEC 60364-4-443:1999	II		
Protection according to IEC 60529	IP20		
Storage and Transport Conditions			
Storage Temperature	-25 to +55 °C		
Relative Humidity for Storage	5 to 95 %, non-condensing		
Transport Temperature	-25 to +70 °C		
Relative Humidity for Transport	95 % at 40 °C, non-condensing		
Mechanical Characteristics			
Dimensions Width Height Depth	70.5 mm 375 mm 235.5 mm		
Weight	4.0 kg	4.1 kg	4.4 kg

Table 8: Technical data ACOPOS 1022, 1045 and 1090 (cont.)

1.5 ACOPOS 1640, 128M

1.5.1 Order Data

Model Number	Short Description	Image
Servo Drives		
8V1640.00-1	Servo drive 3 x 400-480V 64A 32kW, line filter and braking resistor integrated ¹⁾	
8V128M.00-1	Servo drive 3 x 400-480V 128A 64kW, line filter and braking resistor integrated ¹⁾	
Accessories		
8AC110.60-2	ACOPOS plug-in module, CAN interface	
8AC120.60-1	ACOPOS plug-in module, EnDat encoder interface	
8AC122.60-1	ACOPOS plug-in module, resolver interface	
8AC123.60-1	ACOPOS plug-in module, incremental encoder and SSI absolute encoder interface	
8AC130.60-1	ACOPOS plug-in module, 8 digital I/O configurable in pairs as 24V input or as output 400/100mA, 2 digital outputs 2A, Order TB712 terminal block separately	

Table 9: Order data ACOPOS 1640, 128M

1) Integrated line filter in preparation.

1.5.2 Technical Data

Product ID	8V1640.00-1	8V128M.00-1
General Information		
C-UL-US Listed	Yes	
Power Mains Connection		
Mains Input Voltage	3 x 400 VAC to 480 VAC $\pm 10\%$ Power filter according to IEC 61800-3-A11 second environment (Limits from CISPR11, Group 2, Class A) ¹⁾	
Frequency	48 Hz to 62 Hz	
Installed Load	Max. 54 kVA	Max. 98 kVA
Starting Current	26 A (at 400 VAC)	
Switch-on Interval	Anywhere	
Power Loss at Max. Device Power without Brake Resistor	~1600 W	~3200 W
24 VDC Supply		
Input Voltage	24 VDC $\pm 25\%$ / -25%	
Current Requirements	Max. 6 A + 1.4 x current for motor holding brake	

Table 10: Technical data ACOPOS 1640, 128M

Technical Data • ACOPOS Servo Family

Product ID	8V1640.00-1	8V128M.00-1
Motor Connection		
Maximum Switching Frequency	10 kHz	5 kHz
Continuous Current at 400 V	64 A _{eff}	128 A _{eff}
Continuous Current at 480 V	48 A _{eff}	96 A _{eff}
Peak Current	200 A _{eff} (283 A _{pk})	300 A _{eff} (425 A _{pk})
Maximum Motor Line Length	25 m	
Protective Measures	Short circuit and ground fault protection	
Motor Holding Brake Connection		
Maximum Output Current	3 A	
Protective Measures	Short circuit and ground fault protection	
Braking Resistance		
Peak Power Int. / Ext.	7 / 250 kW	8.5 / 250 kW
Continuous Power Int. / Ext.	0.2 / 24 kW	0.24 / 24 kW
Operational Conditions		
Environmental Temperature during Operation	0 to 40 °C	
Relative Humidity during Operation	5 to 95 %, non-condensing	
Power Reduction in Relation to Installation Altitude	10 % per 1000 m installation altitude Max. 2,000 m above sea level	
Degree of Pollution according to IEC 60664-1	2 (non-conductive material)	
Overvoltage Category according to IEC 60364-4-443:1999	II	
Protection according to IEC 60529	IP20	
Storage and Transport Conditions		
Storage Temperature	-25 to +55 °C	
Relative Humidity for Storage	5 to 95 %, non-condensing	
Transport Temperature	-25 to +70 °C	
Relative Humidity for Transport	95 % at 40 °C, non-condensing	
Mechanical Characteristics		
Dimensions		
Width	276 mm	402 mm
Height	460 mm	460 mm
Depth	295 mm	295 mm
Weight	24.1 kg	33.8 kg

Table 10: Technical data ACOPOS 1640, 128M (cont.)

1) Integrated line filter in preparation.

2. ACOPOS Plug-in Modules

2.1 General Information

The ACOPOS drives are equipped with four plug-in module slots. You can select the plug-in modules required for your application and insert them into the ACOPOS servo drive.

2.2 Module Overview

Model Number	Short Description
8AC110.60-2	ACOPOS plug-in module, CAN interface
8AC120.60-1	ACOPOS plug-in module, EnDat encoder interface
8AC122.60-1	ACOPOS plug-in module, resolver interface
8AC123.60-1	ACOPOS plug-in module, incremental encoder and SSI absolute encoder interface
8AC130.60-1	ACOPOS plug-in module, 8 digital I/O configurable in pairs as 24V input or as output 400/100mA, 2 digital outputs 2A, Order TB712 terminal block separately

Table 11: Module overview for plug-in modules

2.3 AC110 - CAN Interface

2.3.1 General Description

The AC110 plug-in module can be used in an ACOPOS slot. The module is equipped with a CAN interface. This fieldbus interface is used for communication and setting parameters on the ACOPOS servo drive for standard applications.

2.3.2 Order Data

Model Number	Short Description	Image
	Plug-in Module	
8AC110.60-2	ACOPOS plug-in module, CAN interface	
	Accessories	
7AC911.9	Bus Connector, CAN	
0AC912.9	Bus Adapter, CAN, 1 CAN interface	
0AC913.92	Bus Adapter, CAN, 2 CAN interfaces, including 30 cm connection cable	

Table 12: Order Data AC110

2.3.3 Technical Data

Product ID	8AC110.60-2
General Information	
C-UL-US Listed	Yes
Module Type	ACOPOS plug-in module
Slot	Currently limited to slot 1
Power Consumption	Max. 0.7 W
CAN Interface	
Connection, Module Side	9 pin DSUB plug
Indications	RXD/TXD LEDs
Electrical Isolation CAN - ACOPOS	Yes

Table 13: Technical Data AC110

Product ID	8AC110.60-2
Maximum Distance	60 m
Baud Rate	500 kBit/s
Network Capable	Yes
Bus Termination Resistor	Externally wired
Operational Conditions	
Environmental Temperature during Operation	0 to 50 °C
Relative Humidity during Operation	5 to 95 %, non-condensing
Storage and Transport Conditions	
Storage Temperature	-25 to +55 °C
Relative Humidity for Storage	5 to 95 %, non-condensing
Transport Temperature	-25 to +70 °C
Relative Humidity for Transport	95 % at 40 °C, non-condensing

Table 13: Technical Data AC110 (cont.)

2.3.4 CAN Node Number Settings

The CAN node number can be set using two HEX code switches: ¹⁾

Code Switch	CAN Node Number
Top	16s position (high)
Bottom	1s position (low)

Table 14: Setting the CAN node number with the two HEX code switches

Changing the node number becomes active the next time the ACOPOS servo drive is switched on.

There must be a terminating resistor (120 Ω, 0.25 W) between CAN_H and CAN_L at the beginning and end of the CAN bus.

2.3.5 Indications

The status LEDs show if data is being received (RXD) or sent (TXD).

¹⁾ Changing the node number using software is not possible (Basis CAN ID can be changed). The ACOPOS Manager only supports node numbers from 1 - 32. When using the NC157 positioning module, only node numbers from 1 - 8 are possible.

2.4 AC120 - EnDat Encoder Interface

2.4.1 General Description

The AC120 plug-in module can be used in an ACOPOS slot. The module is equipped with an EnDat encoder interface.

The module handles the output from EnDat encoders which are built into B&R servo motors or used as an encoder for external axes. The encoder input signals are monitored. In this way, broken connections, shorted lines and encoder supply failure can be recognized.

EnDat is a standard developed by Johannes Heidenhain GmbH (www.heidenhain.de), incorporating the advantages of absolute and incremental position measurement and also offers a read/write parameter memory in the encoder. With absolute position measurement (absolute position is read in serially) the search home procedure is usually not required. Where necessary a multi-turn encoder (4096 revolutions) should be installed. To save costs, a single turn encoder and a reference switch can also be used. In this case, a search home procedure must be carried out.

The incremental process allows the short delay times necessary for position measurement on drives with exceptional dynamic properties. With the sinusoidal incremental signal and the fine resolution in the EnDat module, a very high positioning resolution is achieved in spite of the moderate signal frequencies used.

The parameter memory in the encoder is used by B&R to store motor data (among other things). In this way, the ACOPOS servo drives are always automatically provided the correct motor parameters and limit values.

During start-up, the AC120 module is automatically identified, configured and its parameters set by the ACOPOS operating system. You only have to make sure that the maximum cable length is not exceeded. When using a B&R EnDat cable, even this source of problems is avoided.

2.4.2 Order Data

Model Number	Short Description	Image
	Plug-in Module	
8AC120.60-1	ACOPOS plug-in module, EnDat encoder interface	
	Accessories	
8CE005.12-1	EnDat cable, length 5m, 10 x 0.14mm ² + 2 x 0.5mm ² , EnDat connector 17 pin Intercontec socket, servo connector 15 pin DSUB plug, can be used in cable drag chains, UL/CSA listed	
8CE007.12-1	EnDat cable, length 7m, 10 x 0.14mm ² + 2 x 0.5mm ² , EnDat connector 17 pin Intercontec socket, servo connector 15 pin DSUB plug, can be used in cable drag chains, UL/CSA listed	
8CE010.12-1	EnDat cable, length 10m, 10 x 0.14mm ² + 2 x 0.5mm ² , EnDat connector 17 pin Intercontec socket, servo connector 15 pin DSUB plug, can be used in cable drag chains, UL/CSA listed	
8CE015.12-1	EnDat cable, length 15m, 10 x 0.14mm ² + 2 x 0.5mm ² , EnDat connector 17 pin Intercontec socket, servo connector 15 pin DSUB plug, can be used in cable drag chains, UL/CSA listed	
8CE020.12-1	EnDat cable, length 20m, 10 x 0.14mm ² + 2 x 0.5mm ² , EnDat connector 17 pin Intercontec socket, servo connector 15 pin DSUB plug, can be used in cable drag chains, UL/CSA listed	
8CE025.12-1	EnDat cable, length 25m, 10 x 0.14mm ² + 2 x 0.5mm ² , EnDat connector 17 pin Intercontec socket, servo connector 15 pin DSUB plug, can be used in cable drag chains, UL/CSA listed	

Table 15: Order Data AC120

2.4.3 Technical Data

Product ID	8AC120.60-1
General Information	
C-UL-US Listed	Yes
Module Type	ACOPOS plug-in module
Slot ¹⁾	Currently limited to slots 2 and 3
Power Consumption E0 ... EnDat single-turn, 512 lines E1 ... EnDat multi-turn, 512 lines E2 ... EnDat single-turn, 32 lines (inductive) E3 ... EnDat multi-turn, 32 lines (inductive)	Max. 1.7 W Max. 2.3 W In preparation In preparation
Encoder Input	
Connection, Module Side	15 pin DSUB socket
Indications	UP/DN LEDs
Electrical Isolation EnDat Encoder - ACOPOS	No
Encoder Monitoring	Yes
Resolution ²⁾	8000 * number of encoder lines e.g. 4 million incr/rev for 512 line encoders
Precision ³⁾	---
Sine Cosine Inputs Signal Transfer Signal Frequency	Differential Signals DC...400 kHz
Serial Interface Signal Transfer Baud Rate Electrical Isolation Encoder-ACOPOS Sense Lines	RS485 625 kBaud No, common-mode voltage max. ±7 V 2, compensation of max. 1 V
Immunity ⁴⁾ IEC 61000-4-2 (ESD) IEC 61000-4-4 (Burst)	15 kV 4 kV
Operational Conditions	
Environmental Temperature during Operation	0 to 50 °C
Relative Humidity during Operation	5 to 95 %, non-condensing
Storage and Transport Conditions	
Storage Temperature	-25 to +55 °C
Relative Humidity for Storage	5 to 95 %, non-condensing
Transport Temperature	-25 to +70 °C
Relative Humidity for Transport	95 % at 40 °C, non-condensing

Table 16: Technical Data AC120

1) Two EnDat modules can also be inserted. In this case, the module in slot 2 is automatically used for motor feedback.

2) Noise on the encoder signal reduces the resolution that can be used by approx. 3 bits (factor of 8).

3) The precision is actually limited by the encoder.

4) With B&R EnDat cable. Both screws on the module must be tightened!

2.5 AC122 - Resolver Interface

2.5.1 General Description

The AC122 plug-in module can be used in an ACOPOS slot. The module is equipped with a resolver interface.

The plug-in module handles the output from resolvers which are built into B&R servo motors or used as an encoder for external axes. This resolver delivers the absolute position over one revolution. Normally, the movement path is longer than one revolution. In this case, a reference switch must be used and a search home procedure carried out.

The encoder input signals are monitored. In this way, broken connections, shorted lines and encoder supply failure can be recognized. ¹⁾

The module is designed for the evaluation of BRX resolvers. These resolvers are fed with a single sinusoidal signal (reference signal) and deliver two sinusoidal signals as the result. The amplitude of these signals change with the angular position (sine or cosine form).

Unlike BRX resolvers, BRT resolvers can be fed with two sine signals which are offset by 90°. A single sine signal with constant amplitude is returned. The phase position of this signal depends on the angular position.

During start-up, the AC122 module is automatically identified by the ACOPOS operating system. Making automatic adjustments to the motor (resolution parameter) and reading the motor parameters and limit values is not possible because the resolver does not have parameter memory like the EnDat encoder.

If the precision, resolution, bandwidth or ease of setting parameters is not sufficient with the resolver, the EnDat system should be used (see Section 2.4 "AC120 - EnDat Encoder Interface").

¹⁾ In preparation.

2.5.2 Order Data

Model Number	Short Description	Image
8AC122.60-1	ACOPOS plug-in module, resolver interface	
	Accessories	
8CR005.12-1	Resolver cable, length 5m, 3 x 2 x 24 AWG/19, resolver connector 12 pin Intercontec socket, servo connector 9 pin DSUB plug, can be used in cable drag chains, UL/CSA listed	
8CR007.12-1	Resolver cable, length 7m, 3 x 2 x 24 AWG/19, resolver connector 12 pin Intercontec socket, servo connector 9 pin DSUB plug, can be used in cable drag chains, UL/CSA listed	
8CR010.12-1	Resolver cable, length 10m, 3 x 2 x 24 AWG/19, resolver connector 12 pin Intercontec socket, servo connector 9 pin DSUB plug, can be used in cable drag chains, UL/CSA listed	
8CR015.12-1	Resolver cable, length 15m, 3 x 2 x 24 AWG/19, resolver connector 12 pin Intercontec socket, servo connector 9 pin DSUB plug, can be used in cable drag chains, UL/CSA listed	
8CR020.12-1	Resolver cable, length 20m, 3 x 2 x 24 AWG/19, resolver connector 12 pin Intercontec socket, servo connector 9 pin DSUB plug, can be used in cable drag chains, UL/CSA listed	
8CR025.12-1	Resolver cable, length 25m, 3 x 2 x 24 AWG/19, resolver connector 12 pin Intercontec socket, servo connector 9 pin DSUB plug, can be used in cable drag chains, UL/CSA listed	

Table 17: Order Data AC122

2.5.3 Technical Data

Product ID	8AC122.60-1
General Information	
C-UL-US Listed	Yes
Module Type	ACOPOS plug-in module
Slot ¹⁾	Currently limited to slots 2 and 3
Power Consumption	Max. 1.2 W
Resolver Input	
Resolver Type	BRX ²⁾
Connection, Module Side	9 pin DSUB socket
Indications	UP/DN LEDs
Electrical Isolation Resolver - ACOPOS	No
Encoder Monitoring	Yes ³⁾

Table 18: Technical Data AC122

Product ID	8AC122.60-1
Resolution	Depends on the maximum speed 14 bits/rev for $n < 3900 \text{ min}^{-1}$ 12 bits/rev for $n < 15600 \text{ min}^{-1}$
Bandwidth	1.7 kHz for $n < 3900 \text{ min}^{-1}$ 2.5 kHz for $n < 15600 \text{ min}^{-1}$
Precision	± 8 angular minutes
Reference Output Signal Transfer Differential Voltage Output Current Frequency	Differential Signals Typically $3.4 V_{\text{eff}}$ Max. $50 \text{ mA}_{\text{eff}}$ 10 kHz
Sine Cosine Inputs Signal Transfer Differential Voltage Possible Phase Shift to Ref. Input Impedance at 10 kHz (per pin) Electrical Isolation Encoder-ACOPOS	Differential Signals Nom. $1.7 V_{\text{eff}}$ max. $1.9 V_{\text{eff}}$ $\pm 10^\circ$ $10.4 \text{ k}\Omega - j 11.1 \text{ k}\Omega$ No, common-mode voltage on the sine cosine inputs max $\pm 20 \text{ V}$
Immunity ⁴⁾ IEC 61000-4-2 (ESD) IEC 61000-4-4 (Burst)	15 kV 4 kV
Operational Conditions	
Environmental Temperature during Operation	0 to 50 °C
Relative Humidity during Operation	5 to 95 %, non-condensing
Storage and Transport Conditions	
Storage Temperature	-25 to +55 °C
Relative Humidity for Storage	5 to 95 %, non-condensing
Transport Temperature	-25 to +70 °C
Relative Humidity for Transport	95 % at 40 °C, non-condensing

Table 18: Technical Data AC122 (cont.)

- 1) Two resolver modules can also be inserted. In this case, the module in slot 2 is automatically used for motor feedback.
- 2) BRX resolvers have 1 primary winding and 2 secondary windings. The primary winding is supplied with the reference output. Sinusoidal voltages are induced into the secondary windings with amplitudes corresponding to the sine or cosine of the angle of rotation.
- 3) In preparation.
- 4) With B&R resolver cable. Both screws on the module must be tightened!

2.6 AC123 - Incremental Encoder and SSI Absolute Encoder Interface

2.6.1 General Description

The ACOPOS plug-in module AC123 is used to connect standard industrial incremental or absolute encoders with a synchronous serial interface (SSI) to ACOPOS servo drives. For example, this allows electronic gears to be configured which read master movements using external encoders. If the encoder resolution is high enough, motor feedback for asynchronous motors is also possible.

With incremental encoders, the maximum counter frequency is 200 kHz. Single and multi-turn encoders with a maximum of 31 bits at 200 kBaud can be read as absolute SSI encoders.

The position is determined cyclically (initiated by the module) and is exactly synchronized with the ACOPOS controller clock. The input signals are monitored for both encoder types. In this way, broken connections, shorted lines and encoder supply failure can be recognized.

With incremental encoders the count frequency and distance between edges is also monitored. With absolute encoders, the parity bit is evaluated and a plausibility check carried out.

2.6.2 Order Data

Model Number	Short Description	Image
8AC123.60-1	ACOPOS plug-in module, incremental encoder and SSI absolute encoder interface	

Table 19: Order Data AC123

2.6.3 Technical Data

Product ID	8AC123.60-1
General Information	
C-UL-US Listed	Yes
Module Type	ACOPOS plug-in module
Slot ¹⁾	Currently limited to slots 2 and 3
Power Consumption	Max. 7.5 W Depends on the current requirements for the encoder connected ²⁾
Encoder Input	
Connection, Module Side	15 pin DSUB socket
Indications	UP/DN LEDs
Electrical Isolation Encoder - ACOPOS	Yes
Encoder Monitoring	Yes
Signal Transfer	Differential signal transfer
Cable Length ³⁾	Max. 50 m
Immunity ⁴⁾ IEC 61000-4-2 (ESD) IEC 61000-4-4 (Burst)	15 kV 4 kV
Encoder Supply	
Supply Voltages	Internal, select between 5 V/15 V
Sense Lines for 5 V for 15 V	Yes, 2, compensation of max. 2 V No
Load 5 V 15 V	350 mA 350 mA
Short Circuit, Overload Protection	Yes
Incremental Encoder ⁵⁾	
Signal Form	Square wave pulse
Evaluation	4-fold
Input Frequency	Max. 200 kHz
Count Frequency	Max. 800 kHz
Reference Frequency	Max. 200 kHz
Distance between Edges	Min. 0.6 µs
Counter Size	32 bit
Inputs	A, A _I , B, B _I , R, R _I
Differential Voltage Inputs A, B, R Minimum Maximum	2.5 V 6 V

Table 20: Technical Data AC123

Product ID	8AC123.60-1
SSI Absolute Encoder	
Baud Rate	200 kBaud
Word Size	Max. 31 bit
Differential Voltage Clock Output - 120 Ω	
Minimum	2.5 V
Maximum	5 V
Differential Voltage Data Input	
Minimum	2.5 V
Maximum	6 V
Operational Conditions	
Environmental Temperature during Operation	0 to 50 °C
Relative Humidity during Operation	5 to 95 %, non-condensing
Storage and Transport Conditions	
Storage Temperature	-25 to +55 °C
Relative Humidity for Storage	5 to 95 %, non-condensing
Transport Temperature	-25 to +70 °C
Relative Humidity for Transport	95 % at 40 °C, non-condensing

Table 20: Technical Data AC123 (cont.)

1) Two modules can also be inserted. In this case, the module in slot 2 is automatically used for motor feedback.

2) The power consumption of the plug-in module can be approximated using the following formula:

$$P_{\text{Module}} [\text{W}] = P_{\text{Encoder}} [\text{W}] * k + 0.6 \text{ W}$$

The power consumed by the encoder P_{Encoder} is calculated from the selected encoder supply voltage (5 V/15 V) and the current required:

$$P_{\text{Encoder}} [\text{W}] = U_{\text{Encoder}} [\text{V}] * I_{\text{Encoder}} [\text{A}]$$

The following values must be used for k:

$$k = 1.2 \quad (\text{for 15 V encoder supply})$$

$$k = 1.75 \quad (\text{for 5 V encoder supply})$$

3) A cable with at least $4 \times 2 \times 0.14 \text{ mm}^2 + 2 \times 0.5 \text{ mm}^2$ is required for the maximum cable length. The sense lines must be used.

4) With shielded cable (single shield) and twisted pair signal lines (e.g. $4 \times 2 \times 0.14 \text{ mm}^2 + 2 \times 0.5 \text{ mm}^2$). Both screws on the module must be tightened!

5) Incremental encoders can be used as motor feedback only for asynchronous motors, but can only provide limited control quality for this purpose. An encoder with at least 1000 lines must be used for motor feedback.

2.7 AC130 - Digital Mixed Module

2.7.1 General Description

The AC130 plug-in module can be used in an ACOPOS slot. A maximum of 8 digital inputs or 10 digital outputs are available.

I/O points can be configured in pairs as inputs or outputs. The first three inputs have incremental encoder functionality (A, B, R). The first two outputs can be operated in pulse width modulation (PWM) mode.

The inputs are divided into 4 standard (max. 10 kHz) and 4 high speed (max. 100 kHz) inputs.

The outputs include 4 high speed (push-pull) outputs with a maximum current of 100 mA, 4 standard (high-side) outputs with a maximum current of 400 mA and 2 low speed (high-side) outputs with a maximum current of 2 A. All outputs can be read.

2.7.2 Order Data

Model Number	Short Description	Image
8AC130.60-1	ACOPOS plug-in module, 8 digital I/O configurable in pairs as 24V input or as output 400/100mA, 2 digital outputs 2A, Order TB712 terminal block separately	
Accessories		
7TB712.9	Terminal block, 12 pin, screw clamps	
7TB712.91	Terminal block, 12 pin, cage clamps	
7TB712.90-02	Terminal block, 12 pin, 20 pcs., screw clamps	
7TB712.91-02	Terminal block, 12 pin, 20 pcs., cage clamps	

Table 21: Order Data AC130

2.7.3 Technical Data

Product ID	8AC130.60-1
General Information	
C-UL-US Listed	Yes
Module Type	ACOPOS plug-in module
Slot	Currently limited to slots 3 and 4
Power Consumption	Max. 0.8 W
Inputs/Outputs	
Connection, Module Side	12 conductor pin-connector
Configuration of the Inputs/Outputs	Configured in pairs as input or output
Indication	24 V - LED
Immunity ¹⁾ IEC 61000-4-2 (ESD) IEC 61000-4-4 (Burst)	15 kV 2 kV
Power Supply	
Power Supply Minimum Nominal Maximum	18 VDC 24 VDC 30 VDC
Reverse Polarity Protection	Yes
Voltage Monitoring (24 V - LED)	Yes, supply voltage >18 V
Inputs	
Number of Inputs	max. 8
Wiring	Sink
Electrical Isolation Input - ACOPOS Input - Input	Yes No
Input Voltage Minimum Nominal Maximum	18 VDC 24 VDC 30 VDC
Switching Threshold LOW HIGH	< 5 V > 15 V
Input Current at Nominal Voltage Inputs 1 - 4 Inputs 5 - 8	Approx. 10 mA Approx. 5.5 mA
Switching Delay Inputs 1 - 4 Inputs 5 - 8	Max. 5 µs Max. 35 µs
Event Counter	
Signal Form	Square wave pulse
Input Frequency	Max. 100 kHz

Table 22: Technical Data AC130

Product ID	8AC130.60-1
Counter Size	16 bit
Inputs Input 1 Input 2	Counter 1 Counter 2
Incremental Encoder	
Signal Form	Square wave pulse
Evaluation	4-fold
Encoder Monitoring	No
Input Frequency	Max. 62.5 kHz
Count Frequency	Max. 250 kHz
Reference Frequency	Max. 62.5 kHz
Distance between Edges	Min. 2.5 µs
Counter Size	16 bit
Inputs Input 1 Input 2 Input 3	Channel A Channel B Reference Pulse R
Outputs	
Number of Outputs	max. 10
Type Outputs 1 - 4 Outputs 5 - 10	Transistor Outputs push-pull high-side
Electrical Isolation Output - ACOPOS Output - Output	Yes No
Switching Voltage Minimum Nominal Maximum	18 VDC 24 VDC 30 VDC
Continuous Current Outputs 1 - 4 Outputs 5 - 8 Outputs 9 - 10	Max. 100 mA Max. 400 mA Max. 2 A
Switching Delay Outputs 1 - 4 Outputs 5 - 8 Outputs 9 - 10	Max. 5 µs Max. 50 µs Max. 500 µs
Switching Frequency (resistive load) Outputs 1 - 2 Outputs 3 - 4 Outputs 5 - 8 Outputs 9 - 10	Max. 10 kHz (max. 20 kHz in PWM mode) Max. 10 kHz Max. 5 kHz Max. 100 Hz
PWM Outputs 1 - 2 Resolution of the Pulse Width Period Duration	13 bit 50 µs - 400 µs

Table 22: Technical Data AC130 (cont.)

Technical Data • ACOPOS Plug-in Modules

Product ID	8AC130.60-1
Protection Short Circuit Protection Overload Protection	Yes Yes
Short Circuit Current at 24 V (until cut-off) Outputs 1 - 4 Outputs 5 - 8 Outputs 9 - 10	Approx. 1 A Approx. 1.2 A Approx. 24 A
Readable Outputs	Yes
Operational Conditions	
Environmental Temperature during Operation	0 to 50 °C
Relative Humidity during Operation	5 to 95 %, non-condensing
Storage and Transport Conditions	
Storage Temperature	-25 to +55 °C
Relative Humidity for Storage	5 to 95 %, non-condensing
Transport Temperature	-25 to +70 °C
Relative Humidity for Transport	95 % at 40 °C, non-condensing

Table 22: Technical Data AC130 (cont.)

- 1) Shielded cables must be used for inputs 1 - 4. Both screws on the module must be tightened!

3. Cables

3.1 General Information

B&R offers the cables for ACOPOS servo drives in six different lengths. All cables can be used for drag chain installations.

To prevent disturbances to encoder signals, the holding brake and temperature sensor wires are in the motor cable and not in the EnDat or resolver cable.

3.1.1 Manufactured Cables

Using the B&R cable guarantees that the EMC limits are not exceeded. The cables are manufactured in the EU and are therefore subject to the strictest quality standards.

Information:

If other cables are used, make sure that they have the same wave parameters. If deviations exist, additional measures are necessary to ensure that EMC guidelines are met.

3.2 Motor Cables

3.2.1 Order Data

Model Number	Short Description	Image
Motor Cables 1.5 mm²		
8CM005.12-1	Motor cable, length 5m, 4 x 1.5mm ² + 2 x 2 x 0.75mm ² , motor connector 8 pin Intercontec socket, can be used in cable drag chains, UL/CSA listed	
8CM007.12-1	Motor cable, length 7m, 4 x 1.5mm ² + 2 x 2 x 0.75mm ² , motor connector 8 pin Intercontec socket, can be used in cable drag chains, UL/CSA listed	
8CM010.12-1	Motor cable, length 10m, 4 x 1.5mm ² + 2 x 2 x 0.75mm ² , motor connector 8 pin Intercontec socket, can be used in cable drag chains, UL/CSA listed	
8CM015.12-1	Motor cable, length 15m, 4 x 1.5mm ² + 2 x 2 x 0.75mm ² , motor connector 8 pin Intercontec socket, can be used in cable drag chains, UL/CSA listed	
8CM020.12-1	Motor cable, length 20m, 4 x 1.5mm ² + 2 x 2 x 0.75mm ² , motor connector 8 pin Intercontec socket, can be used in cable drag chains, UL/CSA listed	
8CM025.12-1	Motor cable, length 25m, 4 x 1.5mm ² + 2 x 2 x 0.75mm ² , motor connector 8 pin Intercontec socket, can be used in cable drag chains, UL/CSA listed	
Motor Cables 4 mm²		
8CM005.12-3	Motor cable, length 5m, 4 x 4mm ² + 2 x 2 x 1mm ² , motor connector 8 pin Intercontec socket, can be used in cable drag chains, UL/CSA listed	
8CM007.12-3	Motor cable, length 7m, 4 x 4mm ² + 2 x 2 x 1mm ² , motor connector 8 pin Intercontec socket, can be used in cable drag chains, UL/CSA listed	
8CM010.12-3	Motor cable, length 10m, 4 x 4mm ² + 2 x 2 x 1mm ² , motor connector 8 pin Intercontec socket, can be used in cable drag chains, UL/CSA listed	
8CM015.12-3	Motor cable, length 15m, 4 x 4mm ² + 2 x 2 x 1mm ² , motor connector 8 pin Intercontec socket, can be used in cable drag chains, UL/CSA listed	
8CM020.12-3	Motor cable, length 20m, 4 x 4mm ² + 2 x 2 x 1mm ² , motor connector 8 pin Intercontec socket, can be used in cable drag chains, UL/CSA listed	
8CM025.12-3	Motor cable, length 25m, 4 x 4mm ² + 2 x 2 x 1mm ² , motor connector 8 pin Intercontec socket, can be used in cable drag chains, UL/CSA listed	

Table 23: Order Data Motor Cables



Model Number	Short Description	Image
Motor Cables 10 mm²		
8CM005.12-5	Motor cable, length 5m, 4 x 10mm ² + 2 x 2 x 1.5mm ² , motor connector 8 pin Intercontec socket, can be used in cable drag chains, UL/CSA listed	
8CM007.12-5	Motor cable, length 7m, 4 x 10mm ² + 2 x 2 x 1.5mm ² , motor connector 8 pin Intercontec socket, can be used in cable drag chains, UL/CSA listed	
8CM010.12-5	Motor cable, length 10m, 4 x 10mm ² + 2 x 2 x 1.5mm ² , motor connector 8 pin Intercontec socket, can be used in cable drag chains, UL/CSA listed	
8CM015.12-5	Motor cable, length 15m, 4 x 10mm ² + 2 x 2 x 1.5mm ² , motor connector 8 pin Intercontec socket, can be used in cable drag chains, UL/CSA listed	
8CM020.12-5	Motor cable, length 20m, 4 x 10mm ² + 2 x 2 x 1.5mm ² , motor connector 8 pin Intercontec socket, can be used in cable drag chains, UL/CSA listed	
8CM025.12-5	Motor cable, length 25m, 4 x 10mm ² + 2 x 2 x 1.5mm ² , motor connector 8 pin Intercontec socket, can be used in cable drag chains, UL/CSA listed	
Motor Cables 35 mm²		
8CM005.12-8	Motor cable, length 5m, 4 x 35mm ² + 2 x 2 x 1.5mm ² , can be used in cable drag chains, UL/CSA listed	
8CM007.12-8	Motor cable, length 7m, 4 x 35mm ² + 2 x 2 x 1.5mm ² , can be used in cable drag chains, UL/CSA listed	
8CM010.12-8	Motor cable, length 10m, 4 x 35mm ² + 2 x 2 x 1.5mm ² , can be used in cable drag chains, UL/CSA listed	
8CM015.12-8	Motor cable, length 15m, 4 x 35mm ² + 2 x 2 x 1.5mm ² , can be used in cable drag chains, UL/CSA listed	
8CM020.12-8	Motor cable, length 20m, 4 x 35mm ² + 2 x 2 x 1.5mm ² , can be used in cable drag chains, UL/CSA listed	
8CM025.12-8	Motor cable, length 25m, 4 x 35mm ² + 2 x 2 x 1.5mm ² , can be used in cable drag chains, UL/CSA listed	

Table 23: Order Data Motor Cables (cont.)

3.2.2 Cable Specification

Product ID	Motor Cables 1.5 mm ²	Motor Cables 4 mm ²
General Information		
Cable Cross Section	4 x 1.5 mm ² + 2 x 2 x 0.75 mm ²	4 x 4 mm ² + 2 x 2 x 1 mm ²
Durability	Oil resistant according to VDE 0472 part 803, as well as standard hydraulic oil	
Certification	UL AWM Style 20669, 90 °C, 600 V, E63216 and CSA AWM I/II A/B, 90 °C, 600 V, FT1 LL46064	
Conductor		
Power Lines	1.5 mm ² , tinned Cu wire	4 mm ² , tinned Cu wire
Wire Insulation Wire Colors	Special thermoplastic material Black, brown, blue, yellow/green	
Signal Lines	0.75 mm ² , tinned Cu wire	1 mm ² , tinned Cu wire
Wire Insulation Wire Colors	Special thermoplastic material White, white/red, white/blue, white/green	
Cable Construction		
Power Lines Stranding Shield	No No	
Signal Lines Stranding Shield	White with white/red and white/blue with white/green Separate shielding for pairs, tinned Cu mesh, optical coverage >85 % and foil banding	
Cable Stranding	With filler elements and foil banding	
Cable Shielding	Tinned Cu mesh, optical coverage >85 % and wrapped in isolating fabric	
Outer Sheathing Material Color Labeling	PUR Orange, similar to RAL 2003 flat BERNECKER + RAINER 4x1.5+2x2x0.75 FLEX BERNECKER + RAINER 4x4.0+2x2x1.5 FLEX	
Electrical Characteristics		
Conductor Resistance Power Lines Signal Lines	≤ 14 Ω/km ≤ 29 Ω/km	≤ 5.2 Ω/km ≤ 14 Ω/km
Insulation Resistance	>200 MΩ per km	
Isolation Voltage Wire/wire Wire/shield	3 kV 1 kV	
Operating Voltage	Max. 600 V	
Mechanical Characteristics		
Temperature Range Moving Still	-10 °C to 70 °C -20 °C to 90 °C	
Outer Diameter	12.8 mm ±0,4 mm	15.8 mm ±0.5 mm
Flex Radius	> 96 mm	> 118.5 mm
Speed	≤ 4 m/s	
Acceleration	<60 m/s ²	

 Table 24: Cable specifications for 1.5 and 4 mm² motor cables

Product ID	Motor Cables 1.5 mm ²	Motor Cables 4 mm ²
Flex Cycles	≥3,000,000	
Weight	0.26 kg/m	0.45 kg/m

Table 24: Cable specifications for 1.5 and 4 mm² motor cables (cont.)

Product ID	Motor Cables 10 mm ²	Motor Cables 35 mm ²
General Information		
Cable Cross Section	4 x 10 mm ² + 2 x 2 x 1.5 mm ²	4 x 35 mm ² + 2 x 2 x 1.5 mm ²
Durability	Oil resistant according to VDE 0472 part 803, as well as standard hydraulic oil	
Certification	UL AWM Style 20669, 90 °C, 600 V, E63216 and CSA AWM I/II A/B, 90 °C, 600 V, FT1 LL46064	
Conductor		
Power Lines	10 mm ² , tinned Cu wire	35 mm ² , tinned Cu wire
Wire Insulation Wire Colors	Special thermoplastic material Black, brown, blue, yellow/green	
Signal Lines	1.5 mm ² , tinned Cu wire	
Wire Insulation Wire Colors	Special thermoplastic material White, white/red, white/blue, white/green	
Cable Construction		
Power Lines Stranding Shield	No No	
Signal Lines Stranding Shield	White with white/red and white/blue with white/green Separate shielding for pairs, tinned Cu mesh, optical coverage >85 % and foil banding	
Cable Stranding	With filler elements and foil banding	
Cable Shielding	Tinned Cu mesh, optical coverage >85 % and wrapped in isolating fabric	
Outer Sheathing Material Color	PUR Orange, similar to RAL 2003 flat	
Labeling	BERNECKER + RAINER 4x10.0+2x2x1.5 FLEX	BERNECKER + RAINER 4x35.0+2x2x1.5 FLEX
Electrical Characteristics		
Conductor Resistance		
Power Lines	≤ 2.1 Ω/km	≤ 0.6 Ω/km
Signal Lines	≤ 14 Ω/km	≤ 14 Ω/km
Insulation Resistance	>200 MΩ per km	
Isolation Voltage		
Wire/wire	3 kV	
Wire/shield	1 kV	
Operating Voltage	Max. 600 V	

Table 25: Cable specifications for 10 and 35 mm² motor cables

Product ID	Motor Cables 10 mm ²	Motor Cables 35 mm ²
Mechanical Characteristics		
Temperature Range Moving Still	-10 °C to 70 °C -20 °C to 90 °C	
Outer Diameter	20.1 mm ±0.7 mm	32.5 mm ±1 mm
Flex Radius	> 150.8 mm	> 243.8 mm
Speed	≤ 4 m/s	
Acceleration	<60 m/s ²	
Flex Cycles	≥3,000,000	
Weight	0.77 kg/m	2.2 kg/m

Table 25: Cable specifications for 10 and 35 mm² motor cables (cont.)

3.3 EnDat Cables

3.3.1 Order Data

Model Number	Short Description	Image
8CE005.12-1	EnDat cable, length 5m, 10 x 0.14mm ² + 2 x 0.5mm ² , EnDat connector 17 pin Intercontec socket, servo connector 15 pin DSUB plug, can be used in cable drag chains, UL/CSA listed	
8CE007.12-1	EnDat cable, length 7m, 10 x 0.14mm ² + 2 x 0.5mm ² , EnDat connector 17 pin Intercontec socket, servo connector 15 pin DSUB plug, can be used in cable drag chains, UL/CSA listed	
8CE010.12-1	EnDat cable, length 10m, 10 x 0.14mm ² + 2 x 0.5mm ² , EnDat connector 17 pin Intercontec socket, servo connector 15 pin DSUB plug, can be used in cable drag chains, UL/CSA listed	
8CE015.12-1	EnDat cable, length 15m, 10 x 0.14mm ² + 2 x 0.5mm ² , EnDat connector 17 pin Intercontec socket, servo connector 15 pin DSUB plug, can be used in cable drag chains, UL/CSA listed	
8CE020.12-1	EnDat cable, length 20m, 10 x 0.14mm ² + 2 x 0.5mm ² , EnDat connector 17 pin Intercontec socket, servo connector 15 pin DSUB plug, can be used in cable drag chains, UL/CSA listed	
8CE025.12-1	EnDat cable, length 25m, 10 x 0.14mm ² + 2 x 0.5mm ² , EnDat connector 17 pin Intercontec socket, servo connector 15 pin DSUB plug, can be used in cable drag chains, UL/CSA listed	

Table 26: Order Data EnDat Cables

3.3.2 Cable Specification

Product ID	EnDat Cables
General Information	
Cable Cross Section	10 x 0.14 mm ² + 2 x 0.50 mm ²
Durability	Oil resistant according to VDE 0472 part 803, as well as standard hydraulic oil
Certification	UL AWM Style 20963, 80 °C, 30 V, E63216 and CSA AWM I/II A/B, 90 °C, 30 V, FT1 LL46064
Conductor	
Signal Lines Wire Insulation Wire Colors	0.14 mm ² , tinned Cu wire Special thermoplastic material Blue, brown, yellow, gray, green, pink, red, black, violet, white
Supply Lines Wire Insulation Wire Colors	0.5 mm ² , tinned Cu wire Special thermoplastic material White/green, white/red

Table 27: Cable specifications for EnDat cables

Product ID	EnDat Cables
Cable Construction	
Signal Lines Stranding Shield	No No
Supply Lines Stranding Shield	White/red with white/green and filler elements No
Cable Stranding	with foil banding
Cable Shielding	Cu mesh, optical coverage >85 % and wrapped in isolating fabric
Outer Sheathing Material Color Labeling	PUR Orange, similar to RAL 2003 flat BERNECKER + RAINER 10x0.14+2x0.50 FLEX
Electrical Characteristics	
Conductor Resistance Signal Lines Supply Lines	≤ 140 Ω/km ≤ 40 Ω/km
Insulation Resistance	>200 MΩ per km
Isolation Voltage Wire/wire Wire/shield	1.5 kV 0.8 kV
Operating Voltage	Max. 30 V
Mechanical Characteristics	
Temperature Range Moving Still	-10 °C to 70 °C -20 °C to 90 °C
Outer Diameter	7.3 mm ±0.25 mm
Flex Radius	> 55 mm
Speed	≤ 4 m/s
Acceleration	<60 m/s ²
Flex Cycles	≥3,000,000
Weight	0.08 kg/m

Table 27: Cable specifications for EnDat cables (cont.)

3.4 Resolver Cables

3.4.1 Order Data

Model Number	Short Description	Image
8CR005.12-1	Resolver cable, length 5m, 3 x 2 x 24 AWG/19, resolver connector 12 pin Intercontec socket, servo connector 9 pin DSUB plug, can be used in cable drag chains, UL/CSA listed	
8CR007.12-1	Resolver cable, length 7m, 3 x 2 x 24 AWG/19, resolver connector 12 pin Intercontec socket, servo connector 9 pin DSUB plug, can be used in cable drag chains, UL/CSA listed	
8CR010.12-1	Resolver cable, length 10m, 3 x 2 x 24 AWG/19, resolver connector 12 pin Intercontec socket, servo connector 9 pin DSUB plug, can be used in cable drag chains, UL/CSA listed	
8CR015.12-1	Resolver cable, length 15m, 3 x 2 x 24 AWG/19, resolver connector 12 pin Intercontec socket, servo connector 9 pin DSUB plug, can be used in cable drag chains, UL/CSA listed	
8CR020.12-1	Resolver cable, length 20m, 3 x 2 x 24 AWG/19, resolver connector 12 pin Intercontec socket, servo connector 9 pin DSUB plug, can be used in cable drag chains, UL/CSA listed	
8CR025.12-1	Resolver cable, length 25m, 3 x 2 x 24 AWG/19, resolver connector 12 pin Intercontec socket, servo connector 9 pin DSUB plug, can be used in cable drag chains, UL/CSA listed	

Table 28: Order Data Resolver Cables

3.4.2 Cable Specification

Product ID	Resolver Cables
General Information	
Cable Cross Section	3 x 2 x 24 AWG/19
Durability	Oil resistant according to VDE 0472 part 803, as well as standard hydraulic oil
Certification	UL AWM Style 20671, 90 °C, 30 V, E63216 and CSA AWM, 90 °C, 30 V, I/II A/B FT1 LL46064
Conductor	
Signal Lines Wire Insulation Wire Colors	24 AWG/19, tinned Cu wire Special thermoplastic material White, brown, green, yellow, gray, pink
Cable Construction	
Signal Lines Stranding Shield	White with brown, green with yellow, gray with pink No
Cable Stranding	The 3 pairs together covered by foil banding
Cable Shielding	Cu mesh, optical coverage ≥90 % and wrapped in isolating fabric
Outer Sheathing Material Color Labeling	PUR Orange, similar to RAL 2003 flat BERNECKER + RAINER 3x2x24 AWG FLEX
Electrical Characteristics	
Conductor Resistance 24 AWG	≤ 86 Ω/km
Insulation Resistance	>200 MΩ per km
Isolation Voltage Wire/wire Wire/shield	1.5 kV 0.8 kV
Operating Voltage	Max. 30 V
Mechanical Characteristics	
Temperature Range Moving Still	-10 °C to 80 °C -40 °C to 90 °C
Outer Diameter	6.5 mm ±0.2 mm
Flex Radius	≥50 mm
Speed	≤ 4 m/s
Acceleration	<60 m/s ²
Flex Cycles	≥3,000,000
Weight	0.07 kg/m

Table 29: Cable specifications for resolver cables

4. Connectors

4.1 General Information

B&R offers five different motor/encoder connectors for AC servo motors. All connectors have IP67 protection. The metallic housing provides a protective ground connection on the housing according to VDE 0627. All plastic used in the connector is UL94/V0 listed. High quality, gold plated cage connector contacts guarantee a high level of contact security even when reinserted many times.

Using the B&R connector guarantees that the EMC limits for the connection are not exceeded. Make sure that connectors are put together correctly including a proper shield connection.

4.2 Motor Connectors

4.2.1 Order Data

Model Number	Short Description	Image
Cable Diameter 9 - 17 mm		
8PM001.00-1	Motor connector 8 pin Intercontec socket, crimp range 4 x 0.5-2.5mm ² + 4 x 0.06-1.0mm ² , for cable ø 9-14mm, IP67, UL/CSA listed	
8PM002.00-1	Motor connector 8 pin Intercontec socket, crimp range 4 x 0.5-4.0mm ² + 4 x 0.06-1.0mm ² , for cable ø 14-17mm, IP67, UL/CSA listed	
Cable Diameter 17 - 26 mm		
8PM003.00-1	Motor connector 8 pin Intercontec socket, crimp range 4 x 1.5-10mm ² + 4 x 0.5-2.5mm ² , for cable ø 17-26mm, IP67, UL/CSA listed	

Table 30: Order data for motor connectors

4.2.2 Specifications for 8PM001.00-1 and 8PM002.00-1

Product ID	8PM001.00-1	8PM002.00-1
General Information		
Contacts	8 (4 power and 4 signal contacts)	
Degree of Pollution	3	
Installation Altitude	up to 4,000 m	
Insulator	PA, UL94/V0 listed	
Contacts	Gold plated brass	
Protective Ground Connection on Housing	According to VDE 0627	
Protection according to DIN 40050	IP67 when connected	
Certifications	UL/CSA	
Electrical Characteristics		
Overvoltage Category	3	
Power Contacts		
Nominal Current	25 A	
Nominal Voltage	800 VAC / VDC	
Isolation Voltage (L-L)	6000 V	
Contact Resistance	<3 mΩ	
Signal Contacts		
Nominal Current	9 A	
Nominal Voltage	250 VAC / VDC	
Isolation Voltage (L-L)	2500 V	
Contact Resistance	<5 mΩ	
Mechanical Characteristics		
Temperature Range	-40 °C to 125 °C	
Housing Material	Zinc casting, nickel plated	
Gaskets	Viton, H-NBR	
Crimp Range	4 x 0.5 - 2.5 mm ² + 4 x 0.06 - 1 mm ²	4 x 0.5 - 4 mm ² + 4 x 0.06 - 1 mm ²
Cable ø	9 - 14 mm	14 - 17 mm
Manufacturer Information		
Manufacturer	INTERCONTEC	
Internet Address	http://www.intercontec.com	
Manufacturer's Product ID	BSTA 108 FR 19 08 0006 000	BSTA 108 FR 35 16 0006 000

Table 31: Specifications for motor connectors 8PM001.00-1 and 8PM002.00-1

4.2.3 Specifications for 8PM003.00-1

Product ID	8PM003.00-1
General Information	
Contacts	8 (4 power and 4 signal contacts)
Degree of Pollution	3
Installation Altitude	up to 4,000 m
Insulator	PA, UL94/V0 listed
Contacts	Gold plated brass
Protective Ground Connection on Housing	According to VDE 0627
Protection according to DIN 40050	IP67 when connected
Certifications	UL/CSA
Electrical Characteristics	
Overvoltage Category	3
Power Contacts Nominal Current Nominal Voltage Isolation Voltage (L-L) Contact Resistance	75 A 630 VAC / VDC 6000 V <1 mΩ
Signal Contacts Nominal Current Nominal Voltage Isolation Voltage (L-L) Contact Resistance	30 A 250 VAC / VDC 4000 V <3 mΩ
Mechanical Characteristics	
Temperature Range	-40 °C to 130 °C
Housing Material	Aluminum, nickel plated
Gaskets	Viton
Crimp Range	4 x 1.5 - 10 mm ² + 4 x 0.5 - 2.5 mm ²
Cable ø	17 - 26 mm
Manufacturer Information	
Manufacturer Internet Address	INTERCONTEC http://www.intercontec.com
Manufacturer's Product ID	CSTA 264 FR 48 25 0001 000

Table 32: Specifications for motor connector 8PM003.00-1

4.3 Encoder Connectors

4.3.1 Order Data



Model Number	Short Description	Image
EnDat Connector		
8PE001.00-1	EnDat Connector 17 pin Intercontec socket, crimp range 17 x 0.06-1.0mm², for cable ø 9-12mm, IP67, UL/CSA listed	
Resolver Connector		
8PR001.00-1	Resolver connector 12 pin Intercontec socket, crimp range 12 x 0.06-1.0mm², for cable ø 5.5-10.5mm, IP67, UL/CSA listed	

Table 33: Order data for encoder connectors

4.3.2 Specifications for EnDat Connector 8PE001.00-1

Product ID	8PE001.00-1
General Information	
Contacts	17 signal contacts
Degree of Pollution	3
Installation Altitude	up to 2,000 m
Insulator	PBT, UL94/V0 listed
Contacts	Gold plated brass
Protective Ground Connection on Housing	According to VDE 0627
Protection according to DIN 40050	IP67 when connected
Certifications	UL/CSA
Electrical Characteristics	
Signal Contacts	
Nominal Current	9 A
Nominal Voltage	32 V
Isolation Voltage (L-L)	1500 V
Contact Resistance	<5 mΩ
Mechanical Characteristics	
Temperature Range	-40 °C to 125 °C
Housing Material	Zinc casting, nickel plated
Gaskets	Viton, H-NBR
Crimp Range	17 x 0.06 - 1 mm ²
Cable ø	9 - 12 mm
Manufacturer Information	
Manufacturer	INTERCONTEC
Internet Address	http://www.intercontec.com
Manufacturer's Product ID	ASTA 035 FR 11 12 0005 000

Table 34: Specifications for EnDat Connector 8PE001.00-1

4.3.3 Specifications for Resolver Connector 8PR001.00-1

Product ID	8PR001.00-1
General Information	
Contacts	12 signal contacts
Degree of Pollution	3
Installation Altitude	up to 2,000 m
Insulator	PBT, UL94/V0 listed
Contacts	Gold plated brass
Protective Ground Connection on Housing	According to VDE 0627
Protection according to DIN 40050	IP67 when connected
Certifications	UL/CSA
Electrical Characteristics	
Signal Contacts	
Nominal Current	9 A
Nominal Voltage	160 V
Isolation Voltage (L-L)	2500 V
Contact Resistance	<5 mΩ
Mechanical Characteristics	
Temperature Range	-40 °C to 125 °C
Housing Material	Zinc casting, nickel plated
Gaskets	Viton, H-NBR
Crimp Range	12 x 0.06 - 1 mm ²
Cable ø	5.5 - 10.5 mm
Manufacturer Information	
Manufacturer	INTERCONTEC
Internet Address	http://www.intercontec.com
Manufacturer's Product ID	ASTA 021 FR 11 10 0005 000

Table 35: Specifications for Resolver Connector 8PR001.00-1

CHAPTER 3 • INSTALLATION

1. General Information

Make sure that installation takes place on a flat surface which is correctly dimensioned. The dimensional diagram lists the number and type of mounting screws to be used.

The ring screws contained in the delivery can be attached to the device to lift ACOPOS 1640 and ACOPOS 128M drives:

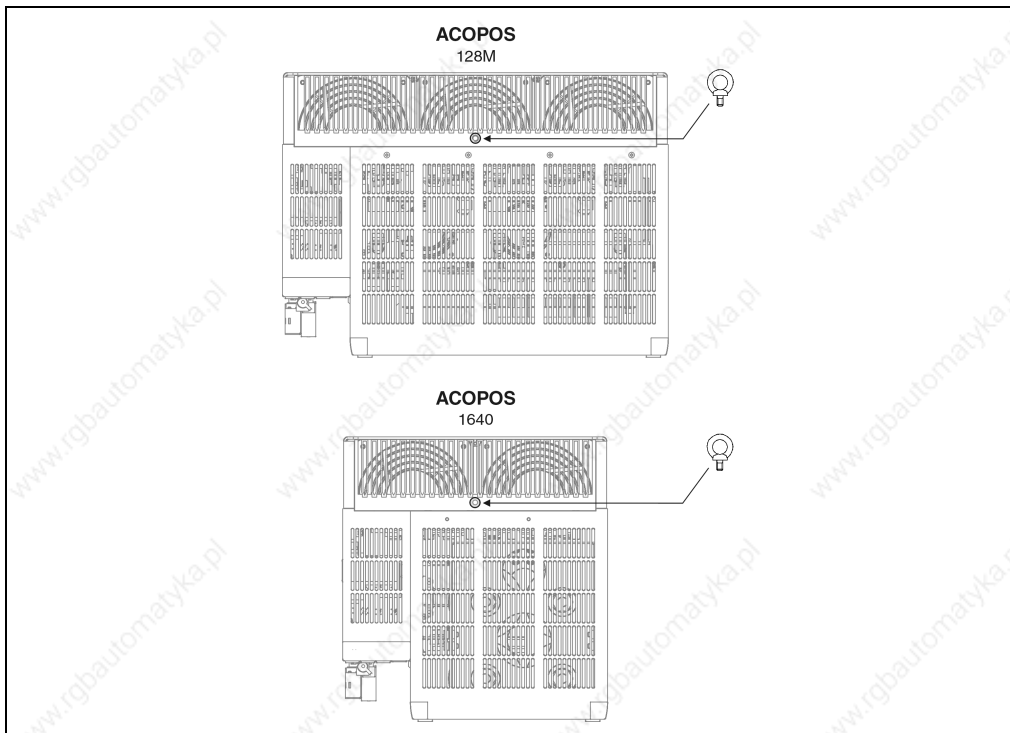

Figure 9: Attaching the ring screws contained in the delivery to ACOPOS 1640 and 128M drives

ACOPOS servo drives can only be installed in an environment which corresponds to pollution degree II (non-conductive material). When installing the device, make sure that the maximum operating temperature (40 °C) is not exceeded and IP20 protection is provided as specified in the technical data.

For proper air circulation, at least 80 mm has to be left free above and below the ACOPOS servo drive. ACOPOS servo drives can be mounted directly next to each other; the required distance between devices can be found in the respective dimensional diagram.

2. Dimensional Diagram and Installation Dimensions

2.1 ACOPOS 1022, 1045, 1090

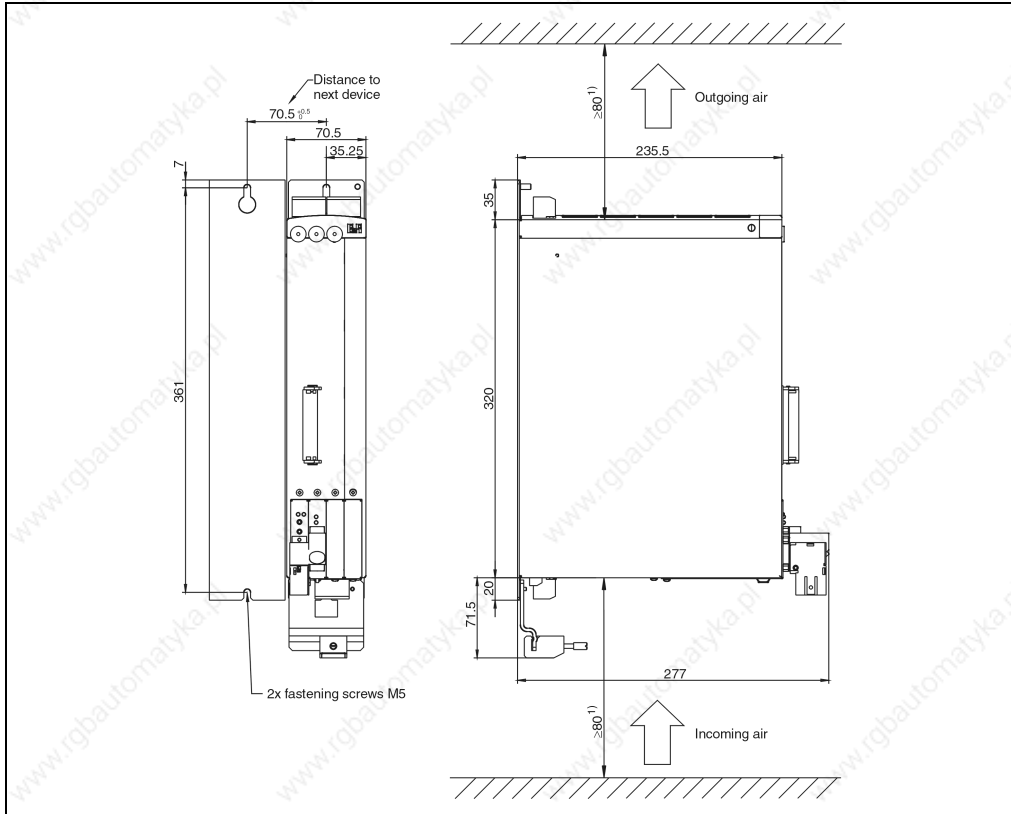

Figure 10: Dimensional diagram and installation dimensions for ACOPOS 1022, 1045, 1090

- 1) For proper air circulation, at least 80 mm has to be left free above and below the ACOPOS servo drive.

2.2 ACOPOS 1640

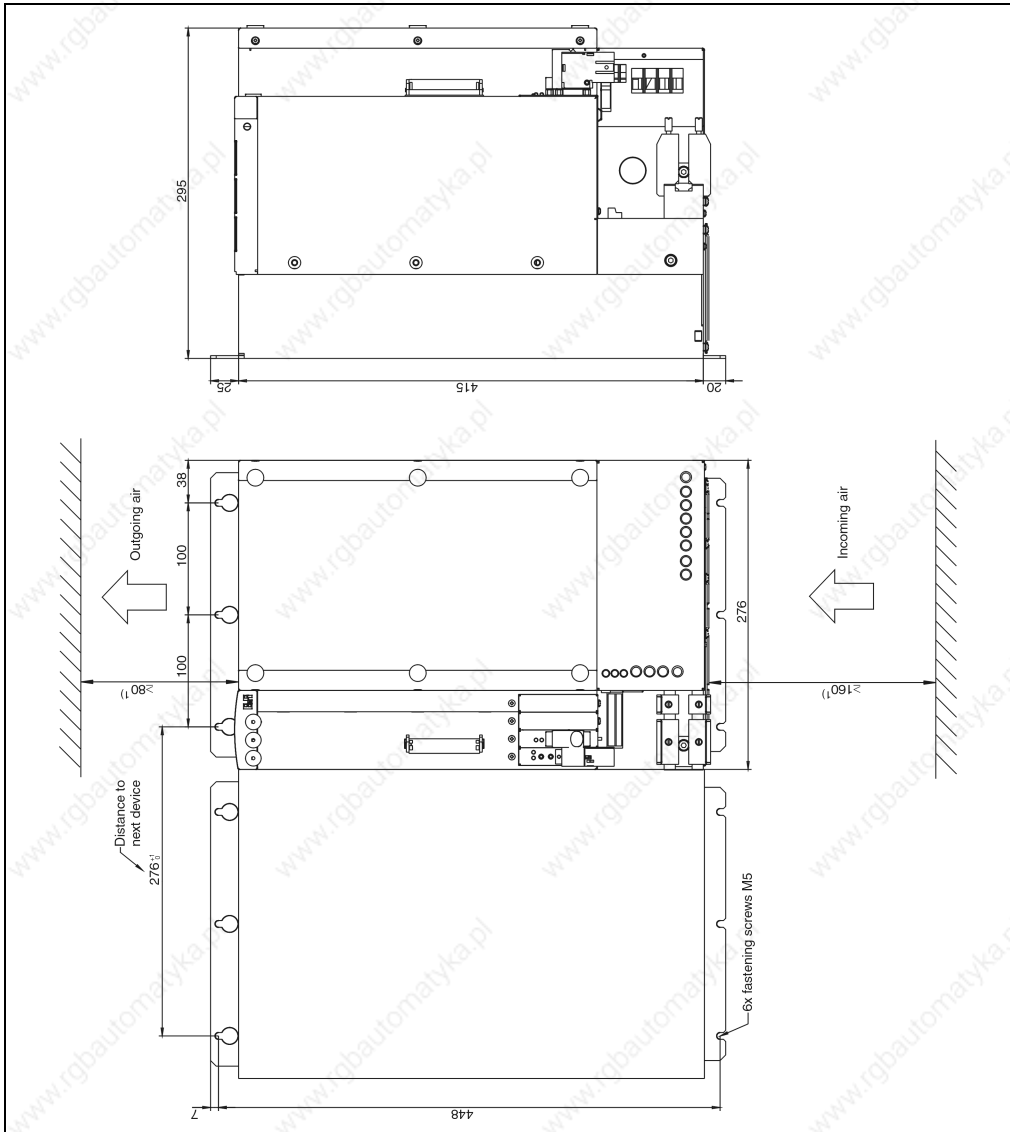

Figure 11: Dimensional diagram and installation dimensions for ACOPOS 1640

- 1) For proper air circulation, at least 80 mm has to be left free above and below the ACOPOS servo drive. Approximately 160 mm free space is required under the ACOPOS servo drive to prevent cabling problems.

2.3 ACOPOS 128M

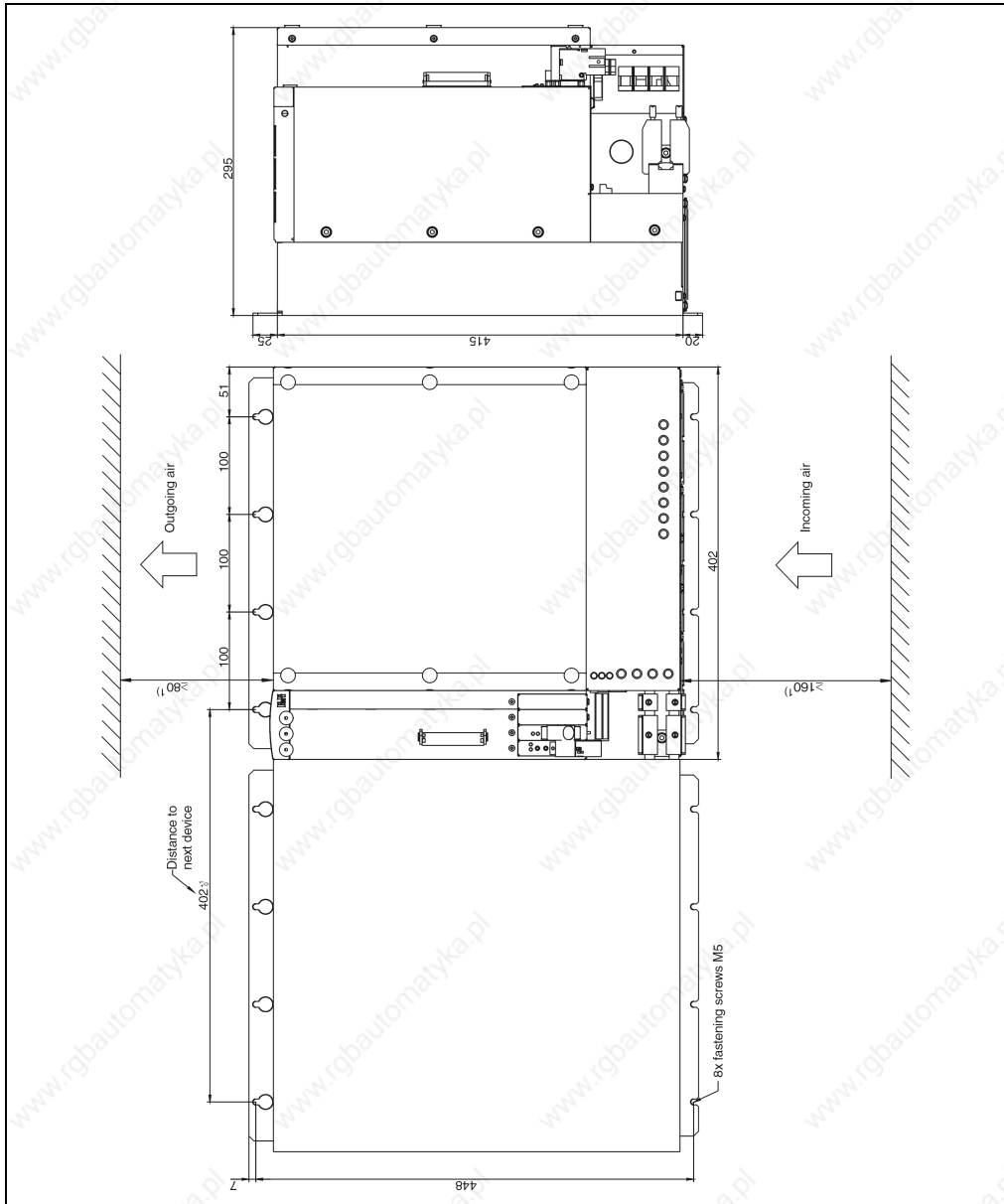

Figure 12: Dimensional diagram and installation dimensions for ACOPOS 128M

- 1) For proper air circulation, at least 80 mm has to be left free above and below the ACOPOS servo drive. Approximately 160 mm free space is required under the ACOPOS servo drive to prevent cabling problems.

3. Installation and Removal of Plug-in Modules

3.1 General Information

All ACOPOS servo drives are equipped with four slots for plug-in modules. At present, the following module arrangements must be used:

 1 2 3 4	Plug-in Module	Operation Possible in this Slot			
		1	2	3	4
	8AC110.60-2	✓	x	x	x
	8AC120.60-1	x	✓	✓	x
	8AC122.60-1	x	✓	✓	x
	8AC123.60-1	x	✓	✓	x
	8AC130.60-1	x	x	✓	✓

Table 36: Slot overview for ACOPOS plug-in modules

Caution!

- **Keep the plug-in modules in the original packaging and only take them out immediately before installation.**
- **Avoid touching the plug-in modules anywhere but on the front cover.**
- **Take the necessary steps to protect against electrostatic discharges.**

3.1.1 Installation

- 1) Disconnect the ACOPOS servo drive from the power mains and prevent reconnection.
- 2) Switch off 24 VDC supply voltage.
- 3) Remove screw from the bottom of the slot cover.
- 4) Loosen screw on the front (**don't remove it completely, the screw could fall into the ACOPOS servo drive!**).

- 5) Remove slot cover.



Figure 13: Installing ACOPOS plug-in modules

- 6) Insert plug-in module in the free slot (see diagram shown above).
- 7) Fasten the plug-in module with the two screws.
- 8) Switch on 24 VDC supply voltage.
- 9) Connect ACOPOS servo drive to the power mains.

3.1.2 Removal

- 1) Disconnect the ACOPOS servo drive from the power mains and prevent reconnection.
- 2) Switch off 24 VDC supply voltage.
- 3) Remove screw from the bottom of the plug-in module.
- 4) Loosen screw on the front (**don't remove it completely, the screw could fall into the ACOPOS servo drive!**).
- 5) Remove plug-in module.
- 6) Insert slot cover in free slot.
- 7) Fasten the slot cover with the two screws.
- 8) Switch on 24 VDC supply voltage.
- 9) Connect ACOPOS servo drive to the power mains.

4. Installing Various ACOPOS Series Devices Directly Next to Each Other

When installing various ACOPOS series devices directly next to each other, we recommend aligning the vertical position so that the LED displays of the respective devices are lined up.

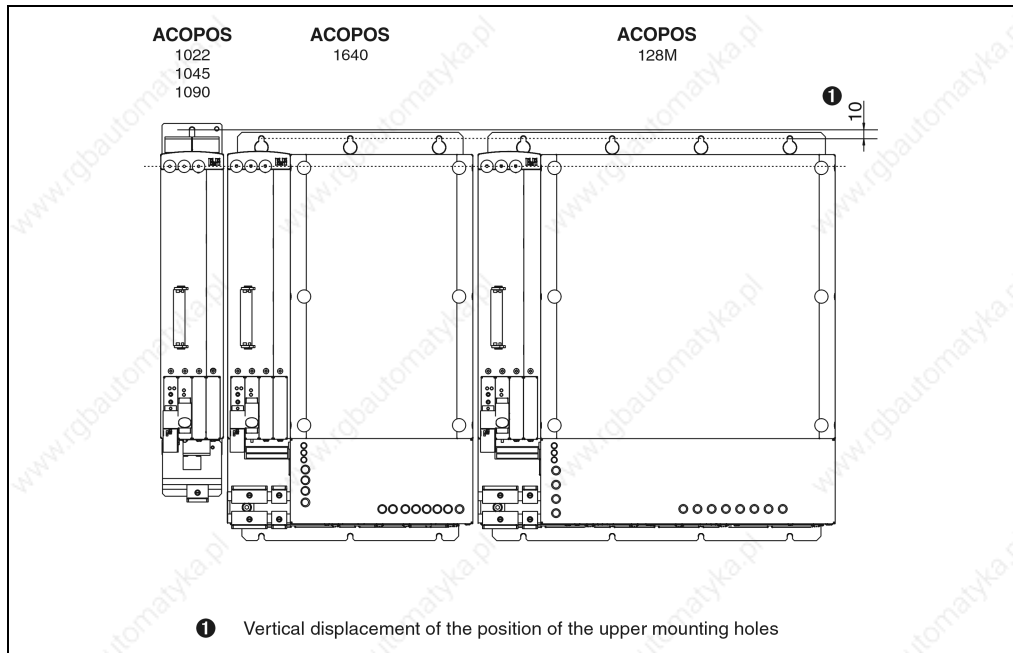

Figure 14: Installing various ACOPOS series devices directly next to each other

You can see from the image above that the vertical offset of the upper mounting holes is 10 mm. The distances for the lower mounting holes and the number and size of the screws required can be taken from the dimensional diagrams for the respective ACOPOS servo drives.

Installation • Installing Various ACOPOS Series Devices Directly Next to Each Other

Overview of the vertical offsets:

Installed next to		ACOPOS				
		1022	1045	1090	1640	128M
ACOPOS	1022	No offset			10 mm	
	1045					
	1090					
	1640	10 mm			No offset	
	128M					

Table 37: Overview of the vertical offsets (ACOPOS - ACOPOS)

5. Using Cooling Aggregates in Switching Cabinets

To prevent exceeding the required environmental temperatures, it may be necessary to cool the air inside of a switching cabinet.

Caution!

Incorrect installation of cooling aggregates may cause condensation which can damage the ACOPOS servo drives installed there!

Condensation can enter the ACOPOS servo drives with the cooled air stream!

Make sure that only well sealed switching cabinets are used (condensation caused by outside air entering the switching cabinet).

During operation with the switching cabinet doors open (e.g. service), the ACOPOS servo drives are not allowed to be cooler than the air in the switching cabinet at any time after the doors are closed.

To keep the temperature of the ACOPOS servo drives and the switching cabinet at the same level, the cooling aggregate must remain in operation even when the system is switched off.

Cooling aggregates must be installed in a way that prevents condensation from dripping into the ACOPOS servo drives. This should be considered when selecting the switching cabinet (special construction for use of cooling aggregates on top of the switching cabinet).

Also make sure that condensed water which forms in the cooling aggregate fan when it is switched off cannot sprinkle into the ACOPOS servo drives.

Make sure the temperature setting of the cooling aggregates is correct!

Cooling aggregate on top of the switching cabinet

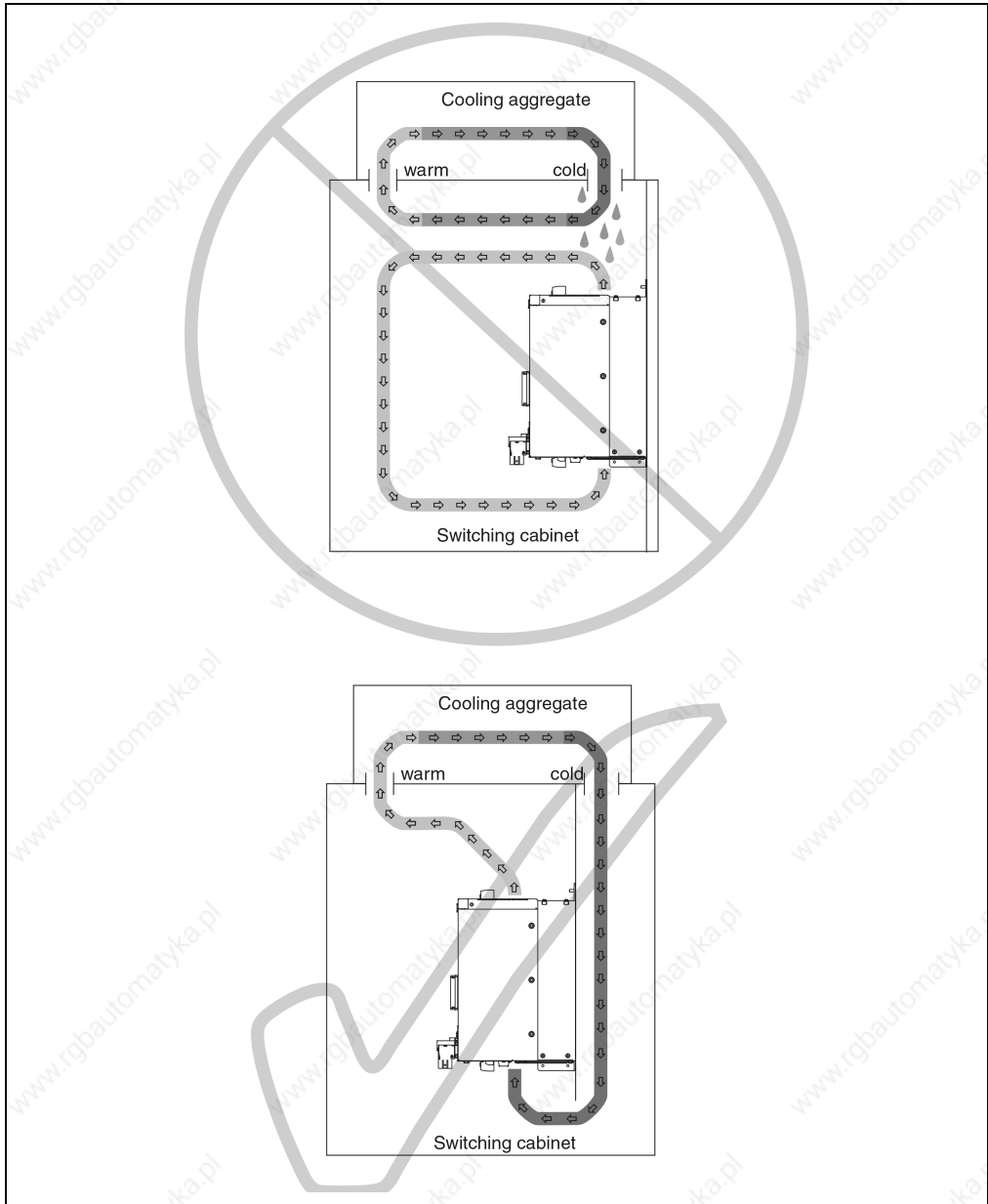

Figure 15: Cooling aggregate on top of the switching cabinet

Cooling aggregate on the front of the switching cabinet

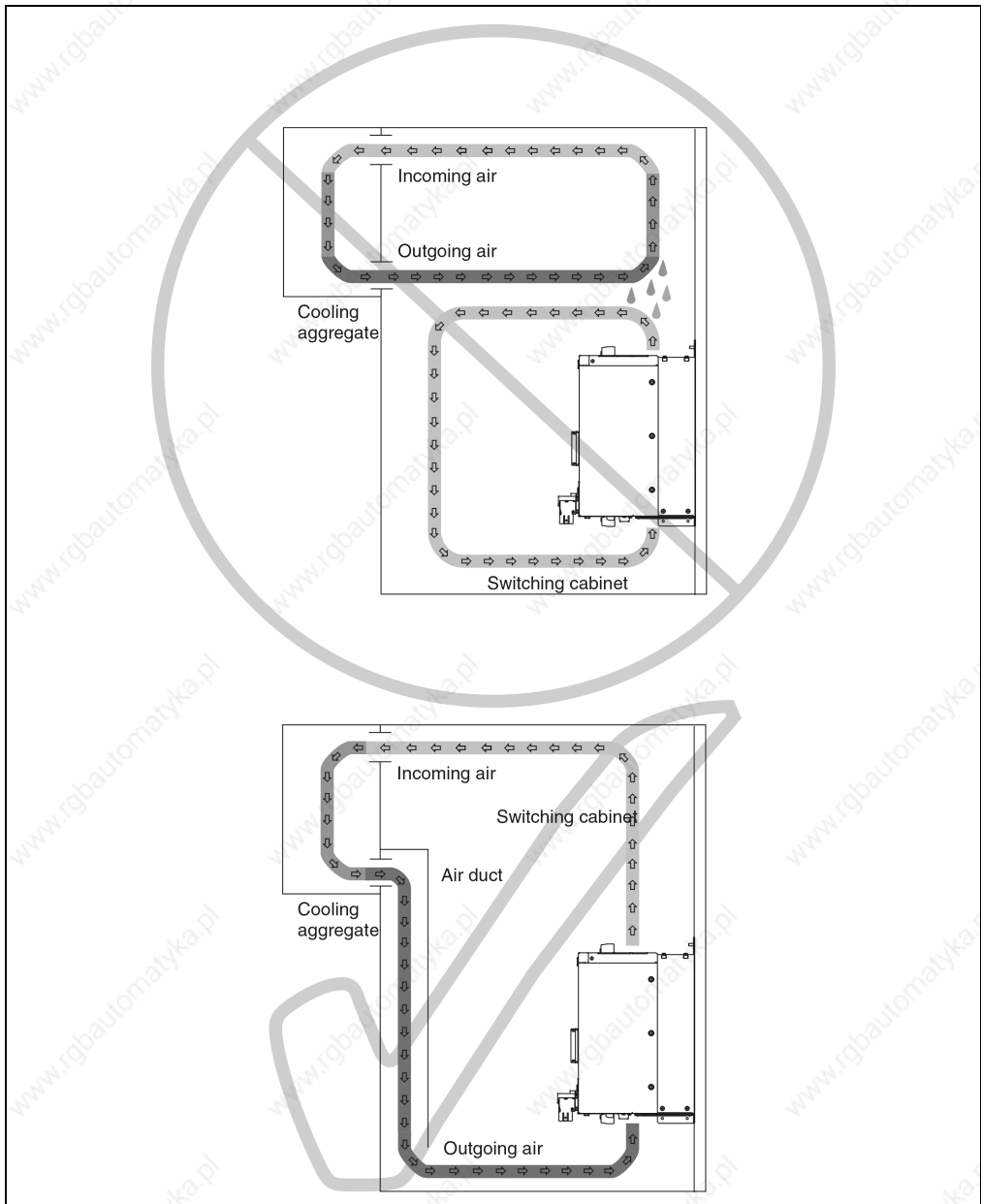

Figure 16: Cooling aggregate on the front of the switching cabinet

CHAPTER 4 • DIMENSIONING

1. Power Mains Connection

1.1 General Information

1.1.1 System Configuration

The power mains connection is made using terminals X3 / L1, L2, L3 and PE. The ACOPOS servo drives can be directly connected to TT and TN systems (these are three-phase systems with grounded neutral).

When using ungrounded IT systems (three-phase systems without grounded neutral), isolation transformers must be used. The secondary neutral must be grounded and connected to the ACOPOS protective ground conductor. In this way, it is possible to prevent overvoltages between external conductors and the ACOPOS housing. Three-phase isolation transformers with the corresponding input and output voltages and a vector group with secondary neutral can be used (e.g. 3 x 400 V / 3 x 400 V, Dyn3).

Danger!

The ACOPOS servo drives are only allowed to be operated directly on grounded, three-phase industrial mains (TN, TT systems). When using the servo drives in living areas, shops and small businesses, additional filtering measures must be implemented by the user.

1.1.2 Supply Voltage Range

The permissible supply voltage range for ACOPOS servo drives is 3 x 400 VAC to 3 x 480 VAC $\pm 10\%$. Respective intermediate transformers must be used for other supply voltages. With grounded power mains, autotransformers can also be used to adjust the voltage. Neutral does not have to be connected for this type of transformer.

1.1.3 Protective Ground Connection (PE)

The following information concerning the protective ground connection corresponds to IEC 61800-5 (draft), Item 3.2.5.3 "Connection elements for the protective ground conductor" and must be followed.

Wire Cross Section

The wire cross section for the protective ground conductor is oriented to the external conductors and must be selected according to the following table:

Wire Cross Section for External Line A [mm ²]	Minimum Wire Cross Section for Protective Ground Connection A _{PE} [mm ²]
A ≤ 16	A
16 < A ≤ 35	16
35 < A	A / 2

Table 38: Selection of the protective ground conductor cross section

Increased Discharge Current

ACOPOS servo drives are devices with increased discharge current (larger than 3.5 mA AC or 10 mA DC). Therefore a fixed (immobile) protective ground connection is required on the servo drives.

The following conditions must be met, depending on the ACOPOS device being used:

ACOPOS	Conditions	Image
1022 1045 1090	In addition to the connection of the first protective ground conductor on terminal X3 / PE, a second protective ground conductor with the same cross section must be connected on the designated terminal (threaded bolt M4).	
1640 128M	The cross section of the protective ground conductor connected to terminal X3 / PE must be at least 10 mm ² Cu.	

Table 39: Protective ground conditions according to ACOPOS device

1.2 Dimensioning

In general, dimensioning the power mains, the overcurrent protection and the line contactors depend on the structure of the power mains connection. The ACOPOS servo drives can be connected individually (each drive has separate overcurrent protection and, if necessary, a separate line contactor) or together in groups.

1.2.1 Individual ACOPOS Power Mains Connections

The structure of an individual power mains connection with line contactor and circuit breaker can be seen in the following diagram:

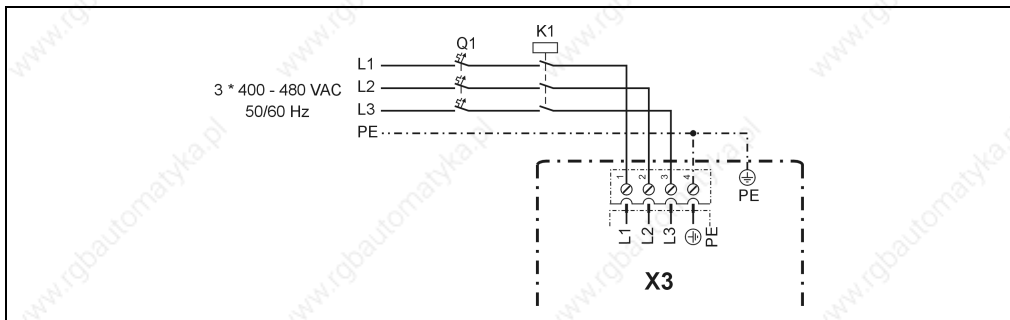

Figure 17: Circuit diagram for ACOPOS X3, individual power mains connection

Dimensioning the Power Mains and Overcurrent Protection

The cross section of the power mains and the rated current for overcurrent protection should be dimensioned for the average current load to be expected.

The power mains are to be equipped with overcurrent protection in the form of a circuit breaker or a fuse. Circuit breakers (time lag) with type C tripping characteristics (according to IEC 60898) or fuses (time lag) with type gM tripping characteristics (according to IEC60269-1) are to be used. ¹⁾

The average current load to be expected can be calculated as follows:

$$I_{\text{mains}}[\text{A}] = \frac{S[\text{VA}]}{\sqrt{3} \cdot U_{\text{mains}}[\text{V}]}$$

The apparent power S can be calculated as follows:

$$S[\text{VA}] = M_{\text{eff}}[\text{Nm}] \cdot k \cdot \frac{2 \cdot \pi \cdot n_{\text{aver}}[\text{min}^{-1}]}{60} \quad 2)$$

ACOPOS	k
1022	2.8
1045	2.4
1090	2.4
1640	1.7
128M	1.5

Table 40: Constant k

- 1) Circuit breakers are available on the market with rated currents from 6 A to 63 A. Outside of this range, fuses must be used.
- 2) If information concerning load torque, inertia and friction are available, the effective torque is calculated as follows:

$$M_{\text{eff}}[\text{Nm}] = \sqrt{\frac{1}{T_{\text{cycle}}[\text{s}]} \sum M_i[\text{Nm}]^2 \cdot t_i[\text{s}]}$$

If the motor is dimensioned correctly, the nominal torque for the selected motor can also be used here.

The cross section of the power mains and the rated current of the overcurrent protection used are chosen according to Table 41, "Maximum current load for PVC insulated three-phase cables or individual wires", on page 85 so that the maximum current load for the cable cross section selected is greater than or equal to the calculated mains current.

$$I_Z \geq I_{\text{mains}}$$

The rated current of the overcurrent protection must be less than or equal to the maximum current load for the cable cross section selected (see Table 41, "Maximum current load for PVC insulated three-phase cables or individual wires", on page 85).

$$I_B \leq I_Z$$

The following table shows the maximum current load of PVC insulated three-phase cables (or three current-carrying wires) according to IEC60204-1 at 40 °C environmental temperature ¹⁾ and 70 °C maximum conductor temperature (maximum current load for installation type F and cross sections greater than 35 mm², IEC60364-5-523 is used for installation types B1 and B2).

Wire Cross Section [mm ²]	Installation Types				
	Three individual wires in insulating conduit or cable duct B1	Three-phase cable in insulating conduit or cable duct B2	Three-phase cable on walls C	Three-phase cable in a cable tray E	Three individual wires in a cable tray F
	Maximum current load for the cable cross section I_Z / rated current for the overcurrent protection I_B [A]				
1,5	13.5 / 13	12.2 / 10	15.2 / 13	16.1 / 16	---
2,5	18.3 / 16	16.5 / 16	21 / 20	22 / 20	---
4	25 / 25	23 / 16	28 / 25	30 / 25	---
6	32 / 32	29 / 25	36 / 32	37 / 32	---
10	44 / 32	40 / 32	50 / 50	52 / 50	---
16	60 / 50	53 / 63	66 / 63	70 / 63	---
25	77 / 63	67 / 63	84 / 80	88 / 80	96 / 80
35	97 / 80	83 / 80	104 / 100	114 / 100	119 / 100
50	117 / 100	103 / 100	123 / 100	123 / 100	145 / 125
70	149 / 125	130 / 125	155 / 125	155 / 125	188 / 160
95	180 / 160	156 / 125	192 / 160	192 / 160	230 / 200

Table 41: Maximum current load for PVC insulated three-phase cables or individual wires

1) The maximum current load value in IEC60204-1 is for an environmental temperature of 40 °C. In IEC60364-5-523, this reference temperature is 30 °C. The values in Table 41, "Maximum current load for PVC insulated three-phase cables or individual wires", on page 85 from IEC60364-5-523 are calculated with the factor $k_{T_{\text{emp}}} = 0.87$ given in the standard and also at 40 °C.

When determining the cross section for the power mains, make sure that the cross section selected is within the range that can be used with power mains terminal X3 (see Chapter 5 "Wiring", Table 48, "Terminal cross sections for ACOPOS servo drives", on page 107).

Dimensioning the Line Contactor

The rated current of the line contactor is oriented to the overcurrent protection for the power mains connection. The line contactor is selected so that the maximum current load is approximately 1.3 times the rated current of the overcurrent protection.

1.2.2 Implementing ACOPOS Power Mains Connections for Drive Groups

The structure of the power mains connection for a drive group with line contactor and circuit breaker can be seen in the following diagram:

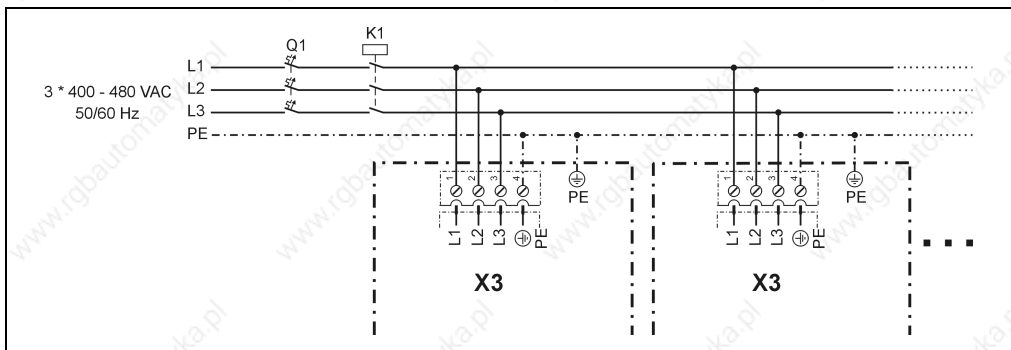

Figure 18: Circuit diagram for ACOPOS X3, power mains connection for a drive group

Dimensioning the Power Mains and Overcurrent Protection

The cross section of the distribution point and all power mains connections are chosen according to Table 41, "Maximum current load for PVC insulated three-phase cables or individual wires", on page 85 so that the maximum current load for the cable cross section selected ¹⁾ is greater than or equal to the sum of the calculated mains current.

$$I_Z \geq \sum I_{\text{mains}}$$

The rated current of the overcurrent protection must be less than or equal to the maximum current load for the cable cross section selected (see Table 41, "Maximum current load for PVC insulated three-phase cables or individual wires", on page 85).

$$I_B \leq I_Z$$

1) When determining a common cross section for several drives (especially with different sized ACOPOS modules), make sure that the cross section selected is within the range that can be used with the power mains terminals (see Chapter 5 "Wiring", Table 48, "Terminal cross sections for ACOPOS servo drives", on page 107).

Dimensioning the Line Contactor

The rated current of a common line contactor is oriented to the overcurrent protection for the power mains connection. The line contactor is selected so that the maximum current load is approximately 1.3 times the rated current of the overcurrent protection.

1.3 Fault Current Protection

Fault current protection (RCD - residual current-operated protective device) can be used with ACOPOS servo drives. However the following points must be noted:

ACOPOS servo drives have a power rectifier. If a short-circuit to the frame occurs, a flat DC fault current can be created which prevents an AC current or pulse current sensitive RCD (Type A or AC) from being activated, therefore canceling the protective function for all connected devices.

Danger!

If used for protection during direct or indirect contact of the fault current protection (RCD), only a Type B RCD (AC-DC sensitive, according to IEC 60755) can be used for the ACOPOS power mains connection. Otherwise additional protective measures must be used, such as neutralization or isolation from the power mains using an isolation transformer.

1.3.1 Rated Fault Current

On ACOPOS servo drives, fault current protection with a rated fault current ¹⁾ of ≥ 100 mA can be used. However, errors can occur:

- When connecting servo drives to the power mains (short-term single-phase or two-phase operation because of contact chatter on the line contactor).
- Because of high frequency discharge currents occurring during operation when using long motor cables.
- Because of an extreme unbalance factor for the three-phase system.

1) The rated fault current listed by the manufacturer are maximum values which will definitely trip the protective device. Normally, the protective device is tripped at approximately 60 % of the rated fault current.

1.3.2 Estimating the Discharge Current

Depending on the connection of the ACOPOS servo drive, different discharge currents flow to ground on the protective ground conductor (PE):

Single-phase or two-phase operation (as intermediate state when switching on the line contactor):

$$I_A[A] = \frac{U_{\text{mains}}[V] \cdot 2 \cdot \pi \cdot f_{\text{mains}}[\text{Hz}] \cdot C_D[F]}{\sqrt{3}}$$

Single-phase operation with neutral (lab or test operation):

$$I_A[A] = \frac{U_{\text{mains}}[V] \cdot 2 \cdot \pi \cdot f_{\text{mains}}[\text{Hz}] \cdot C_D[F]}{2 \cdot \sqrt{3}}$$

ACOPOS	C _D [nF]
1022, 1045, 1090	660
1640, 128M	... 1)

Table 42: Discharge capacitance C_D

1) Integrated line filter in preparation.

1.3.3 Manufacturer Used

For example, the AC-DC sensitive, 4 pin fault current protective device F 804 from ABB (fault current: 300 mA; nominal current: 63 A) can be used. Using this fault current protective device, approximately 5 ACOPOS 1022 (or 1045, 1090) can be connected in parallel.

2. DC Bus

2.1 General Information

With ACOPOS servo drives, it is possible to connect several servo drives via the DC bus ¹⁾. This connection allows compensation of brake and drive energy of several axes or the distribution of brake energy to several braking resistors.

The connection is made using terminals X2 / +DC and -DC. The structure of the DC bus connections can be seen in the following diagram:

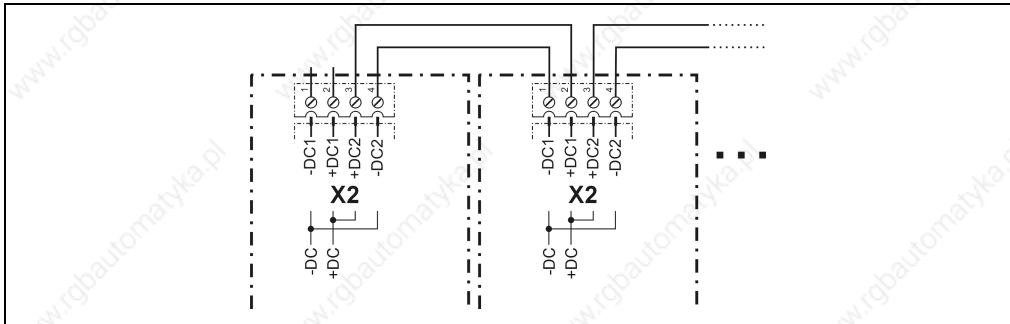

Figure 19: ACOPOS X2 circuit diagram, DC bus connections

Caution!

To prevent excessively high discharge currents from flowing over the individual servo drives, make sure that smaller servo drives are not connected between two larger servo drives.

1) The connection of the DC bus for several ACOPOS 1022, 1045 or 1090 modules is only possible within combined groups (also see Section 1.2.2 "Implementing ACOPOS Power Mains Connections for Drive Groups"). With ACOPOS 1640 and 128M modules, it is also possible to connect individual ACOPOS servo drives because of built-in phase and power mains monitoring.

2.2 Wiring

The DC bus connections on the ACOPOS servo drives do **not** have short circuit and ground fault protection and are not protected against reverse polarity. Therefore the DC bus connections must be wired correctly.

Caution!

The DC bus connections must be wired correctly (no short circuits, ground faults or reverse polarity).

A suitable measure to ensure that the wiring is secure against short circuits and ground faults ¹⁾ is the use of corresponding cabling. Special rubber-insulated wires with increased resistance to heat (90 °C) of types

- NSGAÖU
- NSGAFÖU
- NSGAFCMÖU

with a nominal voltage U_0/U of at least 1.7/3 kV are considered to be secure against short circuits and ground faults in switchgear and distribution systems up to 1000 V ²⁾.

1) Cabling e.g. according to DIN VDE 0100, part 200 "Electrical systems for buildings - terms", item A.7.6.

2) See e.g. DIN VDE 0298, part 3 "Use of cables and insulated wires for high-voltage systems", item 9.2.8.

2.3 Equal Distribution of the Applied Power via the Power Rectifiers

When creating a DC bus connection between several servo drives, it is possible that the parallel connection of the power rectifiers causes incorrect distribution of the applied power. To prevent this undesired effect, appropriately dimensioned shunt resistors are integrated in the ACOPOS servo drives.

The following rules must be observed so that the effect of these shunt resistors is not cancelled out:

- The length of the DC bus wiring is not allowed to exceed a total length of 3 m and must be within a single switching cabinet.
- Dimensioning the cross section of the ACOPOS servo drive power mains must be done according to Section "Dimensioning the Power Mains and Overcurrent Protection".
- The cross section of the DC bus wiring ¹⁾ on the respective ACOPOS servo drives must be less than or equal to the cross section of the servo drive power mains.
- The selected cross section must be within the range possible for the DC bus connection terminal X2 (see chapter 5 "Wiring", Table 48, "Terminal cross sections for ACOPOS servo drives", on page 107).

2.4 Equal Distribution of the Brake Power on the Braking Resistors

The braking resistors integrated in the ACOPOS servo drives as well as braking resistors which can be connected externally are controlled using a specially developed procedure. This guarantees that the brake power is optimally and equally distributed on the braking resistors when a DC bus connection is made between several units.

When using the integrated braking resistors, additional configuration is not required. When using external braking resistors, the corresponding parameters must be defined (see Section 4.4 "Setting Brake Resistor Parameters").

- 1) The cross section of the individual segments of the DC bus wiring must be dimensioned for the thermal equivalent effective value of the respective compensation current. If information concerning the flow of the compensation current is available, calculate the thermal equivalent effective value of the compensation current using

$$I_q [A] = \sqrt{\frac{1}{T_{\text{cycle}} [s]} \sum I_i [A]^2 \cdot t_i [s]}$$

The cross section of the DC bus wiring should then be selected as described in chapter 5 "Wiring", Table 48, "Terminal cross sections for ACOPOS servo drives", on page 107 so that the maximum current load of the cable cross section is greater than or equal to the thermal equivalent effective value of the compensation current ($I_z \geq I_q$).

3. Motor Connection

On B&R motors, the power connections, the connections for the holding brake and the connections for the motor temperature sensor are all made using the same motor plug. On the servo drive, the motor connection is made using terminals X4 / U, V, W and PE as well as terminals X5 / B+, B-, T+ and T-. The motor connection must be shielded correctly (see chapter 5 "Wiring", Section 1.1 "Electromagnetic Compatibility of the Installation").

The structure of the motor connection can be seen in the following diagram:

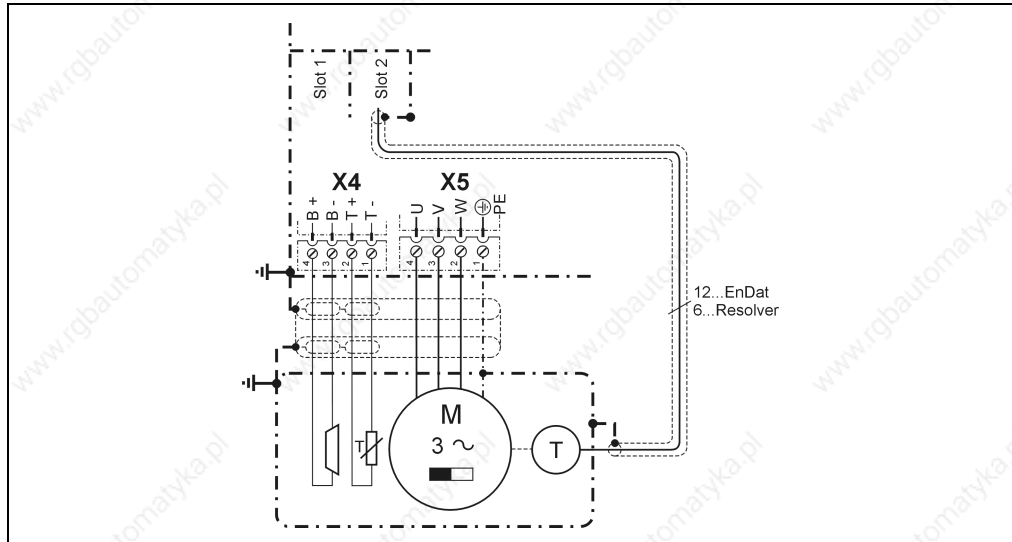

Figure 20: ACOPOS X4/X5 circuit diagram, motor connection

The cross section of the motor cable must be dimensioned for the thermal equivalent effective value of the motor current ¹⁾. If the motor is dimensioned correctly, the nominal current for the motor can also be used here.

1) If information concerning load torque, inertia and friction are available, the thermal equivalent effective value for the motor current of the motor used is calculated as follows:

$$I_q[\text{A}] = \sqrt{\frac{1}{T_{\text{cycle}}[\text{s}]} \sum I_i[\text{A}]^2 \cdot t_i[\text{s}]}$$

The cross section of the motor cable is chosen for B&R motor cables according to the following table so that the maximum current load for the cable cross section selected is greater than or equal to the thermal equivalent effective value of the motor current.

$$I_z \geq I_q$$

The following table shows the maximum current load for special insulated three-phase cables according to IEC60364-5-523 at 40 °C environmental temperature ¹⁾ and 90 °C maximum cable temperature.

Wire Cross Section [mm ²]	Installation Types		
	Three-phase cable in insulating conduit or cable duct B2	Three-phase cable on walls C	Three-phase cable in a cable tray E
	Maximum current load of the cable I _z [A]		
1,5	17.8	20	20.9
4	31.9	36.4	38.2
10	54.6	64.6	68.3
35	116.5	133.8	143.8

Table 43: Maximum current load for special insulated three-phase cables

When determining the cross section for the motor cable, make sure that the cross section selected is within the range that can be used with motor connection terminal X5 (see Chapter 5 "Wiring", Table 48, "Terminal cross sections for ACOPOS servo drives", on page 107).

1) The entry for the maximum current load in IEC60364-5-523 is for an environmental temperature of 30 °C. The values in Table 43, "Maximum current load for special insulated three-phase cables", on page 93 are calculated with the factor $k_{Temp} = 0.91$ given in the standard for use at 40 °C environmental temperature.

4. Braking Resistor

4.1 General Information

When braking servo motors, power is returned to the servo drive. This causes the capacitors in the DC bus to be charged to higher voltages. Starting with a DC bus voltage of approx. 800 V, the ACOPOS servo drive links the braking resistor to the DC bus using the brake chopper and converts the braking power to heat.

For ACOPOS servo drives, braking resistors are integrated for this purpose or external braking resistors can be connected. The equipment differences can be found in the following table:

	8V1022.00-1	8V1045.00-1 8V1090.00-1	8V1640.00-1	8V128M.00-1
Integrated Brake Chopper	Yes	Yes	Yes	Yes
Internal Braking Resistor	Yes	Yes	Yes ¹⁾	Yes ¹⁾
Continuous Power Output	130 W	200 W	200 W	240 W
Maximum Power	3.5 kW	7 kW	7 kW	8.5 kW
Connection of External Braking Resistor Possible ²⁾	No ⁴⁾	No ⁴⁾	Yes	Yes
Continuous Power Output	---	---	24 kW	24 kW
Maximum Power	---	---	250 kW	250 kW
Minimum Braking Resistor Value ($R_{BR_{min}}$)	---	---	2.5 Ω	2.5 Ω
Rated Current of the Built-in Fuse ³⁾ (I_B)	---	---	30 A (fast-acting)	30 A (fast-acting)

Table 44: Braking resistors for ACOPOS servo drives

1) The braking resistor integrated in the ACOPOS servo drives 1640 and 128M is dimensioned so that it is possible to brake to a stop (in a typical drive situation).

2) The ACOPOS servo drives are designed so that either the integrated braking resistor **or** the external braking resistor can be activated. Braking with both braking resistors at the same time is not possible. Switching takes place using the software and is only possible during the servo drive initialization phase:

ParID 398: Switching to internal / external braking resistor
 1 ... external
 0 ... internal (default)

3) The fuses used must be fast-acting fuses $\varnothing 10 \times 38$ mm for 600 V AC/DC. For example, type KLKD0xx (xx is the rated current of the fuse in amperes e.g. KLKD030) from Littelfuse (www.littelfuse.com) can be used.

4) The braking resistors integrated in ACOPOS servo drives 1022, 1045 and 1090 are optimally dimensioned for the respective sizes.

4.2 Braking Resistor Connection

The external braking resistors are connected using terminals X6 / RB+, RB- and PE. The structure of the braking resistor connection can be seen in the following diagram:

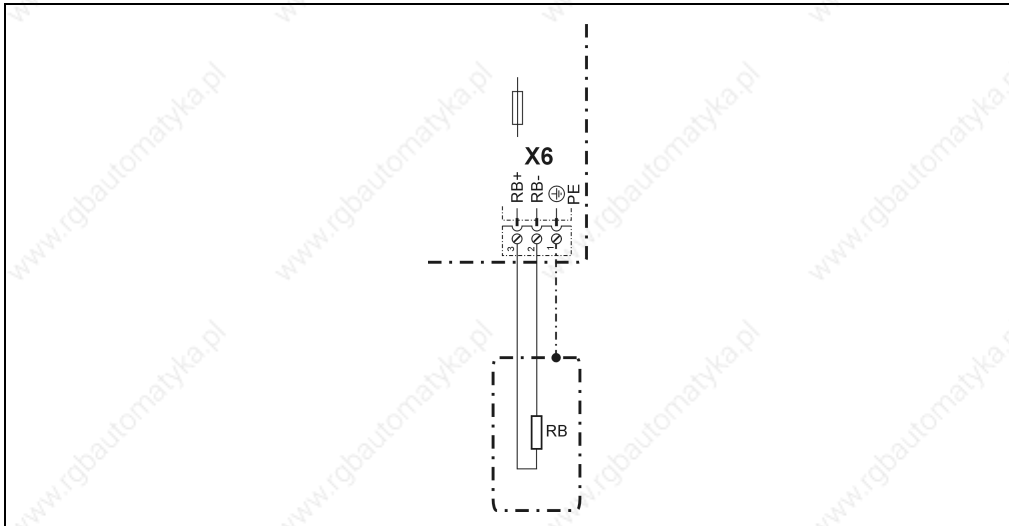

Figure 21: Circuit diagram for ACOPOS X6, external braking resistor on ACOPOS 1640 and 128M

When determining the cross section ¹⁾ for the braking resistor connection, make sure that the cross section selected is within the range that can be used with braking resistor connection terminal X6 (see Chapter 5 "Wiring", Table 48, "Terminal cross sections for ACOPOS servo drives", on page 107).

- 1) The cross section of the braking resistor cable must be dimensioned for the thermal equivalent effective value of the respective brake current. If information concerning the flow of the brake current is available, calculate the thermal equivalent effective value of the brake current using

$$I_q[\text{A}] = \sqrt{\frac{1}{T_{\text{cycle}}[\text{s}]} \sum I_i[\text{A}]^2 \cdot t_i[\text{s}]}$$

The cross section of the braking resistor connection should then be selected as described in Table 41, "Maximum current load for PVC insulated three-phase cables or individual wires", on page 85, so that the maximum current load of the cable cross section is greater than or equal to the thermal equivalent effective value of the brake current ($I_Z \geq I_q$).

4.3 Dimensioning the Brake Resistor

Like other drive components, the externally connected braking resistors must be dimensioned according to the requirements of the application.

To determine the required braking power ($P_{Br\ max}$ and $P_{Br\ aver}$), the mechanical values $M(t)$, $\omega(t)$, T_{cycle} must be known. The following formulas are used to determine the drive power curve.

$$P(t)[W] = M(t)[Nm] \cdot \omega(t)[rad \cdot s^{-1}]$$

$$\omega(t)[rad \cdot s^{-1}] = 2 \cdot \pi \cdot \frac{n(t)[min^{-1}]}{60[s \cdot min^{-1}]}$$

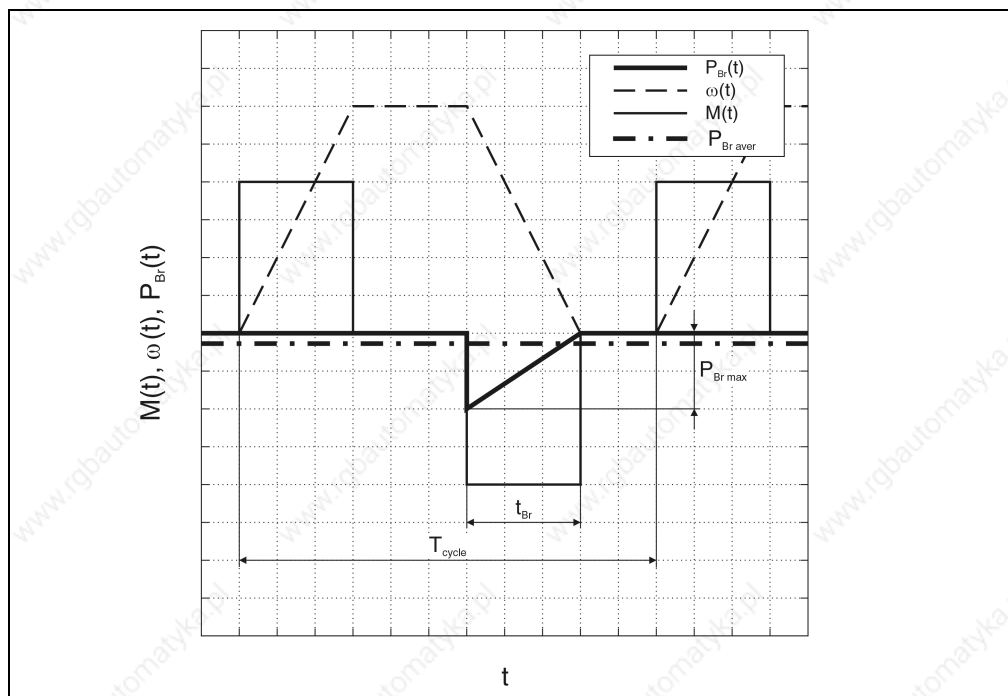

Figure 22: Diagram of a typical movement with the brake power curve $P_{Br}(t)$ ¹⁾

- 1) If - as shown - a typical triangular brake power curve occurs, then the average brake power can be calculated directly with the following formula:

$$P_{BR\ aver} [W] = \frac{1}{T_{cycle}[s]} \cdot \frac{P_{Br\ max} \cdot t_{Br}}{2}$$

The calculation is continued by deriving the brake power curve $P_{Br}(t)$ from the drive power curve. The power must be set to zero in areas where it is positive ($P(t) > 0$). This results in the following maximum brake power

$$P_{Br_{max}} [W] = \text{abs}(\max(P_{Br}(t)[W]))$$

Then the average brake power is calculated over the given cycle

$$P_{Br_{aver}} [W] = \frac{1}{T_{cycle}[s]} \sum P_{Br_i}(t)[W] \cdot t_i[s]$$

In order to use an external braking resistor ¹⁾, the following parameters must be calculated:

- the resistance (R_{Br})
- the maximum power ($P_{R_{Br_{max}}}$)
- the nominal power ($P_{R_{Br_N}}$)

Resistance of the Braking Resistor

The resistance of the braking resistor R_{Br} can be calculated as follows:

$$R_{Br}[\Omega] = \frac{U_{DC}[V]^2}{P_{Br_{max}}[W]} = \frac{800[V]^2}{P_{Br_{max}}[W]}$$

The selected resistance is not allowed to be less than the **minimum** resistance for the respective ACOPOS servo drive (see Table 44, "Braking resistors for ACOPOS servo drives", on page 94).

$$R_{Br}[\Omega] \geq R_{Br_{min}}[\Omega]$$

If this condition is not met, the maximum brake power required cannot be reached! Typical resistances are 4 - 50 Ω depending on the size of the ACOPOS device.

Caution!

If a resistance less than the minimum resistance is used, the brake chopper built into the ACOPOS device could be destroyed!

1) Reliable braking resistors are available from Danotherm (www.danotherm.com).

Then the following calculation

$$P_{Br_{aver}} [W] \leq R_{Br} [\Omega] \cdot I_B [A]^2$$

must be made to check if the average continuous power for the brake can be reached with the selected braking resistor on the ACOPOS servo drive. The brake power which can be continually output by the ACOPOS device is limited by the built-in fuse (rated current of the built-in fuse, see Table 44, "Braking resistors for ACOPOS servo drives", on page 94).

Power Data for the Braking Resistor

The maximum power that the braking resistor must be able to dissipate is calculated as follows:

$$P_{R_{Br_{max}}} [W] \geq P_{Br_{max}} [W]$$

The nominal power (the power which can be continually dissipated) for the braking resistor is calculated using the following formulas:

$$P_{R_{Br_N}} [W] \geq P_{Br_{aver}}$$

$$P_{R_{Br_N}} [W] \geq \frac{1}{30} \cdot P_{R_{Br_{max}}} [W]$$

The second condition depends on ACOPOS internal relationships.

4.4 Setting Brake Resistor Parameters

The braking resistors integrated in the ACOPOS servo drives as well as braking resistors which can be connected externally are controlled using a specially developed procedure. This guarantees that the brake power is optimally and equally distributed on the braking resistors when a DC bus connection is made between several units.

When using the integrated braking resistors, additional configuration is not required. When using external braking resistors, the following resistor data must be known:

Resistor Data	Term	Unit
Continuous power for the resistance	$P_{R_{BrN}}$	[W]
Maximum power for the resistance	$P_{R_{Brmax}}$	[W]
Ohmic resistance	R_{Br}	[Ω]
Maximum switch on time at maximum power		[s]
Maximum temperature of the resistor ¹⁾		[$^{\circ}$ C]

Table 45: Resistor data when using external braking resistors

1) If available.

Then the parameters to be set on the ACOPOS servo drive can be determined with the configuration tool RESISTPARAM.XLS.

ParID 10:	Ohmic resistance	[W]
ParID 11:	Max. temperature of the resistor.	[$^{\circ}$ C]
ParID 12:	Thermal resistance	[$^{\circ}$ C/W]
ParID 13:	Heat capacity of the resistor	[Ws/ $^{\circ}$ C]

5. Current Consumption of ACOPOS Plug-in Modules

The plug-in modules for ACOPOS servo drives allow the servo drives to be individually configured according to the requirements of the application. When putting together plug-in module combinations, the power consumption must be checked.

The maximum power output for all 4 slots is 22 W. The total power consumption for all plug-in modules must be less than or equal to the maximum power output.

$$P_{\max} = 22\text{W} \geq \sum P_{\text{module}}$$

The power consumption of the individual modules can be found in the technical data for the modules (see chapter 2 "Technical Data").

6. Formula Variables Used

Term	Unit	Product ID
C_D	F	Discharge capacitance for ACOPOS 1022, 1045, 1090 $C_D = 660 \text{ nF}$ for ACOPOS 1064, 128M --- ¹⁾
f_{mains}	Hz	Mains frequency
I_A	A	Discharge current via protective ground conductor (PE)
I_B	A	Rated current for overcurrent protection
I_{mains}	A	Mains current (phase current)
I_q	A	Thermal equivalent current effective value
I_Z	A	Maximum current load on a cable
M	Nm	Torque (general)
M_{eff}	Nm	Effective load torque
n	min^{-1}	Speed (general)
n_{aver}	min^{-1}	Average speed
ω	rad/s	Angular speed
P	W	Power or true power (general)
P_{Br}	W	Brake power
P_{Brmax}	W	Maximum brake power
P_{Braver}	W	Average brake power
P_{RBrmax}	W	Maximum load on the external braking resistor
P_{RBrN}	W	Nominal power of the external braking resistor
P_{max}	W	Maximum power
P_{module}	W	Power consumption of the plug-in modules
π	---	Pi (3.1415)
R_{Br}	Ω	Braking resistance
R_{Brmin}	Ω	Minimum braking resistance
S	VA	Apparent power
t	s	Time (general)
t_{Br}	s	Brake time
T_{cycle}	s	Cycle time
U_{DC}	V	DC bus voltage
U_{mains}	V	Supply voltage (phase to phase)

Table 46: Formula variables used

1) Integrated line filter in preparation.

CHAPTER 5 • WIRING

1. General Information

1.1 Electromagnetic Compatibility of the Installation

1.1.1 General Information

Servo drives are electrical equipment intended for use in industrial and commercial systems. ACOPOS servo drives meet the requirements for adherence to the EMC guideline 89/336/EWG regarding electromagnetic compatibility of the installation. Under the terms of the EMC guidelines, such devices do not require certification because they are intended to be further processed by the competent, machine and equipment manufacturer in compliance with the EMCG components and cannot be operated independently.

Evidence of compliance with the limit values required in the EMC guidelines must be provided by the manufacturer or the machine or system operator.

ACOPOS servo drives fulfill the requirements of IEC 61800-3 (industry – 2nd environment) in regard to disturbance immunity and emitted disturbance.

When using the servo drives in living areas, shops and small businesses, additional filtering measures must be implemented by the user.

1.1.2 Installation Notes

- The switching cabinet or the system must be constructed appropriately.
- In order to avoid disturbances,
 - motor cables
 - encoder cables
 - control cables
 - data cablesare to be properly shielded.
- Inductive switching elements such as contactors or relays are to be equipped with corresponding suppressor elements such as varistors, RC elements or damping diodes.
- All electrical connections are to be kept as short as possible.
- Cable shields are to be attached to the designated shield terminals and the plug housing.
- Shielded cables with copper mesh or tinned copper mesh are to be used. Twisting or extending the protective mesh using single conductors is not allowed.
- Unused cable conductors are to be grounded on both sides if possible.

The ground connections and shield connections have to be made as illustrated in the following diagram.

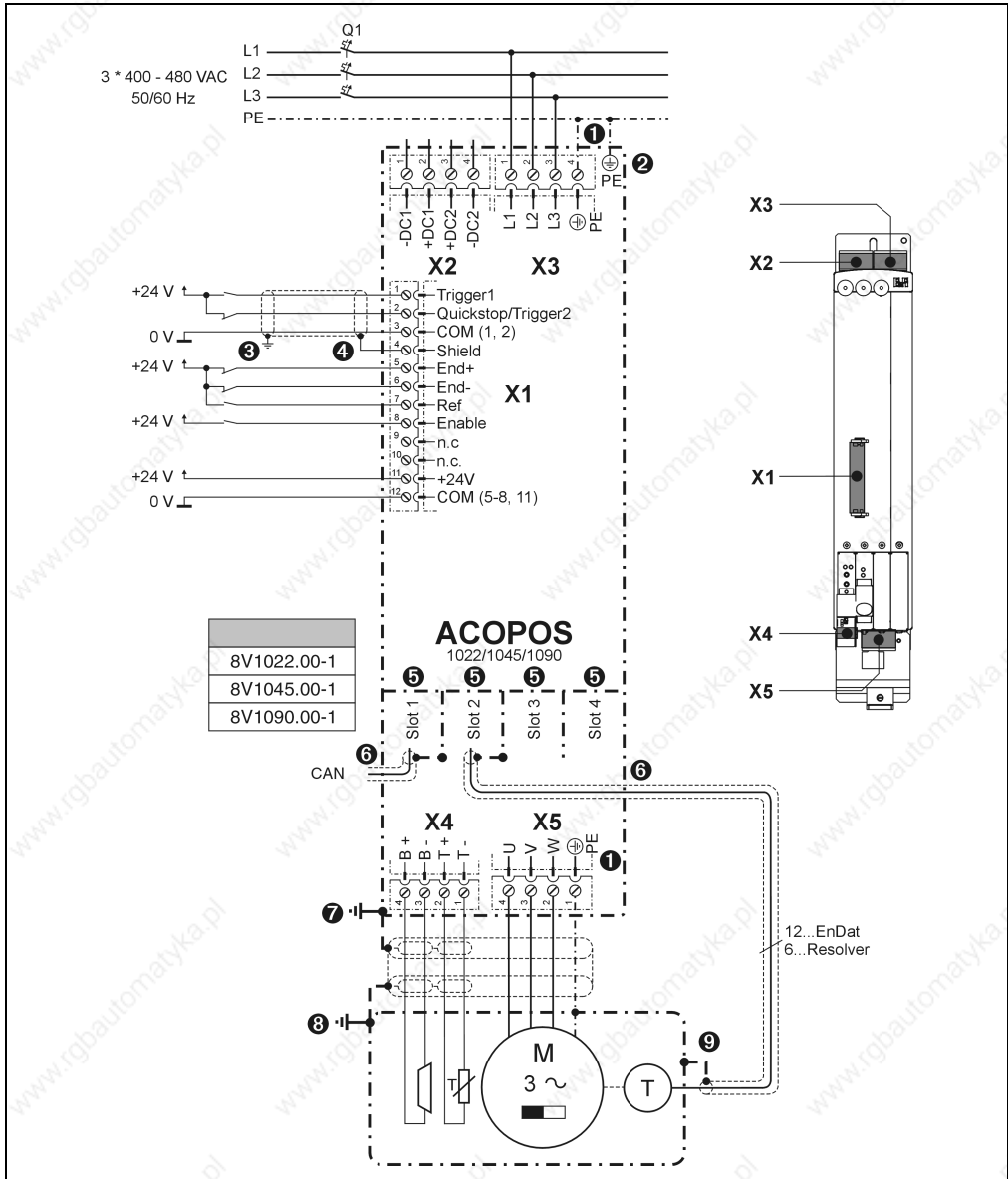

Figure 23: Connection diagram for ground and shield connections

- ❶ The protective ground conductor for the power mains (PE) and the protective ground conductor for the motor lines are internally connected with the housing of the ACOPOS servo drive.
 - ❷ The second protective ground conductor connection is required because of the increased discharge current (>3.5 mA) on the ACOPOS servo drives 1022, 1045 and 1090. The same cross section as the protective ground conductor for the power mains must be used.
 - ❸ The two trigger inputs only internally filter disturbances up to approx. 50 µs, therefore proper grounding of the cable shields is important.
 - ❹ The cable shield must be connected to the designated terminal.
 - ❺ On all plug-in modules, the two screws used to fasten the module must be tightened so that the mounting bracket is connected to ground.
 - ❻ Cable connection via DSUB plug:
The cable shield must be connected using the designated clamp in the metallic or metal plated plug housing. The plug housing must be fastened to the designated device connector using safety screws.
- Cable connection via terminals:
The cable shield must be connected to the designated terminal.
- ❼ The cable shield for the motor line is connected with the ACOPOS housing via the grounding plate using the grounding clamp provided:

Shield connection for the motor cable using grounding clamps	
1022, 1045, 1090	1640, 128M
	

Table 47: Grounding the motor cable

- ❽ On the motor side, the cable shield is connected to the motor housing using the motor plug and connected to ground via the machine.
- ❾ On the motor side, the encoder cable shield is connected to the motor housing using the encoder plug and connected to ground via the machine.

1.2 Overview of the Terminal Cross Sections

Terminal Cross Sections		8V1022.00-1 8V1045.00-1 8V1090.00-1		8V1640.00-1		8V128M.00-1	
		[mm ²]	[AWG]	[mm ²]	[AWG]	[mm ²]	[AWG]
X1	Solid core and multiple conductor lines	0.14 - 1.5	28 - 16	0.14 - 1.5	28 - 16	0.14 - 1.5	28 - 16
	Flexible and fine wire lines without Wire Tip Sleeves with Wire Tip Sleeves	0.14 - 1.5 0.25 - 0.5	28 - 16 23 - 20	0.14 - 1.5 0.25 - 0.5	28 - 16 23 - 20	0.14 - 1.5 0.25 - 0.5	28 - 16 23 - 20
	Approval Data UL/C-UL-US CSA	--- ---	30 - 16 28 - 16	--- ---	30 - 16 28 - 16	--- ---	30 - 16 28 - 16
Terminal tightening torque value [Nm]		0.22 ... 0.25		0.22 ... 0.25		0.22 ... 0.25	
X2 DC Bus	Solid core and multiple conductor lines	0.2 - 4	24 - 10	10 - 25	7 - 3	10 - 50	7 - 0
	Flexible and fine wire lines without Wire Tip Sleeves with Wire Tip Sleeves	0.2 - 4 0.25 - 4	24 - 10 23 - 10	4 - 16 4 - 16	11 - 5 11 - 5	10 - 35 10 - 35	7 - 2 7 - 2
	Approval Data UL/C-UL-US CSA	--- ---	30 - 10 28 - 10	--- ---	12 - 4 14 - 4	--- ---	10 - 2 12 - 2
Terminal tightening torque value [Nm]		0.5 ... 0.6		2.5 ... 3		2.5 ... 3	
X3 Power Mains	Solid core and multiple conductor lines	0.2 - 4	24 - 10	10 - 25	7 - 3	10 - 50	7 - 0
	Flexible and fine wire lines without Wire Tip Sleeves with Wire Tip Sleeves	0.2 - 4 0.25 - 4	24 - 10 23 - 10	4 - 16 4 - 16	11 - 5 11 - 5	10 - 35 10 - 35	7 - 2 7 - 2
	Approval Data UL/C-UL-US CSA	--- ---	30 - 10 28 - 10	--- ---	12 - 4 14 - 4	--- ---	10 - 2 12 - 2
Terminal tightening torque value [Nm]		0.5 ... 0.6		2.5 ... 3		2.5 ... 3	
X4 Motor (holding brake, temperature sensor)	Solid core and multiple conductor lines	0.14 - 1.5	28 - 16	0.14 - 1.5	28 - 16	0.14 - 1.5	28 - 16
	Flexible and fine wire lines without Wire Tip Sleeves with Wire Tip Sleeves	0.14 - 1.5 0.25 - 0.5	28 - 16 23 - 20	0.14 - 1.5 0.25 - 0.5	28 - 16 23 - 20	0.14 - 1.5 0.25 - 0.5	28 - 16 23 - 20
	Approval Data UL/C-UL-US CSA	--- ---	30 - 14 28 - 16	--- ---	30 - 16 28 - 16	--- ---	30 - 16 28 - 16
Terminal tightening torque value [Nm]		0.22 ... 0.25		0.22 ... 0.25		0.22 ... 0.25	
X5 Motor (power)	Solid core and multiple conductor lines	0.2 - 4	24 - 10	10 - 25	7 - 3	10 - 50	7 - 0
	Flexible and fine wire lines without Wire Tip Sleeves with Wire Tip Sleeves	0.2 - 4 0.25 - 4	24 - 10 23 - 10	4 - 16 4 - 16	11 - 5 11 - 5	10 - 35 10 - 35	7 - 2 7 - 2
	Approval Data UL/C-UL-US CSA	--- ---	30 - 10 28 - 10	--- ---	12 - 4 14 - 4	--- ---	10 - 2 12 - 2
Terminal tightening torque value [Nm]		0.5 ... 0.6		2.5 ... 3		2.5 ... 3	
X6 External Braking Resistor	Solid core and multiple conductor lines	---	---	2.5 - 10	13 - 7	2.5 - 10	13 - 7
	Flexible and fine wire lines without Wire Tip Sleeves with Wire Tip Sleeves	---	---	0.5 - 6 0.5 - 6	20 - 9 20 - 9	0.5 - 6 0.5 - 6	20 - 9 20 - 9
	Approval Data UL/C-UL-US CSA	---	---	---	22 - 8 20 - 8	---	22 - 8 20 - 8
Terminal tightening torque value [Nm]		---		1.2 ... 1.6		1.2 ... 1.6	

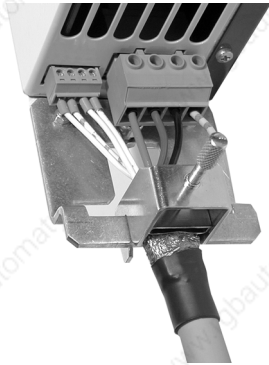
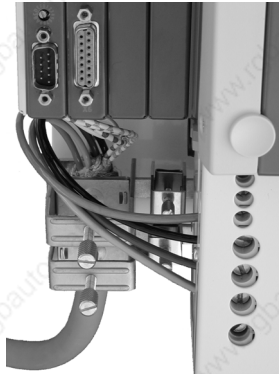
Table 48: Terminal cross sections for ACOPOS servo drives

2. Connections ACOPOS 1022, 1045, 1090

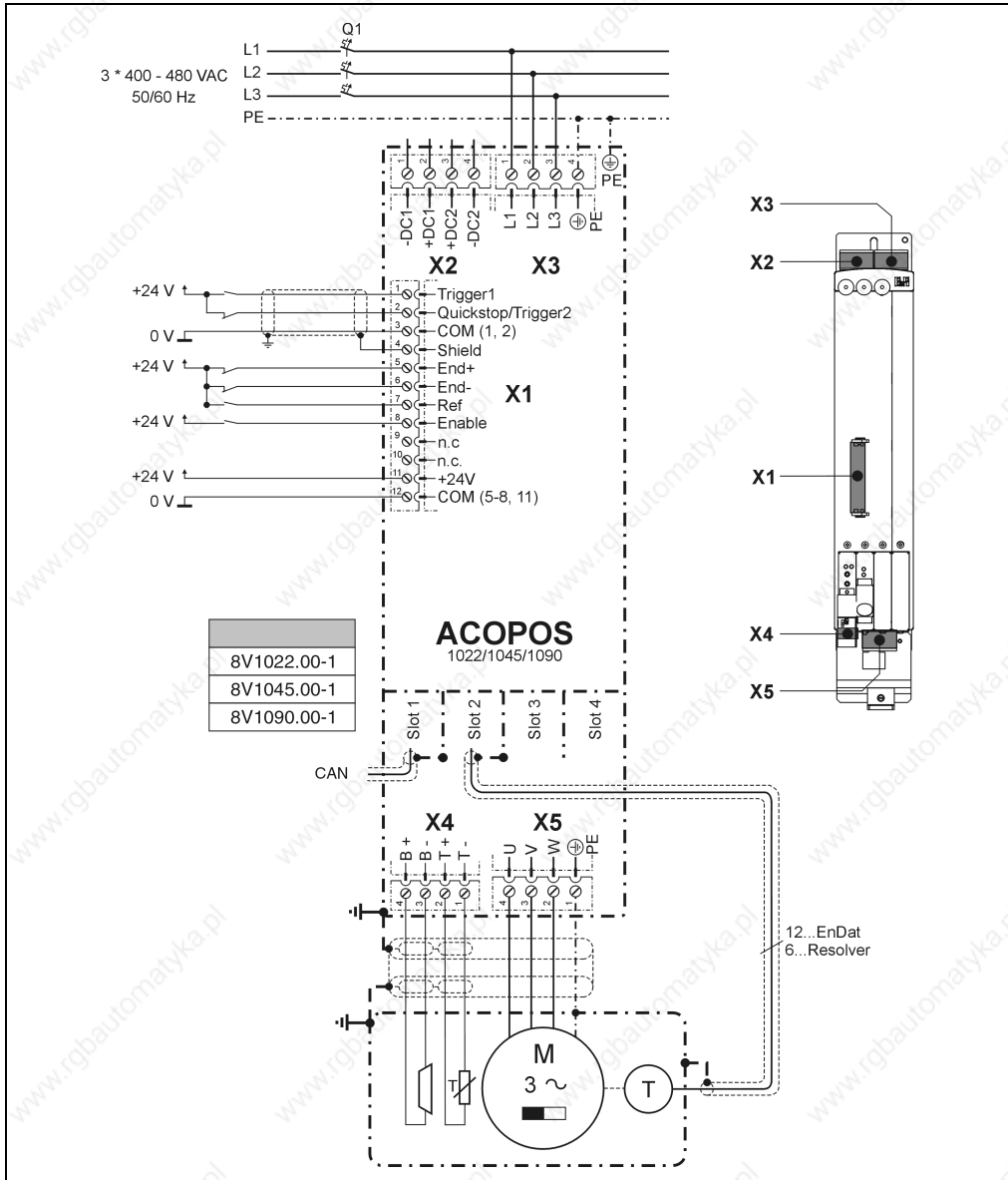

Figure 24: Connection overview ACOPOS 1022, 1045, 1090

2.1 Pin Assignments for Plug X1

X1	Pin	Description	Function
	1	Trigger1	Trigger 1
	2	Quickstop/Trigger2	Quickstop/Trigger 2
	3	COM (1, 2)	Trigger 1, Quickstop/Trigger 2 - 0 V
	4	Shield	Shield
	5	End+	Positive HW limit
	6	End-	Negative HW limit
	7	Ref	Reference switch
	8	Enable	Controller enable
	9	---	---
	10	---	---
	11	+24V	Supply +24 V
	12	COM (5-8, 11)	Supply 0 V
Terminal Cross Sections see Table 48, "Terminal cross sections for ACOPOS servo drives", on page 107			

Table 49: Pin assignments for plug X1 ACOPOS 1022, 1045, 1090

2.2 Pin Assignments for Plug X2

X2	Pin	Description	Function
	1	-DC1	U DC bus -
	2	+DC1	U DC bus +
	3	+DC2	U DC bus +
	4	-DC2	U DC bus -
Terminal Cross Sections see Table 48, "Terminal cross sections for ACOPOS servo drives", on page 107			

Table 50: Pin assignments for plug X2 ACOPOS 1022, 1045, 1090

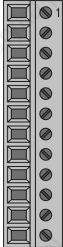
2.3 Pin Assignments for Plug X3

X3	Pin	Description	Function
	1	L1	Power Mains Connection L1
	2	L2	Power Mains Connection L2
	3	L3	Power Mains Connection L3
	4	PE	Protective Ground Conductor
Terminal Cross Sections see Table 48, "Terminal cross sections for ACOPOS servo drives", on page 107			

Table 51: Pin assignments for plug X3 ACOPOS 1022, 1045, 1090

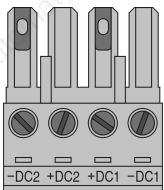
2.4 Pin Assignments for Plug X4

X4	Pin	Description	Function
	1	T-	Temperature Sensor -
	2	T+	Temperature Sensor +
	3	B-	Brake -
	4	B+	Brake +
Terminal Cross Sections see Table 48, "Terminal cross sections for ACOPOS servo drives", on page 107			

Table 52: Pin assignments for plug X4 ACOPOS 1022, 1045, 1090

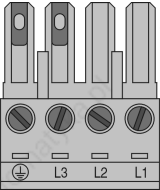
2.5 Pin Assignments for Plug X5

X5	Pin	Description	Function
	1	PE	Protective Ground Conductor
	2	W	Motor Connection W
	3	V	Motor Connection V
	4	U	Motor Connection U
Terminal Cross Sections see Table 48, "Terminal cross sections for ACOPOS servo drives", on page 107			

Table 53: Pin assignments for plug X5 ACOPOS 1022, 1045, 1090

2.6 Protective Ground Connection (PE)

The protective ground conductor is connected to the threaded bolt M4 provided using a cable lug. For information concerning dimensioning see Chapter 4 "Dimensioning", Section 1.1.3 "Protective Ground Connection (PE)".

Image	Pin	Description	Function					
	---	PE	Protective Ground Conductor					
	<table border="1"> <thead> <tr> <th>Terminal Cross Sections</th> <th>[mm²]</th> <th>AWG</th> </tr> </thead> <tbody> <tr> <td>Cable lug for threaded bolt M4</td> <td>0.25 - 6</td> <td>23 - 9</td> </tr> </tbody> </table>			Terminal Cross Sections	[mm ²]	AWG	Cable lug for threaded bolt M4	0.25 - 6
Terminal Cross Sections	[mm ²]	AWG						
Cable lug for threaded bolt M4	0.25 - 6	23 - 9						

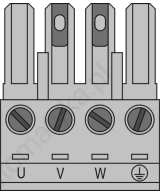
Table 54: Protective ground conductor (PE) ACOPOS 1022, 1045, 1090

Danger!

Before turning on the servo drive, make sure that the housing is properly connected to ground (PE rail). The ground connection must be made, even when testing the servo drive or when operating it for a short time!

3. Connections ACOPOS 1640, 128M

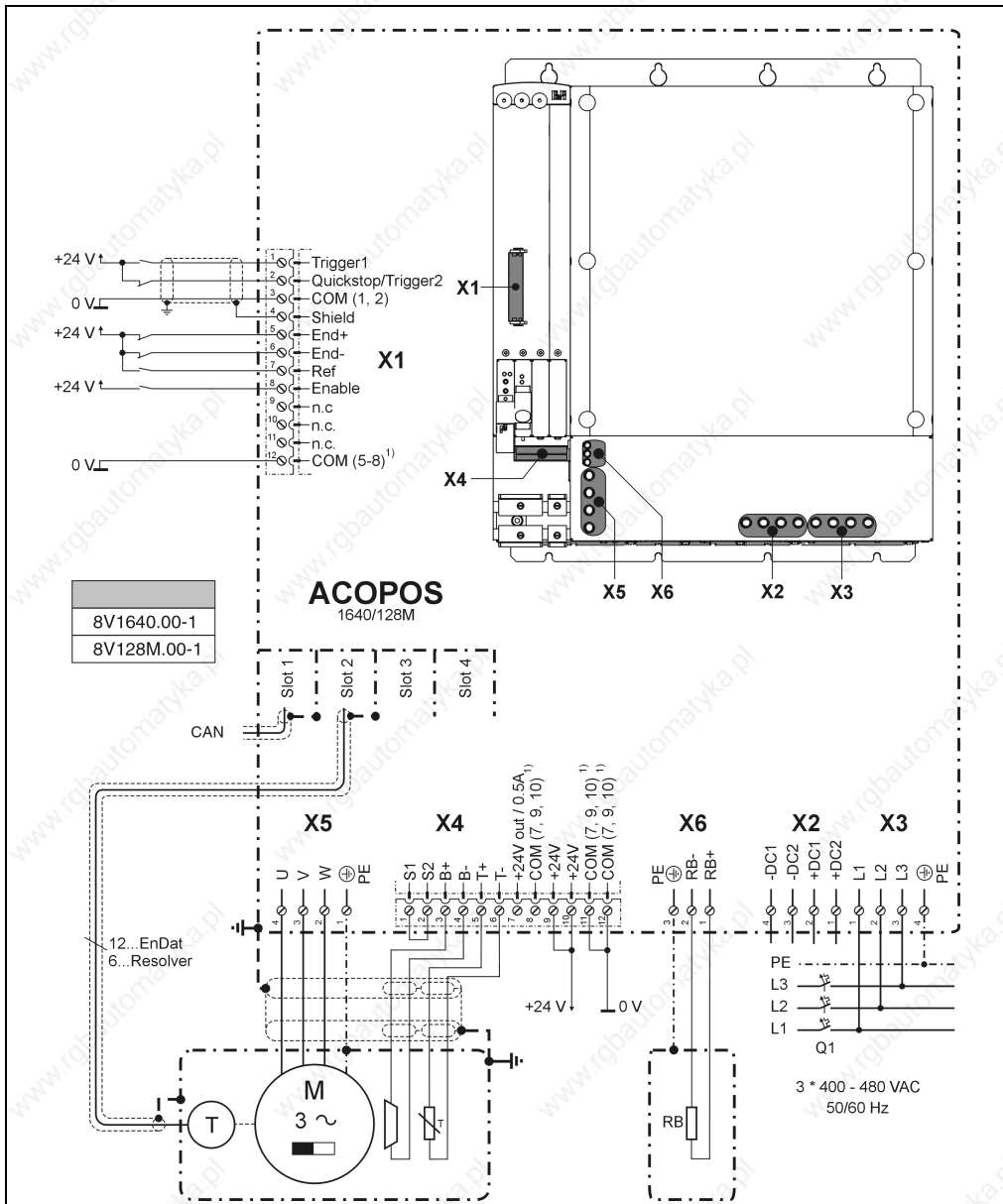

1) Connections X1 / COM (5 - 8) and X4 / COM (7, 9, 10) are internally connected in the device.

3.1 Pin Assignments for Plug X1

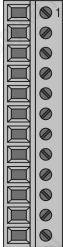
X1	Pin	Description	Function
	1	Trigger1	Trigger 1
	2	Quickstop/Trigger2	Quickstop/Trigger 2
	3	COM (1, 2)	Trigger 1, Quickstop/Trigger 2 - 0 V
	4	Shield	Shield
	5	End+	Positive HW limit
	6	End-	Negative HW limit
	7	Ref	Reference switch
	8	Enable	Controller enable
	9	---	---
	10	---	---
	11	---	---
	12	COM (5-8)	Supply 0 V

Terminal Cross Sections see Table 48, "Terminal cross sections for ACOPOS servo drives", on page 107

Table 55: Pin assignments for plug X1 ACOPOS 1640, 128M

3.2 Pin Assignments for X2

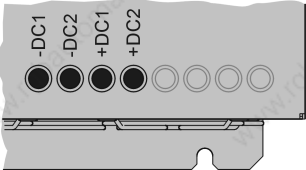
X2	Pin	Description	Function
	1	+DC2	U DC bus +
	2	+DC1	U DC bus +
	3	-DC2	U DC bus -
	4	-DC1	U DC bus -

Terminal Cross Sections see Table 48, "Terminal cross sections for ACOPOS servo drives", on page 107

Table 56: Pin assignments for X2 ACOPOS 1640, 128M

3.3 Pin Assignments for X3

X3	Pin	Description	Function
	1	L1	Power Mains Connection L1
	2	L2	Power Mains Connection L2
	3	L3	Power Mains Connection L3
	4	PE	Protective Ground Conductor
Terminal Cross Sections see Table 48, "Terminal cross sections for ACOPOS servo drives", on page 107			

Table 57: Pin assignments for X3 ACOPOS 1640, 128M

3.4 Pin Assignments for Plug X4

X4	Pin	Description	Function
	1	S1	External activation of the holding brake ¹⁾
	2	S2	External activation of the holding brake ¹⁾
	3	B+	Brake +
	4	B-	Brake -
	5	T+	Temperature +
	6	T-	Temperature -
	7	+24V out / 0.5A	+24 V output / 0.5 A
	8	COM (7, 9, 10)	Supply 0 V
	9	+24V	+24 V
	10	+24V	+24 V
	11	COM (7, 9, 10)	Supply 0 V
	12	COM (7, 9, 10)	Supply 0 V
Terminal Cross Sections see Table 48, "Terminal cross sections for ACOPOS servo drives", on page 107			

Table 58: Pin assignments for plug X4 ACOPOS 1640, 128M

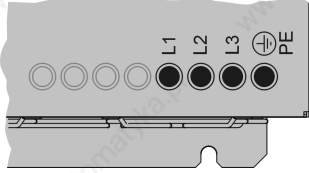
- 1) S1 and S2 can be used to connect an external potential free contact (typically normally closed). This makes it possible to activate the holding brake using an external safety circuit independent of the control integrated in the ACOPOS servo drive. If this function is not used, a jumper must be placed between S1 and S2.

3.5 Pin Assignments for X5

X5	Pin	Description	Function
	1	PE	Protective Ground Conductor
	2	W	Motor Connection W
	3	V	Motor Connection V
	4	U	Motor Connection U
<p>Terminal Cross Sections see Table 48, "Terminal cross sections for ACOPOS servo drives", on page 107</p>			

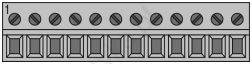
Table 59: Pin assignments for X5 ACOPOS 1640, 128M

3.6 Pin Assignments for X6

X6	Pin	Description	Function
	1	RB+	Brake Resistance +
	2	RB-	Brake Resistance -
	3	PE	Protective Ground Conductor
<p>Terminal Cross Sections see Table 48, "Terminal cross sections for ACOPOS servo drives", on page 107</p>			

Table 60: Pin assignments for X6 ACOPOS 1640, 128M

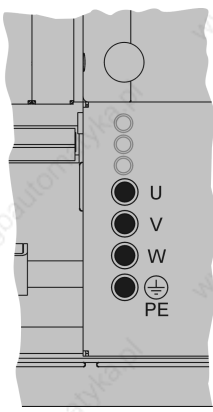
4. Plug-in Module Connections

4.1 AC110 - CAN Interface

4.1.1 Pin Assignments

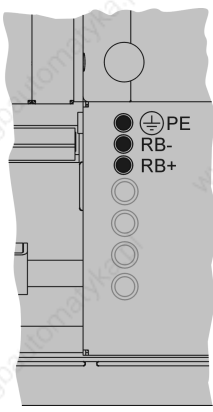
Image	Connection	Pin	Description	Function
 <p>The image shows the AC 110 CAN interface module on the left, which has a DIN connector and two circular ports labeled RXD and TXD. On the right is a diagram of the 9-pin connector with pins numbered 1 through 9.</p>		1	---	---
		2	CAN_L	CAN Low
		3	COM (2, 7)	CAN 0 V
		4	---	---
		5	---	---
		6	---	---
		7	CAN_H	CAN High
		8	---	---
		9	---	---

Table 61: Pin assignments for AC110 - CAN Interface

4.2 AC120 - EnDat Encoder Interface

4.2.1 Pin Assignments

Image	Connection	Pin	Description	Function
 <p>The image shows the AC 120 EnDat Encoder Interface module on the left, which is a vertical black component with a D-sub connector at the bottom. To its right is a diagram of the 15-pin connector, showing the pin layout with pins numbered 1 through 15. Pin 1 is at the bottom right, pin 8 is at the top right, pin 15 is at the top left, and pin 9 is at the bottom left.</p>		1	A	Channel A
		2	COM (1, 3 - 9,11, 13 - 15)	Encoder supply 0 V
		3	B	Channel B
		4	+5V out / 0.25A	Encoder supply +5 V
		5	D	Data input
		6	---	---
		7	R\	Reference pulse inverted
		8	T	Clock output
		9	A\	Channel A inverted
		10	Sense COM	Sense input 0 V
		11	B\	Channel B inverted
		12	Sense +5V	Sense input +5 V
		13	D\	Data inverted
		14	R	Reference pulse
		15	T\	Clock output inverted

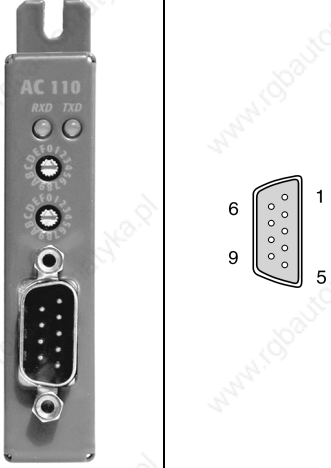
Table 62: Pin assignments for AC120 - EnDat Encoder Interface

4.3 AC122 - Resolver Interface

4.3.1 Pin Assignments

Image	Connection	Pin	Description	Function
 <p>The image shows the AC122 Resolver Interface module on the left, which has a U-shaped top, two status LEDs labeled 'UP' and 'DN', and a 9-pin D-sub connector. To the right is a diagram of the 9-pin connector with pins numbered 1 through 9.</p>		1	---	---
		2	---	---
		3	Cos	Cosine input
		4	Sin	Sine input
		5	Ref	Reference Output
		6	---	---
		7	Cos\	Cosine input inverted
		8	Sin\	Sine input inverted
		9	Ref \	Reference output inverted

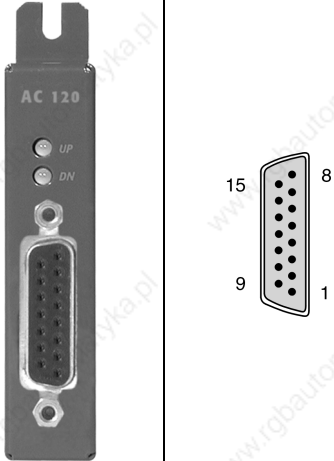
Table 63: Pin assignments for AC122 - Resolver Interface

4.4 AC123 - Incremental Encoder and SSI Absolute Encoder Interface

4.4.1 Pin Assignments

Image	Connection	Pin	Description	Function in Incremental Mode	Function in SSI Mode
 <p>The image shows the AC123 module on the left and a detailed view of its 15-pin connector on the right. The connector pins are numbered 1 through 15. Pin 1 is at the bottom right, and pin 15 is at the top left.</p>		1	A	Channel A	---
		2	A\	Channel A inverted	---
		3	B	Channel B	---
		4	B\	Channel B inverted	---
		5	RD	Reference pulse	Data input
		6	RD\	Reference pulse inverted	Data input inverted
		7	T	---	Clock output
		8	T\	---	Clock output inverted
		9	+5V out / 0.35A	Encoder supply +5 V	
		10	Sense +5V	Sense +5 V	
		11	Sense COM	Sense 0 V	
		12	COM (7 - 9, 13)	Encoder supply 0 V	
		13	+15V out / 0.35A	Encoder supply +15 V	
		14	A1	Activate encoder supply ¹⁾	
		15	A2	Activate encoder supply ¹⁾	

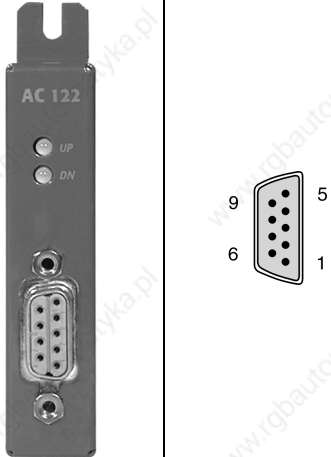
Table 64: Pin assignments AC123 - incremental encoder and SSI absolute encoder interface

1) To activate the encoder supply, pins 14 and 15 must be connected in the encoder cable plug.

4.5 AC130 - Digital Mixed Module

4.5.1 Pin Assignments

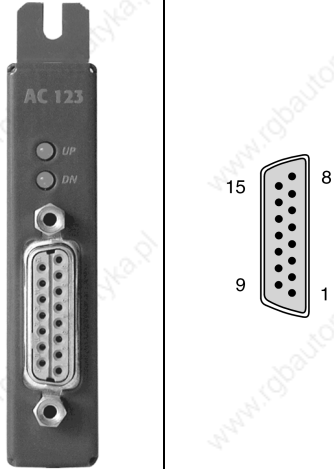

Image	Connection	Pin	Description	Function
		1	Dig. I/O 1	Digital input / output 1
		2	Dig. I/O 2	Digital input / output 2
		3	Dig. I/O 3	Digital input / output 3
		4	Dig. I/O 4	Digital input / output 4
		5	Dig. I/O 5	Digital input / output 5
		6	Dig. I/O 6	Digital input / output 6
		7	Dig. I/O 7	Digital input / output 7
		8	Dig. I/O 8	Digital input / output 8
		9	Dig. O 9	Digital output 9
		10	Dig. O 10	Digital output 10
		11	+24V	Supply +24 V
		12	COM (1-11)	Supply 0 V
Terminal Cross Sections			[mm²]	[AWG]
Solid core and multiple conductor lines			0.5 - 1.5	20 - 14
Flexible, multiple wire line without Wire Tip Sleeves with Wire Tip Sleeves			0.5 - 1.5	20 - 14
			0.5 - 1.5	20 - 14
Approbation Data (UL/C-UL-US- and CSA) UL/C-UL-US CSA			---	26 - 14
			---	26 - 14

Table 65: Pin assignments AC130 - digital mixed module

4.6 Connecting Cables to Plug-in Modules

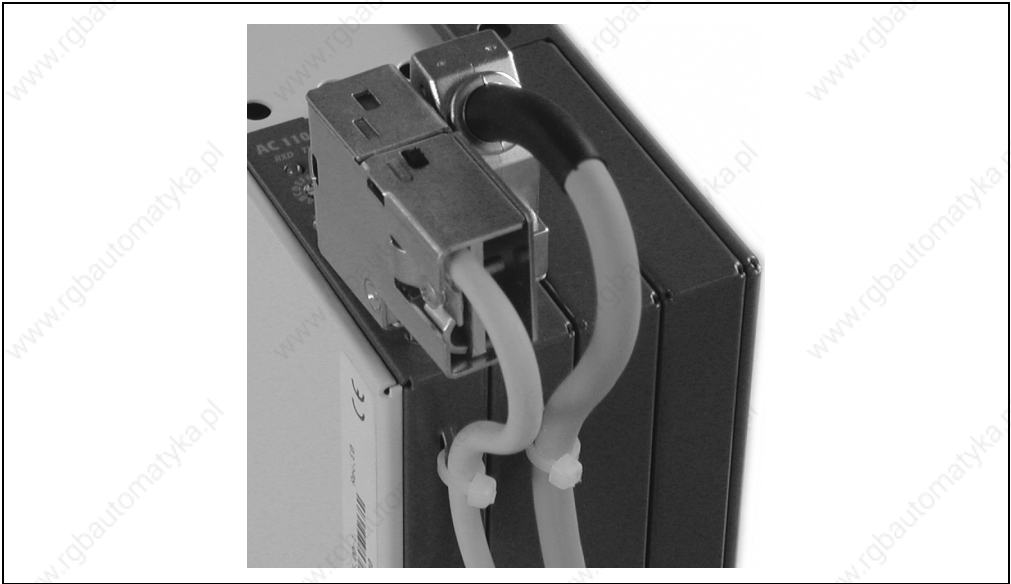

Figure 26: Connecting Cables to Plug-in Modules

Stress relief for the cable is implemented using a cable tie. The cable tie is to be run through the eye on the bottom of the plug-in module.

Make sure that the ventilation slots on the bottom of the ACOPOS drive are not blocked.

5. Cables

5.1 Motor Cables

5.1.1 Motor Cable Construction

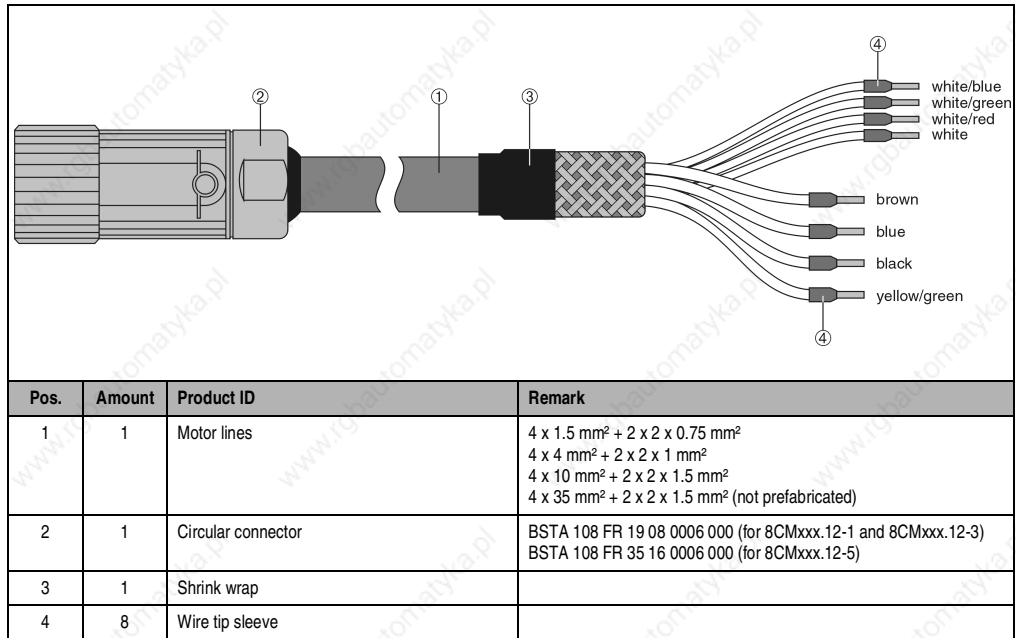

Table 66: Motor cable construction

5.1.2 Pin Assignments 8CMxxx.12-1, 8CMxxx.12-3

Circular connector	Pin	Product ID	Function
	1	U	Motor Connection U
	2	PE	Protective Ground Conductor
	3	W	Motor Connection W
	4	V	Motor Connection V
	A	T+	Temperature +
	B	T-	Temperature -
	C	B+	Brake +
	D	B-	Brake -

Table 67: Pin assignments for motor cable 8CMxxx.12-1, 8CMxxx.12-3

5.1.3 Cable Schematic for 8CMxxx.12-1, 8CMxxx.12-3

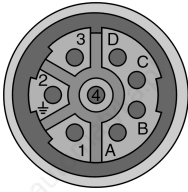
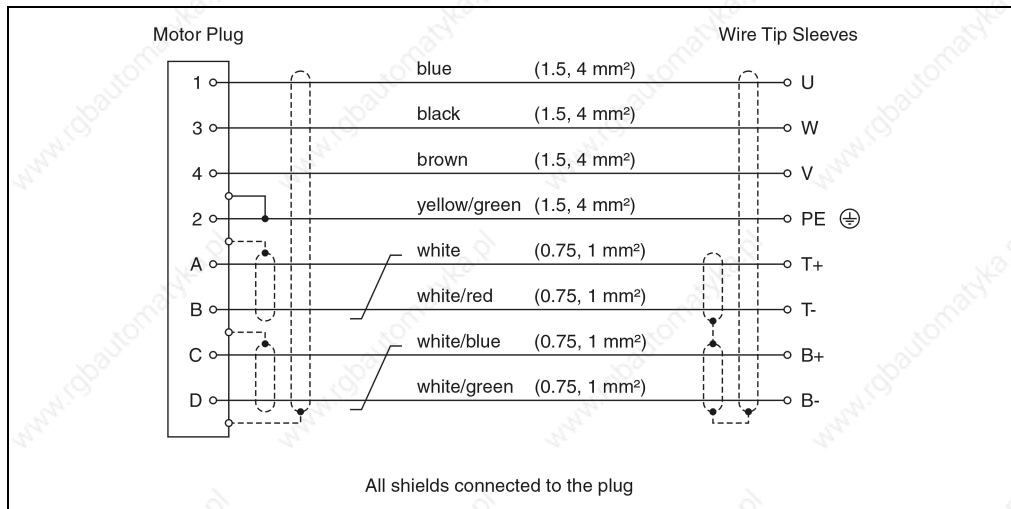

Figure 27: Cable schematic for motor cable 8CMxxx.12-1, 8CMxxx.12-3

5.1.4 Pin Assignments for 8CMxxx.12-5

Circular connector	Pin	Product ID	Function
	U	U	Motor Connection U
	⏏	PE	Protective Ground Conductor
	W	W	Motor Connection W
	V	V	Motor Connection V
	1	T+	Temperature +
	2	T-	Temperature -
	+	B+	Brake +
	-	B-	Brake -

Table 68: Pin assignments for motor cables 8CMxxx.12-5

5.1.5 Cable Schematic for 8CMxxx.12-5

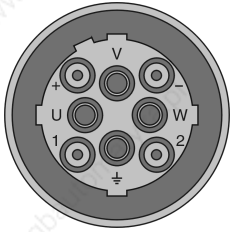
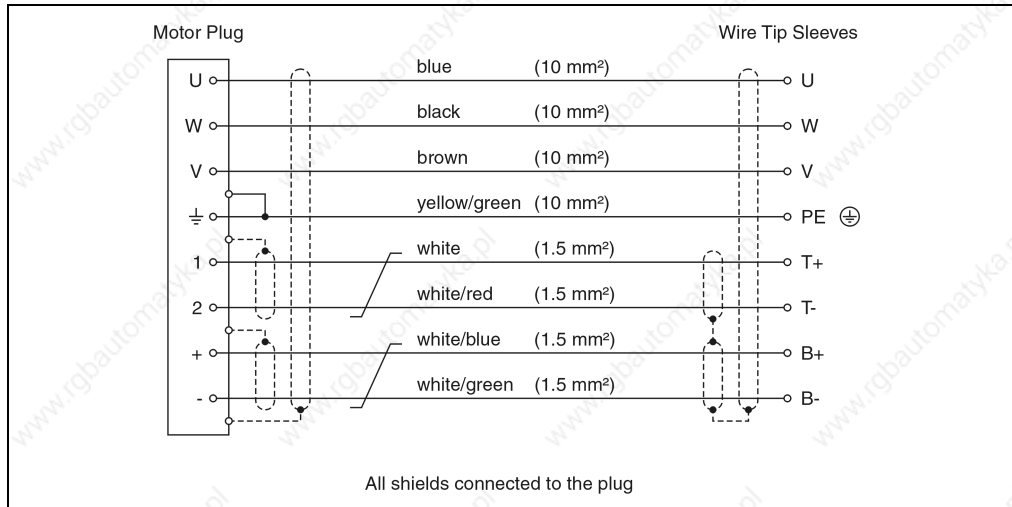
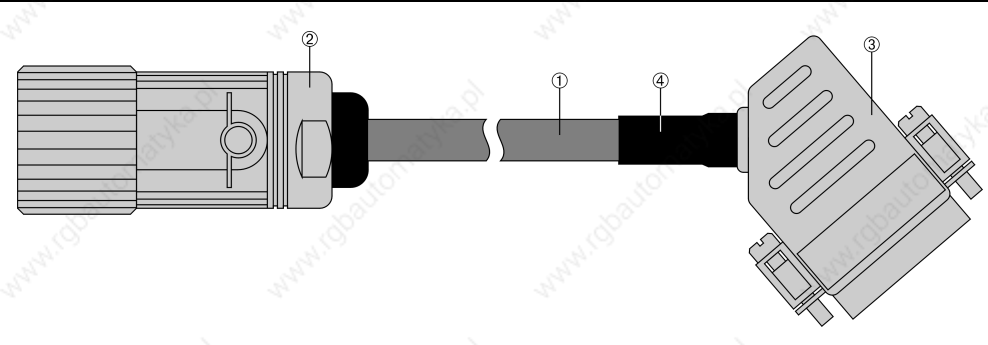

Figure 28: Cable schematic for motor cables 8CMxxx.12-5

5.2 EnDat Encoder Cables

5.2.1 EnDat Encoder Cable Construction



Pos.	Amount	Product ID	Remark
1	1	Encoder cable	10 x 0.14 mm ² + 2 x 0.50 mm ²
2	1	Circular connector, 17 pin socket	ASTA 035 FR 11 12 0005 000
3	1	DSUB housing 45°, metal plated, 15 pin plug	
4	1	Shrink wrap	

Table 69: EnDat encoder cable construction

5.2.2 Pin Assignments

Circular connector	Pin	Product ID	Function	Pin	DSUB plug
	15	A	Channel A	1	
	10	COM (1, 3 - 9, 11, 13 - 15)	Encoder supply 0 V	2	
	12	B	Channel B	3	
	7	+5V out / 0.25A	Encoder supply +5 V	4	
	14	D	Data input	5	
	8	T	Clock output	8	
	16	A\	Channel A inverted	9	
	4	Sense COM	Sense input 0 V	10	
	13	B\	Channel B inverted	11	
	1	Sense +5V	Sense input +5 V	12	
	17	D\	Data inverted	13	
	9	T\	Clock output inverted	15	

Table 70: Pin assignments for EnDat encoder cables

5.2.3 Cable Schematic

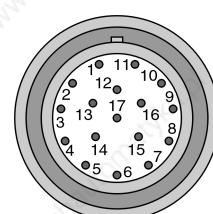
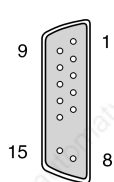
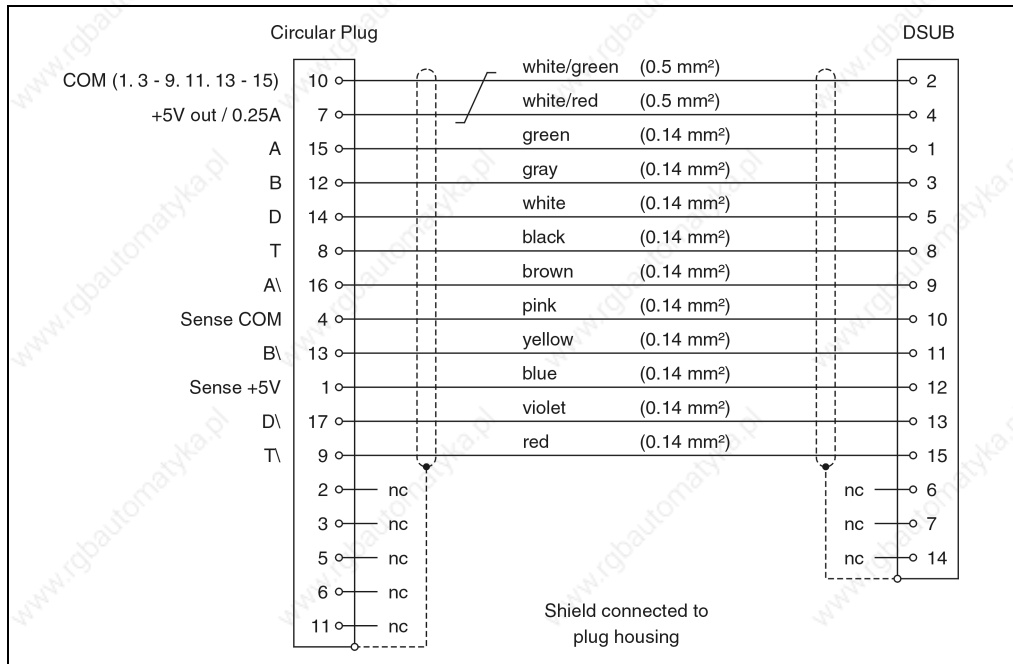
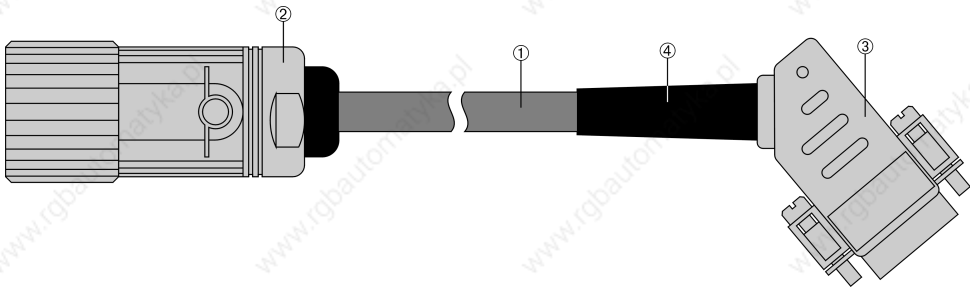

Figure 29: Cable schematic for EnDat encoder cables

5.3 Resolver Cables

5.3.1 Resolver Cable Construction



Pos.	Amount	Product ID	Remark
1	1	Encoder cable	3 x 2 x 24 AWG/19
2	1	Circular connector, 12 pin socket	ASTA 021 FR 11 10 0005 000
3	1	DSUB housing 45°, metal plated, 9 pin plug	
4	1	Kink protection	

Table 71: Resolver cable construction

5.3.2 Pin Assignments

Circular connector	Pin	Product ID	Function	Pin	DSUB plug
	1	---			
	2	---			
	3	Cos	Cosine input	3	
	4	Sin	Sine input	4	
	5	Ref	Reference Output	5	
	6	---			
	7	Cos\	Cosine input inverted	7	
	8	Sin\	Sine input inverted	8	
	9	Ref \	Reference output inverted	9	
	10	---			
	11	---			
	12	---			

Table 72: Pin assignments for resolver cables

5.3.3 Cable Schematic

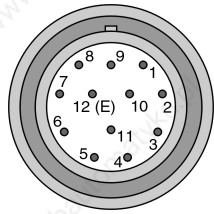
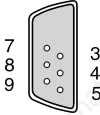
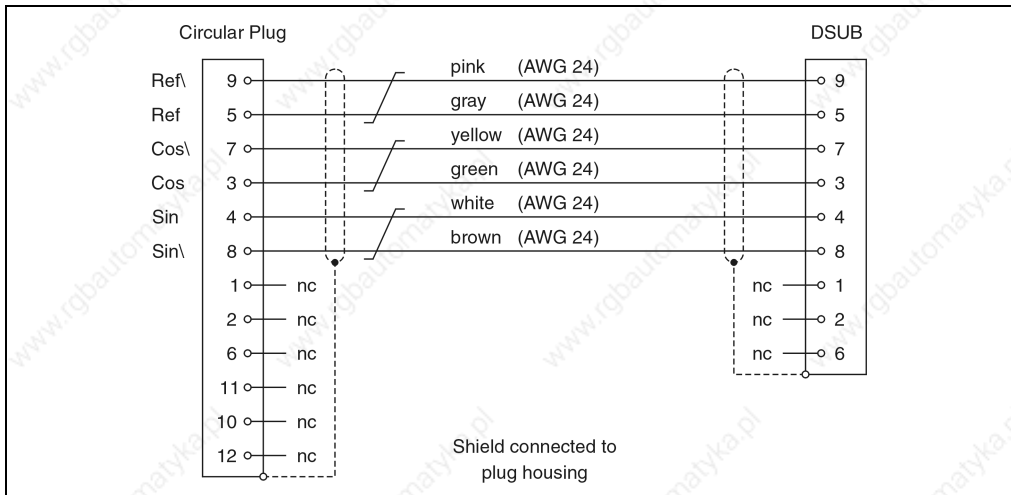

Figure 30: Cable schematic for resolver cables

CHAPTER 6 • GETTING STARTED

1. Preparation

1.1 Unpacking the ACOPOS Servo Drive

Remove the protective packaging from the ACOPOS servo drive. Check the ACOPOS servo drive for obvious mechanical damage.

Danger!

Do not operate the ACOPOS servo drive if it is damaged. This can cause severe personal injury or damage to property!

1.2 Installing and Connecting the ACOPOS Servo Drive

The guidelines and specifications for installing and wiring the respective ACOPOS servo drive can be found in chapters 3 "Installation", 4 "Dimensioning" and 5 "Wiring".

1.3 Connecting the ACOPOS Servo Drive with a B&R PLC

The ACOPOS servo drives are equipped with a CAN interface which can be used to connect to a B&R PLC. The connection is made using a CAN cable (pin assignments can be found in chapter 5 "Wiring" and in the User's Manual for the PLC).

2. Starting Up an ACOPOS Servo Drive

The goal of the following example is move the shaft of a motor connected to an ACOPOS servo drive 5000 units. In order to emphasize the important points of starting up the hardware, this will be done using an sample project contained in B&R Automation Studio™.

Danger!

Incorrect control of motors or mechanical parts connected to the motor shaft can cause unwanted and dangerous movements!

2.1 General Information

The start-up procedure described here is based on the following configuration: ¹⁾

Model Number	Short Description
	Servo Drives
8V1045.00-1	Servo drive 3 x 400-480V 4.4A 2kW, line filter and braking resistor integrated
	Plug-in Modules
8AC110.60-1	ACOPOS plug-in module, CAN interface
8AC120.60-1	ACOPOS plug-in module, EnDat encoder interface
	Motor
8MSA4L.E0-B4	Motor MSA4 series with EnDat encoder
	Accessories
7AC911.9	Bus connector, CAN (2 pcs.)
8CE005.12-1	EnDat cable, length 5m, 10 x 0.14mm ² + 2 x 0.5mm ² , EnDat connector 17 pin Intercontec socket, servo connector 15 pin DSUB plug, can be used in cable drag chains, UL/CSA listed
8CM005.12-1	Motor cable, length 5m, 4 x 1.5mm ² + 2 x 2 x 0.75mm ² , motor connector 8 pin Intercontec socket, can be used in cable drag chains, UL/CSA listed
0G0001.00-090	Cable PC <-> PLC/PW, RS232, Online cable
	PLC CPU
7CP476.60-1	2003 CPU, 750 KB SRAM, 1.5 MB FlashPROM, 24 VDC, 12.5 W supply, 1 RS232 interface, 1 CAN interface, CAN: electrically isolated, network capable, 4 slots for screw-in modules, system bus for expansion modules, max. 272 digital / 80 analog I/O points
	B&R Automation Studio™
1A4000.Lx	B&R AutomationSoftware™ CD, full version

Table 73: Configuration for the start-up example

1) The procedure can change slightly depending on the hardware configuration.

The hardware configuration will be called the "target system" in the following sections. A PC with B&R Automation Studio™ installed will also be needed.

2.1.1 Sample Project

Several sample projects are available in B&R Automation Studio™ which can be used to test ACOPOS servo drives. They are found in the directory "...\\BRAUTOMATION\\SAMPLES\\MOTION" in the B&R Automation Studio™ installation directory.

This start-up example is based on the sample project "...\\BRAUTOMATION\\SAMPLES\\MOTION\\DEUTSCH\\C\\ACP10.PGP\\ACP10.GDM" starting with ACOPOS operating system version V 0.47.2.

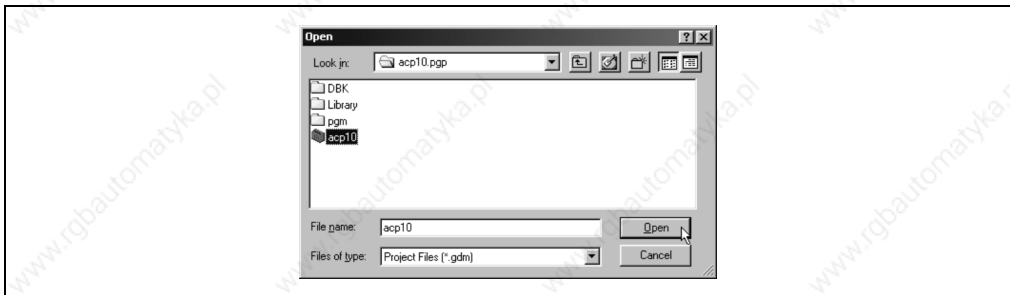

Figure 31: Open sample project

Information:

During start-up, changes will be made to the sample project. We recommend that you make a copy of the sample project (entire ACP10.PGP directory, see Figure 31 "Open sample project") in a different project directory and use it for the start-up.

2.1.2 Preparing the Hardware for Sample Project acp10.gdm

- Check the wiring of the ACOPOS servo drive connections (also see chapter 5 "Wiring").
- Set node number 1 on the AC110 plug-in module (see chapter 2 "Technical Data").
- Connect the PC with the PLC using the online cable (see user's manual for the PLC for information concerning the online cable connection to the PLC).
- Apply power to the PLC and the ACOPOS servo drive (24 VDC, 400 VAC). You can make sure the ACOPOS servo drive boots correctly by watching the blink code (see chapter 2 "Technical Data").

2.2 Start-up

2.2.1 Load Sample Project

Start B&R Automation Studio™:



Figure 32: B&R Automation Studio™ version is shown during the start procedure

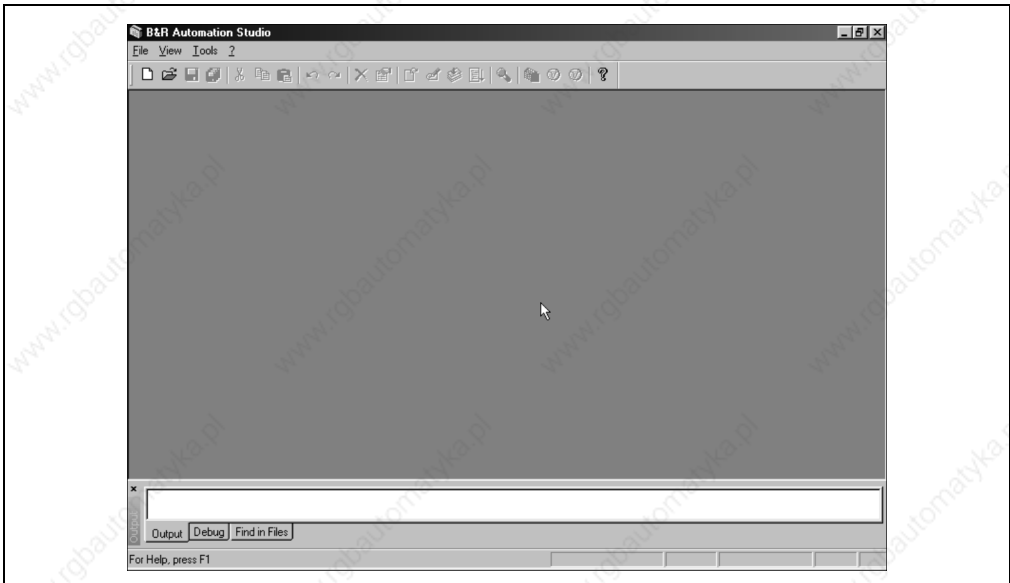

Figure 33: B&R Automation Studio™ Start-up Screen

Open the project (recommended: make a copy of sample project ACP10.GDM in the respective project path):

- Click **Open Project ...** in the **File** menu.

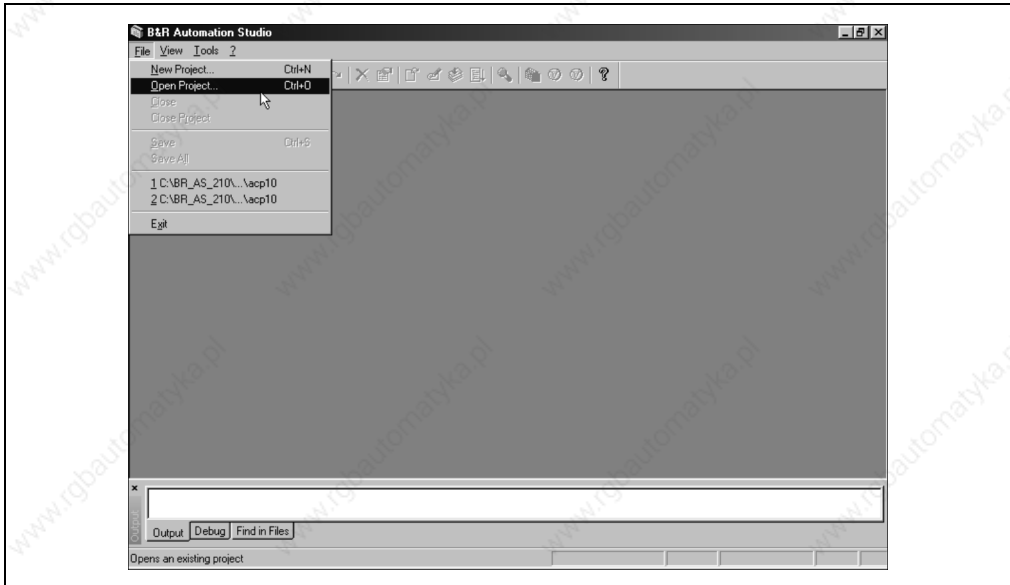

Figure 34: Opening a project

- Select ...ACP10.PGP\ACP10.GDM.
- Load the project by clicking on the **Open** button.

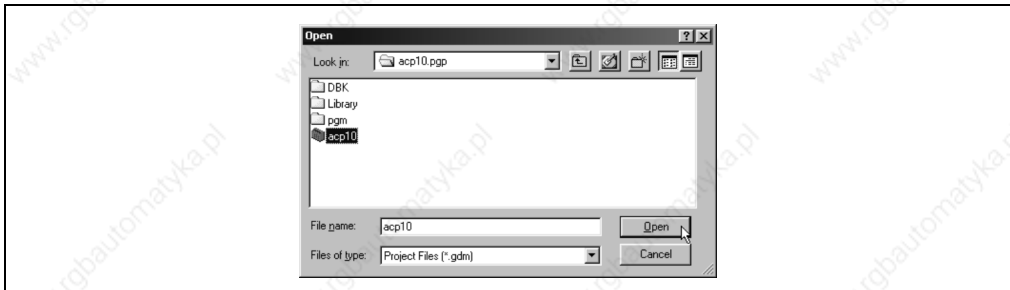

Figure 35: Selecting the project

The selected project is then opened in the project window:

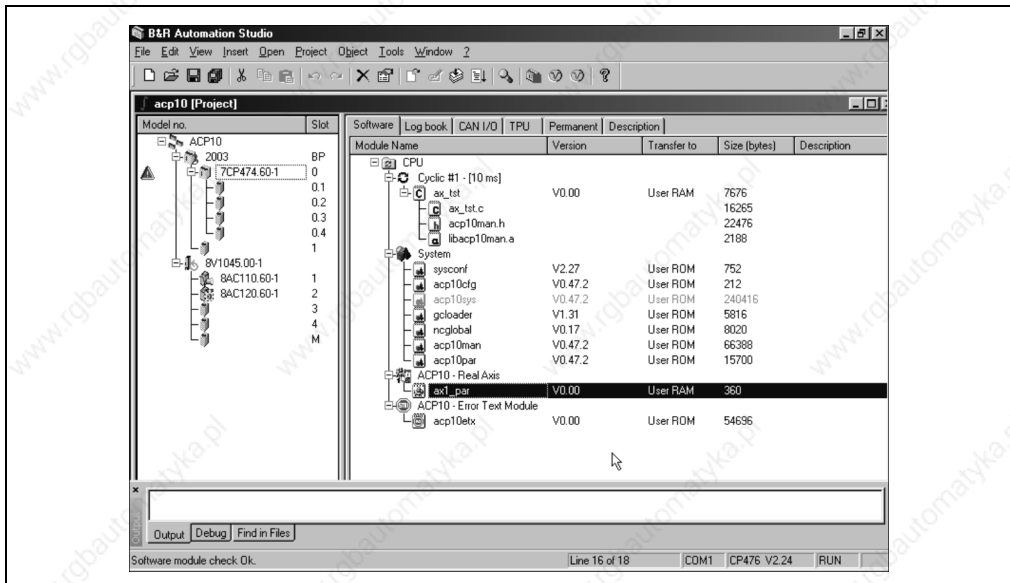

Figure 36: Project window with representation of the hardware and software configuration

The left part of the window contains the hardware configuration for the project and the right part of the window contains the software configuration for the hardware component selected in the left part of the window.

Information:

When loading the project, a connection is automatically established between the PC and the PLC.

If the connection is active, the CPU type and "RUN" are shown to the right below the status bar (see Figure 36 "Project window with representation of the hardware and software configuration").

2.2.2 Preset Values for the Sample Project

A few preset values must be defined on the target system before downloading the project.

CPU

The sample project was originally created for a different PLC CPU (7CP474.60-1).

This must be changed to the CPU used on the target system (shown to the right under the status bar):

- In the left part of the window, position the mouse pointer on the CPU (7CP474.60-1).

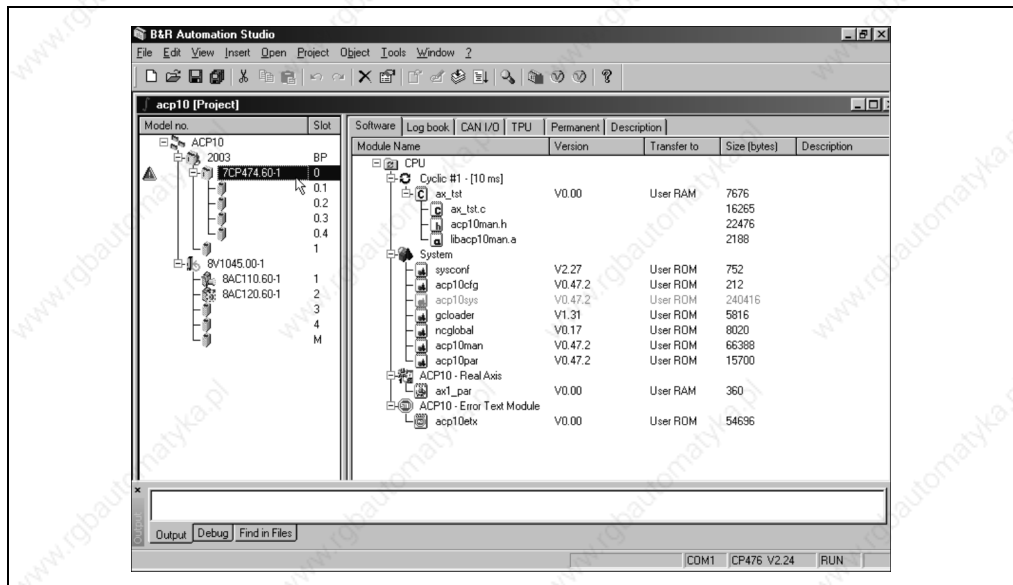

Figure 37: Select the CPU in the left part of the window

- Open the shortcut menu with the right mouse button.
- Position the mouse pointer on **Replace with 7CP476.60-1**.
- Select this menu item with the left mouse button.

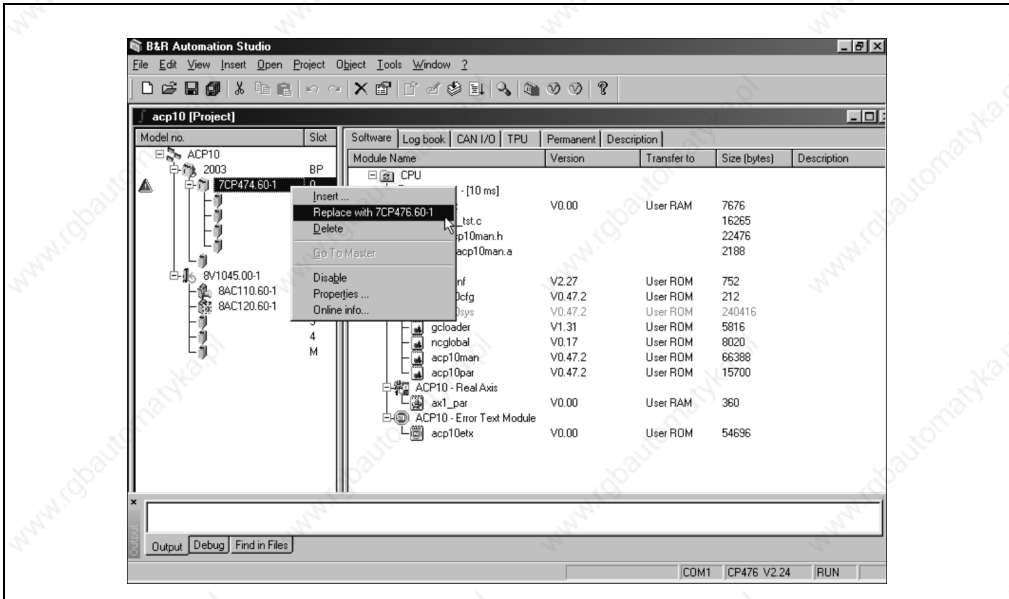

Figure 38: Select the command used to replace the CPU from the shortcut menu

- Acknowledge the change of the CPU by clicking on the **OK** button.

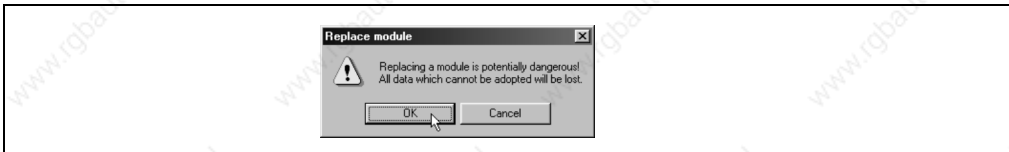

Figure 39: Acknowledge the change of the CPU

User Memory

Before downloading the sample project, we recommend clearing the user memory on the PLC:

- In the **Project** menu, select **Services** and then **Clear Memory**

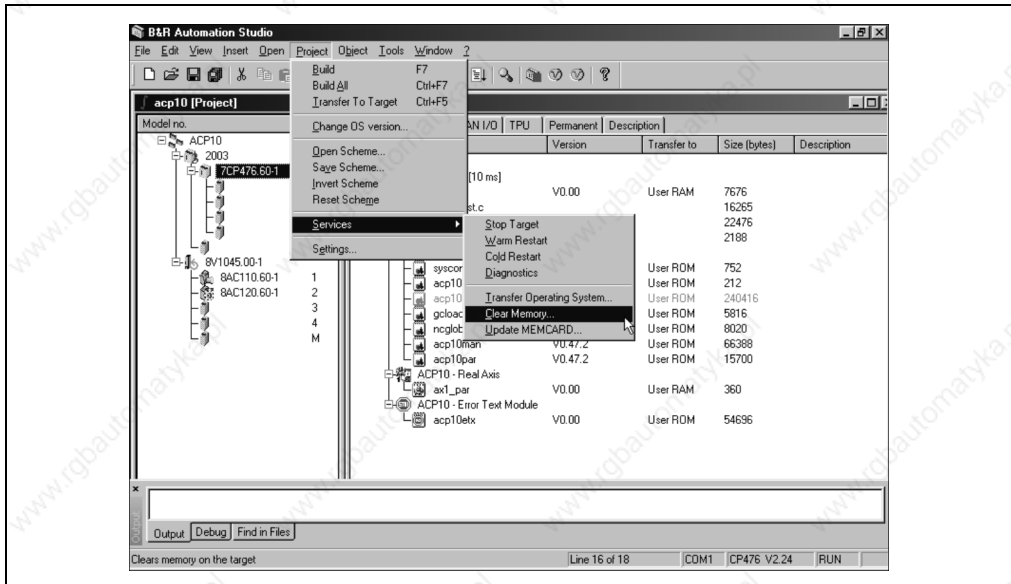

Figure 40: Clearing user memory on the PLC

- Activate the checkbox **Erase USER ROM**.
- Acknowledge the selection by clicking the **OK** button.

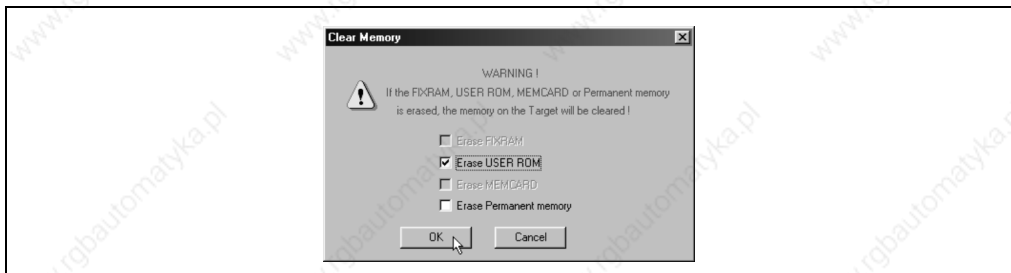

Figure 41: Selecting the user memory on the PLC

- The user memory is erased.



Figure 42: Erasing the user memory

After clearing the user memory, the project window will be shown again.

Operating System Download

The first time an ACOPOS servo drive is started up, the ACOPOS operating system ACP10SYS must also be transferred to the target system. In the sample project, transferring ACP10SYS is deactivated (shown in gray in the right part of the window). Transferring ACP10SYS must be activated separately in the sample project:

- Position the mouse pointer on ACP10SYS in the right part of the window.

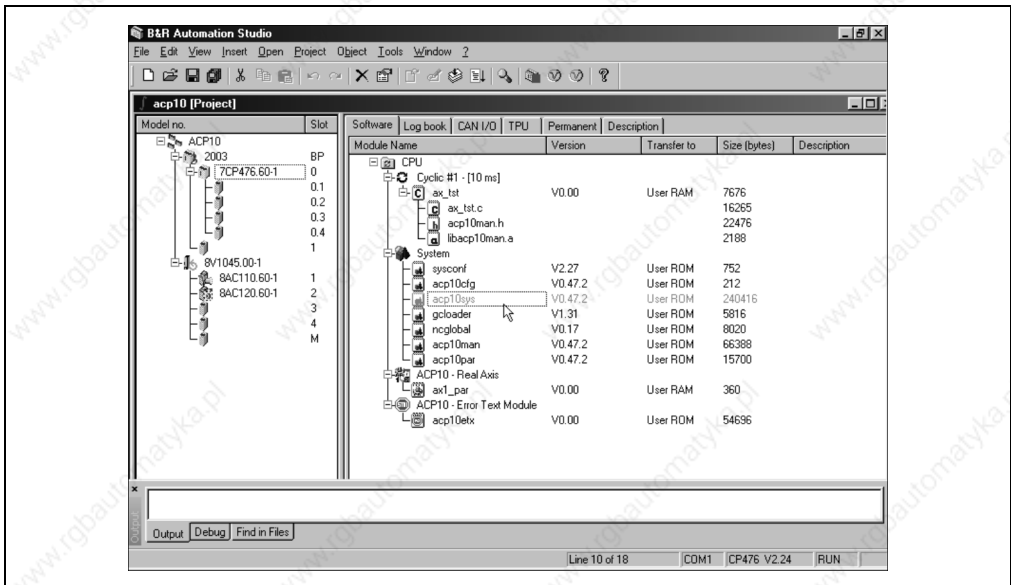

Figure 43: Place mouse pointer on ACOPOS operating system ACP10SYS

- Open the shortcut menu with the right mouse button.
- Position the mouse pointer on **Disable**.
- Click on **Disable** with the left mouse button to cancel deactivation.

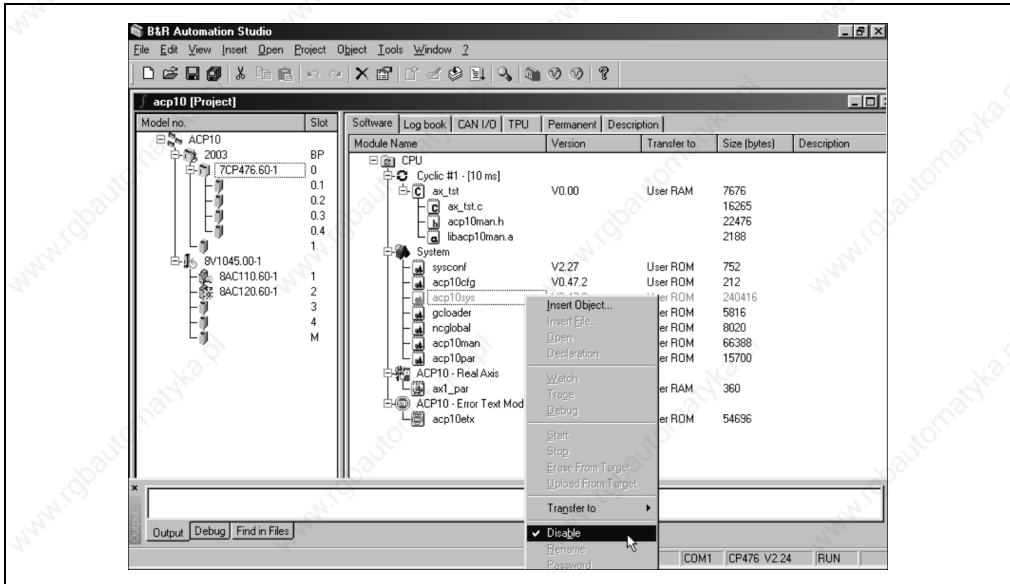

Figure 44: Enable transferring the ACOPOS operating system

ACP10SYS is now enabled (shown in black instead of gray) and is also transferred the next time the project is downloaded.

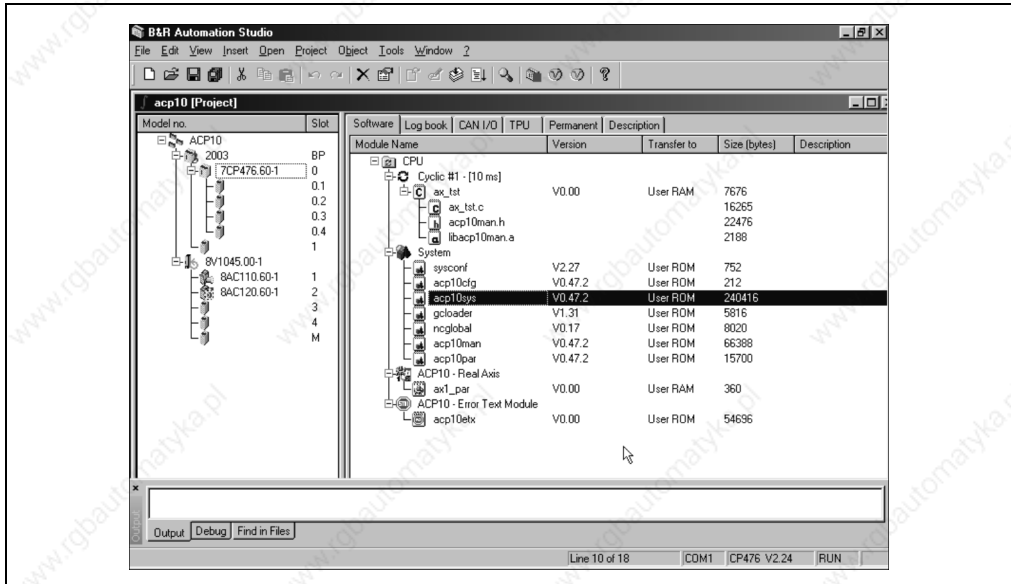

Figure 45: The operating system is also transferred the next time the project is downloaded

Information:

After successfully downloading the operating system the first time, "Disable" can be set again which shortens the download time for projects.

2.2.3 Preset Values Concerning Wiring

The further procedure depends on the wiring of the digital servo drive control inputs.

End Switch and Quickstop are Wired

If the hardware end switches (normally closed) are wired to X1 / End+ and X1 / End- and a quickstop switch (normally closed) is wired to X1 / Quickstop/Trigger2 according to chapter 5 "Wiring", Section 2 "Connections ACOPOS 1022, 1045, 1090", then start-up can be continued with Section 2.2.4 "Downloading the Project".

End Switch and Quickstop are not Wired

If the hardware end switches and quickstop are not wired, it is possible to change the parameters so that the motor shaft can still be moved.

Danger!

When moving the motor shaft without the hardware end switches connected, movements of mechanical parts mounted on the motor shaft must be considered. Otherwise severe personal injury or damage to property can occur!

- Position the cursor on the initial parameter module AX1_PAR.
- Open the object by double-clicking with the left mouse button.

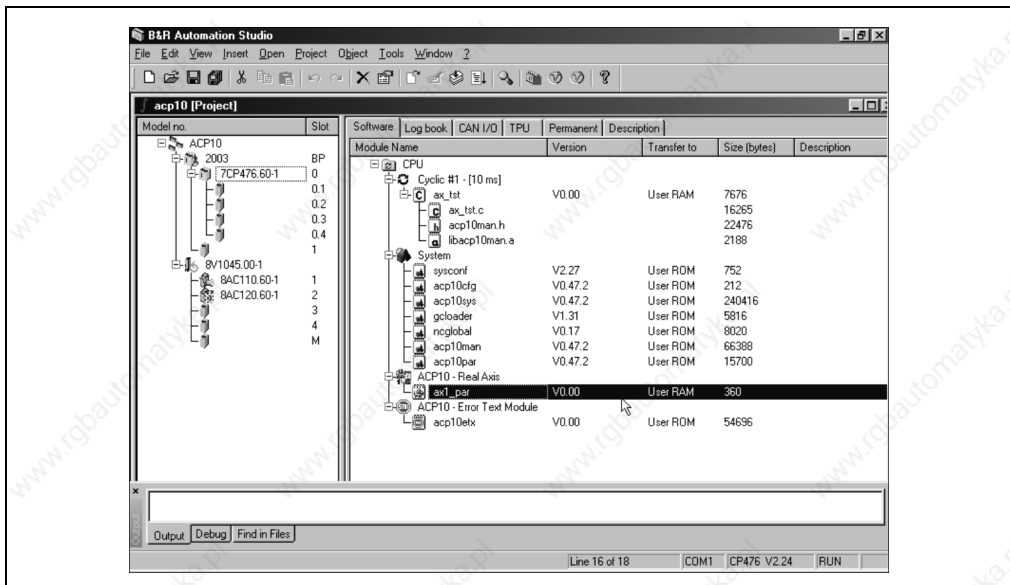

Figure 46: Open initial parameter module AX1_PAR

- Position the mouse pointer on "dig_in".

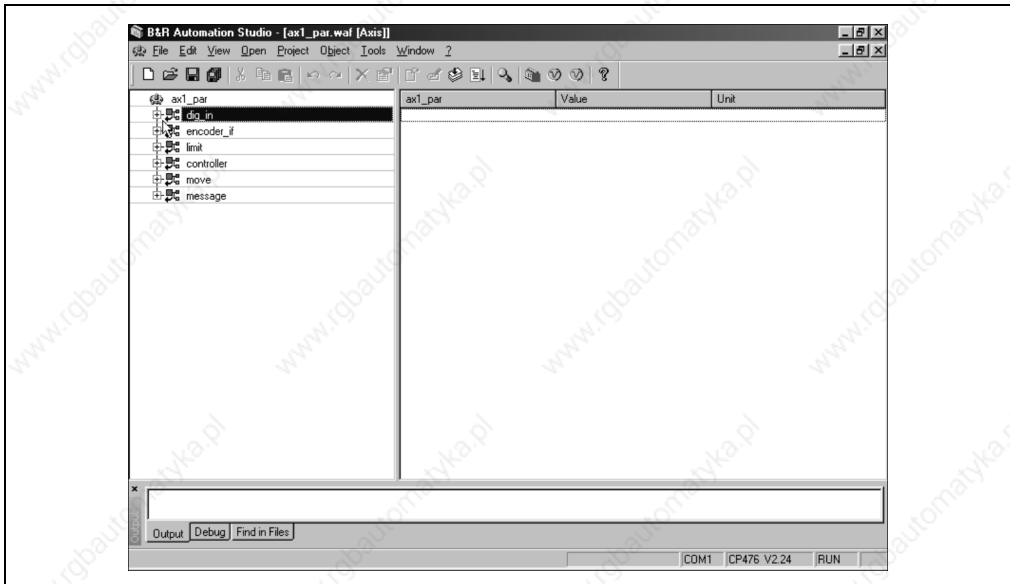

Figure 47: Place the mouse pointer on "dig_in"

- Expand the view by clicking on "+".

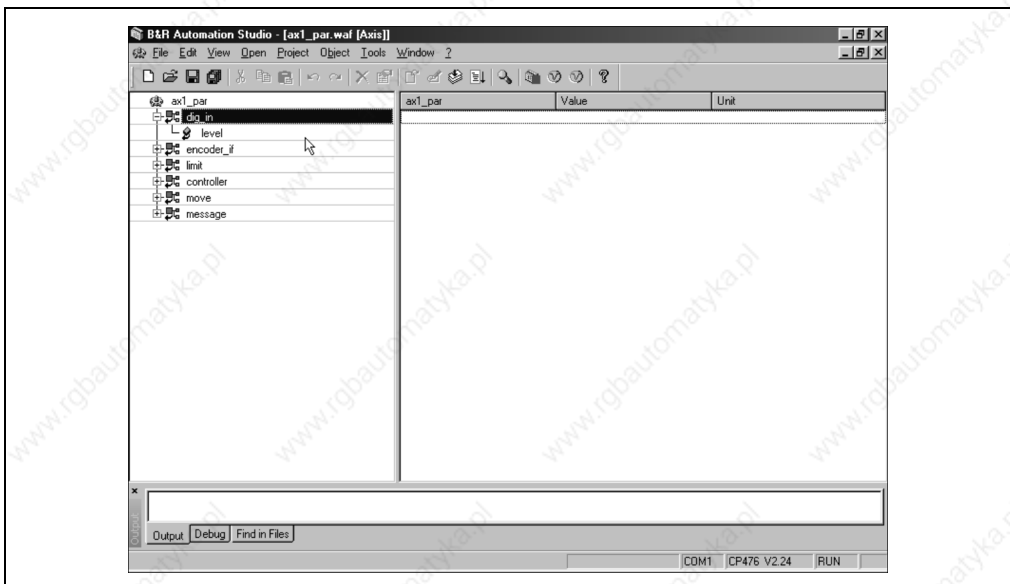

Figure 48: Expand the view

- Position the mouse pointer on "level". The parameters are now shown in the right part of the window.

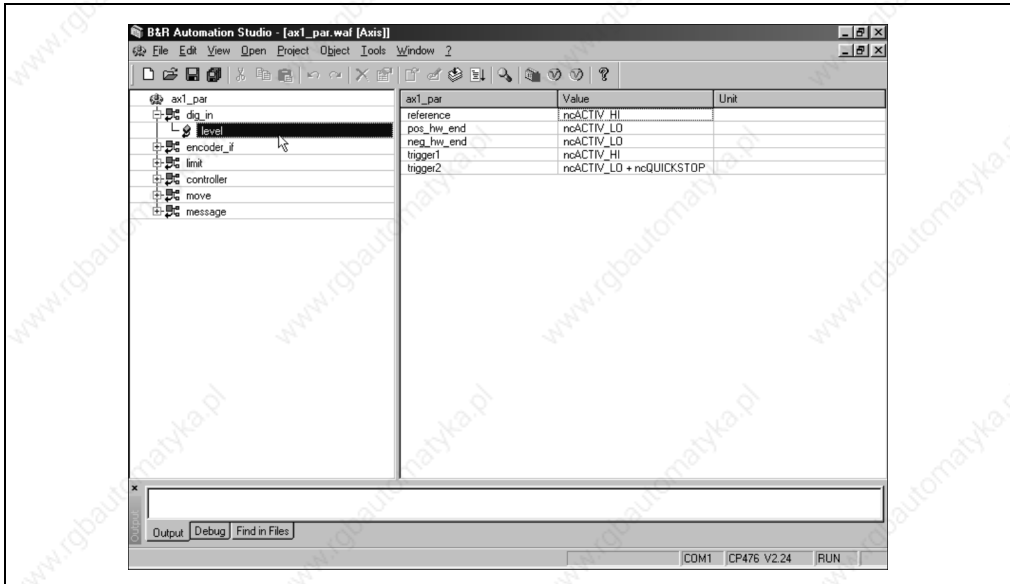

Figure 49: Displaying the level parameters

To allow movement of the motor shaft, the following parameters must be changed to the value "ncACTIV_HI":

- pos_hw_end
- neg_hw_end
- trigger2 (quickstop)

"ncACTIV_HI" means that the inputs for both hardware end switches and the quickstop are activated (logical "1"). This allows the motor shaft to be moved without wiring the hardware end switches and a quickstop.

The procedure is shown here in an example for pos_hw_end:

- In the right part of the window, position the mouse pointer on level "ncACTIV_LO" for the shaft parameter pos_hw_end.

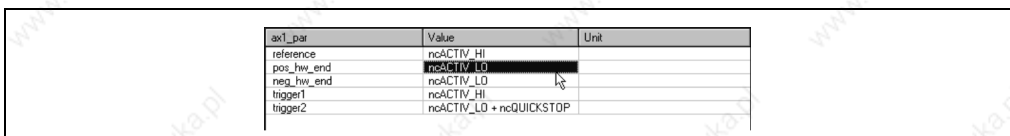

Figure 50: Place mouse pointer on level "ncACTIV_LO"

Getting Started • Starting Up an ACOPOS Servo Drive

- Open the selection list by clicking with the left mouse button.
- Select "ncACTIV_HI" by clicking with the left mouse button.

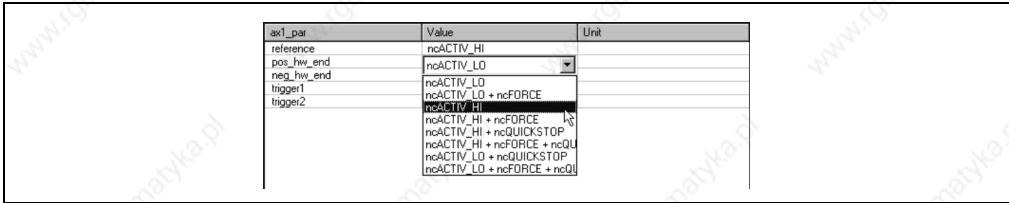

Figure 51: Change the level for the positive hardware end switch

- Acknowledge the selection by pressing the ENTER key.

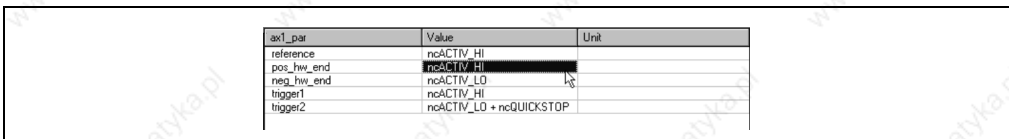

Figure 52: Acknowledge level change

Use the same procedure for the other two parameters, neg_hw_end and trigger2 (quickstop).

When all changes are made, the value list looks like this:

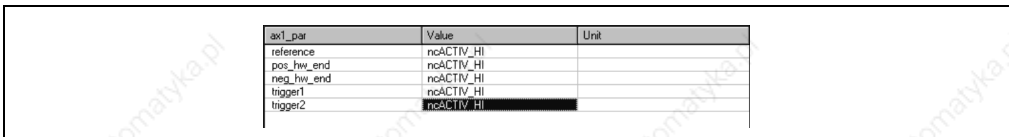

Figure 53: Levels after all changes are made

Now the object window can be closed.

- In the **File** menu, click on **Close**.

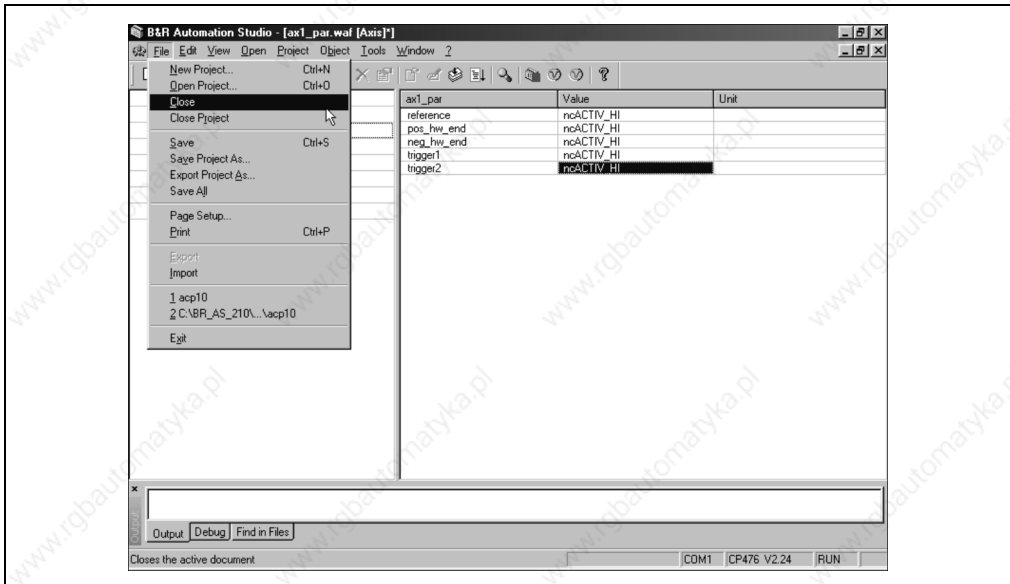

Figure 54: Closing the object window

- Acknowledge the changes by clicking the **Yes** button.

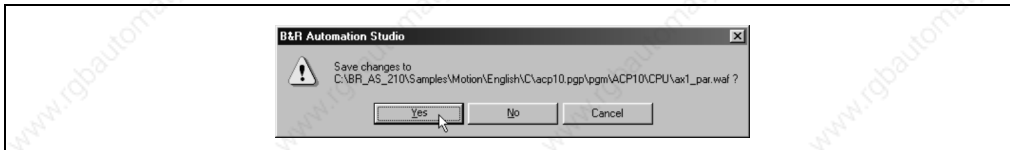

Figure 55: Acknowledge level changes

The project window will be shown again.

2.2.4 Downloading the Project

After making the preparations, the project can now be transferred to the target system:

- In the **Project** menu, click on **Transfer To Target**.

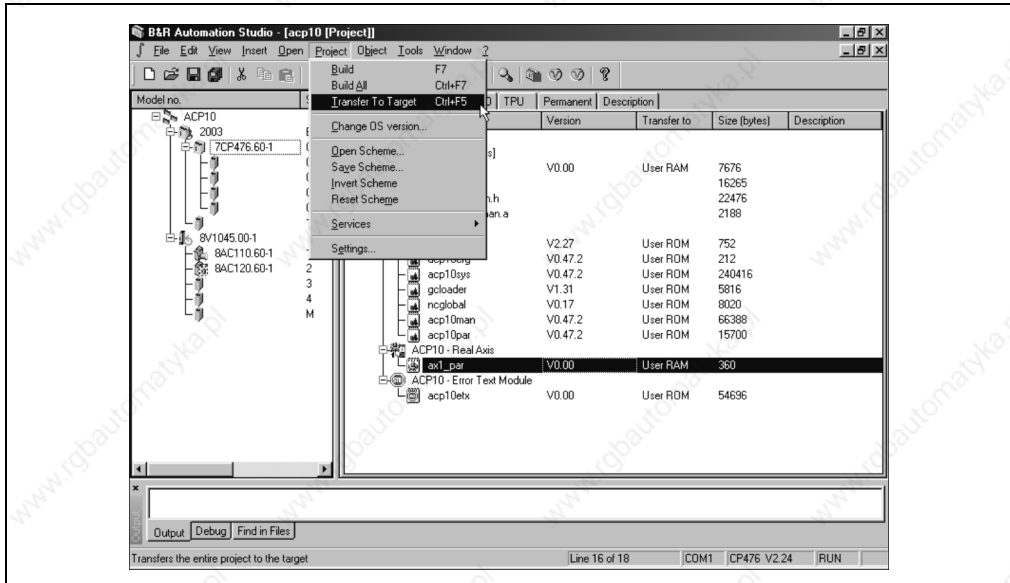

Figure 56: Click on the command to transfer the project to the target system

If an operating system has already been transferred to the PLC, a version conflict could occur. In this case, the operating system on the PLC is to be applied to the operating system in the sample project:

- Select option **Apply the current version**

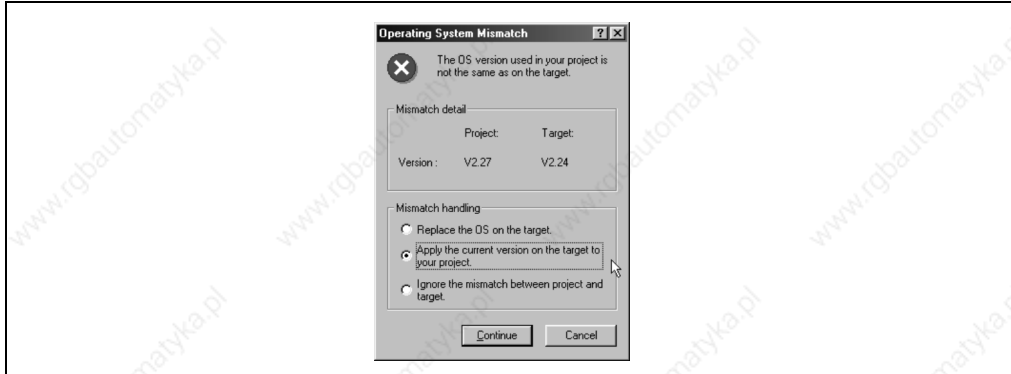

Figure 57: Operating system version conflict

- Acknowledge by clicking the **Continue** button.

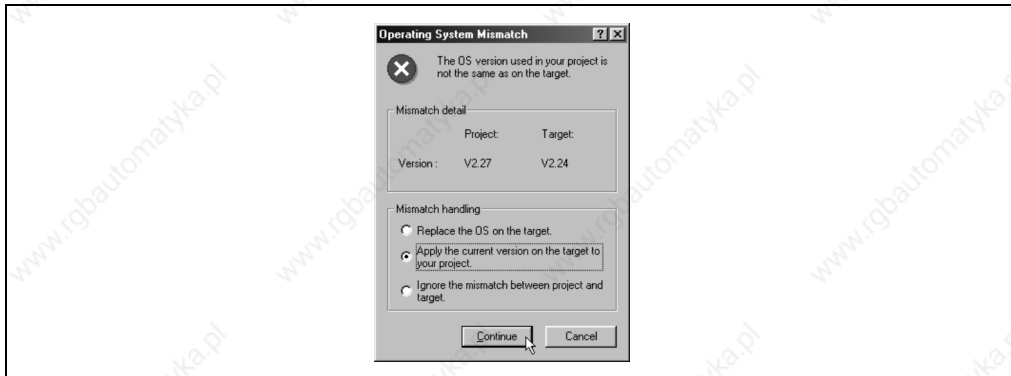

Figure 58: Acknowledge selection of conflict resolution

- A message will be displayed by B&R Automation Studio™. Acknowledge this message by clicking **Yes**.

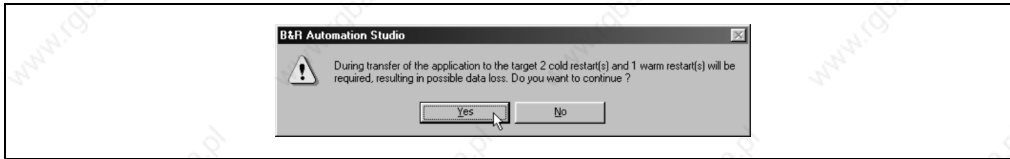

Figure 59: Acknowledge message from B&R Automation Studio™ with **Yes**

- The project is transferred.

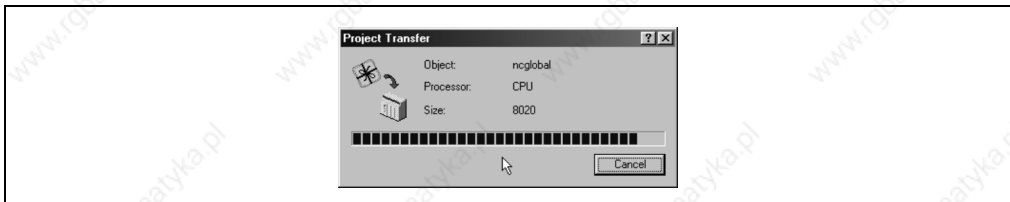

Figure 60: The project is transferred

- The following message is given after the project has been successfully transferred:

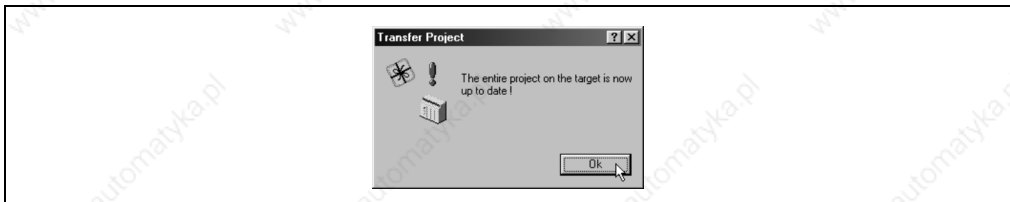

Figure 61: The project was transferred successfully

- Acknowledge the message by clicking the **OK** button.

2.2.5 Test Function

Now control of the motor shaft can be taken over using the test function (ACP10 - real axis):

- Position the cursor on the initial parameter module AX1_PAR.

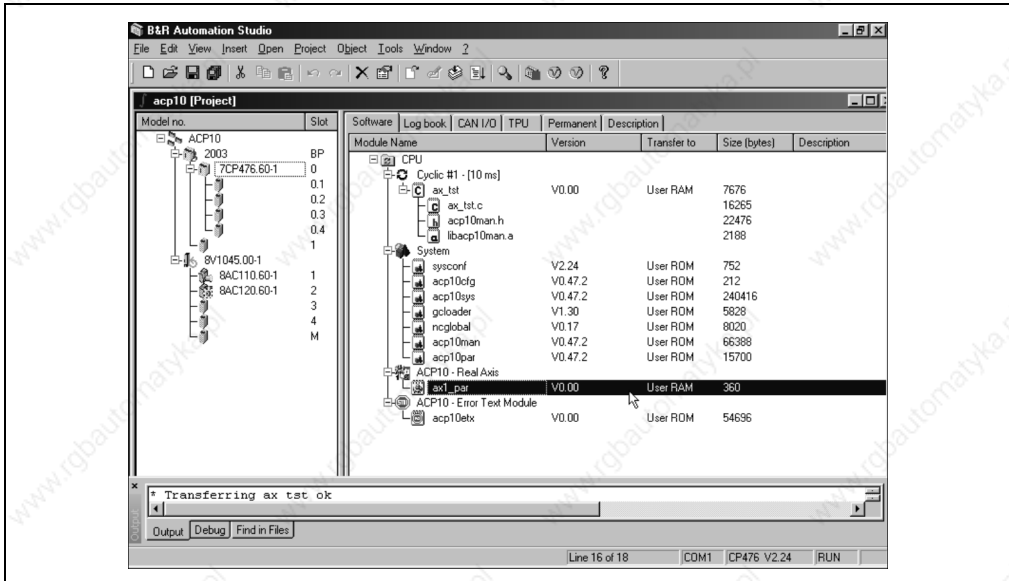

Figure 62: Select initial parameter module AX1_PAR

- In the **Open** menu, click on **Test**.

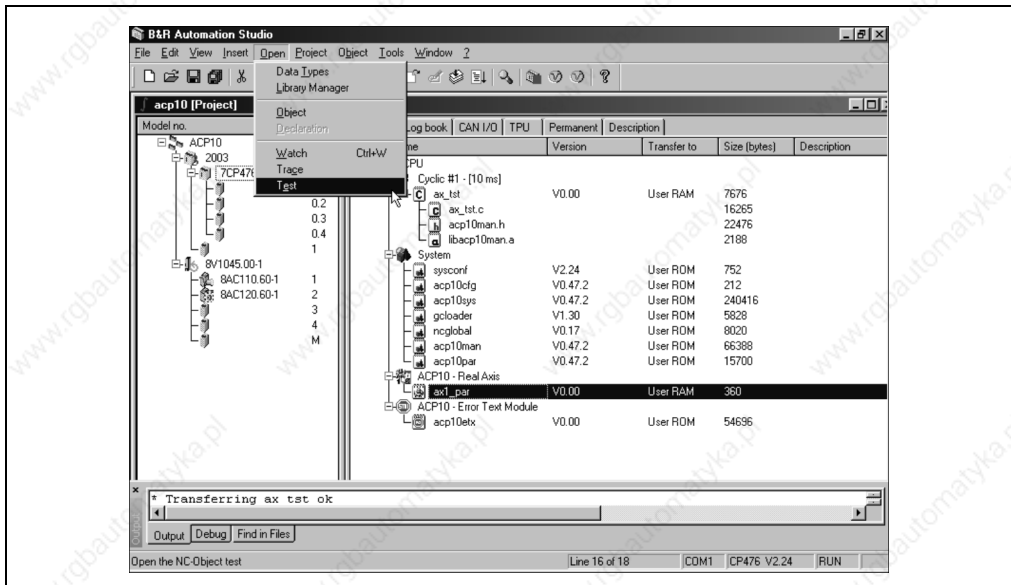

Figure 63: Command to open the test window

The test window is shown:

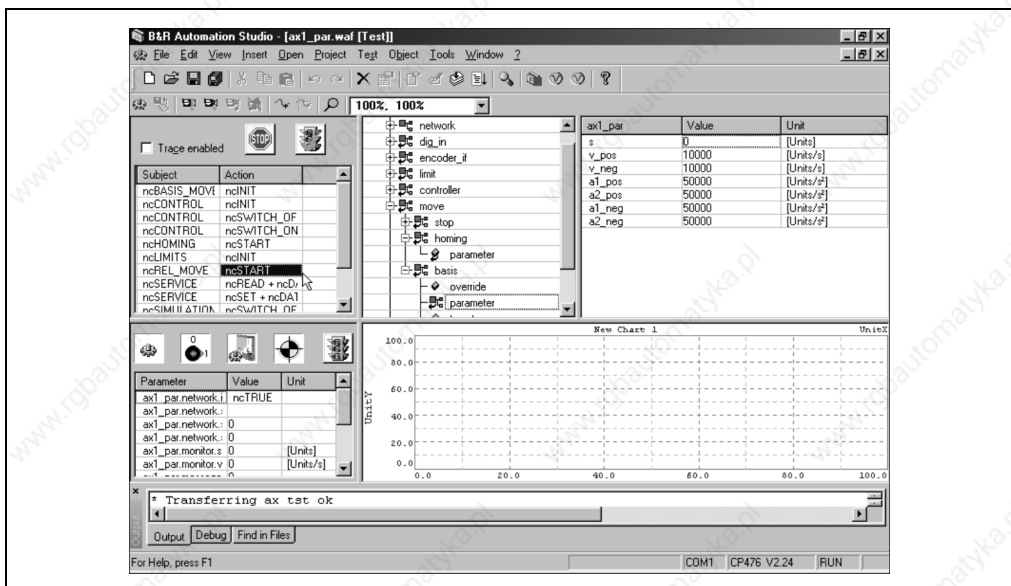

Figure 64: Test window for ACOPOS servo drives

2.2.6 Starting the Motor Movement

Danger!

The traverse path must be adjusted for the conditions present (installed mechanical parts, etc.).

Incorrect control of motors or mechanical parts connected to the motor shaft can cause unwanted and dangerous movements. This can cause severe personal injury or damage to property!

If mechanical parts are mounted on the motor, the number of encoder units per motor revolution must be adjusted to the mechanical characteristics (possible traverse path, etc.).

The number of encoder units per motor revolution (units, rev_motor) can be set as follows:

- Position the mouse pointer on "encoder_if"
- Expand the view by clicking on "+"
- Position the mouse pointer on "parameter"
- Expand the view by clicking on "+"
- Position the mouse pointer on "scaling"
- Expand the view by clicking on "+"
- Position the mouse pointer on "load"

The parameters are now shown in the right part of the window:

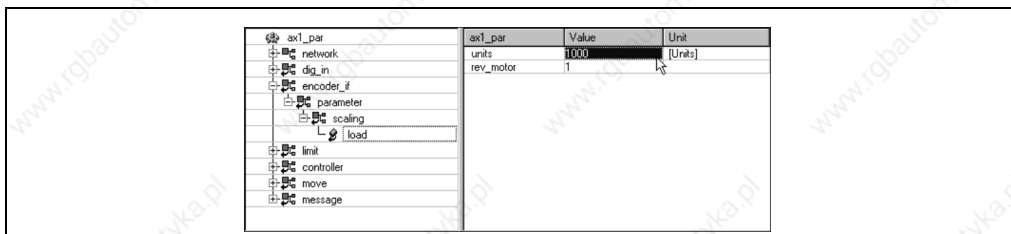

Figure 65: Setting the encoder resolution

Now the values can be adjusted to the mechanical parts used and acknowledged by pressing the ENTER key.

For additional safety, the traverse path can be limited using software end switches (pos_sw_end, neg_sw_end).

The software end switches can be defined as follows:

- Position the mouse pointer on "limit"
- Expand the view by clicking on "+"
- Position the mouse pointer on "parameter"

The parameters are now shown in the right part of the window:

ax1_par	ax1_par	Value	Unit
network	v_pos	50000	[Units/s]
	v_neg	50000	[Units/s]
encoder_#	a1_pos	500000	[Units/s²]
limit	a2_pos	500000	[Units/s²]
parameter	a1_neg	500000	[Units/s²]
controller	a2_neg	500000	[Units/s²]
move	t_jolt	0	[s]
message	t_in_pos	0	[s]
	pos_sw_end	2000000000	[Units]
	neg_sw_end	-2000000000	[Units]
	ds_warning	500	[Units]
	ds_stop	1000	[Units]

Figure 66: Defining the software end switches

Now the values can be adjusted to the mechanical parts used and acknowledged by pressing the ENTER key.

Entering the Traverse Path

- Position the mouse pointer on the **action** "ncSTART" for the **subject** "ncREL_MOVE" in the action window.

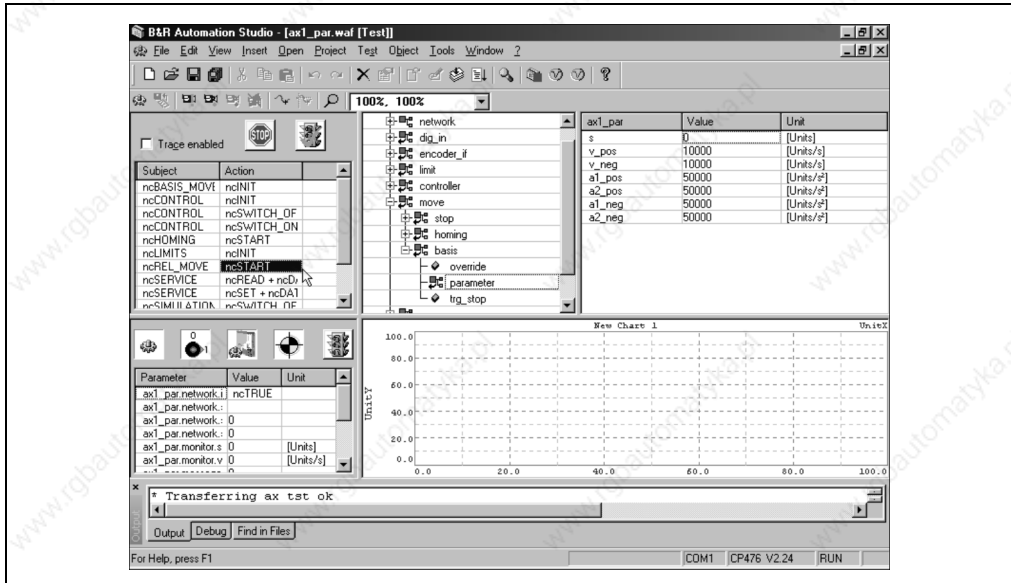

Figure 67: Place mouse pointer on the **action** "ncSTART"

- Enter the value (e.g. 5000) for s (target position or relative traverse path) in the **parameter** object , **value** column.

Danger!

The traverse path must be adjusted for the conditions present (installed mechanical parts, etc.).

Incorrect control of motors or mechanical parts connected to the motor shaft can cause unwanted and dangerous movements! This could result in death, severe injury or material damage.

- Acknowledge by pressing the ENTER key.

The new value is sent to the PLC.

Enabling the Trace Function

- Position the mouse pointer on the **Trace enabled** checkbox in the action window.
- Activate the checkbox by clicking on it with the left mouse button.

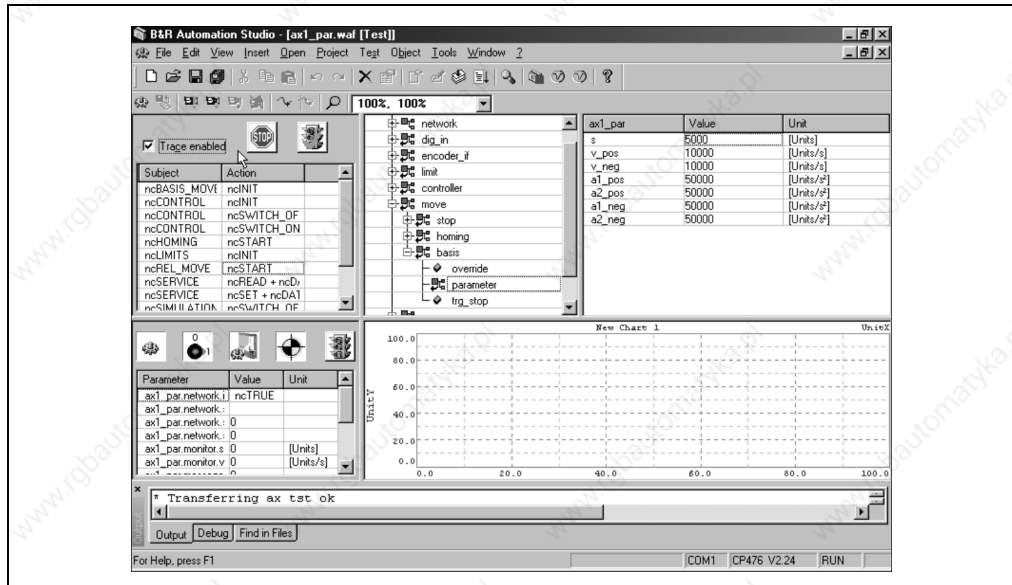
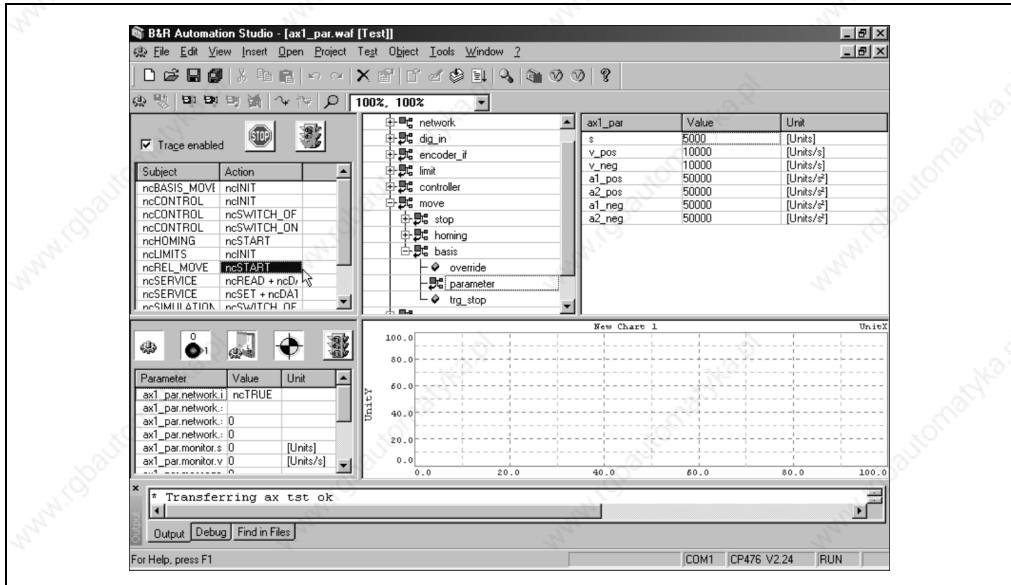



Figure 68: Enable trace function

Start the Motor Movement

- Position the mouse pointer on the **action** "ncSTART" for the **subject** "ncREL_MOVE" in the action window.

Figure 69: Place mouse pointer on the **action** "ncSTART"

- Click on the  button on the toolbar:

The motor shaft now moves according to the traverse path (s) defined and the Trace function starts.

Display and Evaluation of the Trace Function

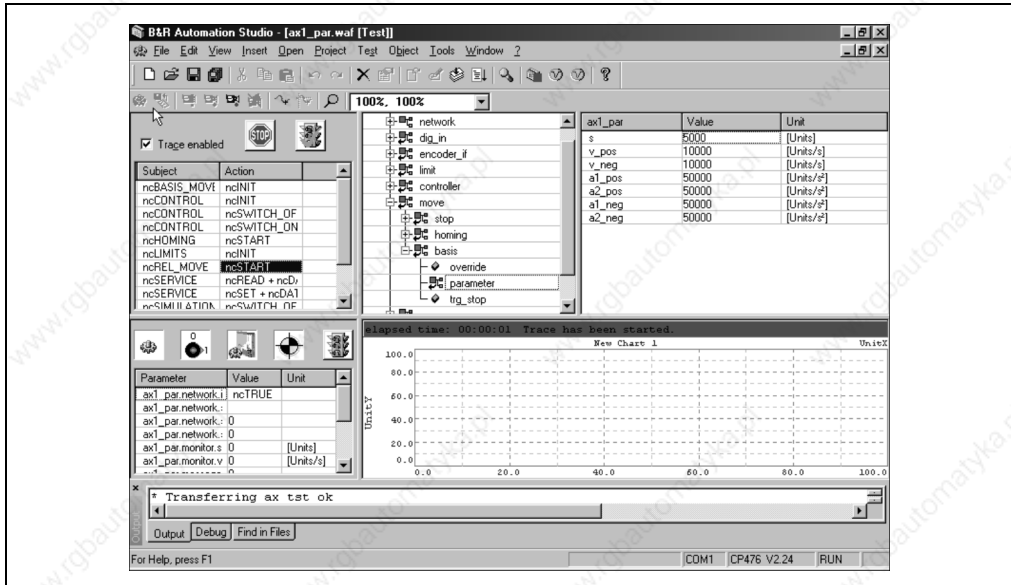

Figure 70: During the movement of the shaft, the traverse path already completed is shown in the Watch window

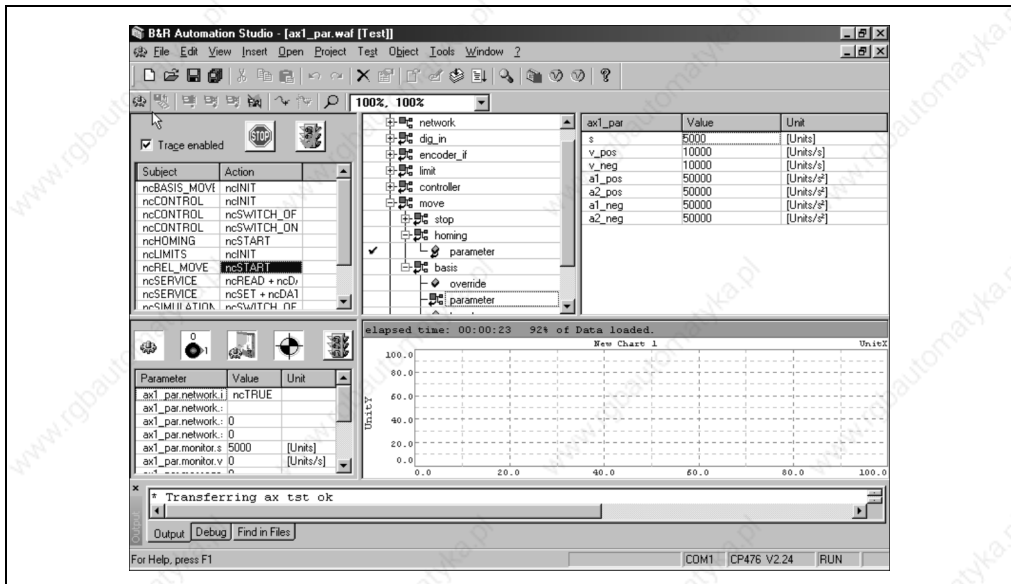

Figure 71: The defined traverse path was completed and the Trace data is loaded

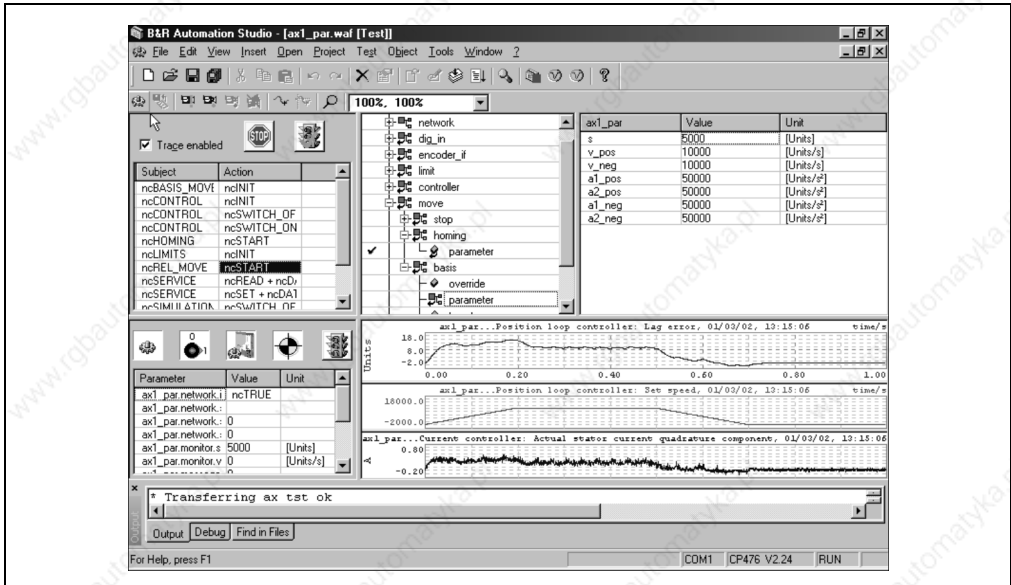

Figure 72: The data recorded is shown in the Trace window

The current position of the motor shaft is shown in the Watch window:

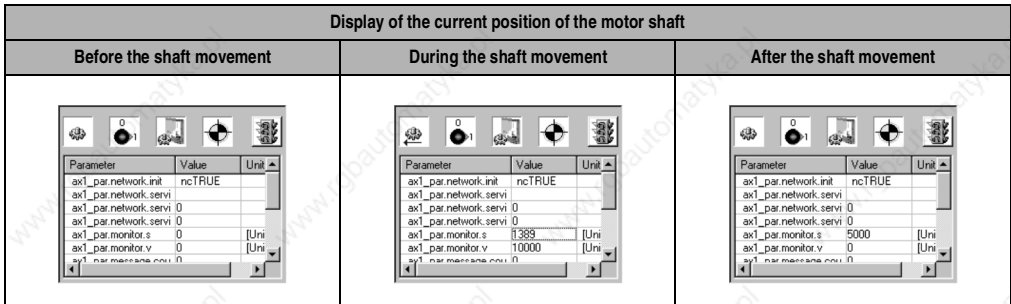

Table 74: Display of the current position of the motor shaft in the Watch window

The following data concerning shaft movement is displayed in the Trace window:

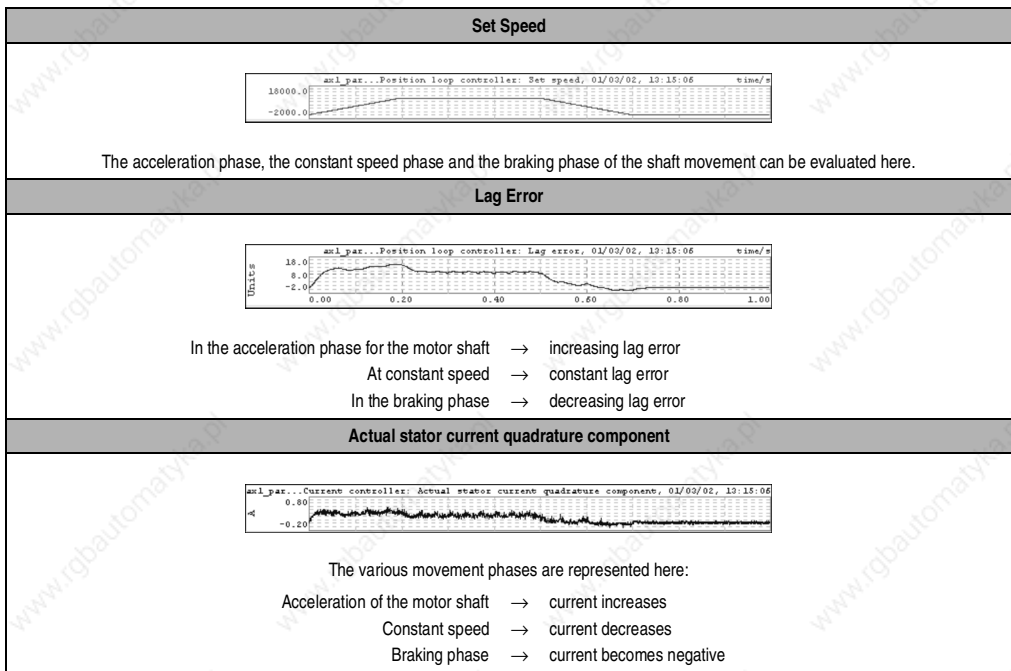

Table 75: Output of the recorded data in the Trace window

CHAPTER 7 • STANDARDS AND CERTIFICATIONS

1. Valid European Guidelines for ACOPOS Servo Drives

- EMC guidelines 89/336/EWG
- Low-voltage guidelines 73/23/EWG
- Machine guidelines 98/37/EG

2. Valid Standards for ACOPOS Servo Drives

Standard	Description
IEC/EN 61800-2	Adjustable speed electrical power drive systems: Part 2: General requirements - Rating specifications for low voltage adjustable frequency a.c. power drive systems
IEC/EN 61800-3	Adjustable speed electrical power drive systems: Part 3: EMC product standard including specific test methods
IEC 61800-5 (draft)	Adjustable speed electrical power drive systems: Part 5: Safety requirements - Electrical and thermal
IEC/EN 61131-2	Programmable controllers: Part 2: Equipment requirements and tests
IEC 60204-1	Safety of machinery - Electrical equipment of machines: Part 1: General requirements
EN 1037	Safety of machinery - prevention of unexpected start-up
IEC 61508	Functional safety of electrical / electronic / programmable electronic safety-related systems
IEC 954-1	Safety of machinery - safety-related parts of control systems Part 1: General principles of design TÜV: Sample test for secure restart prevention according to category 3 planned
UL 508 C	Power Control Equipment

Table 76: Valid Standards for ACOPOS Servo Drives

3. Electrical Limit Values for Immunity Tests according to IEC 61800-3

These immunity tests are valid for industry (2nd environment).

Tests according to IEC 61000-4-2 Electrostatic Discharge	
	IEC 61800-3
Contact discharge to powder-coated and bare metal housing parts	4 kV, criteria B
Discharge through the air to plastic housing parts	8 kV, criteria B

Tests according to IEC 61000-4-3 Electromagnetic Fields	
	IEC 61800-3
Housing, completely wired	80 MHz - 1 GHz, 10 V/m, 80 % amplitude modulation with 1 kHz, criteria A

Tests according to IEC 61000-4-4 Burst	
	IEC 61800-3
Power lines	2 kV, 1 min, criteria B, direct coupling
Lines for measurement and control functions in the process environment	2 kV, 1 min, criteria B
Signal interfaces, other lines	1 kV, 1 min, criteria B

Tests according to IEC 61000-4-5 Surge	
	IEC 61800-3
Power lines	1 kV (2 Ω), DM, symmetrical, criteria B 2 kV (12 Ω), CM, unsymmetrical, criteria B

Tests according to IEC 61000-4-6 HF Coupling	
	IEC 61800-3
Power lines	0.15 - 80 MHz, 10 V, 80 % amplitude modulation with 1 kHz, criteria A
Lines for measurement and control functions in the process environment	
Signal interfaces, other lines	

Table 77: Electrical Limit Values for Immunity Tests according to IEC61800-3

Performance Criteria (simplified)

Criteria A: Test object not influenced during test.

Criteria B: Test object only temporarily influenced during test.

Criteria C: The system does not reboot automatically (reset required).

4. Electrical Limit Values for Emission Tests according to IEC 61800-3

These emission tests are valid for industry (2nd environment).

Tests according to IEC 55011 (conducted emissions)			
Continuous Current on Motor	Frequency Range [MHz]	Quasi-peak Value	Average
I ≤ 100 A	0.15 ≤ f < 0.5	100 dB (μV)	90 dB (μV)
	0.5 ≤ f < 5	86 dB (μV)	76 dB (μV)
	5 ≤ f < 30	90 dB (μV)	80 dB (μV)
100 A < I	0.15 ≤ f < 0.5	130 dB (μV)	120 dB (μV)
	0.5 ≤ f < 5	125 dB (μV)	115 dB (μV)
	5 ≤ f < 30	115 dB (μV)	105 dB (μV)

Tests according to IEC 55011 (radiated emissions)	
Frequency Range [MHz]	Quasi-peak Value
30 ≤ f ≤ 230	40 dB (μV/m), measured at distance of 30 m
230 < f ≤ 1000	50 dB (μV/m), measured at distance of 30 m

Table 78: Electrical limit values for emission tests according to IEC 61800-3

5. Environmental Limit Values according to IEC 61800-2

Operational Conditions	
	IEC 61800-2
Environmental Temperature during Operation	5 to 40 °C
Relative Humidity during Operation	5 -85 %, non-condensing
Power Reduction in Relation to Installation Altitude ¹⁾	10 % per 1000 m installation altitude Max. 2,000 m above sea level
Degree of Pollution according to IEC 60664-1	2 (non-conductive material)
Overvoltage Category according to IEC 60364-4-443:1999	II
Protection according to IEC 60529	IP20
Vibration 2 ≤ f < 9 Hz 9 ≤ f < 200 Hz	0.3 mm amplitude 1 m/s ² acceleration

Storage and Transport Conditions	
Storage Temperature	-25 to +55 °C
Relative Humidity for Storage	5 - 95 %, non-condensing
Transport Temperature	-25 to +70 °C
Relative Humidity for Transport	95 % at 40 °C, non-condensing
Vibration during Transport 2 ≤ f < 8 Hz 8 ≤ f < 200 Hz 200 ≤ f < 500 Hz	3.5 mm amplitude 10 m/s ² acceleration 15 m/s ² acceleration

Table 79: Environmental Limit Values according to IEC 61800-2

1) Unusual operating conditions must be arranged with B&R.

6. International Certifications

B&R products and services comply with the applicable standards. These are international standards from organizations such as ISO, IEC and CENELEC, as well as national standards of organizations such as UL, CSA, FCC, VDE, ÖVE, etc. We give special consideration to the reliability of our products in an industrial environment.



Certifications	
USA and Canada 	All important B&R products are tested and listed by Underwriters Laboratories and are checked quarterly by a UL inspector. This mark is valid for the USA and Canada and eases certification of your machines and systems in these areas. Listing is planned for ACOPOS servo drives.
Europe 	All harmonized EN standards for the valid guidelines are met.
Russian Federation 	A GOST-R certification is planned for the export of ACOPOS servo drives in the Russian Federation.

Table 80: International Certifications

Numerics

8AC110.60-2.....	36	8PM002.00-1.....	62
8AC120.60-1.....	39	8PM003.00-1.....	62
8AC122.60-1.....	42	8PR001.00-1.....	65
8AC123.60-1.....	44	8V1022.00-1.....	31
8AC130.60-1.....	47	8V1045.00-1.....	31
8CE005.12-1.....	57	8V1090.00-1.....	31
8CE007.12-1.....	57	8V128M.00-1.....	33
8CE010.12-1.....	57	8V1640.00-1.....	33
8CE015.12-1.....	57		
8CE020.12-1.....	57	A	
8CE025.12-1.....	57	AC110.....	36, 116
8CM005.12-1.....	52	AC120.....	38, 117
8CM005.12-3.....	52	AC122.....	41, 118
8CM005.12-5.....	53	AC123.....	44, 119
8CM005.12-8.....	53	AC130.....	47, 120
8CM007.12-1.....	52	ACOPOS	
8CM007.12-3.....	52	1022.....	31, 108
8CM007.12-5.....	53	1045.....	31, 108
8CM007.12-8.....	53	1090.....	31, 108
8CM010.12-1.....	52	128M.....	33, 112
8CM010.12-3.....	52	1640.....	33, 112
8CM010.12-5.....	53	See Servo Drives	
8CM010.12-8.....	53		
8CM015.12-1.....	52	B	
8CM015.12-3.....	52	Braking resistance.....	94
8CM015.12-5.....	53		
8CM015.12-8.....	53	C	
8CM020.12-1.....	52	Cables	
8CM020.12-3.....	52	Encoder Cables	
8CM020.12-5.....	53	EnDat.....	57, 125
8CM020.12-8.....	53	Resolver.....	59, 127
8CM025.12-1.....	52	General Information.....	51
8CM025.12-3.....	52	Motor Cables.....	52, 122
8CM025.12-5.....	53	Cam Editor.....	19
8CM025.12-8.....	53	CAN Bus Interface AC110.....	36, 116
8CR005.12-1.....	59	Certifications.....	163
8CR007.12-1.....	59	Configurations	
8CR010.12-1.....	59	CAN.....	20
8CR015.12-1.....	59	Connections	
8CR020.12-1.....	59	ACOPOS Servo Drives.....	108
8CR025.12-1.....	59	Cable and Plug.....	122
8PE001.00-1.....	65	Plug-in Modules.....	116
8PM001.00-1.....	62		

Index

- Connector
 - Encoder Connector
 - EnDat 65, 125
 - Resolver 65, 127
 - General Information 61
 - Motor Connectors 62, 123
 - Correctly installing cooling aggregates 78
 - Cross Sections 107
- D**
- Danger Warning 22
 - DC Bus 89
 - Digital Mixed Module AC130 47, 120
 - Dimensioning
 - Braking resistance 94
 - Current Requirements of Plug-in Modules .
100
 - DC Bus 89
 - Formula Variables 101
 - Motor Connection 92
 - Power Mains Connection 81
 - Dimensions 71
 - Drive Oscilloscope 18
 - Drives
 - See Servo Drives
- E**
- Electromagnetic Compatibility of the Installation 103
 - Embedded Parameter Chip 13
 - Encoder Cables
 - EnDat 57, 125
 - Resolver 59, 127
 - Encoder Connector
 - EnDat 65, 125
 - Resolver 65, 127
 - Encoder Resolution 150
 - Encoder Systems
 - EnDat Encoder Interface 39, 117
 - Incremental/SSI Encoder IF 44, 119
 - Resolver interface 42, 118
 - EnDat Cables
 - Cable Schematic 126
 - Order Data 57
 - Pin Assignments 125
 - Specifications 57
 - Structure 125
 - EnDat Connector
 - Order Data 65
 - Pin Assignments 125
 - Specifications 66
 - EnDat Encoder Interface AC120 39, 117
- F**
- Formula Variables 101
 - Function Test 17, 155
- G**
- Getting Started 129
 - Guidelines 159
- I**
- Incremental/SSI Encoder IF AC123 ... 44, 119
 - Installation 23, 69, 103
 - Installation Dimensions 71
- L**
- Limit Values 160
- M**
- Modular Servo Drive Concept 27
 - Motor Cables
 - Cable Schematic 123, 124
 - Order Data 52
 - Pin Assignments 123, 124
 - Specifications 54
 - Structure 122

Motor Connectors	
Order Data.....	62
Pin Assignments.....	123, 124
Specifications	63
Motors	
Configurations	20
Embedded Parameter Chip	13
General Information.....	13

N

NC Objects	16
------------------	----

P

Plug-in Modules	
AC110	36, 116
AC120	38, 117
AC122	41, 118
AC123	44, 119
AC130	47, 120
Current Requirements	100
General Information.....	14, 35
Installation and Removal	74
Overview	35
Power Mains Connection.....	81
Programming	15
Protective Ground Connection (PE) ..	82, 111

R

Resolver Cables	
Cable Schematic	128
Order Data.....	59
Pin Assignments.....	127
Specifications	60
Structure	127
Resolver Connector	
Order Data.....	65
Pin Assignments.....	127
Specifications	67
Resolver Interface AC122.....	42, 118

S

Safety Guidelines	22
Sample Project	130
Security.....	13, 14
Service.....	15
Servo Drives	
ACOPOS 1022, 1045, etc.	31, 108
Cables	
See Cable	
Cam Editor	19
Concept.....	27
Configurations	
CAN	20
Connections	108
Connector	
See Connectors	
Danger Warning	22
Dimensioning	81
Dimensions	71
Drive Oscilloscope	18
Function Test	17, 155
General Information	13, 27
Installation	23, 69, 103
Installation Dimensions	71
NC Objects.....	16
Order Data	31
Plug-in Modules	14, 35, 74, 100, 116
Programming.....	15
Safety Guidelines	22
Sample Project.....	130
Service	15
Software	15
Start-up	129
Status LEDs	29
Storage.....	22
Technical Data	31
Trace	17, 155
Transport.....	22
Trigger.....	18
Wiring.....	103

Index

Shield Connection.....	105
Software.....	15
Software End Switches.....	151
Standards	159
Start-up.....	129
Status LEDs	
ACOPOS.....	29
Storage.....	22

T

Terminal Cross Sections	107
Trace	17, 155
Transport	22
Trigger.....	18

W

Wiring	103
--------------	-----

MAACP1-E