

OPERATION & CONNECTING MANUAL

HUST H2PN CONTROLLER

EDITION : 2008 / 06 / 17

HUST Automation Inc.

No. 80 Kon Yei Road, Toufen, Miaoli, Taiwan

Tel: 886-37- 623242

Fax: 886-37-623241

CATALOG

1 H2PN CONTROLLER FUNCTIONS & FEATURES MANUAL 1-1

2 OPERATION 2-1

2.1	Basic Operation	2-1
2.2	Edit Program	2-13
2.3	Operation of Sub-Program	2-27

3 MCM Machine Constant Parameters 3-1

3.1	MCM	3-1
3.1.1	Basic MCM	3-1
3.1.2	Further MCM	3-1
3.1.3	Special MCM	3-4
3.2	MCM Description	3-5

4 APPEARANCE & CONNECTION 4-1

4.1	Connection Manual	4-1
4.2	Installation And Dimension	4-2
4.2.1	Environmental Requirements	4-2
4.2.2	Cabinet Considerations	4-2
4.2.3	Thermal Design in the Cabinet	4-3
4.3	Appearance and Size	4-5
4.4	Output / Input Board Connection	4-8
4.4.1	Input Signals	4-9
4.4.2	Output Signals	4-10
4.5	Connecting Diagrams	4-11
4.5.1	Positioning Control Connection	4-13
4.5.2	MPG Hand-wheel Connecting Diagram	4-16

5 Information and Description of Inspecting Error 5-1

6	APPENDIX	6-1
6.1	Appendix A Input/Output (I/O) List	6-1
6.2	Appendix B Command Code List	6-3
6.3	Appendix C Program Description for Example	6-5
6.4	Appendix D HUST H2PN&MR- J2S connection	6-7

1 H2PN Controller function & quality manual

- Control the number of axis ; X , Y two axes. One-axis encoder feedback is added.
- Two axes arrive at the same time & Master-Slave mode.
- 512k program memory.
- Edit program with blank-talking way. Users don't have to memorize lots of annoying injunctions.
- Touch-Panel introduction & Program editing commentary with example. (Screen Help)
- Teach-Mode function in program editing. (Teach Mode)
- Define the circular function of program block.
- The program can be adjusted during the AUTO RUN.
- After power-off , the program can be saved with battery backup. (Battery Backup)
- Backlash compensation ; it will adjust the gear-chink error due to the used.
- Repeat circulation and a circulation.
- Optional jump. (Option Jump)
- AUTO RUN and Feed Hold.
- Self-test and point out the error. (Self Test)
- Interface of MPG , MPG test is available . Prevent machinery crash. (MPG Test)
- Offer standard 28 inputs and 20 outputs.

This operation manual includes basic operation 、 program edition 、 MCM setting 、 connection 、 distribution of input/output 、 protection(Error description)
Once you have read this manual , but you still don't understand all. Or there is some problem occurred when you are using our controller. Then please describe the problem and send it to us with fax or mail. We will reply your question as soon as possible.

2 Operation

2.1 Basic Operation

Description of screen and operation

* **Power-On screen**

Turn the controller power on and then the power-on screen is shown



P2-1

* **Standby screen**

After 3 seconds, the standby screen is shown (Press RESET key will also enter this screen)

As picture below: P2-2 is single axis screen, P2-3 is double axis screen

The pictures below are suit for double axis:

When the power-on is ready, the system will load calculate program first. So it is normal that the program number has some changes.

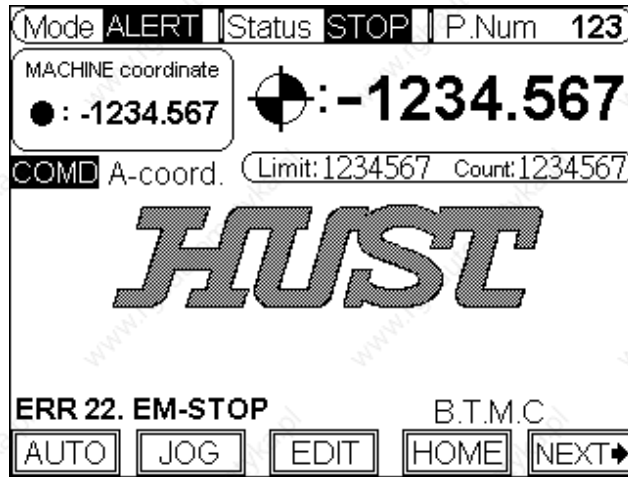

P2-2

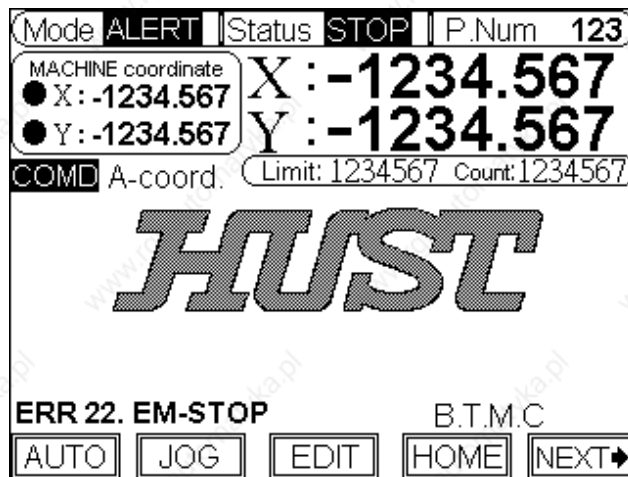

P2-3

* **Auto Mode screen**

Press 『F1』 to enter Auto-Mode, the screen as below:

Mode **AUTO** | Status **STOP** | P.Num 123

Limit: 1234567 X: -1234.567
Count: 1234567 Y: -1234.567

COMD A-coord.

N	C	X	Y	F	D
01	1	0.000	0.000	100	
02	4				2
03	5				3
04	1	100.000	200.000	50	
05	5				-3

B.T.M.C

RET P.F.H 1-CYC MPG.T E.W.E

Showing the program content or not is set by special MCM

Auto-mode show the program content. The 『E.W.E』 key will show up when the Auto run. E.W.E is edition when executing

P2-4

In auto-mode there are soft keys as follow :

1. **Program Feed Hold (F2) :** It only works when the program is executing.

When the program is executing , you can stop program immediately by pressing this key. The program will continue unless pressing 『RESET』 key to interrupt the program or pressing the 『CYCST』 key.

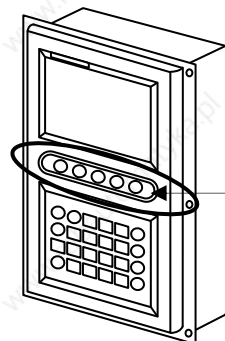

2. **One Cycle (F3) :** You can choose this function at any time no matter the program is executing or feed hold.

When the repetitious circulation is on , if the function of counter limit is off or the counter does not reach the value , then the program will run unstoppably. You can press F3 to let it stop at the location of program ending.

3. **MPG Program Test (F4) :** You can choose this function at any time no matter the program is executing or feed hold.

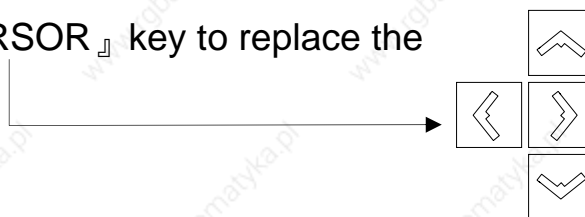

When this function is chosen and executing , any motion of program will be controlled by MPG pulse . The motion of program will stop when the MPG pulse dose not feed-rate.

※You can also use 『CURSOR』 key to replace the MPG feed-rate.





4. **Edition When Executing**

Special mode 1 (AUTO MODE ; Show the program content)

- (1) Enter the basic MCM page.
- (2) Press  key and  key each twice within one second.
- (3) Press 『F3』 . (special key)
- (4) The value-set of first line【AUTO MODE , the program content is showing】 is “ 1 ”.

Special mode 2 (AUTO MODE ; Show the program content and the corrected program content)

- (1) Enter the basic MCM page.
- (2) Press  key and  key each twice within one second.
- (3) Press 『F3』 . (special key)
- (4) The value-set of first line【AUTO MODE , the program content is showing】 is “ 256 ”.

Description :

- (1) AUTO MODE ; Press 『CYCST』 key.
- (2) When the program is executing , the 『E.W.E』 key will show on the lower side of screen.

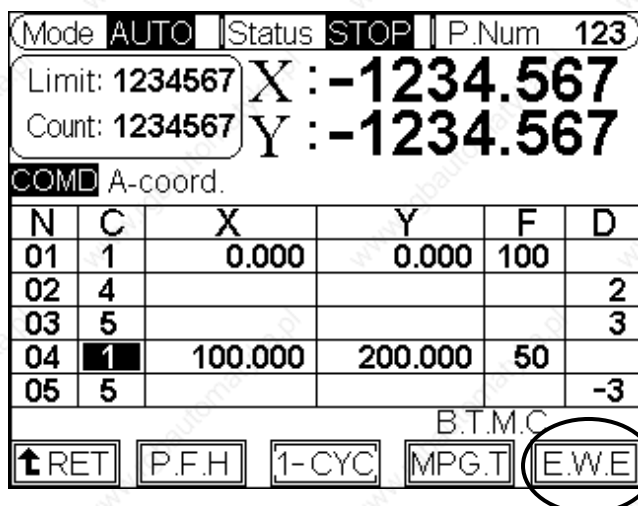

- (3) Press 『F5』 key , 『E.W.E』 will highlight.
- (4) In E.W.E mode and use CURSOR key to correct the content of program when the program is executing.

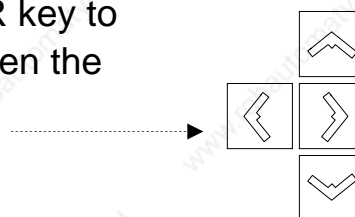

- (5) When the correction is finished , press 『E.W.E』 key again , The controller will go back to AUTO MODE again(Highlight of 『E.W.E』will be canceled) , and the program correction will be effective in the next cycle→ The program is executing , There will effective when the “Repetitious cycle” command is on.

Limitation :

- (1) When the program is executing , the limitation of correcting program is described below :
 - a. 【J-Column】 and 【L-Column】 Value can't be corrected.
 - b. The key of 【Insert】 and 【Delete】 will fail.
- (2) Correcting program data when the program is executing , the controller will go back to AUTO MODE. At this time because it recalculates the program data , there is some delay before next cycle.
- (3) When system are showing the program content under AUTO MODE , the scan time will be longer that it will infect the fluency between single block.
So , please do not show the program content when the program is executing , if the motion response is very fast.

* JOG Mode screen

Press 『JOG』 to enter jog mode , the screen is displayed below :

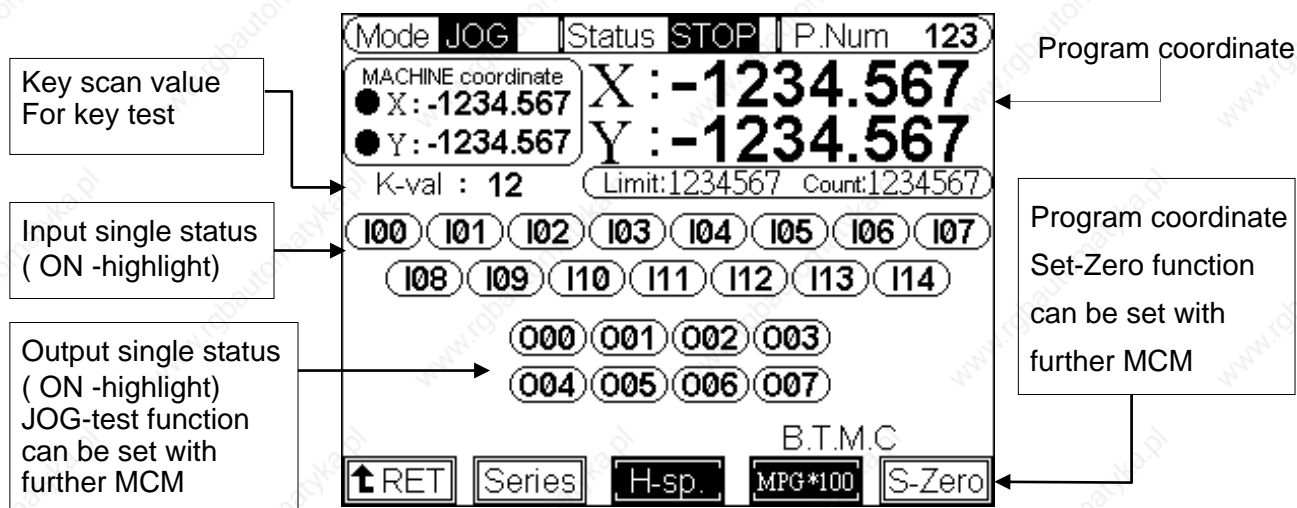

P2-5

- (1) On the basic MCM page, keeping pressing 『 F5 』 blank key for 5 seconds will enter further MCM page.
- (2) Set the value of 【output test function under jog mode】 as 1.
- (3) Enter JOG mode and press numeral key 0 to 7. It can test independently if the correspondent output signal (O00~~O07) is normal or not. By pressing once the output signal is on , and when pressing again the output signal will be off.
- (4) When output signal already on then it can't be test. If you leave the JOG mode , all the output signal will return to the former status before entering JOG mode automatically.

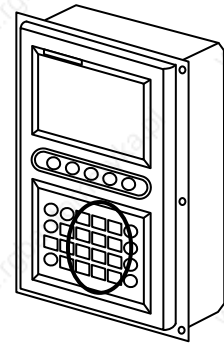

※Attention : When using JOG mode to test , you must pay attention to that if there is any danger of machinery crash .

Under JOG mode , the movement of axis can be controlled :

Under **JOG** mode , the description of 『 F2~F4 』

1. **JOG** mode (F2) : 『 Series 』、 『 1 』、 『 0. 1 』、 『 0.01 』、 『 0.001 』 .
2. **JOG** speed (F3) : 『 L-sp. 』、 『 M-sp. 』、 『 H-sp. 』 .
3. **JOG** way (F4) : 『 ~~MPG~~ 』、 『 MPG*1 』、 『 MPG*10 』、 『 MPG*100 』 .



S-Zero (F5): Program coordinate Set-Zero

- (1) On the basic MCM page , keep pressing 『 F5 』 blank key for 5 seconds to enter further MCM page.
- (2) Set the value of 【(S-Zero) key function under **JOG** mode】 as 1.
- (3) Return to **JOG** page. The status will be blank if this function is off.





- (4) When this function is on , keeping pressing 『S-Zero』 for 2 seconds will set the program coordinate as zero. Machine coordinate will be set as zero depended by if the axis direction has “HOME” movement.
- (5) If there is setting about “ Back to the Machine coordinate before CYCST” in page 3 of further MCM
- Setting value = 1 ; The X-axis Machine coordinate will not be set as zero.
 - Setting value = 2 ; The Y-axis Machine coordinate will not be set as zero.
 - Setting value = 3 ; The Z-axis Machine coordinate will not be set as zero.
- (6) This coordinate setting-zero institution is not allowed when the axis is moving.

Operation description :

1 MPG operation :

- Choose 『MPG*1』、 『MPG*10』、 『MPG*100』
- Choose axis (Press page 『』、 『』 key. The chosen axis will highlight on the screen.
- MPG feed-rate.

2 Pressing key way :

- Press 『F4』 , choose 『~~MPG~~』 key.
- Press 『F2』 , choose executing mode. 『Series』 key.
- Keep pressing the cursor  . X axis is executing on the positive direction. Keep pressing the cursor  . X axis is moving on the negative direction.
- Keep pressing the cursor  . X axis is executing on the positive direction. Keep pressing the cursor  . X axis is executing on the negative direction.
- Press 『F2』 , choose executing mode 『1』、 『0.1』、 『0.01』、 『0.001』 . Then press cursor to move the distance 『1』、 『0.1』、 『0.01』、 『0.001』 by chosen axis and direction.

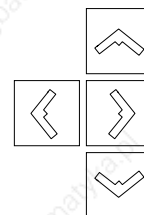

**** EDIT MODE screen**

On "standby" screen (P 2-6), press 『EDIT』 key to enter EDIT mode , the screen is shown as (P 2-7) :

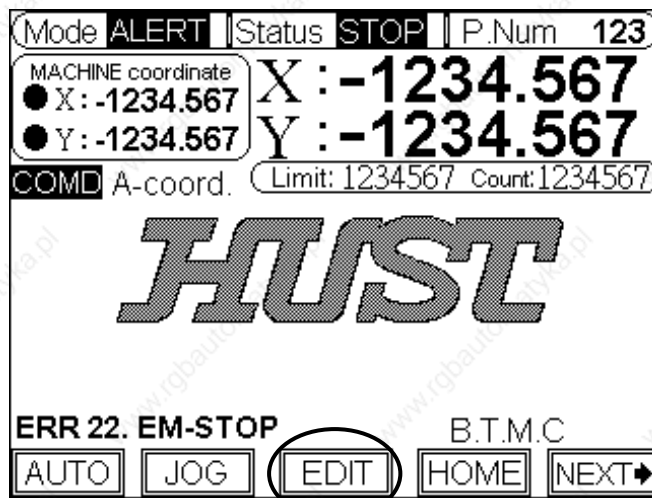

P2-6

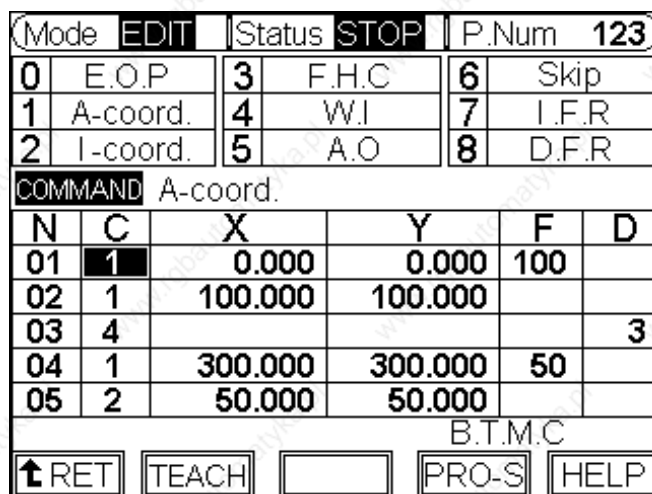

P2-7

※ Detail program editing operation is described in 2.2 『Program Edition』 chapter (Page 13)

* **HOME mode screen**

Press 『HOME』 to enter home mode, the screen is shown as below :

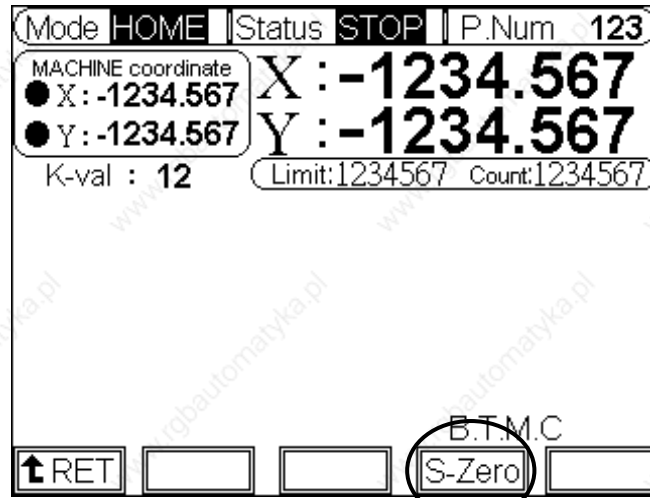

P2-8

HOME operation :

1. Directly press cursor 『 ← 』、 『 → 』 . X axis returns to machine coordinate.
2. Directly press cursor 『 ↓ 』、 『 ↑ 』 . Y axis returns to machine coordinate.
3. Press CYCST key. The both two axes return at machine coordinate at the same time.

PS : In the further MCM (P 2-9) , when setting “Back to the Machine coordinate before CYCST” =1 , there will be HOME movement by pressing 【CURSOR】 key or 【CYCST】 key. If the setting value=0 , there will be no HOME movement.

Setting value =1 , only X-axis HOME is on.

Setting value =2 , only Y-axis HOME is on.

Setting value =3, X、Y-axis HOME is on.

Further MCM	
54. Coordinate set-zero when CYCST. 0:NO 1:X 2:Y 3:XY	0
55. Back to the machine coordinate before CYCST. 0:NO 1:X 2:Y 3:XY	0
56. Set the coordinate as zero or not when the program is executing at the end. 0:NO 1:X 2:Y 3:XY	0

P2-9

Program coordinate Set-Zero : (S-Zero)

Keeping pressing the S-Zero 『F4』 for 2 second (P 2-8) can set current program coordinate as zero.

PS :

1. In the further MCM , when setting “Back to the Machine coordinate before CYCST”=1 , this operation of set-zero only set the program coordinate as zero and reserve the machine coordinate.
2. In the further MCM , when setting “Back to the Machine coordinate before CYCST” =0 , Keeping pressing the S-Zero key for 2 second will set the coordinate of program and mechanic as zero.

※ On standby screen , pressing the soft key 『NEXT』 can exchange the function of soft key.

After exchanging the screen is shown as (P 2-11)

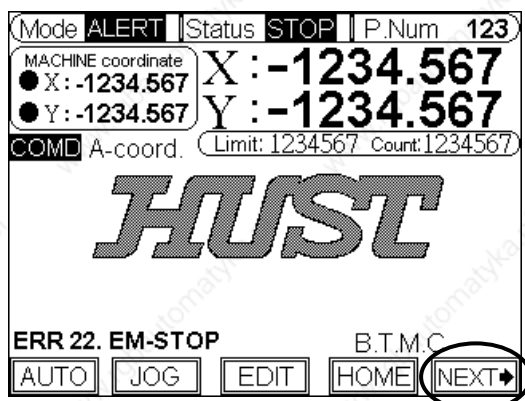

P2-10

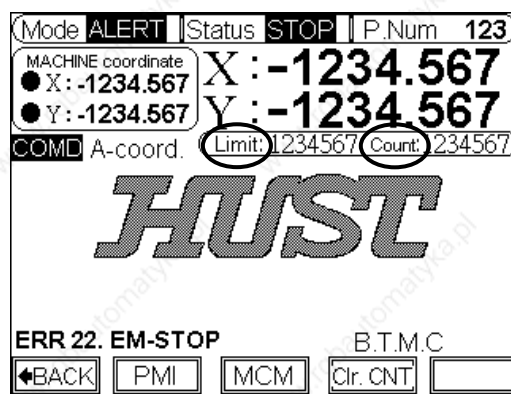

P2-11

* 『CONT』 (P 2-11) :

When the program is executing to the end or repetitious cycle (R-cyc.), the counter will add by 1.

If you want to set it zero, please keep pressing 『CONT 0』 for 2 seconds. Then it will be zero.

* 『CONT limit』 (P 2-11) :

1. Set by the basic MCM. (P 2-12)
2. When the counter value has reached the limit, the program will stop and CYCST key fail.
3. The 『LIMIT』 on the screen will be twinkling.

1. Set the JOG feed-rate of X-axis	1000
2. Set the JOG feed-rate of Y-axis	1000
3. Counter Limit (0~9999999)	0
4. The program output time of one cycle	0.00 S
5. Output time of program ending	0.00 S
6. Output time of positioning completed	0.00 S
7. Output time of counter reached	0.00 S
8. RS232 Baud Rate	38400
9. Set the Max ratio value of denominator of the program speed edition.	0
10. The preset speed of program edition	0
11. The pausing time of each divided feed-rate	0.00 S
Basic MCM	
↑RET	TOP
SPECIAL	VER

P2-12

* Inspection screen

Press 『Inspe.』 to enter inspectional page. The input and output signal is shown as page below :

I00 Interrupt Feed-rate	O00 Servo on output
I01 Skip Selection	O01
I02 Division Feed-rate	O02
I03 Y-HOME limit switch	O03
I04 Y-(+) O.T. limit switch	O04 1-Cycle output
I05 Y(-) O.T. limit switch	O05 Counter limit output
I06 Y servo alarm	O06 Positioning Finished
I07 CYCST	O07 Program End output
I08 STOP	
I09 Feed-Hold	
I10 X-HOME limit switch	
I11 X-(+) O.T. limit switch	
I12 X(-) O.T. limit switch	
I13 X servo alarm	
I14 EM-STOP	

↑RET [] [] [] []

P2-13

1. On this screen you can inspect the status of I/O (Input/Output signal).
2. "ON" signal will highlight on the screen.
3. Unused signal of input or output can be set as the **status off** in the special MCM. And these will not have the definition pointer.

* Basic MCM screen

Press 『MCM』 key to enter basic MCM setting mode, the screen is shown below :

1. Set the JOG feed-rate of X-axis	1000
2. Set the JOG feed-rate of Y-axis	1000
3. Counter Limit (0~9999999)	0
4. The program output time of one cycle	0.00 S
5. Output time of program ending	0.00 S
6. Output time of positioning completed	0.00 S
7. Output time of counter reached	0.00 S
8. RS232 Baud Rate	38400
9. Set the Max ratio value of denominator of the program speed edition.	0
10. The preset speed of program edition	0
11. The pausing time of each divided feed-rate	0.00 S
	Basic MCM

↑RET [TOP] [SPECIAL] [VER] []

P2-14

※ The detailed description of each basic MCM is explained in chapter 3 『MCM』 .

Press 『VER』 key to enter the mode of version display , the screen is shown below :

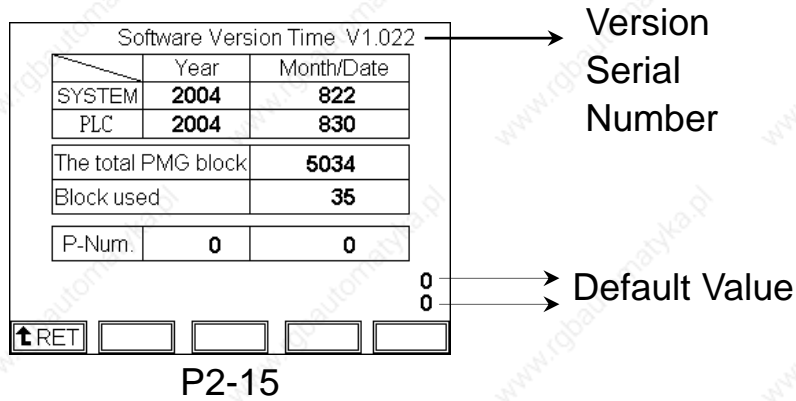

The screen display the SYSTEM&PLC time(Year Month Date)

SYSTEM : 2004 1105

PLC : 2004 1105

It presents that the system version time is November 5th, 2004

The screen display the PLC time(Year Month Date)EX : 2004 1105

2.2 Edit Program

Press 『EDIT』 key (as P 2-16). When the cursor moves on the subject of data. Then press 『>』 will display another subject (as P 2-17). (Single axis mode is shown on the same screen)

Mode		EDIT		Status		STOP		P.Num		123	
0	E.O.P	3	F.H.C	6	Skip						
1	A-coord.	4	W.I	7	I.F.R						
2	I-coord.	5	A.O	8	D.F.R						
COMMAND A-coord.											
N	C	X	Y	F	D						
01	1	0.000	0.000	100							
02	1	100.000	100.000								
03	4				3						
04	1	300.000	300.000	50							
05	2	50.000	50.000								
B.T.M.C											
↑RET		TEACH		PRO-S		HELP					

P2-16

Mode		EDIT		Status		STOP		P.Num		123	
0	E.O.P	3	F.H.C	6	Skip						
1	A-coord.	4	W.I	7	I.F.R						
2	I-coord.	5	A.O	8	D.F.R						
COMMAND A-coord.											
N	C	X	Y	J	L						
01	1	0.000	0.000	1	3						
02	1	100.000	100.000								
03	4										
04	1	300.000	300.000	9							
05	2	50.000	50.000								
B.T.M.C											
↑RET		TEACH		PRO-S		HELP					

P2-17

※ The highlight location is the edit location.

1. Use cursor key 『<』、『>』 to move the cursor to the edition column.
2. Use cursor key 『^』、『v』 and the changing-page key 『⏪』、『⏩』 to move the row place of serial number.
3. Input value first then press 『↵』.
4. How to clean the column to blank : Press 『CLR』 first then press 『↵』.
5. 『CLR』 key can erase the input data of the temporal input area(lower and left).

Mode		EDIT		Status		STOP		P.Num		123	
0	E.O.P	3	F.H.C	6	Skip						
1	A-coord.	4	W.I	7	I.F.R						
2	I-coord.	5	A.O	8	D.F.R						
COMMAND A-coord.											
N	C	X	Y	F	D						
01	1	0.000	0.000	100							
02	1	100.000	100.000								
03	4				3						
04	1	300.000	300.000	50							
05	2	50.000	50.000								
B.T.M.C											
↑RET		TEACH		PRO-S		HELP					

P2-18

6. 『DEL』 key can delete the whole row data the cursor pointing.

(Mode EDIT)		Status STOP		P.Num 123	
0	E.O.P	3	F.H.C	6	Skip
1	A-coord.	4	W.I	7	I.F.R
2	I-coord.	5	A.O	8	D.F.R
COMMAND A-coord.					
N	C	X	Y	F	D
01	1	0.000	0.000	100	
02	1	100.000	100.000		
03	4				3
04	1	300.000	300.000	50	
05	2	50.000	50.000		
B.T.M.C					
↑RET	TEACH		PRO-S	HELP	

row data

cursor pointing

P2-19

7. 『INS』 key can insert a row data the cursor pointing and move the edition row to the next row.

Edition screen :

1. Press 『HELP』 key to change the upper part of command code description. (P2-21)

(Mode EDIT)		Status STOP		P.Num 123	
0	E.O.P	3	F.H.C	6	Skip
1	A-coord.	4	W.I	7	I.F.R
2	I-coord.	5	A.O	8	D.F.R
COMMAND A-coord.					
N	C	X	Y	F	D
01	1	0.000	0.000	100	
02	1	100.000	100.000		
03	4				3
04	1	300.000	300.000	50	
05	2	50.000	50.000		
B.T.M.C					
↑RET	TEACH		PRO-S	HELP	

P2-20



(Mode EDIT)		Status STOP		P.Num 123	
9	R-CYC	12		15	
10		13		16	
11		14		17	
COMMAND A-coord.					
N	C	X	Y	F	D
01	1	0.000	0.000	100	
02	1	100.000	100.000		
03	4				3
04	1	300.000	300.000	50	
05	2	50.000	50.000		
B.T.M.C					
↑RET	TEACH		PRO-S	HELP	

P2-21

2. Press 『HELP』 key again to change the upper part of command code description. (P2-20)
3. Continuously press 『HELP』 key twice to change the description of program edition. (P-22)

Description of editing operation					
N	C	X	Y	F	D
1	2	3	3	4	5
1. The node of program					
2. Command code. If the setting value is 0 or over the define range. It will deem the end of program command.					
3. Set the coordinate of axis feed-rate.					
4. The speed of axis feed-rate. setting range 1~100(or 999)					
5. According to the command setting value. EX. Setting the times of Incremental coordinate or the serial number of skip selection.					
↑RET					PD

P2-22

4. When the first axis-direction command of distance in the program "SPEED" is blank,(P2-23) the system will input a value of basic MCM setting.(P2-24) It will be replaced till the speed value up to 50. (P2-23)

Mode EDIT		Status STOP		P.Num 123	
0	E.O.P	3	F.H.C	6	Skip
1	A-coord.	4	W.I	7	I.F.R
2	I-coord.	5	A.O	8	D.F.R
COMMAND A-coord.					
N	C	X	Y	F	D
01	1	0.000	0.000		
02	1	100.000	100.000	50	
03	4				3
04	1	300.000	300.000		
05	2	50.000	50.000	100	
B.T.M.C					
↑RET		TEACH		PRO-S	HELP

P2-23

1. Set the JOG feed-rate of X-axis	1000
2. Set the JOG feed-rate of Y-axis	1000
3. Counter Limit (0~9999999)	0
4. The program output time of one cycle	0.00 S
5. Output time of program ending	0.00 S
6. Output time of positioning completed	0.00 S
7. Output time of counter reached	0.00 S
8. RS232 Baud Rate	38400
9. Set the Max ratio value of denominator of the program speed edition.	100
10. The preset speed of program edition	1
11. The pausing time of each divided feed-rate	0.00 S
Basic MCM	
↑RET	
TOP	
SPECIAL	
VER	

P2-24

5. If the speed of node and next node is the same, the "SPEED" column is based on first node. (P2-25)

Mode EDIT		Status STOP		P.Num 123	
0	E.O.P	3	F.H.C	6	Skip
1	A-coord.	4	W.I	7	I.F.R
2	I-coord.	5	A.O	8	D.F.R
COMMAND A-coord.					
N	C	X	Y	F	D
01	1	0.000	0.000		
02	1	100.000	100.000	50	
03	4				3
04	1	300.000	300.000		
05	2	50.000	50.000	100	
B.T.M.C					
↑RET		TEACH		PRO-S	HELP

P2-25

→ SPEED = 50

6. The maximum of unit-number of speed is 100 default value. If you want to divide more imperceptibly , you can change the basic MCM setting. System ability is up to divide the speed up to 999 sections.

1. Set the JOG feed-rate of X-axis	1000
2. Set the JOG feed-rate of Y-axis	1000
3. Counter Limit (0~9999999)	0
4. The program output time of one cycle	0.00 S
5. Output time of program ending	0.00 S
6. Output time of positioning completed	0.00 S
7. Output time of counter reached	0.00 S
8. RS232 Baud Rate	38400
9. Set the Max ratio value of denominator of the program speed edition.	100
10. The preset speed of program edition	1
11. The pausing time of each divided feed-rate	0.00 S
Basic MCM	
<input type="button" value="↑RET"/> <input type="button" value="TOP"/> <input type="button" value="SPECIAL"/> <input type="button" value="VER"/> <input type="button" value=""/>	

P2-26

Program skip without any condition :

When the junction code is “1” or “2”, writing 9876.xxx on the “X-Coordinate” setting subject will let the system recognize this as the skip. The row serial number is decided by “xxx”. If there is no row serial number of “xxx”, the system will alarm the error”Err18. FILE END”.

The circulation of program :

“J”(Column)and “L”(Column)are the data of setting block circulation. They both have to match each other. Then the setting is on.

“J” Setting value = 1 Point current row serial number as the initial number of block circulation.

Setting value = 9 Point current row serial number as the ended number of block circulation.

“L” Setting times of block circulation must be written on the same row with cycle setting value”1”.(P2-27)

If “the circulation of program” with “Program skip without any condition” command , ”the circulation of program” will be skipped. (P2-28)

Description :

Mode EDIT		Status STOP		P.Num 123	
0	E.O.P	3	F.H.C	6	Skip
1	A-coord.	4	W.I	7	I.F.R
2	I-coord.	5	A.O	8	D.F.R
COMMAND A-coord.					
N	C	X	Y	J	L
01	1	100.000	100.000	1	3
02	1	200.000	200.000		
03	1	300.000	300.000		
04	1	400.000	400.000	9	
05	1	500.000	500.000		
B.T.M.C					
↑RET		TEACH		PRO-S HELP	

X · Y axis execute the movement from 100.000 to 300.000 together. They will execute next motion till the cycle times up to 3.

P2-27

Mode EDIT		Status STOP		P.Num 123	
0	E.O.P	3	F.H.C	6	Skip
1	A-coord.	4	W.I	7	I.F.R
2	I-coord.	5	A.O	8	D.F.R
COMMAND A-coord.					
N	C	X	Y	J	L
01	1	100.000	100.000	1	3
02	1	9876.005	200.000		
03	1	300.000	300.000		
04	1	400.000	400.000	9	
05	1	500.000	500.000		
B.T.M.C					
↑RET		TEACH		PRO-S HELP	

When X·Y axis has reached the coordinate of 100.000 , the system will execute to run the coordinate of 500.000 in 5th node.

P2-28

※ If the command area of the row serial number 06 is blank. It means that the program has the function of “Repetitious cycle” .

Mode EDIT		Status STOP		P.Num 123	
0	E.O.P	3	F.H.C	6	Skip
1	A-coord.	4	W.I	7	I.F.R
2	I-coord.	5	A.O	8	D.F.R
COMMAND A-coord.					
N	C	X	Y	J	L
02	1	9876.005	200.000	1	3
03	1	300.000	300.000		
04	1	400.000	400.000		
05	1	500.000	500.000	9	
06					
B.T.M.C					
↑RET		TEACH		PRO-S HELP	

P2-29

Edit Command Definition Description:

Command “0” : End Of Program

When the program just only execute one times, write this command code on the place of program ending point.

Relative Column : NO

Command “1” : Absolute Coordinate

Relative Column :

X-Coordinate : Setting value is the absolute position of X-axis.

Y-Coordinate : Setting value is the absolute position of Y-axis.

Speed : The setting value is the ratio value of Traverse speed limit. The denominator is set by basic MCM 【 Program speed edition : Max sections(100~999)】 .

Data : Set the number of sub-program to execute.

Command ”2” : Incremental coordinate

Relative column:

X-Coordinate : Setting value is the incremental value of X-axis.

Y-Coordinate : Setting value is the incremental value of Y axis.

Speed : The setting value is the ratio value of Traverse speed limit. The denominator is set by basic MCM 【 Program speed edition : Max sections(100~999)】 .

Data : Set the number of sub-program to execute.

1. Set the JOG feed-rate of X-axis	1000
2. Set the JOG feed-rate of Y-axis	1000
3. Counter Limit (0~9999999)	0
4. The program output time of one cycle	0.00 S
5. Output time of program ending	0.00 S
6. Output time of positioning completed	0.00 S
7. Output time of counter reached	0.00 S
8. RS232 Baud Rate	38400
9. Set the Max ratio value of denominator of the program speed edition.	100
10. The preset speed of program edition	1
11. The pausing time of each divided feed-rate	0.00 S
Basic MCM	
↑RET	TOP
SPECIAL	VER

Denominator

P2-30

Mode		EDIT		Status		STOP		P.Num		123	
0	E.O.P.	3	F.H.C	6	Skip						
1	A-coord.	4	W.I	7	I.F.R						
2	I-coord.	5	A.O	8	D.F.R						
COMMAND A-coord.											
N	C	X	Y	F	D						
01	1	0.000	0.000	100							
02	1	100.000	100.000								
03	4				3						
04	1	300.000	300.000	50							
05	2	50.000	50.000								
B.T.M.C											
RET		TEACH		PRO-S		HELP					

Numerator

P2-31

$$\text{【 Traverse speed limit 】} \times \frac{\text{Numerator}}{\text{Denominator}} = \text{Program execute speed}$$

Command "3" : Feed Hold

The program executing by feed hold. the setting time is in the "X-coordinate" column.

Relative Column :

X-coordinate: Set pausing time as the unit 1/1000 second.

Command "4" : Wait for the input signal

Wait for the input signal is on or off is according to the setting value of 【Data】 column.

EX: Setting value = 3 , Standby Input 3 ON.

Setting value = -3 , Standby Input 3 OFF.

Relative Column :

X-Coordinate : The delay setting of time of standby input signal.

Mode		EDIT		Status		STOP		P.Num		123	
0	E.O.P.	3	F.H.C	6	Skip						
1	A-coord.	4	W.I	7	I.F.R						
2	I-coord.	5	A.O	8	D.F.R						
COMMAND A-coord.											
N	C	X	Y	F	D						
01	1	0.000	0.000	100							
02	1	100.000	100.000								
03	4				3						
04	1	300.000	300.000	50							
05	2	50.000	50.000								
B.T.M.C											
RET		TEACH		PRO-S		HELP					

If setting value=1

Wait the 【input 3】 signal for one sec.

P2-32

Data : The number of setting input point.

- ※ When wait over the setting time , wait for the input signal “W.I” will twinkle as hint located on the right side of current command.
- ※ The signal can’t use the function , when it is already used.

(Mode EDIT)		Status STOP		P.Num 123	
0	E.O.P	3	F.H.C	6	Skip
1	A-coord.	4	W.I	7	I.F.R
2	I-coord.	5	A.O	8	D.F.R
COMMAND A-coord.					
N	C	X	Y	F	D
01	1	0.000	0.000	100	
02	1	100.000	100.000		
03	4				3
04	1	300.000	300.000	50	
05	2	50.000	50.000		
B.T.M.C					
RET		TEACH		PRO-S HELP	

Twinkle

Ranges from 0 to 14

P2-33

Command “5” : Assigned Output

That the assigned output point is on or off is according to the setting value of 【Data】 column.

- EX: Setting value = 3 , Assigned output 3 ON.
- Setting value = -3 , Assigned output 3 OFF.

Relative Column :

Data : The serial number of assigned output motion ranges from 0 to 7.

(Mode EDIT)		Status STOP		P.Num 123	
0	E.O.P	3	F.H.C	6	Skip
1	A-coord.	4	W.I	7	I.F.R
2	I-coord.	5	A.O	8	D.F.R
COMMAND A-coord.					
N	C	X	Y	F	D
01	1	0.000	0.000		
02	1	100.000	100.000	50	
03	5				3
04	1	300.000	300.000		
05	2	50.000	50.000	100	
B.T.M.C					
RET		TEACH		PRO-S HELP	

Ranges from 0 to 7

P2-34

Command “6” : Skip Selection

When the program execute at the command code”6” , the system will check the status of signal “Input 1”. If it is ON , the program will accord to the setting of 【Data】 column to skip to the assigned row-serial-number. And then it continues to executing the program. If the system can’t find the skip signal , it will alarm the error “Err 18. FILE END”.

If “Input 1” is off and the program is executing at the command code”6” , the function of skip selection is off and program keeps executing to next one.

Relative Column :

Data : Assign the row serial number to skip

Mode		EDIT		Status		STOP		P.Num		123	
0	E.O.P	3	F.H.C	6	Skip						
1	A-coord.	4	W.I	7	I.F.R						
2	I-coord.	5	A.O	8	D.F.R						
COMMAND A-coord.											
N	C	X	Y	F	D						
01	1	0.000	0.000								
02	1	100.000	100.000	50							
03	6	200.000	200.000		5						
04	1	300.000	300.000								
05	2	50.000	50.000	100							
B.T.M.C											
RET		TEACH		PRO-S		HELP					

If “Input 1” = ON.

P2-35

Command ”7” : Interrupt Feed-rate

According to the 【Speed】 setting of X、Y axis , the program will executing the incremental feed-rate.

When the signal “Input 0” is on in the positioning , the axis will stop immediately and directly execute next node.

Relative column :

X-Coordinate : Setting value is the incremental value of X-axis.

Y-Coordinate : Setting value is the incremental value of Y axis.

Speed : The setting value is the ratio value of Traverse speed limit. The denominator is set by basic MCM 【Program speed edition : Max sections(100~999)】 .

Mode		EDIT		Status		STOP		P.Num		123	
0	E.O.P	3	F.H.C	6	Skip						
1	A-coord.	4	W.I	7	I.F.R						
2	I-coord.	5	A.O	8	D.F.R						
COMMAND A-coord.											
N	C	X	Y	F	D						
01	1	100.000	100.000								
02	7	200.000	200.000								
03	1	300.000	300.000								
04	1	400.000	400.000								
05	1	500.000	500.000								
B.T.M.C											
RET		TEACH		PRO-S		HELP					

P2-36

Description : P2-36

1. When executing second node , the signal “Input 0” is on.
2. Interruption immediately and directly execute next node.
3. If the signal “Input 0” does not on, the axis of X and Y will execute the incremental coordinate “200.000” first and then execute next node.

Command "8" : Division Feed-rate

According to the settings of **【Data】** column and the speed of X and Y axis , the system will divide the feed-rate.

After each positioning of divided feed-rate, there are two ways to restart:

- A. Set the pausing time of divided feed-rate (Set in the basic MCM#11). When reaching the setting time, it will go to next position automatically.
- B. If the basic MCM#11 setting value of divided feed-rate pausing time is "0" , the restart signal is the "falling edge" that when "Input 2" turn on to off.

Relative Column :

X-coordinate : Set the total X-axis coordinate of incremental movement.

Y-coordinate : Set the total Y-axis coordinate of incremental movement.

Speed : The setting value is the ratio value of Traverse speed limit. The denominator is set by basic MCM **【Program speed edition : Max sections(100~999)】** .

Data: Set the times of division

- ※ When the number can not be divided as integer , the difference will compensate on the last time.

EX: Divide 10 mm as 3 parts , it will execute 3.333 mm at first and second time. And it will execute 3.334 at the third time.

Command "9" : Repetitious cycle

When the program is executing at this command , the program will go back to the first node of program and keep executing this cycle.

It will be recognized as the function of repetitious cycle if the last node of program command code is "blank".



Relative Column : NO

※ **If you are not familiar with how to use command , you can go to the “HELP” screen which has detailed description and examples.**





How to go to the HELP screen : Quickly press the 『HELP』 key twice within 0.5 second.

※ Teach and Edit

Enter the teach-mode. The screen is shown as the picture below : This mode is only for teaching coordinate. If you want to edit other command codes , you must return to the editing mode.

User uses MPG to move the axis at the actual work position. Then press the enter key [] or insert key [] input current position to 『coordinate』 column automatically.

When the cursor locates on the column of “X- coordinate” or “Y- coordinate”, pressing the input key is only for inputting correspondent coordinate.

Mode		TEACH	Status	STOP	P.Num	123
MACHINE coordinate		● X: -1234.567		X: -1234.567		
		● Y: -1234.567		Y: -1234.567		
COMD		A-coord.	Limit:1234567	Count:1234567		
N	C	X	Y	F	D	
01	1	0.000	0.000	100		
02	4				2	
03	5				3	
04	1	100.000	200.000	50		
05	5				-3	
B.T.M.C						
						

P2-37

※※ The way of axis positioning is only using MPG :

1. Choose 『MPG*1』、 『MPG*10』、 『MPG*100』 .
2. Choose axis direction(When pressing 『X』、 『Y』 key , the chosen axis direction will be highlight on the LCD screen)
3. MPG feed-rate.

The editing keys of teach mode :

1. **ENTER key** : 

Enter the current program coordinate to the node cursor pointing.

The cursor highlight must be on the “X- coordinate” or “Y- coordinate”.

The first line of “X- coordinate” or “Y- coordinate” of program must be written by inputting key.

2. DELETE key :

Delete the data of single node cursor pointing.

3. INSERT key :

When the axis has some movement , pressing this key will input current coordinate of program to next row and move the serial number of editing to next ; When there is no movement , pressing this key will create a blank row.

PS : In the teach mode , the command code will be input as”1” automatically(absolutely coordinate).

Program-selection mode : 【PRO-S】

By pressing PRO-S key 『F4』 (P2-38) , you can go to the program-selection screen. (P2-39)

Mode EDIT		Status STOP		P.Num 123	
0	E.O.P	3	F.H.C	6	Skip
1	A-coord.	4	W.I	7	I.F.R
2	I-coord.	5	A.O	8	D.F.R
COMMAND A-coord.					
N	C	X	Y	F	D
01	1	100.000	100.000		
02	7	200.000	200.000		
03	1	300.000	300.000		
04	1	400.000	400.000		
05	1	500.000	500.000		
B.T.M.C					
<input type="button" value="RET"/>	<input type="button" value="TEACH"/>	<input type="button" value=""/>	<input type="button" value="PRO-S"/>	<input type="button" value="HELP"/>	

P2-38

Mode PRNO		Status STOP		P.Num 123	
→ 0000: 2004-08-30					
CURSOR	0001:	EMPTY			
	0002:	EMPTY			
	0003:	APPENDIX: INPUT BY YOURSELF			
	0004:	EMPTY			
	0005:	EMPTY			
	0006:	EMPTY			
	0007:	EMPTY			
	0008:	EMPTY			
	0009:	EMPTY			
<input type="button" value="RET"/>	<input type="button" value="COPY"/>	<input type="button" value="DEL"/>	<input type="button" value=""/>	<input type="button" value="ENTER"/>	

P2-39

Move the cursor at the chosen program number. Then press confirm-key 『F5』 to change to the chosen program.

※ Press cursor () left and right key. The serial number of program will be added for a hundred once.

How to delete program :

Move the cursor at the program number waited to be deleted. Then press 『DEL』 key. The illustrating screen of LCD is displayed below.

You can just follow the illustrative operation.

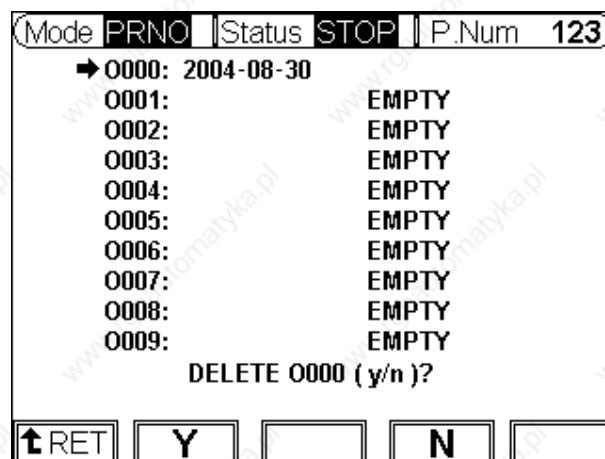

P2- 40

How to copy program : Move to cursor at the serial number of program needed to be copied. Press 『F2』 source-key. Then move the cursor at the serial number of program wanted to be replaced. Press 『F4』 destination-key. Then press 『F5』 confirm-key to complete the operation.

The illustrative screen of LCD is displayed below: And you can just follow the illustrative operation on the screen.

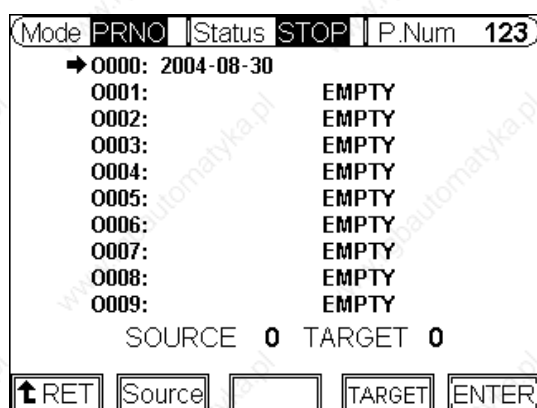

P2- 41

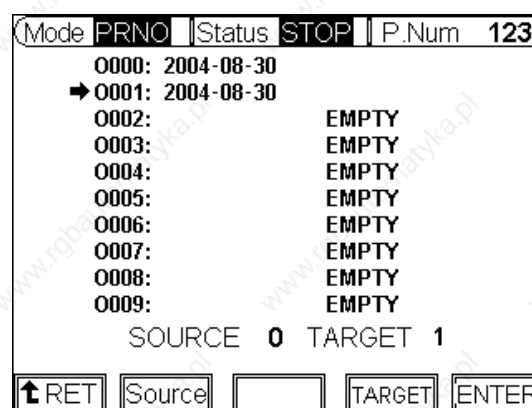

P2- 42



Description of editing operation :

1. Move the cursor to choose the source of program to be copied.
(P2- 41)
2. Press 『 F2 』 source-key.
3. Move the cursor to choose the destination of program to be copied.
(P2- 42)
4. Press 『 F4 』 destination-key.
5. Press 『 F5 』 confirm-key to complete the operation.

2.3 Operation of Sub- Program

You can call and execute another sub-program after the absolute feed or the incremental feed-positioning have finished. The content of sub-program is only allowed for I/O motion or feed-hold command. The way of using and edition is mentioned below :

1. Open the **【Special MCM】**

When the controller is under the mode of standby or basic MCM page , quickly press “**ENTER**” key twice  then press “**CLR**” key  twice (You must do it within one second and use your both hands). Therefore when you go to the basic MCM page, the **【Special】** function key will show up. Then press 『F3』 special-key to jump to the special MCM setting page directly.

2. On the special MCM setting page , you can set **【After Absolute / Incremental feed-positioning , execute the sub-program】**

Special MCM	
57. In the AUTO mode, it shows the program content. 0:NO 1:YES	0
58. After positioning of ABS./INC. feed-rate, execute the sub program.	0
59. Close the delay time of LCD showing or not. 0:NO 1:YES	0
60. Set the minimum of node the system pre-fate when close the LCD showing	-----
61. X-axis (+)(-) O.T. limit switch. 0:Operational 1:Not operational	0
⇩	
<input type="button" value="↑RET"/> <input type="button" value=""/> <input type="button" value=""/> <input type="button" value=""/> <input type="button" value=""/>	

P2- 43

Description :

After Absolute / Incremental feed-positioning , execute the sub-program

Format :

Setting range : 0 to 99 sets

Limitation :

(1) The provided sub-program which serial number ranges from O401 to O499 is only allowed to edit the I/O motion.

(2) Command of single node of work program can only call one sub-program.

Setting value = 0 , there is no sub-program function , when executing single node of work program.

Setting value = 1 , the system can only call and execute sub-program “0401”.

Setting value = 2 , the system can call and execute sub-program “0401” and “0402”.

Setting value = 3 , the system can call and execute sub-program “0401” to “0403”.

Setting value = 99 , the system can call and execute sub-program “0401” to “0499”.

(3) After the positioning is completed , execute the sub-program.

The way of calling and executing is inputting the serial number of sub-program in the **【Data】** column on the command row of absolute / incremental feed-rate.(Setting range : 1 to 99)

(4) Those sub-programs must be set in order. The beginning 3 sub-programs are quickly responded. (Use it carefully)

3. The way of selecting serial number of program and edition

The serial number of sub-program is defined by O401 to O499(P2- 43). Under the mode of selecting program serial number , according to the setting value , the largest program serial number will be different.

In the Edit mode , press 『 F4 』 selecting-program key to enter the mode of selecting the serial number of program. Move the cursor to the sub-program to be edited (O401 to O499). After pressing confirm key 『 F4 』 , the serial number of program on the right-and-upper corner will change to sub-program. Press Ret-key 『 F1 』 to edit the sub-program directly(illustrated as picture below). The serial number is not the same with major program`s. (P2- 44)

Mode EDIT		Status STOP	P.Num 401			
4	F.H.C	Edit the sub-program of I/O & Feed-hold command.				
11	A.O	The "M" column of last row of sub-program is inputted "99" independently.				
12	W.I					
COMMAND A-coord.						
N	G	P	L	A	B	M
01						
02						
03						
04						
05						
<input type="button" value="RET"/> <input type="button" value="TEACH"/> <input type="button" value="PRO-S"/> <input type="button" value="HELP"/>						

P2- 44

※※ Please exchange the serial number to the major program after the edition of sub-program. If you don't exchange it back to major program. When the system is reentering to the auto mode, the serial number will exchange back to the 0th.

Mode AUTO		Status STOP	P.Num 0			
Limit: 1234567		X: -1234.567				
Count: 1234567		Y: -1234.567				
COMD A-coord.						
N	C	X	Y	F	D	
01	1	0.000	0.000	100		
02	4				2	
03	5				3	
04	1	100.000	200.000	50		
05	5				-3	
B.T.M.C						
<input type="button" value="RET"/> <input type="button" value="P.F.H"/> <input type="button" value="1-CYC"/> <input type="button" value="MPG.T"/> <input type="button" value="E.W.E"/>						

P2- 45

※※ Example of command code of sub-program :

G11 P02 Assigned outputting signal O002 ON
 G11 P-02 Assigned outputting signal O002 OFF
 G12 P02 Standby inputting signal I002 ON
 G12 P-02 Standby inputting signal I002 OFF
 G12 P02 L1 Standby inputting signal I002
 "rising edge" (OFF→ON)
 G12 P-02 L1 Standby inputting signal I002
 "falling edge" (ON→OFF)
 G12 P02 A1000 Standby inputting signal I002 ON 1sec.
 then execute next command. (A Unit: ms)
 G12 P02 B1000 Standby inputting signal I002 ON 1sec.
 If it is over the setting time. The "W.I" will
 highlight as hint. (B Unit: ms)
 M00 Standby the CYCST signal
 M99 Back to major program

The "M" column of last row of sub-program is inputted "99" independently. Do not edit other command code on the same row.

Mode	EDIT	Status	STOP	P.Num	401
4	F.H.C	Edit the sub-program of I/O & Feed-hold command.			
11	A.O	The "M" column of last row of sub-program is inputted "99" independently.			
12	W.I				
COMMAND A-coord.					
N	G	P	L	A	B M
01	12	2			99
02					
03					
04					
05					
<input type="button" value="↑RET"/> <input type="button" value="TEACH"/> <input type="button" value="PRO-S"/> <input type="button" value="HELP"/>					

P2- 46

You can not input "02" or "30" in the "M" column. Because "02" and "30" are the codes of ending operation of program.

3 MCM Machine Constant Parameters

3.1 MCM

The MCM setting allows user to define certain machine constants that match to the mechanical specification of the equipment and the machining requirements.

The MCM can be defined as basic MCM , further MCM and special MCM in advance.

3.1.1 Basic MCM

Press “MCM” key on the standby screen to get in the MCM screen as shown below:

1. Set the JOG feed-rate of X-axis	1000
2. Set the JOG feed-rate of Y-axis	1000
3. Counter Limit (0~9999999)	0
4. The program output time of one cycle	0.00 S
5. Output time of program ending	0.00 S
6. Output time of positioning completed	0.00 S
7. Output time of counter reached	0.00 S
8. RS232 Baud Rate	38400
9. Set the Max ratio value of denominator of the program speed edition.	100
10. The preset speed of program edition	5
11. The pausing time of each divided feed-rate	0.00 S
	Basic MCM

↑RET

TOP

SPECIAL

VER

To show the special key needs to be decoded, described in 3.1.3

P3-1

3.1.2 Further MCM

The further MCM setting has a great deal of influence on mechanic system and tool production. So it must be set carefully. After the setting completed , please restart the controller.

※ In the basic MCM page , keeping pressing the blank soft key 『 F5 』 on the right side for 5 seconds will jump to further MCM page automatically.

Description of Function Key

Burn Program :

Burn the work program in the FLASH ROM. It will be downloaded in each booting automatically. (The program data in the memory will be covered → Pay more attention!!)

Burn MCM :

Burn PLC ladder into FLASH-ROM.

When all the MCM setting is correct , the operation of **【Burn】** can be started.

Clear variable :

Set all the controller variable #1 ~ #9999 as zero.

MCM reset :

MCM parameters reset.

Delete program :

Delete all the NC program (including of pre-loaded program). After doing this , it can not burn any program.

These function keys mentioned above work in case keeping pressing for 2 seconds.

Further MCM Page 1

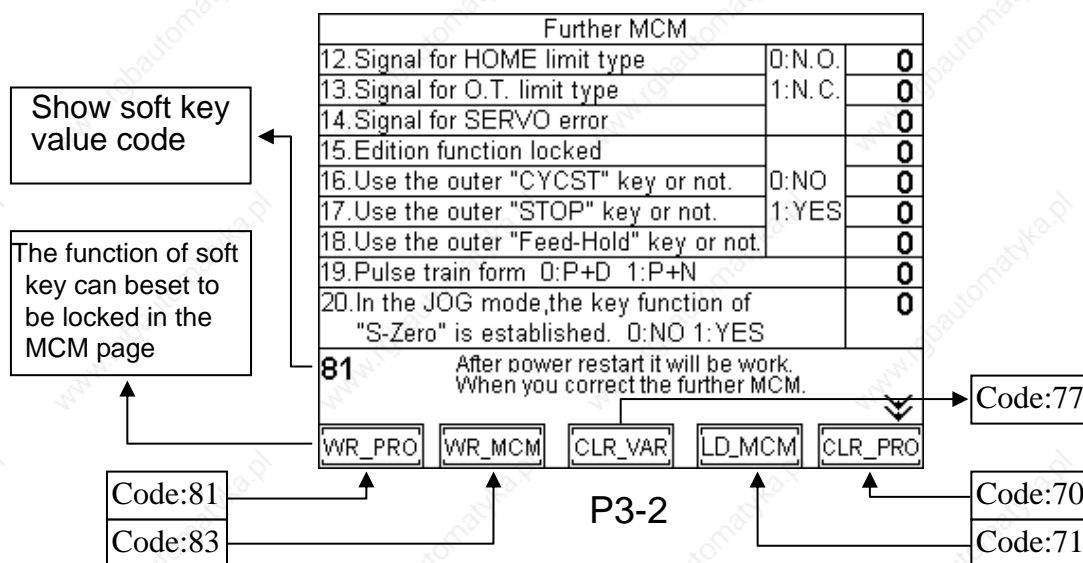

Further MCM Page 2

Further MCM	
21. In the JOG mode, the testing function of output point is established. 0:N 1:Y	0
22. Denominator(pulse) of machine resolution, X-axis.	100
23. Numerator(distance) of machine resolution, X-axis.	100
24. Denominator(pulse) of machine resolution, Y-axis.	100
25. Numeratio(distance) of machine resolution, Y-axis.	100
<input type="text"/> <input type="text"/> <input type="text"/> <input type="text"/> <input type="text"/> <input type="text"/>	

P3-3

Further MCM Page 3

Further MCM	
26. Traverse Speed Limit, X-axis(G00)	10000
27. Traverse Speed Limit, Y-axis(G00)	10000
28. Direction Motor Rotation, X-axis.	0
29. Direction Motor Rotation, Y-axis.	0
30. Home Speed, X-axis	2500
31. Home Speed, Y-axis	2500
32. Home Grid Speed, X-axis	40
33. Home Grid Speed, Y-axis	40
34. Home Direction, X-axis	0
35. Home Diredtion, Y-axis	0
<input type="text"/> <input type="text"/> <input type="text"/> <input type="text"/> <input type="text"/> <input type="text"/>	

P3-4

Further MCM Page 4

Further MCM	
36. Software O.T. limit in (+) Dir. , X-axis	9999.999
37. Software O.T. limit in (+) Dir. , Y-axis	9999.999
38. Software O.T. limit in (-) Dir. , X-axis	-9999.999
39. Software O.T. limit in (-) Dir. , Y-axis	-9999.999
40. Backlash compensation, X-axis	0
41. Backlash compensation, Y-axis	0
42. Set X-axis as Rotation/Linear axis	0
43. Set Y-axis as Rotation/Linear axis	0
44. X-axis Denominator, MPG resolution	100
45. X-axis Numerator, MPG resolution	100
<input type="text"/> <input type="text"/> <input type="text"/> <input type="text"/> <input type="text"/> <input type="text"/>	

P3-5

Further MCM Page 5

Further MCM	
46. Y-axis Denominator, MPG resolution	100
47. Y-axis Numerator, MPG resolution	100
48. Master/Slave mode setting	0
49. Type of motor ACC./DEC.	0
50. Servo motor ACC./DEC. time.(G01)	100
51. Set ACC./DEC. time for MPG	100
52. Metric/Inch mode selection	0
53. Lock the function key on the Further MCM page or not. 0:NO 1:YES	0
<input type="text"/> <input type="text"/> <input type="text"/> <input type="text"/> <input type="text"/> <input type="text"/>	

P3-6



Further MCM Page 6

Further MCM	
54. Coordinate set-zero when CYCST. 0:NO 1:X 2:Y 3:XY	0
55. Back to the machine coordinate before CYCST. 0:NO 1:X 2:Y 3:XY	0
56. Set the coordinate as zero or not when the program is executing at the end. 0:NO 1:X 2:Y 3:XY	0
<input type="text"/> <input type="text"/> <input type="text"/> <input type="text"/> <input type="text"/> <input type="text"/>	

P3-7

3.1.3 Special MCM

The further MCM setting has a great deal of influence on mechanic system. So it must be set carefully. The revision of special MCM is only operative unless to press the RESET key.

- ※ When the controller is in the standby mode , press ENTER key  twice + quickly press “CLR” key  twice in one second. Therefore when getting in basic MCM page , “Special” function key will show up. Press “Special” key to jump to the special MCM setting page directly as shown in P 3-5.

Special MCM Setting Page1

Special MCM	
57. In the AUTO mode, it shows the program content. 0:NO 1:YES	0
58. After positioning of ABS./INC. feed-rate, execute the sub program.	0
59. Close the delay time of LCD showing or not. 0:NO 1:YES	0
60. Set the minmum of node the system pre-fate when close the LCD showing	-----
61. X-axis (+)(-) O.T. limit switch. 0:Operational 1:Not operational	0
⏏	
<div style="display: flex; justify-content: space-between; align-items: center;"> ⏏ RET </div>	

P3-8

Special MCM Setting Page2

Special MCM	
62. Y-axis (+)(-) O.T. limit switch. 0:Operational 1:Not operational	0
63. [000] Servo On. 0:Operational 1:Not operational	0
64. [004] Output of One Cycle. 0:Operational 1:Not operational	0
65. [005] Counter limit. 0:Operational 1:Not operational	0
66. [006] Position reached signal. 0:Operational 1:Not operational	0
⏏	
<div style="display: flex; justify-content: space-between; align-items: center;"> ⏏ RET </div>	





P3-9

Special MCM Setting Page3

Special MCM	
67. [007] Program end. 0:Operational 1:Not operational	0
68. [114] Emergent stop. 0:Not operational 1:Operational	0
⏏	
<div style="display: flex; justify-content: space-between; align-items: center;"> ⏏ RET </div>	

P3-10

How to revise MCM value :

Use the page   and cursor   to move to the location of MCM wanted to correct. Input the new MCM value and then press 『  』 input key to revise it.

3.2 MCM description

** Basic MCM Showing Page **

1. Set the JOG feed-rate of X-axis , unit: mm/min.
2. Set the JOG feed-rate of Y-axis , unit: mm/min.
Format=□□□□□ (Default 1000)
3. Counter Limit
Format=□□□□□□□ (Maximum up to 7 digit)
※ value = 0 no limit
When the counter value reaches the counter limit , the program will stop and it can not start automatically.
4. The program output time of one cycle
Format=□□.□□ (Default 0.00)
Set the time of output 4 ON when the program is executing one cycle.
5. Output time of program ending
Format=□□.□□ (Default 0.00)
Set the time of output 7 ON when the program is executing at the end.
6. Output time of positioning completed
Format=□□.□□ (Default 0.00)
Set the time of output 6 ON when the positioning of coordinate is completed.
7. Output time of counter reached
Format=□□.□□ (Default 0.00)
Set the time of output 5 ON when the counter is reached.

8. RS232C Baud Rate

Format=□□□□ (Default 38400)

Set RS232C communication speed. choose from 4800 , 9600 , 19200 or 38400.

In addition , use the following settings for your PC(Hcon) :

PARITY -EVEN

STOP BITS -2 BITS

9. Set the Max ratio value of denominator of the program speed edition.

Format=□□□ (Default 100)

Range=100 to 999

1.Set the JOG feed-rate of X-axis	1000
2.Set the JOG feed-rate of Y-axis	1000
3.Counter Limit (0~9999999)	0
4.The program output time of one cycle	0.00 S
5.Output time of program ending	0.00 S
6.Output time of positioning completed	0.00 S
7.Output time of counter reached	0.00 S
8.RS232 Baud Rate	38400
9.Set the Max ratio value of denominator of the program speed edition.	100
10.The preset speed of program edition	5
11.The pausing time of each divided feed-rate	0.00 S
Basic MCM	
↑RET	TOP
SPECIAL	VER

Denominator

Mode EDIT		Status STOP		P.Num 123	
0	E.O.P	3	F.H.C	6	Skip
1	A-coord.	4	W.I	7	I.F.R
2	I-coord.	5	A.O	8	D.F.R
COMMAND A-coord.					
N	C	X	Y	F	D
01	1	0.000	0.000	100	
02	1	100.000	100.000		
03	4				3
04	1	300.000	300.000	50	
05	2	50.000	50.000		
B.T.M.C					
↑RET	TEACH		PRO-S	HELP	

Numerator

$$\text{【 Traverse speed limit 】} \times \frac{\text{Numerator}}{\text{Denominator}} = \text{Program execute speed}$$

10. The preset speed of program edition

Format=□□□ (Default 5)

This setting value is not shown up in the program content. When executing program and "SPEED" column is empty, the controller will execute by main speed with this setting value.

Range : 1 to item ninth of basic MCM setting value.

11. The pausing time of each divided feed-rate

Format=□□.□□□ (Default 0.000)

Set the pausing time when each divided coordinate has reached.

※ Setting value=0.00, this operation will be replaced by waiting input 2 ON.

Ex.

1. Set the JOG feed-rate of X-axis	1000
2. Set the JOG feed-rate of Y-axis	1000
3. Counter Limit (0~9999999)	0
4. The program output time of one cycle	0.00 S
5. Output time of program ending	0.00 S
6. Output time of positioning completed	0.00 S
7. Output time of counter reached	0.00 S
8. RS232 Baud Rate	38400
9. Set the Max ratio value of denominator of the program speed edition.	100
10. The preset speed of program edition	5
11. The pausing time of each divided feed-rate	1.00 S

Basic MCM

↑RET TOP SPECIAL VER

Mode	EDIT	Status	STOP	P. Num	123
0	E.O.P	3	F.H.C	6	Skip
1	A-coord.	4	W.I	7	I.F.R
2	I-coord.	5	A.O	8	D.F.R
COMMAND D.F.R					
N	C	X	Y	F	D
01	1	0.000	0.000		
02	8	100.000	200.000	50	5

↑RET TEACH PRO-S HELP

Description :

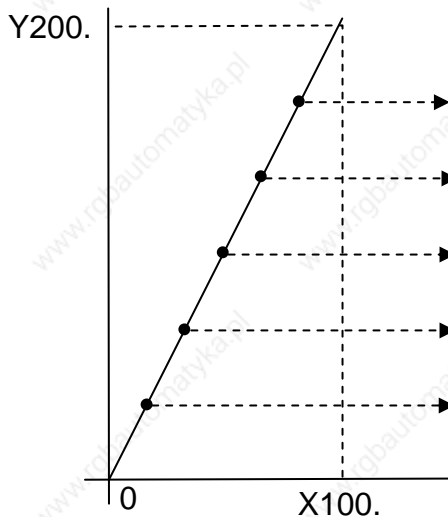

Each point wait 1 sec.
 ※ If pausing time Setting value=0.00 then wait the input 2 signal ON for each point.

**** Further MCM Showing Page 1 ****

12. Signal for HOME limit type.
0=Normally Open (NO point) , 1= Normally Close (NC point)
Format= (Default 0)

13. Signal for Over-travel (OT) Limit switch type.
0=Normally Open (NO point) , 1= Normally Close (NC point)
Format= (Default 0)

14. Signal for SERVO error. (connecting from servo-driver)
0=Normally Open (NO point) , 1= Normally Close (NC point)
Format= (Default 0)

15. Edition function locked.
0 = NO , 1 = YES
Format= (Default 0)
When the editing function is locked , In standby screen the function key of 『EDIT』 will highlight and can not get in the mode of editing program.

16. Use the outer “CYCST” key or not.
0 = NO , 1 = YES

17. Use the outer “STOP” key or not.
0 = NO , 1 = YES

18. Use the outer “Program feed-hold” (P.F.H)key or not.
0 = NO , 1 = YES
Format= (Default 0)

19. Pulse train form
Format= (Default 0)
Set the pulse train format of axis-direction.
= 0 : Pulse train + sign (Direction)
= 1 : Positive Pulse + Negative Pulse

20. In the JOG mode , the key function of “Set Zero” is established.
 0 = NO , 1 = YES
 Format= (Default 0)
 When the function is on , the soft key 『 S- Zero 』 will show up in the JOG mode.

**** Further MCM Showing Page 2 ****

21. In the JOG mode , the testing function of output point is established. 0 = NO , 1 = YES
 Format= (Default 0)
 When the function is on , in the JOG mode press once is ON and press again is OFF the number key 0 to 7 (correspondent output point O00 to O07). The output points already ON will have no movement.

※ When leaving the JOG mode , all the output points ON by test will turn OFF.

※ **This function is only for test of output point. If the output points have relative operation each other or is dangerous , this function is not advised to be open.**

22. Denominator(Encoder pulse) of Machine Resolution , X-axis.

23. Numerator (distance) of Machine Resolution , X-axis.
 Format= (Default 100)

24. Denominator(Encoder pulse) of Machine Resolution , Y-axis.

25. Numerator (distance) of Machine Resolution , Y-axis.
 Format= (Default 100)

※※ The setting value of resolution of denominator or numerator is set according to the mechanic axis-direction gearing equipment and the pulse which drivers accept. Please do not change them by any case without permission after confirmation.

Denominator (D) = pulses/rev for the encoder on motor.
 Numerator (N) = pitch length (mm/rev) of the ball-screw.
 Gear Ratio (GR) = Tooth No. on ball-screw / Tooth No. on motor.

$$\text{Machine Resolution} = \frac{(\text{pitch of ball-screw})}{(\text{Encoder Pulse})} \times \frac{1}{\text{GR}}$$

Ex1 :

X-axis as linear axis (MCM # 42=0) , pitch = 5 mm = 5000 μm
 Encoder = 2500 pulses , and GR = 4 (motor rotates 4 times while ball-screw rotates once)

Machine resolution = (5000/2500) / 4 = 5000/10000 = 1/2 = 0.5 μm/pulse

Therefore , the setting value for Further MCM #22 (D) and #23 (N) can be one of the three combinations. They are all correct.
 (1) D=10000, N=1000 (2) D=10, N=1 (3) D=100, N=10

Ex2:

Y-axis as rotating axis (MCM # 43=1), Angle = 360.000 deg/circle
 Encoder = 2500 pulses , and GR = 4 (motor rotates 4 times while ball-screw rotates once)

Machine resolution = (360000/2500)/4 = 360000/10000 = 36/1

Therefore, the setting value for Further MCM #24 (D) and #25 (N) can be one of the three combinations. They are all correct.
 (1) D=1, N=36 (2) D=10, N=360 (3) D=10000, N=360000

**** Further MCM Showing Page 3 ****

26. Traverse Speed Limit , X-axis(G00).

27. Traverse Speed Limit , Y-axis(G00).

Format= (Default 10000)

Unit : mm/min

Attention : The setting value is format of integer without point

Ex :

Set as 5000 , it indicates that traverse max speed of X-axis is 5000 mm per minute.

Set the max. moving speed for G00 function in each axis. The traverse speed limit can be calculated from the following equation:

$$F_{max} = 0.95 * RPM * Pitch * GR$$

RPM : The max. rpm of servo motor

Pitch : The pitch of the ball-screw

GR : Gear ratio of ball-screw/motor

Ex:

Max. rpm = 3000 rpm for X-axis , Pitch = 5 mm/rev , Gear Ratio = 5 : 1 (motor rotates 5 times while ball-screw rotates once)

$$F_{max} = 0.95 \times 3000 \times 5 / 5 = 2850 \text{ mm/min}$$

Therefore , it is recommended to set Further MCM #26=2850.

28. Direction of Motor Rotation , X-axis.

29. Direction of Motor Rotation , Y-axis.

Format= (Default 0)

Setting=0 , Motor rotates in the positive direction(CW).

Setting=1 , Motor rotates in the negative direction(CCW).

※ This MCM can be used to reverse the direction of motor rotation if desired. So you don't have to worry about the direction of rotation when installing motor. These parameters will affect the direction of HOME position.

- 30. Home Speed When Tool Going to Home , X-axis. (Speed 1)
- 31. Home Speed When Tool Going to Home , Y-axis. (Speed 1)
Format=□□□□ (Default 2500)
Unit : mm/min
- 32. Home Grid Speed When Tool Going to Home , X-axis. (Speed 2)
- 33. Home Grid Speed When Tool Going to Home , Y-axis. (Speed 2)
Format=□□□□ (Default 40)
Unit : mm/min

- ※ Note that the length of the HOME limit switch should be longer than the distance for the deceleration of Speed 1. Otherwise , serious error may result.
- ※ The equation to calculate the length of the Home limit switch is

$$\text{Length of Home limit switch(mm)} \geq \frac{\text{FDCOM} \times \text{ACC}}{60000}$$

- FDCOM = Speed 1 , in mm/min.(Further MCM #30 , #31)
- ACC = Time for acceleration/deceleration , in ms. (Further MCM #50)
- 60000 = 60 seconds = 60 × 1000 milliseconds

Ex: FDCOM = 3000.00 mm/min , and ACC = 100 ms
Length of Home Limit Switch = 3000 × 100 / 60000 = 5 mm

- 34. Home Direction for Tool , X-axis.
- 35. Home Direction for Tool , Y-axis.
Format=□ (Default 0)

Setting=0 Tool returning to HOME in the positive direction.
Setting=1 Tool returning to HOME in the negative direction.

**** Further MCM Showing Page 4 ****

36. Software over-travel (OT) Limit in (+) Direction , X-axis.

37. Software over-travel (OT) Limit in (+) Direction , Y-axis.

Format=□□□□.□□□ (Default +9999.999)

Unit = mm

Set the software over-travel (OT) limit in the positive (+) direction , the setting value is equal to the distance from positive OT location to the machine origin (HOME).

38. Software over-travel (OT) Limit in (-) Direction , X-axis.

39. Software over-travel (OT) Limit in (-) Direction , Y-axis.

Format=□□□□.□□□ (Default -9999.999)

Unit = mm

Set the software over-travel (OT) limit in the negative (-) direction , the setting value is equal to the distance from negative OT location to the machine origin (HOME). Figure below shows the relationship among the software OT limit , the emergency stop , and the actual hardware limit.

Concept and Description of Over-Travel Limit

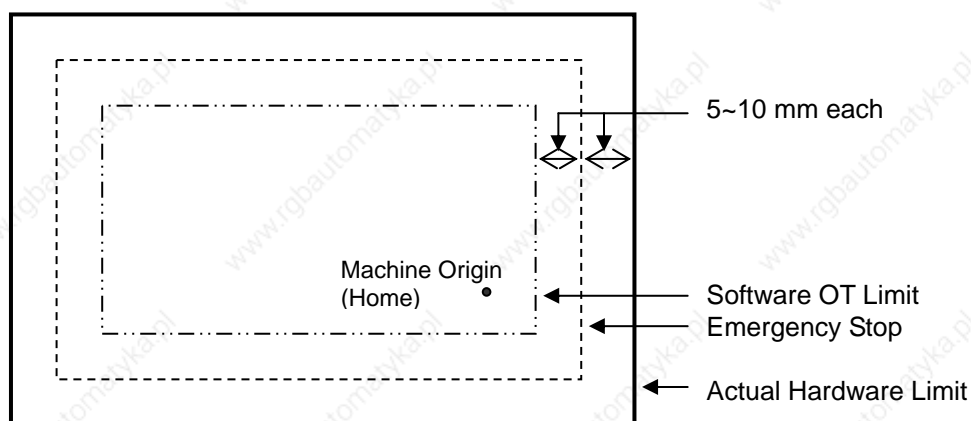

P3-6

PS : The distance from the setting point of software OT limit to EM-STOP is about 5 to 10 mm.

- 40. Backlash Compensation , X-axis.
- 41. Backlash Compensation , Y-axis.
Format= (Default 0)
Unit = μm
- 42. Set X-axis as Rotating/Linear axis.
- 43. Set Y-axis as Rotating/Linear axis.
Format= (Default 0)

Setting = 0 , Use as linear axis.
Setting = 1 , Use as rotating axis.
- 44. X-axis Denominator , MPG Hand-wheel Resolution Adjustment.
(pulse)
- 45. X-axis Numerator , MPG Hand-wheel Resolution Adjustment.
(μm)
Format= (Default 100)

**** Further MCM Showing Page 5 ****

- 46. Y-axis Denominator , MPG Hand-wheel Resolution Adjustment.
(pulse)
- 47. Y-axis Numerator , MPG Hand-wheel Resolution Adjustment.
(μm)
Format= (Default 100)

Explanation as follow :

Ex1 :

For X-axis , Further MCM #44 = 100 pulses , Further MCM #45 = 100 μm . The resolution for X-axis = $100/100 = 1 \mu\text{m}/\text{pulse}$. If MPG hand-wheel moves 1 notch (=100 pulses) , the feed length in X-axis = $100 \times (100/100) = 100 \mu\text{m} = 0.1 \text{ mm}$.

Ex2 :

For Y-axis , Further MCM #46= 200 pulses , Further MCM #47 = 500 μm . The resolution for Y-axis = $500/200 = 2.5 \mu\text{m}/\text{pulse}$.

If MPG hand-wheel moves 1 notch (=100 pulses) , the feed length in Y-axis = $100 \times (500/200) = 250 \mu\text{m} = 0.25 \text{ mm}$.

48. Master/Slave Mode Setting

Format= (Default 0)

Setting = 0 , CNC mode, Master/Slave mode NOT set.
 = 1 , X-axis as master axis, Y-axis as slave axes.
 = 2 , Y-axis as master axis, X-axis as slave axes.
 = 10, Round Corner Non-stop Operation.

49. Type of Motor Acceleration / Deceleration

Format= (Default 0)

Setting = 0 Linear type.

Setting = 1 "S" Curve.

When the setting = 1 , all linear type will be replaced by "S-curve".

50. Servo Motor Acceleration / Deceleration Time (T) , G01.

Format= (Default 100)

Unit= milliseconds

Setting Range 4~1024 ms.

If Further MCM #49 setting = 0

type of acceleration / deceleration for G01 = Linear.

If Further MCM #49 setting = 1

type of acceleration / deceleration for G01 = "S" curve.

In this case , the actual acceleration / deceleration time is twice the setting value.

51. Set Acceleration / Deceleration Time for MPG

Format= (Default 64)

Unit = milliseconds

Setting Range 4~512 ms.

52. Metric / Inch mode selection

Format= (Default 0)

Setting = 0 Measurement in METRIC unit.

Setting = 1 Measurement in INCH unit.

53. Lock the function key on the Further MCM page or not.

0 = NO , 1 = YES

Format= (Default 0)

If the function key on the Further MCM page(P3-2) is locked , the function key on lower side of further MCM page will become blank. The function of burning and downloading are both failed.

**** Further MCM Showing Page 6 ****

54. Coordinate set-zero when CYCST.

0=NO 1=X 2=Y 3=XY

Format= (Default 0)

Set the program coordinate as zero or not before executing the program.

Setting=0 None of this operation

Setting=1 X-axis

Setting=2 Y-axis

Setting=3 X-axis & Y-axis

※ **The axis which has the operation of HOME (Further MCM#55) can not be set this function.**

55. Back to the Machine coordinate before CYCST.

0=NO 1=X 2=Y 3=XY

Format= (Default 0)

The axis dose the operation of HOME or not before program starting.

Setting=0 No HOME(The HOME operation of X and Y axis is closed)

Setting=1 X-axis must go to the Machine coordinate before program starting.
(The HOME operation of Y axis is closed)

Setting=2 Y-axis must go to the Machine coordinate before program starting.
(The HOME operation of X axis is closed)

Setting=3 X-axis & Y-axis must go to the Machine coordinate before program starting.

※ If the axis is set to be HOME operation , the axis will do the HOME operation first and then execute the program.

※ The program can not be executed till the axis has finished the HOME operation.

56. Set the coordinate as zero or not when the program is executing at the end.

0=NO 1=X 2=Y 3=XY

Format= (Default 0)

Set the coordinate as zero or not when the program is executing at the end or the program is finishing one cycle.

Setting=0 Do not set any axis-coordinate as zero when the program is executing at the end.

Setting=1 Set the coordinate as zero of X-axis when the program is executing at the end.

Setting=2 Set the coordinate as zero of Y-axis when the program is executing at the end.

Setting=3 Set the coordinate as zero when the program is executing at the end.

※ **The axis which has the operation of HOME (Further MCM#55) can not be set this function.**

** Special MCM Showing Page 1 **

57. In the AUTO mode , it shows the program content.

0 = NO , 1 = YES

Format= (Default 0)

In the AUTO mode , it shows the program content. The system scan time will be longer. The pausing time between each node will be affected directly.

Value = 256

So this function is only suit for the condition that no continuance needed between each node.

When the setting value is 256 , the program data can be revised in executing.

The correct value will be executing in next cycle.

58. After positioning of Absolutely / Incrementally feed-rate , execute the sub program

Format= Setting range= 0 to 99

The provided sub programs from O401 to O499 can only be edited the operation of I/O.

One command line can only call one sub program.

Setting = 0 No operation of executing sub program

Setting = 1 Call the sub program "O401" only

Setting = 2 Call the sub program "O401" and "O402"

Setting = 3 Call the sub program from "O401" to "O403"

Setting = 99 Call the sub program from "O401" to "O499"

When the positioning is completed and the operation of executing sub program is beginning , the way to execute is to input the code of sub program on the "DATA" column of the absolutely / incrementally feed-rate command line (Range=1 to 99)

59. Close the delay time of LCD showing or not.

0 = NO , 1 = YES

Format= (Default 0)

This setting is used correspondent with the Further MCM #57. In the AUTO mode , the program content dose not show up. If there is some delay between each node in the executing condition , please open this operation. By accommodating the Further MCM #60 setting , the problem of delay between each node will be improved.

Further MCM #57 = 0

Further MCM #59 = 1

Further MCM #60 = 32

60. Set the minimum of node the system pre-fate when close the LCD showing

Format= (Default 0)

Setting range= 16 to 32

When the Further MCM #59=1 and the amount of program node pre-fate by the controller system is smaller than this setting value , the showing operation will pause automatically. Till the amount of program node pre-fate by the controller system is bigger than this setting value , the LCD operation of showing is restarting.

Further MCM #59 = 1

Further MCM #60 = 32

※ LCD showing : If used #57. #59. #60 function , the LCD showing will be slow or stop.

※ Pre-fate : The control system operation of presetting decoding.

61. X-axis (+)(-) OT limit switch.

0 = Operational , 1 = Not Operational

Format= (Default 0)

When the X-axis is the linear type , you must set the #61 = 0 or the tool machine may crash.

**** Special MCM Showing Page 2 ****

62. Y-axis (+)(-) OT limit switch.

0 = Operational , 1 = Not Operational

Format= (Default 0)

When the Y-axis is the linear type , you must set the #62 = 0 or the tool machine may crash.

63. 【O00】 Servo On .

0 = Operational , 1 = Not Operational

Format= (Default 0)

#63 = 0 :

Controller sends the output signal to the servo (or stepping) motor.

64. 【O04】 Output of One Cycle.

0 = Operational , 1 = Not Operational

Format= (Default 0)

When the program has executing one cycle , the signal will be outputted.

65. 【O05】 Counter Limit.

0 = Operational , 1 = Not Operational

Format= (Default 0)

The basic MCM #7 <> 0 and Further MCM #65 = 0

Then the count value \geq #7 then Output 5 = 1.

66. 【O06】 Position Reached Signal.

0 = Operational , 1 = Not Operational

Format= (Default 0)

Command code as 『 Absolutely Feed-Rate 』、 『 Incrementally Feed-Rate 』 and 『 Dividedly Feed-Rate 』 . The signal is outputted when the motor has finished the positioning.

**** Special MCM Showing Page 3 ****

67. 【O07】 Program End.

0 = Operational , 1 = Not Operational

Format= (Default 0)

When the program is executing the command “0” 『 Program End 』 or program execute “One Cycle ” at the end , this signal will be outputted.

68. 【I14】 Emergent Stop.

0 = Not Operational , 1 = Operational

Format= (Default 0)

The signal is normally close (NC).

If #68 = 1 and Input 14 is off , then the controller will enters the condition of emergent stop.

H2PN MCM-LIST			
N	BASIC MCM	VALUE	APPENDIX
1	Set the JOG feed-rate of X-axis		
2	Set the JOG feed-rate of Y-axis		
3	Counter Limit		
4	The program output time of one cycle		
5	Output time of program ending		
6	Output time of positioning completed		
7	Output time of counter reached		
8	RS232 Baud Rate		
9	Set the Max ratio value of denominator of the Program speed edition		
10	The preset speed of program edition		
11	The pausing time of each divided feed-rate		

N	FURTHER MCM	VALUE	APPENDIX
12	Signal for HOME limit type		
13	Signal for Over-travel (OT) limit switch type		
14	Signal for Servo error		
15	Edition function locked		
16	Use the outer "CYCST" key or not		
17	Use the outer "STOP" key or not		
18	Use the outer "Program feed-hold" key or not		
19	Pulse train form		
20	In the JOG mode ,the key function of "Set Zero" is established		
21	In the JOG mode, the testing function of output point is established		
22	Denominator(Encoder pulse) of Machine resolution, X-axis		
23	Numerator(distance) of Machine resolution, X-axis		
24	Denominator(Encoder pulse) of Machine resolution, Y-axis		
25	Numerator(distance) of Machine resolution, Y-axis		

N	FURTHER MCM	VALUE	APPENDIX
26	Traverse Speed Limit, X-axis(G00)		
27	Traverse Speed Limit, Y-axis		
28	Direction of Motor Rotation , X-axis		
29	Direction of Motor Rotation , Y-axis		
30	Home Speed When Tool Going to Home, X-axis(Speed 1)		
31	Home Speed When Tool Going to Home, Y-axis(Speed 1)		
32	Home Grid Speed When Tool Going to Home, X-axis(Speed 2)		
33	Home Grid Speed When Tool Going to Home, Y-axis(Speed 2)		
34	Home Direction for Tool , X-axis		
35	Home Direction for Tool , Y-axis		
36	Software over-travel (OT) Limit in (+) Direction, X-axis		
37	Software over-travel (OT) Limit in (+) Direction, Y-axis		
38	Software over-travel (OT) Limit in (-) Direction, X-axis		
39	Software over-travel (OT) Limit in (-) Direction, Y-axis		
40	Backlash Compensation , X-axis		
41	Backlash Compensation , Y-axis		
42	Set X-axis as Rotation / Linear axis		
43	Set Y-axis as Rotation / Linear axis		
44	X-axis Denominator, MPG Hand-wheel Resolution Adjustment (pulse)		
45	X-axis Numerator, MPG Hand-wheel Resolution Adjustment (um)		
46	Y-axis Denominator, MPG Hand-wheel Resolution Adjustment (pulse)		
47	Y-axis Numerator, MPG Hand-wheel Resolution Adjustment (um)		
48	Master/Slave mode setting		
49	Type of motor Acceleration / Deceleration		

50	Servo motor Acceleration / Deceleration time		
51	Set Acceleration / Deceleration time for MPG		
52	Metric / Inch mode selection		
53	Lock the function key on the Further MCM page or not.		
54	Coordinate set-zero when CYCST.		
55	Back to the Machine coordinate before CYCST		
56	Set the coordinate as zero or not when the program is executing at the end.		

N	SPECIAL MCM	VALUE	APPENDIX
57	In the auto mode ,it shows the program content		
58	After positioning of Absolutely / Incrementally feed-rate, execute the sub program		
59	Close the delay time of LCD showing or not		
60	Set the minimum of node the system pre-fate when close the LCD showing		
61	X-axis (+)(-) OT limit switch.		
62	Y-axis (+)(-) OT limit switch.		
63	O00 Servo on 0=Operational 1=Not Operational		
64	O04 Output of one cycle 0=Operational 1=Not Operational		
65	O05 Counter limit 0=Operational 1=Not Operational		
66	O00 Position Reached Signal 0=Operational 1=Not Operational		
67	O00 Program End 0=Operational 1=Not Operational		
68	I14 Emergent Stop 0= Not Operational 1= Operational		

4 Appearance and Connection

4.1 Connection Manual

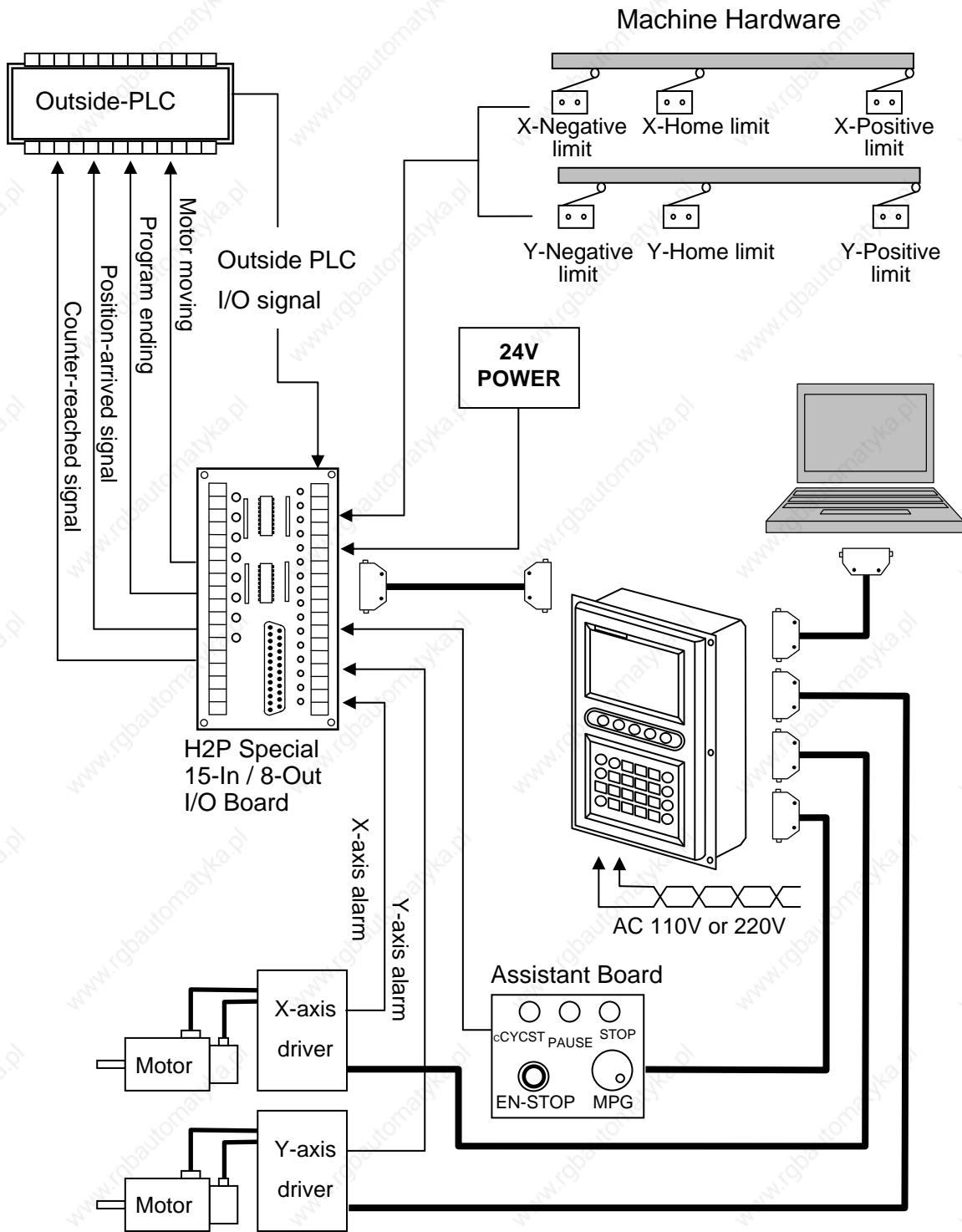

P4-1

4.2 INSTALLATION AND DIMENSION

4.2.1 Environmental Requirements

The design of the cabinet to house the CNC unit , the keyboard panel and the LCD display is the responsibility of the machine tool builder. The cabinet must be constructed and the unit installed in an environment satisfying the following conditions.

- Ambient Temperature
When operating: 0^o C to 45^o C.
When storing or transporting the system: -20^o C to 55^o C.
- Temperature Variation
Maximum: 1.1^o C/minute.
- Humidity
Normally: 80% RH or less (Relative Humidity).
For short period: maximum 95% RH.
- Vibration
When operating: <= 0.075 mm with frequency 5 HZ.
- Noise
When operating: withstand 2000V/100 sec pulse width every 10 m sec.
- Consult us when installing the system in an environment with high degree of dust, coolant, or organic solution.

4.2.2 Cabinet Considerations

Pay attention to the following items when designing a cabinet.

- The cabinet must be constructed to house the CNC unit , MDI panel and is always a completely enclosed box.

- Temperature rise within the cabinet should be 10° C or less than the ambient temperature.
- Sealing of the cable inlet/outlet or doors must be done thoroughly.
- When mounting the servo amplifier , please refer to the Servo Motor Manual.

4.2.3 Thermal Design in the Cabinet

The cabinet for the control unit must be a closed structure , and the temperature rise within the cabinet must be 10° C or less than the ambient temperature. When designing a metal cabinet for a CNC unit , two factors must be considered , which are the heat source and the radiation area. For a CNC unit , the user cannot do too much to change the heat source. Therefore , the one thing that the user can do in controlling the temperature rise is the radiation area. The allowable temperature rise inside a metal cabinet can be estimated as follows :

1. With a cooling fan , the allowable temperature rise is 1° C /6 W/1 m².
2. Without a cooling fan , the allowable temperature rise is 1° C /4 W/1 m².

This means that a cabinet with a radiation area of 1 m² and a cooling fan will have an internal temperature rise of 1° C when a heating unit of 6 W (4W without a cooling) is inside the cabinet. The radiation area of a cabinet is the entire surface area of the cabinet minus the area contacting the floor.

Example 1 (with a cooling fan) :

A cabinet has a 2 m² radiation area with a temperature rise of 10° C. The maximum allowable heat value inside the cabinet is 6 W x 2 x 10 = 120 W. Therefore , the heat generated inside the cabinet must

be kept less than 120 W. If the heat generated is 120 W or more in the cabinet , some other cooling devices , such as cooling fins , must be incorporated in the unit.

Example 2 (without a cooling fan) :

A cabinet has a 2 m² radiation area with a temperature rise of 10° C. The maximum allowable heat value inside the cabinet is 4 W x 2 x 10 = 80 W. Therefore, the heat generated inside the cabinet must be kept less than 80 W. If the heat generated is 80 W or more in the cabinet , some other cooling devices , such as fan , or cooling fins , must be incorporated in the unit.

4.3 Appearance and Size

* HUST H2PN appearance

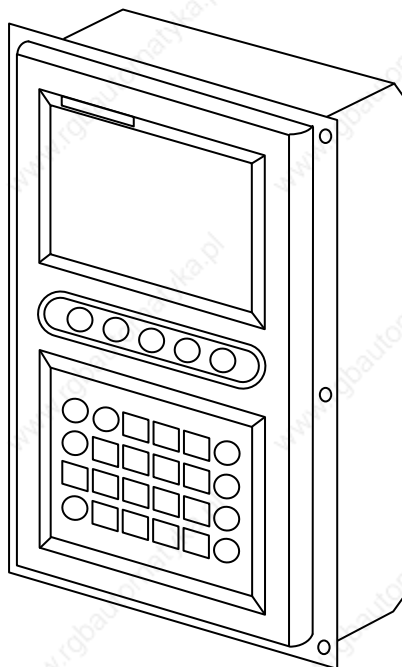

P4-2

* HUST H2PN size of box(Back)

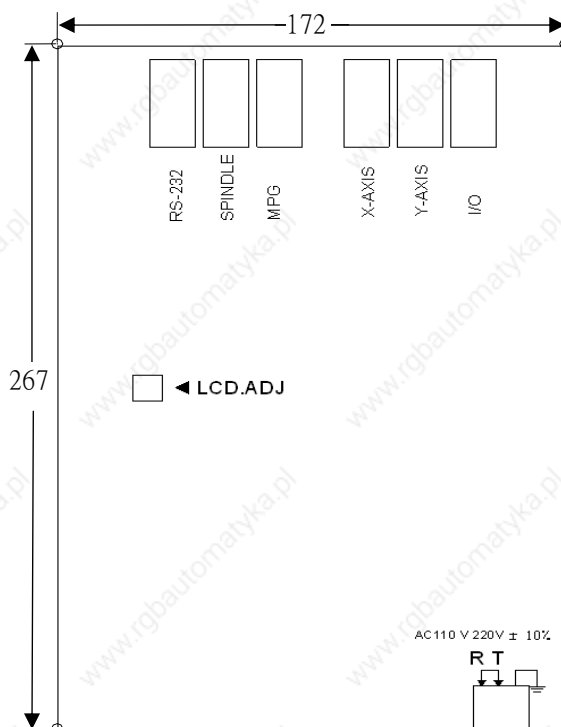

P4-3

*** HUST H2PN size of box(Right)**

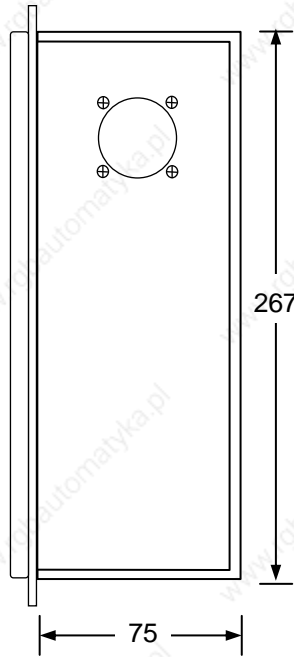

P4-4

*** HUST H2PN installation step illustration**

1. Make a square hole as 267*172mm on the mechanic construction.
And draw 3 screw holes each for both sides.

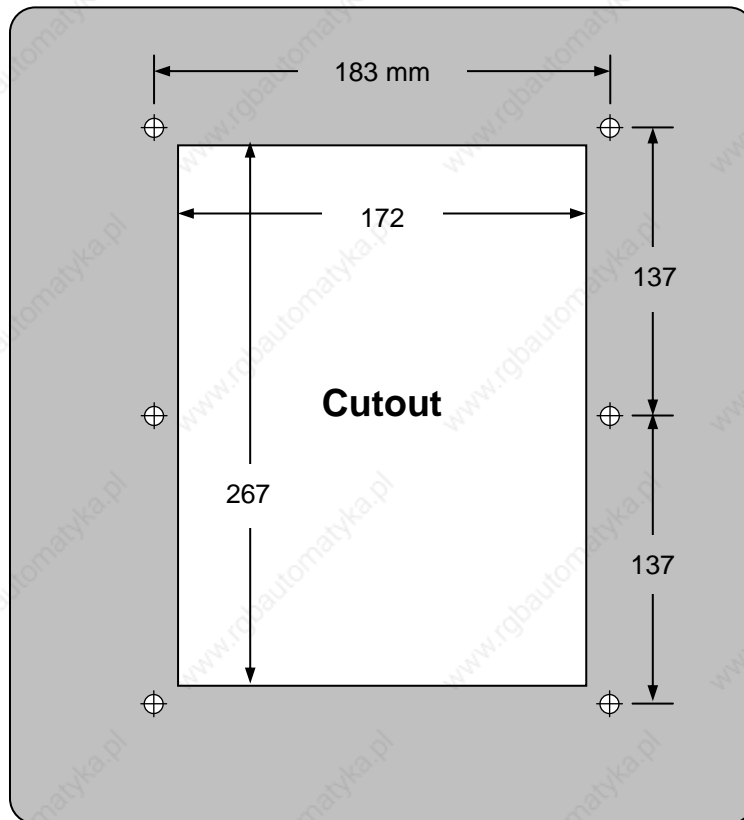

P4-5

2. Install HUST H2PN controller by the way picture showing.

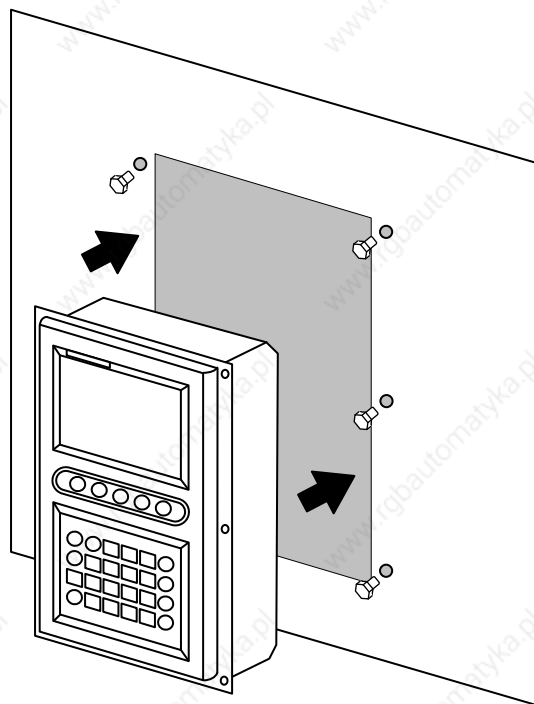

P4-6

3. Picture of completed installation

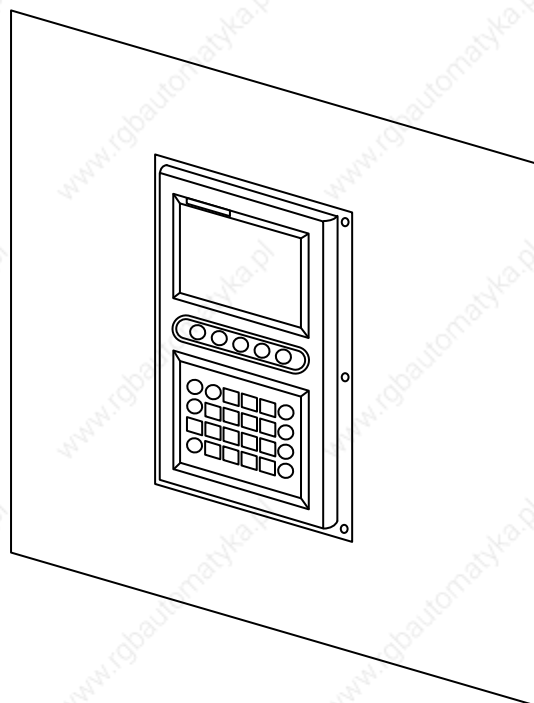

P4-7

4.4 Output / Input Board Connection

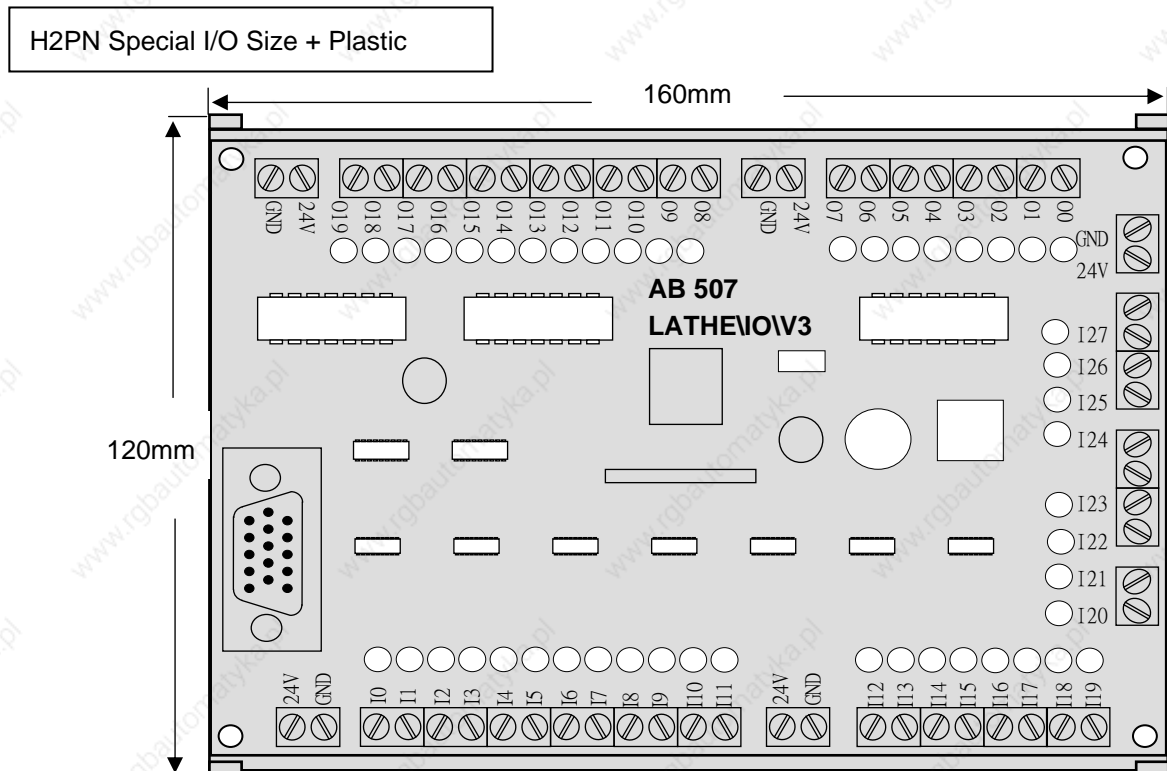
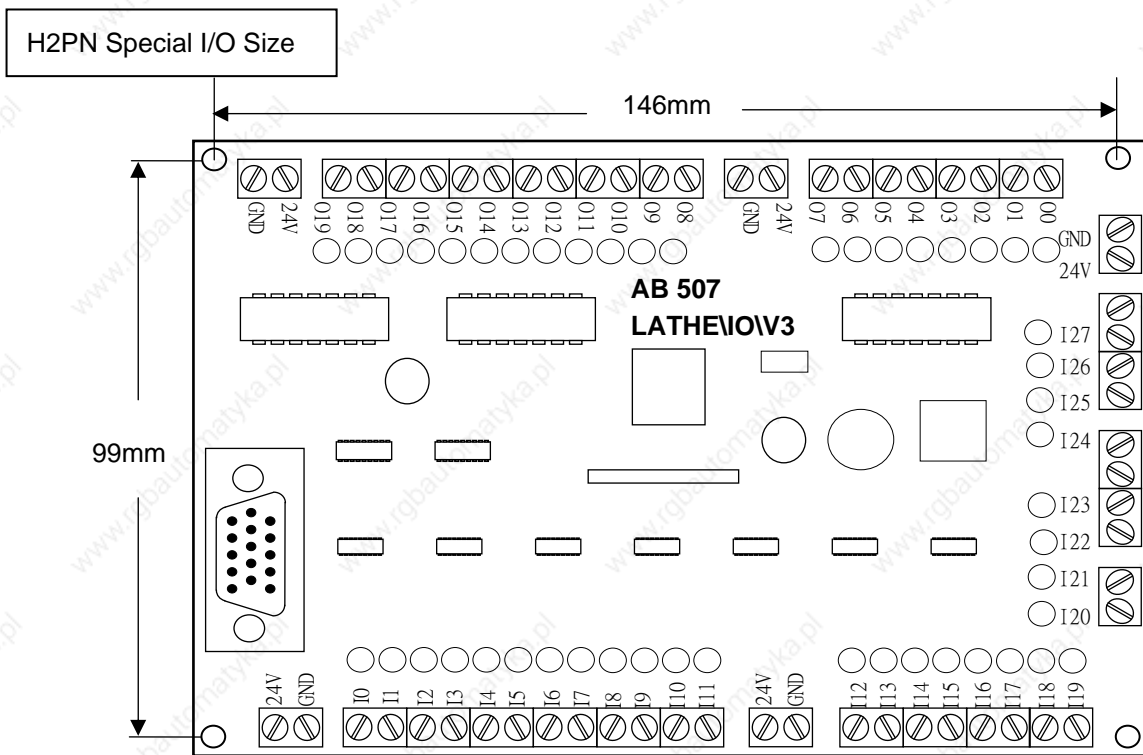

Standard I/O board has 28 inputting points and 20 outputting points. When the output or input signal is coming , the correspondent LED will light on.

※ +24V power is not provided

Please connect the 24V input connector to the **DC +24V IN**

When the 24V is inputting, each output unit on the board marked +24V will output +24V. It is 0V if it marks "GND".

So, please do not connect the +24V to that "GND" point.

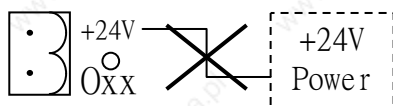

P4-9

4.4.1 Input Signals

The input signals are the signals transmit from outside machinery to controller. These signals can be come from push button, limit switch, relay connector, or proximity switch. There are total 15 inputting points.(I00 ~ I14)

* Input Signal Specification (NPN type)

Input Voltage : 0 V

Input ampere : 8 mA

* Input Signal Connection

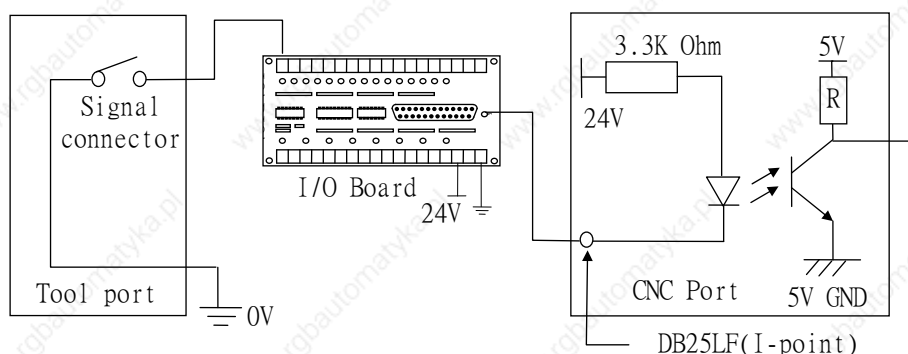

P4-10 Input Signal Connection

4.4.2 Output Signals

The output signal is that the signal outputs from inside the controller to outside tool machine. H2PN`s output circuit is transistor circuit to drive the relay of tool machine.

*** Output Signal Specification**

Each connector of I/O transistor circuit can stand the continuous voltage up to 30V and 100mA.

*** Output Signal Connection**

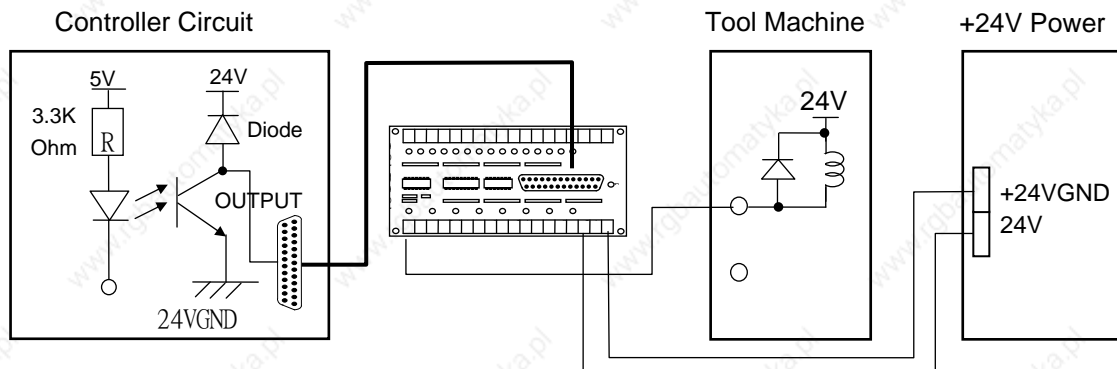

P4-11 Output Circuit

4.5 Connecting Diagrams

* Emergent Stop Connection Diagram-1

P4-12 is suggested connection diagram. By this way of connection, the software and hardware are series controlled. When the bottom of emergent stop is pressed, though the software is obsessive, the hardware also can turn the SERVO-ON off.

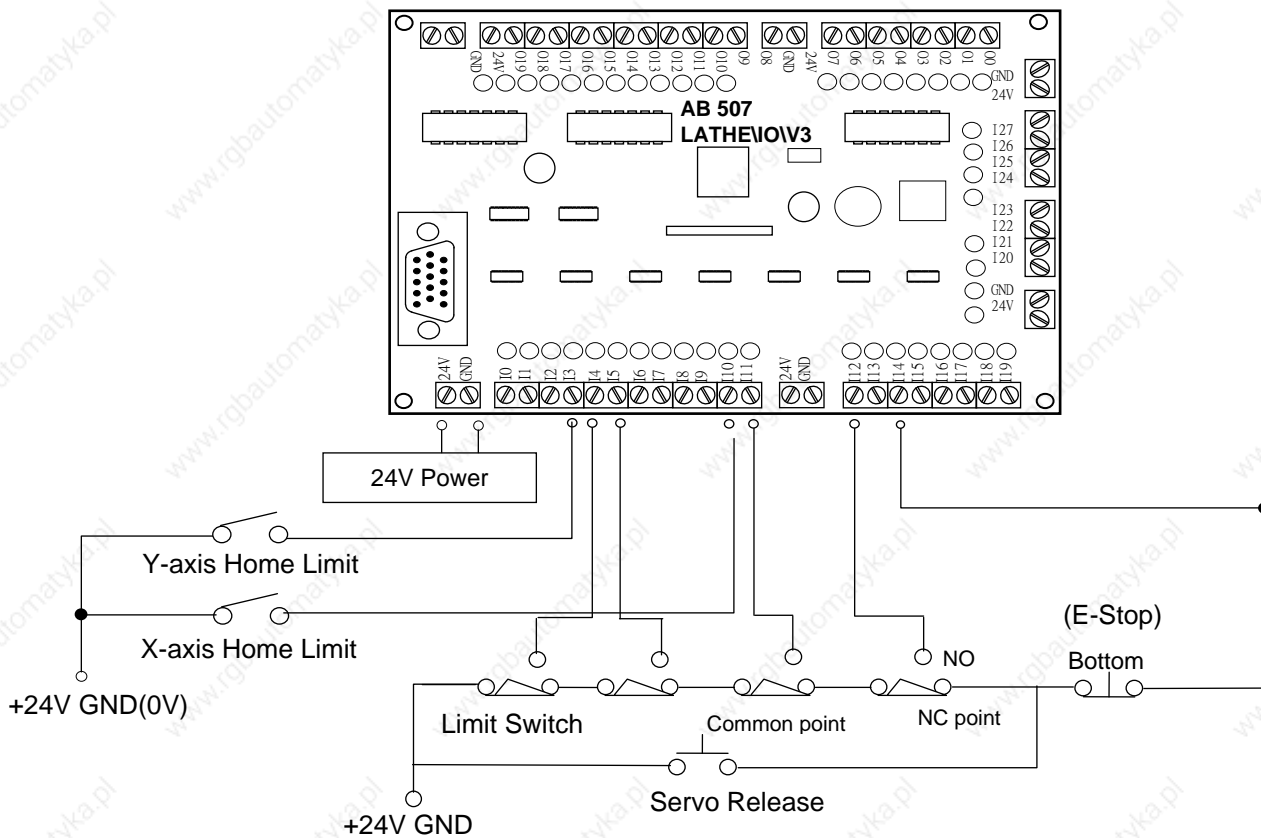
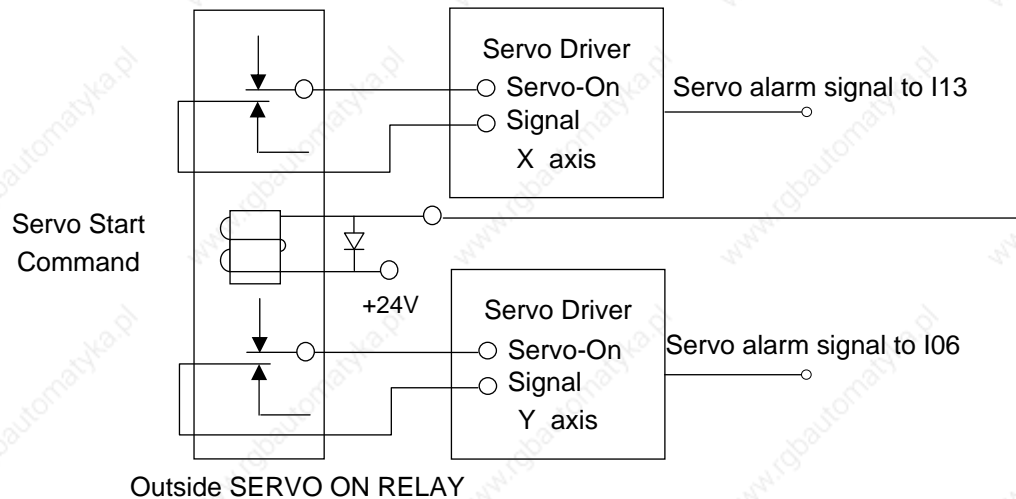

P4-12

* **Emergent Stop Connection Diagram-2**

P 4-13 is simple connection diagram.

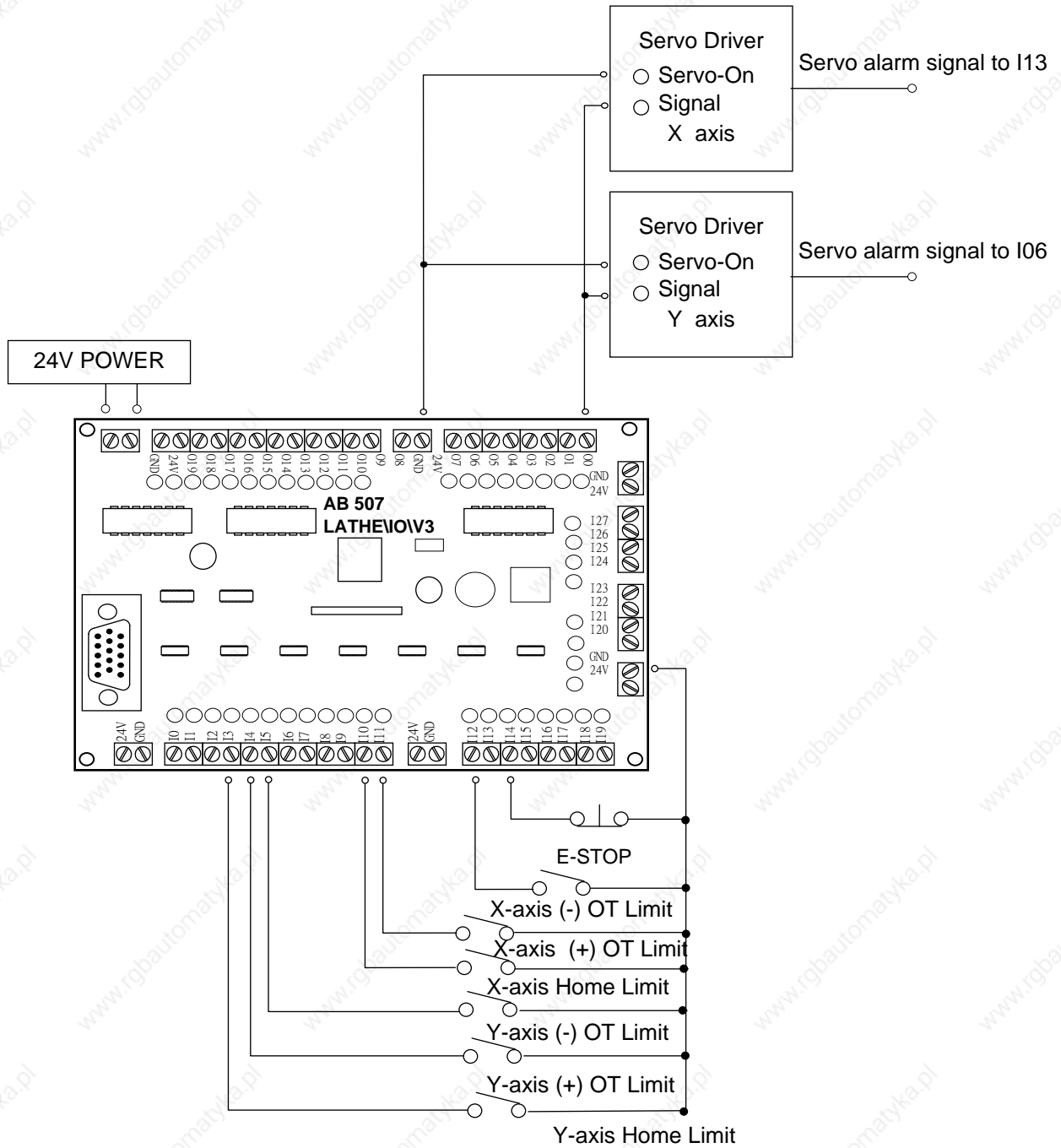

P4-13

4.5.1 Positioning Control Connection

The driver is connected to the connector of X-axis and Y-axis. The encoder is connected to the connector of spindle.

The pulse generator is connected to MPG as P 4-14. The connections of servo driver signal and of MPG are different with brand. You can get some reference in their manuals. (The function of spindle is reserved by system)

The connections of servo driver signal and of MPG are different with brand

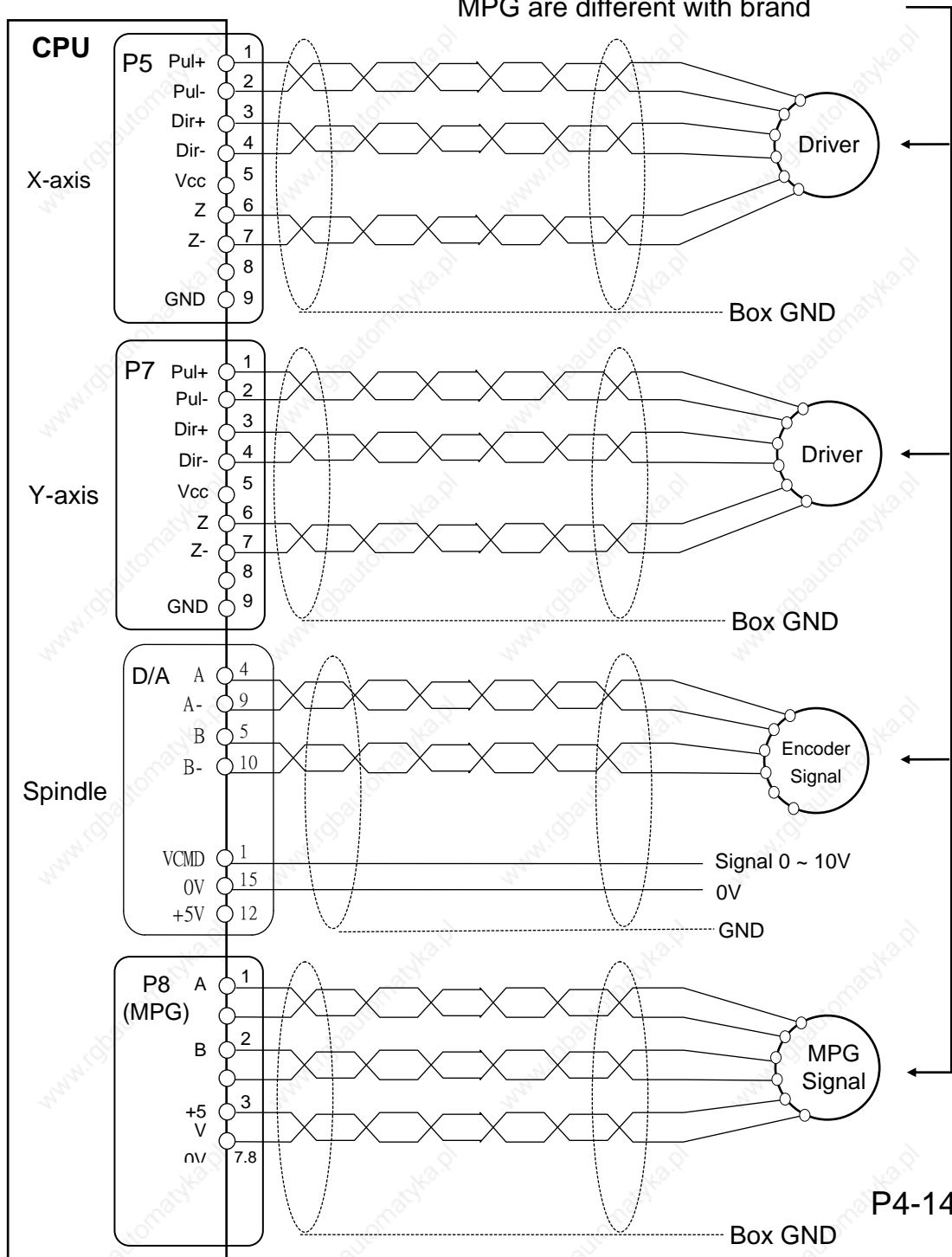

- The connection diagram of stepping motor HOME operation. (GRID board)

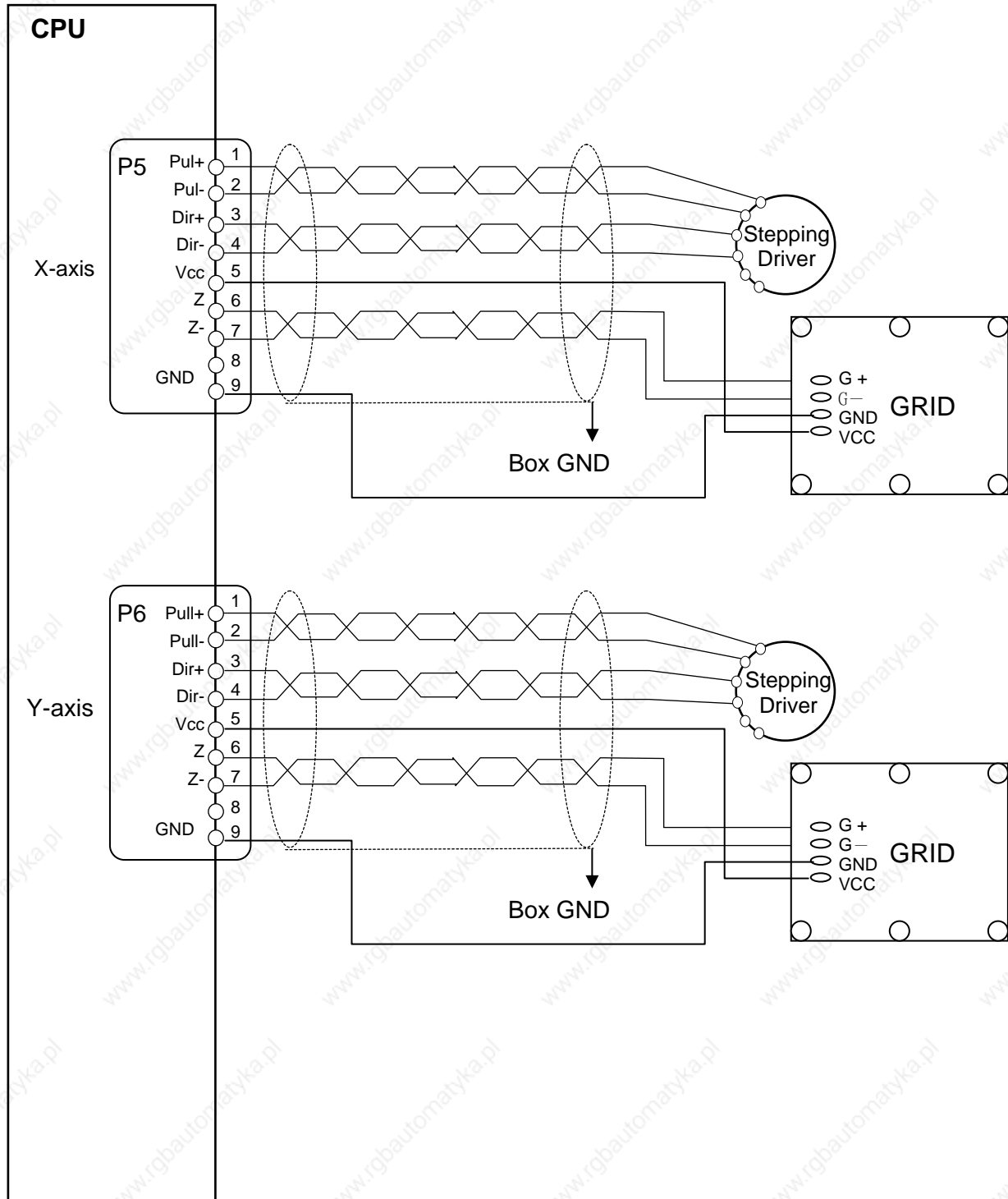

P4-15

The theory and steps of construction :

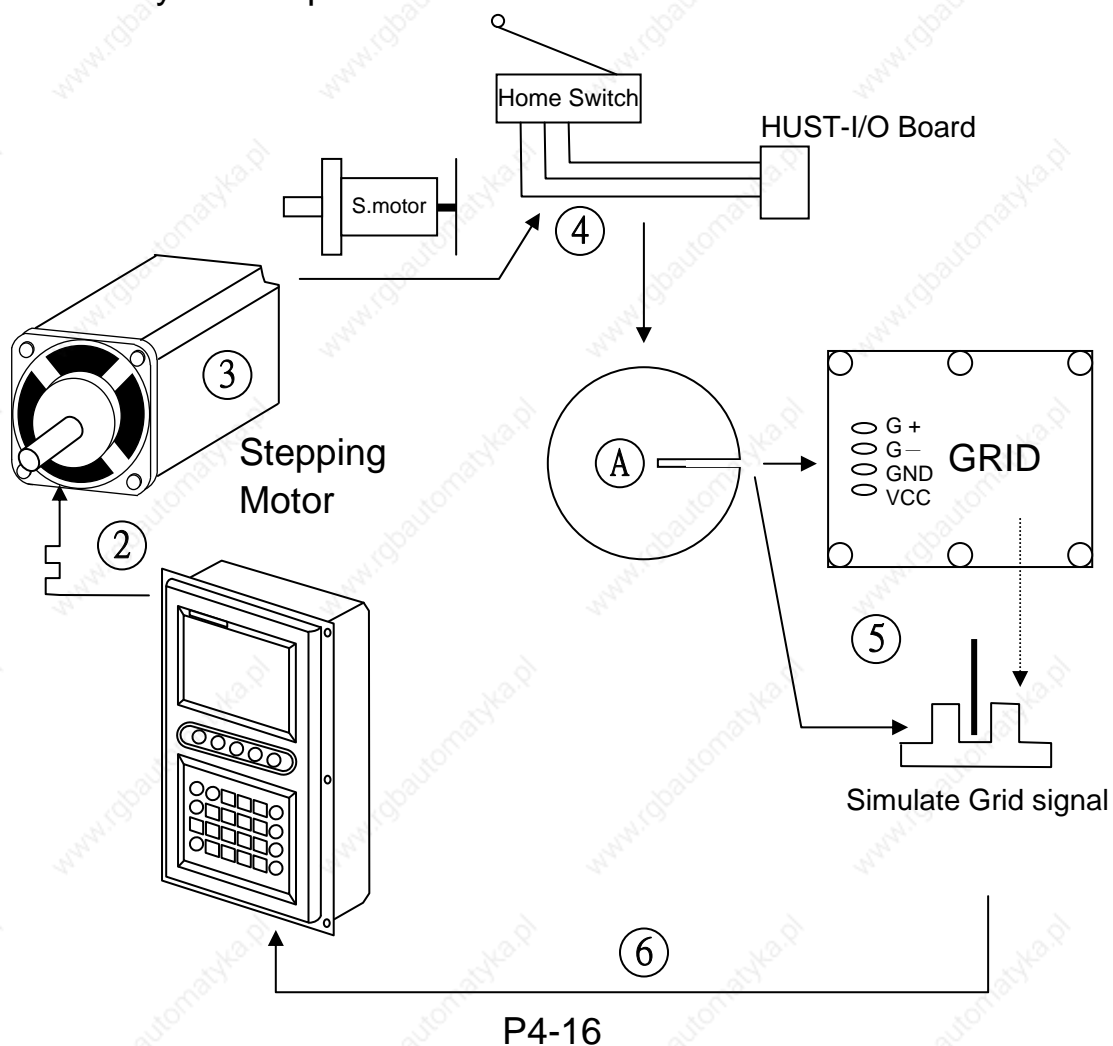

Operation Steps :

1. Executing the HOME operation.
2. The controller will send the pulse to driver stepping motor to the way to HOME limit.
3. The stepping motor is rotating at the speed of speed 1 setting (Further MCM #30、#31) while moving the A disk on the back.
4. The trigger set on the HOME switch of machine sends the signal through I/O board to controller.
The controller commands the motor rotating reversely at the speed of 【1/4 (Further MCM #30、#31 value)】 and leaving HOME switch.
5. When the signal of HOME switch is off, the controller will command the motor keeping rotating at the speed of speed 2 setting (Further MCM #32、#33) till the A disk's gap triggering on

the GRID board.

- At this time the GRID board will send out the HOME signal to the controller. And the controller will stop to pulse feed-rate. The stepping motor stops operation. The machine coordinate is set as zero. The HOME operation is completed.

※ Because the stepping motor Z(GRID) signal HUST controller accepted is the form of line driver , this signal Grid board is needed.

If used the servo motor , it has the Z(GRID) signal output itself , the signal is connected to the controller directly. This GRID board is not needed.

4.5.2 MPG Hand-wheel Connecting Diagram

If the tool movement is in the opposite direction to the MPG hand-wheel rotation , please exchange A and B signal connections.

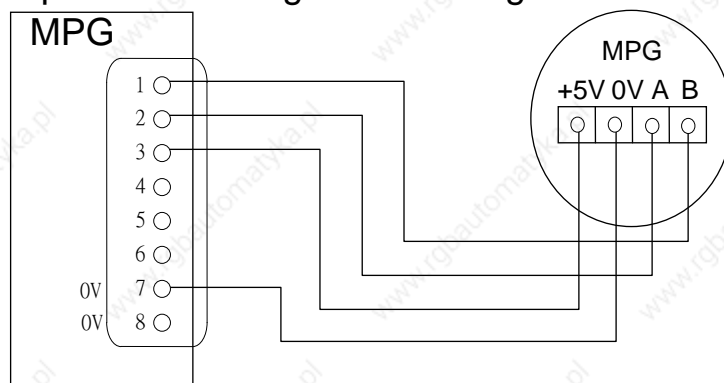

P 4-17 MPG Hand-wheel connection

*** D/A Explanation**

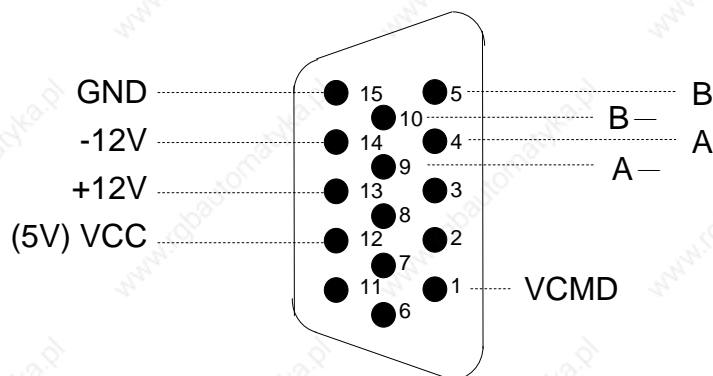

P 4-18 D/A Connector

5 Information and Description of Inspecting Error

If the controller has errors on the operation, the information of error will be shown up on the LCD screen as P 5-1. The information of error probably happened and the How to correct are explained below.

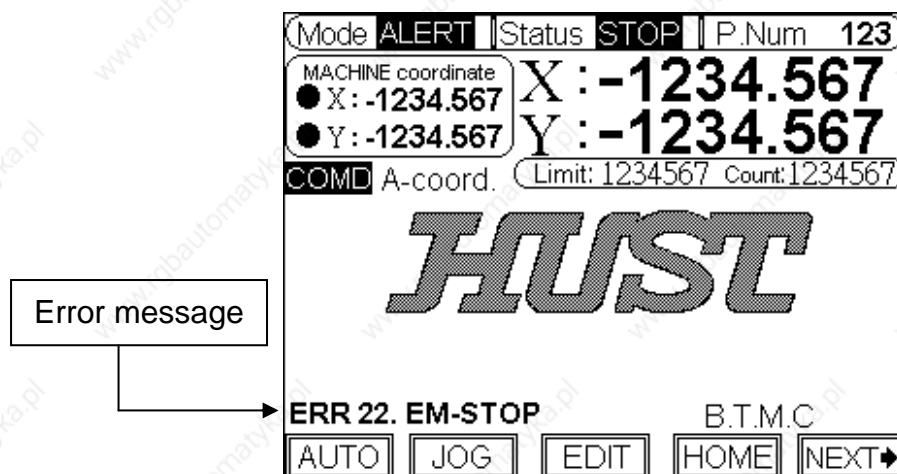

P5-1

* **ERROR-01 : MCM DATA ERROR OR BATTERY FAIL**

Info : The setting value of MCM is not correct or battery fail.

How to release :

1. Check the "MCM" setting value is correct or not.
2. The data of inner memory will lost if the controller hasn't Power On for more than one year. The controller will show the information that batteries(BT1) are low. Please turn the controller on and let it be charged.

* **ERROR-10 : RS232 ERROR**

Info : RS232 communication error.

How to release :

1. Check the baud rate in basic MCM #8 if compatible with the one in PC.

2. Check the communication cable connection from PC to CNC controller.

* **ERROR-12 : NO ROOM**

Info : When booting controller to load prepositive calculation program is error.

How to release :

Reboot the controller once and let it reload the prepositive calculation program.

* **ERROR-11 : PROGRAM MEMORY ERROR**

Info : The program data memory is error. It maybe low battery.

How to release :

Check memory battery. The controller will show the information of low battery. Please change a new set of battery.(The data of inner memory will lost if the controller havn't Power On for more than one year.)

How to delete all the program data :

1. Enter the Basic MCM page.
2. Press the blank function key on right side for 5 seconds to jump to Further MCM page.
3. When the function key of MCM page is not locked , there will be correspondent description of function. By pressing "Delete Program" key for 2 seconds , all the program data in controller will be deleted.
(When the function key is locked , please set the value =0 of Further MCM#53)
4. When the controller is rebooting , system will reload important programs.
5. The system has a protection that when controller is deleting all the program data , the operation of burning program can't be done.

* **ERROR-14 : X-AXIS OVER TRAVEL**

Info : X-axis over the range of (+)(-) OT limit.

How to release :

Using JOG mode to move the X-axis in the operation range.

* **ERROR-14 : Y-AXIS OVER TRAVEL**

Info : Y-axis over the range of (+)(-) OT limit.

How to release :

Using JOG mode to move the Y-axis in the operation range.

● **ERROR-18 : END OF FILE NOT FOUND**

Info : The condition of program ending is error.

How to release :

1. Check if the program content is blank status.
2. If execute the sub-program , please check if the program has ending code "M99"()

* **ERROR-20 : SOFTWARE OVER-TRAVEL**

Info : The work coordinate is over the range of software OT limit.

How to release :

Check the program or reset the Further MCM#36~#39 (range of software OT limit)

* **ERROR-22 : EM-STOP , HOME AGAIN**

Info : Now controller is in the status of Emergent Stop

How to release :

After solving the problems , turn on the bottom of EM-STOP and then press "RESET" key.

If the status of Emergent Stop can not be resolved , please check the way of connection.
(The condition would be resolved unless the input point I14 is ON.)

* **ERROR-30.1 : BATT. LOW**

Info : The battery (BT1) for data storage is out of charge or service.

How to release :

Turn the power on and keep it for 4 hours to let the memory batteries being charged. After the charging completed , reboot the controller. If this alarm is still , please change the batteries.

6 APPENDIX

6.1 Appendix A : Input/Output (I/O)List

Input/Output (I/O) List (Single Axis)				
Input	Description	PS	Output	Description
I00	◎(Interrupt Feed-rate) Command "7"	*	O00	* Motor SERVO ON)
I01	◎(Skip Selection) Command "6"	*	O01	
I02	◎(Division Feed-rate) Command "8"	*	O02	
I03			O03	
I04			O04	* One Cycle Output
I05			O05	* Counter Limit
I06			O06	* Positioning Finished
I07	◎Start(Outer Cycst Key)	*	O07	* Program End
I08	◎Stop(Outer Reset Key)	*	O08/O19	Reserved
I09	◎Program feed-hold(Outer Key)	*		
I10	# X-Home Limit Switch			
I11	# X-(+) OT Limit Switch	*		
I12	# X-(-) OT Limit Switch	*		
I13	# X-axis Error			
I14	Emergent-Stop (NC)	*		
I15/I27	Reserved			

PS :

◎ It presents that if open this function of inputting signal , this function can match with 『 Wait for the input signal 』 and design them at will.

* It presents that it can be set as used or unused by MCM.

It presents that it can be set as Normally Open or Close by MCM.

※ **The un-defined input/output points or the input points which functions have not used can be designed at will and they can match with the command code 『 Wait for the input signal(Command "4") 』、 『 Assigned Output(Command "5") 』 to use. But please do not make any conflict with the defined input/output points or which function had been started.**

Input/Output (I/O) List(Double Axes)				
Input	Description	PS	Output	Description
I00	◎(Interrupt Feed-rate) Command "7"	*	O00	* Motor (SERVO ON)
I01	◎(Skip Selection) Command "6"	*	O01	
I02	◎(Division Feed-rate) Command "8"	*	O02	
I03	# Y-Home Limit Switch		O03	
I04	# Y-(+) OT Limit Switch	*	O04	* One Cycle Output
I05	# Y-(-) OT Limit Switch	*	O05	* Counter Limit
I06	# Y-axis Error		O06	* Positioning Finished
I07	◎Start(Outer Cycst Key)	*	O07	* Program End
I08	◎Stop(Outer Reset Key)	*	O08/O19	Reserved
I09	◎Program feed-hold(Outer Key)	*		
I10	# X-Home Limit Switch			
I11	# X-(+) OT Limit Switch	*		
I12	# X-(-) OT Limit Switch	*		
I13	# X-axis Error			
I14	Emergent-Stop (NC)	*		
I15/I27	Reserved			

PS :

◎ It presents that if open this function of inputting signal , this function can match with 『 Wait for the input signal 』 and design them at will.

* It presents that it can be set as used or unused by MCM.

It presents that it can be set as Normally Open or Close by MCM.

※ **The un-defined input/output points or the input points which functions have not used can be designed at will and they can match with the command code 『 Wait for the input signal(Command "4") 』、 『 Assigned Output(Command "5") 』 to use. But please do not make any conflict with the defined input/output points or which function had been started.**

6.2 Appendix B : Command Code List

HUST H2PN Series Command Code List		
Code	Name	Command Description
1	Absolute coordinate	The motor is executing at the setting speed to process at the absolute position set. When it has reached the position, the positioning signal is outputted (Time is set by basic MCM#6)
2	Incremental coordinate	The motor is executing at the setting speed to process at the incremental position set. Each time when it has reached the position, the positioning signal is outputted (Time is set by basic MCM#6)
3	Feed-Hold	The program executing by feed hold. the setting time is in the "X-coordinate" column.
4	Wait for the input signal	Wait for the input signal is on or off is according to the setting value of 【Data】 column. EX: The value of 【Data】 column "1" indicates that when the value of standby input 1 is ON, Then the program will continue to execute by the serial number. The value of 【Data】 column "-1" indicates that when the value of standby input 1 is OFF, Then the program will continue to execute by the serial number.
5	Assign Output	That the assigned output point is on or off is according to the setting value of 【Data】 column. EX: Setting value = 3, Assigned Input 3 ON. Setting value = -3, Assigned Input 3 OFF. Data: The serial number of assigned output motion ranges from 0 to 7.
6	Skip Selection	When executing at the serial number : If the skip selection input 1 is ON, it will skip to assigned serial number 【Set by (Data) column】 If the skip selection input 1 is OFF, it will continue to execute the next node.

7	Interrupt Feed-rate	<p>According to the 【Speed】 setting of X · Y axis , the program will executing the incremental feed-rate.</p> <p><u>When the signal “Input 0” is on in the positioning, the axis will stop immediately and directly execute next node.</u></p> <p>If the interrupt input 0 is not ON, during the feeding tour. It will continue to execute the next node after the setting incremental feed-rate reached.</p>
8	Division Feed-rate	<p>According to the settings of 【Data】 column and the speed of X and Y axis, the system will divide the feed-rate.</p> <p>After each positioning of divided feed-rate, there are two ways to restart:</p> <p>A. Set the pausing time of divided feed-rate (Set in the basic MCM#11). When reaching the setting time, it will go to next position automatically.</p> <p>B. If the basic MCM#11 setting value of divided feed-rate pausing time is “0”, the restart signal is the “falling edge” that when “Input 2” turn on to off.</p>
9	Repetitious cycle	<p>When the program is executing at this command, the program will go back to the first node of program and keep executing this cycle.</p> <p>It will be recognized as the function of repetitious cycle if the last node of program command code is “blank”.</p> <p>※If the counter dose not reach the limit or 「One cycle」 is not ON,</p> <p>It will jump back on the node1 to executing recycle. The counter value is added by 1.</p> <p>If the 「One cycle」 is ON, the program motion will stop automatically that the program has executed last node.</p> <p>※ If the last node command code is not set as “0”, it will be replaced by “9”.</p>
0	End Of Program	<p>When the program just only execute one times, write this command code on the place of program ending point.</p>

6.3 Appendix C : Program Description for Example

Program description for example -1 :

Command Description	Node Code	Command	XY-Coor.	Speed	Value	Description
Absolute Coordinate	01	1	50.000	10	*	Move from current position to the absolute position "50.000" with speed "10"
Incremental Coordinate	02	2	20.000	5	3	Move from current position to the positive direction "20.000" for three times with speed "5"
Feed Hold	04	3	1.000	*	*	Pause for 1 second
Wait for the input signal	05	4	*	*	1	Wait the Input 1 = ON
Assign Output	06	5	*	*	3	Assign Output 3 = ON
Feed Hold	07	3	0.500	*	*	Pause for 0.5 second
Assign Output	08	5	*	*	-3	Assign Output 3 = OFF
Wait for the input signal	09	4	*	*	-1	Wait the Input 1 = OFF
Repetitious cycle	10	9	*	*	*	※ If the counter dose not reach the limit or 「One cycle」 is not ON, It will jump back on the node1 to executing recycle. The counter value is added by 1. If the 「One cycle」 is ON, the program motion will stop automatically that the program has executed last node.

Program description for example -2 :

Command Description	Code	Command	XY-Coor.	Speed	Value	Description
Absolute Coordinate	01	1	50.000	10	*	Move from current position to the absolute position "50.000" with speed "10"
Interrupt Feed-rate	02	7	200.000	5	*	Move to the incremental position "200.000" with speed "5". In the duration, if the I00=1, it will skip to execute the next code immediately.
Division Feed-rate	03	8	100.000	2	4	Move to the incremental position "(100.000/4)=25.000". And move for 4 times total "100.000" moving distance.
Skip Selection	04	6	*	*	2	If I01=ON, it will skip to execute the node 2. (Interrupt Feed-rate)
Absolute Coordinate	05	1	0.000	10	*	Move from current position to the absolute position "0.000" with speed "10"

6.4 Appendix D : HUST H2PN & MR- J2S connection

HUST H2PN <<< >>>MR- J2S

POSITION MODE

HUST CPU

DRIVER CN1A
(POSITION MODE)

