

**Interference Suppression
film capacitors**

**PCX2 337
(305V)**

MKP RADIAL POTTED CAPACITORS

Pitch 10.0/15.0/22.5/27.5mm

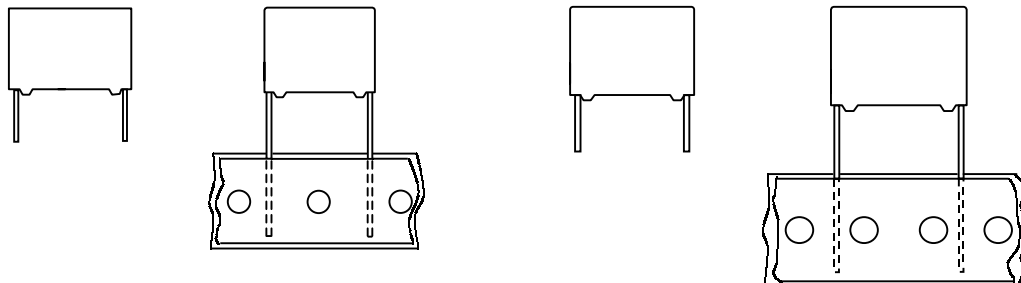

10 and 15mm

22.5 and 27.5mm

QUICK REFERENCE DATA

Capacitance range (E6 series) *	0.01 μ F to 3.3 μ F
Capacitance tolerance	\pm 10 %, \pm 20 %
Rated (AC) voltage 50 to 60 Hz	305 V ⁻
Climatic category	40/105/21
Rated temperature	105 ^o C
Maximum application temperature	105 ^o C
Reference IEC specification	IEC 60384-14(2nd edition) and EN132400
Safety approvals	UL 1414 & CAS-C 22.2 NO.1 UL 1283 & CAS-C 22.2 NO.8 ENEC
Materials	Qualified in accordance with UL 94V-0
Safety class	X2

* Intermediate values of the E12 series are available to special order

<p>FEATURES</p> <ul style="list-style-type: none"> . 10 to 27.5 mm lead pitch . Supplied loose in box and taped on reel . Consist of a low-inductive wound cell of Metallized Polypropylene film, potted in a flame retardant case 	<p>APPLICATIONS</p> <ul style="list-style-type: none"> . For X2-electromagnetic interference suppression <p>Specially designed to meet the NEW REQUIREMENTS in new IEC 60384-14 specification(2nd edition)/EN 1324 requiring for X2 a 2.5kV peak pulse voltage test and the UL1414 and CSA-C22.2 No 1 specification</p>
----------------------------------------------------------------------------------------------------------------------------------------------------------------------------------------------------------------------------------------------------------------------------	------------------------------------------------------------------------------------------------------------------------------------------------------------------------------------------------------------------------------------------------------------------------------------------------------------------------------------------------------

• Please refer to caution and warning at <http://www.pilkor.co.kr/download/Introductions.pdf> before using these products.

Ordering Information

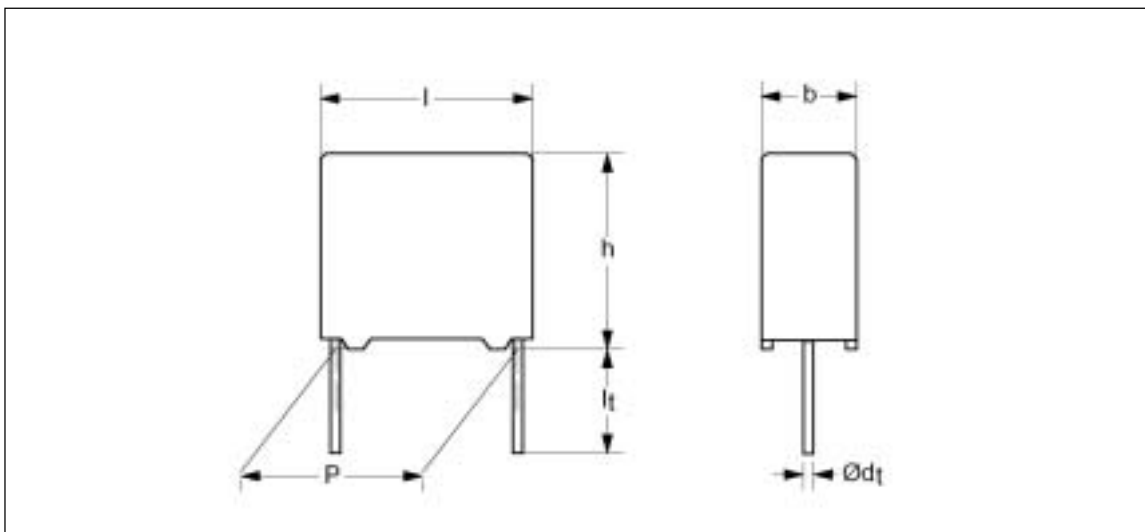

PCX2 337 X X X X X X

Type series

Capacitance

Code	Voltage
3	305V

Code	Original pitch
D	10.0mm
F	15.0mm
J	22.5mm
L	27.5mm

code	Packing method	Lead configuration	C - tol	12NC
0	Loose in box	lt = 5.0 ± 1.0mm	C-tol ± 20 %	PCX2 337xx0xxx
1	Loose in box	lt = 5.0 ± 1.0mm	C-tol ± 10 %	PCX2 337xx1xxx
4	Loose in box	lt = 25 ± 2.0mm	C-tol ± 20 %	PCX2 337xx4xxx
5	Loose in box	lt = 25 ± 2.0mm	C-tol ± 10 %	PCX2 337xx5xxx
2	Taped on reel	H = 18.5 mm* / P ₀ =12.7mm	C-tol ± 20%	PCX2 337xx2xxx
3	Taped on reel	H = 18.5 mm* / P ₀ =12.7mm	C-tol ± 10%	PCX2 337xx3xxx
6	Ammopack	H = 18.5 mm* / P ₀ =12.7mm	C-tol ± 20%	PCX2 337xx6xxx
7	Ammopack	H = 18.5 mm* / P ₀ =12.7mm	C-tol ± 10%	PCX2 337xx7xxx
C	Loose in box	lt = 3.2 ± 0.3mm	C-tol ± 20%	PCX2 337xxCxxx
D	Loose in box	lt = 3.2 ± 0.3mm	C-tol ± 10%	PCX2 337xxDxxx

* H ; intape height ; for detailed specifications refer to chapter PACKAGING

Interference Suppression film capacitors

**PCX2 337
(305V)**

SAFETY APPROVALS

SAFETY APPROVALS	Voltage	Value	File Number
UL1414 & CSA C22.2 NO 1	250V(AC)	10nF to 1.0 μ F	E165646
ENEC(SEMKO) *	305V(AC)	10nF to 3.3 μ F	SE/0256-1
UL1283 & CSA C22.2 No.8	275V(AC)	C > 1 μ F	E208404

* The ENEC-approval together with the CB-Certificate replace all national approval marks of the following countries(they have already signed the ENEC-Agreement): Austria; Belgium; Czech. Republic; Denmark; Finland; France; Germany; Greece; Hungary; Ireland; Italy; Luxembourg; Netherlands; Norway; Portugal; Slovenian; Spain; Sweden; Switzerland and United Kingdom

Packaging Information

SMALLEST PACKING QUANTITIES (SPQ)	LOOSE IN BOX	
	lt = 5 \pm 1.0 mm lt = 3.2 \pm 0.3 mm	lt = 25 \pm 2.0 mm
DIMENSIONS		
4.0 x 10.0 x 12.5	2000	1200
5.0 x 11.0 x 12.5	1500	1000
6.0 x 12.0 x 12.5	1000	1000
5.0 x 11.0 x 18.0	1000	1000
6.0 x 12.0 x 18.0	1000	1000
7.0 x 13.5 x 18.0	1000	1000
8.5 x 15.0 x 18.0	1000	1000
10.0 x 16.5 x 18.0	1000	1000
11.0 x 18.5 x 18.0	1000	1000
6.0 x 15.5 x 26.0	1000	1000
7.0 x 16.5 x 26.0	1000	1000
8.5 x 18.0 x 26.0	500	500
10.0 x 19.5 x 26.0	500	500
13.0 x 23.0 x 26.0	500	500
11.0 x 21.0 x 31.0	500	250
13.0 x 23.0 x 31.0	250	250
15.0 x 25.0 x 31.0	250	250
18.0 x 28.0 x 31.0	200	200
21.0 x 31.0 x 31.0	150	150

Interference Suppression film capacitors

PCX2 337 (305V)

SPECIFIC REFERENCE DATA FOR 305 V_{AC}

Tangent of loss angle	at 1 khz	at 10 khz
C 470 nF 470 nF < C 1 μF C > 1 μF	10×10^{-4} 20×10^{-4} 30×10^{-4}	20×10^{-4} 70×10^{-4} -
Rated voltage pulse slope (dV/dt) _R	100 V/μs	
R between leads, for C 0.33 μF	15 000 MΩ	
RC between leads, for C > 0.33 μF	5 000 s	
Test voltage (DC) on line; C 1 μF C > 1 μF	2250 V ; 1 min 1850 V ; 1 min	

V_{Rac} = 305 V X2
loose and taped

Cap. (μF)	b x h x l (mm)	MASS (g)	CATALOGUE NUMBER			
			PCX2 337			
			loose in box			
			lt = 5 ± 1.0 mm		lt = 25 ± 2.0 mm	
			C - tol. ±20 %	C - tol. ±10 %	C - tol. ±20 %	C - tol. ±10 %
Pitch = 10.0 ± 0.4 mm			dt = 0.6 +0.06/-0.05 mm			
0.01	4.0 x 10.0 x 12.5	0.8	D30103	D31103	D34103	D35103
0.015	4.0 x 10.0 x 12.5	0.8	D30153	D31153	D34153	D35153
0.022	4.0 x 10.0 x 12.5	0.8	D30223	D31223	D34223	D35223
0.033	5.0 x 11.0 x 12.5	0.9	D30333	D31333	D34333	D35333
0.047	5.0 x 11.0 x 12.5	0.9	D30473	D31473	D34473	D35473
0.068	6.0 x 12.0 x 12.5	1.0	D30683	D31683	D34683	D35683
0.1	6.0 x 12.0 x 12.5	1.0	D30104	D31104	D34104	D35104

**Interference Suppression
film capacitors**
**PCX2 337
(305V)**
 $V_{Rac} = 305 V \cdot X2$

loose and taped

Cap. (μF)	b x h x l (mm)	MASS (g)	CATALOGUE NUMBER			
			PCX2 337			
			loose in box			
			lt = 5 \pm 1.0 mm		lt = 25 \pm 2.0 mm	
			C - tol. ± 20 %	C - tol. ± 10 %	C - tol. ± 20 %	C - tol. ± 10 %
Pitch = 15.0 \pm 0.4 mm			dt = 0.6 +0.06/-0.05 mm			
0.01	5.0 x 11.0 x 18.0	1.6	F30103	F31103	F34103	F35103
0.015	5.0 x 11.0 x 18.0	1.6	F30153	F31153	F34153	F35153
0.022	5.0 x 11.0 x 18.0	1.6	F30223	F31223	F34223	F35223
0.033	5.0 x 11.0 x 18.0	1.6	F30333	F31333	F34333	F35333
0.047	5.0 x 11.0 x 18.0	1.6	F30473	F31473	F34473	F35473
0.068	5.0 x 11.0 x 18.0	1.6	F30683	F31683	F34683	F35683
0.1*	5.0 x 11.0 x 18.0	1.6	FV0104	FV1104	FV4104	FV5104
Pitch = 15.0 \pm 0.4 mm			dt = 0.8 +0.08/-0.05 mm			
0.1	6.0 x 12.0 x 18.0	1.8	F30104	F31104	F34104	F35104
0.15	7.0 x 13.5 x 18.0	1.9	F30154	F31154	F34154	F35154
0.22	8.5 x 15.0 x 18.0	2.6	F30224	F31224	F34224	F35224
0.33	10.0 x 16.5 x 18.0	3.1	F30334	F31334	F34334	F35334
0.47	11.0 x 18.5 x 18.0	4.1	F30474	F31474	F34474	F35474
Pitch = 22.5 \pm 0.4 mm			dt = 0.8 +0.08/-0.05 mm			
0.22	6.0 x 15.5 x 26.0	3.0	J30224	J31224	J34224	J35224
0.33	7.0 x 16.5 x 26.0	3.5	J30334	J31334	J34334	J35334
0.47	8.5 x 18.0 x 26.0	4.4	J30474	J31474	J34474	J35474
0.68	10.0 x 19.5 x 26.0	5.5	J30684	J31684	J34684	J35684
1.0	13.0 x 23.0 x 26.0	8.0	J30105	J31105	J34105	J35105
Pitch = 27.5 \pm 0.4 mm			dt = 0.8 +0.08/-0.05 mm			
0.68	11.0 x 21.0 x 31.0	11.0	L30684	L31684	L34684	L35684
1.0	13.0 x 23.0 x 31.0	11.5	L30105	L31105	L34105	L35105
1.5	15.0 x 25.0 x 31.0	12.8	L30155	L31155	L34155	L35155
2.2	18.0 x 28.0 x 31.0	17.2	L30225	L31225	L34225	L35225
3.3	21.0 x 31.0 x 31.0	20.4	L30335	L31335	L34335	L35335

* Mini Type : xVxxxx

CONSTRUCTION

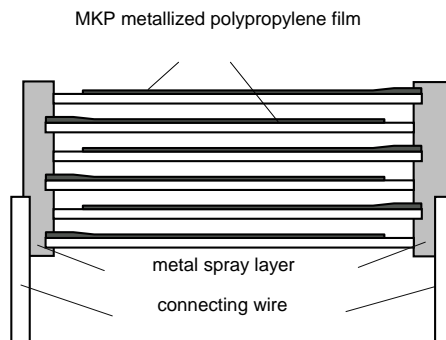

MOUNTING

NORMAL USE

The capacitors are designed for mounting on printed-circuit boards.
 The capacitors packed in bandoliers are designed for mounting on printed-circuit boards by means of automatic insertion machines.
 For detailed specifications refer to chapter "PACKAGING".

SPECIFIC METHOD OF MOUNTING TO WITHSTAND VIBRATION AND SHOCK

In order to withstand vibration and shock tests, it must be ensured that the stand-off pips are in good contact with the printed-circuit board.
 . For pitches of 15mm the capacitors shall be mechanically fixed by leads.
 . For larger pitches the capacitors shall be mounted in the same way and the body clamped.

SPACE REQUIREMENTS ON PRINTED-CIRCUIT BOARD

The maximum length and width of film capacitors are shown in the following drawing ;

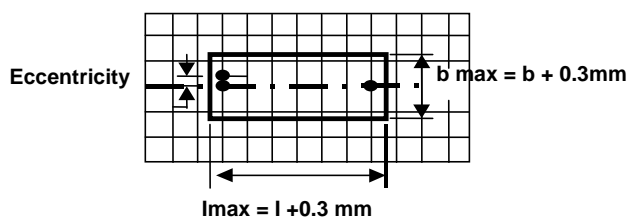

- Eccentricity as in drawing.
 The maximum eccentricity is smaller than or equal to the lead diameter of the product concerned.
- Product height with seating plane as given by IEC 60717 as reference : $h_{max} \quad h+0.3\text{mm}$

RATINGS AND CHARACTERISTICS

Unless otherwise specified all electrical values apply to an ambient temperature of 23 ± 1 °C, an atmospheric pressure of 86 to 106kPa and a relative humidity $50 \pm 2\%$.

For reference testing, a conditioning period shall be applied of 96 ± 4 hours by heating the products in a circulating air oven at the rated temperature and a relative humidity not exceeding 20%.

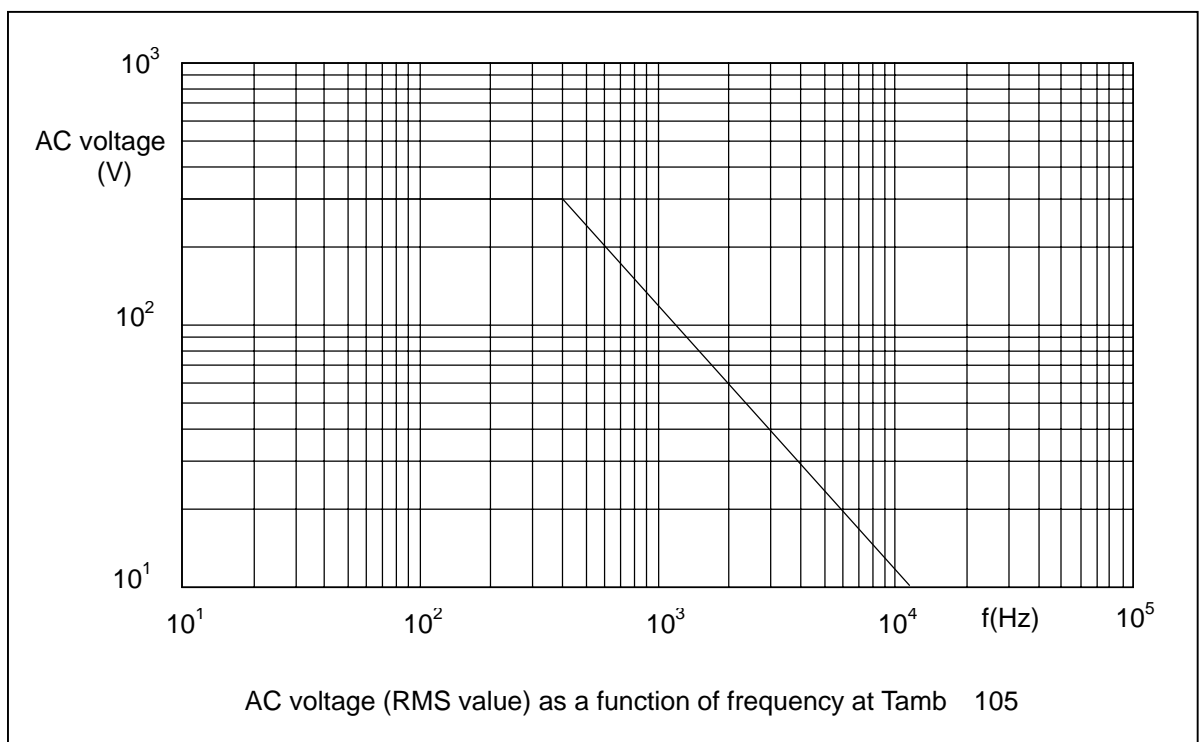
Maximum RMS Voltage as a function of frequency

PRODUCT MARKING

Capacitors are marked with having following information;

- 1.Manufacturer (PILKOR)
- 2.Manufacturer's type designation (337 or PCX2 337)
- 3.Rated capacitance in code according to IEC 60062
- 4.Rated (AC) voltage (305V~)
- 5.Sub class (X2)
- 6.Tolerance on rated capacitance M = ± 20 % K = ± 10 %
- 7.Climatic category (40/105/21)
- 8.Code for dielectric material (MKP)
- 9.Year and week of manufacturing (0638)
- 10.Safety approvals

Example of marking

Pitch P = 10mm



Marking on the side

Pitch P = 15.0mm or P = 22.5mm

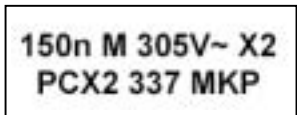

Marking on the top



Marking on the side

Pitch P = 22.5 mm.

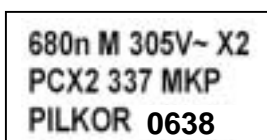

Marking on the top



Marking on the side

or



Marking on headface

Pitch P = 27.5 mm.



Marking on headface(C = 1uF)

or

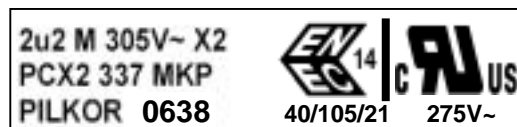

Marking on headface(C > 1uF)